

# Combinatorial point for higher spin loop models

P. Zinn-Justin \*

Integrable loop models associated with higher representations (spin  $\ell/2$ ) of  $U_q(\mathfrak{sl}(2))$  are investigated at the point  $q = -e^{\pm i\pi/(\ell+2)}$ . The ground state eigenvalue and eigenvectors are described. Introducing inhomogeneities into the models allows to derive a sum rule for the ground state entries.

03/2006

---

\* Laboratoire de Physique Théorique et Modèles Statistiques, UMR 8626 du CNRS, Université Paris-Sud, Bâtiment 100, F-91405 Orsay Cedex, France

## 1. Introduction

The present work is part of an ongoing project to understand the combinatorial properties of integrable models at special points where a (generalized) stochasticity property is satisfied. The project was started in [1], based on the observations and conjectures found in [2,3]. The original model under consideration was the XXZ spin chain with (twisted) periodic boundary conditions at the special point  $\Delta = -1/2$ , or equivalently a statistical model of non-crossing loops with weight 1 per loop (somewhat improperly called “O(1)” model, since it is really based on  $U_q(\widehat{\mathfrak{sl}(2)})$  with  $q = -e^{\pm i\pi/3}$ ), which can be reformulated as a Markov process on configurations of arches. Among the various conjectured properties of the *ground state eigenvector*, a “sum rule” formulated in [2], namely that the sum of components of the properly normalized ground state eigenvector is equal to the number of alternating sign matrices, was proved in [1].

Since then, a number of generalizations have been considered: (i) models based on a different algebra, either the ortho/symplectic series which corresponds to models of crossing loops [4,5], or higher rank  $A_n$  [6], which can be described as paths in Weyl chambers. Note that in the latter case the stochasticity property must be slightly modified: it becomes the existence of a (known) fixed left eigenvector of the transfer matrix. This idea will reappear in the present work. (ii) models with other boundary conditions [7,8], which will not be discussed here.

There is yet another direction of generalization: the use of higher representations. Indeed all models considered so far were based on fundamental representations (spin 1/2 for  $A_1$ ). We thus study here integrable models based on  $A_1$ , but representations of spin  $\ell/2$ . There is a reasonable way to formulate these in terms of loops, using the fusion procedure (see Sect. 2). One interesting feature is that the resulting models are closer in their formulation to the original  $O(1)$  loop model, and we can hope a richer combinatorial structure in the spirit of the full “Razumov–Stroganov conjecture” [3].

The present work remains indeed very close to that of [1]. It is concerned with the study of the ground state eigenvector and of the properties of its entries in an appropriate basis. In fact, many arguments are direct generalizations of those of [1] – though proofs are sometimes clarified and simplified. There are however some new ideas. In particular, as already mentioned a key technical feature is the existence of a common left eigenvector for the whole family of operators from which one builds the transfer matrix or the Hamiltonian. Here we give an “explanation” of this phenomenon: it is related to the degeneration

of a natural “scalar product” on the space of states. Indeed asking for this scalar product to have rank 1 fixes the special value of the parameter  $q$  to be  $q = -e^{\pm i\pi/(\ell+2)}$ , which generalizes the value  $\Delta = \frac{q+1/q}{2} = -1/2$  for spin 1/2. This will be explained in Sect. 3.1 and 3.2. Sect. 3.3 deals with the ground state eigenvector for the inhomogeneous integrable transfer matrix, the polynomial character of its components in terms of the spectral parameters and other properties, while Sect. 3.4 describes the computation of the sum rule, both following the general setup of [1]. In the latter, we shall be forced to rely on a conjecture concerning the degree of the polynomial eigenvector: although in the special case  $\ell = 1$  this conjecture was proved in [1], the general proof is beyond the scope of the present paper.

## 2. Definition of the model

In this section we define the space of states and the Hamiltonian, or Transfer Matrix, acting on it. In order to do that it is convenient to introduce a larger space, corresponding to the case  $\ell = 1$ , and then use fusion. This has the advantages that it gives us a natural “combinatorial basis” to work with; however the situation, as we shall see, remains more subtle than in the case  $\ell = 1$ , because a projection operation is needed; in many cases, this means that results that are “obvious graphically” must be additionally shown to be compatible with the projection.

### 2.1. Link Patterns and Temperley–Lieb algebra

Let  $n$  be a positive integer, and  $\mathcal{L}_{2n}$  be the set of *link patterns* of size  $n$ , which are defined as non-crossing (planar) pairings of  $2n$  points. We want to imagine link patterns as living inside a disk, with the  $2n$  endpoints on the boundary; but it is sometimes more practical to unfold them to the traditional depiction on a half-plane, see Fig. 1. The number of such link patterns is known to be the Catalan number  $c_n = (2n)!/(n!(n+1)!)$ .

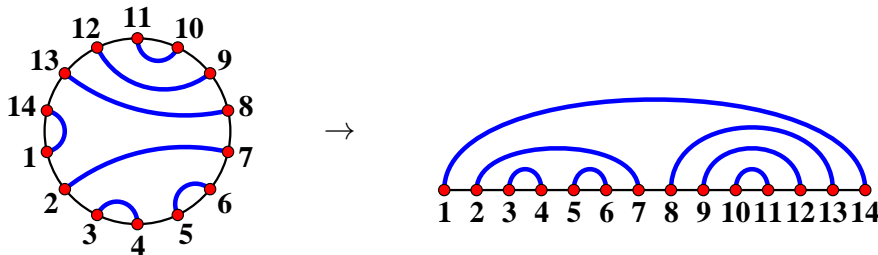

**Fig. 1:** A link pattern.

We view  $\mathcal{L}_{2n}$  as a subset of the involutions of  $\{1, \dots, 2n\}$  without fixed points, by setting  $\alpha(i) = j$  if  $i$  and  $j$  are paired by  $\alpha \in \mathcal{L}_{2n}$ .

Let  $\mathcal{H}_{2n} = \mathbb{C}[\mathcal{L}_{2n}]$ . For  $i = 1, \dots, 2n - 1$ , we define  $e_i$  to be the operator on  $\mathcal{H}_{2n}$  by defining its action on the canonical basis  $|\alpha\rangle$ ,  $\alpha \in \mathcal{L}_{2n}$ :

$$e_i|\alpha\rangle = \begin{cases} \tau|\alpha\rangle & \text{if } \alpha(i) = i + 1 \\ |c^{-1} \circ \alpha \circ c\rangle & \text{otherwise, } c \text{ cycle } (i, i + 1, \alpha(i + 1), \alpha(i)) \end{cases}$$

where  $\tau$  is a complex parameter, which for convenience we rewrite as  $\tau = -q - q^{-1}$ ,  $q \in \mathbb{C}^\times$ . We shall provide an alternative graphical rule below.

The  $e_i$ ,  $i = 1, \dots, 2n - 1$ , form a representation of the usual Temperley–Lieb algebra  $TL_{2n}(\tau)$ . By definition  $TL_L(\tau)$  is the algebra with generators  $e_i$ ,  $i = 1, \dots, L - 1$  and relations

$$e_i^2 = \tau e_i \quad e_i e_{i \pm 1} e_i = e_i \quad e_i e_j = e_j e_i \quad j \neq i - 1, i + 1. \quad (2.1)$$

It is well-known that the Temperley–Lieb algebra  $TL_L(\tau)$  can be viewed itself as the space of linear combinations of non-crossing pairings of points on strips of size  $L$ , see the example below, multiplication being juxtaposition of strips, with the additional prescription that each time a closed loop is formed, one can erase it at the price of multiplying by  $\tau$ . In particular, the generators  $e_i$  correspond to the strip with two little arches connecting sites  $i$  and  $i + 1$  on the top and bottom rows. We conclude that the dimension of  $TL_L(\tau)$  is  $c_L$ , so that for  $L = 2n$  it is  $c_{2n} = (4n)! / ((2n)!(2n + 1)!)$ . The action on link patterns is once again juxtaposition of the strip and of the link pattern (in the unfolded depiction), with the weight  $\tau^{\#\text{loops}}$  for erased loops. Since  $c_n^2 < c_{2n}$ , this representation is not faithful; however, when there is no possible confusion, we shall by abuse of language identify Temperley–Lieb algebra elements and the corresponding operators on  $\mathcal{H}_{2n}$ .

EXAMPLE:

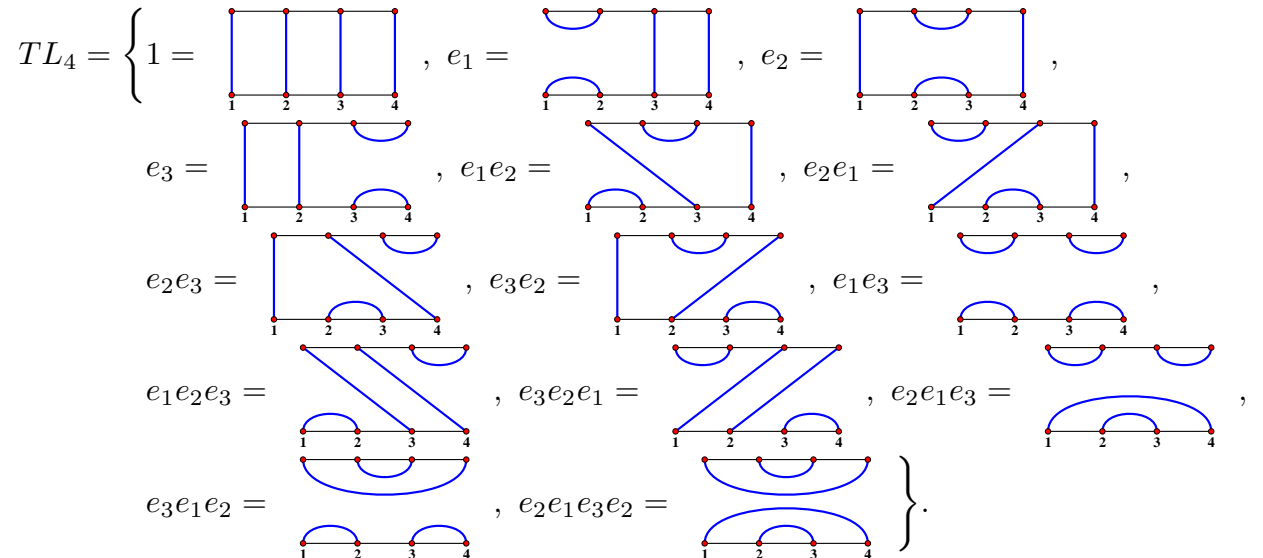

In what follows, we shall sometimes need an extra operator  $e_{2n}$ , defined just like the other  $e_i$ , but reconnecting the points  $2n$  and  $1$ . The  $e_i$ ,  $i = 1, \dots, 2n$  satisfy the same types of relations (2.1) as before, but assuming periodic indices:  $2n + 1 \equiv 1$ . These are defining relations of the “periodic” Temperley–Lieb algebra  $\widehat{TL}_{2n}(\tau)$ . Clearly, its elements can be represented as certain non-crossing pairings on an annular strip (acting in the obvious way on link patterns in the circular depiction), but in practice are more complex to handle. Fortunately in most circumstances we shall need to use only some subset of consecutive generators –  $e_i, e_{i+1}, \dots, e_{i+L-1}$ , or  $e_i, \dots, e_{2n}, e_1, \dots, e_{i-2n+L-1}$  – forming a representation of the usual (non-periodic)  $TL_L(\tau)$ .

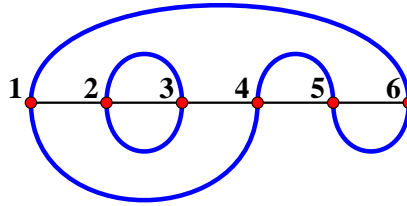

**Fig. 2:** Gluing two link patterns together. Here two loops are formed.

## 2.2. Bilinear form

There is an important pairing  $\langle \cdot | \cdot \rangle$  of link patterns which extends into a symmetric bilinear form on  $\mathcal{H}_{2n}$ . It consists of taking a mirror image of one link pattern, gluing it to the other and assigning it the usual weight  $\tau^{\#\text{loops}}$ , see Fig. 2. There is also an anti-automorphism  $*$  of the periodic Temperley–Lieb algebra defined by  $e_{i*} = e_i$  (noting that the defining relations of  $\widehat{TL}_{2n}(\tau)$  are invariant with respect to writing words in  $e_i$  in the reverse order); graphically, it associates to an operator its mirror image, and therefore we have the identity

$$\langle \alpha | x_* | \beta \rangle = \langle \beta | x | \alpha \rangle \quad x \in \widehat{TL}_{2n}(\tau) . \quad (2.2)$$

Define  $g_{\alpha\beta} = \langle \alpha | \beta \rangle$ ; the determinant of the matrix  $g$  was computed in [9], In particular, it is non-zero when  $q$  (that enters into the loop weight  $\tau = -q - q^{-1}$ ) is generic, i.e. not a root of unity (see also [10]). However, in what follows we shall be particularly interested in the situation  $q^{2(\ell+2)} = 1$ , in which  $g$  is singular for  $n$  large enough, and the mapping  $|\alpha\rangle \mapsto \langle \alpha | \cdot \rangle$  is *not* an isomorphism from  $\mathcal{H}_{2n}$  to  $\mathcal{H}_{2n}^*$ , which requires some care in handling bra-ket expressions.

In particular, a remark is in order: in the “strip” description of the Temperley–Lieb algebra  $TL_{2n}(\beta)$ , it is clear that any operator  $|\alpha\rangle\langle\beta|\cdot$  belongs to the Temperley–Lieb algebra (they are those pairings of  $2 \times 2n$  points with no “up–down” pairings); therefore, for  $q$  generic the mapping from  $TL_{2n}(\tau)$  to the space of operators  $L(\mathcal{H}_{2n})$  is surjective. It is however in general not surjective any more for  $q$  root of unity; this is consistent with the fact that there is no notion of adjoint operator with respect to the bilinear form for an arbitrary operator on  $\mathcal{H}_{2n}$  (which  $*$  provides for Temperley–Lieb elements), a point that will become crucial in Sec. 3.1.

### 2.3. Projection

Fix now a positive integer  $\ell$ , and assume that  $n = \ell m$ . For each subset  $S_i = \{\ell(i-1) + 1, \dots, \ell i\}$ ,  $i = 1, \dots, 2m$ , of  $\ell$  consecutive points, we define a local projector  $p_i$ ; it is uniquely characterized by

- (i)  $p_i|\alpha\rangle = 0$  if  $\exists j, k \in S_i$  such that  $\alpha(j) = k$ .
- (ii)  $p_i$  is in the subalgebra generated by the  $e_k$ ,  $k = \ell(i-1) + 1, \dots, \ell i - 1$ .
- (iii)  $p_i^2 = p_i$  (normalization).

The details of their construction and their main properties are listed in appendix A. Here we give the key formula which is the recurrence definition: start with  $p^{(1)} = 1$  and

$$p^{(k+1)}(e_j, \dots, e_{j+k-1}) = p^{(k)}(e_j, \dots, e_{j+k-2})(1 - \mu_k(\tau)e_{j+k-1})p^{(k)}(e_j, \dots, e_{j+k-2}) \quad (2.3)$$

where  $\mu_k(\tau) = U_{k-1}(\tau)/U_k(\tau)$  and  $U_k$  is the Chebyshev polynomial of the second kind. Then  $p_i := p^{(\ell)}(e_{\ell(i-1)+1}, \dots, e_{\ell i-1})$ .

In particular we note that at the zeroes of the Chebyshev polynomials  $U_j(\tau)$ ,  $1 \leq j \leq \ell - 1$ , that is if  $q^{2j} = 1$  for some  $1 \leq j \leq \ell$ , the  $p_i$  are undefined; we therefore exclude from now on these roots of unity.

The  $p_i$  form a family of commuting orthogonal projectors; define  $P = \prod_{i=1}^{2m} p_i$ , and  $\mathcal{H}_{\ell, 2m} = P(\mathcal{H}_{2n})$ . Furthermore, define

$$\mathcal{L}_{\ell, 2m} = \{ \alpha \in \mathcal{L}_{2n} : \forall i, j \in S_i \ \alpha(j) \notin S_i \}$$

that is, the set of link patterns with no arches within one of the subsets  $S_i$ .

EXAMPLE:

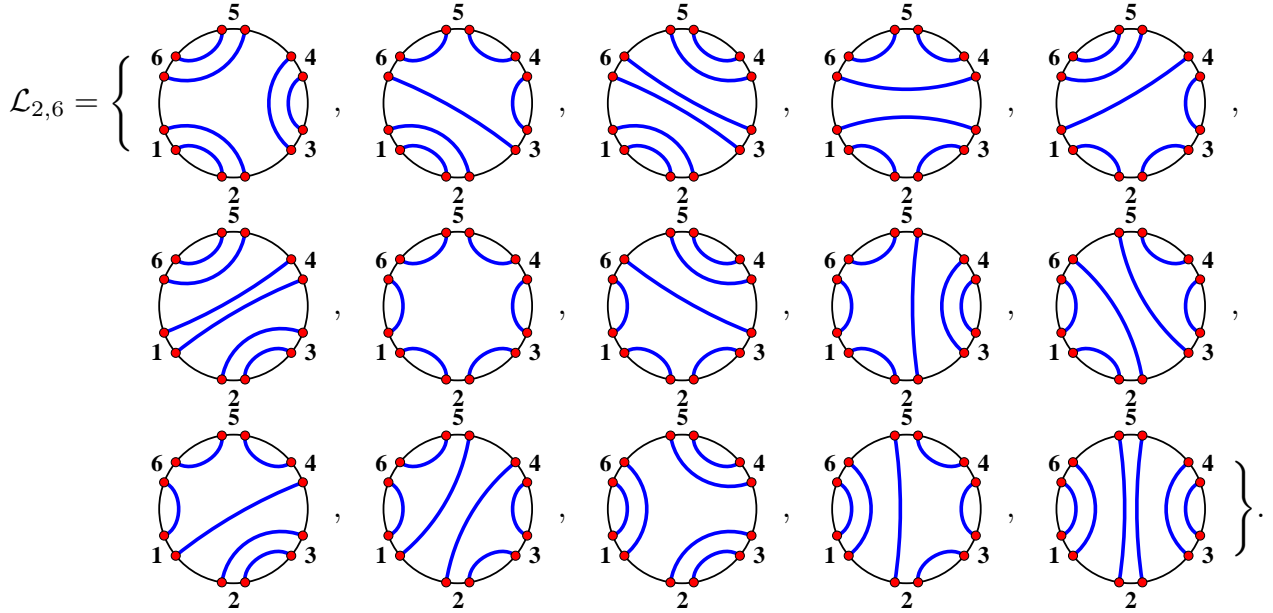

It is crucial to observe that the  $|\alpha\rangle$ ,  $\alpha \in \mathcal{L}_{\ell,2m}$ , do not belong to  $\mathcal{H}_{\ell,2m}$ . However, if we define  $|\tilde{\alpha}\rangle := P|\alpha\rangle$ ,  $\alpha \in \mathcal{L}_{\ell,2m}$ , we can state:

PROPOSITION 1. *The  $|\tilde{\alpha}\rangle$  form a basis of  $\mathcal{H}_{\ell,2m}$ .*

Proof. Clearly,  $P|\alpha\rangle = 0$  if  $\alpha \notin \mathcal{L}_{\ell,2m}$ . Therefore  $\dim \mathcal{H}_{\ell,2m} \leq \#\mathcal{L}_{\ell,2m}$ , and it suffices to show that the  $|\tilde{\alpha}\rangle$  are independent. But this is obvious in view of the fact that  $|\tilde{\alpha}\rangle$  is of the form  $|\tilde{\alpha}\rangle = |\alpha\rangle + \sum_{\beta \notin \mathcal{L}_{\ell,2m}} c(\alpha, \beta)|\beta\rangle$  for all  $\alpha \in \mathcal{L}_{\ell,2m}$ .  $\square$

Note that this basis coincides with the dual canonical basis of the invariant subspace of  $2m$  copies of the  $(\ell + 1)$ -dimensional representation of  $U_q(\mathfrak{sl}(2))$ , see [11] (thanks to K. Shigechi for pointing this out).

We can now introduce a set of local operators, the  $e_i^{(j)}$ ,  $j = 0, \dots, \ell$ , acting on the two subsets  $S_i$  and  $S_{i+1}$  for  $i = 1, \dots, 2m$  (with  $S_{m+1} \equiv S_1$ ). They are defined by  $e_i^{(j)} = P e_{li} e_{li-1} e_{li+1} \cdots e_{li-j+1} \cdots e_{li+j-1} \cdots e_{li-1} e_{li+1} e_{li} P$ , but best understood graphically, see Fig. 3.

The  $e_i^{(j)}$  satisfy a certain algebra which we do not need to describe entirely. However we need the following results:

LEMMA 1. *The image of  $e_i^{(j)}$  is included in the span of the  $|\tilde{\alpha}\rangle$  such that there are (at least)  $j$  arches between  $S_i$  and  $S_{i+1}$ , i.e.  $\alpha(li) = li + 1, \dots, \alpha(li - j + 1) = li + j$ .*

Proof. This is obvious graphically, since  $e_i^{(j)}$  reconnects precisely these pairs of points mentioned in the lemma, then projects.  $\square$

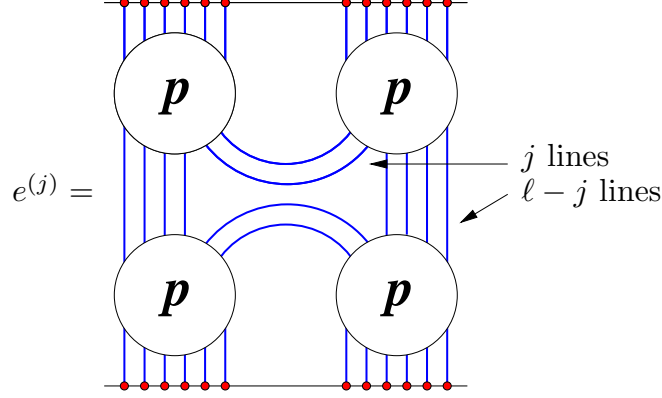

**Fig. 3:** Definition of  $e_i^{(j)}$ . The two subsets of vertices are  $S_i$  and  $S_{i+1}$ . The circled  $p$ 's are the local projection operators  $p_i$  and  $p_{i+1}$ .

LEMMA 2. *The equality of Fig. 4 holds. Consequently, (a) Consider a link pattern  $\alpha$  such that  $S_i$  and  $S_{i+1}$  are fully connected, i.e.  $\alpha(\ell i) = \ell i + 1, \dots, \alpha(\ell(i-1) + 1) = \ell(i+1)$ . Then*

$$e_i^{(j)} |\tilde{\alpha}\rangle = \frac{U_\ell(\tau)}{U_{\ell-j}(\tau)} |\tilde{\alpha}\rangle. \quad (2.4)$$

(b) *Equivalently,*

$$e_i^{(j)} e_i^{(\ell)} = e_i^{(\ell)} e_i^{(j)} = \frac{U_\ell(\tau)}{U_{\ell-j}(\tau)} e_i^{(\ell)}. \quad (2.5)$$

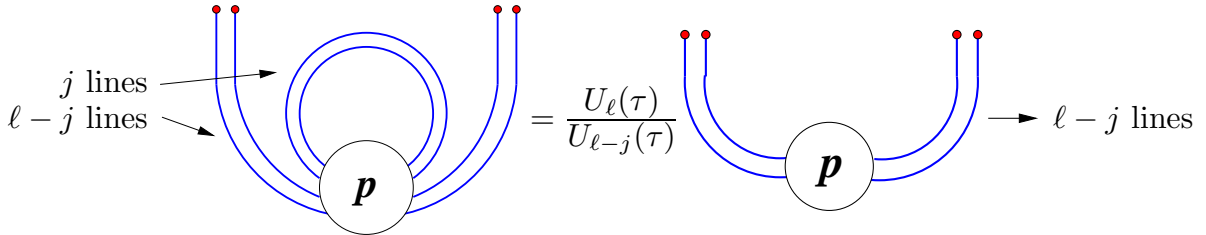

**Fig. 4:** Graphical equality of Lemma 2.  $p$  refers to  $p^{(\ell)}$  in the l.h.s. and to  $p^{(\ell-j)}$  in the r.h.s.

Proof. The proof is by induction on  $\ell$ . Consider the l.h.s. of Fig. 4 and replace  $p^{(\ell)}$  with its definition by recurrence from Appendix A, choosing to apply  $p^{(\ell-1)}$  to the  $\ell - j$  open lines and to  $j - 1$  closed lines, excluding the innermost closed line: we obtain two terms which are both precisely of the same form as the l.h.s., but with  $\ell - 1$  lines among which  $j - 1$  close, and coming with coefficients  $\tau$  (one closed loop) and  $-\mu_{\ell-1}(\tau)$ . Applying the induction hypothesis we find the coefficient of proportionality to be  $(\tau - U_{\ell-2}(\tau)/U_{\ell-1}(\tau))U_{\ell-1}(\tau)/U_{\ell-j}(\tau) = (\tau U_{\ell-1}(\tau) - U_{\ell-2}(\tau))/U_{\ell-j}(\tau) =$



$U_\ell(\tau)/U_{\ell-j}(\tau)$ . The proof of Eqs. (2.4) and (2.5) is a simple application of this formula, noting that when there are series of projections one can coalesce them into a single projection.  $\square$

This second lemma is particularly important; we provide on Fig. 5 two more graphical corollaries of it.

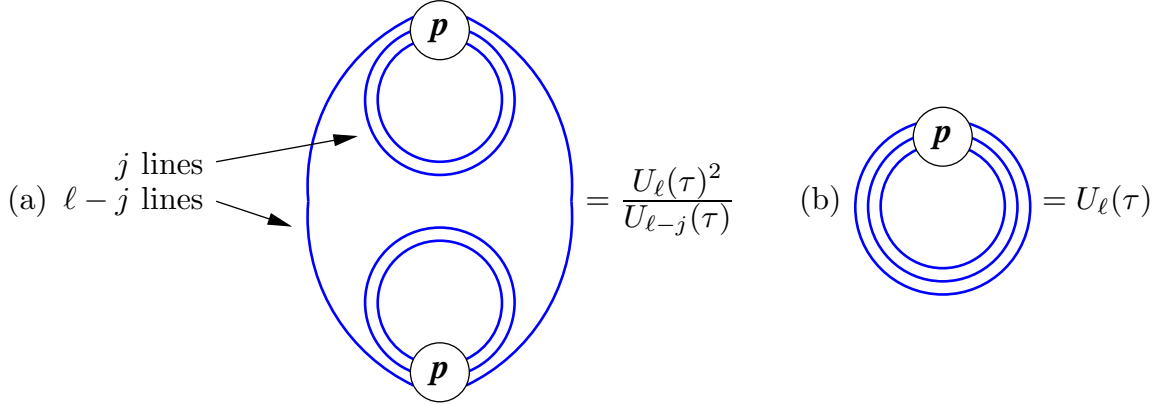

**Fig. 5:** Equalities obtained from Lemma 2. On the two figures  $p = p^{(\ell)}$ .

#### 2.4. Fusion

Let us briefly describe the fusion mechanism. Since this is standard material, we shall not prove the following facts.

Start with the  $\ell = 1$   $R$ -matrix

$$r_i(z, w) = \frac{qz - q^{-1}w}{qw - q^{-1}z} + \frac{z - w}{qw - q^{-1}z} e_i. \quad (2.6)$$

We now fuse  $\ell^2$   $R$ -matrices<sup>1</sup> into a single operator  $R$  by

$$\begin{aligned} R_i(z, w) = & \left( \prod_{k=1}^{\ell} \frac{q^{-k}z - q^k w}{q^k z - q^{-k} w} \right) r_{\ell i}(q^{-\ell+1}z, q^{\ell-1}w) \\ & r_{\ell i-1}(q^{-\ell+3}z, q^{\ell-1}w) r_{\ell i+1}(q^{-\ell+1}z, q^{\ell-3}w) \\ & \dots \\ & r_{\ell(i-1)+1}(q^{\ell-1}z, q^{\ell-1}w) \dots r_{\ell(i+1)-1}(q^{-\ell+1}z, q^{-\ell+1}w) \end{aligned}$$

---

<sup>1</sup> Note that to define a transfer matrix, one could fuse only  $\ell$   $R$ -matrices, keeping a single line for the “auxiliary space”. However we need the doubly fused  $R$ -matrix to write the form of the Yang–Baxter equation that we need, and to obtain the Hamiltonian.

$$\begin{aligned}
& \dots \\
& r_{\ell i-1}(q^{\ell-1}z, q^{-\ell+3}w)r_{\ell i+1}(q^{\ell-3}z, q^{-\ell+1}w) \\
& r_{\ell i}(q^{\ell-1}z, q^{-\ell+1}w) P .
\end{aligned} \tag{2.7}$$

Due to the choice of arguments of the  $R$ -matrices,  $R_i$  leaves  $\mathcal{H}_{\ell,2m}$  stable.

We shall need a more explicit form of  $R_i$ . This is possible, using the local operators  $e_i^{(j)}$  introduced previously:

$$R_i(z, w) = \sum_{j=0}^{\ell} a_j \left( \prod_{k=0}^{\ell-j} \frac{q^k z - q^{-k} w}{q^{k-\ell} z - q^{\ell-k} w} \right) e_i^{(j)} \tag{2.8}$$

where  $a_j = a_{\ell-j} = \prod_{k=1}^j \frac{U_{\ell-k}(\tau)}{U_{k-1}(\tau)}$ .

$R_i(z, w)$  has poles when  $w/z = q^{-2}, \dots, q^{-2\ell}$  and is non-invertible when  $w/z = q^2, \dots, q^{2\ell}$ ; for other values of  $z/w$  it satisfies the unitarity equation

$$R_i(z, w)R_i(w, z) = 1 . \tag{2.9}$$

Next we define the fully inhomogeneous transfer matrix  $T(z|z_1, \dots, z_{2m})$ . This requires to extend slightly the space  $\mathcal{H}_{\ell,2m}$  into  $\mathcal{H}_{\ell,2m+1}$  where the additional ‘‘auxiliary’’  $\ell$  lines are drawn horizontally. One also defines the ‘‘partial trace’’  $\text{tr}_{aux}$  which to an operator on  $\mathcal{H}_{\ell,2m+1}$  associates an operator on  $\mathcal{H}_{\ell,2m}$  obtained by reconnecting together the incoming and outgoing auxiliary lines,<sup>2</sup> including a weight of  $\tau = -q - q^{-1}$  by closed loop. Then the transfer matrix corresponds to the auxiliary line crossing all other lines then reconnecting itself (see Fig. 6)

$$T(t|z_1, \dots, z_{2m}) = \text{tr}_{aux} R_{2m}(z_{2m}, t) \cdots R_2(z_2, t) R_1(z_1, t) \tag{2.10}$$

---

<sup>2</sup> Making the auxiliary line horizontal conceals the fact that this operation induces a rotation of the link pattern, since the auxiliary line has changed its position from left to right relative to the rest of the lines.

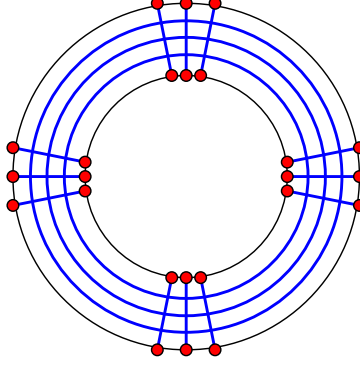

**Fig. 6:** The transfer matrix ( $\ell = 3$ ,  $2m = 4$ ). Each  $\ell \times \ell$  grid is the fused  $R$ -matrix.

The transfer matrix satisfies two forms of the Yang–Baxter equation. The first one is the well-known “RTT” form, which implies the commutation relation  $[T(t), T(t')] = 0$ , where all  $z_i$  are fixed. The second one simply reads:

$$T(t|z_1, \dots, z_i, z_{i+1}, \dots, z_{2m}) R_i(z_i, z_{i+1}) = R_i(z_i, z_{i+1}) T(t|z_1, \dots, z_{i+1}, z_i, \dots, z_{2m}) \quad (2.11)$$

for  $i = 1, \dots, 2m$  (with  $z_{2m+1} \equiv z_1$ ).

We also need the “scattering matrices”  $T'_i := T(z_i|z_1, \dots, z_{2m})$ ,  $1 \leq i \leq 2m$ . Using the fact that  $R_i(z, z) = 1$ , one finds

$$T'_i = R_i(z_i, z_{i+1}) \dots R_{2m-1}(z_i, z_{2m}) R_{2m}(z_i, z_1) R_1(z_i, z_2) \dots R_{i-1}(z_i, z_{i-1}) \rho \quad (2.12)$$

where  $\rho$  is the rotation of link patterns:  $(\rho\alpha)(i) = \alpha(i - \ell) + \ell$  (modulo  $2n$ ), which sends  $S_i$  to  $S_{i+1}$ .

One can also define the Hamiltonian. Consider the homogeneous situation  $z_i = 1$ . Then it is natural to expand  $T$  around  $t = 1$  to obtain commuting operators that are expressed as sums of local operators (the  $e_i^{(j)}$ ). Explicitly, expanding at first order, we find that  $T(t)$  commutes with

$$H := (q - q^{-1}) T(1)^{-1} \frac{\partial}{\partial t} T(t)|_{t=1} + cst = \sum_{i=1}^{2m} \sum_{j=1}^{\ell} \frac{1}{U_{j-1}(\tau)} e_i^{(j)} \quad (2.13)$$

(the constant term in the expansion has been cancelled for convenience).

### 2.5. Cell depiction

Finally, there is yet another graphical depiction of link patterns in  $\mathcal{L}_{\ell,2m}$ : since vertices in the same subset  $S_i$  are never connected to each other, one can simply coalesce them into a single vertex: the result is a division of the disk into 2-dimensional cells such that  $\ell$  edges come out of each of the  $2m$  vertices on the boundary.

EXAMPLE: at  $\ell = 2$  cells can be conveniently drawn using the natural bicolouration of cells according to whether they touch the exterior circle at vertices or edges (see also below the

discussion of exterior vs interior cells):

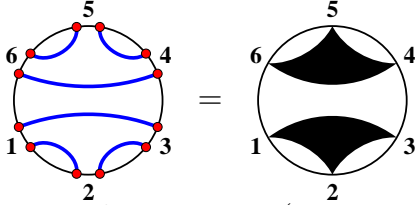

. Note that if one

straightens edges to produce polygons, one can obtain 2-gons (or worse, several 2-gons that sit on top of each other); it is therefore possible to work with polygonal cells on condition that such singular configurations be included.

For future use, we now define the following notion: a link pattern  $\alpha \in \mathcal{L}_{\ell,2m}$  is said to be  $\ell$ -admissible if all its cells have an even number of edges. When there is no ambiguity we shall simply say “admissible”, noting that this is an abuse of language since admissibility is an  $\ell$ -dependent property: some edges disappear when vertices are merged. Call  $\mathcal{L}'_{\ell,2m}$  the set of  $\ell$ -admissible link patterns.

EXAMPLE:

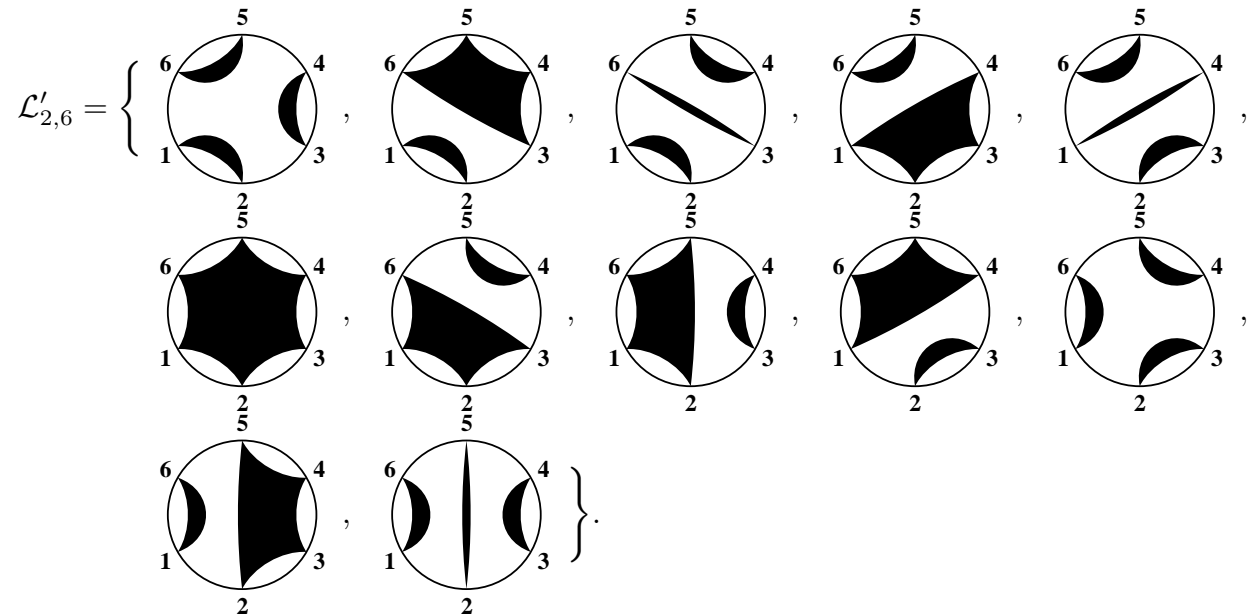

We also need a simple fact about admissible link patterns. Call  $r(i)$  the remainder of the division of  $i - 1$  by  $\ell$ .

LEMMA 3. If  $\alpha$  is an  $\ell$ -admissible link pattern, then  $r(i) + r(\alpha(i)) = \ell - 1$  for  $1 \leq i \leq 2m$ .

Proof. Induction on  $\alpha(i) - i \pmod{2m} \in \{1, \dots, 2m - 1\}$ .

★ If  $\alpha(i) = i + 1$ :  $\alpha \in \mathcal{L}_{\ell, 2m}$  forbids any arches inside a given subset of  $\ell$  vertices, therefore  $r(i) = \ell - 1$ ,  $r(i + 1) = 0$ .

★ If  $\alpha(i) - i > 1$ : call  $k = r(i + 1)$ . Consider the cell with edge  $(i, \alpha(i))$  such that all its other vertices are between  $i$  and  $\alpha(i)$  moving counterclockwise around the circle. The idea is to use the induction hypothesis for all these other vertices. Two cases have to be distinguished: either (i)  $k = 0$ , in which case the values of  $r$  at vertices (in the sense of the original depiction) of the cell follow a pattern:  $0, \ell - 1, 0$ , etc and we obtain immediately  $r(i) = \ell - 1$ ,  $r(\alpha(i)) = 0$ ; or (ii)  $k > 0$ . In this case, the values of  $r$  at vertices of the cell are of the form  $k, \ell - 1 - k, \ell - k, k - 1, k$ , etc, being careful that these vertices are coalesced into pairs  $\{k - 1, k\}$  and  $\{\ell - 1 - k, \ell - k\}$  to form the actual vertices of the cell. But since  $\alpha$  is admissible, the cell has an even number of edges, and when we reach  $\alpha(i)$  we get the value  $\ell - k$ , so that  $r(i) = k - 1$ ,  $r(\alpha(i)) = \ell - k$ .  $\square$

In the course of the proof, we have found that one can associate to each cell  $c$  of an admissible link pattern a pair of integers  $\{k(c), \ell - k(c)\}$ : conventionally we choose  $k(c)$  to be the smaller of the two. Graphically,  $k(c)$  is the “distance” from the cell to the boundary, defined as the minimum number of edges one needs to cross to reach the exterior circle (excluding the circle itself). Following the subdivision in the proof, We call *exterior* (resp. *interior*) a cell  $c$  such that  $k(c) = 0$  (resp.  $k(c) > 0$ ). An exterior cell touches the circle at every other edge, whereas an interior cell touches it at vertices only. In practice exterior cells play no role in what follows, as will become clear, and on the pictures they will be left uncolored. Note that in the case  $\ell = 2$  this notion coincides with the natural bicolouration of cells.

Also note that the converse of lemma 3 is untrue. In particular if  $\ell = 2$  the property of lemma 3 is always satisfied by parity.

In appendix B,  $\ell$ -admissible link patterns are enumerated, and it is found that

$$\#\mathcal{L}'_{\ell, 2m} = \frac{((\ell + 1)m)!}{(\ell m + 1)!m!}. \quad (2.14)$$

### 3. Combinatorial point

We now investigate the special value  $q = -e^{\pm i\pi/(\ell+2)}$ , that is  $\tau = -q - q^{-1} = 2 \cos \frac{\pi}{\ell+2} = 1, \sqrt{2}, \frac{1+\sqrt{5}}{2}, \sqrt{3}, \dots$

### 3.1. Degeneration of the bilinear form

Define the matrix of the bilinear form in the subspace  $\mathcal{H}_{\ell,2m}$ :

$$\tilde{g}_{\alpha\beta} := \langle \tilde{\alpha} | \tilde{\beta} \rangle = \langle \alpha | P | \beta \rangle \quad \alpha, \beta \in \mathcal{L}_{\ell,2m} .$$

**THEOREM 1.** *The rank of the matrix  $\tilde{g}$  is one.*

*Proof.* As many reasonings in this paper, the proof is best understood pictorially. It makes use of Lemma 2, with the additional assumption that  $q = -e^{\pm i\pi/(\ell+2)}$ , which implies that  $U_j(\tau) = U_{\ell-j}(\tau)$ . Fig. 4(a) therefore implies the equality of Fig. 7(a), which itself can be rewritten as Fig. 7(b), noting that any link pattern in  $\mathcal{L}_{\ell,4}$  is of the form of Fig. 7(a) for some  $j$  – and for any other link pattern in  $\mathcal{L}_{4\ell}$ , both l.h.s. and r.h.s. are zero.

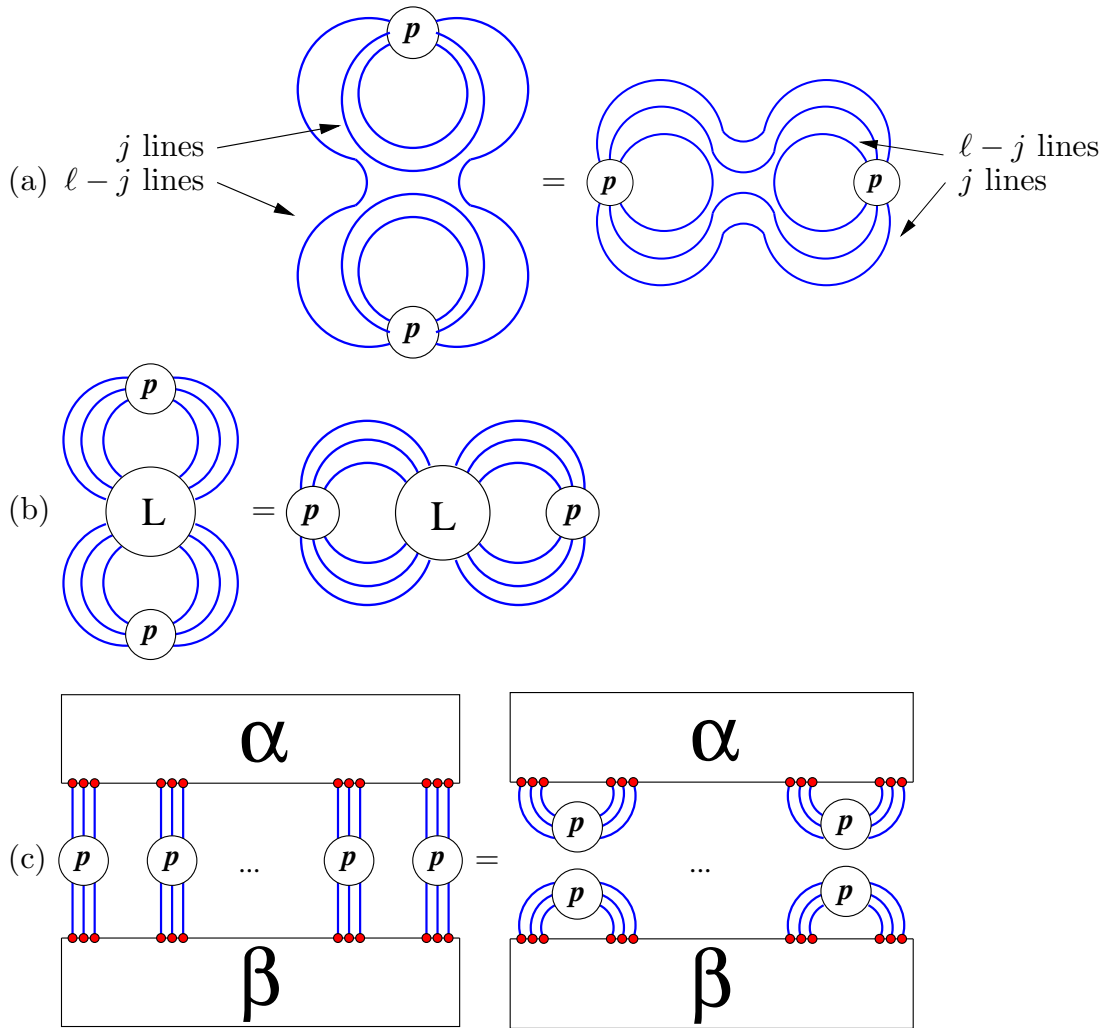
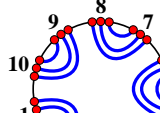

**Fig. 7:** Graphical proof of Thm. 1. L stands for any linear combination of link patterns.

Consider now the bracket  $\langle \alpha | P | \beta \rangle$ . Using repeatedly the identity of Fig. 7(b), we obtain Fig. 7(c), that is

$$\langle \tilde{\alpha} | \tilde{\beta} \rangle = \langle \tilde{\alpha} | 0 \rangle \langle 0 | \tilde{\beta} \rangle \quad (3.1)$$

where 0 denotes the link pattern which fully connects  $S_{2i-1}$  and  $S_{2i}$ , as in the r.h.s. of

Fig. 7(c) (e.g. ). Thus,  $\tilde{g} = v \otimes v$ ,  $v$  the linear form  $\langle 0 | \cdot \rangle$  on  $\mathcal{H}_{\ell, 2m}$  which is

non-zero since  $\tilde{g}_{00} = \langle 0 | P | 0 \rangle = 1$  (Fig. 4(b)).  $\square$

Remark: there is another link pattern  $0'$  related to 0 by rotation, which connects  $S_{2i}$  and  $S_{2i+1}$  ( $2m + 1 \equiv 1$ ). The argument above works equally well with  $\langle 0' |$ .

We can in fact provide an explicit formula for  $\tilde{g}$ , of the form  $\tilde{g}_{\alpha\beta} = v_\alpha v_\beta$ ,  $\alpha, \beta \in \mathcal{L}_{\ell, 2m}$ :

PROPOSITION 2.

$$v_\alpha = \langle 0 | \tilde{\alpha} \rangle = \begin{cases} 0 & \text{if } \alpha \text{ is non-admissible} \\ \prod_{\text{cell } c} U_{k(c)}(\tau)^{-l(c)/2+1} & \text{if } \alpha \text{ is admissible} \end{cases} \quad (3.2)$$

where the product can be restricted to interior cells only,  $l(c)$  is the number of edges of cell  $c$  (note that 2-gons do not contribute), and  $k(c)$  is the distance from the cell to the boundary as defined in Sect. 2.3.

Proof. Induction on  $m$ .  $m = 1$  is trivial. For a given link pattern  $\alpha$ , we shall pick a certain pair of subsets  $S_i, S_{i+1}$  and reconnect them with a projection: this is one step in the pairing with  $\langle 0 |$  (or  $\langle 0' |$ , depending on the parity of  $i$ ), and we can then use the induction hypothesis.

For any link pattern, it is easy to check that one of these two situations must arise (graphically, that there exists a cell which has no “nested” cells):

(i) either there are two subsets  $S_i$  and  $S_{i+1}$  which are fully connected to each other. These correspond to  $\ell$  2-gons which should not contribute to  $v_\alpha$ . Indeed, applying Fig. 5(b), the loops, once closed with a projection, contribute  $U_\ell(\tau) = 1$  and can be removed, leading to the step  $m - 1$ .

(ii) or there is a subset  $S_i$  such that  $j$  lines connect it to  $S_{i-1}$  and  $\ell - j$  lines connect it to  $S_{i+1}$ . We reconnect  $S_i$  and  $S_{i+1}$  and apply Lemma 2 (Fig. 4). In the process some 2-gons are erased, and the only other (interior) cell that is affected is the one directly above, see Fig. 8, which we denote by  $c$ . One checks that  $c$  loses 2 edges. If  $c$  had 3 edges

to begin with, it becomes a cell with 1 edge i.e. there is a connection inside a subset and the resulting link pattern does not belong to  $\mathcal{L}'_{\ell,2(m-1)}$ , so  $v_\alpha = 0$ . If  $c$  had a higher odd number of edges the resulting link pattern is not admissible and by induction  $v_\alpha$  is again zero. Finally, if the number of edges of  $c$  is even, we note that  $\min(j, \ell - j) = k(c)$  and the contribution  $1/U_j(\tau)$  plus the induction hypothesis reproduce Eq. (3.2) (whether  $\alpha$  is admissible or not).  $\square$

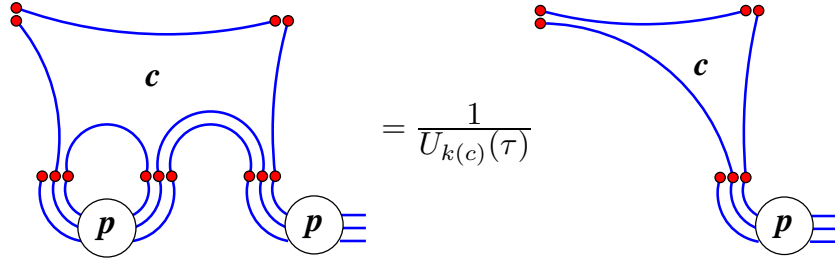

**Fig. 8:** Case (ii) of the proof of Prop. 2.

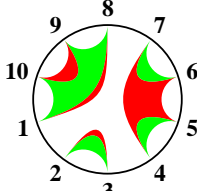
EXAMPLE: consider the diagram  $\alpha =$    $\in \mathcal{L}_{3,10}$ . It is admissible, and there

are two 4-gons at distance 1, so  $v_\alpha = U_1(\tau)^{-2} = ((1 + \sqrt{5})/2)^{-2}$ .

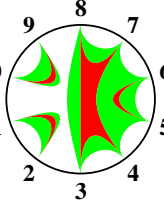
$\alpha =$    $\in \mathcal{L}_{4,10}$  is also admissible, there are 4-gons at distance 1 and 2, so  $v_\alpha = U_1(\tau)^{-1}U_2(\tau)^{-1} = 1/(2\sqrt{3})$ .

Remark. For  $\ell = 2, 3$ , since the only non-trivial  $U_j(\tau)$  are equal to  $\tau$ , one can simplify the formula for admissible link patterns to:  $v_\alpha = \tau^{-m+\#\text{connected components of cells}}$ .

### 3.2. Common left eigenvector

Consider now any operator  $x$  of the (periodic) Temperley–Lieb algebra, projected onto  $\mathcal{H}_{\ell,2m}$ , that is  $x = PxP$ . As explained in Sec. 2.2, it possesses a mirror symmetric  $x_*$ . Let us write in components the identity (2.2) expressing this fact: if  $x|\tilde{\alpha}\rangle = \sum_\beta x^\beta_\alpha|\tilde{\beta}\rangle$



and  $x_*|\tilde{\alpha}\rangle = \sum_{\beta} x_{*\alpha}^{\beta}|\tilde{\beta}\rangle$ , then  $\tilde{g}_{\alpha\gamma}x_{*\beta}^{\gamma} = \tilde{g}_{\beta\gamma}x_{*\alpha}^{\gamma}$ , where summation over repeated indices is implied, or, choosing any  $\beta$  such that  $v_{\beta} \neq 0$ ,

$$v_{\gamma}x_{*\alpha}^{\gamma} = \frac{v_{\gamma}x_{*\beta}^{\gamma}}{v_{\beta}}v_{\alpha}. \quad (3.3)$$

In other words,  $v$  is a left eigenvector of  $x$  (and of  $x_*$  by exchanging their roles). What we have found is that the right-representation of  $P\widehat{TL}_{2n}(\tau)P$  on  $\mathcal{H}_{\ell,2m}^*$  possesses a one-dimensional stable subspace; and therefore also that the left-representation on  $\mathcal{H}_{\ell,2m}$  is decomposable (but not reducible, as it turns out) with a stable subspace of codimension one (the kernel of  $v$ ). Note that an advantage of defining the left eigenvector  $v$  from the bilinear form is that it provides a convenient natural normalization of  $v$ .

LEMMA 4. *Eigenvalues of various operators for the left eigenvector  $v$ :*

$$\begin{aligned} v e_i^{(j)} &= \frac{1}{U_j(\tau)}v & j = 0, \dots, \ell \\ v R_i(z, w) &= v \\ v T(t|z_1, \dots, z_{2m}) &= v \\ v H &= 2m\tau v \end{aligned} \quad (3.4)$$

Proof. Since we already know that  $v$  is a left eigenvector of  $e_i^{(j)}$ , we only need to compute  $v e_i^{(j)}|\tilde{\alpha}\rangle$  where  $\alpha$  is a given admissible link pattern; we choose it as in the hypotheses of Lemma 2 (for example, either  $|0\rangle$  or  $|0'\rangle$  works). We conclude directly that  $U_{\ell}(\tau)/U_{\ell-j}(\tau)$  is the eigenvalue for  $v$ , which is the announced result using  $U_j(\tau) = U_{\ell-j}(\tau)$  at  $q = -e^{\pm i\pi/(\ell+2)}$ . The other formulae follow by direct computation.  $\square$

LEMMA 5. *The eigenvalue 1 of  $T(t|z_1, \dots, z_{2m})$  is simple for generic values of the parameters.*

Note that the set of degeneracies of the eigenvalue 1 is a closed subvariety of the space of parameters. Thus, finding one point where the eigenvalue is simple is enough to show the lemma. There are a variety of ways to find such a point, none of which being particularly simple. One can for example consider the limit  $z_1 \ll z_2 \ll \dots \ll z_{2m}$ , in which all eigenvalues can be computed explicitly. The calculations are too cumbersome and will not be reproduced here.

### 3.3. Polynomial eigenvector

We have found in the previous section that the transfer matrix  $T(t|z_1, \dots, z_{2m})$  possesses the eigenvalue 1, with left eigenvector  $v$ ; what about the corresponding right eigenvector? The latter, which we denote by  $|\Psi\rangle = \sum_{\alpha} \Psi_{\alpha} |\tilde{\alpha}\rangle$ , depends on the parameters  $z_1, \dots, z_{2m}$  (but not on  $t$ ). Being the solution of a degenerate linear system of equations whose coefficients are rational fractions, it can be normalized in such a way that its components  $\Psi_{\alpha}$  are *coprime polynomials* in the variables  $z_1, \dots, z_{2m}$ . Furthermore, all equations being homogeneous, the  $\Psi_{\alpha}$  are homogeneous polynomials of the same degree  $\deg |\Psi\rangle$ . We now formulate a key result:

PROPOSITION 3.  $|\Psi(z_1, \dots, z_i, z_{i+1}, \dots, z_{2m})\rangle = R_i(z_i, z_{i+1})|\Psi(z_1, \dots, z_{i+1}, z_i, \dots, z_{2m})\rangle$ .

Proof. Eq. (2.11) shows that  $R_i(z_i, z_{i+1})|\Psi(z_{i+1}, z_i)\rangle$  is an eigenvector of  $T(z_1, \dots, z_{2m})$  with the eigenvalue 1 (Lemma 4). Since this eigenvalue is simple (Lemma 5), the l.h.s. and r.h.s. of Prop. 3 must be proportional:  $R_i(z_i, z_{i+1})|\Psi(z_{i+1}, z_i)\rangle = F(z_1, \dots, z_{2m})|\Psi(z_i, z_{i+1})\rangle$ ,  $F$  rational fraction. More precisely,

$$\prod_{k=1}^{\ell} (q^{-k} z_i - q^k z_{i+1}) R_i(z_i, z_{i+1}) |\Psi(z_{i+1}, z_i)\rangle = P(z_1, \dots, z_{2m}) |\Psi(z_i, z_{i+1})\rangle \quad (3.5)$$

where  $P(z_1, \dots, z_{2m}) = F(z_1, \dots, z_{2m}) \prod_{k=1}^{\ell} (q^{-k} z_i - q^k z_{i+1})$  is a polynomial since the  $\Psi_{\alpha}$  are coprime and the l.h.s. is already polynomial. Iterating this equation leads to

$$P(z_i, z_{i+1}) P(z_{i+1}, z_i) = \prod_{k=1}^{\ell} (q^{-k} z_i - q^k z_{i+1}) (q^{-k} z_{i+1} - q^k z_i) \quad (3.6)$$

i.e.  $P$  and therefore  $F$  are functions of only two variables and  $F(z, w) = \prod_{k \in K} \frac{q^{-k} w - q^k z}{q^{-k} z - q^k w}$  where  $K$  is some subset of  $\{1, \dots, \ell\}$ . To fix  $F$ , consider  $T'_i |\Psi\rangle$  (with  $T'_i$  given by Eq. (2.12)): on the one hand, since  $T'_i$  is simply the transfer matrix at a special choice of parameter  $t$ , we know that it has eigenvector  $\Psi$  with eigenvalue 1 (Lemma 4):  $T'_i |\Psi\rangle = |\Psi\rangle$ ; on the other hand, applying Eq. (3.5) repeatedly, we find that  $T'_i |\Psi\rangle = \prod_{j \neq i} F(z_i, z_j) |\Psi\rangle$ ; we easily conclude from this that  $F = 1$ .  $\square$

PROPOSITION 4. Suppose  $z_{i+1} = q^{2k} z_i$ ,  $1 \leq k \leq \ell$ . Then  $\Psi_{\alpha}(z_1, \dots, z_{2m}) = 0$  unless  $\alpha$  is such that there are (at least)  $\ell - k + 1$  arches between  $S_i$  and  $S_{i+1}$ .

Proof. Apply proposition 3 with  $R_i(z_i, q^{2k} z_i)$  replaced with its expression (2.8). As soon as  $\ell - j \geq k$ , the product is zero, so that  $R_i$  is a linear combination of  $e_i^{(\ell-k+1)}, \dots, e_i^{(\ell)}$ . The proposition is then a direct application of Lemma 1.  $\square$

Equivalently, since the components  $\Psi_\alpha$  are polynomials,  $z_{i+1} - q^{2k}z_i | \Psi_\alpha$ . We now state a broad generalization of Prop. 4:

**THEOREM 2.** *Suppose  $z_j = q^{2k}z_i$ ,  $1 \leq k \leq \ell$ ,  $j \neq i$ . Then  $\Psi_\alpha(z_1, \dots, z_{2m}) = 0$  unless  $\#\{p, q \in S_{i,j} : p < \alpha(p) = q\} \geq \ell - k + 1$ .*

Here  $S_{i,j}$  denotes the set of vertices between  $i$  and  $j$  in a cyclic way, that is  $S_{i,j} = \{\ell(i-1) + 1, \dots, \ell j\}$  if  $i < j$ ,  $\{\ell(i-1) + 1, \dots, 2m, 1, \dots, \ell j\}$  if  $j < i$ .

Note that this theorem is a generalization of (part of) theorem 1 of [1], and the proof is completely analogous. We present here a briefer version of it. Prop. 3 shows that  $|\Psi(\dots, z_i, z_{i+1}, \dots, z_j, \dots)\rangle$  and  $|\Psi(\dots, z_i, z_j, z_{i+1}, \dots)\rangle$  are related by a product of  $R$ -matrices from  $i+1$  to  $j-1$  (these  $R$ -matrices have poles, but are well-defined for generic values of the other  $z$ 's). According to Prop. 4, the only non-zero components of  $|\Psi(\dots, z_i, z_j, z_{i+1}, \dots)\rangle$  possess  $\ell - k + 1$  arches between subsets  $S_i$  and  $S_{i+1}$ . Now observe that the action of any Temperley–Lieb generator *cannot decrease* the number of arches within any range containing the 2 sites on which it is acting. Therefore multiplication by a product of  $R$ -matrices (which are themselves linear combinations of products of Temperley–Lieb generators acting somewhere between  $S_i$  and  $S_j$ ) does not decrease the number of arches between  $S_i$  and  $S_j$ .  $\square$

One can go further and look for cancellation conditions for the whole of  $|\Psi\rangle$ :

**PROPOSITION 5.** *Assume that  $z_{i+1} = q^{2k}z_i$  and  $z_{i+2} = q^{2k'}z_{i+1}$  so that  $z_i, z_{i+1}, z_{i+2}$  are in “cyclic order”, that is  $1 \leq k, k'$  and  $k + k' \leq \ell + 1$ . Then  $|\Psi(z_1, \dots, z_{2m})\rangle = 0$ .*

*Proof.* apply twice Prop. 4. For a component  $\Psi_\alpha$  to be non-zero,  $\alpha$  should have  $\ell - k + 1$  arches between  $S_i$  and  $S_{i+1}$ , and  $\ell - k' + 1$  arches between  $S_{i+1}$  and  $S_{i+2}$ ; thus the number of lines emerging from  $S_{i+1}$  should be  $2\ell - (k + k') + 2 \geq \ell + 1$ , which is impossible.  $\square$

Once again we can generalize this result to

**THEOREM 3.** *Assume that  $z_{i'} = q^{2k}z_i$  and  $z_{i''} = q^{2k'}z_{i'}$  so that  $z_i, z_{i'}, z_{i''}$  are in cyclic order, and  $i, i', i''$  are also in cyclic order ( $i < i' < i''$  or  $i' < i'' < i$  or  $i'' < i < i'$ ). Then  $|\Psi(z_1, \dots, z_{2m})\rangle = 0$ .*

We use exactly the same process as to go from Prop. 4 to Thm. 2. We note that  $|\Psi(\dots, z_i, \dots, z_{i'}, \dots, z_{i''}, \dots)\rangle$  is related to  $|\Psi(\dots, z_i, z_{i'}, z_{i''}, \dots)\rangle$  by a product of  $R$ -matrices, paying attention to the fact that none of these  $R$ -matrices are singular for generic values of the other parameters (this is where we use the fact that  $i, i', i''$  are in cyclic order). Then we apply Prop. 5.  $\square$

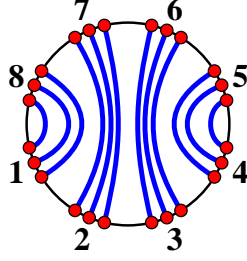

**Fig. 9:** Base link pattern of  $\mathcal{L}_{3,8}$ .

Let us now consider what we call the *base link pattern*  $\delta \in \mathcal{L}_{\ell,2m}$  defined by  $\delta(i) = 2n + 1 - i$ ,  $1 \leq i \leq 2n$ , see Fig. 9. Theorem 2 implies that

$$\Psi_\delta = \Omega \prod_{\substack{1 \leq i < j \leq m \\ \text{or} \\ m+1 \leq i < j \leq 2m}} \prod_{k=1}^{\ell} (q^k z_i - q^{-k} z_j) \quad (3.7)$$

where  $\Omega$  is a polynomial to be determined. Thus,  $\deg |\Psi\rangle = \deg \Psi_\delta \geq \ell m(m-1)$ . Based on experience with similar models [1,4,6] in which one can prove a “minimal degree property”, as well as extensive computer investigations, it is reasonable to formulate the

CONJECTURE 1.  $\deg |\Psi\rangle = \ell m(m-1)$ .

One should be able to prove this conjecture either by *ad hoc* methods, as in e.g. [1], or by a detailed analysis of the underlying representation theory on the space of polynomials, as suggested by the work [12]. This is not the purpose of the present work, and we proceed assuming Conjecture 1. To fix the normalization of  $|\Psi\rangle$  we set  $\Omega = (-1)^{\ell m(m-1)/2}$  in Eq. (3.7), so that the homogeneous value  $\Psi_\delta(1, \dots, 1) = \left(\frac{\ell+2}{2 \sin(\pi/(\ell+2))}\right)^{m(m-1)}$  is positive.

PROPOSITION 6. *Assuming Conjecture 1, each component  $\Psi_\alpha$  is of degree at most  $\ell(m-1)$  in each variable.*

Proof. The proof is strictly identical to that of Thm. 4 of [1], and will be sketched only. Using reflection covariance of the model, it is easy to see that

$$\prod_{i=1}^{2m} z_i^d \Psi_{s\alpha} \left( \frac{1}{z_{2m}}, \dots, \frac{1}{z_1} \right) = \Psi_\alpha(z_1, \dots, z_{2m}) \quad (3.8)$$

where  $s$  is the reflection of link patterns:  $(s\alpha)(i) = 2m + 1 - \alpha(2m + 1 - i)$ , and  $d$  is the maximum degree of the components  $\Psi_\alpha$  in each variable. Equating the total degrees in all variables on both sides of Eq. (3.8), we find  $2md - \ell m(m-1) = \ell m(m-1)$ , and therefore  $d = \ell(m-1)$ .  $\square$

We are now in a position to resolve the following natural question, which is to ask what one can say about the *non-zero* components when  $z_j = q^{2k} z_i$ . Here we answer this question in the simplest situation:

PROPOSITION 7. *Suppose  $z_{i+1} = q^2 z_i$ . Consider the embedding  $\varphi_i$  of  $\mathcal{L}_{\ell, 2(m-1)}$  into  $\mathcal{L}_{\ell, 2m}$  which inserts  $2\ell$  sites at  $S_i, S_{i+1}$  and  $\ell$  arches between  $S_i$  and  $S_{i+1}$ . Then, assuming Conj. 1,*

$$\begin{aligned} \Psi_{\varphi_i(\alpha)}(z_1, \dots, z_{i+1} = q^2 z_i, \dots, z_{2m}) \\ = q^{2(m-1)} \prod_{j \neq i, i+1} \prod_{k=1}^{\ell} (z_i - q^{2k} z_j) \Psi_{\alpha}(z_1, \dots, z_{i-1}, z_{i+2}, \dots, z_{2m}) \end{aligned} \quad (3.9)$$

for all  $\alpha \in \mathcal{L}_{\ell, 2(m-1)}$ , where it is understood that on the r.h.s.  $\Psi$  is the eigenvector at size  $m-1$ .

Proof. First we recall (cf proof of Prop. 4) that  $R_i(z_i, q^2 z_i)$  is proportional to  $e_i^{(\ell)}$ , the projector onto the span of the image of  $\varphi_i$ , so that according to Eq. (2.11),  $T(t|z_1, \dots, z_i, z_{i+1} = q^2 z_i, \dots, z_{2m})$  leaves this subspace invariant. This alone is sufficient to show that  $T(t|z_1, \dots, z_i, z_{i+1} = q^2 z_i, \dots, z_{2m}) \varphi_i \propto \varphi_i T(t|z_1, \dots, z_{i-1}, z_{i+2}, \dots, z_{2m})$ , but we need to compute the proportionality factor explicitly. The latter is given by evaluating Fig. 10. Since the result is proportional to the projector  $p$ , one can close the outgoing lines, replace the  $R$ -matrices with their expressions (2.8) and then apply repeatedly Lemma 2. Simplifying Eq. (2.8) at  $q = -e^{i\pi/(\ell+2)}$ , we find that the term  $j, j'$  in the double sum produces a contribution  $\frac{(z_i-t)(q z_i - q^{-1}t)}{(q^{-j-1} z_i - q^{j+1}t)(q^{-j} z_i - q^j t)}$  times the same for  $j'$  with  $z_i$  replaced with  $z_{i+1}$  (noting in particular that the factors  $1/(U_j U_{j'})$  produced by Lemma 2 compensate  $a_j a_{j'}$ ). Finally we find that the coefficient of proportionality is  $\sum_{j=0}^{\ell} \frac{(z_i-t)(q z_i - q^{-1}t)}{(q^{-j-1} z_i - q^{j+1}t)(q^{-j} z_i - q^j t)} = 1$  times the same sum with  $z_i$  replaced with  $z_{i+1}$ . Thus,

$$T(t|z_1, \dots, z_i, z_{i+1} = q^2 z_i, \dots, z_{2m}) \varphi_i = \varphi_i T(t|z_1, \dots, z_{i-1}, z_{i+2}, \dots, z_{2m}) \quad (3.10)$$

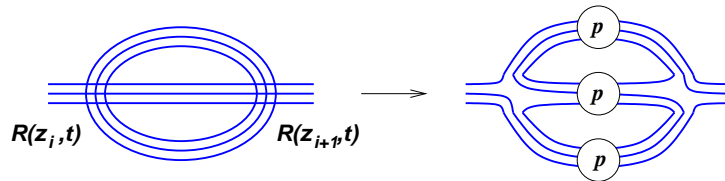

**Fig. 10:** Contribution of  $R(z_i, t)R(z_{i+1}, t)$  to the sector where  $S_i$  and  $S_{i+1}$  are fully connected to each other.

Lemma 5 then implies that the l.h.s. and r.h.s. of Eq. (3.9) are proportional, up to a rational function of the  $z_i$  which is independent of  $\alpha$ . To fix the proportionality factor, we consider the base link pattern, but rotated  $i$  times in such a way that there are  $\ell$  arches between  $S_i$  and  $S_{i+1}$ . When we remove the arches between  $S_i$  and  $S_{i+1}$  this is again the rotated base link pattern but at size  $2(m-1)$ . We can therefore compare their expressions (Eq. (3.7) with  $\Omega = (-1)^{\ell m(m-1)/2}$ ; this is the only place where we use Conj. 1) and collect the extra factors at size  $2m$ .  $\square$

The theorem can be easily generalized to  $z_j = q^{2k} z_i$ , along the lines of Thm. 6 of [1], but this will not be needed here. In the case  $z_j = q^{2k} z_i$ ,  $k > 1$ , the situation is more subtle: the recursion would lead to a new type of “mixed” loop model with  $2(m-1)$  usual subsets of  $\ell$  vertices and one special site which would have only  $2(k-1)$  vertices fused together. We do not pursue here this direction.

EXAMPLE: We provide the full analysis of the case  $2m = 4$ . As has already been mentioned in the course of the proof of Thm. 1, a state  $|j\rangle$  in  $\mathcal{L}_{\ell,4}$  is indexed by an integer  $j$ ,  $0 \leq j \leq \ell$ , in such a way that there are  $\ell - j$  arches between  $S_1$  and  $S_2$  and between  $S_3$  and  $S_4$ , and  $j$  arches between  $S_2$  and  $S_3$  and between  $S_4$  and  $S_1$ . (note that  $|\delta\rangle = |0'\rangle = |j\rangle$ ). We immediately conclude from Prop. 4 that

$$\Psi_j(z_1, z_2, z_3, z_4) = \Omega_j \prod_{k=1}^j (q^k z_1 - q^{-k} z_2)(q^k z_3 - q^{-k} z_4) \prod_{k=1}^{\ell-j} (q^k z_2 - q^{-k} z_3)(q^k z_4 - q^{-k} z_1) \quad (3.11)$$

where the  $\Omega_j$  are constants if we assume the conjecture 1 on the degree  $2\ell$ . In order to determine them we consider the homogeneous situation i.e. the Hamiltonian  $H$ . It is not too hard to compute off-diagonal elements of the matrix of  $H$ :  $H_k^j = 2U_{1+|j-k|}(\tau)$ ,  $j \neq k$ , and in particular to conclude that it is a symmetric matrix. Therefore  $\Psi_j$  must be proportional to  $v_j = 1/U_j(\tau)$ . We compute  $\Psi_j(1, \dots, 1) = (-1)^\ell \left(\frac{\ell+2}{2 \sin(\pi/(\ell+2))}\right)^2 \Omega_j / U_j(\tau)^2$ , and using Eq. (3.7) to fix the normalization ( $\Omega_\ell = \Omega = (-1)^\ell$ ), we find  $\Omega_j = (-1)^\ell U_j(\tau)$ .

Note that for  $m > 2$ , Thm. 5 is not sufficient to determine up to a constant the entries  $\Psi_\alpha$ , since they are in general not fully factorizable as products of  $z_j - q^{2k} z_i$ .

### 3.4. Sum rule

A very natural object is the pairing of the left eigenvector and of the right eigenvector: we denote it by  $Z(z_1, \dots, z_{2m}) := \langle 0 | \Psi(z_1, \dots, z_{2m}) \rangle$ .

PROPOSITION 8.  $Z(z_1, \dots, z_{2m})$  is a symmetric function of its arguments.

Proof. Start from  $Z(z_1, \dots, z_{i+1}, z_i, \dots, z_{2m}) = \langle 0 | \Psi(z_1, \dots, z_{i+1}, z_i, \dots, z_{2m}) \rangle$ . Applying Prop. 3, it is equal to  $\langle 0 | R_i(z_{i+1}, z_i) | \Psi(z_1, \dots, z_{2m}) \rangle$ . On the other hand, from Lemma 4,  $\langle 0 | R_i(z_{i+1}, z_i) | \cdot \rangle = v R_i(z_{i+1}, z_i) = v$ . Thus,  $Z(z_1, \dots, z_{i+1}, z_i, \dots, z_{2m}) = Z(z_1, \dots, z_{2m})$ , which proves the proposition.  $\square$

THEOREM 4. Assuming Conjecture 1,  $Z(z_1, \dots, z_{2m})$  is the Schur function  $s_{Y_{\ell, m}}(z_1, \dots, z_{2m})$  associated to the Young diagram  $((m-1)\ell, (m-1)\ell, \dots, 2\ell, 2\ell, \ell, \ell)$ .

Proof. In fact, we really claim that  $s_{Y_{\ell, m}}(z_1, \dots, z_{2m})$  is, up to multiplication by a scalar, the only symmetric polynomial of degree (at most)  $\ell(m-1)$  in each variable, which vanishes when the conditions of Thm. 3 are met. This clearly implies the theorem (up to a multiplicative constant) due to Prop. 8, Prop. 6 and Thm. 3.

First, we show that  $s_{Y_{\ell, m}}$  does satisfy these conditions. It is symmetric by definition, and its degree in each variable is the width of its Young diagram that is  $\ell(m-1)$ . It can be expressed as

$$s_{Y_{\ell, m}}(z_1, \dots, z_{2m}) = \frac{\det_{1 \leq i, j \leq 2m} (z_j^{h_i})}{\prod_{1 \leq i < j \leq 2m} (z_i - z_j)} \quad (3.12)$$

where the  $h_j$  are the shifted lengths of the rows of  $Y_{\ell, m}$ , that is  $h_{2i-1} = (i-1)(\ell+2) \equiv 0 \pmod{\ell+2}$ ,  $h_{2i} = (i-1)(\ell+2) + 1 \equiv 1 \pmod{\ell+2}$ ,  $i = 1, \dots, m$ . Assume now that  $z_2 = q^{2k} z_1$ ,  $z_3 = q^{2k'} z_2$ . Isolate the three first columns of the determinant in the numerator of Eq. (3.12): the odd rows are of the form  $z_1^{h_{2i-1}}(1, 1, 1)$  whereas the even rows are of the form  $z_1^{h_{2i}}(1, q^{2k}, q^{2(k+k')})$ . Thus, we have two series of  $m$  proportional rows: this proves that the  $3 \times 2m$  matrix is of rank 2, and that the full  $2m \times 2m$  matrix is singular. If the  $z$ 's are distinct the denominator of Eq. (3.12) is non-zero and we conclude that  $s_{Y_{\ell, m}}$  vanishes.

Next, we show that it is the only such polynomial by induction. The step  $m = 0$  is trivial.

At step  $m$ , consider a symmetric polynomial  $Z(z_1, \dots, z_{2m})$  in  $2m$  variables, of degree  $\ell(m-1)$  in each variable, which vanishes when the conditions of Thm. 3 are met. Note that since  $Z$  is symmetric, the conditions can be in fact extended to arbitrary distinct integers  $(i, i', i'')$ . Setting  $z_j = q^{2k} z_i$ ,  $1 \leq k \leq \ell+1$ ,  $i \neq j$ , they therefore imply the following factorization:

$$Z|_{z_j = q^{2k} z_i} = \left( \prod_{h \neq i, j} \prod_{\substack{p=1 \\ p \neq k}}^{\ell+1} (z_h - q^{2p} z_i) \right) W(z_1, \dots, \hat{z}_i, \dots, \hat{z}_j, \dots, z_{2m}) \quad (3.13)$$

where  $W$  is a symmetric polynomial of the  $2m-2$  variables  $z_h$ ,  $h \neq i, j$ , of degree  $\ell(m-2)$  in each, which still vanishes when the conditions of Thm. 3 are met.  $W$  does not depend on  $z_i$  because the  $2\ell(m-1)$  prefactors exhaust the degree of  $z_i$  and  $z_j$  combined. The induction hypothesis implies that  $W = \text{const } s_{Y_{\ell, m-1}}(z_1, \dots, \hat{z}_i, \dots, \hat{z}_j, \dots, z_{2m})$ . The constant is independent of  $i$  or  $j$  by symmetry; and of  $k$ , as one can check by taking  $z_i \rightarrow \infty$  (indeed in the limit  $z_i, z_j \rightarrow \infty$ ,  $Z$  must be proportional to  $(z_i z_j)^{\ell(m-1)}$ , which fixes the relative normalization of  $Z|_{z_j=q^{2k}z_i}$  for varying  $k$ ).  $Z$ , as a function of a given  $z_j$ , is thus specified at  $(\ell+1)(2m-1)$  points by Eq. (3.13); this is enough to determine uniquely a polynomial of degree  $\ell(m-1)$ . Therefore  $Z = \text{const } s_{Y_{\ell, m}}(z_1, \dots, z_{2m})$ , which concludes the induction.

Finally, one fixes the constant by another induction using Prop. 7 (Eq. (3.9)).  $\square$

Note the obvious

COROLLARY.  $\langle \Psi | \Psi \rangle = s_{Y_{\ell, m}}^2$ .

A final remark concerns the homogeneous situation where all  $z_i$  are equal. In this case one can evaluate explicitly the Schur function i.e. the dimension of the corresponding  $sl(2m)$  representation:

$$Z(1, \dots, 1) = ((\ell+2)i)^{m(m-1)} \prod_{i,j=1}^m \frac{(\ell+2)(j-i)+1}{j-i+m}. \quad (3.14)$$

$m$ $\ell$	1	2	3	4	5	6
1	1	6	189	30618	25332021	106698472452
2	1	20	6720	36900864	3280676585472	4702058148658151424
3	1	50	103125	8507812500	27783325195312500	3574209022521972656250000
4	1	105	945945	707814508401	43505367274327463505	218541150429748620278689395225
5	1	196	6117748	29406803321896	21520945685492367246132	2385377935975138162776292257847164

**Tab. 1:** First few values of  $Z(1, \dots, 1)$ .



## 4. Conclusion

This paper has tried to demonstrate the power of the methods devised in [1] and subsequent papers by applying it to the case of fused  $A_1$  models. A special point has been found for each such model – which is nothing but the point at which the central charge of the infrared fixed point vanishes. We call this point “combinatorial” because one can hope that the properties it possesses have interesting combinatorial meaning. Some of it have been described in the paper: existence of a left eigenvector with a simple form in the basis that we have built; simple sum rule. However, many questions remain open.

First and foremost, one would like to have a generalized Razumov–Stroganov [3] conjecture for these fused models. In the present case, it would correspond to identifying each component of the ground state eigenvector of the Hamiltonian with the  $\tau$ -enumeration of some combinatorial objects. By  $\tau$ -enumeration we mean that the enumeration should be somehow weighted with  $\tau$  to take into account the fact that the components belong to  $\mathbb{Z}[\tau]$  (in the unfused case they are integers). For example, note that at  $\ell = 2$  we do know an interpretation of the sum of all components: up to a missing factor  $2^m$  (which can be naturally introduced in the normalisation of  $v$ ), it is the 2-enumeration of Quarter-Turn Symmetric Alterating Sign Matrices (QTSASM) [13,14]. The introduction of spectral parameters and the appearance of the Schur function of Thm. 4 also arise in this context. One should explore how this connection can be extended at the level of each component. Note that in the ASM literature, 1-, 2- and 3-enumerations are often considered. In our language, these are really 1-,  $\sqrt{2}$ -,  $\sqrt{3}$ -enumerations, which correspond to  $\ell = 1, 2, 4$ .

Also, many additional properties should be obtainable, along the lines of the abundant literature on the unfused case. For example we propose here the following

CONJECTURE 2. Denote  $\Psi(m) \equiv \Psi(z_1 = \dots = z_{2m} = 1)$ ,  $Z(m) \equiv Z(z_1 = \dots = z_{2m} = 1)$ . Then  $\Psi_0(m)$  is the largest entry of  $|\Psi(m)\rangle$  (where we recall that 0 is the pattern that fully connects  $S_{2i-1}$  and  $S_{2i}$ ), and

$$\frac{\Psi_0(m)}{\Psi_\delta(m)} = \frac{Z(m-1)}{\Psi_\delta(m-1)}$$

In other words, if  $\Psi$  is normalized in such a way that the base link pattern has entry 1, the largest entry at size  $m$  is the (weighted) sum at size  $m-1$ .

Equally interesting is the study of the space of polynomials spanned by the components of the ground state eigenvector and the related representation theory, following the philosophy of [12]. One should emphasize the difficulty of such a task, because it involves separating the action on polynomials from the action on link patterns – even in the case of the Birman–Wenzel–Murakami algebra (BWM) this difficulty appears [4,15], and for us BWM is only the simplest fused case (corresponding to  $\ell = 2$ ).

Closely related is the extension of this work to a generic value of  $q$  by introducing an appropriate quantum Knizhnik–Zamolodchikov ( $q$ KZ) equation. Clearly all arguments of Sect. 3.3 depend only on polynomiality of the ground state eigenvector and on Prop. 3, which is the key equation of the  $q$ KZ system. A natural conjecture is that at  $q$  generic will appear precisely the  $q$ KZ equation at level  $\ell$ , which would be of greater interest than the level 1 (“free boson”)  $q$ KZ of the unfused model.

One should also be able to combine the ideas of [6] and of the present work to study fused higher rank models; it is easy to guess the kind of properties they will possess at the point  $q = -e^{\pm i\pi/(k+\ell)}$ ,  $k$  dual Coxeter number. One could also consider fused models with other boundary conditions (open boundary conditions, etc, as in [7,8]).

Finally, it would be interesting to find some relation between our formulae, and in particular the sum rule, with the recent work [16] which generalizes the domain wall boundary conditions of the six-vertex model (relevant to the sum rule of the unfused loop model) to fused models.

### Acknowledgments

The author thanks P. Di Francesco and J.-B. Zuber for numerous discussions, and acknowledges the support of European networks “ENIGMA” MRT-CT-2004-5652, “ENRAGE” MRTN-CT-2004-005616, and of ANR program “GIMP” ANR-05-BLAN-0029-01.

### Appendix A. Projection operator

Following [17] (see also [10] and references therein), we define recurrently the projectors  $p^{(k)}$  by  $p^{(1)} = 1$  and

$$p^{(k+1)}(e_j, \dots, e_{j+k-1}) = p^{(k)}(e_j, \dots, e_{j+k-2})(1 - \mu_k(\tau)e_{j+k-1})p^{(k)}(e_j, \dots, e_{j+k-2}) \quad (\text{A.1})$$

where  $\mu_k(\tau) = U_{k-1}(\tau)/U_k(\tau)$  and  $U_k$  is the Chebyshev polynomial of the second kind. The projectors used in this paper are simply  $p_i := p^{(\ell)}(e_{\ell(i-1)+1}, \dots, e_{\ell i-1})$ .

By recursion on  $k$  one can prove the following facts:

- (a)  $(p^{(k)}(e_j, \dots, e_{j+k-2})e_{j+k-1})^2 = \mu_k^{-1} p^{(k)}(e_j, \dots, e_{j+k-2})e_{j+k-1}$  and  $p^{(k)2} = p^{(k)}$ .
- (b)  $p^{(k)}$  is  $\star$ -symmetric.
- (c)  $p^{(k)}(e_j, \dots, e_{j+k-2})e_m = e_m p^{(k)}(e_j, \dots, e_{j+k-2}) = 0$  for  $m = j, \dots, j+k-2$ . (use (a) for  $m = j+k-2$ ).
- (d)  $p^{(k)}$  is “left-right symmetric”, that is it also satisfies

$$p^{(k+1)}(e_j, \dots, e_{j+k-1}) = p^{(k)}(e_{j+1}, \dots, e_{j+k-1})(1 - \mu_k(\tau)e_j)p^{(k)}(e_{j+1}, \dots, e_{j+k-1}) \quad (\text{A.2})$$

- (e)  $p^{(k)}p^{(k')} = p^{(k)}p^{(k')} = p^{(k)}$  when  $k \geq k'$  and the arguments of  $p^{(k')}$  are a subset of those of  $p^{(k)}$  (use Eqs. (A.1) and (A.2)).

Note that property (i) of Sect. (2.3) is a direct consequence of (c).

## Appendix B. Enumeration of admissible states

Call  $W_{\ell,m}$  the set of Lukaciewicz words of length  $(\ell+1)m$  taking values in  $\{\ell, -1\}$ , that is

$$W_{\ell,m} = \left\{ w \in \{\ell, -1\}^{(\ell+1)m} : \sum_{i=1}^j w_i \geq 0 \forall j < (\ell+1)m, \sum_{i=1}^{(\ell+1)m} w_i = 0 \right\} \quad (\text{B.1})$$

These words describe rooted planar trees with arity  $\ell+1$ , and it is well-known that

$$\#W_{\ell,m} = \frac{((\ell+1)m)!}{(\ell m + 1)!m!} \quad (\text{B.2})$$

We shall therefore describe a bijection between  $\mathcal{L}'_{\ell,2m}$  and  $W_{\ell,m}$ .

Start from a link pattern  $\alpha$ . As an intermediate step it is convenient to rewrite it as a Dyck word  $w$  (the case  $\ell = 1$  of the Lukaciewicz words above). Considering the link pattern as unfolded in the half-plane, we associate to each vertex where an arch starts (resp. ends) a  $+1$  (resp.  $-1$ ). This is in fact the bijection in the case  $\ell = 1$ . We shall now restrict ourselves to  $\ell$ -admissible link patterns. The goal is to transform the word  $w$  by condensing groups of  $\ell$  “ $+1$ ” into a single “ $\ell$ ”.

We read the word  $w$  from left to right, in sequences of  $\ell$  letters. Since  $\alpha \in \mathcal{L}_{\ell,2m}$ , these sequences can only be  $k$  “ $-1$ ” followed by  $\ell - k$  “ $+1$ ”,  $0 \leq k \leq \ell$ . We distinguish three cases:

- (i)  $k = 0$ : if there are only “ $+1$ ”, replace them with a single “ $\ell$ ”.
- (ii)  $k = \ell$ : if there are only “ $-1$ ”, leave them intact.

(iii)  $0 < k < \ell$ : the  $k$  “ $-1$ ” are left intact. As to the  $\ell - k$  “ $+1$ ”, two situations arise. Either (iiia) they have not been flagged yet, in which case they are replaced with a single “ $\ell$ ”. Say the first  $+1$  of the sequence is at position  $i$ . Find the first position  $j$  for which  $\sum_{p=i+1}^{j-1} w_p < 0$ . According to Lemma 3, we know that  $r(i) + r(j-1) = \ell - 1$ , and that  $w_j$  and all its successors are  $+1$  (there are  $\ell - r(i) = \ell - k$  of them). We flag them. Or (iiib) they have been flagged, in which case we ignore them.

It is easy to show that the resulting word is indeed in  $W_{\ell,m}$ . In particular, the  $\ell$ -admissibility ensures that sequences with  $k$  “ $+1$ ” with  $0 < k < \ell$  always come in pairs, the second one being flagged.

Inversely, start from a word  $w \in W_{\ell,m}$ . Read it from left to right. Each time we come across a “ $\ell$ ” at position  $i$  (all modifications to the left being taken into account in the position), with  $r(i) = k$ , we replace it using the following rule:

- (i)  $k = 0$ : we simply replace it with a sequence of  $\ell$  “ $+1$ ”.
- (ii)  $k > 0$ : we replace it with  $\ell - k$  “ $+1$ ”. Then we look for the first position  $j$  such that  $\sum_{p=i+1}^{j-1} w_p < 0$  (being careful that the sum starts with  $\ell - k - 1$  newly created “ $+1$ ”). We insert  $k$  extra “ $+1$ ” between positions  $j$  and  $j + 1$ .

This will clearly produce a Dyck word, and it not hard to check that the corresponding link pattern is  $\ell$ -admissible. The two operations described above being clearly inverse of each other, we conclude that they are bijections.

EXAMPLE: these are the words associated to  $\mathcal{L}'_{2,6}$ , with the same ordering as in Sect. 2.5:

$$W_{2,3} = \left\{ \begin{array}{ccccccccc} 2 & -1 & -1 & 2 & -1 & -1 & 2 & -1 & -1 \\ 2 & -1 & -1 & 2 & -1 & 2 & -1 & -1 & -1 \\ 2 & -1 & -1 & 2 & 2 & -1 & -1 & -1 & -1 \\ 2 & -1 & 2 & -1 & -1 & -1 & 2 & -1 & -1 \\ 2 & 2 & -1 & -1 & -1 & -1 & 2 & -1 & -1 \\ 2 & -1 & 2 & -1 & -1 & 2 & -1 & -1 & -1 \\ 2 & -1 & 2 & -1 & 2 & -1 & -1 & -1 & -1 \\ 2 & -1 & 2 & 2 & -1 & -1 & -1 & -1 & -1 \\ 2 & 2 & -1 & -1 & -1 & 2 & -1 & -1 & -1 \\ 2 & 2 & -1 & -1 & 2 & -1 & -1 & -1 & -1 \\ 2 & 2 & -1 & 2 & -1 & -1 & -1 & -1 & -1 \\ 2 & 2 & 2 & -1 & -1 & -1 & -1 & -1 & -1 \end{array} \right\}$$

## References

- [1] P. Di Francesco and P. Zinn-Justin, *Around the Razumov–Stroganov conjecture: proof of a multi-parameter sum rule*, *E. J. Combi.* 12 (1) (2005), R6, [math-ph/0410061](#).
- [2] M.T. Batchelor, J. de Gier and B. Nienhuis, *The quantum symmetric XXZ chain at  $\Delta = -1/2$ , alternating sign matrices and plane partitions*, *J. Phys.* A34 (2001) L265–L270, [cond-mat/0101385](#).
- [3] A.V. Razumov and Yu.G. Stroganov, *Combinatorial nature of ground state vector of  $O(1)$  loop model*, *Theor. Math. Phys.* **138** (2004) 333–337; *Teor. Mat. Fiz.* 138 (2004) 395–400, [math.CO/0104216](#).
- [4] P. Di Francesco and P. Zinn-Justin, *Inhomogeneous model of crossing loops and multidegrees of some algebraic varieties*, *Commun. Math. Phys.* 262 (2006), 459–487, [math-ph/0412031](#).
- [5] A. Knutson and P. Zinn-Justin, *A scheme related to the Brauer loop model*, [math.AG/0503224](#).
- [6] P. Di Francesco and P. Zinn-Justin, *Quantum Knizhnik–Zamolodchikov equation, generalized Razumov–Stroganov sum rules and extended Joseph polynomials*, *J. Phys. A* 38 (2005) L815–L822, [math-ph/0508059](#).
- [7] P. Di Francesco, *Inhomogeneous loop models with open boundaries*, *J. Phys. A* 38 (27) (2005), 6091–6120, [math-ph/0504032](#); *Boundary  $q$ KZ equation and generalized Razumov–Stroganov sum rules for open IRF models*, *J. Stat. Mech.* (2005) P11003, [math-ph/0509011](#).
- [8] P. Di Francesco and P. Zinn-Justin, *From Orbital Varieties to Alternating Sign Matrices*, extended abstract for FPSAC’06, [math-ph/0512047](#).
- [9] P. Di Francesco, O. Golinelli and E. Guitter, *Meanders and the Temperley–Lieb algebra*, *Commun. Math. Phys.* 186 (1997), 1–59, [hep-th/9602025](#).
- [10] W.M. Koo and H. Saleur, *Fused Potts models*, [hep-th/930311](#).
- [11] M. Khovanov, *Graphical calculus, canonical bases and Kazhdan-Lusztig theory*, PhD dissertation (1997).
- [12] V. Pasquier, *Quantum incompressibility and Razumov Stroganov type conjectures*, [cond-mat/0506075](#).
- [13] G. Kuperberg, *Symmetry classes of alternating-sign matrices under one roof*, *Ann. of Math.* (2) 156 (2002), no. 3, 835–866, [math.CO/0008184](#).
- [14] S. Okada, *Enumeration of Symmetry Classes of Alternating Sign Matrices and Characters of Classical Groups*, [math.CO/0408234](#).
- [15] V. Pasquier, *Incompressible representations of the Birman-Wenzl-Murakami algebra*, [math.QA/0507364](#).
- [16] A. Caradoc, O. Foda, N. Kitanine, *Higher spin vertex models with domain wall boundary conditions*, [math-ph/0601061](#).
- [17] P. Martin, *Potts model and related problems in statistical mechanics*, World Scientific (1991).