

Large N Field Theories, String Theory and Gravity

Ofer Aharony,¹ Steven S. Gubser,² Juan Maldacena,^{2,3}

Hiroshi Ooguri,^{4,5} and Yaron Oz⁶

¹ Department of Physics and Astronomy, Rutgers University,
Piscataway, NJ 08855-0849, USA

² Lyman Laboratory of Physics, Harvard University, Cambridge, MA 02138, USA

³ School of Natural Sciences, Institute for Advanced Study, Princeton, NJ 08540

⁴ Department of Physics, University of California, Berkeley, CA 94720-7300, USA

⁵ Lawrence Berkeley National Laboratory, MS 50A-5101, Berkeley, CA 94720, USA

⁶ Theory Division, CERN, CH-1211, Geneva 23, Switzerland

oferah@physics.rutgers.edu, ssgubser@bohr.harvard.edu,
malda@pauli.harvard.edu, hooguri@lbl.gov, yaron.oz@cern.ch

Abstract

We review the holographic correspondence between field theories and string/M theory, focusing on the relation between compactifications of string/M theory on Anti-de Sitter spaces and conformal field theories. We review the background for this correspondence and discuss its motivations and the evidence for its correctness. We describe the main results that have been derived from the correspondence in the regime that the field theory is approximated by classical or semiclassical gravity. We focus on the case of the $\mathcal{N} = 4$ supersymmetric gauge theory in four dimensions, but we discuss also field theories in other dimensions, conformal and non-conformal, with or without supersymmetry, and in particular the relation to QCD. We also discuss some implications for black hole physics.

(To be published in Physics Reports)

Contents

1	Introduction	4
1.1	General Introduction and Overview	4
1.2	Large N Gauge Theories as String Theories	10
1.3	Black p -Branes	16
1.3.1	Classical Solutions	16
1.3.2	D-Branes	20
1.3.3	Greybody Factors and Black Holes	21
2	Conformal Field Theories and AdS Spaces	30
2.1	Conformal Field Theories	30
2.1.1	The Conformal Group and Algebra	31
2.1.2	Primary Fields, Correlation Functions, and Operator Product Expansions	32
2.1.3	Superconformal Algebras and Field Theories	34
2.2	Anti-de Sitter Space	36
2.2.1	Geometry of Anti-de Sitter Space	36
2.2.2	Particles and Fields in Anti-de Sitter Space	45
2.2.3	Supersymmetry in Anti-de Sitter Space	47
2.2.4	Gauged Supergravities and Kaluza-Klein Compactifications	48
2.2.5	Consistent Truncation of Kaluza-Klein Compactifications	52
3	AdS/CFT Correspondence	55
3.1	The Correspondence	55
3.1.1	Brane Probes and Multicenter Solutions	61
3.1.2	The Field \leftrightarrow Operator Correspondence	62
3.1.3	Holography	65
3.2	Tests of the AdS/CFT Correspondence	68

3.2.1	The Spectrum of Chiral Primary Operators	70
3.2.2	Matching of Correlation Functions and Anomalies	78
3.3	Correlation Functions	80
3.3.1	Two-point Functions	82
3.3.2	Three-point Functions	85
3.3.3	Four-point Functions	89
3.4	Isomorphism of Hilbert Spaces	90
3.4.1	Hilbert Space of String Theory	91
3.4.2	Hilbert Space of Conformal Field Theory	96
3.5	Wilson Loops	98
3.5.1	Wilson Loops and Minimum Surfaces	98
3.5.2	Other Branes Ending on the Boundary	103
3.6	Theories at Finite Temperature	104
3.6.1	Construction	104
3.6.2	Thermal Phase Transition	107
4	More on the Correspondence	111
4.1	Other AdS_5 Backgrounds	111
4.1.1	Orbifolds of $AdS_5 \times S^5$	113
4.1.2	Orientifolds of $AdS_5 \times S^5$	118
4.1.3	Conifold theories	121
4.2	D-Branes in AdS, Baryons and Instantons	129
4.3	Deformations of the Conformal Field Theory	134
4.3.1	Deformations in the AdS/CFT Correspondence	135
4.3.2	A c-theorem	137
4.3.3	Deformations of the $\mathcal{N} = 4$ $SU(N)$ SYM Theory	138
4.3.4	Deformations of String Theory on $AdS_5 \times S^5$	144
5	AdS_3	150
5.1	The Virasoro Algebra	150
5.2	The BTZ Black Hole	152
5.3	Type IIB String Theory on $AdS_3 \times S^3 \times M^4$	155
5.3.1	The Conformal Field Theory	155
5.3.2	Black Holes Revisited	159
5.3.3	Matching of Chiral-Chiral Primaries	162
5.3.4	Calculation of the Elliptic Genus in Supergravity	167

5.4	Other AdS_3 Compactifications	168
5.5	Pure Gravity	171
5.6	Greybody Factors	172
5.7	Black Holes in Five Dimensions	178
6	Other AdS Spaces and Non-Conformal Theories	180
6.1	Other Branes	180
6.1.1	M5 Branes	180
6.1.2	M2 Branes	184
6.1.3	Dp Branes	187
6.1.4	NS5 Branes	192
6.2	QCD	194
6.2.1	QCD ₃	195
6.2.2	QCD ₄	204
6.2.3	Other Directions	218
7	Summary and Discussion	223

Chapter 1

Introduction

1.1 General Introduction and Overview

The microscopic description of nature as presently understood and verified by experiment involves quantum field theories. All particles are excitations of some field. These particles are pointlike and they interact locally with other particles. Even though quantum field theories describe nature at the distance scales we observe, there are strong indications that new elements will be involved at very short distances (or very high energies), distances of the order of the Planck scale. The reason is that at those distances (or energies) quantum gravity effects become important. It has not been possible to quantize gravity following the usual perturbative methods. Nevertheless, one can incorporate quantum gravity in a consistent quantum theory by giving up the notion that particles are pointlike and assuming that the fundamental objects in the theory are strings, namely one-dimensional extended objects [1, 2]. These strings can oscillate, and there is a spectrum of energies, or masses, for these oscillating strings. The oscillating strings look like localized, particle-like excitations to a low energy observer. So, a single oscillating string can effectively give rise to many types of particles, depending on its state of oscillation. All string theories include a particle with zero mass and spin two. Strings can interact by splitting and joining interactions. The only consistent interaction for massless spin two particles is that of gravity. Therefore, any string theory will contain gravity. The structure of string theory is highly constrained. String theories do not make sense in an arbitrary number of dimensions or on any arbitrary geometry. Flat space string theory exists (at least in perturbation theory) only in ten dimensions. Actually, 10-dimensional string theory is described by a string which also has fermionic excitations and gives rise to a supersymmetric theory.¹ String theory is then a candidate for a quantum theory of gravity. One can get down to four

¹One could consider a string with no fermionic excitations, the so called “bosonic” string. It lives in 26 dimensions and contains tachyons, signaling an instability of the theory.

dimensions by considering string theory on $\mathbb{R}^4 \times M_6$ where M_6 is some six dimensional compact manifold. Then, low energy interactions are determined by the geometry of M_6 .

Even though this is the motivation usually given for string theory nowadays, it is not how string theory was originally discovered. String theory was discovered in an attempt to describe the large number of mesons and hadrons that were experimentally discovered in the 1960's. The idea was to view all these particles as different oscillation modes of a string. The string idea described well some features of the hadron spectrum. For example, the mass of the lightest hadron with a given spin obeys a relation like $m^2 \sim T J^2 + \text{const}$. This is explained simply by assuming that the mass and angular momentum come from a rotating, relativistic string of tension T . It was later discovered that hadrons and mesons are actually made of quarks and that they are described by QCD.

QCD is a gauge theory based on the group $SU(3)$. This is sometimes stated by saying that quarks have three colors. QCD is asymptotically free, meaning that the effective coupling constant decreases as the energy increases. At low energies QCD becomes strongly coupled and it is not easy to perform calculations. One possible approach is to use numerical simulations on the lattice. This is at present the best available tool to do calculations in QCD at low energies. It was suggested by 't Hooft that the theory might simplify when the number of colors N is large [3]. The hope was that one could solve exactly the theory with $N = \infty$, and then one could do an expansion in $1/N = 1/3$. Furthermore, as explained in the next section, the diagrammatic expansion of the field theory suggests that the large N theory is a free string theory and that the string coupling constant is $1/N$. If the case with $N = 3$ is similar to the case with $N = \infty$ then this explains why the string model gave the correct relation between the mass and the angular momentum. In this way the large N limit connects gauge theories with string theories. The 't Hooft argument, reviewed below, is very general, so it suggests that different kinds of gauge theories will correspond to different string theories. In this review we will study this correspondence between string theories and the large N limit of field theories. We will see that the strings arising in the large N limit of field theories are the same as the strings describing quantum gravity. Namely, string theory in some backgrounds, including quantum gravity, is equivalent (dual) to a field theory.

We said above that strings are not consistent in four flat dimensions. Indeed, if one wants to quantize a four dimensional string theory an anomaly appears that forces the introduction of an extra field, sometimes called the “Liouville” field [4]. This field on the string worldsheet may be interpreted as an extra dimension, so that the strings effectively move in five dimensions. One might qualitatively think of this new field as the “thickness” of the string. If this is the case, why do we say that the string moves

in five dimensions? The reason is that, like any string theory, this theory will contain gravity, and the gravitational theory will live in as many dimensions as the number of fields we have on the string. It is crucial then that the five dimensional geometry is curved, so that it can correspond to a four dimensional field theory, as described in detail below.

The argument that gauge theories are related to string theories in the large N limit is very general and is valid for basically any gauge theory. In particular we could consider a gauge theory where the coupling does not run (as a function of the energy scale). Then, the theory is conformally invariant. It is quite hard to find quantum field theories that are conformally invariant. In supersymmetric theories it is sometimes possible to prove exact conformal invariance. A simple example, which will be the main example in this review, is the supersymmetric $SU(N)$ (or $U(N)$) gauge theory in four dimensions with four spinor supercharges ($\mathcal{N} = 4$). Four is the maximal possible number of supercharges for a field theory in four dimensions. Besides the gauge fields (gluons) this theory contains also four fermions and six scalar fields in the adjoint representation of the gauge group. The Lagrangian of such theories is completely determined by supersymmetry. There is a global $SU(4)$ R -symmetry that rotates the six scalar fields and the four fermions. The conformal group in four dimensions is $SO(4, 2)$, including the usual Poincaré transformations as well as scale transformations and special conformal transformations (which include the inversion symmetry $x^\mu \rightarrow x^\mu/x^2$). These symmetries of the field theory should be reflected in the dual string theory. The simplest way for this to happen is if the five dimensional geometry has these symmetries. Locally there is only one space with $SO(4, 2)$ isometries: five dimensional Anti-de-Sitter space, or AdS_5 . Anti-de Sitter space is the maximally symmetric solution of Einstein's equations with a negative cosmological constant. In this supersymmetric case we expect the strings to also be supersymmetric. We said that superstrings move in ten dimensions. Now that we have added one more dimension it is not surprising any more to add five more to get to a ten dimensional space. Since the gauge theory has an $SU(4) \simeq SO(6)$ global symmetry it is rather natural that the extra five dimensional space should be a five sphere, S^5 . So, we conclude that $\mathcal{N} = 4$ $U(N)$ Yang-Mills theory could be the same as ten dimensional superstring theory on $AdS_5 \times S^5$ [5]. Here we have presented a very heuristic argument for this equivalence; later we will be more precise and give more evidence for this correspondence.

The relationship we described between gauge theories and string theory on Anti-de-Sitter spaces was motivated by studies of D-branes and black holes in strings theory. D-branes are solitons in string theory [6]. They come in various dimensionalities. If they have zero spatial dimensions they are like ordinary localized, particle-type soliton solutions, analogous to the 't Hooft-Polyakov [7, 8] monopole in gauge theories. These are called D-zero-branes. If they have one extended dimension they are called D-one-

branes or D-strings. They are much heavier than ordinary fundamental strings when the string coupling is small. In fact, the tension of all D-branes is proportional to $1/g_s$, where g_s is the string coupling constant. D-branes are defined in string perturbation theory in a very simple way: they are surfaces where open strings can end. These open strings have some massless modes, which describe the oscillations of the branes, a gauge field living on the brane, and their fermionic partners. If we have N coincident branes the open strings can start and end on different branes, so they carry two indices that run from one to N . This in turn implies that the low energy dynamics is described by a $U(N)$ gauge theory. D- p -branes are charged under $p + 1$ -form gauge potentials, in the same way that a 0-brane (particle) can be charged under a one-form gauge potential (as in electromagnetism). These $p + 1$ -form gauge potentials have $p + 2$ -form field strengths, and they are part of the massless closed string modes, which belong to the supergravity (SUGRA) multiplet containing the massless fields in flat space string theory (before we put in any D-branes). If we now add D-branes they generate a flux of the corresponding field strength, and this flux in turn contributes to the stress energy tensor so the geometry becomes curved. Indeed it is possible to find solutions of the supergravity equations carrying these fluxes. Supergravity is the low-energy limit of string theory, and it is believed that these solutions may be extended to solutions of the full string theory. These solutions are very similar to extremal charged black hole solutions in general relativity, except that in this case they are black branes with p extended spatial dimensions. Like black holes they contain event horizons.

If we consider a set of N coincident D-3-branes the near horizon geometry turns out to be $AdS_5 \times S^5$. On the other hand, the low energy dynamics on their worldvolume is governed by a $U(N)$ gauge theory with $\mathcal{N} = 4$ supersymmetry [9]. These two pictures of D-branes are perturbatively valid for different regimes in the space of possible coupling constants. Perturbative field theory is valid when $g_s N$ is small, while the low-energy gravitational description is perturbatively valid when the radius of curvature is much larger than the string scale, which turns out to imply that $g_s N$ should be very large. As an object is brought closer and closer to the black brane horizon its energy measured by an outside observer is redshifted, due to the large gravitational potential, and the energy seems to be very small. On the other hand low energy excitations on the branes are governed by the Yang-Mills theory. So, it becomes natural to conjecture that Yang-Mills theory at strong coupling is describing the near horizon region of the black brane, whose geometry is $AdS_5 \times S^5$. The first indications that this is the case came from calculations of low energy graviton absorption cross sections [10, 11, 12]. It was noticed there that the calculation done using gravity and the calculation done using super Yang-Mills theory agreed. These calculations, in turn, were inspired by similar calculations for coincident D1-D5 branes. In this case the near horizon geometry involves $AdS_3 \times S^3$ and the low energy field theory living on the D-branes

is a 1+1 dimensional conformal field theory. In this D1-D5 case there were numerous calculations that agreed between the field theory and gravity. First black hole entropy for extremal black holes was calculated in terms of the field theory in [13], and then agreement was shown for near extremal black holes [14, 15] and for absorption cross sections [16, 17, 18]. More generally, we will see that correlation functions in the gauge theory can be calculated using the string theory (or gravity for large $g_s N$) description, by considering the propagation of particles between different points in the boundary of AdS , the points where operators are inserted [19, 20].

Supergravities on AdS spaces were studied very extensively, see [21, 22] for reviews. See also [23, 24] for earlier hints of the correspondence.

One of the main points of this review will be that the strings coming from gauge theories are very much like the ordinary superstrings that have been studied during the last 20 years. The only particular feature is that they are moving on a curved geometry (anti-de Sitter space) which has a boundary at spatial infinity. The boundary is at an infinite spatial distance, but a light ray can go to the boundary and come back in finite time. Massive particles can never get to the boundary. The radius of curvature of Anti-de Sitter space depends on N so that large N corresponds to a large radius of curvature. Thus, by taking N to be large we can make the curvature as small as we want. The theory in AdS includes gravity, since any string theory includes gravity. So in the end we claim that there is an equivalence between a gravitational theory and a field theory. However, the mapping between the gravitational and field theory degrees of freedom is quite non-trivial since the field theory lives in a lower dimension. In some sense the field theory (or at least the set of local observables in the field theory) lives on the boundary of spacetime. One could argue that in general any quantum gravity theory in AdS defines a conformal field theory (CFT) “on the boundary”. In some sense the situation is similar to the correspondence between three dimensional Chern-Simons theory and a WZW model on the boundary [25]. This is a topological theory in three dimensions that induces a normal (non-topological) field theory on the boundary. A theory which includes gravity is in some sense topological since one is integrating over all metrics and therefore the theory does not depend on the metric. Similarly, in a quantum gravity theory we do not have any local observables. Notice that when we say that the theory includes “gravity on AdS ” we are considering any finite energy excitation, even black holes in AdS . So this is really a sum over all spacetimes that are asymptotic to AdS at the boundary. This is analogous to the usual flat space discussion of quantum gravity, where asymptotic flatness is required, but the spacetime could have any topology as long as it is asymptotically flat. The asymptotically AdS case as well as the asymptotically flat cases are special in the sense that one can choose a natural time and an associated Hamiltonian to define the quantum theory. Since black holes might be present this time coordinate is not necessarily globally well-defined, but it is

certainly well-defined at infinity. If we assume that the conjecture we made above is valid, then the $U(N)$ Yang-Mills theory gives a non-perturbative definition of string theory on AdS . And, by taking the limit $N \rightarrow \infty$, we can extract the (ten dimensional string theory) flat space physics, a procedure which is in principle (but not in detail) similar to the one used in matrix theory [26].

The fact that the field theory lives in a lower dimensional space blends in perfectly with some previous speculations about quantum gravity. It was suggested [27, 28] that quantum gravity theories should be holographic, in the sense that physics in some region can be described by a theory at the boundary with no more than one degree of freedom per Planck area. This “holographic” principle comes from thinking about the Bekenstein bound which states that the maximum amount of entropy in some region is given by the area of the region in Planck units [29]. The reason for this bound is that otherwise black hole formation could violate the second law of thermodynamics. We will see that the correspondence between field theories and string theory on AdS space (including gravity) is a concrete realization of this holographic principle.

The review is organized as follows.

In the rest of the introductory chapter, we present background material. In section 1.2, we present the 't Hooft large N limit and its indication that gauge theories may be dual to string theories. In section 1.3, we review the p -brane supergravity solutions. We discuss D-branes, their worldvolume theory and their relation to the p-branes. We discuss greybody factors and their calculation for black holes built out of D-branes.

In chapter 2, we review conformal field theories and AdS spaces. In section 2.1, we give a brief description of conformal field theories. In section 2.2, we summarize the geometry of AdS spaces and gauged supergravities.

In chapter 3, we “derive” the correspondence between supersymmetric Yang Mills theory and string theory on $AdS_5 \times S^5$ from the physics of D3-branes in string theory. We define, in section 3.1, the correspondence between fields in the string theory and operators of the conformal field theory and the prescription for the computation of correlation functions. We also point out that the correspondence gives an explicit holographic description of gravity. In section 3.2, we review the direct tests of the duality, including matching the spectrum of chiral primary operators and some correlation functions and anomalies. Computation of correlation functions is reviewed in section 3.3. The isomorphism of the Hilbert spaces of string theory on AdS spaces and of CFTs is described in section 3.4. We describe how to introduce Wilson loop operators in section 3.5. In section 3.6, we analyze finite temperature theories and the thermal phase transition.

In chapter 4, we review other topics involving AdS_5 . In section 4.1, we consider some other gauge theories that arise from D-branes at orbifolds, orientifolds, or conifold points. In section 4.2, we review how baryons and instantons arise in the string theory

description. In section 4.3, we study some deformations of the CFT and how they arise in the string theory description.

In chapter 5, we describe a similar correspondence involving 1+1 dimensional CFTs and AdS_3 spaces. We also describe the relation of these results to black holes in five dimensions.

In chapter 6, we consider other examples of the AdS/CFT correspondence as well as non conformal and non supersymmetric cases. In section 6.1, we analyse the M2 and M5 branes theories, and go on to describe situations that are not conformal, realized on the worldvolume of various Dp-branes, and the “little string theories” on the worldvolume of NS 5-branes. In section 6.2, we describe an approach to studying theories that are confining and have a behavior similar to QCD in three and four dimensions. We discuss confinement, θ -vacua, the mass spectrum and other dynamical aspects of these theories.

Finally, the last chapter is devoted to a summary and discussion.

Other reviews of this subject are [30, 31, 32, 33].

1.2 Large N Gauge Theories as String Theories

The relation between gauge theories and string theories has been an interesting topic of research for over three decades. String theory was originally developed as a theory for the strong interactions, due to various string-like aspects of the strong interactions, such as confinement and Regge behavior. It was later realized that there is another description of the strong interactions, in terms of an $SU(3)$ gauge theory (QCD), which is consistent with all experimental data to date. However, while the gauge theory description is very useful for studying the high-energy behavior of the strong interactions, it is very difficult to use it to study low-energy issues such as confinement and chiral symmetry breaking (the only current method for addressing these issues in the full non-Abelian gauge theory is by numerical simulations). In the last few years many examples of the phenomenon generally known as “duality” have been discovered, in which a single theory has (at least) two different descriptions, such that when one description is weakly coupled the other is strongly coupled and vice versa (examples of this phenomenon in two dimensional field theories have been known for many years). One could hope that a similar phenomenon would apply in the theory of the strong interactions, and that a “dual” description of QCD exists which would be more appropriate for studying the low-energy regime where the gauge theory description is strongly coupled.

There are several indications that this “dual” description could be a string theory. QCD has in it string-like objects which are the flux tubes or Wilson lines. If

we try to separate a quark from an anti-quark, a flux tube forms between them (if ψ is a quark field, the operator $\bar{\psi}(0)\psi(x)$ is not gauge-invariant but the operator $\bar{\psi}(0)P \exp(i \int_0^x A_\mu dx^\mu)\psi(x)$ is gauge-invariant). In many ways these flux tubes behave like strings, and there have been many attempts to write down a string theory describing the strong interactions in which the flux tubes are the basic objects. It is clear that such a stringy description would have many desirable phenomenological attributes since, after all, this is how string theory was originally discovered. The most direct indication from the gauge theory that it could be described in terms of a string theory comes from the 't Hooft large N limit [3], which we will now describe in detail.

Yang-Mills (YM) theories in four dimensions have no dimensionless parameters, since the gauge coupling is dimensionally transmuted into the QCD scale Λ_{QCD} (which is the only mass scale in these theories). Thus, there is no obvious perturbation expansion that can be performed to learn about the physics near the scale Λ_{QCD} . However, an additional parameter of $SU(N)$ gauge theories is the integer number N , and one may hope that the gauge theories may simplify at large N (despite the larger number of degrees of freedom), and have a perturbation expansion in terms of the parameter $1/N$. This turns out to be true, as shown by 't Hooft based on the following analysis (reviews of large N QCD may be found in [34, 35]).

First, we need to understand how to scale the coupling g_{YM} as we take $N \rightarrow \infty$. In an asymptotically free theory, like pure YM theory, it is natural to scale g_{YM} so that Λ_{QCD} remains constant in the large N limit. The beta function equation for pure $SU(N)$ YM theory is

$$\mu \frac{dg_{YM}}{d\mu} = -\frac{11}{3}N \frac{g_{YM}^3}{16\pi^2} + \mathcal{O}(g_{YM}^5), \quad (1.1)$$

so the leading terms are of the same order for large N if we take $N \rightarrow \infty$ while keeping $\lambda \equiv g_{YM}^2 N$ fixed (one can show that the higher order terms are also of the same order in this limit). This is known as the *'t Hooft limit*. The same behavior is valid if we include also matter fields (fermions or scalars) in the adjoint representation, as long as the theory is still asymptotically free. If the theory is conformal, such as the $\mathcal{N} = 4$ SYM theory which we will discuss in detail below, it is not obvious that the limit of constant λ is the only one that makes sense, and indeed we will see that other limits, in which $\lambda \rightarrow \infty$, are also possible. However, the limit of constant λ is still a particularly interesting limit and we will focus on it in the remainder of this chapter.

Instead of focusing just on the YM theory, let us describe a general theory which has some fields Φ_i^a , where a is an index in the adjoint representation of $SU(N)$, and i is some label of the field (a spin index, a flavor index, etc.). Some of these fields can be ghost fields (as will be the case in gauge theory). We will assume that as in the YM theory (and in the $\mathcal{N} = 4$ SYM theory), the 3-point vertices of all these fields are proportional to g_{YM} , and the 4-point functions to g_{YM}^2 , so the Lagrangian is of the

schematic form

$$\mathcal{L} \sim \text{Tr}(d\Phi_i d\Phi_i) + g_{YM} c^{ijk} \text{Tr}(\Phi_i \Phi_j \Phi_k) + g_{YM}^2 d^{ijkl} \text{Tr}(\Phi_i \Phi_j \Phi_k \Phi_l), \quad (1.2)$$

for some constants c^{ijk} and d^{ijkl} (where we have assumed that the interactions are $SU(N)$ -invariant; mass terms can also be added and do not change the analysis). Rescaling the fields by $\tilde{\Phi}_i \equiv g_{YM} \Phi_i$, the Lagrangian becomes

$$\mathcal{L} \sim \frac{1}{g_{YM}^2} \left[\text{Tr}(d\tilde{\Phi}_i d\tilde{\Phi}_i) + c^{ijk} \text{Tr}(\tilde{\Phi}_i \tilde{\Phi}_j \tilde{\Phi}_k) + d^{ijkl} \text{Tr}(\tilde{\Phi}_i \tilde{\Phi}_j \tilde{\Phi}_k \tilde{\Phi}_l) \right], \quad (1.3)$$

with a coefficient of $1/g_{YM}^2 = N/\lambda$ in front of the whole Lagrangian.

Now, we can ask what happens to correlation functions in the limit of large N with constant λ . Naively, this is a classical limit since the coefficient in front of the Lagrangian diverges, but in fact this is not true since the number of components in the fields also goes to infinity in this limit. We can write the Feynman diagrams of the theory (1.3) in a double line notation, in which an adjoint field Φ^a is represented as a direct product of a fundamental and an anti-fundamental field, Φ_j^i , as in figure 1.1. The interaction vertices we wrote are all consistent with this sort of notation. The propagators are also consistent with it in a $U(N)$ theory; in an $SU(N)$ theory there is a small mixing term

$$\langle \Phi_j^i \Phi_l^k \rangle \propto (\delta_l^i \delta_k^j - \frac{1}{N} \delta_j^i \delta_l^k), \quad (1.4)$$

which makes the expansion slightly more complicated, but this involves only subleading terms in the large N limit so we will neglect this difference here. Ignoring the second term the propagator for the adjoint field is (in terms of the index structure) like that of a fundamental-anti-fundamental pair. Thus, any Feynman diagram of adjoint fields may be viewed as a network of double lines. Let us begin by analyzing vacuum diagrams (the generalization to adding external fields is simple and will be discussed below). In such a diagram we can view these double lines as forming the edges in a simplicial decomposition (for example, it could be a triangulation) of a surface, if we view each single-line loop as the perimeter of a face of the simplicial decomposition. The resulting surface will be oriented since the lines have an orientation (in one direction for a fundamental index and in the opposite direction for an anti-fundamental index). When we compactify space by adding a point at infinity, each diagram thus corresponds to a compact, closed, oriented surface.

What is the power of N and λ associated with such a diagram? From the form of (1.3) it is clear that each vertex carries a coefficient proportional to N/λ , while propagators are proportional to λ/N . Additional powers of N come from the sum over the indices in the loops, which gives a factor of N for each loop in the diagram (since each index has N possible values). Thus, we find that a diagram with V vertices, E

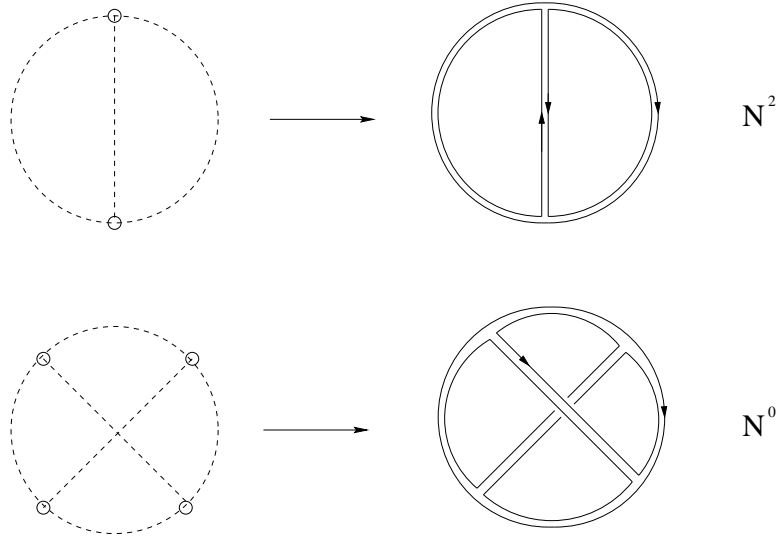

Figure 1.1: Some diagrams in a field theory with adjoint fields in the standard representation (on the left) and in the double line representation (on the right). The dashed lines are propagators for the adjoint fields, the small circles represent interaction vertices, and solid lines carry indices in the fundamental representation.

propagators (= edges in the simplicial decomposition) and F loops (= faces in the simplicial decomposition) comes with a coefficient proportional to

$$N^{V-E+F} \lambda^{E-V} = N^\chi \lambda^{E-V}, \quad (1.5)$$

where $\chi \equiv V - E + F$ is the Euler character of the surface corresponding to the diagram. For closed oriented surfaces, $\chi = 2 - 2g$ where g is the genus (the number of handles) of the surface.² Thus, the perturbative expansion of any diagram in the field theory may be written as a double expansion of the form

$$\sum_{g=0}^{\infty} N^{2-2g} \sum_{i=0}^{\infty} c_{g,i} \lambda^i = \sum_{g=0}^{\infty} N^{2-2g} f_g(\lambda), \quad (1.6)$$

where f_g is some polynomial in λ (in an asymptotically free theory the λ -dependence will turn into some Λ_{QCD} -dependence but the general form is similar; infrared divergences could also lead to the appearance of terms which are not integer powers of λ). In the large N limit we see that any computation will be dominated by the surfaces of maximal χ or minimal genus, which are surfaces with the topology of a sphere (or

²We are discussing here only connected diagrams, for disconnected diagrams we have similar contributions from each connected component.

equivalently a plane). All these *planar diagrams* will give a contribution of order N^2 , while all other diagrams will be suppressed by powers of $1/N^2$. For example, the first diagram in figure 1.1 is planar and proportional to $N^{2-3+3} = N^2$, while the second one is not and is proportional to $N^{4-6+2} = N^0$. We presented our analysis for a general theory, but in particular it is true for any gauge theory coupled to adjoint matter fields, like the $\mathcal{N} = 4$ SYM theory. The rest of our discussion will be limited mostly to gauge theories, where only gauge-invariant ($SU(N)$ -invariant) objects are usually of interest.

The form of the expansion (1.6) is the same as one finds in a perturbative theory with closed oriented strings, if we identify $1/N$ as the string coupling constant³. Of course, we do not really see any strings in the expansion, but just diagrams with holes in them; however, one can hope that in a full non-perturbative description of the field theory the holes will “close” and the surfaces of the Feynman diagrams will become actual closed surfaces. The analogy of (1.6) with perturbative string theory is one of the strongest motivations for believing that field theories and string theories are related, and it suggests that this relation would be more visible in the large N limit where the dual string theory may be weakly coupled. However, since the analysis was based on perturbation theory which generally does not converge, it is far from a rigorous derivation of such a relation, but rather an indication that it might apply, at least for some field theories (there are certainly also effects like instantons which are non-perturbative in the $1/N$ expansion, and an exact matching with string theory would require a matching of such effects with non-perturbative effects in string theory).

The fact that $1/N$ behaves as a coupling constant in the large N limit can also be seen directly in the field theory analysis of the ’t Hooft limit. While we have derived the behavior (1.6) only for vacuum diagrams, it actually holds for any correlation function of a product of gauge-invariant fields $\langle \prod_{j=1}^n G_j \rangle$ such that each G_j cannot be written as a product of two gauge-invariant fields (for instance, G_j can be of the form $\frac{1}{N} \text{Tr}(\prod_i \Phi_i)$). We can study such a correlation function by adding to the action $S \rightarrow S + N \sum g_j G_j$, and then, if W is the sum of connected vacuum diagrams we discussed above (but now computed with the new action),

$$\left\langle \prod_{j=1}^n G_j \right\rangle = (iN)^{-n} \left[\frac{\partial^n W}{\prod_{j=1}^n \partial g_j} \right]_{g_j=0}. \quad (1.7)$$

Our analysis of the vacuum diagrams above holds also for these diagrams, since we put in additional vertices with a factor of N , and, in the double line representation, each of the operators we inserted becomes a vertex of the simplicial decomposition of the surface (this would not be true for operators which are themselves products,

³In the conformal case, where λ is a free parameter, there is actually a freedom of choosing the string coupling constant to be $1/N$ times any function of λ without changing the form of the expansion, and this will be used below.

and which would correspond to more than one vertex). Thus, the leading contribution to $\langle \prod_{j=1}^n G_j \rangle$ will come from planar diagrams with n additional operator insertions, leading to

$$\left\langle \prod_{j=1}^n G_j \right\rangle \propto N^{2-n} \quad (1.8)$$

in the 't Hooft limit. We see that (in terms of powers of N) the 2-point functions of the G_j 's come out to be canonically normalized, while 3-point functions are proportional to $1/N$, so indeed $1/N$ is the coupling constant in this limit (higher genus diagrams do not affect this conclusion since they just add higher order terms in $1/N$). In the string theory analogy the operators G_j would become vertex operators inserted on the string world-sheet. For asymptotically free confining theories (like QCD) one can show that in the large N limit they have an infinite spectrum of stable particles with rising masses (as expected in a free string theory). Many additional properties of the large N limit are discussed in [36, 34] and other references.

The analysis we did of the 't Hooft limit for $SU(N)$ theories with adjoint fields can easily be generalized to other cases. Matter in the fundamental representation appears as single-line propagators in the diagrams, which correspond to boundaries of the corresponding surfaces. Thus, if we have such matter we need to sum also over surfaces with boundaries, as in open string theories. For $SO(N)$ or $USp(N)$ gauge theories we can represent the adjoint representation as a product of two fundamental representations (instead of a fundamental and an anti-fundamental representation), and the fundamental representation is real, so no arrows appear on the propagators in the diagram, and the resulting surfaces may be non-orientable. Thus, these theories seem to be related to non-orientable string theories [37]. We will not discuss these cases in detail here, some of the relevant aspects will be discussed in section 4.1.2 below.

Our analysis thus far indicates that gauge theories may be dual to string theories with a coupling proportional to $1/N$ in the 't Hooft limit, but it gives no indication as to precisely which string theory is dual to a particular gauge theory. For two dimensional gauge theories much progress has been made in formulating the appropriate string theories [38, 39, 40, 41, 42, 43, 44, 45], but for four dimensional gauge theories there was no concrete construction of a corresponding string theory before the results reported below, since the planar diagram expansion (which corresponds to the free string theory) is very complicated. Various direct approaches towards constructing the relevant string theory were attempted, many of which were based on the loop equations [46] for the Wilson loop observables in the field theory, which are directly connected to a string-type description.

Attempts to directly construct a string theory equivalent to a four dimensional gauge theory are plagued with the well-known problems of string theory in four dimensions (or generally below the critical dimension). In particular, additional fields must be

added on the worldsheet beyond the four embedding coordinates of the string to ensure consistency of the theory. In the standard quantization of four dimensional string theory an additional field called the Liouville field arises [4], which may be interpreted as a fifth space-time dimension. Polyakov has suggested [47, 48] that such a five dimensional string theory could be related to four dimensional gauge theories if the couplings of the Liouville field to the other fields take some specific forms. As we will see, the AdS/CFT correspondence realizes this idea, but with five additional dimensions (in addition to the radial coordinate on AdS which can be thought of as a generalization of the Liouville field), leading to a standard (critical) ten dimensional string theory.

1.3 Black p -Branes

The recent insight into the connection between large N field theories and string theory has emerged from the study of p -branes in string theory. The p -branes were originally found as classical solutions to supergravity, which is the low energy limit of string theory. Later it was pointed out by Polchinski that D-branes give their full string theoretical description. Various comparisons of the two descriptions led to the discovery of the AdS/CFT correspondence.

1.3.1 Classical Solutions

String theory has a variety of classical solutions corresponding to extended black holes [49, 50, 51, 52, 53, 54, 55, 56, 57, 58, 59]. Complete descriptions of all possible black hole solutions would be beyond the scope of this review, and we will discuss here only illustrative examples corresponding to parallel D p branes. For a more extensive review of extended objects in string theory, see [60, 61].

Let us consider type II string theory in ten dimensions, and look for a black hole solution carrying electric charge with respect to the Ramond-Ramond (R-R) $(p + 1)$ -form A_{p+1} [50, 55, 58]. In type IIA (IIB) theory, p is even (odd). The theory contains also magnetically charged $(6 - p)$ -branes, which are electrically charged under the dual $dA_{7-p} = *dA_{p+1}$ potential. Therefore, R-R charges have to be quantized according to the Dirac quantization condition. To find the solution, we start with the low energy effective action in the string frame,

$$S = \frac{1}{(2\pi)^7 l_s^8} \int d^{10}x \sqrt{-g} \left(e^{-2\phi} (\mathcal{R} + 4(\nabla\phi)^2) - \frac{2}{(8-p)!} F_{p+2}^2 \right), \quad (1.9)$$

where l_s is the string length, related to the string tension $(2\pi\alpha')^{-1}$ as $\alpha' = l_s^2$, and F_{p+2} is the field strength of the $(p + 1)$ -form potential, $F_{p+2} = dA_{p+1}$. In the self-dual case of $p = 3$ we work directly with the equations of motion. We then look for a solution

corresponding to a p -dimensional electric source of charge N for A_{p+1} , by requiring the Euclidean symmetry $ISO(p)$ in p -dimensions:

$$ds^2 = ds_{10-p}^2 + e^\alpha \sum_{i=1}^p dx^i dx^i. \quad (1.10)$$

Here ds_{10-p}^2 is a Lorentzian-signature metric in $(10-p)$ -dimensions. We also assume that the metric is spherically symmetric in $(10-p)$ dimensions with the R-R source at the origin,

$$\int_{S^{8-p}} {}^*F_{p+2} = N, \quad (1.11)$$

where S^{8-p} is the $(8-p)$ -sphere surrounding the source. By using the Euclidean symmetry $ISO(p)$, we can reduce the problem to the one of finding a spherically symmetric charged black hole solution in $(10-p)$ dimensions [50, 55, 58]. The resulting metric, in the string frame, is given by

$$ds^2 = -\frac{f_+(\rho)}{\sqrt{f_-(\rho)}} dt^2 + \sqrt{f_-(\rho)} \sum_{i=1}^p dx^i dx^i + \frac{f_-(\rho)^{-\frac{1}{2}-\frac{5-p}{7-p}}}{f_+(\rho)} d\rho^2 + r_-^2 f_-(\rho)^{\frac{1}{2}-\frac{5-p}{7-p}} d\Omega_{8-p}^2, \quad (1.12)$$

with the dilaton field,

$$e^{-2\phi} = g_s^{-2} f_-(\rho)^{-\frac{p-3}{2}}, \quad (1.13)$$

where

$$f_\pm(\rho) = 1 - \left(\frac{r_\pm}{\rho}\right)^{7-p}, \quad (1.14)$$

and g_s is the asymptotic string coupling constant. The parameters r_+ and r_- are related to the mass M (per unit volume) and the RR charge N of the solution by

$$M = \frac{1}{(7-p)(2\pi)^7 d_p l_P^8} \left((8-p)r_+^{7-p} - r_-^{7-p} \right), \quad N = \frac{1}{d_p g_s l_s^{7-p}} (r_+ r_-)^{\frac{7-p}{2}}, \quad (1.15)$$

where $l_P = g_s^{\frac{1}{4}} l_s$ is the 10-dimensional Planck length and d_p is a numerical factor,

$$d_p = 2^{5-p} \pi^{\frac{5-p}{2}} \Gamma\left(\frac{7-p}{2}\right). \quad (1.16)$$

The metric in the Einstein frame, $(g_{\mathcal{E}})_{\mu\nu}$, is defined by multiplying the string frame metric $g_{\mu\nu}$ by $\sqrt{g_s e^{-\phi}}$ in (1.9), so that the action takes the standard Einstein-Hilbert form,

$$S = \frac{1}{(2\pi)^7 l_P^8} \int d^{10}x \sqrt{-g_{\mathcal{E}}} \left(\mathcal{R}_{\mathcal{E}} - \frac{1}{2} (\nabla\phi)^2 + \dots \right). \quad (1.17)$$

The Einstein frame metric has a horizon at $\rho = r_+$. For $p \leq 6$, there is also a curvature singularity at $\rho = r_-$. When $r_+ > r_-$, the singularity is covered by the horizon and

the solution can be regarded as a black hole. When $r_+ < r_-$, there is a timelike naked singularity and the Cauchy problem is not well-posed.

The situation is subtle in the critical case $r_+ = r_-$. If $p \neq 3$, the horizon and the singularity coincide and there is a “null” singularity⁴. Moreover, the dilaton either diverges or vanishes at $\rho = r_+$. This singularity, however, is milder than in the case of $r_+ < r_-$, and the supergravity description is still valid up to a certain distance from the singularity. The situation is much better for $p = 3$. In this case, the dilaton is constant. Moreover, the $\rho = r_+$ surface is regular even when $r_+ = r_-$, allowing a smooth analytic extension beyond $\rho = r_+$ [62].

According to (1.15), for a fixed value of N , the mass M is an increasing function of r_+ . The condition $r_+ \geq r_-$ for the absence of the timelike naked singularity therefore translates into an inequality between the mass M and the R-R charge N , of the form

$$M \geq \frac{N}{(2\pi)^p g_s l_s^{p+1}}. \quad (1.18)$$

The solution whose mass M is at the lower bound of this inequality is called an *extremal p -brane*. On the other hand, when M is strictly greater than that, we have a *non-extremal black p -brane*. It is called *black* since there is an event horizon for $r_+ > r_-$. The area of the black hole horizon goes to zero in the extremal limit $r_+ = r_-$. Since the extremal solution with $p \neq 3$ has a singularity, the supergravity description breaks down near $\rho = r_+$ and we need to use the full string theory. The D-brane construction discussed below will give exactly such a description. The inequality (1.18) is also the BPS bound with respect to the 10-dimensional supersymmetry, and the extremal solution $r_+ = r_-$ preserves one half of the supersymmetry in the regime where we can trust the supergravity description. This suggests that the extremal p -brane is a ground state of the black p -brane for a given charge N .

The extremal limit $r_+ = r_-$ of the solution (1.12) is given by

$$ds^2 = \sqrt{f_+(\rho)} \left(-dt^2 + \sum_{i=1}^p dx^i dx^i \right) + f_+(\rho)^{-\frac{3}{2} - \frac{5-p}{7-p}} d\rho^2 + \rho^2 f_+(\rho)^{\frac{1}{2} - \frac{5-p}{7-p}} d\Omega_{8-p}^2. \quad (1.19)$$

In this limit, the symmetry of the metric is enhanced from the Euclidean group $ISO(p)$ to the Poincaré group $ISO(p, 1)$. This fits well with the interpretation that the extremal solution corresponds to the ground state of the black p -brane. To describe the geometry of the extremal solution outside of the horizon, it is often useful to define a new coordinate r by

$$r^{7-p} \equiv \rho^{7-p} - r_+^{7-p}, \quad (1.20)$$

⁴This is the case for $p < 6$. For $p = 6$, the singularity is timelike as one can see from the fact that it can be lifted to the Kaluza-Klein monopole in 11 dimensions.

and introduce the isotropic coordinates, $r^a = r\theta^a$ ($a = 1, \dots, 9 - p$; $\sum_a(\theta^a)^2 = 1$). The metric and the dilaton for the extremal p -brane are then written as

$$ds^2 = \frac{1}{\sqrt{H(r)}} \left(-dt^2 + \sum_{i=1}^p dx^i dx^i \right) + \sqrt{H(r)} \sum_{a=1}^{9-p} dr^a dr^a, \quad (1.21)$$

$$e^\phi = g_s H(r)^{\frac{3-p}{4}}, \quad (1.22)$$

where

$$H(r) = \frac{1}{f_+(\rho)} = 1 + \frac{r_+^{7-p}}{r^{7-p}}, \quad r_+^{7-p} = d_p g_s N l_s^{7-p}. \quad (1.23)$$

The horizon is now located at $r = 0$.

In general, (1.21) and (1.22) give a solution to the supergravity equations of motion for any function $H(\vec{r})$ which is a harmonic function in the $(9 - p)$ dimensions which are transverse to the p -brane. For example, we may consider a more general solution, of the form

$$H(\vec{r}) = 1 + \sum_{i=1}^k \frac{r_{(i)+}^{7-p}}{|\vec{r} - \vec{r}_i|^{7-p}}, \quad r_{(i)+}^{7-p} = d_p g_s N_i l_s^{7-p}. \quad (1.24)$$

This is called a multi-centered solution and represents parallel extremal p -branes located at k different locations, $\vec{r} = \vec{r}_i$ ($i = 1, \dots, k$), each of which carries N_i units of the R-R charge.

So far we have discussed the black p -brane using the classical supergravity. This description is appropriate when the curvature of the p -brane geometry is small compared to the string scale, so that stringy corrections are negligible. Since the strength of the curvature is characterized by r_+ , this requires $r_+ \gg l_s$. To suppress string loop corrections, the effective string coupling e^ϕ also needs to be kept small. When $p = 3$, the dilaton is constant and we can make it small everywhere in the 3-brane geometry by setting $g_s < 1$, namely $l_P < l_s$. If $g_s > 1$ we might need to do an S -duality, $g_s \rightarrow 1/g_s$, first. Moreover, in this case it is known that the metric (1.21) can be analytically extended beyond the horizon $r = 0$, and that the maximally extended metric is geodesically complete and without a singularity [62]. The strength of the curvature is then uniformly bounded by r_+^{-2} . To summarize, for $p = 3$, the supergravity approximation is valid when

$$l_P < l_s \ll r_+. \quad (1.25)$$

Since r_+ is related to the R-R charge N as

$$r_+^{7-p} = d_p g_s N l_s^{7-p}, \quad (1.26)$$

this can also be expressed as

$$1 \ll g_s N < N. \quad (1.27)$$

For $p \neq 3$, the metric is singular at $r = 0$, and the supergravity description is valid only in a limited region of the spacetime.

1.3.2 D-Branes

Alternatively, the extremal p -brane can be described as a D-brane. For a review of D-branes, see [63]. The Dp -brane is a $(p+1)$ -dimensional hyperplane in spacetime where an open string can end. By the worldsheet duality, this means that the D-brane is also a source of closed strings (see Fig. 1.2). In particular, it can carry the R-R charges. It was shown in [6] that, if we put N Dp -branes on top of each other, the resulting $(p+1)$ -dimensional hyperplane carries exactly N units of the $(p+1)$ -form charge. On the worldsheet of a type II string, the left-moving degrees of freedom and the right-moving degrees of freedom carry separate spacetime supercharges. Since the open string boundary condition identifies the left and right movers, the D-brane breaks at least one half of the spacetime supercharges. In type IIA (IIB) string theory, precisely one half of the supersymmetry is preserved if p is even (odd). This is consistent with the types of R-R charges that appear in the theory. Thus, the Dp -brane is a BPS object in string theory which carries exactly the same charge as the black p -brane solution in supergravity.

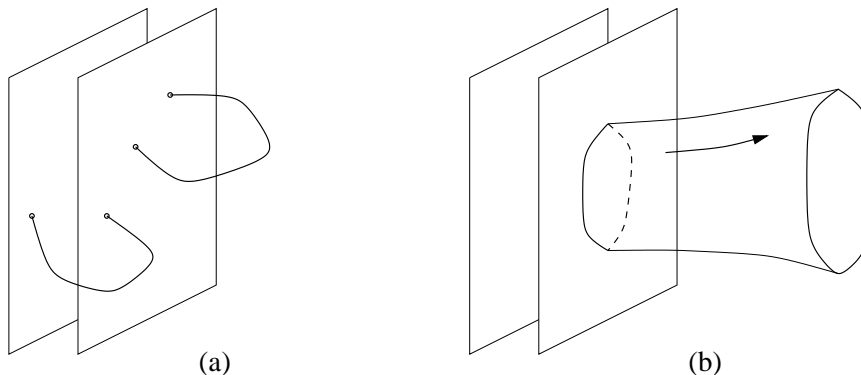

Figure 1.2: (a) The D-brane is where open strings can end. (b) The D-brane is a source of closed strings.

It is believed that the extremal p -brane in supergravity and the Dp -brane are two different descriptions of the same object. The D-brane uses the string worldsheet and, therefore, is a good description in string perturbation theory. When there are N D-branes on top of each other, the effective loop expansion parameter for the open strings is $g_s N$ rather than g_s , since each open string boundary loop ending on the D-branes comes with the Chan-Paton factor N as well as the string coupling g_s . Thus, the D-brane description is good when $g_s N \ll 1$. This is complementary to the regime (1.27) where the supergravity description is appropriate.

The low energy effective theory of open strings on the Dp -brane is the $U(N)$ gauge

theory in $(p + 1)$ dimensions with 16 supercharges [9]. The theory has $(9 - p)$ scalar fields $\vec{\Phi}$ in the adjoint representation of $U(N)$. If the vacuum expectation value $\langle \vec{\Phi} \rangle$ has k distinct eigenvalues⁵, with N_1 identical eigenvalues $\vec{\phi}_1$, N_2 identical eigenvalues $\vec{\phi}_2$ and so on, the gauge group $U(N)$ is broken to $U(N_1) \times \cdots \times U(N_k)$. This corresponds to the situation when N_1 D-branes are at $\vec{r}_1 = \vec{\phi}_1 l_s^2$, N_2 D p -branes are at $\vec{r}_2 = \vec{\phi}_2 l_s^2$, and so on. In this case, there are massive W -bosons for the broken gauge groups. The W -boson in the bi-fundamental representation of $U(N_i) \times U(N_j)$ comes from the open string stretching between the D-branes at \vec{r}_i and \vec{r}_j , and the mass of the W -boson is proportional to the Euclidean distance $|\vec{r}_i - \vec{r}_j|$ between the D -branes. It is important to note that the same result is obtained if we use the supergravity solution for the multi-centered p -brane (1.24) and compute the mass of the string going from \vec{r}_i to \vec{r}_j , since the factor $H(\vec{r})^{\frac{1}{4}}$ from the metric in the \vec{r} -space (1.21) is cancelled by the redshift factor $H(\vec{r})^{-\frac{1}{4}}$ when converting the string tension into energy. Both the D-brane description and the supergravity solution give the same value of the W -boson mass, since it is determined by the BPS condition.

1.3.3 Greybody Factors and Black Holes

An important precursor to the AdS/CFT correspondence was the calculation of greybody factors for black holes built out of D-branes. It was noted in [14] that Hawking radiation could be mimicked by processes where two open strings collide on a D-brane and form a closed string which propagates into the bulk. The classic computation of Hawking (see, for example, [64] for details) shows in a semi-classical approximation that the differential rate of spontaneous emission of particles of energy ω from a black hole is

$$d\Gamma_{\text{emit}} = \frac{v\sigma_{\text{absorb}}}{e^{\omega/T_H} \pm 1} \frac{d^n k}{(2\pi)^n}, \quad (1.28)$$

where v is the velocity of the emitted particle in the transverse directions, and the sign in the denominator is minus for bosons and plus for fermions. We use n to denote the number of spatial dimensions around the black hole (or if we are dealing with a black brane, it is the number of spatial dimensions perpendicular to the world-volume of the brane). T_H is the Hawking temperature, and σ_{absorb} is the cross-section for a particle coming in from infinity to be absorbed by the black hole. In the differential emission rate, the emitted particle is required to have a momentum in a small region $d^n k$, and ω is a function of k . To obtain a total emission rate we would integrate (1.28) over all k .

If σ_{absorb} were a constant, then (1.28) tells us that the emission spectrum is the same

⁵There is a potential $\sum_{I,J} \text{Tr}[\Phi^I, \Phi^J]^2$ for the scalar fields, so expectation values of the matrices Φ^I ($I = 1, \dots, 9 - p$) minimizing the potential are simultaneously diagonalizable.

as that of a blackbody. Typically, σ_{absorb} is not constant, but varies appreciably over the range of finite ω/T_H . The consequent deviations from the pure blackbody spectrum have earned σ_{absorb} the name “greybody factor.” A successful microscopic account of black hole thermodynamics should be able to predict these greybody factors. In [16] and its many successors, it was shown that the D-branes provided an account of black hole microstates which was successful in this respect.

Our first goal will be to see how greybody factors are computed in the context of quantum fields in curved spacetime. The literature on this subject is immense. We refer the reader to [65] for an overview of the General Relativity literature, and to [18, 11, 61] and references therein for a first look at the string theory additions.

In studying scattering of particles off of a black hole (or any fixed target), it is convenient to make a partial wave expansion. For simplicity, let us restrict the discussion to scalar fields. Assuming that the black hole is spherically symmetric, one can write the asymptotic behavior at infinity of the time-independent scattering solution as

$$\begin{aligned} \phi(\vec{r}) &\sim e^{ikx} + f(\theta) \frac{e^{ikr}}{r^{n/2}} \\ &\sim \sum_{\ell=0}^{\infty} \frac{1}{2} \tilde{P}_{\ell}(\cos\theta) \frac{S_{\ell} e^{ikr} + (-1)^{\ell;n} e^{-ikr}}{(ikr)^{n/2}}, \end{aligned} \quad (1.29)$$

where $x = r \cos\theta$. The term e^{ikx} represents the incident wave, and the second term in the first line represents the scattered wave. The $\tilde{P}_{\ell}(\cos\theta)$ are generalizations of Legendre polynomials. The absorption probability for a given partial wave is given by $P_{\ell} = 1 - |S_{\ell}|^2$. An application of the Optical Theorem leads to the absorption cross section [66]

$$\sigma_{\text{abs}}^{\ell} = \frac{2^{n-1} \pi^{\frac{n-1}{2}}}{k^n} \Gamma\left(\frac{n-1}{2}\right) \left(\ell + \frac{n-1}{2}\right) \binom{\ell+n-2}{\ell} P_{\ell}. \quad (1.30)$$

Sometimes the absorption probability P_{ℓ} is called the greybody factor.

The strategy of absorption calculations in supergravity is to solve a linearized wave equation, most often the Klein-Gordon equation $\square\phi = 0$, using separation of variables, $\phi = e^{-i\omega t} P_{\ell}(\cos\theta) R(r)$. Typically the radial function cannot be expressed in terms of known functions, so some approximation scheme is used, as we will explain in more detail below. Boundary conditions are imposed at the black hole horizon corresponding to infalling matter. Once the solution is obtained, one can either use the asymptotics (1.29) to obtain S_{ℓ} and from it P_{ℓ} and $\sigma_{\text{abs}}^{\ell}$, or compute the particle flux at infinity and at the horizon and note that particle number conservation implies that P_{ℓ} is their ratio.

One of the few known universal results is that for $\omega/T_H \ll 1$, σ_{abs} for an s -wave massless scalar approaches the horizon area of the black hole [67]. This result holds

for any spherically symmetric black hole in any dimension. For ω much larger than any characteristic curvature scale of the geometry, one can use the geometric optics approximation to find σ_{abs} .

We will be interested in the particular black hole geometries for which string theory provides a candidate description of the microstates. Let us start with N coincident D3-branes, where the low-energy world-volume theory is $d = 4$ $\mathcal{N} = 4$ $U(N)$ gauge theory. The equation of motion for the dilaton is $\square \phi = 0$ where \square is the laplacian for the metric

$$ds^2 = \left(1 + \frac{R^4}{r^4}\right)^{-1/2} \left(-dt^2 + dx_1^2 + dx_2^2 + dx_3^2\right) + \left(1 + \frac{R^4}{r^4}\right)^{1/2} \left(dr^2 + r^2 d\Omega_5^2\right). \quad (1.31)$$

It is convenient to change radial variables: $r = Re^{-z}$, $\phi = e^{2z}\psi$. The radial equation for the ℓ^{th} partial wave is

$$\left[\partial_z^2 + 2\omega^2 R^2 \cosh 2z - (\ell + 2)^2\right] \psi_\ell(z) = 0, \quad (1.32)$$

which is precisely Schrodinger's equation with a potential $V(z) = -2\omega^2 R^2 \cosh 2z$. The absorption probability is precisely the tunneling probability for the barrier $V(z)$: the transmitted wave at large positive z represents particles falling into the D3-branes. At leading order in small ωR , the absorption probability for the ℓ^{th} partial wave is

$$P_\ell = \frac{4\pi^2}{(\ell + 1)!^4 (\ell + 2)^2} \left(\frac{\omega R}{2}\right)^{8+4\ell}. \quad (1.33)$$

This result, together with a recursive algorithm for computing all corrections as a series in ωR , was obtained in [68] from properties of associated Mathieu functions, which are the solutions of (1.32). An exact solution of a radial equation in terms of known special functions is rare. We will therefore present a standard approximation technique (developed in [69] and applied to the problem at hand in [10]) which is sufficient to obtain the leading term of (1.33). Besides, for comparison with string theory predictions we are generally interested only in this leading term.

The idea is to find limiting forms of the radial equation which can be solved exactly, and then to match the limiting solutions together to approximate the full solution. Usually a uniformly good approximation can be found in the limit of small energy. The reason, intuitively speaking, is that on a compact range of radii excluding asymptotic infinity and the horizon, the zero energy solution is nearly equal to solutions with very small energy; and outside this region the wave equation usually has a simple limiting form. So one solves the equation in various regions and then matches together a global solution.

It is elementary to show that this can be done for (1.32) using two regions:

$$\begin{aligned}
\text{far region: } z \gg \log \omega R & \quad \left[\partial_z^2 + \omega^2 R^2 e^{2z} - (\ell + 2)^2 \right] \psi = 0 \\
& \quad \psi(z) = H_{\ell+2}^{(1)}(\omega R e^z) \\
\text{near region: } z \ll -\log \omega R & \quad \left[\partial_z^2 + \omega^2 R^2 e^{-2z} - (\ell + 2)^2 \right] \psi = 0 \\
& \quad \psi(z) = a J_{\ell+2}(\omega R e^{-z})
\end{aligned} \tag{1.34}$$

It is amusing to note the \mathbb{Z}_2 symmetry, $z \rightarrow -z$, which exchanges the far region, where the first equation in (1.34) is just free particle propagation in flat space, and the near region, where the second equation in (1.34) describes a free particle in AdS_5 . This peculiar symmetry was first pointed out in [10]. It follows from the fact that the full D3-brane metric comes back to itself, up to a conformal rescaling, if one sends $r \rightarrow R^2/r$. A similar duality exists between six-dimensional flat space and $AdS_3 \times S^3$ in the D1-D5-brane solution, where the Laplace equation again can be solved in terms of Mathieu functions [70, 71]. To our knowledge there is no deep understanding of this “inversion duality.”

For low energies $\omega R \ll 1$, the near and far regions overlap in a large domain, $\log \omega R \ll z \ll -\log \omega R$, and by comparing the solutions in this overlap region one can fix a and reproduce the leading term in (1.33). It is possible but tedious to obtain the leading correction by treating the small terms which were dropped from the potential to obtain the limiting forms in (1.34) as perturbations. This strategy was pursued in [72, 73] before the exact solution was known, and in cases where there is no exact solution. The validity of the matching technique is discussed in [65], but we know of no rigorous proof that it holds in all the circumstances in which it has been applied.

The successful comparison of the s -wave dilaton cross-section in [10] with a perturbative calculation on the D3-brane world-volume was the first hint that Green’s functions of $\mathcal{N} = 4$ super-Yang-Mills theory could be computed from supergravity. In summarizing the calculation, we will follow more closely the conventions of [11], and give an indication of the first application of non-renormalization arguments [12] to understand why the agreement between supergravity and perturbative gauge theory existed despite their applicability in opposite limits of the ’t Hooft coupling.

Setting normalization conventions so that the pole in the propagator of the gauge bosons has residue one at tree level, we have the following action for the dilaton plus the fields on the brane:

$$S = \frac{1}{2\kappa^2} \int d^{10}x \sqrt{g} \left[\mathcal{R} - \frac{1}{2}(\partial\phi)^2 + \dots \right] + \int d^4x \left[-\frac{1}{4}e^{-\phi} \text{Tr} F_{\mu\nu}^2 + \dots \right], \tag{1.35}$$

where we have omitted other supergravity fields, their interactions with one another, and also terms with the lower spin fields in the gauge theory action. A plane wave

of dilatons with energy ω and momentum perpendicular to the brane is kinematically equivalent on the world-volume to a massive particle which can decay into two gauge bosons through the coupling $\frac{1}{4}\phi\text{Tr}F_{\mu\nu}^2$. In fact, the absorption cross-section is given precisely by the usual expression for the decay rate into k particles:

$$\sigma_{\text{abs}} = \frac{1}{S_f} \frac{1}{2\omega} \int \frac{d^3p_1}{(2\pi)^3 2\omega_1} \cdots \frac{d^3p_k}{(2\pi)^3 2\omega_k} (2\pi)^4 \delta^4(P_f - P_i) |\overline{\mathcal{M}}|^2 . \quad (1.36)$$

In the Feynman rules for \mathcal{M} , a factor of $\sqrt{2\kappa^2}$ attaches to an external dilaton line on account of the non-standard normalization of its kinetic term in (1.35). This factor gives σ_{abs} the correct dimensions: it is a length to the fifth power, as appropriate for six transverse spatial dimensions. In (1.36), $|\overline{\mathcal{M}}|^2$ indicates summation over distinguishable processes: in the case of the s -wave dilaton there are N^2 such processes because of the number of gauge bosons. One easily verifies that $|\overline{\mathcal{M}}|^2 = N^2 \kappa^2 \omega^4$. S_f is a symmetry factor for identical particles in the final state: in the case of the s -wave dilaton, $S_f = 2$ because the outgoing gauge bosons are identical.

Carrying out the $\ell = 0$ calculation explicitly, one finds

$$\sigma_{\text{abs}} = \frac{N^2 \kappa^2 \omega^3}{32\pi} , \quad (1.37)$$

which, using (1.30) and the relation between R and N , can be shown to be in precise agreement with the leading term of P_0 in (1.33). This is now understood to be due to a non-renormalization theorem for the two-point function of the operator $\mathcal{O}_4 = \frac{1}{4}\text{Tr}F^2$.

To understand the connection with two-point functions, note that an absorption calculation is insensitive to the final state on the D-brane world-volume. The absorption cross-section is therefore related to the discontinuity in the cut of the two-point function of the operator to which the external field couples. To state a result of some generality, let us suppose that a scalar field ϕ in ten dimensions couples to a gauge theory operator through the action

$$S_{\text{int}} = \int d^4x \partial_{y_{i_1}} \cdots \partial_{y_{i_\ell}} \phi(x, y_i) \Big|_{y_i=0} \mathcal{O}^{i_1 \cdots i_\ell}(x) , \quad (1.38)$$

where we use x to denote the four coordinates parallel to the world-volume and y_i to denote the other six. An example where this would be the right sort of coupling is the ℓ^{th} partial wave of the dilaton [11]. The ℓ^{th} partial wave absorption cross-section for a particle with initial momentum $p = \omega(\hat{t} + \hat{y}_1)$ is obtained by summing over all final

$$\sum_X \left| \frac{1}{\sqrt{2\kappa^2}} \left(\text{Diagram: incoming closed string, } n \text{ outgoing lines} \right) \mathbf{X} \right|^2 = \frac{2\kappa^2}{i} \text{Disc} \left(\text{Diagram: two closed strings, } n \text{ internal lines, unitarity cut} \right)$$

Figure 1.3: An application of the optical theorem.

states that could be created by the operator $\mathcal{O}^{1\dots 1}$.⁶

$$\begin{aligned} \sigma_{\text{abs}} &= \frac{1}{2\omega} \sum_n \prod_{i=1}^n \frac{1}{S_f} \frac{d^3 p_i}{(2\pi)^3 2\omega_i} (2\pi)^4 \delta^4(P_f - P_i) |\overline{\mathcal{M}}|^2 \\ &= \frac{2\kappa^2 \omega^\ell}{2i\omega} \text{Disc} \int d^4 x e^{ip \cdot x} \langle \mathcal{O}^{1\dots 1}(x) \mathcal{O}^{1\dots 1}(0) \rangle \Big|_{p=(\omega, 0, 0, 0)}. \end{aligned} \quad (1.39)$$

In the second equality we have applied the Optical Theorem (see figure 1.3). The factor of $2\kappa^2$ is the square of the external leg factor for the incoming closed string state, which was included in the invariant amplitude \mathcal{M} . The factor of ω^ℓ arises from acting with the ℓ derivatives in (1.38) on the incoming plane wave state. The symbol Disc indicates that one is looking at the unitarity cut in the two-point function in the s plane, where $s = p^2$. The two-point function can be reconstructed uniquely from this cut, together with some weak conditions on regularity for large momenta. Results analogous to (1.39) can be stated for incoming particles with spin, only it becomes more complicated because a polarization must be specified, and the two-point function in momentum space includes a polynomial in p which depends on the polarization.

Expressing absorption cross-sections in terms of two-point functions helps illustrate why there is ever agreement between the tree-level calculation indicated in (1.36) and the supergravity result, which one would *a priori* expect to pick up all sorts of radiative corrections. Indeed, it was observed in [12] that the s -wave graviton cross-section agreed between supergravity and tree-level gauge theory because the correlator $\langle T_{\alpha\beta} T_{\gamma\delta} \rangle$ enjoys a non-renormalization theorem. One way to see that there must be such a non-renormalization theorem is to note that conformal Ward identities relate this two-point function to $\langle T_\mu^\mu T_{\alpha\beta} T_{\gamma\delta} \rangle$ (see for example [74] for the details), and supersymmetry in turn relates this anomalous three-point function to the anomalous VEV's of the divergence of R-currents in the presence of external sources for them. The Adler-Bardeen theorem [75] protects these anomalies, hence the conclusion.

Another case which has been studied extensively is a system consisting of several D1 and D5 branes. The D1-branes are delocalized on the four extra dimensions of the D5-brane, which are taken to be small, so that the total system is effectively 1+1-

⁶There is one restriction on the final states: for a process to be regarded as an ℓ^{th} partial wave absorption cross-section, ℓ units of angular momentum must be picked up by the brane. Thus $\mathcal{O}^{i_1 \dots i_\ell}$ must transform in the irreducible representation which is the ℓ^{th} traceless symmetric power of the $\mathbf{6}$ of $SO(6)$.

dimensional. We will discuss the physics of this system more extensively in chapter 5, and the reader can also find background material in [61]. For now our purpose is to show how supergravity absorption calculations relate to finite-temperature Green's functions in the 1+1-dimensional theory.

Introducing momentum along the spatial world-volume (carried by open strings attached to the branes), one obtains the following ten-dimensional metric and dilaton:

$$\begin{aligned}
 ds_{10,\text{str}}^2 = & H_1^{-1/2} H_5^{-1/2} \left[-dt^2 + dx_5^2 + \frac{r_0^2}{r^2} (\cosh \sigma dt + \sinh \sigma dx_5)^2 \right] \\
 & + H_1^{1/2} H_5^{-1/2} \sum_{i=1}^4 dy_i^2 + H_1^{1/2} H_5^{1/2} \left[\left(1 - \frac{r_0^2}{r^2} \right)^{-1} dr^2 + r^2 d\Omega_3^2 \right] \quad (1.40)
 \end{aligned}$$

$$\begin{aligned}
 e^{\phi - \phi_\infty} &= H_1^{1/2} H_5^{-1/2} \\
 H_1 &= 1 + \frac{r_1^2}{r^2} \quad H_5 = 1 + \frac{r_5^2}{r^2} .
 \end{aligned}$$

The quantities r_1^2 , r_5^2 , and $r_K^2 = r_0^2 \sinh^2 \sigma$ are related to the number of D1-branes, the number of D5-branes, and the net number of units of momentum in the x_5 direction, respectively. The horizon radius, r_0 , is related to the non-extremality. For details, see for example [18]. If $r_0 = 0$ then there are only left-moving open strings on the world-volume; if $r_0 \neq 0$ then there are both left-movers and right-movers. The Hawking temperature can be expressed as $\frac{2}{T_H} = \frac{1}{T_L} + \frac{1}{T_R}$, where

$$T_L = \frac{1}{\pi} \frac{r_0 e^\sigma}{2r_1 r_5} \quad T_R = \frac{1}{\pi} \frac{r_0 e^{-\sigma}}{2r_1 r_5} . \quad (1.41)$$

T_L and T_R have the interpretation of temperatures of the left-moving and right-moving sectors of the 1+1-dimensional world-volume theory. There is a detailed and remarkably successful account of the Bekenstein-Hawking entropy using statistical mechanics in the world-volume theory. It was initiated in [13], developed in a number of subsequent papers, and has been reviewed in [61].

The region of parameter space which we will be interested in is

$$r_0, r_K \ll r_1, r_5 \quad (1.42)$$

This is known as the dilute gas regime. The total energy of the open strings on the branes is much less than the constituent mass of either the D1-branes or the D5-branes. We are also interested in low energies $\omega r_1, \omega r_5 \ll 1$, but $\omega/T_{L,R}$ can be arbitrary thanks to (1.42), (1.41). The D1-D5-brane system is not stable because left-moving open strings can run into right-moving open string and form a closed string: indeed, this is exactly the process we aim to quantify. Since we have collisions of left and right

moving excitations we expect that the answer will contain the left and right moving occupation factors, so that the emission rate is

$$d\Gamma = g_{eff}^2 \frac{1}{(e^{\frac{\omega}{2T_L}} - 1)} \frac{1}{(e^{\frac{\omega}{2T_R}} - 1)} \frac{d^4k}{(2\pi)^4} \quad (1.43)$$

where g_{eff} is independent of the temperature and measures the coupling of the open strings to the closed strings. The functional form of (1.43) seems, at first sight, to be different from (1.28). But in order to compare them we should calculate the absorption cross section appearing in (1.28).

Off-diagonal gravitons $h_{y_1 y_2}$ (with $y_{1,2}$ in the compact directions) reduce to scalars in six dimensions which obey the massless Klein Gordon equation. These so-called minimal scalars have been the subject of the most detailed study. We will consider only the s -wave and we take the momentum along the string to be zero. Separation of variables leads to the radial equation

$$\left[\frac{h}{r^3} \partial_r h r^2 \partial_r + \omega^2 f \right] R = 0, \quad (1.44)$$

$$h = 1 - \frac{r_0^2}{r^2}, \quad f = \left(1 + \frac{r_1^2}{r^2} \right) \left(1 + \frac{r_5^2}{r^2} \right) \left(1 + \frac{r_0^2 \sinh^2 \sigma}{r^2} \right).$$

Close to the horizon, a convenient radial variable is $z = h = 1 - r_0^2/r^2$. The matching procedure can be summarized as follows:

$$\begin{aligned} \text{far region:} \quad & \left[\frac{1}{r^3} \partial_r r^3 \partial_r + \omega^2 \right] R = 0 \\ & R = A \frac{J_1(\omega r)}{r^{3/2}}, \\ \text{near region:} \quad & \left[z(1-z) \partial_z^2 + \left(1 - i \frac{\omega}{2\pi T_H} \right) (1-z) \partial_z + \frac{\omega^2}{16\pi^2 T_L T_R} \right] z^{\frac{i\omega}{4\pi T_H}} R = 0 \\ & R = z^{-\frac{i\omega}{4\pi T_H}} F \left(-i \frac{\omega}{4\pi T_L}, -i \frac{\omega}{4\pi T_R}; 1 - i \frac{\omega}{2\pi T_H}; z \right). \end{aligned} \quad (1.45)$$

After matching the near and far regions together and comparing the infalling flux at infinity and at the horizon, one arrives at

$$\sigma_{\text{abs}} = \pi^3 r_1^2 r_5^2 \omega \frac{e^{\frac{\omega}{T_H}} - 1}{\left(e^{\frac{\omega}{2T_L}} - 1 \right) \left(e^{\frac{\omega}{2T_R}} - 1 \right)}. \quad (1.46)$$

This has precisely the right form to ensure the matching of (1.43) with (1.28) (note that for a massless particle with no momentum along the black string $v = 1$ in (1.28)).

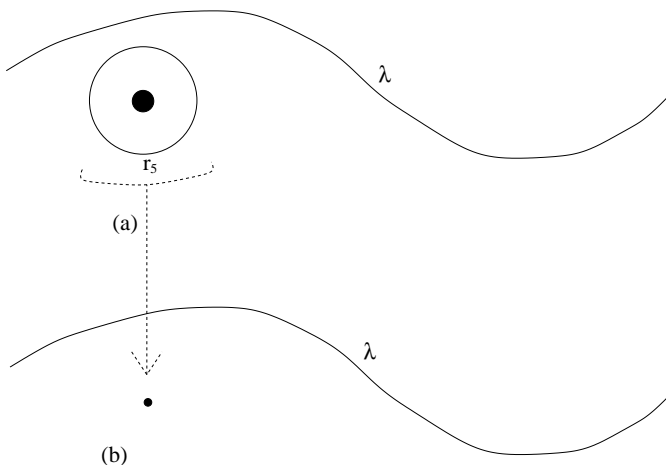

Figure 1.4: Low energy dynamics of extremal or near-extremal black branes. r_5 denotes the typical gravitational size of the system, namely the position where the metric significantly deviates from Minkowski space. The Compton wavelength of the particles we scatter is much larger than the gravitational size, $\lambda \gg r_5$. In this situation we replace the whole black hole geometry (a) by a point-like system in the transverse coordinates with localized excitations (b). These excitations are the ones described by the field theory living on the brane.

It is possible to be more precise and calculate the coefficient in (1.43) and actually check that the matching is precise [16]. We leave this to chapter 5.

Both in the D3-brane analysis and in the D1-D5-brane analysis, one can see that all the interesting physics is resulting from the near-horizon region: the far region wavefunction describes free particle propagation. For quanta whose Compton wavelength is much larger than the size of the black hole, the effect of the far region is merely to set the boundary conditions in the near region. See figure 1.4. This provides a motivation for the prescription for computing Green's functions, to be described in section 3.3: as the calculations of this section demonstrate, cutting out the near-horizon region of the supergravity geometry and replacing it with the D-branes leads to an identical response to low-energy external probes.

Chapter 2

Conformal Field Theories and AdS Spaces

2.1 Conformal Field Theories

Symmetry principles, and in particular Lorentz and Poincaré invariance, play a major role in our understanding of quantum field theory. It is natural to look for possible generalizations of Poincaré invariance in the hope that they may play some role in physics; in [76] it was argued that for theories with a non-trivial S-matrix there are no such bosonic generalizations. An interesting generalization of Poincaré invariance is the addition of a scale invariance symmetry linking physics at different scales (this is inconsistent with the existence of an S-matrix since it does not allow the standard definition of asymptotic states). Many interesting field theories, like Yang-Mills theory in four dimensions, are scale-invariant; generally this scale invariance does not extend to the quantum theory (whose definition requires a cutoff which explicitly breaks scale invariance) but in some special cases (such as the $d = 4, \mathcal{N} = 4$ supersymmetric Yang-Mills theory) it does, and even when it does not (like in QCD) it can still be a useful tool, leading to relations like the Callan-Symanzik equation. It was realized in the past 30 years that field theories generally exhibit a renormalization group flow from some scale-invariant (often free) UV fixed point to some scale-invariant (sometimes trivial) IR fixed point, and statistical mechanics systems also often have non-trivial IR scale-invariant fixed points. Thus, studying scale-invariant theories is interesting for various physical applications.

It is widely believed that unitary interacting scale-invariant theories are always invariant under the full conformal group, which is a simple group including scale invariance and Poincaré invariance. This has only been proven in complete generality for two dimensional field theories [77, 78], but there are no known counter-examples. In this section we will review the conformal group and its implications for field theories,

focusing on implications which will be useful in the context of the AdS/CFT correspondence. General reviews on conformal field theories may be found in [79, 80, 81] and references therein.

2.1.1 The Conformal Group and Algebra

The conformal group is the group of transformations which preserve the form of the metric up to an arbitrary scale factor, $g_{\mu\nu}(x) \rightarrow \Omega^2(x)g_{\mu\nu}(x)$ (in this section greek letters will correspond to the space-time coordinates, $\mu, \nu = 0, \dots, d-1$). It is the minimal group that includes the Poincaré group as well as the inversion symmetry $x^\mu \rightarrow x^\mu/x^2$.

The conformal group of Minkowski space¹ is generated by the Poincaré transformations, the scale transformation

$$x^\mu \rightarrow \lambda x^\mu, \quad (2.1)$$

and the special conformal transformations

$$x^\mu \rightarrow \frac{x^\mu + a^\mu x^2}{1 + 2x^\nu a_\nu + a^2 x^2}. \quad (2.2)$$

We will denote the generators of these transformations by $M_{\mu\nu}$ for the Lorentz transformations, P_μ for translations, D for the scaling transformation (2.1) and K_μ for the special conformal transformations (2.2). The vacuum of a conformal theory is annihilated by all of these generators. They obey the conformal algebra

$$\begin{aligned} [M_{\mu\nu}, P_\rho] &= -i(\eta_{\mu\rho}P_\nu - \eta_{\nu\rho}P_\mu); & [M_{\mu\nu}, K_\rho] &= -i(\eta_{\mu\rho}K_\nu - \eta_{\nu\rho}K_\mu); \\ [M_{\mu\nu}, M_{\rho\sigma}] &= -i\eta_{\mu\rho}M_{\nu\sigma} \pm \text{permutations}; & [M_{\mu\nu}, D] &= 0; & [D, K_\mu] &= iK_\mu; \\ [D, P_\mu] &= -iP_\mu; & [P_\mu, K_\nu] &= 2iM_{\mu\nu} - 2i\eta_{\mu\nu}D, \end{aligned} \quad (2.3)$$

with all other commutators vanishing. This algebra is isomorphic to the algebra of $SO(d, 2)$, and can be put in the standard form of the $SO(d, 2)$ algebra (with signature $-, +, +, \dots, +, -$) with generators J_{ab} ($a, b = 0, \dots, d+1$) by defining

$$J_{\mu\nu} = M_{\mu\nu}; \quad J_{\mu d} = \frac{1}{2}(K_\mu - P_\mu); \quad J_{\mu(d+1)} = \frac{1}{2}(K_\mu + P_\mu); \quad J_{(d+1)d} = D. \quad (2.4)$$

For some applications it is useful to study the conformal theory in Euclidean space; in this case the conformal group is $SO(d+1, 1)$,² and since \mathbb{R}^d is conformally equivalent to S^d the field theory on \mathbb{R}^d (with appropriate boundary conditions at infinity) is

¹More precisely, some of these transformations can take finite points in Minkowski space to infinity, so they should be defined on a compactification of Minkowski space which includes points at infinity.

²Strictly speaking, $SO(d+1, 1)$ is the connected component of the conformal group which includes the identity, and it does not include $x^\mu \rightarrow x^\mu/x^2$. We will hereafter ignore such subtleties.

isomorphic to the theory on S^d . Much of what we say below will apply also to the Euclidean theory.

In the special case of $d = 2$ the conformal group is larger, and in fact it is infinite dimensional. The special aspects of this case will be discussed in chapter 5 where they will be needed.

2.1.2 Primary Fields, Correlation Functions, and Operator Product Expansions

The interesting representations (for physical applications) of the conformal group involve operators (or fields) which are eigenfunctions of the scaling operator D with eigenvalue $-i\Delta$ (Δ is called the *scaling dimension* of the field). This means that under the scaling transformation (2.1) they transform as $\phi(x) \rightarrow \phi'(x) = \lambda^\Delta \phi(\lambda x)$. The commutation relations (2.3) imply that the operator P_μ raises the dimension of the field, while the operator K_μ lowers it. In unitary field theories there is a lower bound on the dimension of fields (for scalar fields it is $\Delta \geq (d-2)/2$ which is the dimension of a free scalar field), and, therefore, each representation of the conformal group which appears must have some operator of lowest dimension, which must then be annihilated by K_μ (at $x = 0$). Such operators are called *primary operators*. The action of the conformal group on such operators is given by [82]

$$\begin{aligned}
[P_\mu, \Phi(x)] &= i\partial_\mu \Phi(x), \\
[M_{\mu\nu}, \Phi(x)] &= [i(x_\mu \partial_\nu - x_\nu \partial_\mu) + \Sigma_{\mu\nu}] \Phi(x), \\
[D, \Phi(x)] &= i(-\Delta + x^\mu \partial_\mu) \Phi(x), \\
[K_\mu, \Phi(x)] &= [i(x^2 \partial_\mu - 2x_\mu x^\nu \partial_\nu + 2x_\mu \Delta) - 2x^\nu \Sigma_{\mu\nu}] \Phi(x),
\end{aligned}
\tag{2.5}$$

where $\Sigma_{\mu\nu}$ are the matrices of a finite dimensional representation of the Lorentz group, acting on the indices of the Φ field. The representations of the conformal group corresponding to primary operators are classified by the Lorentz representation and the scaling dimension Δ (these determine the Casimirs of the conformal group). These representations include the primary field and all the fields which are obtained by acting on it with the generators of the conformal group (specifically with P_μ). Since the operators in these representations are eigenfunctions of D , they cannot in general be eigenfunctions of the Hamiltonian P_0 or of the mass operator $M^2 = -P^\mu P_\mu$ (which is a Casimir operator of the Poincaré group but not of the conformal group); in fact, they have a continuous spectrum of M^2 ranging from 0 to ∞ (there are also representations corresponding to free massless fields which have $M^2 = 0$).

Another possible classification of the representations of the conformal group is in terms of its maximal compact subgroup, which is $SO(d) \times SO(2)$. The generator of

$SO(2)$ is $J_{0(d+1)} = \frac{1}{2}(K_0 + P_0)$, and the representations of the conformal group described above may be decomposed into representations of this subgroup. This is useful in particular for the oscillator constructions of the representations of superconformal algebras [83, 84, 85, 86, 87, 88, 89], which we will not describe in detail here (see [90] for a recent review). This subgroup is also useful in the radial quantization of the conformal field theory on $S^{d-1} \times \mathbb{R}$, which will be related to AdS space in global coordinates.

Since the conformal group is much larger than the Poincaré group, it severely restricts the correlation functions of primary fields, which must be invariant under conformal transformations. It has been shown by Luscher and Mack [91] that the Euclidean Green's functions of a CFT may be analytically continued to Minkowski space, and that the resulting Hilbert space carries a unitary representation of the Lorentzian conformal group. The formulas we will write here for correlation functions apply both in Minkowski and in Euclidean space. It is easy to show using the conformal algebra that the 2-point functions of fields of different dimension vanish, while for a single scalar field of scaling dimension Δ we have

$$\langle \phi(0)\phi(x) \rangle \propto \frac{1}{|x|^{2\Delta}} \equiv \frac{1}{(x^2)^\Delta}. \quad (2.6)$$

3-point functions are also determined (up to a constant) by the conformal group to be of the form

$$\langle \phi_i(x_1)\phi_j(x_2)\phi_k(x_3) \rangle = \frac{c_{ijk}}{|x_1 - x_2|^{\Delta_1 + \Delta_2 - \Delta_3} |x_1 - x_3|^{\Delta_1 + \Delta_3 - \Delta_2} |x_2 - x_3|^{\Delta_2 + \Delta_3 - \Delta_1}}. \quad (2.7)$$

Similar expressions (possibly depending on additional constants) arise for non-scalar fields. With 4 independent x_i one can construct two combinations of the x_i (known as harmonic ratios) which are conformally invariant, so the correlation function can be any function of these combinations; for higher n -point functions there are more and more independent functions which can appear in the correlation functions. Many other properties of conformal field theories are also easily determined using the conformal invariance; for instance, their equation of state is necessarily of the form $S = cV(E/V)^{(d-1)/d}$ for some constant c .

The field algebra of any conformal field theory includes the energy-momentum tensor $T_{\mu\nu}$ which is an operator of dimension $\Delta = d$; the Ward identities of the conformal algebra relate correlation functions with T to correlation functions without T . Similarly, whenever there are global symmetries, their (conserved) currents J_μ are necessarily operators of dimension $\Delta = d - 1$. The scaling dimensions of other operators are not determined by the conformal group, and generally they receive quantum corrections. For any type of field there is, however, a lower bound on its dimension which follows

from unitarity; as mentioned above, for scalar fields the bound is $\Delta \geq (d-2)/2$, where equality can occur only for free scalar fields.

A general property of local field theories is the existence of an *operator product expansion* (OPE). As we bring two operators $\mathcal{O}_1(x)$ and $\mathcal{O}_2(y)$ to the same point, their product creates a general local disturbance at that point, which may be expressed as a sum of local operators acting at that point; in general all operators with the same global quantum numbers as $\mathcal{O}_1\mathcal{O}_2$ may appear. The general expression for the OPE is $\mathcal{O}_1(x)\mathcal{O}_2(y) \rightarrow \sum_n C_{12}^n(x-y)\mathcal{O}_n(y)$, where this expression should be understood as appearing inside correlation functions, and the coefficient functions C_{12}^n do not depend on the other operators in the correlation function (the expression is useful when the distance to all other operators is much larger than $|x-y|$). In a conformal theory, the functional form of the OPE coefficients is determined by conformal invariance to be $C_{12}^n(x-y) = c_{12}^n/|x-y|^{\Delta_1+\Delta_2-\Delta_n}$, where the constants c_{12}^n are related to the 3-point functions described above. The leading terms in the OPE of the energy-momentum tensor with primary fields are determined by the conformal algebra. For instance, for a scalar primary field ϕ of dimension Δ in four dimensions,

$$T_{\mu\nu}(x)\phi(0) \propto \Delta\phi(0)\partial_\mu\partial_\nu\left(\frac{1}{x^2}\right) + \dots \quad (2.8)$$

One of the basic properties of conformal field theories is the one-to-one correspondence between local operators \mathcal{O} and states $|\mathcal{O}\rangle$ in the radial quantization of the theory. In radial quantization the time coordinate is chosen to be the radial direction in \mathbb{R}^d , with the origin corresponding to past infinity, so that the field theory lives on $\mathbb{R} \times S^{d-1}$. The Hamiltonian in this quantization is the operator $J_{0(d+1)}$ mentioned above. An operator \mathcal{O} can then be mapped to the state $|\mathcal{O}\rangle = \lim_{x \rightarrow 0} \mathcal{O}(x)|0\rangle$. Equivalently, the state may be viewed as a functional of field values on some ball around the origin, and then the state corresponding to \mathcal{O} is defined by a functional integral on a ball around the origin with the insertion of the operator \mathcal{O} at the origin. The inverse mapping of states to operators proceeds by taking a state which is a functional of field values on some ball around the origin and using conformal invariance to shrink the ball to zero size, in which case the insertion of the state is necessarily equivalent to the insertion of some local operator.

2.1.3 Superconformal Algebras and Field Theories

Another interesting generalization of the Poincaré algebra is the supersymmetry algebra, which includes additional fermionic operators Q which anti-commute to the translation operators P_μ . It is interesting to ask whether supersymmetry and the conformal group can be joined together to form the largest possible simple algebra including the

Poincaré group; it turns out that in some dimensions and for some numbers of supersymmetry charges this is indeed possible. The full classification of superconformal algebras was given by Nahm [92]; it turns out that superconformal algebras exist only for $d \leq 6$. In addition to the generators of the conformal group and the supersymmetry, superconformal algebras include two other types of generators. There are fermionic generators S (one for each supersymmetry generator) which arise in the commutator of K_μ with Q , and there are (sometimes) R-symmetry generators forming some Lie algebra, which appear in the anti-commutator of Q and S (the generators Q and S are in the fundamental representation of this Lie algebra). Schematically (suppressing all indices), the commutation relations of the superconformal algebra include, in addition to (2.3), the relations

$$\begin{aligned}
[D, Q] &= -\frac{i}{2}Q; & [D, S] &= \frac{i}{2}S; & [K, Q] &\simeq S; & [P, S] &\simeq Q; \\
\{Q, Q\} &\simeq P; & \{S, S\} &\simeq K; & \{Q, S\} &\simeq M + D + R.
\end{aligned}
\tag{2.9}$$

The exact form of the commutation relations is different for different dimensions (since the spinorial representations of the conformal group behave differently) and for different R-symmetry groups, and we will not write them explicitly here.

For free field theories without gravity, which do not include fields whose spin is bigger than one, the maximal possible number of supercharges is 16 (a review of field theories with this number of supercharges appears in [93]); it is believed that this is the maximal possible number of supercharges also in interacting field theories. Therefore, the maximal possible number of fermionic generators in a field theory superconformal algebra is 32. Superconformal field theories with this number of supercharges exist only for $d = 3, 4, 6$ ($d = 1$ may also be possible but there are no known examples). For $d = 3$ the R-symmetry group is $Spin(8)$ and the fermionic generators are in the $(\mathbf{4}, \mathbf{8})$ of $SO(3, 2) \times Spin(8)$; for $d = 4$ the R-symmetry group is $SU(4)$ and³ the fermionic generators are in the $(\mathbf{4}, \mathbf{4}) + (\bar{\mathbf{4}}, \bar{\mathbf{4}})$ of $SO(4, 2) \times SU(4)$; and for $d = 6$ the R-symmetry group is $Sp(2) \simeq SO(5)$ and the fermionic generators are in the $(\mathbf{8}, \mathbf{4})$ representation of $SO(6, 2) \times Sp(2)$.

Since the conformal algebra is a subalgebra of the superconformal algebra, representations of the superconformal algebra split into several representations of the conformal algebra. Generally a primary field of the superconformal algebra, which is (by definition) annihilated (at $x = 0$) by the generators K_μ and S , will include several primaries of the conformal algebra, which arise by acting with the supercharges Q on the superconformal primary field. The superconformal algebras have special representations corresponding to *chiral primary operators*, which are primary operators which are annihilated by some combination of the supercharges. These representations are smaller

³Note that this is different from the other \mathcal{N} -extended superconformal algebras in four dimensions which have a $U(\mathcal{N})$ R-symmetry.

than the generic representations, containing less conformal-primary fields. A special property of chiral primary operators is that their dimension is uniquely determined by their R-symmetry representations and cannot receive any quantum corrections. This follows by using the fact that all the S generators and some of the Q generators annihilate the field, and using the $\{Q, S\}$ commutation relation to compute the eigenvalue of D in terms of the Lorentz and R-symmetry representations [94, 95, 96, 93, 97]. The dimensions of non-chiral primary fields of the same representation are always strictly larger than those of the chiral primary fields. A simple example is the $d = 4, \mathcal{N} = 1$ superconformal algebra (which has a $U(1)$ R-symmetry group); in this case a chiral multiplet (annihilated by \overline{Q}) which is a primary is also a chiral primary, and the algebra can be used to prove that the dimension of the scalar component of such multiplets is $\Delta = \frac{3}{2}R$ where R is the $U(1)$ R-charge. A detailed description of the structure of chiral primaries in the $d = 4, \mathcal{N} = 4$ algebra will appear in section 3.2.

When the R-symmetry group is Abelian, we find a bound of the form $\Delta \geq a|R|$ for some constant a , ensuring that there is no singularity in the OPE of two chiral ($\Delta = aR$) or anti-chiral ($\Delta = a|R| = -aR$) operators. On the other hand, when the R-symmetry group is non-Abelian, singularities can occur in the OPEs of chiral operators, and are avoided only when the product lies in particular representations.

2.2 Anti-de Sitter Space

2.2.1 Geometry of Anti-de Sitter Space

In this section, we will review some geometric facts about anti-de Sitter space. One of the important facts is the relation between the conformal compactifications of AdS and of flat space. In the case of the Euclidean signature metric, it is well-known that the flat space \mathbb{R}^n can be compactified to the n -sphere S^n by *adding a point at infinity*, and a conformal field theory is naturally defined on S^n . On the other hand, the $(n + 1)$ -dimensional hyperbolic space, which is the Euclidean version of AdS space, can be conformally mapped into the $(n + 1)$ -dimensional disk D_{n+1} . Therefore the boundary of the compactified hyperbolic space is the compactified Euclid space. A similar correspondence holds in the case with the Lorentzian signature metric, as we will see below.

Conformal Structure of Flat Space

One of the basic features of the AdS/CFT correspondence is the identification of the isometry group of AdS_{p+2} with the conformal symmetry of flat Minkowski space $\mathbb{R}^{1,p}$. Therefore, it would be appropriate to start our discussion by reviewing the conformal

structure of flat space.

◦ $\mathbb{R}^{1,1}$

We begin with two-dimensional Minkowski space $\mathbb{R}^{1,1}$:

$$ds^2 = -dt^2 + dx^2, \quad (-\infty < t, x < +\infty). \quad (2.10)$$

This metric can be rewritten by the following coordinate transformations

$$\begin{aligned} ds^2 &= -du_+ du_-, & (u_{\pm} = t \pm x) \\ &= \frac{1}{4 \cos^2 \tilde{u}_+ \cos^2 \tilde{u}_-} (-d\tau^2 + d\theta^2), & (u_{\pm} = \tan \tilde{u}_{\pm}; \tilde{u}_{\pm} = (\tau \pm \theta)/2) \end{aligned} \quad (2.11)$$

In this way, the Minkowski space is conformally mapped into the interior of the compact region, $|\tilde{u}_{\pm}| < \pi/2$, as shown in figure 2.1. Since light ray trajectories are invariant under a conformal rescaling of the metric, this provides a convenient way to express the causal structure of $\mathbb{R}^{1,1}$. The new coordinates (τ, θ) are well defined at the asymptotical regions of the flat space. Therefore, the conformal compactification is used to give a rigorous definition of *asymptotic flatness* of spacetime — a spacetime is called asymptotically flat if it has the same boundary structure as that of the flat space after conformal compactification.

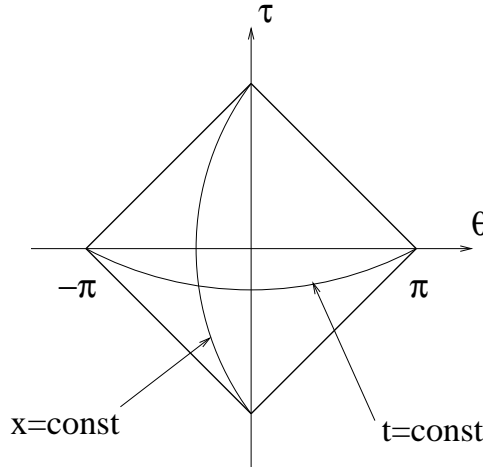

Figure 2.1: Two-dimensional Minkowski space is conformally mapped into the interior of the rectangle.

The two corners of the rectangle at $(\tau, \theta) = (0, \pm\pi)$ correspond to the spatial infinities $x = \pm\infty$ in the original coordinates. By identifying these two points, we can embed

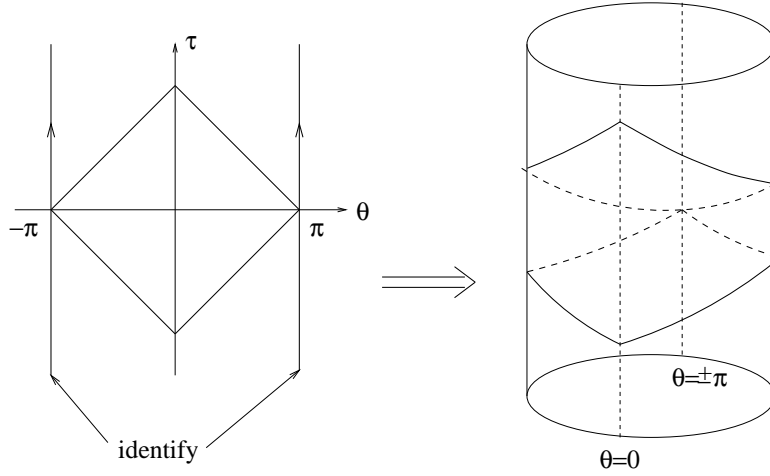

Figure 2.2: The rectangular region can be embedded in a cylinder, with $\theta = \pi$ and $\theta = -\pi$ being identified.

the rectangular image of $\mathbb{R}^{1,1}$ in a cylinder $\mathbb{R} \times S^1$ as shown in figure 2.2. It was proven by Lüscher and Mack [91] that correlation functions of a conformal field theory (CFT) on $\mathbb{R}^{1,1}$ can be analytically continued to the entire cylinder.

As we saw in section 2.1, the global conformal symmetry of $\mathbb{R}^{1,1}$ is $SO(2,2)$, which is generated by the 6 conformal Killing vectors $\partial_{\pm}, u_{\pm}\partial_{\pm}, u_{\pm}^2\partial_{\pm}$. The translations along the cylinder $\mathbb{R} \times S^1$ are expressed as their linear combinations

$$\frac{\partial}{\partial\tau} \pm \frac{\partial}{\partial\theta} = \frac{\partial}{\partial\tilde{u}_{\pm}} = (1 + u_{\pm}^2)\frac{\partial}{\partial u_{\pm}}. \quad (2.12)$$

In the standard form of $SO(2,2)$ generators, J_{ab} , given in section 2.1, they correspond to J_{03} and J_{12} , and generate the maximally compact subgroup $SO(2) \times SO(2)$ of $SO(2,2)$.

◦ $\mathbb{R}^{1,p}$ with $p \geq 2$

It is straightforward to extend the above analysis to higher dimensional Minkowski space:

$$ds^2 = -dt^2 + dr^2 + r^2 d\Omega_{p-1}^2, \quad (2.13)$$

where $d\Omega_{p-1}$ is the line element on the unit sphere S^{p-1} . A series of coordinate changes transforms this as

$$ds^2 = -du_+ du_- + \frac{1}{4}(u_+ - u_-)^2 d\Omega_{p-1}^2, \quad (u_{\pm} = t \pm r)$$

$$\begin{aligned}
&= \frac{1}{\cos^2 \tilde{u}_+ \cos^2 \tilde{u}_-} \left(-d\tilde{u}_+ d\tilde{u}_- + \frac{1}{4} \sin^2(\tilde{u}_+ - \tilde{u}_-) d\Omega_{p-1}^2 \right), \quad (u_{\pm} = \tan \tilde{u}_{\pm}) \\
&= \frac{1}{4 \cos^2 \tilde{u}_+ \cos^2 \tilde{u}_-} (-d\tau^2 + d\theta^2 + \sin^2 \theta d\Omega_{p-1}^2), \quad (\tilde{u}_{\pm} = (\tau \pm \theta)/2). \quad (2.14)
\end{aligned}$$

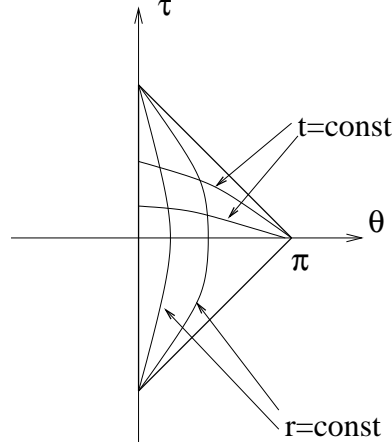

Figure 2.3: The conformal transformation maps the (t, r) half plane into a triangular region in the (τ, θ) plane.

As shown in figure 2.3, the (t, r) half-plane (for a fixed point on S^{p-1}) is mapped into a triangular region in the (τ, θ) plane. The conformally scaled metric

$$ds'^2 = -d\tau^2 + d\theta^2 + \sin^2 \theta d\Omega_{p-1}^2 \quad (2.15)$$

can be analytically continued outside of the triangle, and the maximally extended space with

$$0 \leq \theta \leq \pi, \quad -\infty < \tau < +\infty, \quad (2.16)$$

has the geometry of $\mathbb{R} \times S^p$ (Einstein static universe), where $\theta = 0$ and π corresponds to the north and south poles of S^p . This is a natural generalization of the conformal embedding of $\mathbb{R}^{1,1}$ into $\mathbb{R} \times S^1$ that we saw in the $p = 1$ case.

Since

$$\frac{\partial}{\partial \tau} = \frac{1}{2}(1 + u_+^2) \frac{\partial}{\partial u_+} + \frac{1}{2}(1 + u_-^2) \frac{\partial}{\partial u_-}, \quad (2.17)$$

the generator H of the global time translation on $\mathbb{R} \times S^p$ is identified with the linear combination

$$H = \frac{1}{2}(P_0 + K_0) = J_{0,p+2}, \quad (2.18)$$

where P_0 and K_0 are translation and special conformal generators,

$$P_0 : \frac{1}{2} \left(\frac{\partial}{\partial u_+} + \frac{\partial}{\partial u_-} \right), \quad K_0 : \frac{1}{2} \left(u_+^2 \frac{\partial}{\partial u_+} + u_-^2 \frac{\partial}{\partial u_-} \right) \quad (2.19)$$

on $\mathbb{R}^{1,p}$ defined in section 2.1. The generator $H = J_{0,p+2}$ corresponds to the $SO(2)$ part of the maximally compact subgroup $SO(2) \times SO(p+1)$ of $SO(2, p+1)$. Thus the subgroup $SO(2) \times SO(p+1)$ (or to be precise its universal cover) of the conformal group $SO(2, p+1)$ can be identified with the isometry of the Einstein static universe $\mathbb{R} \times S^p$. The existence of the generator H also guarantees that a correlation function of a CFT on $\mathbb{R}^{1,p}$ can be analytically extended to the entire Einstein static universe $\mathbb{R} \times S^p$.

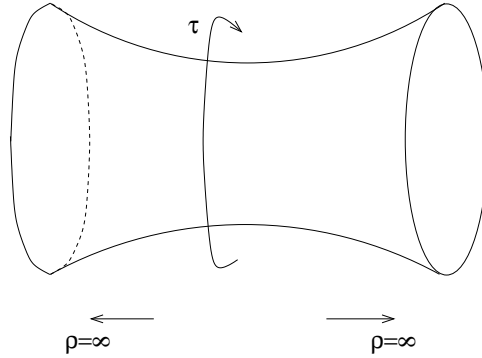

Figure 2.4: AdS_{p+2} is realized as a hyperboloid in $\mathbb{R}^{2,p+1}$. The hyperboloid has closed timelike curves along the τ direction. To obtain a causal space, we need to unwrap the circle to obtain a simply connected space.

Anti-de Sitter Space

The $(p+2)$ -dimensional anti-de Sitter space (AdS_{p+2}) can be represented as the hyperboloid

$$X_0^2 + X_{p+2}^2 - \sum_{i=1}^{p+1} X_i^2 = R^2, \quad (2.20)$$

in the flat $(p+3)$ -dimensional space with metric

$$ds^2 = -dX_0^2 - dX_{p+2}^2 + \sum_{i=1}^{p+1} dX_i^2. \quad (2.21)$$

By construction, the space has the isometry $SO(2, p+1)$, and it is homogeneous and isotropic.

Equation (2.20) can be solved by setting

$$\begin{aligned} X_0 &= R \cosh \rho \cos \tau, & X_{p+2} &= R \cosh \rho \sin \tau, \\ X_i &= R \sinh \rho \Omega_i \quad (i = 1, \dots, p+1; \sum_i \Omega_i^2 = 1). \end{aligned} \quad (2.22)$$

Substituting this into (2.21), we obtain the metric on AdS_{p+2} as

$$ds^2 = R^2(-\cosh^2 \rho d\tau^2 + d\rho^2 + \sinh^2 \rho d\Omega^2). \quad (2.23)$$

By taking $0 \leq \rho$ and $0 \leq \tau < 2\pi$ the solution (2.22) covers the entire hyperboloid once. Therefore, (τ, ρ, Ω_i) are called the global coordinates of AdS . Since the metric behaves near $\rho = 0$ as $ds^2 \simeq R^2(-d\tau^2 + d\rho^2 + \rho^2 d\Omega^2)$, the hyperboloid has the topology of $S^1 \times \mathbb{R}^{p+1}$, with S^1 representing closed timelike curves in the τ direction. To obtain a causal spacetime, we can simply unwrap the circle S^1 (i.e. take $-\infty < \tau < \infty$ with no identifications) and obtain the universal covering of the hyperboloid without closed timelike curves. In this paper, when we refer to AdS_{p+2} , we only consider this universal covering space.

The isometry group $SO(2, p+1)$ of AdS_{p+2} has the maximal compact subgroup $SO(2) \times SO(p+1)$. From the above construction, it is clear that the $SO(2)$ part represents the constant translation in the τ direction, and the $SO(p+1)$ gives rotations of S^p .

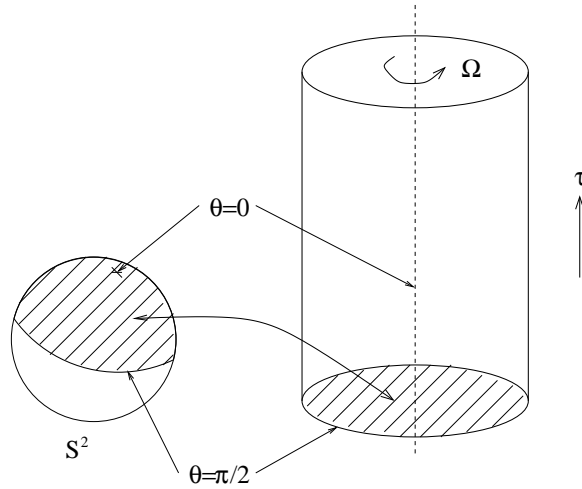

Figure 2.5: AdS_3 can be conformally mapped into one half of the Einstein static universe $\mathbb{R} \times S^2$.

To study the causal structure of AdS_{p+2} , it is convenient to introduce a coordinate

θ related to ρ by $\tan \theta = \sinh \rho$ ($0 \leq \theta < \pi/2$). The metric (2.23) then takes the form

$$ds^2 = \frac{R^2}{\cos^2 \theta} (-d\tau^2 + d\theta^2 + \sin^2 \theta d\Omega^2). \quad (2.24)$$

The causal structure of the spacetime does not change by a conformal rescaling on the metric. Multiplying the metric by $R^{-2} \cos^2 \theta$, it becomes

$$ds'^2 = -d\tau^2 + d\theta^2 + \sin^2 \theta d\Omega^2. \quad (2.25)$$

This is the metric of the Einstein static universe, which also appeared, with the dimension lower by one, in the conformal compactification of $\mathbb{R}^{1,p}$ (2.15). This time, however, the coordinate θ takes values in $0 \leq \theta < \pi/2$, rather than $0 \leq \theta < \pi$ in (2.15). Namely, AdS_{p+2} can be conformally mapped into *one half* of the Einstein static universe; the spacelike hypersurface of constant τ is a $(p+1)$ -dimensional hemisphere. The equator at $\theta = \pi/2$ is a boundary of the space with the topology of S^p , as shown in figure 2.5 in the case of $p = 1$. (In the case of AdS_2 , the coordinate θ ranges $-\pi/2 \leq \theta \leq \pi/2$ since S^0 consists of two points.) As in the case of the flat space discussed earlier, the conformal compactification is a convenient way to describe the asymptotic regions of AdS . In general, if a spacetime can be conformally compactified into a region which has the same boundary structure as one half of the Einstein static universe, the spacetime is called *asymptotically AdS*.

Since the boundary extends in the timelike direction labeled by τ , we need to specify a boundary condition on the $\mathbb{R} \times S^p$ at $\theta = \pi/2$ in order to make the Cauchy problem well-posed on AdS [98]. It turns out that the boundary of AdS_{p+2} , or to be precise the boundary of the conformally compactified AdS_{p+2} , is identical to the conformal compactification of the $(p+1)$ -dimensional Minkowski space. This fact plays an essential role in the AdS_{p+2}/CFT_{p+1} correspondence.

In addition to the global parametrization (2.22) of AdS , there is another set of coordinates (u, t, \vec{x}) ($0 < u, \vec{x} \in \mathbb{R}^p$) which will be useful later. It is defined by

$$\begin{aligned} X_0 &= \frac{1}{2u} \left(1 + u^2(R^2 + \vec{x}^2 - t^2) \right), & X_{p+2} &= Rut, \\ X^i &= Rux^i \quad (i = 1, \dots, p), \\ X^{p+1} &= \frac{1}{2u} \left(1 - u^2(R^2 - \vec{x}^2 + t^2) \right). \end{aligned} \quad (2.26)$$

These coordinates cover one half of the hyperboloid (2.20), as shown in figure 2.6 in the case of $p = 0$. Substituting this into (2.21), we obtain another form of the AdS_{p+2} metric

$$ds^2 = R^2 \left(\frac{du^2}{u^2} + u^2(-dt^2 + d\vec{x}^2) \right). \quad (2.27)$$

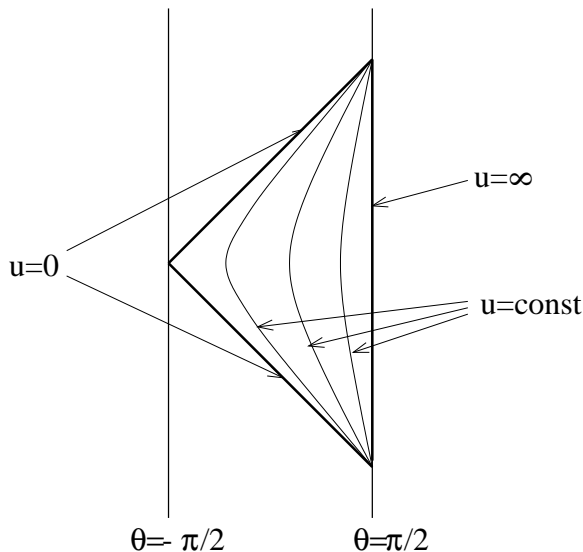

Figure 2.6: AdS_2 can be conformally mapped into $\mathbb{R} \times [-\pi/2, \pi/2]$. The (u, t) coordinates cover the triangular region.

The coordinates (u, t, \vec{x}) are called the Poincaré coordinates. In this form of the metric, the subgroups $ISO(1, p)$ and $SO(1, 1)$ of the $SO(2, p+1)$ isometry are manifest, where $ISO(1, p)$ is the Poincaré transformation on (t, \vec{x}) and $SO(1, 1)$ is

$$(t, \vec{x}, u) \rightarrow (ct, c\vec{x}, c^{-1}u), \quad c > 0. \quad (2.28)$$

In the AdS/CFT correspondence, this is identified with the dilatation D in the conformal symmetry group of $\mathbb{R}^{1,p}$.

It is useful to compare the two expressions, (2.23) and (2.27), for the metric of AdS_{p+2} . In (2.23), the norm of the timelike Killing vector ∂_τ is everywhere non-zero. In particular, it has a constant norm in the conformally rescaled metric (2.24). For this reason, τ is called the global time coordinate of AdS . On the other hand, the timelike Killing vector ∂_t in (2.27) becomes null at $u = 0$ (Killing horizon), as depicted in figure 2.7 in the AdS_2 case.

Euclidean Rotation

Since AdS_{p+2} has the global time coordinate τ and the metric (2.23) is static with respect to τ , quantum field theory on AdS_{p+2} (with an appropriate boundary condition at spatial infinity) allows the Wick rotation in τ , $e^{i\tau H} \rightarrow e^{-\tau_E H}$. From (2.22), one finds that the Wick rotation $\tau \rightarrow \tau_E = -i\tau$ is expressed in the original coordinates

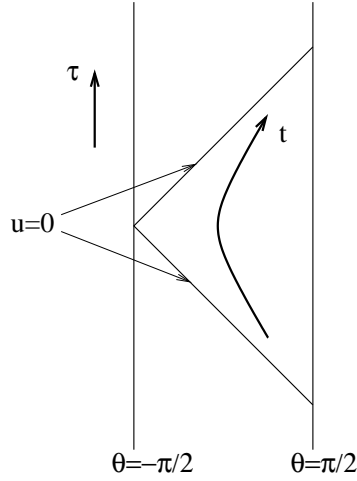

Figure 2.7: The timelike Killing vector ∂_t is depicted in the AdS_2 case. The vector ∂_t becomes a null vector at $u = 0$.

(X_0, \vec{X}, X_{p+2}) on the hyperboloid as $X_{p+2} \rightarrow X_E = -iX_{p+2}$, and the space becomes

$$\begin{aligned} X_0^2 - X_E^2 - \vec{X}^2 &= R^2, \\ ds_E^2 &= -dX_0^2 + dX_E^2 + d\vec{X}^2. \end{aligned} \quad (2.29)$$

We should point out that the same space is obtained by rotating the time coordinate t of the Poincaré coordinates (2.26) as $t \rightarrow t_E = -it$, even though the Poincaré coordinates cover only a part of the entire AdS (half of the hyperboloid). This is analogous to the well-known fact in flat Minkowski space that the Euclidean rotation of the time coordinate t in the Rindler space $ds^2 = -r^2 dt^2 + dr^2$ gives the flat Euclidean plane \mathbb{R}^2 , even though the Rindler coordinates (t, r) cover only a 1/4 of the entire Minkowski space $\mathbb{R}^{1,1}$.

In the coordinates $(\rho, \tau_E, \vec{\Omega}_p)$ and (u, t_E, \vec{x}) , the Euclidean metric is expressed as

$$\begin{aligned} ds_E^2 &= R^2 \left(\cosh^2 \rho d\tau_E^2 + d\rho^2 + \sinh^2 \rho d\Omega_p^2 \right) \\ &= R^2 \left(\frac{du^2}{u^2} + u^2 (dt_E^2 + d\vec{x}^2) \right). \end{aligned} \quad (2.30)$$

In the following, we also use another, trivially equivalent, form of the metric, obtained from the above by setting $u = 1/y$ in (2.30), giving

$$ds^2 = R^2 \left(\frac{dy^2 + dx_1^2 + \cdots + dx_{p+1}^2}{y^2} \right). \quad (2.31)$$

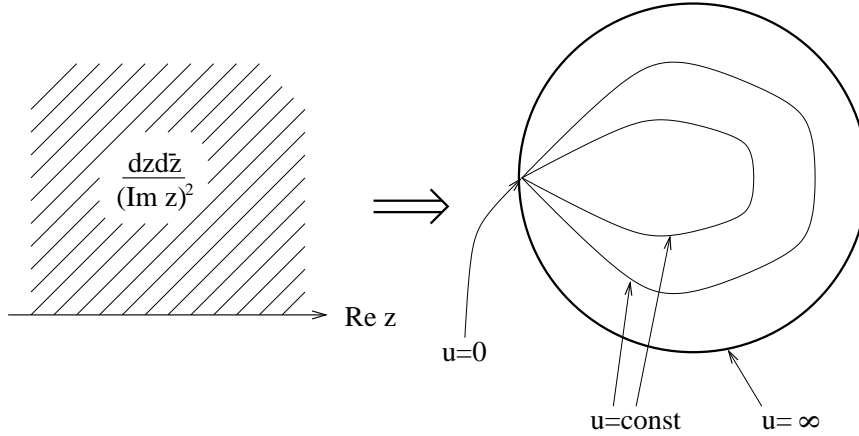

Figure 2.8: The Euclidean AdS_2 is the upper half plane with the Poincaré metric. It can be mapped into a disk, where the infinity of the upper half plane is mapped to a point on the boundary of the disk.

The Euclidean AdS_{p+2} is useful for various practical computations in field theory. For theories on flat space, it is well-known that correlation functions $\langle \phi_1 \cdots \phi_n \rangle$ of fields on the Euclidean space are related, by the Wick rotation, to the T -ordered correlation functions $\langle 0|T(\phi_1 \cdots \phi_n)|0 \rangle$ in the Minkowski space. The same is true in the anti-de Sitter space if the theory has a positive definite Hamiltonian with respect to the global time coordinate τ . Green functions of free fields on AdS_{p+2} have been computed in [99, 100] using this method.

The Euclidean AdS_{p+2} can be mapped into a $(p+2)$ -dimensional disk. In the coordinates (u, t_E, \vec{x}) , $u = \infty$ is the sphere S^{p+1} at the boundary with one point removed. The full boundary sphere is recovered by adding a point corresponding to $u = 0$ (or equivalently $\vec{x} = \infty$). This is shown in figure 2.8 in the case of AdS_2 , for which $z = t_E + i/u$ gives a complex coordinate on the upper-half plane. By adding a point at infinity, the upper-half plane is compactified into a disk. In the Lorentzian case, $u = 0$ represented the Killing horizon giving the boundary of the (u, t, \vec{x}) coordinates. Since the $u = 0$ plane is null in the Lorentzian case, it shrinks to a point in the Euclidean case.

2.2.2 Particles and Fields in Anti-de Sitter Space

Massive particles, moving along geodesics, can never get to the boundary of AdS . On the other hand, since the Penrose diagram of AdS is a cylinder, light rays can go to the boundary and back in finite time, as observed by an observer moving along a geodesic in AdS . More precisely, the light ray will reflect if suitable boundary conditions are set

for the fields propagating in AdS .

Let us first consider the case of a scalar field propagating in AdS_{p+2} . The field equation

$$(\Delta - m^2)\phi = 0 \quad (2.32)$$

has stationary wave solutions

$$\phi = e^{i\omega\tau} G(\theta) Y_l(\Omega_p), \quad (2.33)$$

where $Y_l(\Omega_p)$ is a spherical harmonic, which is an eigenstate of the Laplacian on S^p with an eigenvalue $l(l+p-1)$, and $G(\theta)$ is given by the hypergeometric function

$$G(\theta) = (\sin\theta)^l (\cos\theta)^{\lambda_{\pm}} {}_2F_1(a, b, c; \sin\theta), \quad (2.34)$$

with

$$\begin{aligned} a &= \frac{1}{2}(l + \lambda_{\pm} - \omega R), \\ b &= \frac{1}{2}(l + \lambda_{\pm} + \omega R), \\ c &= l + \frac{1}{2}(p + 1), \end{aligned} \quad (2.35)$$

and

$$\lambda_{\pm} = \frac{1}{2}(p + 1) \pm \frac{1}{2}\sqrt{(p + 1)^2 + 4(mR)^2}. \quad (2.36)$$

The energy-momentum tensor

$$T_{\mu\nu} = 2\partial_{\mu}\phi\partial_{\nu}\phi - g_{\mu\nu}\left((\partial\phi)^2 + m^2\phi^2\right) + \beta(g_{\mu\nu}\Delta - D_{\mu}D_{\nu} + R_{\mu\nu})\phi^2 \quad (2.37)$$

is conserved for any constant value of β . The value of β is determined by the coupling of the scalar curvature to ϕ^2 , which on AdS has the same effect as the mass term in the wave equation (2.32). The choice of β for each scalar field depends on the theory we are considering. The total energy E of the scalar field fluctuation,

$$E = \int d^{p+1}x \sqrt{-g} T_0^0, \quad (2.38)$$

is conserved only if the energy-momentum flux through the boundary at $\theta = \pi/2$ vanishes,

$$\int_{S^p} d\Omega_p \sqrt{g} n_i T_0^i|_{\theta=\pi/2} = 0. \quad (2.39)$$

This requirement reduces to the boundary condition

$$(\tan\theta)^p [(1 - 2\beta)\partial_{\theta} + 2\beta\tan\theta]\phi^2 \rightarrow 0 \quad (\theta \rightarrow \pi/2). \quad (2.40)$$

Going back to the stationary wave solution (2.34), this is satisfied if and only if either a or b in (2.34) is an integer. If we require the energy ω to be real, we find

$$|\omega|R = \lambda_{\pm} + l + 2n, \quad (n = 0, 1, 2, \dots). \quad (2.41)$$

This is possible only when λ defined by (2.36) is real. Consequently, the mass is bounded from below as

$$-\frac{1}{4}(p+1)^2 \leq m^2 R^2. \quad (2.42)$$

This is known as the Breitenlohner-Freedman bound [101, 102]. Note that a negative (mass)² is allowed to a certain extent. The Compton wavelength for these possible tachyons is comparable to the curvature radius of AdS . If $m^2 > -(p-1)(p+3)/4R^2$, we should choose λ_+ in (2.41) since this solution is normalizable while the solution with λ_- is not. If $m^2 \leq -(p-1)(p+3)/4R^2$, both solutions are normalizable and there are two different quantizations of the scalar field on AdS space. Which quantization to choose is often determined by requiring symmetry. See [102, 103, 104] for discussions of boundary conditions in supersymmetric theories. In general, all solutions to the wave equation form a single $SO(2, p+1)$ highest weight representation. The highest weight state is the lowest energy solution [105]. Since $SO(2, p+1)$ acts on AdS as isometries, the action of its generators on the solutions is given by first order differential operators.

2.2.3 Supersymmetry in Anti-de Sitter Space

The $SO(2, p+1)$ isometry group of AdS_{p+2} has a supersymmetric generalization called an AdS supergroup. To understand the supersymmetry on AdS , it would be useful to start with the simple supergravity with a cosmological constant Λ . In four dimensions, for example, the action of the $\mathcal{N} = 1$ theory is [106]

$$S = \int d^4x \left(-\sqrt{g}(\mathcal{R} - 2\Lambda) + \frac{1}{2}\epsilon^{\mu\nu\rho\sigma}\bar{\psi}_{\mu}\gamma^5\gamma_{\nu}\tilde{D}_{\rho}\psi_{\sigma} \right), \quad (2.43)$$

where

$$\tilde{D}_{\mu} = D_{\mu} + \frac{i}{2}\sqrt{\frac{\Lambda}{3}}\gamma_{\mu} \quad (2.44)$$

and D_{μ} is the standard covariant derivative. The local supersymmetry transformation rules for the vierbein $V_{a\mu}$ and the gravitino ψ_{μ} are

$$\begin{aligned} \delta V_{a\mu} &= -i\bar{\epsilon}(x)\gamma_a\psi_{\mu}, \\ \delta\psi_{\mu} &= \tilde{D}_{\mu}\epsilon(x). \end{aligned} \quad (2.45)$$

A global supersymmetry of a given supergravity background is determined by requiring that the gravitino variation is annihilated, $\delta\psi_{\mu} = 0$. The resulting condition

on $\epsilon(x)$,

$$\tilde{D}_\mu \epsilon = \left(D_\mu + \frac{i}{2} \sqrt{\frac{\Lambda}{3}} \gamma_\mu \right) \epsilon = 0, \quad (2.46)$$

is known as the Killing spinor equation. The integrability of this equation requires

$$[\tilde{D}_\mu, \tilde{D}_\nu] \epsilon = \frac{1}{2} (\mathcal{R}_{\mu\nu\rho\sigma} \sigma^{\rho\sigma} - \frac{2}{3} \Lambda \sigma_{\mu\nu}) \epsilon = 0, \quad (2.47)$$

where

$$\sigma_{\mu\nu} = \frac{1}{2} \gamma_{[\mu} \gamma_{\nu]}. \quad (2.48)$$

Since AdS is maximally symmetric, the curvature obeys

$$\mathcal{R}_{\mu\nu\rho\sigma} = \frac{1}{R^2} (g_{\mu\rho} g_{\nu\sigma} - g_{\mu\sigma} g_{\nu\rho}), \quad (2.49)$$

where R is the size of the hyperboloid defined by (2.20). Thus, if we choose the curvature of AdS to be $\Lambda = 3/R^2$ (this is necessary for AdS to be a classical solution of (2.43)), the integrability condition (2.47) is obeyed for any spinor ϵ . Since the Killing spinor equation (2.46) is a first order equation, this means that there are as many solutions to the equation as the number of independent components of the spinor. Namely, AdS preserves as many supersymmetries as flat space.

The existence of supersymmetry implies that, with an appropriate set of boundary conditions, the supergravity theory on AdS is stable with its energy bounded from below. The supergravity theories on AdS typically contains scalar fields with negative (mass)². However they all satisfy the bound (2.42) [104, 107]. The issue of the boundary condition and supersymmetry in AdS was further studied in [103]. A non-perturbative proof of the stability of AdS is given in [108], based on a generalization of Witten's proof [109] of the positive energy theorem in flat space [110].

2.2.4 Gauged Supergravities and Kaluza-Klein Compactifications

Extended supersymmetries in AdS_{p+2} with $p = 2, 3, 4, 5$ are classified by Nahm [92] (see also [111]) as

$$\begin{aligned} AdS_4 & : \quad OSp(\mathcal{N}|4), \quad \mathcal{N} = 1, 2, \dots \\ AdS_5 & : \quad SU(2, 2|\mathcal{N}/2), \quad \mathcal{N} = 2, 4, 6, 8 \\ AdS_6 & : \quad F(4) \\ AdS_7 & : \quad OSp(6, 2|\mathcal{N}), \quad \mathcal{N} = 2, 4. \end{aligned} \quad (2.50)$$

For AdS_{p+2} with $p > 5$, there is no simple AdS supergroup. These extended supersymmetries are realized as global symmetries of gauged supergravity on AdS_{p+2} . The AdS/CFT correspondence identifies them with the superconformal algebras discussed in section 2.1.3. Gauged supergravities are supergravity theories with non-abelian gauge fields in the supermultiplet of the graviton. Typically the cosmological constant is negative and AdS_{p+2} is a natural background geometry. Many of them are related to Kaluza-Klein compactification of the supergravities in 10 and 11 dimensions. A complete catalogue of gauged supergravities in dimensions ≤ 11 is found in [21]. Here we list some of them.

◦ AdS_7

The gauged supergravity in 7 dimensions has global supersymmetry $OSp(6, 2|\mathcal{N})$. The maximally supersymmetric case of $\mathcal{N} = 4$ constructed in [112] contains a Yang-Mills field with a gauge group $Sp(2) \simeq SO(5)$. The field content of this theory can be derived from a truncation of the spectrum of the Kaluza-Klein compactification of the 11-dimensional supergravity to 7 dimensions,

$$\mathbb{R}^{11} \rightarrow AdS_7 \times S^4. \quad (2.51)$$

The 11-dimensional supergravity has the Lagrangian

$$\mathcal{L} = \sqrt{g} \left(\frac{1}{4} R - \frac{1}{48} F_{\mu\nu\rho\sigma} F^{\mu\nu\rho\sigma} \right) + \frac{1}{72} A \wedge F \wedge F + \text{fermions}, \quad (2.52)$$

where A is a 3-form gauge field and $F = dA$. It was pointed out by Freund and Rubin [113] that there is a natural way to “compactify” the theory to 4 or 7 dimensions. We have put the word “compactify” in quotes since we will see that typically the size of the compact dimensions is comparable to the radius of curvature of the non-compact dimensions. To compactify the theory to 7 dimensions, the ansatz of Freund and Rubin sets the 4-form field strength F to be proportional to the volume element on a 4-dimensional subspace M_4 . The Einstein equation, which includes the contribution of F to the energy-momentum tensor, implies a positive curvature on M_4 and a constant negative curvature on the non-compact dimensions, *i.e.* they are AdS_7 .

The maximally symmetric case is obtained by considering $M_4 = S^4$. Since there is no cosmological constant in 11 dimensions, the radius R of S^4 is proportional to the curvature radius of AdS_7 . By the Kaluza-Klein mechanism, the $SO(5)$ isometry of S^4 becomes the gauge symmetry in 7 dimensions. The spherical harmonics on S^4 give an infinite tower of Kaluza-Klein particles on AdS_7 . A truncation of this spectrum to include only the graviton supermultiplet gives the spectrum of the $\mathcal{N} = 4$ $SO(5)$ gauged supergravity on AdS_7 . It has been believed that this is a consistent truncation of the full theory, and very recently it was shown in [114] that this is indeed the case. In general, there are subtleties in the consistent truncation procedure, which will be

discussed in more detail in the next subsection. There are also other $\mathcal{N} = 4$ theories with non-compact gauge groups $SO(p, q)$ with $p + q = 5$ [115].

The seven dimensional $\mathcal{N} = 2$ gauged supergravity with gauge group $Sp(1) \simeq SU(2)$ was constructed in [116]. In this case, one can have also a matter theory with possibly another gauge group G . It is not known whether a matter theory of arbitrary G with arbitrary coupling constant can be coupled to gauged supergravity. The Kaluza-Klein compactification of 10-dimensional $\mathcal{N} = 1$ supergravity, coupled to $\mathcal{N} = 1$ super Yang-Mills, on S^3 gives a particular example. In this case, ten dimensional anomaly cancellation requires particular choices of G .

◦ AdS_6

The 6-dimensional anti-de Sitter supergroup $F(4)$ is realized by the $\mathcal{N} = 4$ gauged supergravity with gauge group $SU(2)$. It was predicted to exist in [117] and constructed in [118]. It was conjectured in [119] to be related to a compactification of the ten dimensional massive type IIA supergravity theory. The relevant compactification of the massive type IIA supergravity is constructed as a fibration of AdS_6 over S^4 [120]. The form of the ten dimensional space is called a *warped product* [121] and it is the most general one that has the AdS isometry group [122]. The $SU(2)$ gauge group of the 6-dimensional $\mathcal{N} = 4$ gauged supergravity is associated with an $SU(2)$ subgroup of the $SO(4)$ isometry group of the compact part of the ten dimensional space.

◦ AdS_5

In 5 dimensions, there are $\mathcal{N} = 2, 4, 6$ and 8 gauged supergravities with supersymmetry $SU(2, 2|\mathcal{N}/2)$. The gauged $\mathcal{N} = 8$ supergravity was constructed in [123, 124]. It has the gauge group $SU(4) \simeq SO(6)$ and the global symmetry E_6 . This theory can be derived by a truncation of the compactification of 10-dimensional type IIB supergravity on S^5 using the Freund-Rubin ansatz, i.e. setting the self-dual 5-form field strength $F^{(5)}$ to be proportional to the volume form of S^5 [125, 85, 126]. By the Einstein equation, the strength of $F^{(5)}$ determines the radius of S^5 and the cosmological constant R^{-2} of AdS_5 .

This case is of particular interest; as we will see below, the AdS/CFT correspondence claims that it is dual to the large N (and large $g_{YM}^2 N$) limit of $\mathcal{N} = 4$ supersymmetric $SU(N)$ gauge theory in four dimensions. The complete Kaluza-Klein mass spectrum of the IIB supergravity theory on $AdS_5 \times S^5$ was obtained in [85, 126]. One of the interesting features of the Kaluza-Klein spectrum (in this case as well as in the other cases discussed in this section) is that the frequency ω of stationary wave solutions is quantized. For example, the masses of the scalar fields in the Kaluza-Klein tower are all of the form $(mR)^2 = \tilde{l}(\tilde{l}+4)$, where \tilde{l} is an integer bounded from below. Substituting this into (2.36) with $p = 3$, we obtain

$$\lambda_{\pm} = 2 \pm |\tilde{l} + 2|. \tag{2.53}$$

Therefore, the frequency ω given by (2.41) takes values in integer multiples of $1/R$:

$$|\omega|R = 2 \pm |\tilde{l} + 2| + l + 2n, \quad (n = 0, 1, 2, \dots). \quad (2.54)$$

This means that all the scalar fields in the supergravity multiplet are periodic in τ with the period 2π , i.e. the scalar fields are single-valued on the original hyperboloid (2.20) before taking the universal covering. This applies to all other fields in the supermultiplet as well, with the fermions obeying the Ramond boundary condition around the timelike circle.

The fact that the frequency ω is quantized has its origin in supersymmetry. The supergravity particles in 10 dimensions are BPS objects and preserve one half of the supersymmetry. This property is preserved under the Kaluza-Klein compactification on S^5 . The notion of the BPS particles in the case of *AdS* supergravity is clarified in [127] and it is shown, in the context of theories in 4 dimensions, that it leads to the quantization of ω . In the *AdS/CFT* correspondence, this is dual to the fact that chiral primary operators do not have anomalous dimensions.

On the other hand, energy levels of other states, such as stringy states or black holes, are not expected to be quantized as the supergravity modes are. Thus, the full string theory does not make sense on the hyperboloid but only on its universal cover without the closed timelike curve.

The $\mathcal{N} = 4$ gauged supergravity with gauge group $SU(2) \times U(1)$ was constructed in [128]. Various $\mathcal{N} = 2$ theories were constructed in [129, 130, 131, 132].

◦ *AdS*₄

In four dimensions, some of the possible *AdS* supergroups are $OSp(\mathcal{N}|4)$ with $\mathcal{N} = 1, 2, 4$ and 8. $\mathcal{N} = 8$ is the maximal supergroup that corresponds to a supergravity theory. The $\mathcal{N} = 8$ gauged supergravity with $SO(8)$ gauge group was constructed in [133, 134]. This theory (like the other theories discussed in this section) has a highly non-trivial potential for scalar fields, whose extrema were analyzed in [135, 136]. It was shown in [137] that the extremum with $\mathcal{N} = 8$ supersymmetry corresponds to a truncation of the compactification of 11-dimensional supergravity on $AdS_4 \times S^7$. Some of the other extrema can also be identified with truncations of compactifications of the 11-dimensional theory. For a review of the 4-dimensional compactifications of 11-dimensional supergravity, see [22].

◦ *AdS*₃

Nahm's classification does not include this case since the isometry group $SO(2, 2)$ of *AdS*₃ is not a simple group but rather the direct product of two $SL(2, \mathbb{R})$ factors. The supergravity theories associated with the *AdS*₃ supergroups $OSp(p|2) \times OSp(q|2)$ were constructed in [138] and studied more recently in [139]. They can be regarded as the Chern-Simons gauge theories of gauge group $OSp(p|2) \times OSp(q|2)$. Therefore, they

are topological field theories without local degrees of freedom. The case of $p = q = 3$ is obtained, for example, by a truncation of the Kaluza-Klein compactification of the 6-dimensional $\mathcal{N} = (2, 0)$ supergravity on S^3 . In addition to $OSp(p|2)$, several other supersymmetric extensions of $SL(2, \mathbb{R})$ are known, such as:

$$SU(\mathcal{N}|1, 1), G(3), F(4), D(2, 1, \alpha). \quad (2.55)$$

Their representations are studied extensively in the context of two-dimensional superconformal field theories.

2.2.5 Consistent Truncation of Kaluza-Klein Compactifications

Despite the fact that the equations of motion for type IIB supergravity in ten dimensions are known, it turns out to be difficult to extract any simple form for the equations of motion of fluctuations around its five-dimensional Kaluza-Klein compactification on S^5 . The spectrum of this compactification is known from the work of [126, 85]. It is a general feature of compactifications involving anti-de Sitter space that the positively curved compact part has a radius of curvature on the same order as the negatively curved anti-de Sitter part. As a result, the positive $(\text{mass})^2$ of Kaluza-Klein modes is of the same order as the negative $(\text{mass})^2$ of tachyonic modes. Thus there is no low-energy limit in which one can argue that all but finitely many Kaluza-Klein harmonics decouple. This was a traditional worry for all compactifications of eleven-dimensional supergravity on squashed seven-spheres.

However, fairly compelling evidence exists ([140] and references therein) that the reduction of eleven-dimensional supergravity on S^7 can be *consistently truncated* to four-dimensional $\mathcal{N} = 8$ gauged supergravity. This is an exact statement about the equations of motion, and does not rely in any way on taking a low-energy limit. Put simply, it means that any solution of the truncated theory can be lifted to a solution of the untruncated theory. Charged black hole metrics in anti-de Sitter space provide a non-trivial example of solutions that can be lifted to the higher-dimensional theory [141, 142, 143]. There is a belief but no proof that a similar truncation may be made from ten-dimensional type IIB supergravity on S^5 to five-dimensional $\mathcal{N} = 8$ supergravity. To illustrate how radical a truncation this is, we indicate in figure 2.9 the five-dimensional scalars that are kept (this is a part of one of the figures in [126]). Note that not all of them are $SO(6)$ singlets. Indeed, the fields which are kept are precisely the superpartners of the massless graviton under the supergroup $SU(2, 2|4)$, which includes $SO(6)$ as its R-symmetry group.

The historical route to gauged supergravities was as an elaboration of the ungauged theories, and only after the fact were they argued to be related to the Kaluza-Klein reduction of higher dimensional theories on positively curved manifolds. In ungauged

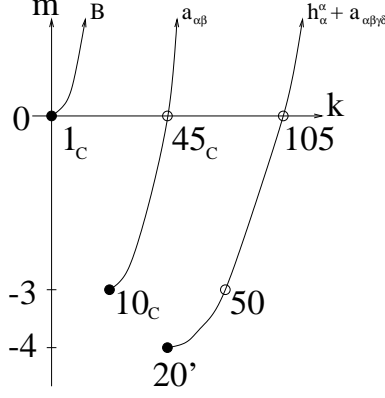

Figure 2.9: The low-lying scalar fields in the Kaluza-Klein reduction of type IIB supergravity on S^5 . The filled dots indicate fields which are kept in the truncation to gauged supergravity. We also indicate schematically the ten-dimensional origin of the scalars.

$d = 5$ $\mathcal{N} = 8$ supergravity, the scalars parametrize the coset $E_{6(6)}/USp(8)$ (following [144] we use here $USp(8)$ to denote the unitary version of the symplectic group with a four-dimensional Cartan subalgebra). The spectrum of gauged supergravity is almost the same: the only difference is that twelve of the vector fields are dualized into anti-symmetric two-forms. Schematically, we write this as

$$\begin{array}{cccccc}
 1 & 8 & 27 & 48 & 42 & \\
 g_{\mu\nu} & \psi_{\mu}^a & A_{\mu}^{ab} & \chi^{abc} & \phi^{abcd} & \\
 & & \wedge & & & \\
 & & A_{\mu IJ} & B_{\mu\nu}^{I\alpha} & & \\
 & & 15 & 12 & &
 \end{array} \tag{2.56}$$

Lower-case Roman indices are the eight-valued indices of the fundamental of $USp(8)$. Multiple $USp(8)$ indices in (2.56) are antisymmetrized and the symplectic trace parts removed. The upper-case Roman indices I, J are the six-valued indices of the vector representation of $SO(6)$, while the index α indicates a doublet of the $SL(2, \mathbb{R})$ which descends directly from the $SL(2, \mathbb{R})$ global symmetry of type IIB supergravity. These groups are embedded into $E_{6(6)}$ via the chain

$$E_{6(6)} \supset SL(6, \mathbb{R}) \times SL(2, \mathbb{R}) \supset SO(6) \times SL(2, \mathbb{R}) . \tag{2.57}$$

The key step in formulating gauged supergravities is to introduce minimal gauge couplings into the Lagrangian for all fields which are charged under the subgroup of the global symmetry group that is to be gauged. For instance, if X_I is a scalar field in the vector representation of $SO(6)$, one makes the replacement

$$\partial_{\mu} X_I \rightarrow D_{\mu} X_I = \partial_{\mu} X_I - g A_{\mu IJ} X^J \tag{2.58}$$

everywhere in the ungauged action. The gauge coupling g has dimensions of energy in five dimensions, and one can eventually show that $g = 2/R$ where R is the radius of the S^5 in the $AdS_5 \times S^5$ geometry. The replacement (2.58) spoils supersymmetry, but it was shown in [124, 123] that a supersymmetric Lagrangian can be recovered by adding terms at $O(g)$ and $O(g^2)$. The full Lagrangian and the supersymmetry transformations can be found in these references. It is a highly non-trivial claim that this action, with its beautiful non-polynomial structure in the scalar fields, represents a consistent truncation of the reduction of type IIB supergravity on S^5 . This is not entirely implausible, in view of the fact that the $SO(6)$ isometry of the S^5 becomes the local gauge symmetry of the truncated theory. Trivial examples of consistent truncation include situations where one restricts to fields which are invariant under some subgroup of the gauge group. For instance, the part of $\mathcal{N} = 8$ five-dimensional supergravity invariant under a particular $SU(2) \subset SO(6)$ is $\mathcal{N} = 4$ gauged supergravity coupled to two tensor multiplets [145]. A similar truncation to $\mathcal{N} = 6$ supergravity was considered in [146].

The $O(g^2)$ term in the Lagrangian is particularly interesting: it is a potential V for the scalars. V is an $SO(6) \times SL(2, \mathbb{R})$ invariant function on the coset manifold $E_{6(6)}/USp(8)$. It involves all the 42 scalars except the dilaton and the axion. Roughly speaking, one can think of the 40 remaining scalars as parametrizing a restricted class of deformations of the metric and 3-form fields on the S^5 , and of V as measuring the response of type IIB supergravity to these deformations. If the scalars are frozen to an extremum of V , then the value of the potential sets the cosmological constant in five dimensions. The associated conformal field theories were discussed in [147, 148, 149]. The known extrema can be classified by the subset of the $SO(6)$ global R-symmetry group that is preserved.

Chapter 3

AdS/CFT Correspondence

3.1 The Correspondence

In this section we will present an argument connecting type IIB string theory compactified on $AdS_5 \times S^5$ to $\mathcal{N} = 4$ super-Yang-Mills theory [5]. Let us start with type IIB string theory in flat, ten dimensional Minkowski space. Consider N parallel D3 branes that are sitting together or very close to each other (the precise meaning of “very close” will be defined below). The D3 branes are extended along a $(3 + 1)$ dimensional plane in $(9 + 1)$ dimensional spacetime. String theory on this background contains two kinds of perturbative excitations, closed strings and open strings. The closed strings are the excitations of empty space and the open strings end on the D-branes and describe excitations of the D-branes. If we consider the system at low energies, energies lower than the string scale $1/l_s$, then only the massless string states can be excited, and we can write an effective Lagrangian describing their interactions. The closed string massless states give a gravity supermultiplet in ten dimensions, and their low-energy effective Lagrangian is that of type IIB supergravity. The open string massless states give an $\mathcal{N} = 4$ vector supermultiplet in $(3 + 1)$ dimensions, and their low-energy effective Lagrangian is that of $\mathcal{N} = 4$ $U(N)$ super-Yang-Mills theory [9, 2].

The complete effective action of the massless modes will have the form

$$S = S_{\text{bulk}} + S_{\text{brane}} + S_{\text{int}}. \tag{3.1}$$

S_{bulk} is the action of ten dimensional supergravity, plus some higher derivative corrections. Note that the Lagrangian (3.1) involves only the massless fields but it takes into account the effects of integrating out the massive fields. It is not renormalizable (even for the fields on the brane), and it should only be understood as an effective description in the Wilsonian sense, i.e. we integrate out all massive degrees of freedom but we do not integrate out the massless ones. The brane action S_{brane} is defined on the $(3 + 1)$ dimensional brane worldvolume, and it contains the $\mathcal{N} = 4$ super-Yang-

Mills Lagrangian plus some higher derivative corrections, for example terms of the form $\alpha'^2 \text{Tr}(F^4)$. Finally, S_{int} describes the interactions between the brane modes and the bulk modes. The leading terms in this interaction Lagrangian can be obtained by covariantizing the brane action, introducing the background metric for the brane [150].

We can expand the bulk action as a free quadratic part describing the propagation of free massless modes (including the graviton), plus some interactions which are proportional to positive powers of the square root of the Newton constant. Schematically we have

$$S_{\text{bulk}} \sim \frac{1}{2\kappa^2} \int \sqrt{g} \mathcal{R} \sim \int (\partial h)^2 + \kappa (\partial h)^2 h + \dots, \quad (3.2)$$

where we have written the metric as $g = \eta + \kappa h$. We indicate explicitly the dependence on the graviton, but the other terms in the Lagrangian, involving other fields, can be expanded in a similar way. Similarly, the interaction Lagrangian S_{int} is proportional to positive powers of κ . If we take the low energy limit, all interaction terms proportional to κ drop out. This is the well known fact that gravity becomes free at long distances (low energies).

In order to see more clearly what happens in this low energy limit it is convenient to keep the energy fixed and send $l_s \rightarrow 0$ ($\alpha' \rightarrow 0$) keeping all the dimensionless parameters fixed, including the string coupling constant and N . In this limit the coupling $\kappa \sim g_s \alpha'^2 \rightarrow 0$, so that the interaction Lagrangian relating the bulk and the brane vanishes. In addition all the higher derivative terms in the brane action vanish, leaving just the pure $\mathcal{N} = 4$ $U(N)$ gauge theory in $3 + 1$ dimensions, which is known to be a conformal field theory. And, the supergravity theory in the bulk becomes free. So, in this low energy limit we have two decoupled systems. On the one hand we have free gravity in the bulk and on the other hand we have the four dimensional gauge theory.

Next, we consider the same system from a different point of view. D-branes are massive charged objects which act as a source for the various supergravity fields. As shown in section 1.3 we can find a D3 brane solution [58] of supergravity, of the form

$$\begin{aligned} ds^2 &= f^{-1/2} (-dt^2 + dx_1^2 + dx_2^2 + dx_3^2) + f^{1/2} (dr^2 + r^2 d\Omega_5^2), \\ F_5 &= (1 + *) dt dx_1 dx_2 dx_3 df^{-1}, \\ f &= 1 + \frac{R^4}{r^4}, \quad R^4 \equiv 4\pi g_s \alpha'^2 N. \end{aligned} \quad (3.3)$$

Note that since g_{tt} is non-constant, the energy E_p of an object as measured by an observer at a constant position r and the energy E measured by an observer at infinity are related by the redshift factor

$$E = f^{-1/4} E_p. \quad (3.4)$$

This means that the same object brought closer and closer to $r = 0$ would appear to have lower and lower energy for the observer at infinity. Now we take the low energy limit in the background described by equation (3.3). There are two kinds of low energy excitations (from the point of view of an observer at infinity). We can have massless particles propagating in the bulk region with wavelengths that becomes very large, or we can have any kind of excitation that we bring closer and closer to $r = 0$. In the low energy limit these two types of excitations decouple from each other. The bulk massless particles decouple from the near horizon region (around $r = 0$) because the low energy absorption cross section goes like $\sigma \sim \omega^3 R^8$ [10, 11], where ω is the energy. This can be understood from the fact that in this limit the wavelength of the particle becomes much bigger than the typical gravitational size of the brane (which is of order R). Similarly, the excitations that live very close to $r = 0$ find it harder and harder to climb the gravitational potential and escape to the asymptotic region. In conclusion, the low energy theory consists of two decoupled pieces, one is free bulk supergravity and the second is the near horizon region of the geometry. In the near horizon region, $r \ll R$, we can approximate $f \sim R^4/r^4$, and the geometry becomes

$$ds^2 = \frac{r^2}{R^2}(-dt^2 + dx_1^2 + dx_2^2 + dx_3^2) + R^2 \frac{dr^2}{r^2} + R^2 d\Omega_5^2, \quad (3.5)$$

which is the geometry of $AdS_5 \times S^5$.

We see that both from the point of view of a field theory of open strings living on the brane, and from the point of view of the supergravity description, we have two decoupled theories in the low-energy limit. In both cases one of the decoupled systems is supergravity in flat space. So, it is natural to identify the second system which appears in both descriptions. Thus, we are led to the conjecture that $\mathcal{N} = 4$ *U(N) super-Yang-Mills theory in 3+1 dimensions is the same as (or dual to) type IIB superstring theory on $AdS_5 \times S^5$* [5].

We could be a bit more precise about the near horizon limit and how it is being taken. Suppose that we take $\alpha' \rightarrow 0$, as we did when we discussed the field theory living on the brane. We want to keep fixed the energies of the objects in the throat (the near-horizon region) in string units, so that we can consider arbitrary excited string states there. This implies that $\sqrt{\alpha'} E_p \sim \text{fixed}$. For small α' (3.4) reduces to $E \sim E_p r / \sqrt{\alpha'}$. Since we want to keep fixed the energy measured from infinity, which is the way energies are measured in the field theory, we need to take $r \rightarrow 0$ keeping r/α' fixed. It is then convenient to define a new variable $U \equiv r/\alpha'$, so that the metric becomes

$$ds^2 = \alpha' \left[\frac{U^2}{\sqrt{4\pi g_s N}} (-dt^2 + dx_1^2 + dx_2^2 + dx_3^2) + \sqrt{4\pi g_s N} \frac{dU^2}{U^2} + \sqrt{4\pi g_s N} d\Omega_5^2 \right]. \quad (3.6)$$

This can also be seen by considering a D3 brane sitting at \vec{r} . As discussed in section

1.3 this corresponds to giving a vacuum expectation value to one of the scalars in the Yang-Mills theory. When we take the $\alpha' \rightarrow 0$ limit we want to keep the mass of the “ W -boson” fixed. This mass, which is the mass of the string stretching between the branes sitting at $\vec{r} = 0$ and the one at \vec{r} , is proportional to $U = r/\alpha'$, so this quantity should remain fixed in the decoupling limit.

A $U(N)$ gauge theory is essentially equivalent to a free $U(1)$ vector multiplet times an $SU(N)$ gauge theory, up to some \mathbb{Z}_N identifications (which affect only global issues). In the dual string theory all modes interact with gravity, so there are no decoupled modes. Therefore, the bulk AdS theory is describing the $SU(N)$ part of the gauge theory. In fact we were not precise when we said that there were two sets of excitations at low energies, the excitations in the asymptotic flat space and the excitations in the near horizon region. There are also some zero modes which live in the region connecting the “throat” (the near horizon region) with the bulk, which correspond to the $U(1)$ degrees of freedom mentioned above. The $U(1)$ vector supermultiplet includes six scalars which are related to the center of mass motion of all the branes [151]. From the AdS point of view these zero modes live at the boundary, and it looks like we might or might not decide to include them in the AdS theory. Depending on this choice we could have a correspondence to an $SU(N)$ or a $U(N)$ theory. The $U(1)$ center of mass degree of freedom is related to the topological theory of B -fields on AdS [152]; if one imposes local boundary conditions for these B -fields at the boundary of AdS one finds a $U(1)$ gauge field living at the boundary [153], as is familiar in Chern-Simons theories [25, 154]. These modes living at the boundary are sometimes called singletons (or doubletons) [155, 127, 156, 87, 88, 157, 158, 159, 160].

As we saw in section 2.2, Anti-de-Sitter space has a large group of isometries, which is $SO(4, 2)$ for the case at hand. This is the same group as the conformal group in $3+1$ dimensions. Thus, the fact that the low-energy field theory on the brane is conformal is reflected in the fact that the near horizon geometry is Anti-de-Sitter space. We also have some supersymmetries. The number of supersymmetries is twice that of the full solution (3.3) containing the asymptotic region [151]. This doubling of supersymmetries is viewed in the field theory as a consequence of superconformal invariance (section 2.2.3), since the superconformal algebra has twice as many fermionic generators as the corresponding Poincare superalgebra. We also have an $SO(6)$ symmetry which rotates the S^5 . This can be identified with the $SU(4)_R$ R-symmetry group of the field theory. In fact, the whole supergroup is the same for the $\mathcal{N} = 4$ field theory and the $AdS_5 \times S^5$ geometry, so both sides of the conjecture have the same spacetime symmetries. We will discuss in more detail the matching between the two sides of the correspondence in section 3.2.

In the above derivation the field theory is naturally defined on $\mathbb{R}^{3,1}$, but we saw in section 2.2.1 that we could also think of the conformal field theory as defined on

$S^3 \times \mathbb{R}$ by redefining the Hamiltonian. Since the isometries of AdS are in one to one correspondence with the generators of the conformal group of the field theory, we can conclude that this new Hamiltonian $\frac{1}{2}(P_0 + K_0)$ can be associated on AdS to the generator of translations in global time. This formulation of the conjecture is more useful since in the global coordinates there is no horizon. When we put the field theory on S^3 the Coulomb branch is lifted and there is a unique ground state. This is due to the fact that the scalars ϕ^I in the field theory are conformally coupled, so there is a term of the form $\int d^4x \text{Tr}(\phi^2)\mathcal{R}$ in the Lagrangian, where \mathcal{R} is the curvature of the four-dimensional space on which the theory is defined. Due to the positive curvature of S^3 this leads to a mass term for the scalars [20], lifting the moduli space.

The parameter N appears on the string theory side as the flux of the five-form Ramond-Ramond field strength on the S^5 ,

$$\int_{S^5} F_5 = N. \quad (3.7)$$

From the physics of D-branes we know that the Yang-Mills coupling is related to the string coupling through [6, 161]

$$\tau \equiv \frac{4\pi i}{g_{YM}^2} + \frac{\theta}{2\pi} = \frac{i}{g_s} + \frac{\chi}{2\pi}, \quad (3.8)$$

where we have also included the relationship of the θ angle to the expectation value of the RR scalar χ . We have written the couplings in this fashion because both the gauge theory and the string theory have an $SL(2, \mathbb{Z})$ self-duality symmetry under which $\tau \rightarrow (a\tau + b)/(c\tau + d)$ (where a, b, c, d are integers with $ad - bc = 1$). In fact, $SL(2, \mathbb{Z})$ is a conjectured strong-weak coupling duality symmetry of type IIB string theory in flat space [162], and it should also be a symmetry in the present context since all the fields that are being turned on in the $AdS_5 \times S^5$ background (the metric and the five form field strength) are invariant under this symmetry. The connection between the $SL(2, \mathbb{Z})$ duality symmetries of type IIB string theory and $\mathcal{N} = 4$ SYM was noted in [163, 164, 165]. The string theory seems to have a parameter that does not appear in the gauge theory, namely α' , which sets the string tension and all other scales in the string theory. However, this is not really a parameter in the theory if we do not compare it to other scales in the theory, since only relative scales are meaningful. In fact, only the ratio of the radius of curvature to α' is a parameter, but not α' and the radius of curvature independently. Thus, α' will disappear from any final physical quantity we compute in this theory. It is sometimes convenient, especially when one is doing gravity calculations, to set the radius of curvature to one. This can be achieved by writing the metric as $ds^2 = R^2 d\tilde{s}^2$, and rewriting everything in terms of \tilde{g} . With these conventions $G_N \sim 1/N^2$ and $\alpha' \sim 1/\sqrt{g_s N}$. This implies that any quantity calculated purely in terms of the gravity solution, without including stringy effects,

will be independent of $g_s N$ and will depend only on N . α' corrections to the gravity results give corrections which are proportional to powers of $1/\sqrt{g_s N}$.

Now, let us address the question of the validity of various approximations. The analysis of loop diagrams in the field theory shows that we can trust the perturbative analysis in the Yang-Mills theory when

$$g_{YM}^2 N \sim g_s N \sim \frac{R^4}{l_s^4} \ll 1. \quad (3.9)$$

Note that we need $g_{YM}^2 N$ to be small and not just g_{YM}^2 . On the other hand, the classical gravity description becomes reliable when the radius of curvature R of AdS and of S^5 becomes large compared to the string length,

$$\frac{R^4}{l_s^4} \sim g_s N \sim g_{YM}^2 N \gg 1. \quad (3.10)$$

We see that the gravity regime (3.10) and the perturbative field theory regime (3.9) are perfectly incompatible. In this fashion we avoid any obvious contradiction due to the fact that the two theories look very different. This is the reason that this correspondence is called a “duality”. The two theories are conjectured to be exactly the same, but when one side is weakly coupled the other is strongly coupled and vice versa. This makes the correspondence both hard to prove and useful, as we can solve a strongly coupled gauge theory via classical supergravity. Notice that in (3.9)(3.10) we implicitly assumed that $g_s < 1$. If $g_s > 1$ we can perform an $SL(2, \mathbb{Z})$ duality transformation and get conditions similar to (3.9)(3.10) but with $g_s \rightarrow 1/g_s$. So, we cannot get into the gravity regime (3.10) by taking N small ($N = 1, 2, \dots$) and g_s very large, since in that case the D-string becomes light and renders the gravity approximation invalid. Another way to see this is to note that the radius of curvature in Planck units is $R^4/l_p^4 \sim N$. So, it is always necessary, but not sufficient, to have large N in order to have a weakly coupled supergravity description.

One might wonder why the above argument was not a proof rather than a conjecture. It is not a proof because we did not treat the string theory non-perturbatively (not even non-perturbatively in α'). We could also consider different forms of the conjecture. In its weakest form the gravity description would be valid for large $g_s N$, but the full string theory on AdS might not agree with the field theory. A not so weak form would say that the conjecture is valid even for finite $g_s N$, but only in the $N \rightarrow \infty$ limit (so that the α' corrections would agree with the field theory, but the g_s corrections may not). The strong form of the conjecture, which is the most interesting one and which we will assume here, is that the two theories are exactly the same for all values of g_s and N . In this conjecture the spacetime is only required to be asymptotic to $AdS_5 \times S^5$ as we approach the boundary. In the interior we can have all kinds of

processes; gravitons, highly excited fundamental string states, D-branes, black holes, etc. Even the topology of spacetime can change in the interior. The Yang-Mills theory is supposed to effectively sum over all spacetimes which are asymptotic to $AdS_5 \times S^5$. This is completely analogous to the usual conditions of asymptotic flatness. We can have black holes and all kinds of topology changing processes, as long as spacetime is asymptotically flat. In this case asymptotic flatness is replaced by the asymptotic AdS behavior.

3.1.1 Brane Probes and Multicenter Solutions

The moduli space of vacua of the $\mathcal{N} = 4$ $U(N)$ gauge theory is $(\mathbb{R}^6)^N/S_N$, parametrizing the positions of the N branes in the six dimensional transverse space. In the supergravity solution one can replace

$$f \propto \frac{N}{r^4} \rightarrow \sum_{i=1}^N \frac{1}{|\vec{r} - \vec{r}_i|^4}, \quad (3.11)$$

and still have a solution to the supergravity equations. We see that if $|\vec{r}| \gg |\vec{r}_i|$ then the two solutions are basically the same, while when we go to $r \sim r_i$ the solution starts looking like the solution of a single brane. Of course, we cannot trust the supergravity solution for a single brane (since the curvature in Planck units is proportional to a negative power of N). What we can do is separate the N branes into groups of N_i branes with $g_s N_i \gg 1$ for all i . Then we can trust the gravity solution everywhere.

Another possibility is to separate just one brane (or a small number of branes) from a group of N branes. Then we can view this brane as a D3-brane in the AdS_5 background which is generated by the other branes (as described above). A string stretching between the brane probe and the N branes appears in the gravity description as a string stretching between the D3-brane and the horizon of AdS . This seems a bit surprising at first since the proper distance to the horizon is infinite. However, we get a finite result for the energy of this state once we remember to include the redshift factor. The D3-branes in AdS (like any D3-branes in string theory) are described at low energies by the Born-Infeld action, which is the Yang-Mills action plus some higher derivative corrections. This seems to contradict, at first sight, the fact that the dual field theory (coming from the original branes) is just the pure Yang-Mills theory. In order to understand this point more precisely let us write explicitly the bosonic part

of the Born-Infeld action for a D-3 brane in *AdS* [150],

$$S = -\frac{1}{(2\pi)^3 g_s \alpha'^2} \int d^4 x f^{-1} \left[\sqrt{-\det(\eta_{\alpha\beta} + f \partial_\alpha r \partial_\beta r + r^2 f g_{ij} \partial_\alpha \theta^i \partial_\beta \theta^j + 2\pi \alpha' \sqrt{f} F_{\alpha\beta})} - 1 \right],$$

$$f = \frac{4\pi g_s \alpha'^2 N}{r^4}, \tag{3.12}$$

where θ^i are angular coordinates on the 5-sphere. We can easily check that if we define a new coordinate $U = r/\alpha'$, then all the α' dependence drops out of this action. Since U (which has dimensions of energy) corresponds to the mass of the W bosons in this configuration, it is the natural way to express the Higgs expectation value that breaks $U(N+1)$ to $U(N) \times U(1)$. In fact, the action (3.12) is precisely the low-energy effective action in the field theory for the massless $U(1)$ degrees of freedom, that we obtain after integrating out the massive degrees of freedom (W bosons). We can expand (3.12) in powers of ∂U and we see that the quadratic term does not have any correction, which is consistent with the non-renormalization theorem for $\mathcal{N} = 4$ super-Yang-Mills [166]. The $(\partial U)^4$ term has only a one-loop correction, and this is also consistent with another non-renormalization theorem [167]. This one-loop correction can be evaluated explicitly in the gauge theory and the result agrees with the supergravity result [168]. It is possible to argue, using broken conformal invariance, that all terms in (3.12) are determined by the $(\partial U)^4$ term [5]. Since the massive degrees of freedom that we are integrating out have a mass proportional to U , the action (3.12) makes sense as long as the energies involved are much smaller than U . In particular, we need $\partial U/U \ll U$. Since (3.12) has the form $\mathcal{L}(g_s N (\partial U)^2 / U^4)$, the higher order terms in (3.12) could become important in the supergravity regime, when $g_s N \gg 1$. The Born Infeld action (3.12), as always, makes sense only when the curvature of the brane is small, but the deviations from a straight flat brane could be large. In this regime we can keep the non-linear terms in (3.12) while we still neglect the massive string modes and similar effects. Further gauge theory calculations for effective actions of D-brane probes include [169, 170, 171].

3.1.2 The Field \leftrightarrow Operator Correspondence

A conformal field theory does not have asymptotic states or an S-matrix, so the natural objects to consider are operators. For example, in $\mathcal{N} = 4$ super-Yang-Mills we have a deformation by a marginal operator which changes the value of the coupling constant. Changing the coupling constant in the field theory is related by (3.8) to changing the coupling constant in the string theory, which is then related to the expectation value of

the dilaton. The expectation value of the dilaton is set by the boundary condition for the dilaton at infinity. So, changing the gauge theory coupling constant corresponds to changing the boundary value of the dilaton. More precisely, let us denote by \mathcal{O} the corresponding operator. We can consider adding the term $\int d^4x \phi_0(\vec{x}) \mathcal{O}(\vec{x})$ to the Lagrangian (for simplicity we assume that such a term was not present in the original Lagrangian, otherwise we consider $\phi_0(\vec{x})$ to be the total coefficient of $\mathcal{O}(\vec{x})$ in the Lagrangian). According to the discussion above, it is natural to assume that this will change the boundary condition of the dilaton at the boundary of AdS to (in the coordinate system (2.31)) $\phi(\vec{x}, z)|_{z=0} = \phi_0(\vec{x})$. More precisely, as argued in [19, 20], it is natural to propose that

$$\langle e^{\int d^4x \phi_0(\vec{x}) \mathcal{O}(\vec{x})} \rangle_{CFT} = \mathcal{Z}_{string} \left[\phi(\vec{x}, z)|_{z=0} = \phi_0(\vec{x}) \right], \quad (3.13)$$

where the left hand side is the generating function of correlation functions in the field theory, i.e. ϕ_0 is an arbitrary function and we can calculate correlation functions of \mathcal{O} by taking functional derivatives with respect to ϕ_0 and then setting $\phi_0 = 0$. The right hand side is the full partition function of string theory with the boundary condition that the field ϕ has the value ϕ_0 on the boundary of AdS . Notice that ϕ_0 is a function of the four variables parametrizing the boundary of AdS_5 .

A formula like (3.13) is valid in general, for any field ϕ . Therefore, each field propagating on AdS space is in a one to one correspondence with an operator in the field theory. There is a relation between the mass of the field ϕ and the scaling dimension of the operator in the conformal field theory. Let us describe this more generally in AdS_{d+1} . The wave equation in Euclidean space for a field of mass m has two independent solutions, which behave like $z^{d-\Delta}$ and z^Δ for small z (close to the boundary of AdS), where

$$\Delta = \frac{d}{2} + \sqrt{\frac{d^2}{4} + R^2 m^2}. \quad (3.14)$$

Therefore, in order to get consistent behavior for a massive field, the boundary condition on the field in the right hand side of (3.13) should in general be changed to

$$\phi(\vec{x}, \epsilon) = \epsilon^{d-\Delta} \phi_0(\vec{x}), \quad (3.15)$$

and eventually we would take the limit where $\epsilon \rightarrow 0$. Since ϕ is dimensionless, we see that ϕ_0 has dimensions of $[\text{length}]^{\Delta-d}$ which implies, through the left hand side of (3.13), that the associated operator \mathcal{O} has dimension Δ (3.14). A more detailed derivation of this relation will be given in section 3.3, where we will verify that the two-point correlation function of the operator \mathcal{O} behaves as that of an operator of dimension Δ [19, 20]. A similar relation between fields on AdS and operators in the

field theory exists also for non-scalar fields, including fermions and tensors on AdS space.

Correlation functions in the gauge theory can be computed from (3.13) by differentiating with respect to ϕ_0 . Each differentiation brings down an insertion \mathcal{O} , which sends a ϕ particle (a closed string state) into the bulk. Feynman diagrams can be used to compute the interactions of particles in the bulk. In the limit where classical supergravity is applicable, the only diagrams that contribute are the tree-level diagrams of the gravity theory (see for instance figure 3.1).

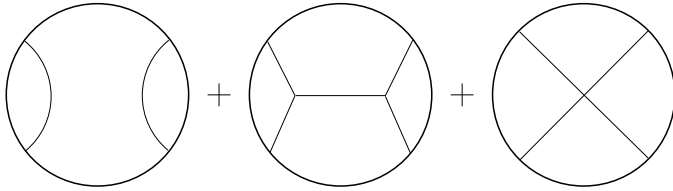

Figure 3.1: Correlation functions can be calculated (in the large $g_s N$ limit) in terms of supergravity Feynman diagrams. Here we see the leading contribution coming from a disconnected diagram plus connected pieces involving interactions of the supergravity fields in the bulk of AdS . At tree level, these diagrams and those related to them by crossing are the only ones that contribute to the four-point function.

This method of defining the correlation functions of a field theory which is dual to a gravity theory in the bulk of AdS space is quite general, and it applies in principle to any theory of gravity [20]. Any local field theory contains the stress tensor as an operator. Since the correspondence described above matches the stress-energy tensor with the graviton, this implies that the AdS theory includes gravity. It should be a well defined quantum theory of gravity since we should be able to compute loop diagrams. String theory provides such a theory. But if a new way of defining quantum gravity theories comes along we could consider those gravity theories in AdS , and they should correspond to some conformal field theory “on the boundary”. In particular, we could consider backgrounds of string theory of the form $AdS_5 \times M^5$ where M^5 is any Einstein manifold [172, 173, 174]. Depending on the choice of M^5 we get different dual conformal field theories, as discussed in section 4.1. Similarly, this discussion can be extended to any AdS_{d+1} space, corresponding to a conformal field theory in d spacetime dimensions (for $d > 1$). We will discuss examples of this in section 6.1.

3.1.3 Holography

In this section we will describe how the AdS/CFT correspondence gives a holographic description of physics in *AdS* spaces.

Let us start by explaining the Bekenstein bound, which states that the maximum entropy in a region of space is $S_{max} = \text{Area}/4G_N$ [29], where the area is that of the boundary of the region. Suppose that we had a state with more entropy than S_{max} , then we show that we could violate the second law of thermodynamics. We can throw in some extra matter such that we form a black hole. The entropy should not decrease. But if a black hole forms inside the region its entropy is just the area of its horizon, which is smaller than the area of the boundary of the region (which by our assumption is smaller than the initial entropy). So, the second law has been violated.

Note that this bound implies that the number of degrees of freedom inside some region grows as the area of the boundary of a region and not like the volume of the region. In standard quantum field theories this is certainly not possible. Attempting to understand this behavior leads to the “holographic principle”, which states that in a quantum gravity theory all physics within some volume can be described in terms of some theory on the boundary which has less than one degree of freedom per Planck area [27, 28] (so that its entropy satisfies the Bekenstein bound).

In the AdS/CFT correspondence we are describing physics in the bulk of *AdS* space by a field theory of one less dimension (which can be thought of as living on the boundary), so it looks like holography. However, it is hard to check what the number of degrees of freedom per Planck area is, since the theory, being conformal, has an infinite number of degrees of freedom, and the area of the boundary of AdS space is also infinite. Thus, in order to compare things properly we should introduce a cutoff on the number of degrees of freedom in the field theory and see what it corresponds to in the gravity theory. For this purpose let us write the metric of *AdS* as

$$ds^2 = R^2 \left[- \left(\frac{1+r^2}{1-r^2} \right)^2 dt^2 + \frac{4}{(1-r^2)^2} (dr^2 + r^2 d\Omega^2) \right]. \quad (3.16)$$

In these coordinates the boundary of *AdS* is at $r = 1$. We saw above that when we calculate correlation functions we have to specify boundary conditions at $r = 1 - \delta$ and then take the limit of $\delta \rightarrow 0$. It is clear by studying the action of the conformal group on Poincaré coordinates that the radial position plays the role of some energy scale, since we approach the boundary when we do a conformal transformation that localizes objects in the CFT. So, the limit $\delta \rightarrow 0$ corresponds to going to the UV of the field theory. When we are close to the boundary we could also use the Poincaré coordinates

$$ds^2 = R^2 \frac{-dt^2 + d\vec{x}^2 + dz^2}{z^2}, \quad (3.17)$$

in which the boundary is at $z = 0$. If we consider a particle or wave propagating in (3.17) or (3.16) we see that its motion is independent of R in the supergravity approximation. Furthermore, if we are in Euclidean space and we have a wave that has some spatial extent λ in the \vec{x} directions, it will also have an extent λ in the z direction. This can be seen from (3.17) by eliminating λ through the change of variables $x \rightarrow \lambda x, z \rightarrow \lambda z$. This implies that a cutoff at

$$z \sim \delta \tag{3.18}$$

corresponds to a UV cutoff in the field theory at distances δ , with no factors of R (δ here is dimensionless, in the field theory it is measured in terms of the radius of the S^4 or S^3 that the theory lives on). Equation (3.18) is called the UV-IR relation [175].

Consider the case of $\mathcal{N} = 4$ SYM on a three-sphere of radius one. We can estimate the number of degrees of freedom in the field theory with a UV cutoff δ . We get

$$S \sim N^2 \delta^{-3}, \tag{3.19}$$

since the number of cells into which we divide the three-sphere is of order $1/\delta^3$. In the gravity solution (3.16) the area in Planck units of the surface at $r = 1 - \delta$, for $\delta \ll 1$, is

$$\frac{\text{Area}}{4G_N} = \frac{V_{S^5} R^3 \delta^{-3}}{4G_N} \sim N^2 \delta^{-3}. \tag{3.20}$$

Thus, we see that the AdS/CFT correspondence saturates the holographic bound [175].

One could be a little suspicious of the statement that gravity in *AdS* is holographic, since it does not seem to be saying much because in *AdS* space the volume and the boundary area of a given region scale in the same fashion as we increase the size of the region. In fact, *any* field theory in *AdS* would be holographic in the sense that the number of degrees of freedom within some (large enough) volume is proportional to the area (and also to the volume). What makes this case different is that we have the additional parameter R , and then we can take *AdS* spaces of different radii (corresponding to different values of N in the SYM theory), and then we can ask whether the number of degrees of freedom goes like the volume or the area, since these have a different dependence on R .

One might get confused by the fact that the surface $r = 1 - \delta$ is really nine dimensional as opposed to four dimensional. From the form of the full metric on $AdS_5 \times S^5$ we see that as we take $\delta \rightarrow 0$ the physical size of four of the dimensions of this nine dimensional space grow, while the other five, the S^5 , remain constant. So, we see that the theory on this nine dimensional surface becomes effectively four dimensional, since we need to multiply the metric by a factor that goes to zero as we approach the boundary in order to define a finite metric for the four dimensional gauge theory.

Note that even though it is often said that the field theory is defined on the boundary of AdS , it actually describes all the physics that is going on inside AdS . When we are thinking in the AdS picture it is incorrect to consider *at the same time* an additional field theory living at the boundary¹. Different regions of AdS space, which are at different radial positions, correspond to physics at different energy scales in the field theory. It is interesting that depending on what boundary we take, \mathbb{R}^{3+1} (in the Poincaré coordinates) or $S^3 \times \mathbb{R}$ (in the global coordinates), we can either have a horizon or not have one. The presence of a horizon in the \mathbb{R}^{3+1} case is related to the fact that the theory has no mass gap and we can have excitations at arbitrarily low energies. This will always happen when we have a horizon, since by bringing a particle close to a horizon its energy becomes arbitrarily small. We are talking about the energy measured with respect to the time associated to the Killing vector that vanishes at the horizon. In the S^3 case there is no horizon, and correspondingly the theory has a gap. In this case the field theory has a discrete spectrum since it is in finite volume.

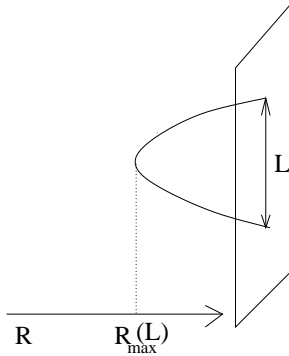

Figure 3.2: Derivation of the IR/UV relation by considering a spatial geodesic ending at two points on the boundary.

Now let us consider the UV/IR correspondence in spaces that are not AdS , like the ones which correspond to the field theories living on D - p -branes with $p \neq 3$ (see section 6.1.3). A simple derivation involves considering a classical spatial geodesic that ends on the boundary at two points separated by a distance L in field theory units (see figure 3.2). This geodesic goes into the bulk, and it has a point at which the distance to the boundary is maximal. Let us call this point $r_{max}(L)$. Then, one formulation of the UV/IR relation is

$$r = r_{max}(L) \leftrightarrow L. \quad (3.21)$$

A similar criterion arises if we consider the wave equation instead of classical geodesics

¹Except possibly for a small number of singleton fields.

[176]; of course both are the same since a classical geodesic arises as a limit of the wave equation for very massive particles.

Since the radial direction arises holographically, it is not obvious at first sight that the theory will be causal in the bulk. Issues of causality in the holographic description of the spacetime physics were discussed in [177, 178, 179, 180].

This holographic description has implications for the physics of black holes. This description should therefore explain how the singularity inside black holes should be treated (see [181]). Holography also implies that black hole evolution is unitary since the boundary theory is unitary. It is not totally clear, from the gravity point of view, how the information comes back out or where it is stored (see [182] for a discussion). Some speculations about holography and a new uncertainty principle were discussed in [183].

3.2 Tests of the AdS/CFT Correspondence

In this section we review the direct tests of the AdS/CFT correspondence. In section 3.1 we saw how string theory on AdS defines a partition function which can be used to define a field theory. Here we will review the evidence showing that this field theory is indeed the same as the conjectured dual field theory. We will focus here only on tests of the correspondence between the $\mathcal{N} = 4$ $SU(N)$ SYM theory and the type IIB string theory compactified on $AdS_5 \times S^5$; most of the tests described here can be generalized also to cases in other dimensions and/or with less supersymmetry, which will be described below.

As described in section 3.1, the AdS/CFT correspondence is a strong/weak coupling duality. In the 't Hooft large N limit, it relates the region of weak field theory coupling $\lambda = g_{YM}^2 N$ in the SYM theory to the region of high curvature (in string units) in the string theory, and vice versa. Thus, a direct comparison of correlation functions is generally not possible, since (with our current knowledge) we can only compute most of them perturbatively in λ on the field theory side and perturbatively in $1/\sqrt{\lambda}$ on the string theory side. For example, as described below, we can compute the equation of state of the SYM theory and also the quark-anti-quark potential both for small λ and for large λ , and we obtain different answers, which we do not know how to compare since we can only compute them perturbatively on both sides. A similar situation arises also in many field theory dualities that were analyzed in the last few years (such as the electric/magnetic $SL(2, \mathbb{Z})$ duality of the $\mathcal{N} = 4$ SYM theory itself), and it was realized that there are several properties of these theories which do not depend on the coupling, so they can be compared to test the duality. These are:

- The global symmetries of the theory, which cannot change as we change the

coupling (except for extreme values of the coupling). As discussed in section 3.1, in the case of the AdS/CFT correspondence we have the same supergroup $SU(2, 2|4)$ (whose bosonic subgroup is $SO(4, 2) \times SU(4)$) as the global symmetry of both theories. Also, both theories are believed to have a non-perturbative $SL(2, \mathbb{Z})$ duality symmetry acting on their coupling constant τ . These are the only symmetries of the theory on \mathbb{R}^4 . Additional \mathbb{Z}_N symmetries arise when the theories are compactified on non-simply-connected manifolds, and these were also successfully matched in [184, 152]².

- Some correlation functions, which are usually related to anomalies, are protected from any quantum corrections and do not depend on λ . The matching of these correlation functions will be described in section 3.2.2 below.
- The spectrum of chiral operators does not change as the coupling varies, and it will be compared in section 3.2.1 below.
- The moduli space of the theory also does not depend on the coupling. In the $SU(N)$ field theory the moduli space is $\mathbb{R}^{6(N-1)}/S_N$, parametrized by the eigenvalues of six commuting traceless $N \times N$ matrices. On the AdS side it is not clear exactly how to define the moduli space. As described in section 3.1.1, there is a background of string theory corresponding to any point in the field theory moduli space, but it is not clear how to see that this is the exact moduli space on the string theory side (especially since high curvatures arise for generic points in the moduli space).
- The qualitative behavior of the theory upon deformations by relevant or marginal operators also does not depend on the coupling (at least for chiral operators whose dimension does not depend on the coupling, and in the absence of phase transitions). This will be discussed in section 4.3.

There are many more qualitative tests of the correspondence, such as the existence of confinement for the finite temperature theory [185], which we will not discuss in this section. We will also not discuss here tests involving the behavior of the theory on its moduli space [169, 186, 170].

²Unlike most of the other tests described here, this test actually tests the finite N duality and not just the large N limit.

3.2.1 The Spectrum of Chiral Primary Operators

The Field Theory Spectrum

The $\mathcal{N} = 4$ supersymmetry algebra in $d = 4$ has four generators Q_α^A (and their complex conjugates $\bar{Q}_{\dot{\alpha}A}$), where α is a Weyl-spinor index (in the $\mathbf{2}$ of the $SO(3,1)$ Lorentz group) and A is an index in the $\mathbf{4}$ of the $SU(4)_R$ R-symmetry group (lower indices A will be taken to transform in the $\bar{\mathbf{4}}$ representation). They obey the algebra

$$\begin{aligned} \{Q_\alpha^A, \bar{Q}_{\dot{\alpha}B}\} &= 2(\sigma^\mu)_{\alpha\dot{\alpha}} P_\mu \delta_B^A, \\ \{Q_\alpha^A, Q_\beta^B\} &= \{\bar{Q}_{\dot{\alpha}A}, \bar{Q}_{\dot{\beta}B}\} = 0, \end{aligned} \tag{3.22}$$

where σ^i ($i = 1, 2, 3$) are the Pauli matrices and $(\sigma^0)_{\alpha\dot{\alpha}} = -\delta_{\alpha\dot{\alpha}}$ (we use the conventions of Wess and Bagger [187]).

$\mathcal{N} = 4$ supersymmetry in four dimensions has a unique multiplet which does not include spins greater than one, which is the vector multiplet. It includes a vector field A_μ (μ is a vector index of the $SO(3,1)$ Lorentz group), four complex Weyl fermions $\lambda_{\alpha A}$ (in the $\bar{\mathbf{4}}$ of $SU(4)_R$), and six real scalars ϕ^I (where I is an index in the $\mathbf{6}$ of $SU(4)_R$). The classical action of the supersymmetry generators on these fields is schematically given (for on-shell fields) by

$$\begin{aligned} [Q_\alpha^A, \phi^I] &\sim \lambda_{\alpha B}, \\ \{Q_\alpha^A, \lambda_{\beta B}\} &\sim (\sigma^{\mu\nu})_{\alpha\beta} F_{\mu\nu} + \epsilon_{\alpha\beta} [\phi^I, \phi^J], \\ \{Q_\alpha^A, \bar{\lambda}_{\dot{\beta}^B}\} &\sim (\sigma^\mu)_{\alpha\dot{\beta}} \mathcal{D}_\mu \phi^I, \\ [Q_\alpha^A, A_\mu] &\sim (\sigma_\mu)_{\alpha\dot{\alpha}} \bar{\lambda}_{\dot{\beta}^A} \epsilon^{\dot{\alpha}\dot{\beta}}, \end{aligned} \tag{3.23}$$

with similar expressions for the action of the \bar{Q} 's, where $\sigma^{\mu\nu}$ are the generators of the Lorentz group in the spinor representation, \mathcal{D}_μ is the covariant derivative, the field strength $F_{\mu\nu} \equiv [\mathcal{D}_\mu, \mathcal{D}_\nu]$, and we have suppressed the $SU(4)$ Clebsch-Gordan coefficients corresponding to the products $\mathbf{4} \times \mathbf{6} \rightarrow \bar{\mathbf{4}}, \mathbf{4} \times \bar{\mathbf{4}} \rightarrow \mathbf{1} + \mathbf{15}$ and $\mathbf{4} \times \mathbf{4} \rightarrow \mathbf{6}$ in the first three lines of (3.23).

An $\mathcal{N} = 4$ supersymmetric field theory is uniquely determined by specifying the gauge group, and its field content is a vector multiplet in the adjoint of the gauge group. Such a field theory is equivalent to an $\mathcal{N} = 2$ theory with one hypermultiplet in the adjoint representation, or to an $\mathcal{N} = 1$ theory with three chiral multiplets Φ^i in the adjoint representation (in the $\mathbf{3}_{2/3}$ of the $SU(3) \times U(1)_R \subset SU(4)_R$ which is left unbroken by the choice of a single $\mathcal{N} = 1$ SUSY generator) and a superpotential of the form $W \propto \epsilon_{ijk} \text{Tr}(\Phi^i \Phi^j \Phi^k)$. The interactions of the theory include a scalar potential proportional to $\sum_{I,J} \text{Tr}([\phi^I, \phi^J]^2)$, such that the moduli space of the theory is the space of commuting matrices ϕ^I ($I = 1, \dots, 6$).

The spectrum of operators in this theory includes all the gauge invariant quantities that can be formed from the fields described above. In this section we will focus on local operators which involve fields taken at the same point in space-time. For the $SU(N)$ theory described above, properties of the adjoint representation of $SU(N)$ determine that such operators necessarily involve a product of traces of products of fields (or the sum of such products). It is natural to divide the operators into single-trace operators and multiple-trace operators. In the 't Hooft large N limit correlation functions involving multiple-trace operators are suppressed by powers of N compared to those of single-trace operators involving the same fields. We will discuss here in detail only the single-trace operators; the multiple-trace operators appear in operator product expansions of products of single-trace operators.

As discussed in section 2.1, it is natural to classify the operators in a conformal theory into primary operators and their descendants. In a superconformal theory it is also natural to distinguish between chiral primary operators, which are in short representations of the superconformal algebra and are annihilated by some of the supercharges, and non-chiral primary operators. Representations of the superconformal algebra are formed by starting with some state of lowest dimension, which is annihilated by the operators S and K_μ , and acting on it with the operators Q and P_μ . The $\mathcal{N} = 4$ supersymmetry algebra involves 16 real supercharges. A generic primary representation of the superconformal algebra will thus include 2^{16} primaries of the conformal algebra, generated by acting on the lowest state with products of different supercharges; acting with additional supercharges always leads to descendants of the conformal algebra (i.e. derivatives). Since the supercharges have helicities $\pm 1/2$, the primary fields in such representations will have a range of helicities between $\lambda - 4$ (if the lowest dimension operator ψ has helicity λ) and $\lambda + 4$ (acting with more than 8 supercharges of the same helicity either annihilates the state or leads to a conformal descendant). In non-generic representations of the superconformal algebra a product of less than 16 different Q 's annihilates the lowest dimension operator, and the range of helicities appearing is smaller. In particular, in the small representations of the $\mathcal{N} = 4$ superconformal algebra only up to 4 Q 's of the same helicity acting on the lowest dimension operator give a non-zero result, and the range of helicities is between $\lambda - 2$ and $\lambda + 2$. For the $\mathcal{N} = 4$ supersymmetry algebra (not including the conformal algebra) it is known that medium representations, whose range of helicities is 6, can also exist (they arise, for instance, on the moduli space of the $SU(N)$ $\mathcal{N} = 4$ SYM theory [188, 189, 190, 191, 192, 193, 194, 195]); it is not clear if such medium representations of the superconformal algebra [196] can appear in physical theories or not (there are no known examples). More details on the structure of representations of the $\mathcal{N} = 4$ superconformal algebra may be found in [85, 197, 198, 199, 200, 201, 196] and references therein.

In the $U(1)$ $\mathcal{N} = 4$ SYM theory (which is a free theory), the only gauge-invariant “single trace” operators are the fields of the vector multiplet itself (which are ϕ^I , λ_A , $\bar{\lambda}^A$ and $F_{\mu\nu} = \partial_{[\mu}A_{\nu]}$). These operators form an ultra-short representation of the $\mathcal{N} = 4$ algebra whose range of helicities is from (-1) to 1 (acting with more than two supercharges of the same helicity on any of these states gives either zero or derivatives, which are descendants of the conformal algebra). All other local gauge invariant operators in the theory involve derivatives or products of these operators. This representation is usually called the doubleton representation, and it does not appear in the $SU(N)$ SYM theory (though the representations which do appear can all be formed by tensor products of the doubleton representation). In the context of AdS space one can think of this multiplet as living purely on the boundary of the space [202, 203, 204, 205, 206, 87, 86, 207, 208, 209, 210], as expected for the $U(1)$ part of the original $U(N)$ gauge group of the D3-branes (see the discussion in section 3.1).

There is no known simple systematic way to compute the full spectrum of chiral primary operators of the $\mathcal{N} = 4$ $SU(N)$ SYM theory, so we will settle for presenting the known chiral primary operators. The lowest component of a superconformal-primary multiplet is characterized by the fact that it cannot be written as a supercharge Q acting on any other operator. Looking at the action of the supersymmetry charges (3.23) suggests that generally operators built from the fermions and the gauge fields will be descendants (given by Q acting on some other fields), so one would expect the lowest components of the chiral primary representations to be built only from the scalar fields, and this turns out to be correct.

Let us analyze the behavior of operators of the form $\mathcal{O}^{I_1 I_2 \dots I_n} \equiv \text{Tr}(\phi^{I_1} \phi^{I_2} \dots \phi^{I_n})$. First we can ask if this operator can be written as $\{Q, \psi\}$ for any field ψ . In the SUSY algebra (3.23) only commutators of ϕ^I 's appear on the right hand side, so we see that if some of the indices are antisymmetric the field will be a descendant. Thus, only symmetric combinations of the indices will be lowest components of primary multiplets. Next, we should ask if the multiplet built on such an operator is a (short) chiral primary multiplet or not. There are several different ways to answer this question. One possibility is to use the relation between the dimension of chiral primary operators and their R-symmetry representation [94, 95, 96, 93, 97], and to check if this relation is obeyed in the free field theory, where $[\mathcal{O}^{I_1 I_2 \dots I_n}] = n$. In this way we find that the representation is chiral primary if and only if the indices form a symmetric traceless product of n $\mathbf{6}$'s (traceless representations are defined as those who give zero when any two indices are contracted). This is a representation of weight $(0, n, 0)$ of $SU(4)_R$; in this section we will refer to $SU(4)_R$ representations either by their dimensions in boldface or by their weights.

Another way to check this is to see if by acting with Q 's on these operators we get the most general possible states or not, namely if the representation contains “null vectors”

or not (it turns out that in all the relevant cases “null vectors” appear already at the first level by acting with a single Q , though in principle there could be representations where “null vectors” appear only at higher levels). Using the SUSY algebra (3.23) it is easy to see that for symmetric traceless representations we get “null vectors” while for other representations we do not. For instance, let us analyze in detail the case $n = 2$. The symmetric product of two $\mathbf{6}$ ’s is given by $\mathbf{6} \times \mathbf{6} \rightarrow \mathbf{1} + \mathbf{20}'$. The field in the $\mathbf{1}$ representation is $\text{Tr}(\phi^I \phi^I)$, for which $[Q_\alpha^A, \text{Tr}(\phi^I \phi^I)] \sim C^{AJB} \text{Tr}(\lambda_{\alpha B} \phi^J)$ where C^{AJB} is a Clebsch-Gordan coefficient for $\bar{\mathbf{4}} \times \mathbf{6} \rightarrow \mathbf{4}$. The right-hand side is in the $\mathbf{4}$ representation, which is the most general representation that can appear in the product $\mathbf{4} \times \mathbf{1}$, so we find no null vectors at this level. On the other hand, if we look at the symmetric traceless product $\text{Tr}(\phi^{\{I} \phi^{J\}}) \equiv \text{Tr}(\phi^I \phi^J) - \frac{1}{6} \delta^{IJ} \text{Tr}(\phi^K \phi^K)$ in the $\mathbf{20}'$ representation, we find that $\{Q_\alpha^A, \text{Tr}(\phi^{\{I} \phi^{J\}})\} \sim \text{Tr}(\lambda_{\alpha B} \phi^K)$ with the right-hand side being in the $\mathbf{20}$ representation (appearing in $\bar{\mathbf{4}} \times \mathbf{6} \rightarrow \mathbf{4} + \mathbf{20}$), while the left-hand side could in principle be in the $\mathbf{4} \times \mathbf{20}' \rightarrow \mathbf{20} + \mathbf{60}$. Since the $\mathbf{60}$ does not appear on the right-hand side (it is a “null vector”) we identify that the representation built on the $\mathbf{20}'$ is a short representation of the SUSY algebra. By similar manipulations (see [20, 211, 197, 200] for more details) one can verify that chiral primary representations correspond exactly to symmetric traceless products of $\mathbf{6}$ ’s.

It is possible to analyze the chiral primary spectrum also by using $\mathcal{N} = 1$ subalgebras of the $\mathcal{N} = 4$ algebra. If we use an $\mathcal{N} = 1$ subalgebra of the $\mathcal{N} = 4$ algebra, as described above, the operators \mathcal{O}_n include the chiral operators of the form $\text{Tr}(\Phi^{i_1} \Phi^{i_2} \dots \Phi^{i_n})$ (in a representation of $SU(3)$ which is a symmetric product of $\mathbf{3}$ ’s), but for a particular choice of the $\mathcal{N} = 1$ subalgebra not all the operators \mathcal{O}_n appear to be chiral (a short multiplet of the $\mathcal{N} = 4$ algebra includes both short and long multiplets of the $\mathcal{N} = 1$ subalgebra).

The last issue we should discuss is what is the range of values of n . The product of more than N commuting³ $N \times N$ matrices can always be written as a sum of products of traces of less than N of the matrices, so it does not form an independent operator. This means that for $n > N$ we can express the operator $\mathcal{O}^{I_1 I_2 \dots I_n}$ in terms of other operators, up to operators including commutators which (as explained above) are descendants of the SUSY algebra. Thus, we find that the short chiral primary representations are built on the operators $\mathcal{O}_n = \mathcal{O}^{\{I_1 I_2 \dots I_n\}}$ with $n = 2, 3, \dots, N$, for which the indices are in the symmetric traceless product of n $\mathbf{6}$ ’s (in a $U(N)$ theory we would find the same spectrum with the additional representation corresponding to $n = 1$). The superconformal algebra determines the dimension of these fields to be $[\mathcal{O}_n] = n$, which is the same as their value in the free field theory. We argued above

³We can limit the discussion to commuting matrices since, as discussed above, commutators always lead to descendants, and we can write any product of matrices as a product of commuting matrices plus terms with commutators.

that these are the only short chiral primary representations in the $SU(N)$ gauge theory, but we will not attempt to rigorously prove this here.

The full chiral primary representations are obtained by acting on the fields \mathcal{O}_n by the generators Q and P of the supersymmetry algebra. The representation built on \mathcal{O}_n contains a total of $256 \times \frac{1}{12}n^2(n^2 - 1)$ primary states, of which half are bosonic and half are fermionic. Since these multiplets are built on a field of helicity zero, they will contain primary fields of helicities between (-2) and 2 . The highest dimension primary field in the multiplet is (generically) of the form $Q^4\bar{Q}^4\mathcal{O}_n$, and its dimension is $n + 4$. There is an elegant way to write these multiplets as traces of products of “twisted chiral $\mathcal{N} = 4$ superfields” [211, 197]; see also [212] which checks some components of these superfields against the couplings to supergravity modes predicted on the basis of the DBI action for D3-branes in anti-de Sitter space [213].

It is easy to find the form of all the fields in such a multiplet by using the algebra (3.23). For example, let us analyze here in detail the bosonic primary fields of dimension $n + 1$ in the multiplet. To get a field of dimension $n + 1$ we need to act on \mathcal{O}_n with two supercharges (recall that $[Q] = \frac{1}{2}$). If we act with two supercharges Q_α^A of the same chirality, their Lorentz indices can be either antisymmetrized or symmetrized. In the first case we get a Lorentz scalar field in the $(2, n - 2, 0)$ representation of $SU(4)_R$, which is of the schematic form

$$\epsilon^{\alpha\beta}\{Q_\alpha, [Q_\beta, \mathcal{O}_n]\} \sim \epsilon^{\alpha\beta}\text{Tr}(\lambda_{\alpha A}\lambda_{\beta B}\phi^{J_1} \dots \phi^{J_{n-2}}) + \text{Tr}([\phi^{K_1}, \phi^{K_2}]\phi^{L_1} \dots \phi^{L_{n-1}}). \quad (3.24)$$

Using an $\mathcal{N} = 1$ subalgebra some of these operators may be written as the lowest components of the chiral superfields $\text{Tr}(W_\alpha^2\Phi^{j_1} \dots \Phi^{j_{n-2}})$. In the second case we get an anti-symmetric 2-form of the Lorentz group, in the $(0, n - 1, 0)$ representation of $SU(4)_R$, of the form

$$\{Q_{\{\alpha}, [Q_{\beta\}}, \mathcal{O}_n]\} \sim \text{Tr}((\sigma^{\mu\nu})_{\alpha\beta}F_{\mu\nu}\phi^{J_1} \dots \phi^{J_{n-1}}) + \text{Tr}(\lambda_{\alpha A}\lambda_{\beta B}\phi^{K_1} \dots \phi^{K_{n-2}}). \quad (3.25)$$

Both of these fields are complex, with the complex conjugate fields given by the action of two \bar{Q} 's. Acting with one Q and one \bar{Q} on the state \mathcal{O}_n gives a (real) Lorentz-vector field in the $(1, n - 2, 1)$ representation of $SU(4)_R$, of the form

$$\{Q_\alpha, [\bar{Q}_{\dot{\alpha}}, \mathcal{O}_n]\} \sim \text{Tr}(\lambda_{\alpha A}\bar{\lambda}_{\dot{\alpha}}^B\phi^{J_1} \dots \phi^{J_{n-2}}) + (\sigma^\mu)_{\alpha\dot{\alpha}}\text{Tr}((\mathcal{D}_\mu\phi^J)\phi^{K_1} \dots \phi^{K_{n-1}}). \quad (3.26)$$

At dimension $n + 2$ (acting with four supercharges) we find :

- A complex scalar field in the $(0, n - 2, 0)$ representation, given by $Q^4\mathcal{O}_n$, of the form $\text{Tr}(F_{\mu\nu}^2\phi^{I_1} \dots \phi^{I_{n-2}}) + \dots$.
- A real scalar field in the $(2, n - 4, 2)$ representation, given by $Q^2\bar{Q}^2\mathcal{O}_n$, of the form $\epsilon^{\alpha\beta}\epsilon^{\dot{\alpha}\dot{\beta}}\text{Tr}(\lambda_{\alpha A_1}\lambda_{\beta A_2}\bar{\lambda}_{\dot{\alpha}}^{B_1}\bar{\lambda}_{\dot{\beta}}^{B_2}\phi^{I_1} \dots \phi^{I_{n-4}}) + \dots$.

- A complex vector field in the $(1, n-4, 1)$ representation, given by $Q^3\bar{Q}\mathcal{O}_n$, of the form $\text{Tr}(F_{\mu\nu}\mathcal{D}^\nu\phi^J\phi^{I_1}\dots\phi^{I_{n-2}})+\dots$.
- An complex anti-symmetric 2-form field in the $(2, n-3, 0)$ representation, given by $Q^2\bar{Q}^2\mathcal{O}_n$, of the form $\text{Tr}(F_{\mu\nu}[\phi^{J_1},\phi^{J_2}]\phi^{I_1}\dots\phi^{I_{n-2}})+\dots$.
- A symmetric tensor field in the $(0, n-2, 0)$ representation, given by $Q^2\bar{Q}^2\mathcal{O}_n$, of the form $\text{Tr}(\mathcal{D}_{\{\mu}\phi^J\mathcal{D}_{\nu\}}\phi^K\phi^{I_1}\dots\phi^{I_{n-2}})+\dots$.

The spectrum of primary fields at dimension $n+3$ is similar to that of dimension $n+1$ (the same fields appear but in smaller $SU(4)_R$ representations), and at dimension $n+4$ there is a single primary field, which is a real scalar in the $(0, n-4, 0)$ representation, given by $Q^4\bar{Q}^4\mathcal{O}_n$, of the form $\text{Tr}(F_{\mu\nu}^4\phi^{I_1}\dots\phi^{I_{n-4}})+\dots$. Note that fields with more than four $F_{\mu\nu}$'s or more than eight λ 's are always descendants or non-chiral primaries.

For $n=2,3$ the short multiplets are even shorter since some of the representations appearing above vanish. In particular, for $n=2$ the highest-dimension primaries in the chiral primary multiplet have dimension $n+2=4$. The $n=2$ representation includes the currents of the superconformal algebra. It includes a vector of dimension 3 in the **15** representation which is the $SU(4)_R$ R-symmetry current, and a symmetric tensor field of dimension 4 which is the energy-momentum tensor (the other currents of the superconformal algebra are descendants of these). The $n=2$ multiplet also includes a complex scalar field which is an $SU(4)_R$ -singlet, whose real part is the Lagrangian density coupling to $\frac{1}{4g_{YM}^2}$ (of the form $\text{Tr}(F_{\mu\nu}^2)+\dots$) and whose imaginary part is the Lagrangian density coupling to θ (of the form $\text{Tr}(F\wedge F)$). For later use we note that the chiral primary multiplets which contain scalars of dimension $\Delta\leq 4$ are the $n=2$ multiplet (which has a scalar in the **20'** of dimension 2, a complex scalar in the **10** of dimension 3, and a complex scalar in the **1** of dimension 4), the $n=3$ multiplet (which contains a scalar in the **50** of dimension 3 and a complex scalar in the **45** of dimension 4), and the $n=4$ multiplet which contains a scalar in the **105** of dimension 4.

The String Theory Spectrum and the Matching

As discussed in section 3.1.2, fields on AdS_5 are in a one-to-one correspondence with operators in the dual conformal field theory. Thus, the spectrum of operators described in section 3.2.1 should agree with the spectrum of fields of type IIB string theory on $AdS_5\times S^5$. Fields on AdS naturally lie in the same multiplets of the conformal group as primary operators; the second Casimir of these representations is $C_2=\Delta(\Delta-4)$ for a primary scalar field of dimension Δ in the field theory, and $C_2=m^2R^2$ for a field of mass m on an AdS_5 space with a radius of curvature R . Single-trace operators in the field theory may be identified with single-particle states in AdS_5 , while multiple-trace operators correspond to multi-particle states.

Unfortunately, it is not known how to compute the full spectrum of type IIB string theory on $AdS_5 \times S^5$. In fact, the only known states are the states which arise from the dimensional reduction of the ten-dimensional type IIB supergravity multiplet. These fields all have helicities between (-2) and 2 , so it is clear that they all lie in small multiplets of the superconformal algebra, and we will describe below how they match with the small multiplets of the field theory described above. String theory on $AdS_5 \times S^5$ is expected to have many additional states, with masses of the order of the string scale $1/l_s$ or of the Planck scale $1/l_p$. Such states would correspond (using the mass/dimension relation described above) to operators in the field theory with dimensions of order $\Delta \sim (g_s N)^{1/4}$ or $\Delta \sim N^{1/4}$ for large $N, g_s N$. Presumably none of these states are in small multiplets of the superconformal algebra (at least, this would be the prediction of the AdS/CFT correspondence).

The spectrum of type IIB supergravity compactified on $AdS_5 \times S^5$ was computed in [126]. The computation involves expanding the ten dimensional fields in appropriate spherical harmonics on S^5 , plugging them into the supergravity equations of motion, linearized around the $AdS_5 \times S^5$ background, and diagonalizing the equations to give equations of motion for free (massless or massive) fields⁴. For example, the ten dimensional dilaton field τ may be expanded as $\tau(x, y) = \sum_{k=0}^{\infty} \tau^k(x) Y^k(y)$ where x is a coordinate on AdS_5 , y is a coordinate on S^5 , and the Y^k are the scalar spherical harmonics on S^5 . These spherical harmonics are in representations corresponding to symmetric traceless products of $\mathbf{6}$'s of $SU(4)_R$; they may be written as $Y^k(y) \sim y^{I_1} y^{I_2} \dots y^{I_k}$ where the y^I , for $I = 1, 2, \dots, 6$ and with $\sum_{I=1}^6 (y^I)^2 = 1$, are coordinates on S^5 . Thus, we find a field $\tau^k(x)$ on AdS_5 in each such $(0, k, 0)$ representation of $SU(4)_R$, and the equations of motion determine the mass of this field to be $m_k^2 = k(k+4)/R^2$. A similar expansion may be performed for all other fields.

If we organize the results of [126] into representations of the superconformal algebra [85], we find representations of the form described in the previous section, which are built on a lowest dimension field which is a scalar in the $(0, n, 0)$ representation of $SU(4)_R$ for $n = 2, 3, \dots, \infty$. The lowest dimension scalar field in each representation turns out to arise from a linear combination of spherical harmonic modes of the S^5 components of the graviton h_a^a (expanded around the $AdS_5 \times S^5$ vacuum) and the 4-form field D_{abcd} , where a, b, c, d are indices on S^5 . The scalar fields of dimension $n + 1$ correspond to 2-form fields B_{ab} with indices in the S^5 . The symmetric tensor fields arise from the expansion of the AdS_5 -components of the graviton. The dilaton fields described above are the complex scalar fields arising with dimension $n + 2$ in the multiplet (as described in the previous subsection).

In particular, the $n = 2$ representation is called the supergraviton representation, and

⁴The fields arising from different spherical harmonics are related by a ‘‘spectrum generating algebra’’, see [214].

it includes the field content of $d = 5, \mathcal{N} = 8$ gauged supergravity. The field/operator correspondence matches this representation to the representation including the superconformal currents in the field theory. It includes a massless graviton field, which (as expected) corresponds to the energy-momentum tensor in the field theory, and massless $SU(4)_R$ gauge fields which correspond to (or couple to) the global $SU(4)_R$ currents in the field theory.

In the naive dimensional reduction of the type IIB supergravity fields, the $n = 1$ doubleton representation, corresponding to a free $U(1)$ vector multiplet in the dual theory, also appears. However, the modes of this multiplet are all pure gauge modes in the bulk of AdS_5 , and they may be set to zero there. This is one of the reasons why it seems more natural to view the corresponding gauge theory as an $SU(N)$ gauge theory and not a $U(N)$ theory. It may be possible (and perhaps even natural) to add the doubleton representation to the theory (even though it does not include modes which propagate in the bulk of AdS_5 , but instead it is equivalent to a topological theory in the bulk) to obtain a theory which is dual to the $U(N)$ gauge theory, but this will not affect most of our discussion in this review so we will ignore this possibility here.

Comparing the results described above with the results of section 3.2.1, we see that we find the same spectrum of chiral primary operators for $n = 2, 3, \dots, N$. The supergravity results cannot be trusted for masses above the order of the string scale (which corresponds to $n \sim (g_s N)^{1/4}$) or the Planck scale (which corresponds to $n \sim N^{1/4}$), so the results agree within their range of validity. The field theory results suggest that the exact spectrum of chiral representations in type IIB string theory on $AdS_5 \times S^5$ actually matches the naive supergravity spectrum up to a mass scale $m^2 \sim N^2/R^2 \sim N^{3/2} M_p^2$ which is much higher than the string scale and the Planck scale, and that there are no chiral fields above this scale. It is not known how to check this prediction; tree-level string theory is certainly not enough for this since when $g_s = 0$ we must take $N = \infty$ to obtain a finite value of $g_s N$. Thus, with our current knowledge the matching of chiral primaries of the $\mathcal{N} = 4$ SYM theory with those of string theory on $AdS_5 \times S^5$ tests the duality only in the large N limit. In some generalizations of the AdS/CFT correspondence the string coupling goes to zero at the boundary even for finite N , and then classical string theory should lead to exactly the same spectrum of chiral operators as the field theory. This happens in particular for the near-horizon limit of NS5-branes, in which case the exact spectrum was successfully compared in [215]. In other instances of the AdS/CFT correspondence (such as the ones discussed in [216, 217, 218]) there exist also additional chiral primary multiplets with n of order N , and these have been successfully matched with wrapped branes on the string theory side.

The fact that there seem to be no non-chiral fields on AdS_5 with a mass below the string scale suggests that for large N and large $g_s N$, the dimension of all non-chiral operators in the field theory, such as $\text{Tr}(\phi^I \phi^I)$, grows at least as $(g_s N)^{1/4} \sim (g_{YM}^2 N)^{1/4}$.

The reason for this behavior on the field theory side is not clear; it is a prediction of the AdS/CFT correspondence.

3.2.2 Matching of Correlation Functions and Anomalies

The classical $\mathcal{N} = 4$ theory has a scale invariance symmetry and an $SU(4)_R$ R-symmetry, and (unlike many other theories) these symmetries are exact also in the full quantum theory. However, when the theory is coupled to external gravitational or $SU(4)_R$ gauge fields, these symmetries are broken by quantum effects. In field theory this breaking comes from one-loop diagrams and does not receive any further corrections; thus it can be computed also in the strong coupling regime and compared with the results from string theory on AdS space.

We will begin by discussing the anomaly associated with the $SU(4)_R$ global currents. These currents are chiral since the fermions $\lambda_{\alpha A}$ are in the $\bar{\mathbf{4}}$ representation while the fermions of the opposite chirality $\bar{\lambda}_{\dot{\alpha}}^A$ are in the $\mathbf{4}$ representation. Thus, if we gauge the $SU(4)_R$ global symmetry, we will find an Adler-Bell-Jackiw anomaly from the triangle diagram of three $SU(4)_R$ currents, which is proportional to the number of charged fermions. In the $SU(N)$ gauge theory this number is $N^2 - 1$. The anomaly can be expressed either in terms of the 3-point function of the $SU(4)_R$ global currents,

$$\langle J_{\mu}^a(x) J_{\nu}^b(y) J_{\rho}^c(z) \rangle_{-} = -\frac{N^2 - 1}{32\pi^6} i d^{abc} \frac{\text{Tr} [\gamma_5 \gamma_{\mu} (\not{x} - \not{y}) \gamma_{\nu} (\not{y} - \not{z}) \gamma_{\rho} (\not{z} - \not{x})]}{(x - y)^4 (y - z)^4 (z - x)^4}, \quad (3.27)$$

where $d^{abc} = 2\text{Tr}(T^a \{T^b, T^c\})$ and we take only the negative parity component of the correlator, or in terms of the non-conservation of the $SU(4)_R$ current when the theory is coupled to external $SU(4)_R$ gauge fields $F_{\mu\nu}^a$,

$$(\mathcal{D}^{\mu} J_{\mu})^a = \frac{N^2 - 1}{384\pi^2} i d^{abc} \epsilon^{\mu\nu\rho\sigma} F_{\mu\nu}^b F_{\rho\sigma}^c. \quad (3.28)$$

How can we see this effect in string theory on $AdS_5 \times S^5$? One way to see it is, of course, to use the general prescription of section 3.3 to compute the 3-point function (3.27), and indeed one finds [219, 220] the correct answer to leading order in the large N limit (namely, one recovers the term proportional to N^2). It is more illuminating, however, to consider directly the meaning of the anomaly (3.28) from the point of view of the AdS theory [20]. In the AdS theory we have gauge fields A_{μ}^a which couple, as explained above, to the $SU(4)_R$ global currents J_{μ}^a of the gauge theory, but the anomaly means that when we turn on non-zero field strengths for these fields the theory should no longer be gauge invariant. This effect is precisely reproduced by a Chern-Simons term which exists in the low-energy supergravity theory arising from the

compactification of type IIB supergravity on $AdS_5 \times S^5$, which is of the form

$$\frac{iN^2}{96\pi^2} \int_{AdS_5} d^5x (d^{abc} \epsilon^{\mu\nu\lambda\rho\sigma} A_\mu^a \partial_\nu A_\lambda^b \partial_\rho A_\sigma^c + \dots). \quad (3.29)$$

This term is gauge invariant up to total derivatives, which means that if we take a gauge transformation $A_\mu^a \rightarrow A_\mu^a + (\mathcal{D}_\mu \Lambda)^a$ for which Λ does not vanish on the boundary of AdS_5 , the action will change by a boundary term of the form

$$-\frac{iN^2}{384\pi^2} \int_{\partial AdS_5} d^4x \epsilon^{\mu\nu\rho\sigma} d^{abc} \Lambda^a F_{\mu\nu}^b F_{\rho\sigma}^c. \quad (3.30)$$

From this we can read off the anomaly in $(\mathcal{D}^\mu J_\mu)$ since, when we have a coupling of the form $\int d^4x A_\mu^a J_\mu^a$, the change in the action under a gauge transformation is given by $\int d^4x (\mathcal{D}^\mu \Lambda)_a J_\mu^a = -\int d^4x \Lambda_a (\mathcal{D}^\mu J_\mu^a)$, and we find exact agreement with (3.28) for large N .

The other anomaly in the $\mathcal{N} = 4$ SYM theory is the conformal (or Weyl) anomaly (see [221, 222] and references therein), indicating the breakdown of conformal invariance when the theory is coupled to a curved external metric (there is a similar breakdown of conformal invariance when the theory is coupled to external $SU(4)_R$ gauge fields, which we will not discuss here). The conformal anomaly is related to the 2-point and 3-point functions of the energy-momentum tensor [223, 224, 74, 225]. In four dimensions, the general form of the conformal anomaly is

$$\langle g^{\mu\nu} T_{\mu\nu} \rangle = -aE_4 - cI_4, \quad (3.31)$$

where

$$\begin{aligned} E_4 &= \frac{1}{16\pi^2} (\mathcal{R}_{\mu\nu\rho\sigma}^2 - 4\mathcal{R}_{\mu\nu}^2 + \mathcal{R}^2), \\ I_4 &= -\frac{1}{16\pi^2} (\mathcal{R}_{\mu\nu\rho\sigma}^2 - 2\mathcal{R}_{\mu\nu}^2 + \frac{1}{3}\mathcal{R}^2), \end{aligned} \quad (3.32)$$

where $\mathcal{R}_{\mu\nu\rho\sigma}$ is the curvature tensor, $\mathcal{R}_{\mu\nu} \equiv \mathcal{R}_{\mu\rho\nu}^\rho$ is the Riemann tensor, and $\mathcal{R} \equiv \mathcal{R}_\mu^\mu$ is the scalar curvature. A free field computation in the $SU(N)$ $\mathcal{N} = 4$ SYM theory leads to $a = c = (N^2 - 1)/4$. In supersymmetric theories the supersymmetry algebra relates $g^{\mu\nu} T_{\mu\nu}$ to derivatives of the R-symmetry current, so it is protected from any quantum corrections. Thus, the same result should be obtained in type IIB string theory on $AdS_5 \times S^5$, and to leading order in the large N limit it should be obtained from type IIB supergravity on $AdS_5 \times S^5$. This was indeed found to be true in [226, 227, 228, 229]⁵, where the conformal anomaly was shown to arise from subtleties in the regularization of the (divergent) supergravity action on AdS space. The result of [226, 227, 228, 229] implies that a computation using gravity on AdS_5 always gives rise to theories with

⁵A generalization with more varying fields may be found in [230].

$a = c$, so generalizations of the AdS/CFT correspondence which have (for large N) a supergravity approximation are limited to conformal theories which have $a = c$ in the large N limit. Of course, if we do not require the string theory to have a supergravity approximation then there is no such restriction.

For both of the anomalies we described the field theory and string theory computations agree for the leading terms, which are of order N^2 . Thus, they are successful tests of the duality in the large N limit. For other instances of the AdS/CFT correspondence there are corrections to anomalies at order $1/N \sim g_s(\alpha'/R^2)^2$; such corrections were discussed in [231] and successfully compared in [232, 233, 234]⁶. It would be interesting to compare other corrections to the large N result.

Computations of other correlation functions [235, 236, 237], such as 3-point functions of chiral primary operators and correlation functions which have only instanton contributions (we will discuss these in section 4.2), have suggested that they are also the same at small λ and at large λ , even though they are not related to anomalies in any known way. Perhaps there is some non-renormalization theorem also for these correlation functions, in which case their agreement would also be a test of the AdS/CFT correspondence. As discussed in [238, 239] (see also [146]) the non-renormalization theorem for 3-point functions of chiral primary operators would follow from a conjectured $U(1)_Y$ symmetry of the 3-point functions of $\mathcal{N} = 4$ SCFTs involving at least two operators which are descendants of chiral primaries⁷. This symmetry is a property of type IIB supergravity on $AdS_5 \times S^5$ but not of the full type IIB string theory.

3.3 Correlation Functions

A useful statement of the AdS/CFT correspondence is that the partition function of string theory on $AdS_5 \times S^5$ should coincide with the partition function of $\mathcal{N} = 4$ super-Yang-Mills theory “on the boundary” of AdS_5 [19, 20]. The basic idea was explained in section 3.1.2, but before summarizing the actual calculations of Green’s functions, it seems worthwhile to motivate the methodology from a somewhat different perspective.

Throughout this section, we approximate the string theory partition function by $e^{-I_{SUGRA}}$, where I_{SUGRA} is the supergravity action evaluated on $AdS_5 \times S^5$ (or on small deformations of this space). This approximation amounts to ignoring all the stringy α' corrections that cure the divergences of supergravity, and also all the loop corrections, which are controlled essentially by the gravitational coupling $\kappa \sim g_{st}\alpha'^2$. On the gauge

⁶Computing such corrections tests the conjecture that the correspondence holds order by order in $1/N$; however, this is weaker than the statement that the correspondence holds for finite N , since the $1/N$ expansion is not expected to converge.

⁷A proof of this, using the analytic harmonic superspace formalism which is conjectured to be valid in the $\mathcal{N} = 4$ theory, was recently given in [240].

theory side, as explained in section 3.1.2, this approximation amounts to taking both N and $g_{YM}^2 N$ large, and the basic relation becomes

$$e^{-I_{SUGRA}} \simeq Z_{\text{string}} = Z_{\text{gauge}} = e^{-W} , \quad (3.33)$$

where W is the generating functional for connected Green's functions in the gauge theory. At finite temperature, $W = \beta F$ where β is the inverse temperature and F is the free energy of the gauge theory. When we apply this relation to a Schwarzschild black hole in AdS_5 , which is thought to be reflected in the gauge theory by a thermal state at the Hawking temperature of the black hole, we arrive at the relation $I_{SUGRA} \simeq \beta F$. Calculating the free energy of a black hole from the Euclidean supergravity action has a long tradition in the supergravity literature [241], so the main claim that is being made here is that the dual gauge theory provides a description of the state of the black hole which is physically equivalent to the one in string theory. We will discuss the finite temperature case further in section 3.6, and devote the rest of this section to the partition function of the field theory on \mathbb{R}^4 .

The main technical idea behind the bulk-boundary correspondence is that the boundary values of string theory fields (in particular, supergravity fields) act as sources for gauge-invariant operators in the field theory. From a D-brane perspective, we think of closed string states in the bulk as sourcing gauge singlet operators on the brane which originate as composite operators built from open strings. We will write the bulk fields generically as $\phi(\vec{x}, z)$ (in the coordinate system (3.17)), with value $\phi_0(\vec{x})$ for $z = \epsilon$. The true boundary of anti-de Sitter space is $z = 0$, and $\epsilon \neq 0$ serves as a cutoff which will eventually be removed. In the supergravity approximation, we think of choosing the values ϕ_0 arbitrarily and then extremizing the action $I_{SUGRA}[\phi]$ in the region $z > \epsilon$ subject to these boundary conditions. In short, we solve the equations of motion in the bulk subject to Dirichlet boundary conditions on the boundary, and evaluate the action on the solution. If there is more than one solution, then we have more than one saddle point contributing to the string theory partition function, and we must determine which is most important. In this section, multiple saddle points will not be a problem. So, we can write

$$W_{\text{gauge}}[\phi_0] = -\log \left\langle e^{\int d^4x \phi_0(x) \mathcal{O}(x)} \right\rangle_{CFT} \simeq \underset{\phi|_{z=\epsilon}=\phi_0}{\text{extremum}} I_{SUGRA}[\phi] . \quad (3.34)$$

That is, the generator of connected Green's functions in the gauge theory, in the large N , $g_{YM}^2 N$ limit, is the on-shell supergravity action.

Note that in (3.34) we have not attempted to be prescient about inserting factors of ϵ . Instead our strategy will be to use (3.34) without modification to compute two-point functions of \mathcal{O} , and then perform a wave-function renormalization on either \mathcal{O} or ϕ so that the final answer is independent of the cutoff. This approach should be

workable even in a space (with boundary) which is not asymptotically anti-de Sitter, corresponding to a field theory which does not have a conformal fixed point in the ultraviolet.

A remark is in order regarding the relation of (3.34) to the old approach of extracting Green's functions from an absorption cross-section [12]. In absorption calculations one is keeping the whole D3-brane geometry, not just the near-horizon $AdS_5 \times S^5$ throat. The usual treatment is to split the space into a near region (the throat) and a far region. The incoming wave from asymptotically flat infinity can be regarded as fixing the value of a supergravity field at the outer boundary of the near region. As usual, the supergravity description is valid at large N and large 't Hooft coupling. At small 't Hooft coupling, there is a different description of the process: a cluster of D3-branes sits at some location in flat ten-dimensional space, and the incoming wave impinges upon it. In the low-energy limit, the value of the supergravity field which the D3-branes feel is the same as the value in the curved space description at the boundary of the near horizon region. Equation (3.34) is just a mathematical expression of the fact that the throat geometry should respond identically to the perturbed supergravity fields as the low-energy theory on the D3-branes.

Following [19, 20], a number of papers—notably [242, 243, 219, 244, 220, 245, 246, 235, 247, 236, 248, 249, 250, 251, 252, 253, 254]—have undertaken the program of extracting explicit n -point correlation functions of gauge singlet operators by developing both sides of (3.34) in a power series in ϕ_0 . Because the right hand side is the extremization of a classical action, the power series has a graphical representation in terms of tree-level Feynman graphs for fields in the supergravity. There is one difference: in ordinary Feynman graphs one assigns the wavefunctions of asymptotic states to the external legs of the graph, but in the present case the external leg factors reflect the boundary values ϕ_0 . They are special limits of the usual gravity propagators in the bulk, and are called bulk-to-boundary propagators. We will encounter their explicit form in the next two sections.

3.3.1 Two-point Functions

For two-point functions, only the part of the action which is quadratic in the relevant field perturbation is needed. For massive scalar fields in AdS_5 , this has the generic form

$$S = \eta \int d^5x \sqrt{g} \left[\frac{1}{2}(\partial\phi)^2 + \frac{1}{2}m^2\phi^2 \right], \quad (3.35)$$

where η is some normalization which in principle follows from the ten-dimensional origin of the action. The bulk-to-boundary propagator is a particular solution of the equation of motion, $(\square - m^2)\phi = 0$, which has special asymptotic properties. We will start by considering the momentum space propagator, which is useful for computing

the two-point function and also in situations where the bulk geometry loses conformal invariance; then, we will discuss the position space propagator, which has proven more convenient for the study of higher point correlators in the conformal case. We will always work in Euclidean space⁸. A coordinate system in the bulk of AdS_5 such that

$$ds^2 = \frac{R^2}{z^2} (d\vec{x}^2 + dz^2) \quad (3.36)$$

provides manifest Euclidean symmetry on the directions parametrized by \vec{x} . To avoid divergences associated with the small z region of integration in (3.35), we will employ an explicit cutoff, $z \geq \epsilon$.

A complete set of solutions for the linearized equation of motion, $(\square - m^2)\phi = 0$, is given by $\phi = e^{i\vec{p}\cdot\vec{x}}Z(pz)$, where the function $Z(u)$ satisfies the radial equation

$$\left[u^5 \partial_u \frac{1}{u^3} \partial_u - u^2 - m^2 R^2 \right] Z(u) = 0 . \quad (3.37)$$

There are two independent solutions to (3.37), namely $Z(u) = u^2 I_{\Delta-2}(u)$ and $Z(u) = u^2 K_{\Delta-2}(u)$, where I_ν and K_ν are Bessel functions and

$$\Delta = 2 + \sqrt{4 + m^2 R^2} . \quad (3.38)$$

The second solution is selected by the requirement of regularity in the interior: $I_{\Delta-2}(u)$ increases exponentially as $u \rightarrow \infty$ and does not lead to a finite action configuration⁹. Imposing the boundary condition $\phi(\vec{x}, z) = \phi_0(\vec{x}) = e^{i\vec{p}\cdot\vec{x}}$ at $z = \epsilon$, we find the bulk-to-boundary propagator

$$\phi(\vec{x}, z) = K_{\vec{p}}(\vec{x}, z) = \frac{(pz)^2 K_{\Delta-2}(pz)}{(p\epsilon)^2 K_{\Delta-2}(p\epsilon)} e^{i\vec{p}\cdot\vec{x}} . \quad (3.39)$$

To compute a two-point function of the operator \mathcal{O} for which ϕ_0 is a source, we write

$$\begin{aligned} \langle \mathcal{O}(\vec{p}) \mathcal{O}(\vec{q}) \rangle &= \left. \frac{\partial^2 W [\phi_0 = \lambda_1 e^{i\vec{p}\cdot\vec{x}} + \lambda_2 e^{i\vec{q}\cdot\vec{x}}]}{\partial \lambda_1 \partial \lambda_2} \right|_{\lambda_1 = \lambda_2 = 0} \\ &= (\text{leading analytic terms in } (\epsilon p)^2) \\ &\quad - \eta \epsilon^{2\Delta-8} (2\Delta - 4) \frac{\Gamma(3 - \Delta)}{\Gamma(\Delta - 1)} \delta^4(\vec{p} + \vec{q}) \left(\frac{\vec{p}}{2} \right)^{2\Delta-4} \\ &\quad + (\text{higher order terms in } (\epsilon p)^2), \\ \langle \mathcal{O}(\vec{x}) \mathcal{O}(\vec{y}) \rangle &= \eta \epsilon^{2\Delta-8} \frac{2\Delta - 4}{\Delta} \frac{\Gamma(\Delta + 1)}{\pi^2 \Gamma(\Delta - 2)} \frac{1}{|\vec{x} - \vec{y}|^{2\Delta}} . \end{aligned} \quad (3.40)$$

Several explanatory remarks are in order:

⁸The results may be analytically continued to give the correlation functions of the field theory on Minkowskian \mathbb{R}^4 , which corresponds to the Poincaré coordinates of AdS space.

⁹Note that this solution, when continued to Lorentzian AdS space, generally involves the non-normalizable mode of the field, with λ_- in (2.34).

- To establish the second equality in (3.40) we have used (3.39), substituted in (3.35), performed the integral and expanded in ϵ . The leading analytic terms give rise to contact terms in position space, and the higher order terms are unimportant in the limit where we remove the cutoff. Only the leading nonanalytic term is essential. We have given the expression for generic real values of Δ . Expanding around integer $\Delta \geq 2$ one obtains finite expressions involving $\log \epsilon p$.
- The Fourier transforms used to obtain the last line are singular, but they can be defined for generic complex Δ by analytic continuation and for positive integer Δ by expanding around a pole and dropping divergent terms, in the spirit of differential regularization [255]. The result is a pure power law dependence on the separation $|\vec{x} - \vec{y}|$, as required by conformal invariance.
- We have assumed a coupling $\int d^4x \phi(\vec{x}, z = \epsilon) \mathcal{O}(\vec{x})$ to compute the Green's functions. The explicit powers of the cutoff in the final position space answer can be eliminated by absorbing a factor of $\epsilon^{\Delta-4}$ into the definition of \mathcal{O} . From here on we will take that convention, which amounts to inserting a factor of $\epsilon^{4-\Delta}$ on the right hand side of (3.39). In fact, precise matchings between the normalizations in field theory and in string theory for all the chiral primary operators have not been worked out. In part this is due to the difficulty of determining the coupling of bulk fields to field theory operators (or in stringy terms, the coupling of closed string states to composite open string operators on the brane). See [11] for an early approach to this problem. For the dilaton, the graviton, and their superpartners (including gauge fields in AdS_5), the couplings can be worked out explicitly. In some of these cases all normalizations have been worked out unambiguously and checked against field theory predictions (see for example [19, 219, 236]).
- The mass-dimension relation (3.38) holds even for string states that are not included in the Kaluza-Klein supergravity reduction: the mass and the dimension are just different expressions of the second Casimir of $SO(4,2)$. For instance, excited string states, with $m \sim 1/\sqrt{\alpha'}$, are expected to correspond to operators with dimension $\Delta \sim (g_{YM}^2 N)^{1/4}$. The remarkable fact is that all the string theory modes with $m \sim 1/R$ (which is to say, all closed string states which arise from massless ten dimensional fields) fall in short multiplets of the supergroup $SU(2,2|4)$. All other states have a much larger mass. The operators in short multiplets have algebraically protected dimensions. The obvious conclusion is that all operators whose dimensions are not algebraically protected have large dimension in the strong 't Hooft coupling, large N limit to which supergravity applies. This is no longer true for theories of reduced supersymmetry: the supergroup gets smaller, but the Kaluza-Klein states are roughly as numerous as

before, and some of them escape the short multiplets and live in long multiplets of the smaller supergroups. They still have a mass on the order of $1/R$, and typically correspond to dimensions which are finite (in the large $g_{YM}^2 N$ limit) but irrational.

Correlation functions of non-scalar operators have been widely studied following [20]; the literature includes [256, 257, 258, 259, 260, 261, 262, 263, 264, 265, 266]. For $\mathcal{N} = 4$ super-Yang-Mills theory, all correlation functions of fields in chiral multiplets should follow by application of supersymmetries once those of the chiral primary fields are known, so in this case it should be enough to study the scalars. It is worthwhile to note however that the mass-dimension formula changes for particles with spin. In fact the definition of mass has some convention-dependence. Conventions seem fairly uniform in the literature, and a table of mass-dimension relations in AdS_{d+1} with unit radius was made in [145] from the various sources cited above (see also [211]):

- scalars: $\Delta_{\pm} = \frac{1}{2}(d \pm \sqrt{d^2 + 4m^2})$,
- spinors: $\Delta = \frac{1}{2}(d + 2|m|)$,
- vectors: $\Delta_{\pm} = \frac{1}{2}(d \pm \sqrt{(d-2)^2 + 4m^2})$,
- p -forms: $\Delta = \frac{1}{2}(d \pm \sqrt{(d-2p)^2 + 4m^2})$,
- first-order $(d/2)$ -forms (d even): $\Delta = \frac{1}{2}(d + 2|m|)$,
- spin-3/2: $\Delta = \frac{1}{2}(d + 2|m|)$,
- massless spin-2: $\Delta = d$.

In the case of fields with second order lagrangians, we have not attempted to pick which of Δ_{\pm} is the physical dimension. Usually the choice $\Delta = \Delta_+$ is clear from the unitarity bound, but in some cases (notably $m^2 = 15/4$ in AdS_5) there is a genuine ambiguity. In practice this ambiguity is usually resolved by appealing to some special algebraic property of the relevant fields, such as transformation under supersymmetry or a global bosonic symmetry. See section 2.2.2 for further discussion. The scalar case above is precisely equation (2.36) in that section.

For brevity we will omit a further discussion of higher spins, and instead refer the reader to the (extensive) literature.

3.3.2 Three-point Functions

Working with bulk-to-boundary propagators in the momentum representation is convenient for two-point functions, but for higher point functions position space is preferred

because the full conformal invariance is more obvious. (However, for non-conformal examples of the bulk-boundary correspondence, the momentum representation seems uniformly more convenient). The boundary behavior of position space bulk-to-boundary propagators is specified in a slightly more subtle way: following [219] we require

$$K_{\Delta}(\vec{x}, z; \vec{y}) \rightarrow z^{4-\Delta} \delta^4(\vec{x} - \vec{y}) \quad \text{as } z \rightarrow 0. \quad (3.41)$$

Here \vec{y} is the point on the boundary where we insert the operator, and (\vec{x}, z) is a point in the bulk. The unique regular K_{Δ} solving the equation of motion and satisfying (3.41) is

$$K_{\Delta}(\vec{x}, z; \vec{y}) = \frac{\Gamma(\Delta)}{\pi^2 \Gamma(\Delta - 2)} \left(\frac{z}{z^2 + (\vec{x} - \vec{y})^2} \right)^{\Delta}. \quad (3.42)$$

At a fixed cutoff, $z = \epsilon$, the bulk-to-boundary propagator $K_{\Delta}(\vec{x}, \epsilon; \vec{y})$ is a continuous function which approximates $\epsilon^{4-\Delta} \delta^4(\vec{x} - \vec{y})$ better and better as $\epsilon \rightarrow 0$. Thus at any finite ϵ , the Fourier transform of (3.42) only approximately coincides with (3.39) (modified by the factor of $\epsilon^{4-\Delta}$ as explained after (3.40)). This apparently innocuous subtlety turned out to be important for two-point functions, as discovered in [219]. A correct prescription is to specify boundary conditions at finite $z = \epsilon$, cut off all bulk integrals at that boundary, and only afterwards take $\epsilon \rightarrow 0$. That is what we have done in (3.40). Calculating two-point functions directly using the position-space propagators (3.41), but cutting the bulk integrals off again at ϵ , and finally taking the same $\epsilon \rightarrow 0$ answer, one arrives at a different answer. This is not surprising since the $z = \epsilon$ boundary conditions were not used consistently. The authors of [219] checked that using the cutoff consistently (i.e. with the momentum space propagators) gave two-point functions $\langle \mathcal{O}(\vec{x}_1) \mathcal{O}(\vec{x}_2) \rangle$ a normalization such that Ward identities involving the three-point function $\langle \mathcal{O}(\vec{x}_1) \mathcal{O}(\vec{x}_2) J_{\mu}(\vec{x}_3) \rangle$, where J_{μ} is a conserved current, were obeyed. Two-point functions are uniquely difficult because of the poor convergence properties of the integrals over z . The integrals involved in three-point functions are sufficiently benign that one can ignore the issue of how to impose the cutoff.

If one has a Euclidean bulk action for three scalar fields ϕ_1, ϕ_2 , and ϕ_3 , of the form

$$S = \int d^5x \sqrt{g} \left[\sum_i \frac{1}{2} (\partial \phi_i)^2 + \frac{1}{2} m_i^2 \phi_i^2 + \lambda \phi_1 \phi_2 \phi_3 \right], \quad (3.43)$$

and if the ϕ_i couple to operators in the field theory by interaction terms $\int d^4x \phi_i \mathcal{O}_i$, then the calculation of $\langle \mathcal{O}_1 \mathcal{O}_2 \mathcal{O}_3 \rangle$ reduces, via (3.34), to the evaluation of the graph shown in figure 3.3. That is,

$$\begin{aligned} \langle \mathcal{O}_1(\vec{x}_1) \mathcal{O}_2(\vec{x}_2) \mathcal{O}_3(\vec{x}_3) \rangle &= -\lambda \int d^5x \sqrt{g} K_{\Delta_1}(x; \vec{x}_1) K_{\Delta_2}(x; \vec{x}_2) K_{\Delta_3}(x; \vec{x}_3) \\ &= \frac{\lambda a_1}{|\vec{x}_1 - \vec{x}_2|^{\Delta_1 + \Delta_2 - \Delta_3} |\vec{x}_1 - \vec{x}_3|^{\Delta_1 + \Delta_3 - \Delta_2} |\vec{x}_2 - \vec{x}_3|^{\Delta_2 + \Delta_3 - \Delta_1}}, \end{aligned} \quad (3.44)$$

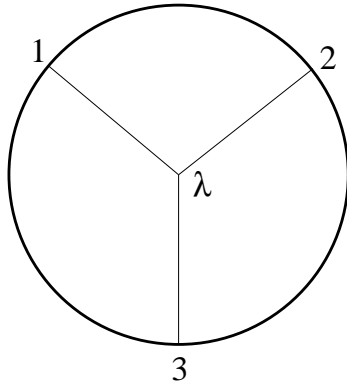

Figure 3.3: The Feynman graph for the three-point function as computed in supergravity. The legs correspond to factors of K_{Δ_i} , and the cubic vertex to a factor of λ . The position of the vertex is integrated over AdS_5 .

for some constant a_1 . The dependence on the \vec{x}_i is dictated by the conformal invariance, but the only way to compute a_1 is by performing the integral over x . The result [219] is

$$a_1 = -\frac{\Gamma\left[\frac{1}{2}(\Delta_1 + \Delta_2 - \Delta_3)\right] \Gamma\left[\frac{1}{2}(\Delta_1 + \Delta_3 - \Delta_2)\right] \Gamma\left[\frac{1}{2}(\Delta_2 + \Delta_3 - \Delta_1)\right]}{2\pi^4 \Gamma(\Delta_1 - 2) \Gamma(\Delta_2 - 2) \Gamma(\Delta_3 - 2)} \Gamma\left[\frac{1}{2}(\Delta_1 + \Delta_2 + \Delta_3) - 2\right]. \quad (3.45)$$

In principle one could also have couplings of the form $\phi_1 \partial \phi_2 \partial \phi_3$. This leads only to a modification of the constant a_1 .

The main technical difficulty with three-point functions is that one must figure out the cubic couplings of supergravity fields. Because of the difficulties in writing down a covariant action for type IIB supergravity in ten dimensions (see however [267, 268, 269]), it is most straightforward to read off these “cubic couplings” from quadratic terms in the equations of motion. In flat ten-dimensional space these terms can be read off directly from the original type IIB supergravity papers [125, 270]. For $AdS_5 \times S^5$, one must instead expand in fluctuations around the background metric and five-form field strength. The old literature [126] only dealt with the linearized equations of motion; for 3-point functions it is necessary to go to one higher order of perturbation theory. This was done for a restricted set of fields in [235]. The fields considered were those dual to operators of the form $\text{Tr} \phi^{(J_1} \phi^{J_2} \dots \phi^{J_\ell)}$ in field theory, where the parentheses indicate a symmetrized traceless product. These operators are the chiral primaries of the gauge theory: all other single trace operators of protected dimension descend from these by commuting with supersymmetry generators. Only the metric and the five-form are involved in the dual supergravity fields, and we are interested only in modes which are scalars in AdS_5 . The result of [235] is that the equations of

motion for the scalar modes \tilde{s}_I dual to

$$\mathcal{O}^I = \mathcal{C}_{J_1 \dots J_\ell}^I \text{Tr} \phi^{(J_1} \dots \phi^{J_\ell)} \quad (3.46)$$

follow from an action of the form

$$S = \frac{4N^2}{(2\pi)^5} \int d^5x \sqrt{g} \left\{ \sum_I \frac{A_I (w^I)^2}{2} [-(\nabla \tilde{s}_I)^2 - l(l-4)\tilde{s}_I^2] \right. \\ \left. + \sum_{I_1, I_2, I_3} \frac{\mathcal{G}_{I_1 I_2 I_3} w^{I_1} w^{I_2} w^{I_3}}{3} \tilde{s}_{I_1} \tilde{s}_{I_2} \tilde{s}_{I_3} \right\}. \quad (3.47)$$

Derivative couplings of the form $\tilde{s} \partial \tilde{s} \partial \tilde{s}$ are expected *a priori* to enter into (3.47), but an appropriate field redefinition eliminates them. The notation in (3.46) and (3.47) requires some explanation. I is an index which runs over the weight vectors of all possible representations constructed as symmetric traceless products of the $\mathbf{6}$ of $SU(4)_R$. These are the representations whose Young diagrams are $\square, \square\square, \square\square\square, \dots, \mathcal{C}_{J_1 \dots J_\ell}^I$ is a basis transformation matrix, chosen so that $\mathcal{C}_{J_1 \dots J_\ell}^I \mathcal{C}_{J_1 \dots J_\ell}^J = \delta^{IJ}$. As commented in the previous section, there is generally a normalization ambiguity on how supergravity fields couple to operators in the gauge theory. We have taken the coupling to be $\int d^4x \tilde{s}_I \mathcal{O}^I$, and the normalization ambiguity is represented by the “leg factors” w^I . It is the combination $s^I = w^I \tilde{s}^I$ rather than \tilde{s}^I itself which has a definite relation to supergravity fields. We refer the reader to [235] for explicit expressions for A_I and the symmetric tensor $\mathcal{G}_{I_1 I_2 I_3}$. To get rid of factors of w^I , we introduce operators $\mathcal{O}^I = \tilde{w}^I \mathcal{O}^I$. One can choose \tilde{w}^I so that a two-point function computation along the lines of section 3.3.1 leads to

$$\langle \mathcal{O}^{I_1}(\vec{x}) \mathcal{O}^{I_2}(0) \rangle = \frac{\delta^{I_1 I_2}}{x^{2\Delta_1}}. \quad (3.48)$$

With this choice, the three-point function, as calculated using (3.44), is

$$\langle \mathcal{O}^{I_1}(\vec{x}_1) \mathcal{O}^{I_2}(\vec{x}_2) \mathcal{O}^{I_3}(\vec{x}_3) \rangle = \frac{1}{N} \frac{\sqrt{\Delta_1 \Delta_2 \Delta_3} \langle \mathcal{C}^{I_1} \mathcal{C}^{I_2} \mathcal{C}^{I_3} \rangle}{|\vec{x}_1 - \vec{x}_2|^{\Delta_1 + \Delta_2 - \Delta_3} |\vec{x}_1 - \vec{x}_3|^{\Delta_1 + \Delta_3 - \Delta_2} |\vec{x}_2 - \vec{x}_3|^{\Delta_2 + \Delta_3 - \Delta_1}}, \quad (3.49)$$

where we have defined

$$\langle \mathcal{C}^{I_1} \mathcal{C}^{I_2} \mathcal{C}^{I_3} \rangle = \mathcal{C}_{J_1 \dots J_i K_1 \dots K_j}^{I_1} \mathcal{C}_{J_1 \dots J_i L_1 \dots L_k}^{I_2} \mathcal{C}_{K_1 \dots K_j L_1 \dots L_k}^{I_3}. \quad (3.50)$$

Remarkably, (3.49) is the same result one obtains from free field theory by Wick contracting all the ϕ^J fields in the three operators. This suggests that there is a non-renormalization theorem for this correlation function, but such a theorem has not yet been proven (see however comments at the end of section 3.2.2). It is worth emphasizing that the normalization ambiguity in the bulk-boundary coupling is circumvented essentially by considering invariant ratios of three-point functions and two-point functions, into which the “leg factors” w^I do not enter. This is the same strategy as was pursued in comparing matrix models of quantum gravity to Liouville theory.

3.3.3 Four-point Functions

The calculation of four-point functions is difficult because there are several graphs which contribute, and some of them inevitably involve bulk-to-bulk propagators of fields with spin. The computation of four-point functions of the operators \mathcal{O}_ϕ and \mathcal{O}_C dual to the dilaton and the axion was completed in [271]. See also [243, 247, 248, 249, 272, 273, 252, 250, 274, 275] for earlier contributions. One of the main technical results, further developed in [276], is that diagrams involving an internal propagator can be reduced by integration over one of the bulk vertices to a sum of quartic graphs expressible in terms of the functions

$$D_{\Delta_1\Delta_2\Delta_3\Delta_4}(\vec{x}_1, \vec{x}_2, \vec{x}_3, \vec{x}_4) = \int d^5x \sqrt{g} \prod_{i=1}^4 \tilde{K}_{\Delta_i}(\vec{x}, z; \vec{x}_i), \quad (3.51)$$

$$\tilde{K}_\Delta(\vec{x}, z; \vec{y}) = \left(\frac{z}{z^2 + (\vec{x} - \vec{y})^2} \right)^\Delta.$$

The integration is over the bulk point (\vec{x}, z) . There are two independent conformally invariant combinations of the \vec{x}_i :

$$s = \frac{1}{2} \frac{\vec{x}_{13}^2 \vec{x}_{24}^2}{\vec{x}_{12}^2 \vec{x}_{34}^2 + \vec{x}_{14}^2 \vec{x}_{23}^2} \quad t = \frac{\vec{x}_{12}^2 \vec{x}_{34}^2 - \vec{x}_{14}^2 \vec{x}_{23}^2}{\vec{x}_{12}^2 \vec{x}_{34}^2 + \vec{x}_{14}^2 \vec{x}_{23}^2}. \quad (3.52)$$

One can write the connected four-point function as

$$\begin{aligned} \langle \mathcal{O}_\phi(\vec{x}_1) \mathcal{O}_C(\vec{x}_2) \mathcal{O}_\phi(\vec{x}_3) \mathcal{O}_C(\vec{x}_4) \rangle &= \left(\frac{6}{\pi^2} \right)^4 \left[16 \vec{x}_{24}^2 \left(\frac{1}{2s} - 1 \right) D_{4455} + \frac{64 \vec{x}_{24}^2}{9 \vec{x}_{13}^2} \frac{1}{s} D_{3355} \right. \\ &\quad \left. + \frac{16 \vec{x}_{24}^2}{3 \vec{x}_{13}^2} \frac{1}{s} D_{2255} - 14 D_{4444} - \frac{46}{9 \vec{x}_{13}^2} D_{3344} - \frac{40}{9 \vec{x}_{13}^2} D_{2244} - \frac{8}{3 \vec{x}_{13}^6} D_{1144} + 64 \vec{x}_{24}^2 D_{4455} \right]. \end{aligned} \quad (3.53)$$

An interesting limit of (3.53) is to take two pairs of points close together. Following [271], let us take the pairs (\vec{x}_1, \vec{x}_3) and (\vec{x}_2, \vec{x}_4) close together while holding \vec{x}_1 and \vec{x}_2 a fixed distance apart. Then the existence of an OPE expansion implies that

$$\langle \mathcal{O}_{\Delta_1}(\vec{x}_1) \mathcal{O}_{\Delta_2}(\vec{x}_2) \mathcal{O}_{\Delta_3}(\vec{x}_3) \mathcal{O}_{\Delta_4}(\vec{x}_4) \rangle = \sum_{n,m} \frac{\alpha_n \langle \mathcal{O}_n(\vec{x}_1) \mathcal{O}_m(\vec{x}_2) \rangle \beta_m}{\vec{x}_{13}^{\Delta_1 + \Delta_3 - \Delta_m} \vec{x}_{24}^{\Delta_2 + \Delta_4 - \Delta_n}}, \quad (3.54)$$

at least as an asymptotic series, and hopefully even with a finite radius of convergence for \vec{x}_{13} and \vec{x}_{24} . The operators \mathcal{O}_n are the ones that appear in the OPE of \mathcal{O}_1 with \mathcal{O}_3 , and the operators \mathcal{O}_m are the ones that appear in the OPE of \mathcal{O}_2 with \mathcal{O}_4 . \mathcal{O}_ϕ and \mathcal{O}_C are descendants of chiral primaries, and so have protected dimensions. The product of descendants of chiral fields is not itself necessarily the descendent of a chiral field: an appropriately normal ordered product $:\mathcal{O}_\phi \mathcal{O}_\phi:$ is expected to have an unprotected

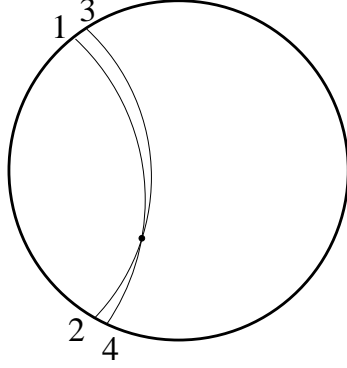

Figure 3.4: A nearly degenerate quartic graph contributing to the four-point function in the limit $|\vec{x}_{13}|, |\vec{x}_{24}| \ll |\vec{x}_{12}|$.

dimension of the form $8 + O(1/N^2)$. This is the natural result from the field theory point of view because there are $O(N^2)$ degrees of freedom contributing to each factor, and the commutation relations between them are non-trivial only a fraction $1/N^2$ of the time. From the supergravity point of view, a composite operator like $:\mathcal{O}_\phi\mathcal{O}_\phi:$ corresponds to a two-particle bulk state, and the $O(1/N^2) = O(\kappa^2/R^8)$ correction to the mass is interpreted as the correction to the mass of the two-particle state from gravitational binding energy. Roughly one is thinking of graviton exchange between the legs of figure 3.4 that are nearly coincident.

If (3.54) is expanded in inverse powers of N , then the $O(1/N^2)$ correction to Δ_n and Δ_m shows up to leading order as a term proportional to a logarithm of some combination of the separations \vec{x}_{ij} . Logarithms also appear in the expansion of (3.53) in the $|\vec{x}_{13}|, |\vec{x}_{24}| \ll |\vec{x}_{12}|$ limit in which (3.54) applies: the leading log in this limit is $\frac{1}{(\vec{x}_{12})^{16}} \log\left(\frac{\vec{x}_{13}\vec{x}_{24}}{\vec{x}_{12}^2}\right)$. This is the correct form to be interpreted in terms of the propagation of a two-particle state dual to an operator whose dimension is slightly different from 8.

3.4 Isomorphism of Hilbert Spaces

The *AdS/CFT* correspondence is a statement about the equivalence of two quantum theories: string theory (or M theory) on $AdS_{p+2} \times$ (compact space) and CFT_{p+1} . The two quantum theories are equivalent if there is an isomorphism between their Hilbert spaces, and moreover if the operator algebras on the Hilbert spaces are equivalent. In this section, we discuss the isomorphism of the Hilbert spaces, following [277, 185, 278, 279]. Related issues have been discussed in [280, 281, 282, 283, 284, 285, 286, 287, 288].

States in the Hilbert space of CFT_{p+1} fall into representations of the global conformal group $SO(2, p + 1)$ on $\mathbb{R}^{p,1}$. At the same time, the isometry group of *AdS* is also $SO(2, p + 1)$, and we can use it to classify states in the string theory. Thus, it is

useful to compare states in the two theories by organizing them into representations of $SO(2, p + 1)$. The conformal group $SO(2, p + 1)$ has $\frac{1}{2}(p + 2)(p + 3)$ generators, $J_{ab} = -J_{ba}$ ($a, b = 0, 1, \dots, p + 2$), obeying the commutation relation

$$[J_{ab}, J_{cd}] = -i(g_{ac}J_{bd} \pm \text{permutations}) \quad (3.55)$$

with the metric $g_{ab} = \text{diag}(-1, +1, +1, \dots, +1, -1)$. In CFT_{p+1} , they are identified with the Poincaré generators P_μ and $M_{\mu\nu}$, the dilatation D and the special conformal generators K_μ ($\mu, \nu = 0, \dots, p$), by the formulas

$$J_{p+2, p+1} = D, \quad J_{\mu, p+2} = \frac{1}{2}(K_\mu + P_\mu), \quad J_{\mu, p+1} = \frac{1}{2}(K_\mu - P_\mu), \quad J_{\mu\nu} = M_{\mu\nu}. \quad (3.56)$$

Since the field theory on $\mathbb{R}^{p,1}$ has no scale, the spectrum of the Hamiltonian P_0 is continuous and there is no normalizable ground state with respect to P_0 . This is also the case for the string theory on AdS_{p+2} . The Killing vector ∂_t corresponding to P_0 has the norm

$$\|\partial_t\| = Ru, \quad (3.57)$$

and it vanishes as $u \rightarrow 0$. Consequently, a stationary wave solution of the linearized supergravity on AdS has a continuous frequency spectrum with respect to the timelike coordinate t . It is not easy to compare the spectrum of P_0 of the two theories.

It is more useful to compare the two Hilbert spaces using the maximum compact subgroup $SO(2) \times SO(p + 1)$ of the conformal group [277]. The Minkowski space $\mathbb{R}^{p,1}$ is conformally embedded in the Einstein Universe $\mathbb{R} \times S^p$, and $SO(2) \times SO(p + 1)$ is its isometry group. In particular, the generator $J_{0, p+2} = \frac{1}{2}(P_0 + K_0)$ of $SO(2)$ is the Hamiltonian for the CFT on $\mathbb{R} \times S^p$. Now we have a scale in the problem, which is the radius of S^p , and the Hamiltonian $\frac{1}{2}(P_0 + K_0)$ has a mass gap. In string theory on AdS_{p+2} , the generator $\frac{1}{2}(P_0 + K_0)$ corresponds to the global time translation along the coordinate τ . This is a globally well-defined coordinate on AdS and the Killing vector ∂_τ is everywhere non-vanishing:

$$\|\partial_\tau\| = \frac{R}{\cos \theta}. \quad (3.58)$$

Therefore, a stationary wave solution with respect to τ is normalizable and has a discrete frequency spectrum. In fact, as we saw in section 2.2.4, the frequency is quantized in such a way that bosonic fields in the supergravity multiplet are periodic and their superpartners are anti-periodic (*i.e.* obeying the supersymmetry preserving Ramond boundary condition) in the τ -direction with the period $2\pi R$.

3.4.1 Hilbert Space of String Theory

With the techniques that are currently available, we can make reliable statements about the Hilbert space structure of string theory on AdS only when the curvature radius R

of AdS is much larger than the string length l_s . In this section we will study some of the properties of the Hilbert space that we can see in the AdS description. We will concentrate on the $AdS_5 \times S^5$ case, but it is easy to generalize this to other cases.

We first consider the case that corresponds to the 't Hooft limit $g_s \rightarrow 0$, $g_s N$ fixed and large, so that we can trust the gravity approximation.

(1) $E \ll m_s$; *Gas of Free Gravitons*

The Hilbert space for low energies is well approximated by the Fock space of gravitons and their superpartners on $AdS_5 \times S^5$. Since τ is a globally defined timelike coordinate on AdS , we can consider stationary wave solutions in the linearized supergravity, which are the normalizable states discussed in section 2.2.2. The frequency ω of a stationary mode is quantized in the unit set by the curvature radius R (2.41), so one may effectively view the supergravity particles in AdS as confined in a box of size R .

The operator $H = \frac{1}{2R}(P_0 + K_0)$ corresponds¹⁰ to the Killing vector ∂_τ on AdS . Thus, a single particle state of frequency ω gives an eigenstate of H . Since the supergraviton is a BPS particle, its energy eigenvalue ω is exact, free from corrections either by first quantized string effects ($\sim l_s/R$) or by quantum gravity effects ($\sim l_P/R$). The energy of multiparticle states may receive corrections, but they become important only when the energy E becomes comparable to the gravitational potential $E^2/(m_P^8 R^7)$, *i.e.* $E \sim m_P^8 R^7$. For the energies we are considering this effect is negligible.

Therefore, the Hilbert space for $E \ll m_s$ is identified with the Fock space of free supergravity particles. For $E \gg R^{-1}$, the entropy $S(E)$ ($= \log N(E)$ where $N(E)$ is the density of states) behaves as

$$S(E) \sim (ER)^{\frac{9}{10}}, \tag{3.59}$$

since we effectively have a gas in ten dimensions (we will ignore multiplicative numerical factors in the entropy in this section).

(2) $m_s < E \ll m_s/g_s^2$; *Gas of Free Strings*

When the energy E becomes comparable to the string scale m_s , we have to take into account excitations on the string worldsheet. Although we do not know the exact first quantized spectrum of string theory on AdS , we can estimate the effects of the worldsheet excitations when $l_s \ll R$. The mass m of a first quantized string state is a function of l_s and R . When $l_s \ll R$, the worldsheet dynamics is perturbative and we can expand m in powers of l_s/R , with the leading term given by the string spectrum on flat space ($R = \infty$). Therefore, for a string state corresponding to the n -th excited

¹⁰The factor $\frac{1}{2R}$ in the relation between H and $(P_0 + K_0)$ is fixed by the commutation relations (3.55).

level of the string on flat space, the (mass)² is given by

$$m^2 = l_s^{-2} \left(n + O(l_s^2/R^2) \right). \quad (3.60)$$

Unlike the single particle supergravity states discussed in the previous paragraph, string excitations need not carry integral eigenvalues of H (in units of R^{-1}). As they are not BPS particles, they are generically unstable in string perturbation theory.

The free string spectrum in 10 dimensions gives the Hagedorn density of states

$$S(E) \simeq El_s. \quad (3.61)$$

Thus, the entropy of supergravity particles (3.59) becomes comparable to that of excited strings (3.61) when

$$(ER)^{\frac{9}{10}} \sim El_s, \quad (3.62)$$

namely

$$E \sim m_s^{10} R^9. \quad (3.63)$$

For $m_s^{10} R^9 < E$, excited strings dominate the Hilbert space. The free string formula (3.61) is reliable until the energy hits another transition point $E \sim m_s/g_s^2$. We are assuming that $R^9 < l_s^9/g_s^2$, which is true in the 't Hooft region.

(3) $m_s/g_s^2 \ll E \ll m_P^8 R^7$; *Small Black Hole*

As we increase the energy, the gas of free strings starts collapsing to make a black hole. The black hole can be described by the classical supergravity when the horizon radius r_+ becomes larger than the string length l_s . Furthermore, if the horizon size r_+ is smaller than R , the geometry near the black hole can be approximated by the 10-dimensional Schwarzschild solution. The energy E and the entropy S of such a black hole is given by

$$\begin{aligned} E &\sim m_P^8 r_+^7 \\ S &\sim (m_P r_+)^8. \end{aligned} \quad (3.64)$$

Therefore, the entropy is estimated to be

$$S(E) \sim (El_P)^{\frac{8}{7}}. \quad (3.65)$$

We can trust this estimate when $l_s \ll r_+ \ll R$, namely $m_P^8 l_s^7 \ll E \ll m_P^8 R^7$. Comparing this with the Hagedorn density of states in the regime (2) given by (3.61), we find that the transition to (3.65) takes place at

$$E \sim \frac{m_s}{g_s^2}. \quad (3.66)$$

For $E \gg m_p^8 l_s^7$, the entropy formula (3.65) is reliable and the black hole entropy exceeds that of the gas of free strings. Therefore, in this regime, the Hilbert space is dominated by black hole states.

(4) $m_p^8 R^7 < E$; *Large Black Hole*

The above analysis assumes that the size of the black hole, characterized by the horizon radius r_+ , is small compared to the radii R of AdS_5 and S^5 . As we increase the energy, the radius r_+ grows and eventually becomes comparable to R . Beyond this point, we can no longer use the 10-dimensional Schwarzschild solution to estimate the number of states. According to (3.64), the horizon size becomes comparable to R when the energy of the black hole reaches the scale $E \sim m_p^8 R^7$. Beyond this energy scale, we have to use a solution which is asymptotically AdS_5 [289],

$$ds^2 = -f(r)d\tau^2 + \frac{1}{f(r)}dr^2 + r^2 d\Omega_3^2, \quad (3.67)$$

where

$$f(r) = 1 + \frac{r^2}{R^2} - \frac{r_+^2}{r^2} \left(1 + \frac{r_+^2}{R^2} \right), \quad (3.68)$$

and $r = r_+$ is the location of the out-most horizon. By studying the asymptotic behavior of the metric, one finds that the black hole carries the energy

$$E \sim \frac{r_+^2}{\mathbf{l}_P^3} \left(1 + \frac{r_+^2}{R^2} \right). \quad (3.69)$$

Here \mathbf{l}_P is the five-dimensional Planck length, related to the 10-dimensional Planck scale l_P and the compactification scale R as

$$\mathbf{l}_P^3 = l_P^8 R^{-5}. \quad (3.70)$$

The entropy of the AdS Schwarzschild solution is given by

$$S \sim \left(\frac{r_+}{\mathbf{l}_P} \right)^3. \quad (3.71)$$

For $r_+ \gg R$, (3.69) becomes $E \sim r_+^4 \mathbf{l}_P^{-3} R^{-2}$, and the entropy as a function of energy is

$$S \sim \left(\frac{ER^2}{\mathbf{l}_P} \right)^{\frac{3}{4}} = \left(\frac{R}{l_P} \right)^2 (ER)^{\frac{3}{4}}. \quad (3.72)$$

As the energy increases, the horizon size expands as $R \ll r_+ \rightarrow \infty$, and the supergravity approximation continues to be reliable. For $E \rightarrow \infty$, the only stringy and quantum gravity corrections are due to the finite size R of the AdS radius of curvature and of

the compact space, and such corrections are suppressed by factors of l_s/R and l_P/R . The leading l_s/R corrections to (3.72) were studied in [290], and found to be of the order of $(l_s/R)^3$.

○ Summary

The above analysis gives the following picture about the structure of the Hilbert space of string theory on AdS when $l_s \ll R$ and $g_s \ll 1$.

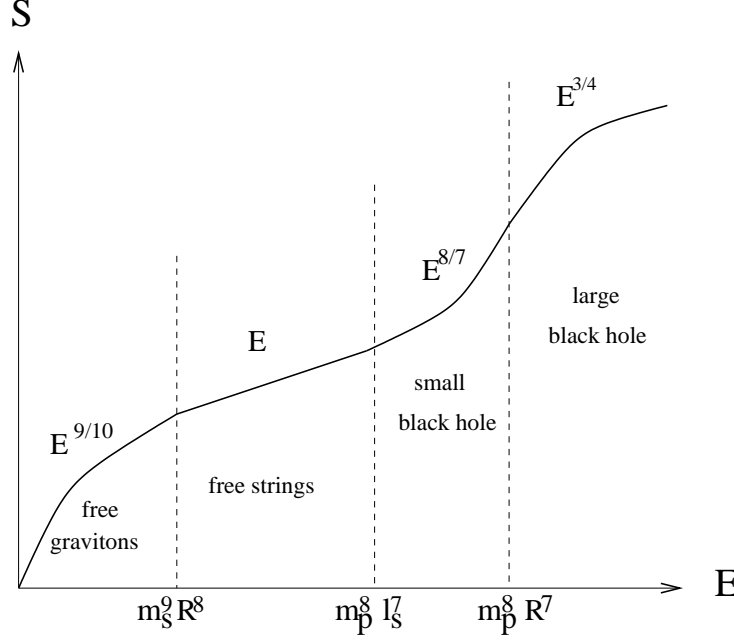

Figure 3.5: The behavior of the entropy S as a function of the energy E in AdS_5 .

(1) For energies $E \ll m_s$, the Hilbert space is the Fock space of supergravity particles and the spectrum is quantized in the unit of R^{-1} . For $E \ll m_s^{10} R^9$, the entropy is given by that of the gas of free supergravity particles in 10 dimensions:

$$S \sim (ER)^{\frac{9}{10}}. \quad (3.73)$$

(2) For $m_s^{10} R^9 < E \ll m_P^8 l_s^7$, stringy excitations become important, and the entropy grows linearly in energy:

$$S \sim El_s. \quad (3.74)$$

(3) For $m_P^8 l_s^7 \ll E \ll m_P^8 R^7$, the black hole starts to show up in the Hilbert space. For $E \ll m_P^8 R^7$, the size of the black hole horizon is smaller than R , and the entropy is given by that of the 10-dimensional Schwarzschild solution:

$$S \sim (El_P)^{\frac{8}{7}}. \quad (3.75)$$

(4) For $m_p^8 R^7 < E$, the size of the black hole horizon becomes larger than R . We then have to use the AdS_{p+2} Schwarzschild solution, and the entropy is given by:

$$S \sim \left(\frac{R}{l_P}\right)^2 (ER)^{\frac{3}{4}}. \quad (3.76)$$

The behavior of the entropy is depicted in figure 3.5.

In the small black hole regime (3), the system has a negative specific heat. This corresponds to the well-known instability of the flat space at finite temperature [291]. On the other hand, the AdS Schwarzschild solution has a positive specific heat and it is thermodynamically stable. This means that, if we consider a canonical ensemble, the free string regime (2) and the small black hole regime (3) will be missed. When set in contact with a heat bath of temperature $T \sim m_s$, the system will continue to absorb heat until its energy reaches $E \sim m_p^8 R^7$, the threshold of the large black hole regime (4). In fact the jump from (1) to (4) takes place at much lower temperature since the temperature equivalent of $E \sim m_p^8 R^7$ derived from (3.76) in the regime (4) is $T \sim R^{-1}$. Therefore, once the temperature is raised to $T \sim R^{-1}$ a black hole forms. The behavior of the canonical ensemble will be discussed in more detail in section 3.6.

Finally let us notice that in the case that $g_s \sim 1$ we do not have the Hagedorn phase, and we go directly from the gas of gravitons to the small black hole phase.

3.4.2 Hilbert Space of Conformal Field Theory

Next, let us turn to a discussion of the Hilbert space of the CFT_{p+1} . The generator $J_{0,p+2} = \frac{1}{2}(P_0 + K_0)$ is the Hamiltonian of the CFT on S^p with the unit radius. In the Euclidean CFT, the conformal group $SO(2, p+1)$ turns into $SO(1, p+2)$ by the Wick rotation, and the Hamiltonian $\frac{1}{2}(P_0 + K_0)$ and the dilatation operator D can be rotated into each other by an internal isomorphism of the group. Therefore, if there is a conformal field $\phi_h(x)$ of dimension h with respect to the dilatation D , then there is a corresponding eigenstate $|h\rangle$ of $\frac{1}{2}(P_0 + K_0)$ on S^p with the same eigenvalue h . In two-dimensional conformal field theory, this phenomenon is well-known as the state-operator correspondence, but in fact it holds for any CFT_{p+1} :

$$\phi_h(x) \rightarrow |h\rangle = \phi_h(x=0)|0\rangle. \quad (3.77)$$

As discussed in section 3.2.1, in maximally supersymmetric cases there is a one-to-one correspondence between chiral primary operators of CFT_{p+1} and the supergravity particles on the dual $AdS_{p+2} \times$ (compact space). This makes it possible to identify a state in the Fock space of the supergravity particles on AdS with a state in the CFT Hilbert space generated by the chiral primary fields.

To be specific, let us consider the $\mathcal{N} = 4$ $SU(N)$ super Yang-Mills theory in four dimensions and its dual, type IIB string theory on $AdS_5 \times S^5$. The string scale m_s and the 10-dimensional Planck scale m_P are related to the gauge theory parameters, g_{YM} and N , by

$$m_s \simeq (g_{YM}^2 N)^{\frac{1}{4}} R^{-1}, \quad m_P \simeq N^{\frac{1}{4}} R^{-1}. \quad (3.78)$$

The four energy regimes of string theory on $AdS_5 \times S^5$ are translated into the gauge theory energy scales (measured in the units of the inverse S^3 radius) in the 't Hooft limit as follows:

(1) $E \ll (g_{YM}^2 N)^{\frac{1}{4}}$

The Hilbert space consists of the chiral primary states, their superconformal descendants and their products. Because of the large- N factorization, a product of gauge invariant operators receives corrections only at subleading orders in the $1/N$ expansion. This fits well with the supergravity description of multi-graviton states, where we estimated that their energy E becomes comparable to the gravitational potential when $E \sim m_P^8 R^7$, which in the gauge theory scale corresponds to $E \sim N^2$. The entropy for $1 \ll E \ll (g_{YM}^2 N)^{\frac{1}{4}}$ is then given by

$$S \sim E^{\frac{9}{10}}. \quad (3.79)$$

(2) $(g_{YM}^2 N)^{\frac{1}{4}} < E \ll (g_{YM}^2 N)^{-\frac{7}{2}} N^2$

Each single string state is identified with a single trace operator in the gauge theory. Supergravity particles correspond to chiral primary states and stringy excitations to non-chiral primaries. Since stringy excitations have an energy $\sim m_s$, the AdS/CFT correspondence requires that non-chiral conformal fields have to have large anomalous dimensions $\Delta \sim m_s R = (g_{YM}^2 N)^{\frac{1}{4}}$. In the 't Hooft limit ($N \gg (g_{YM}^2 N)^\gamma$ for any γ), we can consider the regime $(g_{YM}^2 N)^{\frac{5}{2}} < E \ll (g_{YM}^2 N)^{-\frac{7}{2}} N^2$ where the entropy shows the Hagedorn behavior

$$S \sim (g_{YM}^2 N)^{-\frac{1}{4}} E. \quad (3.80)$$

Apparently, the entropy in this regime is dominated by the non-chiral fields.

(3) $(g_{YM}^2 N)^{-\frac{7}{2}} N^2 < E < N^2$

The string theory Hilbert space consists of states in the small black hole. It would be interesting to find a gauge theory interpretation of the 10-dimensional Schwarzschild black hole. The entropy in this regime behaves as

$$S \sim N^{-\frac{2}{7}} E^{\frac{8}{7}}. \quad (3.81)$$

(4) $N^2 < E$

The string theory Hilbert space consists of states in the large black hole. The entropy is given by

$$S \sim N^{\frac{1}{2}} E^{\frac{3}{4}}. \quad (3.82)$$

The $E^{\frac{3}{4}}$ scaling of the entropy is what one expects for a conformal field theory in $(3+1)$ dimensions at high energies (compared to the radius of the sphere). It is interesting to note that the N dependence of S is the same as that of N^2 free particles in $(3+1)$ dimensions, although the precise numerical coefficient in S differs from the one that is obtained from the number of particles in the $\mathcal{N} = 4$ Yang-Mills multiplet by a numerical factor [292].

3.5 Wilson Loops

In this section we consider Wilson loop operators in the gauge theory. The Wilson loop operator

$$W(\mathcal{C}) = \text{Tr} \left[P \exp \left(i \oint_{\mathcal{C}} A \right) \right] \quad (3.83)$$

depends on a loop \mathcal{C} embedded in four dimensional space, and it involves the path-ordered integral of the gauge connection along the contour. The trace is taken over some representation of the gauge group; we will discuss here only the case of the fundamental representation (see [293] for a discussion of other representations). From the expectation value of the Wilson loop operator $\langle W(\mathcal{C}) \rangle$ we can calculate the quark-antiquark potential. For this purpose we consider a rectangular loop with sides of length T and L in Euclidean space. Then, viewing T as the time direction, it is clear that for large T the expectation value will behave as e^{-TE} where E is the lowest possible energy of the quark-anti-quark configuration. Thus, we have

$$\langle W \rangle \sim e^{-TV(L)}, \quad (3.84)$$

where $V(L)$ is the quark anti-quark potential. For large N and large $g_{YM}^2 N$, the AdS/CFT correspondence maps the computation of $\langle W \rangle$ in the CFT into a problem of finding a minimum surface in AdS [294, 295].

3.5.1 Wilson Loops and Minimum Surfaces

In QCD, we expect the Wilson loop to be related to the string running from the quark to the antiquark. We expect this string to be analogous to the string in our configuration, which is a superstring which lives in ten dimensions, and which can stretch between two points on the boundary of AdS . In order to motivate this prescription let us consider the following situation. We start with the gauge group $U(N+1)$, and we break it to $U(N) \times U(1)$ by giving an expectation value to one of the scalars. This corresponds, as discussed in section 3.1, to having a D3 brane sitting at some radial position U in AdS , and at a point on S^5 . The off-diagonal states, transforming in the \mathbf{N} of $U(N)$, get a mass proportional to U , $m = U/2\pi$. So, from the point of view of

the $U(N)$ gauge theory, we can view these states as massive quarks, which act as a source for the various $U(N)$ fields. Since they are charged they will act as a source for the vector fields. In order to get a non-dynamical source (an “external quark” with no fluctuations of its own, which will correspond precisely to the Wilson loop operator) we need to take $m \rightarrow \infty$, which means U should also go to infinity. Thus, the string should end on the boundary of AdS space.

These stretched strings will also act as a source for the scalar fields. The coupling to the scalar fields can be seen qualitatively by viewing the quarks as strings stretching between the N branes and the single separated brane. These strings will pull the N branes and will cause a deformation of the branes, which is described by the scalar fields. A more formal argument for this coupling is that these states are BPS, and the coupling to the scalar (Higgs) fields is determined by supersymmetry. Finally, one can see this coupling explicitly by writing the full $U(N + 1)$ Lagrangian, putting in the Higgs expectation value and calculating the equation of motion for the massive fields [294]. The precise definition of the Wilson loop operator corresponding to the superstring will actually include also the field theory fermions, which will imply some particular boundary conditions for the worldsheet fermions at the boundary of AdS . However, this will not affect the leading order computations we describe here.

So, the final conclusion is that the stretched strings couple to the operator

$$W(\mathcal{C}) = \text{Tr} \left[P \exp \left(\oint (iA_\mu \dot{x}^\mu + \theta^I \phi^I \sqrt{\dot{x}^2}) d\tau \right) \right], \quad (3.85)$$

where $x^\mu(\tau)$ is any parametrization of the loop and θ^I ($I = 1, \dots, 6$) is a unit vector in \mathbb{R}^6 (the point on S^5 where the string is sitting). This is the expression when the signature of \mathbb{R}^4 is Euclidean. In the Minkowski signature case, the phase factor associated to the trajectory of the quark has an extra factor “ i ” in front of θ^I ¹¹.

Generalizing the prescription of section 3.3 for computing correlation functions, the discussion above implies that in order to compute the expectation value of the operator (3.85) in $\mathcal{N} = 4$ SYM we should consider the string theory partition function on $AdS_5 \times S^5$, with the condition that we have a string worldsheet ending on the loop \mathcal{C} , as in figure 3.6 [295, 294]. In the supergravity regime, when $g_s N$ is large, the leading contribution to this partition function will come from the area of the string worldsheet. This area is measured with the AdS metric, and it is generally not the same as the area enclosed by the loop \mathcal{C} in four dimensions.

The area as defined above is divergent. The divergence arises from the fact that the string worldsheet is going all the way to the boundary of AdS . If we evaluate the area up to some radial distance $U = r$, we see that for large r it diverges as

¹¹The difference in the factor of i between the Euclidean and the Minkowski cases can be traced to the analytic continuation of $\sqrt{\dot{x}^2}$. A detailed derivation of (3.85) can be found in [296].

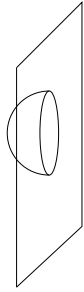

Figure 3.6: The Wilson loop operator creates a string worldsheet ending on the corresponding loop on the boundary of AdS .

$r|\mathcal{C}|$, where $|\mathcal{C}|$ is the length of the loop in the field theory [294, 295]. On the other hand, the perturbative computation in the field theory shows that $\langle W \rangle$, for W given by (3.85), is finite, as it should be since a divergence in the Wilson loop would have implied a mass renormalization of the BPS particle. The apparent discrepancy between the divergence of the area of the minimum surface in AdS and the finiteness of the field theory computation can be reconciled by noting that the appropriate action for the string worldsheet is not the area itself but its Legendre transform with respect to the string coordinates corresponding to θ^I and the radial coordinate u [296]. This is because these string coordinates obey the Neumann boundary conditions rather than the Dirichlet conditions. When the loop is smooth, the Legendre transformation simply subtracts the divergent term $r|\mathcal{C}|$, leaving the resulting action finite.

As an example let us consider a circular Wilson loop. Take \mathcal{C} to be a circle of radius a on the boundary, and let us work in the Poincaré coordinates (defined in section 2.2). We could find the surface that minimizes the area by solving the Euler-Lagrange equations. However, in this case it is easier to use conformal invariance. Note that there is a conformal transformation in the field theory that maps a line to a circle. In the case of the line, the minimum area surface is clearly a plane that intersects the boundary and goes all the way to the horizon (which is just a point on the boundary in the Euclidean case). Using the conformal transformation to map the line to a circle we obtain the minimal surface we want. It is, using the coordinates (3.17) for AdS_5 ,

$$\vec{x} = \sqrt{a^2 - z^2}(\vec{e}_1 \cos \theta + \vec{e}_2 \sin \theta), \quad (3.86)$$

where \vec{e}_1, \vec{e}_2 are two orthonormal vectors in four dimensions (which define the orientation of the circle) and $0 \leq z \leq a$. We can calculate the area of this surface in AdS , and we get a contribution to the action

$$S \sim \frac{1}{2\pi\alpha'} \mathcal{A} = \frac{R^2}{2\pi\alpha'} \int d\theta \int_{\epsilon}^a \frac{dza}{z^2} = \frac{R^2}{\alpha'} \left(\frac{a}{\epsilon} - 1 \right), \quad (3.87)$$

where we have regularized the area by putting a an IR cutoff at $z = \epsilon$ in AdS , which is equivalent to a UV cutoff in the field theory [175]. Subtracting the divergent term we get

$$\langle W \rangle \sim e^{-S} \sim e^{R^2/\alpha'} = e^{\sqrt{4\pi g_s N}}. \quad (3.88)$$

This is independent of a as required by conformal invariance.

We could similarly consider a “magnetic” Wilson loop, which is also called a ’t Hooft loop [297]. This case is related by electric-magnetic duality to the previous case. Since we identify the electric-magnetic duality with the $SL(2, \mathbb{Z})$ duality of type IIB string theory, we should consider in this case a D-string worldsheet instead of a fundamental string worldsheet. We get the same result as in (3.88) but with $g_s \rightarrow 1/g_s$.

Using (3.84) it is possible to compute the quark-antiquark potential in the supergravity approximation [295, 294]. In this case we consider a configuration which is invariant under (Euclidean) time translations. We take both particles to have the same scalar charge, which means that the two ends of the string are at the same point in S^5 (one could consider also the more general case with a string ending at different points on S^5 [294]). We put the quark at $x = -L/2$ and the anti-quark at $x = L/2$. Here “quark” means an infinitely massive W-boson connecting the N branes with one brane which is (infinitely) far away. The classical action for a string worldsheet is

$$S = \frac{1}{2\pi\alpha'} \int d\tau d\sigma \sqrt{\det(G_{MN} \partial_\alpha X^M \partial_\beta X^N)}, \quad (3.89)$$

where G_{MN} is the Euclidean $AdS_5 \times S^5$ metric. Note that the factors of α' cancel out in (3.89), as they should. Since we are interested in a static configuration we take $\tau = t$, $\sigma = x$, and then the action becomes

$$S = \frac{TR^2}{2\pi} \int_{-L/2}^{L/2} dx \frac{\sqrt{(\partial_x z)^2 + 1}}{z^2}. \quad (3.90)$$

We need to solve the Euler-Lagrange equations for this action. Since the action does not depend on x explicitly the solution satisfies

$$\frac{1}{z^2 \sqrt{(\partial_x z)^2 + 1}} = \text{constant}. \quad (3.91)$$

Defining z_0 to be the maximum value of $z(x)$, which by symmetry occurs at $x = 0$, we find that the solution is¹²

$$x = z_0 \int_{z/z_0}^1 \frac{dy y^2}{\sqrt{1 - y^4}}, \quad (3.92)$$

¹²All integrals in this section can be calculated in terms of elliptic or Beta functions.

where z_0 is determined by the condition

$$\frac{L}{2} = z_0 \int_0^1 \frac{dy y^2}{\sqrt{1-y^4}} = z_0 \frac{\sqrt{2}\pi^{3/2}}{\Gamma(1/4)^2}. \quad (3.93)$$

The qualitative form of the solution is shown in figure 3.7(b). Notice that the string quickly approaches $x = L/2$ for small z (close to the boundary),

$$\frac{L}{2} - x \sim z^3, \quad z \rightarrow 0. \quad (3.94)$$

Now we compute the total energy of the configuration. We just plug in the solution (3.92) in (3.90), subtract the infinity as explained above (which can be interpreted as the energy of two separated massive quarks, as in figure 3.7(a)), and we find

$$E = V(L) = -\frac{4\pi^2(2g_{YM}^2 N)^{1/2}}{\Gamma(\frac{1}{4})^4 L}. \quad (3.95)$$

We see that the energy goes as $1/L$, a fact which is determined by conformal invariance. Note that the energy is proportional to $(g_{YM}^2 N)^{1/2}$, as opposed to $g_{YM}^2 N$ which is the perturbative result. This indicates some screening of the charges at strong coupling. The above calculation makes sense for all distances L when $g_s N$ is large, independently of the value of g_s . Some subleading corrections coming from quantum fluctuations of the worldsheet were calculated in [298, 299, 300].

In a similar fashion we could compute the potential between two magnetic monopoles in terms of a D-string worldsheet, and the result will be the same as (3.95) but with $g_{YM} \rightarrow 4\pi/g_{YM}$. One can also calculate the interaction between a magnetic monopole and a quark. In this case the fundamental string (ending on the quark) will attach to the D-string (ending on the monopole), and they will connect to form a $(1, 1)$ string which will go into the horizon. The resulting potential is a complicated function of g_{YM} [301], but in the limit that g_{YM} is small (but still with $g_{YM}^2 N$ large) we get that the monopole-quark potential is just $1/4$ of the quark-quark potential. This can be understood from the fact that when g is small the D-string is very rigid and the fundamental string will end almost perpendicularly on the D-string. Therefore, the solution for the fundamental string will be half of the solution we had above, leading to a factor of $1/4$ in the potential. Calculations of Wilson loops in the Higgs phase were done in [302].

Another interesting case one can study analytically is a surface near a cusp on \mathbb{R}^4 . In this case, the perturbative computation in the gauge theory shows a logarithmic divergence with a coefficient depending on the angle at the cusp. The area of the minimum surface also contains a logarithmic divergence depending on the angle [296]. Other aspects of the gravity calculation of Wilson loops were discussed in [303, 304, 305, 306, 307].

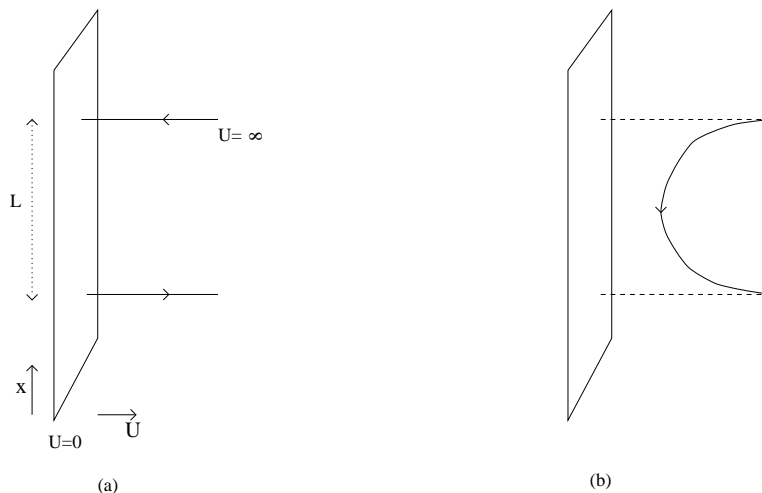

Figure 3.7: (a) Initial configuration corresponding to two massive quarks before we turn on their coupling to the $U(N)$ gauge theory. (b) Configuration after we consider the coupling to the $U(N)$ gauge theory. This configuration minimizes the action. The quark-antiquark energy is given by the difference of the total length of the strings in (a) and (b).

3.5.2 Other Branes Ending on the Boundary

We could also consider other branes that are ending at the boundary [308]. The simplest example would be a zero-brane (i.e. a particle) of mass m . In Euclidean space a zero-brane describes a one dimensional trajectory in anti-de-Sitter space which ends at two points on the boundary. Therefore, it is associated with the insertion of two local operators at the two points where the trajectory ends. In the supergravity approximation the zero-brane follows a geodesic. Geodesics in the hyperbolic plane (Euclidean AdS) are semicircles. If we compute the action we get

$$S = m \int ds = -2mR \int_{\epsilon}^a \frac{adz}{z\sqrt{a^2 - z^2}}, \quad (3.96)$$

where we took the distance between the two points at the boundary to be $L = 2a$ and regulated the result. We find a logarithmic divergence when $\epsilon \rightarrow 0$, proportional to $\log(\epsilon/a)$. If we subtract the logarithmic divergence we get a residual dependence on a . Naively we might have thought that (as in the previous subsection) the answer had to be independent of a due to conformal invariance. In fact, the dependence on a is very important, since it leads to a result of the form

$$e^{-S} \sim e^{-2mR \log a} \sim \frac{1}{a^{2mR}}, \quad (3.97)$$

which is precisely the result we expect for the two-point function of an operator of dimension $\Delta = mR$. This is precisely the large mR limit of the formula (3.14), so we reproduce in the supergravity limit the 2-point function described in section 3.3. In general, this sort of logarithmic divergence arises when the brane worldvolume is odd dimensional [308], and it implies that the expectation value of the corresponding operator depends on the overall scale. In particular one could consider the “Wilson surfaces” that arise in the six dimensional $\mathcal{N} = (2, 0)$ theory which will be discussed in section 6.1.1. In that case one has to consider a two-brane, with a three dimensional worldvolume, ending on a two dimensional surface on the boundary of AdS_7 . Again, one gets a logarithmic term, which is proportional to the rigid string action of the two dimensional surface living on the string in the $\mathcal{N} = (2, 0)$ field theory [309, 308].

One can also compute correlation functions involving more than one Wilson loop. To leading order in N this will be just the product of the expectation values of each Wilson loop. On general grounds one expects that the subleading corrections are given by surfaces that end on more than one loop. One limiting case is when the surfaces look similar to the zeroth order surfaces but with additional thin tubes connecting them. These thin tubes are nothing else than massless particles being exchanged between the two string worldsheets [293, 309]. We will discuss this further in section 6.2.

3.6 Theories at Finite Temperature

As discussed in section 3.2, the quantities that can be most successfully compared between gauge theory and string theory are those with some protection from supersymmetry and/or conformal invariance — for instance, dimensions of chiral primary operators. Finite temperature breaks both supersymmetry and conformal invariance, and the insights we gain from examining the $T > 0$ physics will be of a more qualitative nature. They are no less interesting for that: we shall see in section 3.6.1 how the entropy of near-extremal D3-branes comes out identical to the free field theory prediction up to a factor of a power of 4/3; then in section 3.6.2 we explain how a phase transition studied by Hawking and Page in the context of quantum gravity is mapped into a confinement-deconfinement transition in the gauge theory, driven by finite-size effects; and in section 6.2 we will summarize the attempts to use holographic duals of finite-temperature field theories to learn about pure gauge theory at zero temperature but in one lower dimension.

3.6.1 Construction

The gravity solution describing the gauge theory at finite temperature can be obtained by starting from the general black three-brane solution (1.12) and taking the decoupling

limit of section 3.1 keeping the energy density above extremality finite. The resulting metric can be written as

$$ds^2 = R^2 \left[u^2 (-h dt^2 + dx_1^2 + dx_2^2 + dx_3^2) + \frac{du^2}{hu^2} + d\Omega_5^2 \right] \quad (3.98)$$

$$h = 1 - \frac{u_0^4}{u^4}, \quad u_0 = \pi T.$$

It will often be useful to Wick rotate by setting $t_E = it$, and use the relation between the finite temperature theory and the Euclidean theory with a compact time direction.

The first computation which indicated that finite-temperature $U(N)$ Yang-Mills theory might be a good description of the microstates of N coincident D3-branes was the calculation of the entropy [292, 310]. On the supergravity side, the entropy of near-extremal D3-branes is just the usual Bekenstein-Hawking result, $S = A/4G_N$, and it is expected to be a reliable guide to the entropy of the gauge theory at large N and large $g_{YM}^2 N$. There is no problem on the gauge theory side in working at large N , but large $g_{YM}^2 N$ at finite temperature is difficult indeed. The analysis of [292] was limited to a free field computation in the field theory, but nevertheless the two results for the entropy agreed up to a factor of a power of $4/3$. In the canonical ensemble, where temperature and volume are the independent variables, one identifies the field theory volume with the world-volume of the D3-branes, and one sets the field theory temperature equal to the Hawking temperature in supergravity. The result is

$$F_{SUGRA} = -\frac{\pi^2}{8} N^2 V T^4, \quad (3.99)$$

$$F_{SYM} = \frac{4}{3} F_{SUGRA}.$$

The supergravity result is at leading order in l_s/R , and it would acquire corrections suppressed by powers of TR if we had considered the full D3-brane metric rather than the near-horizon limit, (3.98). These corrections do not have an interpretation in the context of CFT because they involve R as an intrinsic scale. Two equivalent methods to evaluate F_{SUGRA} are a) to use $F = E - TS$ together with standard expressions for the Bekenstein-Hawking entropy, the Hawking temperature, and the ADM mass; and b) to consider the gravitational action of the Euclidean solution, with a periodicity in the Euclidean time direction (related to the temperature) which eliminates a conical deficit angle at the horizon.¹³

The $4/3$ factor is a long-standing puzzle into which we still have only qualitative insight. The gauge theory computation was performed at zero 't Hooft coupling, whereas

¹³The result of [292], $S_{SYM} = (4/3)^{1/4} S_{SUGRA}$, differs superficially from (3.99), but it is only because the authors worked in the microcanonical ensemble: rather than identifying the Hawking temperature with the field theory temperature, the ADM mass above extremality was identified with the field theory energy.

the supergravity is supposed to be valid at strong 't Hooft coupling, and unlike in the 1+1-dimensional case where the entropy is essentially fixed by the central charge, there is no non-renormalization theorem for the coefficient of T^4 in the free energy. Indeed, it was suggested in [290] that the leading term in the $1/N$ expansion of F has the form

$$F = -f(g_{YM}^2 N) \frac{\pi^2}{6} N^2 V T^4, \quad (3.100)$$

where $f(g_{YM}^2 N)$ is a function which smoothly interpolates between a weak coupling limit of 1 and a strong coupling limit of $3/4$. It was pointed out early [311] that the quartic potential $g_{YM}^2 \text{Tr}[\phi^I, \phi^J]^2$ in the $\mathcal{N} = 4$ Yang-Mills action might be expected to freeze out more and more degrees of freedom as the coupling was increased, which would suggest that $f(g_{YM}^2 N)$ is monotone decreasing. An argument has been given [312], based on the non-renormalization of the two-point function of the stress tensor, that $f(g_{YM}^2 N)$ should remain finite at strong coupling.

The leading corrections to the limiting value of $f(g_{YM}^2 N)$ at strong and weak coupling were computed in [290] and [313], respectively. The results are

$$\begin{aligned} f(g_{YM}^2 N) &= 1 - \frac{3}{2\pi^2} g_{YM}^2 N + \dots && \text{for small } g_{YM}^2 N, \\ f(g_{YM}^2 N) &= \frac{3}{4} + \frac{45}{32} \frac{\zeta(3)}{(g_{YM}^2 N)^{3/2}} + \dots && \text{for large } g_{YM}^2 N. \end{aligned} \quad (3.101)$$

The weak coupling result is a straightforward although somewhat tedious application of the diagrammatic methods of perturbative finite-temperature field theory. The constant term is from one loop, and the leading correction is from two loops. The strong coupling result follows from considering the leading α' corrections to the supergravity action. The relevant one involves a particular contraction of four powers of the Weyl tensor. It is important now to work with the Euclidean solution, and one restricts attention further to the near-horizon limit. The Weyl curvature comes from the non-compact part of the metric, which is no longer AdS_5 but rather the AdS-Schwarzschild solution which we will discuss in more detail in section 3.6.2. The action including the α' corrections no longer has the Einstein-Hilbert form, and correspondingly the Bekenstein-Hawking prescription no longer agrees with the free energy computed as βI where I is the Euclidean action. In keeping with the basic prescription for computing Green's functions, where a free energy in field theory is equated (in the appropriate limit) with a supergravity action, the relation $I = \beta F$ is regarded as the correct one. (See [314].) It has been conjectured that the interpolating function $f(g_{YM}^2 N)$ is not smooth, but exhibits some phase transition at a finite value of the 't Hooft coupling. We regard this as an unsettled question. The arguments in [315, 316] seem as yet incomplete. In particular, they rely on analyticity properties of the perturbation expansion which do not seem to be proven for finite temperature field theories.

3.6.2 Thermal Phase Transition

The holographic prescription of [19, 20], applied at large N and $g_{YM}^2 N$ where loop and stringy corrections are negligible, involves extremizing the supergravity action subject to particular asymptotic boundary conditions. We can think of this as the saddle point approximation to the path integral over supergravity fields. That path integral is ill-defined because of the non-renormalizable nature of supergravity. String amplitudes (when we can calculate them) render on-shell quantities well-defined. Despite the conceptual difficulties we can use some simple intuition about path integrals to illustrate an important point about the AdS/CFT correspondence: namely, there can be more than one saddle point in the range of integration, and when there is we should sum $e^{-I_{SUGRA}}$ over the classical configurations to obtain the saddle-point approximation to the gauge theory partition function. Multiple classical configurations are possible because of the general feature of boundary value problems in differential equations: there can be multiple solutions to the classical equations satisfying the same asymptotic boundary conditions. The solution which globally minimizes I_{SUGRA} is the one that dominates the path integral.

When there are two or more solutions competing to minimize I_{SUGRA} , there can be a phase transition between them. An example of this was studied in [289] long before the AdS/CFT correspondence, and subsequently resurrected, generalized, and reinterpreted in [20, 185] as a confinement-deconfinement transition in the gauge theory. Since the qualitative features are independent of the dimension, we will restrict our attention to AdS_5 . It is worth noting however that if the AdS_5 geometry is part of a string compactification, it doesn't matter what the internal manifold is except insofar as it fixes the cosmological constant, or equivalently the radius R of anti-de Sitter space.

There is an embedding of the Schwarzschild black hole solution into anti-de Sitter space which extremizes the action

$$I = -\frac{1}{16\pi G_5} \int d^5x \sqrt{g} \left(\mathcal{R} + \frac{12}{R^2} \right). \quad (3.102)$$

Explicitly, the metric is

$$ds^2 = f dt^2 + \frac{1}{f} dr^2 + r^2 d\Omega_3^2, \quad (3.103)$$

$$f = 1 + \frac{r^2}{R^2} - \frac{\mu}{r^2}.$$

The radial variable r is restricted to $r \geq r_+$, where r_+ is the largest root of $f = 0$. The Euclidean time is periodically identified, $t \sim t + \beta$, in order to eliminate the conical

singularity at $r = r_+$. This requires

$$\beta = \frac{2\pi R^2 r_+}{2r_+^2 + R^2} . \quad (3.104)$$

Topologically, this space is $S^3 \times B^2$, and the boundary is $S^3 \times S^1$ (which is the relevant space for the field theory on S^3 with finite temperature). We will call this space X_2 . Another space with the same boundary which is also a local extremum of (3.102) is given by the metric in (3.103) with $\mu = 0$ and again with periodic time. This space, which we will call X_1 , is not only metrically distinct from the first (being locally conformally flat), but also topologically $B^4 \times S^1$ rather than $S^3 \times B^2$. Because the S^1 factor is not simply connected, there are two possible spin structures on X_1 , corresponding to thermal (anti-periodic) or supersymmetric (periodic) boundary conditions on fermions. In contrast, X_2 is simply connected and hence admits a unique spin structure, corresponding to thermal boundary conditions. For the purpose of computing the twisted partition function, $\text{Tr}(-1)^F e^{-\beta H}$, in a saddle-point approximation, only X_1 contributes. But, X_1 and X_2 make separate saddle-point contributions to the usual thermal partition function, $\text{Tr} e^{-\beta H}$, and the more important one is the one with the smaller Euclidean action.

Actually, both $I(X_1)$ and $I(X_2)$ are infinite, so to compute $I(X_2) - I(X_1)$ a regulation scheme must be adopted. The one used in [185, 290] is to cut off both X_1 and X_2 at a definite coordinate radius $r = R_0$. For X_2 , the elimination of the conical deficit angle at the horizon fixes the period of Euclidean time; but for X_1 , the period is arbitrary. In order to make the comparison of $I(X_1)$ and $I(X_2)$ meaningful, we fix the period of Euclidean time on X_1 so that the proper circumference of the S_1 at $r = R_0$ is the same as the proper length on X_2 of an orbit of the Killing vector $\partial/\partial t$, also at $r = R_0$. In the limit $R_0 \rightarrow \infty$, one finds

$$I(X_2) - I(X_1) = \frac{\pi^2 r_+^3 (R^2 - r_+^2)}{4G_5 (2r_+^2 + R^2)} , \quad (3.105)$$

where again r_+ is the largest root of $f = 0$. The fact that (3.105) (or more precisely its AdS_4 analog) can change its sign was interpreted in [289] as indicating a phase transition between a black hole in AdS and a thermal gas of particles in AdS (which is the natural interpretation of the space X_1). The black hole is the thermodynamically favored state when the horizon radius r_+ exceeds the radius of curvature R of AdS . In the gauge theory we interpret this transition as a confinement-deconfinement transition. Since the theory is conformally invariant, the transition temperature must be proportional to the inverse radius of the space S^3 which the field theory lives on. Similar transitions, and also local thermodynamic instability due to negative specific heats, have been studied in the context of spinning branes and charged black holes

in [317, 318, 319, 142, 141, 320, 321]. Most of these works are best understood on the CFT side as explorations of exotic thermal phenomena in finite-temperature gauge theories. Connections with Higgsed states in gauge theory are clearer in [322, 323]. The relevance to confinement is explored in [320]. See also [324, 325, 326, 285] for other interesting contributions to the finite temperature literature.

Deconfinement at high temperature can be characterized by a spontaneous breaking of the center of the gauge group. In our case the gauge group is $SU(N)$ and its center is \mathbb{Z}_N . The order parameter for the breaking of the center is the expectation value of the Polyakov (temporal) loop $\langle W(C) \rangle$. The boundary of the spaces X_1, X_2 is $S^3 \times S^1$, and the path C wraps around the circle. An element of the center $g \in \mathbb{Z}_N$ acts on the Polyakov loop by $\langle W(C) \rangle \rightarrow g \langle W(C) \rangle$. The expectation value of the Polyakov loop measures the change of the free energy of the system $F_q(T)$ induced by the presence of the external charge q , $\langle W(C) \rangle \sim \exp(-F_q(T)/T)$. In a confining phase $F_q(T)$ is infinite and therefore $\langle W(C) \rangle = 0$. In the deconfined phase $F_q(T)$ is finite and therefore $\langle W(C) \rangle \neq 0$.

As discussed in section 3.5, in order to compute $\langle W(C) \rangle$ we have to evaluate the partition function of strings with a worldsheet D that is bounded by the loop C . Consider first the low temperature phase. The relevant space is X_1 which, as discussed above, has the topology $B^4 \times S^1$. The contour C wraps the circle and is not homotopic to zero in X_1 . Therefore C is not a boundary of any D , which immediately implies that $\langle W(C) \rangle = 0$. This is the expected behavior at low temperatures (compared to the inverse radius of the S^3), where the center of the gauge group is not broken.

For the high temperature phase the relevant space is X_2 , which has the topology $S^3 \times B^2$. The contour C is now a boundary of a string worldsheet $D = B^2$ (times a point in S^3). This seems to be in agreement with the fact that in the high temperature phase $\langle W(C) \rangle \neq 0$ and the center of the gauge group is broken. It was pointed out in [185] that there is a subtlety with this argument, since the center should not be broken in finite volume (S^3), but only in the infinite volume limit (\mathbb{R}^3). Indeed, the solution X_2 is not unique and we can add to it an expectation value for the integral of the NS-NS 2-form field B on B^2 , with vanishing field strength. This is an angular parameter ψ with period 2π , which contributes $i\psi$ to the string worldsheet action. The string theory partition function includes now an integral over all values of ψ , making $\langle W(C) \rangle = 0$ on S^3 . In contrast, on \mathbb{R}^3 one integrates over the local fluctuations of ψ but not over its vacuum expectation value. Now $\langle W(C) \rangle \neq 0$ and depends on the value of $\psi \in U(1)$, which may be understood as the dependence on the center \mathbb{Z}_N in the large N limit. Explicit computations of Polyakov loops at finite temperature were done in [327, 328].

In [185] the Euclidean black hole solution (3.103) was suggested to be holographically dual to a theory related to pure QCD in three dimensions. In the large volume limit

the solution corresponds to the $\mathcal{N} = 4$ gauge theory on $\mathbb{R}^3 \times S^1$ with thermal boundary conditions, and when the S^1 is made small (corresponding to high temperature T) the theory at distances larger than $1/T$ effectively reduces to pure Yang-Mills on \mathbb{R}^3 . Some of the non-trivial successes of this approach to QCD will be discussed in section 6.2.

Chapter 4

More on the Correspondence

4.1 Other AdS_5 Backgrounds

Up to now we have limited our discussion to the $AdS_5 \times S^5$ background of type IIB string theory; in section 4.3 we will describe backgrounds which are related to it by deformations. However, it is clear from the description of the correspondence in sections 3.1 and 3.3 that a similar correspondence may be defined for any theory of quantum gravity whose metric includes an AdS_5 factor; the generalization of equation (3.13) relates such a theory to a four dimensional conformal field theory. The background does not necessarily have to be of the form $AdS_5 \times X$; it is enough that it has an $SO(4, 2)$ isometry symmetry, and more general possibilities in which the curvature of AdS_5 depends on the position in X are also possible [121]. It is necessary, however, for the AdS theory to be a theory of quantum gravity, since any conformal theory has an energy-momentum tensor operator that is mapped by the correspondence to the graviton on AdS_5 ¹. Thus, we would like to discuss compactifications of string theory or M theory, which are believed to be consistent theories of quantum gravity, on backgrounds involving AdS_5 . For simplicity we will only discuss here backgrounds which are direct products of the form $AdS_5 \times X$.

Given such a background of string/M theory, it is not a priori clear what is the conformal field theory to which it corresponds. A special class of backgrounds are those which arise as near-horizon limits of branes, like the $AdS_5 \times S^5$ background. In this case one can sometimes analyze the low-energy field theory on the branes by standard methods before taking the near-horizon limit, and after the limit this becomes the dual conformal field theory. The most well-studied case is the case of D3-branes in type IIB string theory. When the D3-branes are at a generic point in space-time

¹If we have a topological field theory on the boundary the bulk theory does not have to be gravitational, as in [329].

the near-horizon limit gives the $AdS_5 \times S^5$ background discussed extensively above. However, if the transverse space to the D3-branes is singular, the near-horizon limit and the corresponding field theory can be different. The simplest case is the case of a D3-brane on an orbifold [330] or orientifold [216] singularity, which can be analyzed by perturbative string theory methods. These cases will be discussed in sections 4.1.1 and 4.1.2. Another interesting case is the conifold singularity [217] and its generalizations, which will be discussed in section 4.1.3. In this case a direct analysis of the field theory is not possible, but various indirect arguments can be used to determine what it is in many cases.

Not much is known about more general cases of near-horizon limits of D3-branes, which on the string theory side were analyzed in [331, 332, 333, 334, 335], and even less is known about backgrounds which are not describable as near-horizon limits of branes (several AdS_5 backgrounds were discussed in [336]). An example of the latter is the $AdS_5 \times \mathbf{CP}^3$ background of M theory [337], which involves a 4-form flux on the 4-cycle in \mathbf{CP}^3 . Using the methods described in the previous sections we can compute various properties of such compactifications in the large N limit, such as the mass spectrum and the central charge of the corresponding field theories (for the $AdS_5 \times \mathbf{CP}^3$ compactification one finds a central charge proportional to N^3 , where N is the 4-form flux). However, it is not known how to construct an alternative description of the conformal field theory in most of these cases, except for the cases which are related by deformations to the better-understood orbifold and conifold compactifications.

Some of the $AdS_5 \times X$ backgrounds of string/M theory preserve some number of supersymmetries, but most of them (such as the $AdS_5 \times \mathbf{CP}^3$ background) do not. In supersymmetric cases, supersymmetry guarantees the stability of the corresponding solutions. In the non-supersymmetric cases various instabilities may arise for finite N (see, for instance, [338, 339]) which may destroy the conformal ($SO(4, 2)$) invariance, but the correspondence is still conjectured to be valid when all quantum corrections are taken into account (or in the infinite N limit for which the supergravity approximation is valid). One type of instability occurs when the spectrum includes a tachyonic field whose mass is below the Breitenlohner-Freedman stability bound. Such a field is expected to condense just like a tachyon in flat space, and generally it is not known what this condensation leads to. If the classical supergravity spectrum includes a field which saturates the stability bound, an analysis of the quantum corrections is necessary to determine whether they raise the mass squared of the field (leading to a stable solution) or lower it (leading to an unstable solution). Apriori one would not expect to have a field which exactly saturates the bound (corresponding to an operator in the field theory whose dimension is exactly $\Delta = 2$) in a non-supersymmetric theory, but this often happens in orbifold theories for reasons that will be discussed below. Another possible instability arises when there is a massless field in the background,

corresponding to a marginal operator in the field theory. Such a field (the dilaton) exists in all classical type IIB compactifications, and naively corresponds to an exactly marginal deformation of the theory even in the non-supersymmetric cases. However, for finite N one would expect quantum corrections to generate a potential for such a field (if it is neutral under the gauge symmetries), which could drive its expectation value away from the range of values where the supergravity approximation is valid. Again, an analysis of the quantum corrections is necessary in such a case to determine if the theory has a stable vacuum (which may or may not be describable in supergravity), corresponding to a fixed point of the corresponding field theory, or if the potential leads to a runaway behavior with no stable vacuum. Another possible source of instabilities is related to the possibility of forming brane-anti-brane pairs in the vacuum (or, equivalently, the emission of branes which destabilize the vacuum) [340, 341, 342, 343]; one would expect such an instability to arise, for example, in cases where we look at the near-horizon limit of N 3-branes which have a repulsive force between them. For all these reasons, the study of non-supersymmetric backgrounds usually requires an understanding of the quantum corrections, which are not yet well-understood either in M theory or in type IIB compactifications with RR backgrounds. Thus, we will focus here on supersymmetric backgrounds, for which the supergravity approximation is generally valid. In the non-supersymmetric cases the correspondence is still expected to be valid, and in the extreme large N limit it can also be studied using supergravity, but getting finite N information usually requires going beyond the SUGRA approximation. It would be very interesting to understand better the quantum corrections in order to study non-supersymmetric theories at finite N using the AdS/CFT correspondence.

4.1.1 Orbifolds of $AdS_5 \times S^5$

The low-energy field theory corresponding to D3-branes at orbifold singularities may be derived by string theory methods [344, 345]. Generally the gauge group is of the form $\prod_i U(a_i N)$, and there are various bifundamental (and sometimes also adjoint) matter fields². We are interested in the near-horizon limit of D3-branes sitting at the origin of $\mathbb{R}^4 \times \mathbb{R}^6 / \Gamma$ for some finite group Γ which is a discrete subgroup of the $SO(6) \simeq SU(4)_R$ rotation symmetry [330]. If $\Gamma \subset SU(3) \subset SU(4)_R$ the theory on the D3-branes has $\mathcal{N} = 1$ supersymmetry, and if $\Gamma \subset SU(2) \subset SU(4)_R$ it has $\mathcal{N} = 2$ supersymmetry. The near-horizon limit of such a configuration is of the form $AdS_5 \times S^5 / \Gamma$ (since the orbifold commutes with taking the near-horizon limit), and corresponds (at least for large N)

²In general one can choose to have the orbifold group act on the Chan-Paton indices in various ways. We will discuss here only the case where the group acts as N copies of the regular representation of the orbifold group Γ , which is the only case which leads to conformal theories. Other representations involve also 5-branes wrapped around 2-cycles, so they do not arise in the naive near-horizon limit of D3-branes. The AdS_5 description of this was given in [218].

to a conformal theory with the appropriate amount of supersymmetry. Note that on neither side of the correspondence is the orbifolding just a projection on the Γ -invariant states of the original theory – on the string theory side we need to add also twisted sectors, while on the field theory side the gauge group is generally much larger (though the field theory can be viewed as a projection of the gauge theory corresponding to $\dim(\Gamma) \cdot N$ D-branes).

We will start with a general analysis of the orbifold, and then discuss specific examples with different amounts of supersymmetry³. The action of Γ on the S^5 is the same as its action on the angular coordinates of \mathbb{R}^6 . If the original action of Γ had only the origin as its fixed point, the space S^5/Γ is smooth. On the other hand, if the original action had a space of fixed points, some fixed points remain, and the space S^5/Γ includes orbifold singularities. In this case the space is not geometrically smooth, and the supergravity approximation is not valid (though of course in string theory it is a standard orbifold compactification which is generically not singular). The spectrum of string theory on $AdS_5 \times S^5/\Gamma$ includes states from untwisted and twisted sectors of the orbifold. The untwisted states are just the Γ -projection of the original states of $AdS_5 \times S^5$, and they include in particular the Γ -invariant supergravity states. These states have (in the classical supergravity limit) the same masses as in the original $AdS_5 \times S^5$ background [347], corresponding to integer dimensions in the field theory, which is why we often find in orbifolds operators of dimension 2 or 4 which can destabilize non-supersymmetric backgrounds. If the orbifold group has fixed points on the S^5 , there are also light twisted sector states that are localized near these fixed points, which need to be added to the supergravity fields for a proper description of the low-energy dynamics. On the other hand, if the orbifold has no fixed points, all twisted sector states are heavy,⁴ since they involve strings stretching between identified points on the S^5 . In this case the twisted sector states decouple from the low-energy theory in space-time (for large $g_s N$). There is a global Γ symmetry in the corresponding field theory, under which the untwisted sector states are neutral while the twisted sector states are charged.

In the 't Hooft limit of $N \rightarrow \infty$ with $g_s N$ finite, all the solutions of the form $AdS_5 \times S^5/\Gamma$ have a fixed line corresponding to the dilaton, indicating that the beta function of the corresponding field theories vanishes in this limit [330]. In fact, one can prove [348, 349, 350] (see also [351, 352]) that in this limit, which corresponds to keeping only the planar diagrams in the field theory, all the correlation functions of the untwisted sector operators in the orbifold theories are the same (up to multiplication

³We will not discuss here orbifolds that act non-trivially on the AdS space, as in [346].

⁴Note that this happens even when in the original description there were massless twisted sector states localized at the origin.

by some power of $\dim(\Gamma)$) as in the $\mathcal{N} = 4$ SYM theory corresponding to $AdS_5 \times S^5$ ⁵. This is the analog of the usual string theory statement that at tree-level the interactions of untwisted sector states are exactly inherited from those of the original theory before the orbifolding. For example, the central charge of the field theory (appearing in the 2-point function of the energy-momentum tensor) is (in this limit) just $\dim(\Gamma)$ times the central charge of the corresponding $\mathcal{N} = 4$ theory. This may easily be seen also on the string theory side, where the central charge may be shown [173] to be inversely proportional to the volume of the compact space (and $\text{Vol}(S^5/\Gamma) = \text{Vol}(S^5)/\dim(\Gamma)$).

The vanishing of the beta function in the 't Hooft limit follows from this general result (as predicted by the AdS/CFT correspondence). This applies both to orbifolds which preserve supersymmetry and to those which do not, and leads to many examples of supersymmetric and non-supersymmetric theories which have fixed lines in the large N limit. At subleading orders in $1/N$, the correlation functions differ between the orbifold theory and the $\mathcal{N} = 4$ theory, and in principle a non-zero beta function may arise. In supersymmetric orbifolds supersymmetry prevents this⁶, but in non-supersymmetric theories generically there will no longer be a fixed line for finite N . The dilaton potential is then related to the appearance of a non-zero beta function in the field theory, and the minima of this potential are related to the zeros of the field theory beta function for finite N .

As a first example we can analyze the case [330] of D3-branes on an $\mathbb{R}^4/\mathbb{Z}_k$ orbifold singularity, which preserves $\mathcal{N} = 2$ supersymmetry. Before taking the near-horizon limit, the low-energy field theory (at the free orbifold point in the string theory moduli space) is a $U(N)^k$ gauge theory with bifundamental hypermultiplets in the $(\mathbf{N}, \bar{\mathbf{N}}, \mathbf{1}, \dots, \mathbf{1}) + (\mathbf{1}, \mathbf{N}, \bar{\mathbf{N}}, \mathbf{1}, \dots, \mathbf{1}) + \dots + (\mathbf{1}, \dots, \mathbf{1}, \mathbf{N}, \bar{\mathbf{N}}) + (\bar{\mathbf{N}}, \mathbf{1}, \dots, \mathbf{1}, \mathbf{N})$ representation. The bare gauge couplings τ_i of all the $U(N)$ theories are equal to the string coupling τ_{IIB} at this point in the moduli space. In the near-horizon (low-energy) limit this field theory becomes the $SU(N)^k$ field theory with the same matter content, since the off-diagonal $U(1)$ factors are IR-free⁷ (and the diagonal $U(1)$ factor is decoupled here and in all other examples in this section so we will ignore it). This theory is dual to type IIB string theory on $AdS_5 \times S^5/\mathbb{Z}_k$, where the \mathbb{Z}_k action leaves fixed an S^1 inside the S^5 .

This field theory is known (see, for instance, [353]) to be a finite field theory for any value of the k gauge couplings τ_i , corresponding to a k -complex-dimensional surface of conformal field theories. Thus, we should see k complex parameters in the string

⁵There is no similar relation for the twisted sector operators.

⁶At least, it prevents a potential for the dilaton, so there is still some fixed line in the field theory, though it can be shifted from the $\mathcal{N} = 4$ fixed line when $1/N$ corrections are taken into account.

⁷This does not contradict our previous statements about the beta functions since the $U(1)$ factors are subleading in the $1/N$ expansion, and the operators corresponding to the off-diagonal $U(1)$'s come from twisted sectors.

theory background which we can change without destroying the AdS_5 component of this background. One such parameter is obviously the dilaton, and the other $(k - 1)$ may be identified [330] with the values of the NS-NS and R-R 2-form B -fields on the $(k - 1)$ 2-cycles which vanish at the \mathbb{Z}_k orbifold singularity (these are part of the blow-up modes for the singularities; the other blow-up modes turn on fields which change the AdS_5 background, and correspond to non-marginal deformations of the field theory).

The low-energy spectrum has contributions both from the untwisted and from the twisted sectors. The untwisted sector states are just the \mathbb{Z}_k projection of the original $AdS_5 \times S^5$ states. The twisted sector states are the same (for large N and at low energies) as those which appear in flat space at an $\mathbb{R}^4/\mathbb{Z}_k$ singularity, except that here they live on the fixed locus of the \mathbb{Z}_k action which is of the form $AdS_5 \times S^1$. At the orbifold point the massless twisted sector states are $(k - 1)$ tensor multiplets (these tensor multiplets include scalars corresponding to the 2-form B -fields described above). Upon dimensional reduction on the S^1 these give rise to $(k - 1)$ $U(1)$ gauge fields on AdS_5 , which correspond to the $U(1)$ global symmetries of the field theory (which were the off-diagonal gauge $U(1)$'s before taking the near-horizon limit, and become global symmetries after this limit); see, e.g. [354]. The orbifold point corresponds to having all the B -fields maximally turned on [355]. The spectrum of fields on AdS_5 in this background was successfully compared [356] to the spectrum of chiral operators in the field theory. If we move in the string theory moduli space to a point where the B -fields on some 2-cycles are turned off, the D3-branes wrapped around these 2-cycles become tensionless, and the low-energy theory becomes a non-trivial $\mathcal{N} = (2, 0)$ six dimensional SCFT (see [93] and references therein). The low-energy spectrum on AdS_5 then includes the dimensional reduction of this conformal theory on a circle. In particular, when all the B -fields are turned off, we get the A_{k-1} $(2, 0)$ theory, which gives rise to $SU(k)$ gauge fields at low-energies upon compactification on a circle. Thus, the AdS/CFT correspondence predicts an enhanced global $SU(k)$ symmetry at a particular point in the parameter space of the corresponding field theory. Presumably, this point is in a very strongly coupled regime (the string coupling $\tau_{IIB} \propto \sum_i \tau_i$ may be chosen to be weak, but individual τ_i 's can still be strongly coupled) which cannot be accessed directly in the field theory. The field theory in this case has a large group of duality symmetries [353], which includes (but is not limited to) the $SL(2, \mathbb{Z})$ subgroup which acts on the couplings as $\tau \rightarrow (a\tau + b)/(c\tau + d)$ at the point where they are all equal. In the type IIB background the $SL(2, \mathbb{Z})$ subgroup of this duality group is manifest, but it is not clear how to see the rest of this group.

Our second example corresponds to D3-branes at an $\mathbb{R}^6/\mathbb{Z}_3$ orbifold point, where, if we write \mathbb{R}^6 as \mathbb{C}^3 with complex coordinates z_j ($j = 1, 2, 3$), the \mathbb{Z}_3 acts as $z_j \rightarrow e^{2\pi i/3} z_j$. In this case the only fixed point of the \mathbb{Z}_3 action is the origin, so in the near-horizon limit we get [330] $AdS_5 \times S^5/\mathbb{Z}_3$ where the compact space is smooth. Thus, the low-

energy spectrum in this case (for large $g_s N$) includes only the \mathbb{Z}_3 projection of the original supergravity spectrum, and all twisted sector states are heavy in this limit.

The corresponding field theory may be derived by the methods of [344, 345]. It is an $SU(N)^3$ gauge theory, with chiral multiplets U_j ($j = 1, 2, 3$) in the $(\mathbf{N}, \bar{\mathbf{N}}, \mathbf{1})$ representation, V_j ($j = 1, 2, 3$) in the $(\mathbf{1}, \mathbf{N}, \bar{\mathbf{N}})$ representation, and W_j ($j = 1, 2, 3$) in the $(\bar{\mathbf{N}}, \mathbf{1}, \mathbf{N})$ representation, and a classical superpotential of the form $W = g\epsilon^{ijk}U_i V_j W_k$. In the classical theory all three gauge couplings and the superpotential coupling g are equal (and equal to the string coupling). In the quantum theory one can prove that in the space of these four parameters there is a one dimensional line of superconformal fixed points. The parameter which parameterizes this fixed line (which passes through weak coupling in the gauge theory) may be identified with the dilaton in the $AdS_5 \times S^5/\mathbb{Z}_3$ background. Unlike the previous case, here there are no indications of additional marginal deformations, and no massless twisted sector states on AdS_5 which they could correspond to.

As in the previous case, one can try to compare the spectrum of fields on AdS_5 with the spectrum of chiral operators in the field theory. In this case, as in all cases with less than $\mathcal{N} = 4$ supersymmetry, not all the supergravity fields on AdS_5 are in chiral multiplets, since the $\mathcal{N} = 4$ chiral multiplets split into chiral, anti-chiral and non-chiral multiplets when decomposed into $\mathcal{N} = 2$ (or $\mathcal{N} = 1$) representations⁸ (in general there can also be various sizes of chiral multiplets). However, one can still compare those of the fields which are in chiral multiplets (and have the appropriate relations between their AdS mass / field theory dimension and their R-charges). The untwisted states may easily be matched since they are a projection of the original states both in space-time and in the field theory (if we think of the field theory as a projection of the $\mathcal{N} = 4$ $SU(3N)$ gauge theory). Looking at the twisted sectors we seem to encounter a paradox [333]. On the string theory side all the twisted sector states are heavy (they correspond to strings stretched across the S^5 , so they would correspond to operators with $\Delta \simeq mR \simeq R^2/l_s^2 \simeq (g_s N)^{1/2}$). On the field theory side we can identify the twisted sector fields with operators which are charged under the global \mathbb{Z}_3 symmetry which rotates the three gauge groups, and naively there exist chiral operators which are charged under this symmetry and remain of finite dimension in the large $N, g_{YM}^2 N$ limit. However, a careful analysis shows that all of these operators are in fact descendants, so their dimensions are not protected. For example, the operator $\sum_{j=1}^3 e^{2\pi i j/3} \text{Tr}((W_\alpha^{(j)})^2)$, where $W_\alpha^{(j)}$ is the field strength multiplet of the j 'th $SU(N)$ group, seems to be a chiral superfield charged under the \mathbb{Z}_3 symmetry. However, using linear combinations of the Konishi anomaly equations [357, 358] for the three gauge groups, one can show that this operator (and all other “twisted sector” operators) is in

⁸Note that this means that unlike the $AdS_5 \times S^5$ case, in cases with less SUSY there are always non-chiral operators which have a finite dimension in the large $N, g_{YM}^2 N$ limit.

fact a descendant, so there is no paradox. The AdS/CFT correspondence predicts that in the large N , $g_{YM}^2 N$ limit the dimension of all these \mathbb{Z}_3 -charged operators scales as $(g_{YM}^2 N)^{1/2}$, which is larger than the scaling $\Delta \sim (g_{YM}^2 N)^{1/4}$ for the non-chiral operators in the $\mathcal{N} = 4$ SYM theory in the same limit. It would be interesting to verify this behavior in the field theory. Baryon-like operators also exist in these theories [359], which are similar to those which will be discussed in section 4.1.3.

There are various other supersymmetric orbifold backgrounds which behave similarly to the examples we have described in detail here. There are also many non-supersymmetric examples [360, 361] but, as described above, their fate for finite N is not clear, and we will not discuss them in detail here.

4.1.2 Orientifolds of $AdS_5 \times S^5$

The discussion of the near-horizon limits of D3-branes on orientifolds is mostly similar to the discussion of orbifolds, except for the absence of twisted sector states (which do not exist for orientifolds). We will focus here on two examples which illustrate some of the general properties of these backgrounds. Additional examples were discussed in [362, 363, 364, 365, 366, 367, 368, 369].

Our first example is the near-horizon limit of D3-branes on an orientifold 3-plane. The orientifold breaks the same supersymmetries as the 3-branes do, so in the near horizon limit we have the full 32 supercharges corresponding to a $d = 4, \mathcal{N} = 4$ SCFT. In flat space there are (see [370] and references therein) two types of orientifold planes which lead to different projections on D-brane states. One type of orientifold plane leads to a low-energy $SO(2N)$ $\mathcal{N} = 4$ gauge theory for N D-branes on the orientifold, while the other leads to a $USp(2N)$ $\mathcal{N} = 4$ gauge theory. In the first case we can also have an additional “half D3-brane” stuck on the orientifold, leading to an $SO(2N + 1)$ $\mathcal{N} = 4$ gauge theory. In the near-horizon limits of branes on the orientifold we should be able to find string theory backgrounds which are dual to all of these gauge theories.

The near-horizon limit of these brane configurations is type IIB string theory on $AdS_5 \times S^5/\mathbb{Z}_2 \equiv AdS_5 \times \mathbf{RP}^5$, where the \mathbb{Z}_2 acts by identifying opposite points on the S^5 , so there are no fixed points and the space \mathbf{RP}^5 is smooth. The manifestation of the orientifolding in the near-horizon limit is that when a string goes around a non-contractible cycle in \mathbf{RP}^5 (connecting opposite points of the S^5) its orientation is reversed. In all the cases discussed above the string theory perturbation expansion had only closed orientable surfaces, so it was a power series in g_s^2 (or in $1/N^2$ in the 't Hooft limit); but in this background we can also have non-orientable closed surfaces which include crosscaps, and the perturbation expansion includes also odd powers of g_s (or of $1/N$ in the 't Hooft limit). In fact, it has long been known [37] that in the 't Hooft limit the $SO(N)$ and $USp(N)$ gauge theories give rise to Feynman diagrams

that involve also non-orientable surfaces (as opposed to the $SU(N)$ case which gives only orientable surfaces), so it is not surprising that such diagrams arise in the string theory which is dual to these theories. While in the cases described above the leading correction in string perturbation theory was of order g_s^2 (or $1/N^2$ in the 't Hooft limit), in the $AdS_5 \times \mathbf{RP}^5$ background (and in general in orientifold backgrounds) the leading correction comes from \mathbf{RP}^2 worldsheets and is of order g_s (or $1/N$ in the 't Hooft limit). Such a correction appears, for instance, in the computation of the central charge (the 2-point function of the energy-momentum tensor) of these theories, which is proportional to the dimension of the corresponding gauge group.

Our discussion so far has not distinguished between the different configurations corresponding to $SO(2N)$, $SO(2N+1)$ and $USp(2N)$ groups (the only obvious parameter in the orientifold background is the 5-form flux N). In the Feynman diagram expansion it is well-known [371, 372] that the $SO(2N)$ and $USp(2N)$ theories are related by a transformation taking N to $(-N)$, which inverts the sign of all diagrams with an odd number of crosscaps in the 't Hooft limit. Thus, we should look for a similar effect in string theory on $AdS_5 \times \mathbf{RP}^5$. It turns out [216] that this is implemented by a “discrete torsion” on \mathbf{RP}^5 , corresponding to turning on a B_{NS-NS} 2-form in the non-trivial cohomology class of $H^3(\mathbf{RP}^5, \tilde{\mathbb{Z}}) = \mathbb{Z}_2$. The effect of turning on this “discrete torsion” is exactly to invert the sign of all string diagrams with an odd number of crosscaps. It is also possible to turn on a similar “discrete torsion” for the RR 2-form B -field, so there is a total of four different possible string theories on $AdS_5 \times \mathbf{RP}^5$. It turns out that the theory with no B -fields is equivalent to the $SO(2N)$ $\mathcal{N} = 4$ gauge theory, which is self-dual under the S-duality group $SL(2, \mathbb{Z})$. The theory with only a non-zero B_{RR} field is equivalent to the $SO(2N+1)$ gauge theory, while the theories with non-zero B_{NS-NS} fields are equivalent to the $USp(2N)$ gauge theory [216], and this is consistent with the action of S-duality on these groups and on the 2-form B -fields (which are a doublet of $SL(2, \mathbb{Z})$).

An interesting test of this correspondence is the matching of chiral primary fields. In the supergravity limit the fields on $AdS_5 \times \mathbf{RP}^5$ are just the \mathbb{Z}_2 projection of the fields on $AdS_5 \times S^5$, including the multiplets with $n = 2, 4, 6, \dots$ (in the notation of section 3.2). This matches with almost all the chiral superfields in the corresponding gauge theories, which are described as traces of products of the fundamental fields as in section 3.2, but with the trace of a product of an odd number of fields vanishing in these theories from symmetry arguments. However, in the $SO(2N)$ gauge theories (and not in any of the others) there is an additional gauge invariant chiral superfield, called the Pfaffian, whose lowest component is of the form $\epsilon^{a_1 a_2 \dots a_{2N}} \phi_{a_1 a_2}^{I_1} \phi_{a_3 a_4}^{I_2} \dots \phi_{a_{2N-1} a_{2N}}^{I_N}$, where a_i are $SO(2N)$ indices and the I_j are (symmetric traceless) indices in the $\mathbf{6}$ of $SU(4)_R$. The supersymmetry algebra guarantees that the dimension of this operator is $\Delta = N$, and it is independent of the other gauge-invariant chiral superfields. This

operator may be identified with the field on AdS_5 corresponding to a D3-brane wrapped around a 3-cycle in \mathbf{RP}^5 , corresponding to the homology class $H_3(\mathbf{RP}^5, \mathbb{Z}) = \mathbb{Z}_2$. This wrapping is only possible when no B -fields are turned on [216], consistent with such an operator existing for $SO(2N)$ but not for $SO(2N + 1)$ or $USp(2N)$. While it is not known how to compute the mass of this state directly, the superconformal algebra guarantees that it has the right mass to correspond to an operator with $\Delta = N$; the naive approximation to the mass, since the volume of the 3-cycle in \mathbf{RP}^5 is $\pi^2 R^3$, is $mR \simeq R \cdot \pi^2 R^3 / (2\pi)^3 g_s l_s^4 = R^4 / 8\pi l_p^4 \simeq N$ (since in the orientifold case $R^4 \simeq 4\pi(2N)l_p^4$ instead of equation (3.3)), which leads to the correct dimension for large N . The existence of this operator (which decouples in the large N limit) is an important test of the finite N correspondence. Anomaly matching in this background was discussed in [233].

Another interesting background is the near-horizon limit of D3-branes on an orientifold 7-plane, with 4 D7-branes coincident on the orientifold plane to ensure [373, 374] that the dilaton is constant and the low-energy theory is conformal (this is the same as D3-branes in F-theory [375] at a D_4 -type singularity). The field theory we get in the near-horizon limit in this case is [376, 377] an $\mathcal{N} = 2$ SQCD theory with $USp(2N)$ gauge group, a hypermultiplet in the anti-symmetric representation and four hypermultiplets in the fundamental representation. In this case the orientifold action has fixed points on the S^5 , so the near-horizon limit is [378, 379] type IIB string theory on $AdS_5 \times S^5/\mathbb{Z}_2$ where the \mathbb{Z}_2 action has fixed points on an S^3 inside the S^5 . Thus, this background includes an orientifold plane with the topology of $S^3 \times AdS_5$, and the D7-branes stretched along the orientifold plane also remain as part of the background, so that the low-energy theory includes both the supergravity modes in the bulk and the $SO(8)$ gauge theory on the D7-branes (which corresponds to an $SO(8)$ global symmetry in the corresponding field theories)⁹. The string perturbation expansion in this case has two sources of corrections of order g_s , the crosscap diagram and the open string disc diagram with strings ending on the D7-brane, leading to two types of corrections of order $1/N$ in the 't Hooft limit. Again, the spectrum of operators in the field theory may be matched [379] with the spectrum of fields coming from the dimensional reduction of the supergravity theory in the bulk and of the 7-brane theory wrapped on the S^3 . The anomalies may also be matched to the field theory, including $1/N$ corrections to the leading large N result [232] which arise from disc and crosscap diagrams.

By studying other backgrounds of D3-branes with 7-branes (with or without orientifolds) one can obtain non-conformal theories which exhibit a logarithmic running of the coupling constant [379, 380]. For instance, by separating the D7-branes away from the orientifold plane, corresponding to giving a mass to the hypermultiplets in the fundamental representation, one finds string theory solutions in which the dilaton

⁹Similar backgrounds were discussed in [172].

varies in a similar way to the variation of the coupling constant in the field theory, and this behavior persists also in the near-horizon limit (which is quite complicated in this case, and becomes singular close to the branes, corresponding to the low-energy limit of the field theories which is in this case a free Abelian Coulomb phase). This agreement with the perturbative expectation, even though we are (necessarily) in a regime of large $\lambda = g_{YM}^2 N$, is due to special properties of $\mathcal{N} = 2$ gauge theories, which prevent many quantities from being renormalized beyond one-loop.

4.1.3 Conifold theories

In the correspondence between string theory on $AdS_5 \times S^5$ and $d = 4$ $\mathcal{N} = 4$ SYM theories, some of the most direct checks, such as protected operator dimensions and the functional form of two- and three-point functions, are determined by properties of the supergroup $SU(2, 2|4)$. Many of the normalizations of two- and three-point functions which have been computed explicitly are protected by non-renormalization theorems. And yet, we are inclined to believe that the correspondence is a fundamental dynamical principle, valid independent of group theory and the special non-renormalization properties of $\mathcal{N} = 4$ supersymmetry.

To test this belief we want to consider theories with reduced supersymmetry. Orbifold theories [330] provide interesting examples; however, as discussed in the previous sections, it has been shown [349, 350] that at large N these theories are a projection of $\mathcal{N} = 4$ super-Yang-Mills theory; in particular many of their Green's functions are dictated by the Green's functions of the $\mathcal{N} = 4$ theory. The projection involved is onto states invariant under the group action that defines the orbifold. Intuitively, this similarity with the $\mathcal{N} = 4$ theory arises because the compact part of the geometry is still (almost everywhere) locally S^5 , just with some global identifications. Therefore, to make a more non-trivial test of models with reduced supersymmetry, we are more interested in geometries of the form $AdS_5 \times M_5$ where the compact manifold M_5 is not even locally S^5 .

In fact, such compactifications have a long history in the supergravity literature: the direct product geometry $AdS_5 \times M_5$ is known as the Freund-Rubin ansatz [113]. The curvature of the anti-de Sitter part of the geometry is supported by the five-form of type IIB supergravity. Because this five-form is self-dual, M_5 must also be an Einstein manifold, but with positive cosmological constant: rescaling M_5 if necessary, we can write $\mathcal{R}_{\alpha\beta} = 4g_{\alpha\beta}$. For simplicity, we are assuming that only the five-form and the metric are involved in the solution.

A trivial but useful observation is that five-dimensional Einstein manifolds with $\mathcal{R}_{\alpha\beta} = 4g_{\alpha\beta}$ are in one-to-one correspondence with Ricci-flat manifolds C_6 whose metric

has the conical form

$$ds_{C_6}^2 = dr^2 + r^2 ds_{M_5}^2 . \quad (4.1)$$

It can be shown that, given any metric of the form (4.1), the ten-dimensional metric

$$ds_{10}^2 = \left(1 + \frac{R^4}{r^4}\right)^{-1/2} \left(-dt^2 + dx_1^2 + dx_2^2 + dx_3^2\right) + \left(1 + \frac{R^4}{r^4}\right)^{1/2} ds_{C_6}^2 \quad (4.2)$$

is a solution of the type IIB supergravity equations, provided one puts N units of five-form flux through the manifold M_5 , where

$$R^4 = \frac{\sqrt{\pi}}{2} \frac{\kappa N}{\text{Vol } M_5} . \quad (4.3)$$

Furthermore, it was shown in [172] that the number of supersymmetries preserved by the geometry (4.2) is half the number that are preserved by its Ricci-flat $R \rightarrow 0$ limit. Preservation of supersymmetry therefore amounts to the existence of a Killing spinor on $ds_{C_6}^2$, which would imply that it is a Calabi-Yau metric. Finally, the $r \ll R$ limit of (4.2) is precisely $AdS_5 \times M_5$, and in that limit the number of preserved supersymmetries doubles.

These facts suggest a useful means of searching for non-trivial Freund-Rubin geometries: starting with a string vacuum of the form $\mathbb{R}^{3,1} \times C_6$, where C_6 is Ricci-flat, we locate a singularity of C_6 where the metric locally has the form (4.1), and place a large number of D3-branes at that point. The resulting near-horizon Freund-Rubin geometry has the same number of supersymmetries as the original braneless string geometry. The program of searching for and classifying such singularities on manifolds preserving some supersymmetry was enunciated most completely in [333].

We will focus our attention on the simplest non-trivial example, which was worked out in [217]¹⁰. C_6 is taken to be the standard conifold, which as a complex 3-fold is determined by the equation

$$z_1^2 + z_2^2 + z_3^2 + z_4^2 = 0 . \quad (4.4)$$

The Calabi-Yau metric on this manifold has $SU(3)$ holonomy, so one quarter of supersymmetry is preserved. We will always count our supersymmetries in four-dimensional superconformal field theory terms, so one quarter of maximal supersymmetry (that is, eight real supercharges) is in our terminology $\mathcal{N} = 1$ supersymmetry (superconformal symmetry). The supergravity literature often refers to this amount of supersymmetry in five dimensions as $\mathcal{N} = 2$, because in a flat space supergravity theory with this

¹⁰Additional aspects and examples of conifold theories were discussed in [381, 382, 383, 384, 385, 386].

much supersymmetry, reduction on S^1 without breaking any supersymmetry leads to a supergravity theory in four dimensions with $\mathcal{N} = 2$ supersymmetry.

The Calabi-Yau metric on the manifold (4.4) may be derived from the Kähler potential $K = \left(\sum_{i=1}^4 |z_i|^2\right)^{2/3}$, and can be explicitly written as

$$ds_{C_6}^2 = dr^2 + r^2 ds_{T^{11}}^2, \quad (4.5)$$

where $ds_{T^{11}}^2$ is the Einstein metric on the coset space

$$T^{11} = \frac{SU(2) \times SU(2)}{U(1)}. \quad (4.6)$$

In the quotient (4.6), the $U(1)$ generator is chosen to be the sum $\frac{1}{2}\sigma_3 + \frac{1}{2}\tau_3$ of generators of the two $SU(2)$'s. The manifolds T^{pq} , where the $U(1)$ generator is chosen to be $\frac{p}{2}\sigma_3 + \frac{q}{2}\tau_3$, with p and q relatively prime, were studied in [174]. The topology of each of these manifolds is $S^2 \times S^3$. They all admit unique Einstein metrics. Only T^{11} leads to a six-manifold C_6 which admits Killing spinors. In fact, besides $S^5 = SO(6)/SO(5)$, T^{11} is the unique five-dimensional coset space which preserves supersymmetry. The Einstein metrics can be obtained via a rescaling of the Killing metric on $SU(2) \times SU(2)$ by a process explained in [174]. The metric on T^{11} satisfying $\mathcal{R}_{\alpha\beta} = 4g_{\alpha\beta}$ can be written as

$$ds_{T^{11}}^2 = \frac{1}{6} \sum_{i=1}^2 \left(d\theta_i^2 + \sin^2 \theta_i d\phi_i^2 \right) + \frac{1}{9} (d\psi + \cos \theta_1 d\phi_1 + \cos \theta_2 d\phi_2)^2. \quad (4.7)$$

The volume of this metric is $16\pi^3/27$, whereas the volume of the unit five-sphere, which also has $\mathcal{R}_{\alpha\beta} = 4g_{\alpha\beta}$, is π^3 .

Perhaps the most intuitive way to motivate the conjectured dual gauge theory [217] is to first consider the S^5/\mathbb{Z}_2 orbifold gauge theory, where the \mathbb{Z}_2 is chosen to flip the signs of four of the six real coordinates in \mathbb{R}^6 , and thus has a fixed S^1 on the unit S^5 in this flat space. This \mathbb{Z}_2 breaks $SO(6)$ down to $SO(4) \times SO(2)$, which is the same isometry group as for T^{11} . In fact, it can also be shown that an appropriate blowup of the singularities along the fixed S^1 leads to a manifold of topology $S^2 \times S^3$. Since T^{11} is a smooth deformation of the blown-up orbifold, one might suspect that its dual field theory is some deformation of the orbifold's dual field theory. The latter field theory is well known [330], as described in section 4.1.1. It has $\mathcal{N} = 2$ supersymmetry. The field content in $\mathcal{N} = 1$ language is

gauge group	$SU(N)$	$SU(N)$	
chirals A_1, A_2	\square	$\bar{\square}$	
chirals B_1, B_2	$\bar{\square}$	\square	(4.8)
chiral Φ	adj	$\mathbf{1}$	
chiral $\tilde{\Phi}$	$\mathbf{1}$	adj.	

The adjoint chiral fields Φ and $\tilde{\Phi}$, together with the $\mathcal{N} = 1$ gauge multiplets, fill out $\mathcal{N} = 2$ gauge multiplets. The chiral multiplets A_1, B_1 combine to form an $\mathcal{N} = 2$ hypermultiplet, and so do A_2, B_2 . The superpotential is dictated by $\mathcal{N} = 2$ supersymmetry:

$$W = g\text{Tr}\Phi(A_1B_1 + A_2B_2) + g\text{Tr}\tilde{\Phi}(B_1A_1 + B_2A_2) , \quad (4.9)$$

where g is the gauge coupling of both $SU(N)$ gauge groups. A relevant deformation which preserves the global $SU(2) \times SU(2) \times U(1)$ symmetry, and also $\mathcal{N} = 1$ supersymmetry, is

$$W \rightarrow W + \frac{1}{2}m \left(\text{Tr}\Phi^2 - \text{Tr}\tilde{\Phi}^2 \right) . \quad (4.10)$$

There is a nontrivial renormalization group flow induced by these mass terms. The existence of a non-trivial infrared fixed point can be demonstrated using the methods of [387]: having integrated out the heavy fields Φ and $\tilde{\Phi}$, the superpotential is quartic in the remaining fields, which should, therefore, all have dimension $3/4$ at the infrared fixed point (assuming that we do not break the symmetry between the two gauge groups). The anomalous dimension $\gamma = -1/2$ for the quadratic operators $\text{Tr}AB$ is precisely what is needed to make the exact beta functions vanish.

The IR fixed point of the renormalization group described in the previous paragraph is the candidate for the field theory dual to type IIB string theory on $AdS_5 \times T^{11}$, or in weak coupling terms the low-energy field theory of coincident D3-branes on a conifold singularity. There are several non-trivial checks that this is the right theory. The simplest is to note that the moduli space of the $N = 1$ version of the theory is simply the conifold. For $N = 1$ the scalar fields a_i and b_j (in the chiral multiplets A_i and B_j) are just complex-valued. The moduli space can be parametrized by the combinations $a_i b_j$, and if we write

$$\begin{pmatrix} z_1 + iz_4 & iz_2 + z_3 \\ iz_2 - z_3 & z_1 - iz_4 \end{pmatrix} = \begin{pmatrix} a_1 b_1 & a_1 b_2 \\ a_2 b_1 & a_2 b_2 \end{pmatrix} , \quad (4.11)$$

then we recover the conifold equation (4.4) by taking the determinant of both sides. In the $N > 1$ theories, a slight generalization of this line of argument leads to the conclusion that the fully Higgsed phase of the theory, where all the D3-branes are separated from one another, has for its moduli space the N^{th} symmetric power of the conifold.

The most notable prediction of the renormalization group analysis of the gauge theory is that the operators $\text{Tr}A_i B_j$ should have dimension $3/2$. This is something we should be able to see from the dual description. As a warmup, consider first the $\mathcal{N} = 4$ example. There, as described in section 3.2, the lowest dimension operators have the form $\text{Tr}\phi^{(I}\phi^{J)}$, and their dimension is two. Their description in supergravity is a Weyl deformation of the S^5 part of the geometry with $h_a^a \propto Y^2(y)$, where h_a^a is the trace of the metric on S^5 and $Y^2(y)$ is a d -wave spherical harmonic on S^5 . The four-form

potential D_{abcd} is also involved in the deformation, and there are two mass eigenstates in AdS_5 which are combinations of these two fields. A simple way to compute Y^2 is to start with the function $x_i x_j$ on \mathbb{R}^6 and restrict it to the unit S^5 . This suggests quite a general way to find eigenfunctions of the Laplacian on an Einstein manifold M_5 : we start by looking for harmonic functions on the associated conical geometry (4.1). The Laplacian is

$$\square_{C_6} = \frac{1}{r^5} \partial_r r^5 \partial_r + \frac{1}{r^2} \square_{M_5} . \quad (4.12)$$

The operator $r^2 \square_{C_6}$ commutes with $r \partial_r$, so we can restrict our search to functions f on C_6 with $\square_{C_6} f = 0$ and $r \partial_r f = \Delta f$ for some constant Δ . Such harmonic functions restricted to $r = 1$ have $\square_{M_5} f|_{r=1} = -\Delta(\Delta + 4) f|_{r=1}$. Following through the analysis of [126] one learns that the mass of the lighter of the two scalars in AdS_5 corresponding to $h_a^a \propto f|_{r=1}$ is $m^2 R^2 = \Delta(\Delta - 4)$. So, the dimension of the corresponding operator is Δ . In view of (4.11), all we need to do to verify in the supergravity approximation the renormalization group prediction $\Delta = 3/2$ for $\text{Tr} A_i B_j$ is to show that $r \partial_r z_i = \frac{3}{2} z_i$. This follows from scaling considerations as follows. The dilation symmetry on the cone is $r \rightarrow \lambda r$. Under this dilation, $ds_{C_6}^2 \rightarrow \lambda^2 ds_{C_6}^2$. The Kähler form should have this same scaling, and that will follow if also the Kähler potential $K \rightarrow \lambda^2 K$. As mentioned above, the Calabi-Yau metric follows from $K = \left(\sum_{i=1}^4 |z_i|^2 \right)^{2/3}$, which has the desired scaling if $z_i \rightarrow \lambda^{3/2} z_i$. Thus, indeed $r \partial_r z_i = \frac{3}{2} z_i$.

It is straightforward to generalize the above line of argument to operators of the form $\text{Tr} A_{(i_1} B^{j_1} \dots A_{i_\ell)} B^{j_\ell}$. Various aspects of the matching of operators in the conformal field theory to Kaluza-Klein modes in supergravity have been studied in [217, 173, 388]. But there is another interesting type of color singlet operators, which are called dibaryons because the color indices of each gauge group are combined using an antisymmetric tensor. The dibaryon operator is

$$\epsilon_{\alpha_1 \dots \alpha_N} \epsilon^{\beta_1 \dots \beta_N} A^{\alpha_1}_{\beta_1} \dots A^{\alpha_N}_{\beta_N} , \quad (4.13)$$

where we have suppressed $SU(2)$ indices. Let us use the notation $SU(2)_A$ for the global symmetry group under which A_i form a doublet, and $SU(2)_B$ for the group under which B_j form a doublet. Clearly, (4.13) is a singlet under $SU(2)_B$. This provides the clue to its string theory dual, which must also be $SU(2)_B$ -symmetric: it is a D3-brane wrapped on T^{11} along an orbit of $SU(2)_B$ [218]. Using the explicit metric (4.7), it is straightforward to verify that $mR = \frac{3}{4} N$ in the test brane approximation. Up to corrections of order $1/N$, the mass-dimension relation is $\Delta = mR$, so we see that again the field theory prediction for the anomalous dimension of A is born out. The 3-cycle which the D3-brane is wrapped on may be shown to be the unique homologically non-trivial 3-cycle of T^{11} . There is also an anti-dibaryon, schematically B^N , which is a D3-brane wrapped on an orbit of $SU(2)_A$. The two wrappings are opposite in

homology, so the dibaryon and anti-dibaryon can annihilate to produce mesons. This interesting process has never been studied in any detail, no doubt because the dynamics is complicated and non-supersymmetric. It is possible to construct dibaryon operators also in a variety of orbifold theories [218, 359].

The gauge theory dual to T^{11} descends via renormalization group flow from the gauge theory dual to S^5/\mathbb{Z}_2 , as described after (4.10). The conformal anomaly has been studied extensively for such flows (see for example [225]), and the coefficient a in (3.31) is smaller in the IR than in the UV for every known flow that connects UV and IR fixed points. Cardy has conjectured that this must always be the case [389]. To describe the field theoretic attempts to prove such a c-theorem would take us too far afield, so instead we refer the reader to [390] and references therein. In section 4.3.2 we will demonstrate that a limited c-theorem follows from elementary properties of gravity if the AdS/CFT correspondence is assumed.

In the presence of $\mathcal{N} = 1$ superconformal invariance, one can compute the anomaly coefficients a and c in (3.31) if one knows $\langle \partial_\mu R^\mu \rangle_{g_{\mu\nu}, B_\lambda}$, where R_μ is the R-current which participates in the superconformal algebra, and the expectation value is taken in the presence of an arbitrary metric $g_{\mu\nu}$ and an external gauge field source B_μ for the R-current. The reason a and c can be extracted from this anomalous one-point function is that $\partial_\mu R^\mu$ and T_μ^μ are superpartners in the $\mathcal{N} = 1$ multiplet of anomalies. It was shown in [225] via a supergroup argument that

$$\begin{aligned} \langle (\partial_\mu R^\mu) T_{\alpha\beta} T_{\gamma\delta} \rangle &= (a - c) []_{\alpha\beta\gamma\delta} \\ \langle (\partial_\mu R^\mu) R_\alpha R_\beta \rangle &= (5a - 3c) []_{\alpha\beta} , \end{aligned} \tag{4.14}$$

where now the correlators are computed in flat space. The omitted expressions between the square brackets are tensors depending on the positions or momenta of the operators in the correlator. Their form is not of interest to us here because it is the same for any theory: we are interested instead in the coefficients. These can be computed perturbatively via the triangle diagrams in figure 4.1. The Adler-Bardeen theorem guarantees that the one loop result is exact, provided $\partial_\mu R^\mu$ is non-anomalous in the absence of external sources (that is, it suffers from no internal anomalies). The constants of proportionality in the relations shown in figure 4.1 can be tracked down by comparing the complete Feynman diagram amplitude with the explicit tensor forms which we have omitted from (4.14). We are mainly interested in ratios of central charges between IR and UV fixed points, so we do not need to go through this exercise.

The field theory dual to S^5/\mathbb{Z}_2 , expressed in $\mathcal{N} = 1$ language, has the field content described in (4.8). The R-current of the chosen $\mathcal{N} = 1$ superconformal algebra descends from a $U(1)$ in the $SO(6)$ R-symmetry group of the $\mathcal{N} = 4$ algebra, and it assigns a $U(1)_R$ charge $r(\lambda) = 1$ to the $2N^2$ gauginos (fermionic components of the vector superfield) and $r(\chi) = -1/3$ to the $6N^2$ “quarks” (fermionic components of the

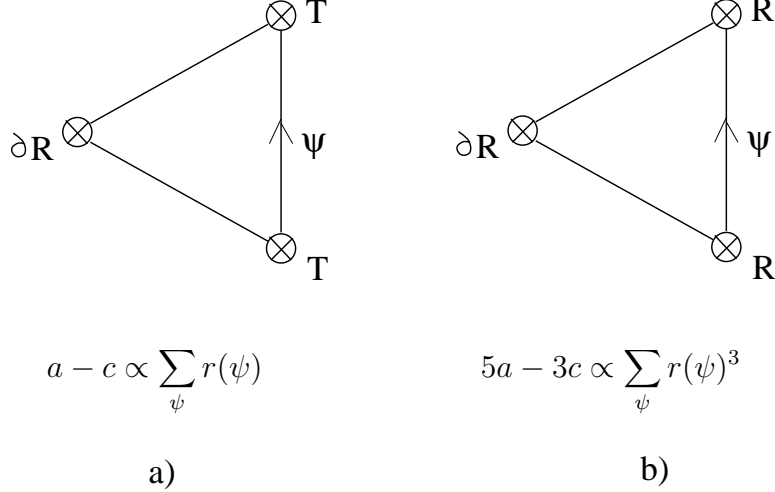

Figure 4.1: Triangle diagrams for computing the anomalous contribution to $\partial_\mu R^\mu$. The sum is over the chiral fermions ψ which run around the loop, and $r(\psi)$ is the R-charge of each such fermion.

chiral superfields)¹¹. We have $\sum_\psi r(\psi) = 0$, which means that the R-current has no gravitational anomalies [391].

For the field theory dual to T^{11} , the R-current described in the previous paragraph is no longer non-anomalous because we have added a mass to the adjoint chiral superfields. There is, however, a non-anomalous combination S_μ of this current, R_μ , with the Konishi currents, K_μ^i , which by definition assign charge 1 to the fermionic fields in the i^{th} chiral multiplet and charge 0 to the fermionic fields in the vector multiplets:

$$S_\mu = R_\mu + \frac{2}{3} \sum_i \left(\gamma_{\text{IR}}^i - \gamma^i \right) K_\mu^i. \quad (4.15)$$

Here γ^i is the anomalous dimension of the i^{th} chiral superfield. At the strongly interacting $\mathcal{N} = 1$ infrared fixed point, S_μ is the current which participates in the superconformal algebra. However, to compute correlators $\langle (\partial_\mu S^\mu) \dots \rangle$ it is more convenient to go to the ultraviolet, where $\gamma^i = 0$ and the perturbative analysis in terms of fermions running around a loop can be applied straightforwardly. Using the fact that $\gamma_{\text{IR}}^A = \gamma_{\text{IR}}^B = -1/4$ and $\gamma_{\text{IR}}^\Phi = \gamma_{\text{IR}}^{\tilde{\Phi}} = 1/2$, we find that $s_{\text{UV}}(\lambda) = 1$ for the gauginos, $s_{\text{UV}}(\chi) = -1/2$ for the quarks which stay light (i.e., the bifundamental quarks), and $s_{\text{UV}}(\eta) = 0$ for the quarks which are made heavy (that is, the adjoint quarks). Note that it is immaterial whether we include these heavy quarks in the triangle diagram, which is as it should be since we can integrate them out explicitly. As before,

¹¹We will ignore here the distinction between $U(N)$ and $SU(N)$ groups which is subleading in the $1/N$ expansion.

$\sum_\psi s_{\text{UV}}(\psi) = 0$, so there are no gravitational anomalies and $a_{\text{IR}} = c_{\text{IR}}$. Combining the information in the past two paragraphs, we have a field theory prediction for the flow from the S^5/\mathbb{Z}_2 theory to the T^{11} theory:

$$\frac{a_{\text{IR}}}{a_{\text{UV}}} = \frac{c_{\text{IR}}}{c_{\text{UV}}} = \frac{5a_{\text{IR}} - 3c_{\text{IR}}}{5a_{\text{UV}} - 3c_{\text{UV}}} = \frac{2N^2 + 4N^2 \left(-\frac{1}{2}\right)^3}{2N^2 + 6N^2 \left(-\frac{1}{3}\right)^3} = \frac{27}{32}. \quad (4.16)$$

This analysis was carried out in [173], where it was also noted that these numbers can be computed in the supergravity approximation. To proceed, let us write the ten-dimensional Einstein metric as

$$ds_{10}^2 = R^2 \widehat{ds}_5^2 + R^2 ds_{M_5}^2, \quad (4.17)$$

where R is given by (4.3) and \widehat{ds}_5^2 is the metric of AdS_5 scaled so that $\widehat{\mathcal{R}}_{\mu\nu} = -4\widehat{g}_{\mu\nu}$. We will refer to \widehat{ds}_5^2 as the dimensionless AdS_5 metric. Reducing the action from ten dimensions to five results in

$$S = \frac{\pi^3 R^8}{2\kappa^2} \int d^5x \sqrt{\widehat{g}} (\widehat{\mathcal{R}} + 12 + \dots) = \frac{\pi^2 N^2}{8 \text{Vol } M_5} \int d^5x \sqrt{\widehat{g}} (\widehat{\mathcal{R}} + 12 + \dots), \quad (4.18)$$

where $\sqrt{\widehat{g}}$ and $\widehat{\mathcal{R}}$ under the integral sign refer to the dimensionless AdS_5 metric, and in the second equality we have used (4.3). In (4.18), κ is the ten-dimensional gravitational coupling. In computing Green's functions using the prescription of [19, 20], the prefactor $\frac{\pi^2 N^2}{8 \text{Vol } M_5}$ multiplies every Green's function. In particular, it becomes the normalization factor for the one-point function $\langle T_\mu^\mu \rangle$ as calculated in [226]. Also, as pointed out in section 3.2, the supergravity calculation in [226] always leads to $a = c$. Without further thought we can write $a = c \propto (\text{Vol } M_5)^{-1}$, and

$$\frac{a_{\text{IR}}}{a_{\text{UV}}} = \frac{c_{\text{IR}}}{c_{\text{UV}}} = \left(\frac{\text{Vol } T^{11}}{\text{Vol } S^5/\mathbb{Z}_2} \right)^{-1} = \frac{27}{32}, \quad (4.19)$$

in agreement with (4.16). It is essential that the volumes in (4.19) be computed for manifolds with the same cosmological constant. Our convention has been to have $\mathcal{R}_{\alpha\beta} = 4g_{\alpha\beta}$.

It is possible to do better and pin down the exact normalization of the central charges. In fact, literally the first normalization check performed in the AdS/CFT correspondence was the verification [19] that in the compactification dual to $\mathcal{N} = 4$ $SU(N)$ Yang-Mills theory, the coefficient c had the value $N^2/4$ (to leading order in large N). Thus, in general

$$a = c = \frac{\pi^3 N^2}{4 \text{Vol } M_5} \quad (4.20)$$

(again to leading order in large N) for the CFT dual to a Freund-Rubin geometry $AdS_5 \times M_5$ supported by N units of five-form flux through the M_5 . This is in a normalization convention where the CFT comprised of a single free real scalar field has $c = 1/120$. See, for example, [173] for a table of standard anomaly coefficients per degree of freedom. Even more generally, we can consider any compactification of string theory or M-theory (or any other, as-yet-unknown theory of quantum gravity) whose non-compact portion is AdS_5 . This would include in particular type IIB supergravity geometries which involve the $B_{\mu\nu}^{NS,RR}$ fields, or the complex coupling τ . Say the AdS_5 geometry has $\mathcal{R}_{\mu\nu} = -\Lambda g_{\mu\nu}$. If we rescale the metric by a factor of $4/\Lambda$, we obtain the dimensionless AdS_5 metric \widehat{ds}_5^2 with $\widehat{\mathcal{R}}_{\mu\nu} = -4\widehat{g}_{\mu\nu}$. In defining a conformal field theory through its duality to the AdS_5 compactification under consideration, the part of the action relevant to the computation of central charges is still the Einstein-Hilbert term plus the cosmological term:

$$S = \frac{1}{2\kappa_5^2} \int d^5x \sqrt{g} (\mathcal{R} + 3\Lambda + \dots) = \frac{4}{\kappa_5^2 \Lambda^{3/2}} \int d^5x \sqrt{\widehat{g}} (\widehat{\mathcal{R}} + 12 + \dots) , \quad (4.21)$$

where $\kappa_5^2 = 8\pi G_5$ is the five-dimensional gravitational coupling. Comparing straightforwardly with the special case analyzed in (4.20), we find that the conformal anomaly coefficients, as always to leading order in $1/N$, must be given by

$$a = c = \frac{1}{G_5 \Lambda^{3/2}} . \quad (4.22)$$

4.2 D-Branes in AdS, Baryons and Instantons

A conservative form of the AdS/CFT correspondence would be to say that classical supergravity captures the large N asymptotics of some quantities in field theory which are algebraically protected against dependence on the 't Hooft coupling. The stronger form which is usually advocated, and which we believe is true, is that the field theory is literally equivalent to the string theory, and the only issue is understanding the mapping from one to the other. To put this belief to the test, it is natural to ask what in field theory corresponds to non-perturbative objects, such as D-branes, in string theory. The answer was found in [216] for several types of wrapped branes (see also [293] for an independent analysis of some cases), and subsequent papers [392, 393, 394, 184, 395, 396, 333, 397, 359, 398, 399] have extended and elaborated on the story. See also [400, 401] for actions for D-branes in anti-de Sitter space, and [402, 403] for other related topics. The connection between D-instantons and gauge theory instantons has also been extensively studied, and we summarize the results at the end of this section.

Let us start with wrapped branes which have no spatial extent in AdS_5 : they are particles propagating in this space. The field theory interpretation must be in terms of some vertex or operator, as for any other particle in AdS (as described above in the case of supergravity particles). If the compact manifold is S^5 , then the only topologically stable possibility is a wrapped 5-brane. The key observation here is that charge conservation requires that N strings must run into or out of the 5-brane. In the case of a D5-brane, these N strings are fundamental strings (one could also consider $SL(2, \mathbb{Z})$ images of this configuration). The argument is a slight variant of the ones used in the discussion of anomalous brane creation [404, 405, 406]. There are N units of five-form (F_5) flux on the S^5 , and the coupling $\frac{1}{2\pi} a \wedge F_5$ in the D5-brane world-volume translates this flux into N units of charge under the $U(1)$ gauge field a on the D5-brane. Since the D5-brane spatial world-volume is closed, the total charge must be zero. A string running out of the D5-brane counts as (-1) unit of $U(1)$ charge, hence the conclusion. Reversing the orientation of the D5-brane changes the sign of the charge induced by F_5 , and correspondingly the N strings should run into the brane rather than out.

In the absence of other D-branes, the strings cannot end anywhere in AdS_5 , so they must run out to the boundary. A string ending on the boundary is interpreted (see section 3.5) as an electric charge in the fundamental representation of the $SU(N)$ gauge group: an external (non-dynamical) quark. This interpretation comes from viewing the strings as running from the D5-brane to a D3-brane at infinity. It was shown in [405] that such stretched strings have a unique ground state which is fermionic, and the conclusion is that the D5-brane “baryon” is precisely an antisymmetric combination of N fermionic fundamental string “quarks.” The gauge theory interpretation is clear: because the gauge group is $SU(N)$ rather than $U(N)$, there is a gauge-invariant baryonic vertex for N external fundamental quarks. We will return to a discussion of baryonic objects in section 6.2.2.

To obtain other types of wrapped brane objects with no spatial extent in AdS_5 , we must turn to compact manifolds with more nontrivial homology cycles. Apart from the intrinsic interest of studying such objects and the gauge theories in which they occur, the idea is to verify the claim that every object we can exhibit in gauge theory has a stringy counterpart, and vice versa.

Following [216] and the discussion in section 4.1.2, we now examine wrapped branes in the $AdS_5 \times \mathbf{RP}^5$ geometry, which is the near-horizon geometry of D3-branes placed on top of a \mathbb{Z}_2 orientifold three-plane (the \mathbb{Z}_2 acts as $x_i \rightarrow -x_i$ for the six coordinates perpendicular to the D3-branes). $H_3(\mathbf{RP}^5, \mathbb{Z}) = \mathbb{Z}_2$, and the generator of the homology group is a projective space $\mathbf{RP}^3 \subset \mathbf{RP}^5$. This seems to offer the possibility of wrapping a D3-brane on a 3-cycle to get a particle in AdS_5 . However, there is a caveat: as argued in [216] the wrapping is permitted only if there is no discrete torsion for the NS and RR B -fields. In gauge theory terms, that amounts to saying that the corresponding

operator is permitted if and only if the gauge group is $SO(N)$ with N even. Direct calculation leads to a mass $m \simeq N/R$ for the wrapped brane, so the corresponding gauge theory operator has dimension N (at least to leading order in large N). A beautiful fact is that a candidate gauge theory operator exists precisely when the gauge group is $SO(N)$ with N even: it is the ‘‘Pfaffian’’ operator,

$$\frac{1}{(N/2)!} \epsilon^{a_1 a_2 \dots a_N} \phi_{a_1 a_2} \dots \phi_{a_{N-1} a_N} . \quad (4.23)$$

Here the fields ϕ_{ab} are the adjoint scalar bosons which are the $\mathcal{N} = 4$ superpartners of the gauge bosons. We have suppressed their global flavor index. A similar wrapped 3-brane was discussed in section 4.1.3, where the 3-brane was wrapped around the 3-cycle of T^{11} (which is topologically $S^2 \times S^3$).

It is also interesting to consider branes with spatial extent in AdS_5 . Strings in AdS_5 were discussed in section 3.5. A three-brane in AdS_5 (by which we mean any wrapped brane with three dimensions of spatial extent in AdS_5) aligned with one direction perpendicular to the boundary must correspond to some sort of domain wall in the field theory. Some examples are obvious: in $AdS_5 \times S^5$, if the three-brane is a D3-brane, then crossing the domain wall shifts the 5-form flux and changes the gauge group from $SU(N)$ to $SU(N + 1)$ or $SU(N - 1)$. A less obvious example was considered in [216]: crossing a D5-brane or NS5-brane wrapped on some $\mathbf{RP}^2 \subset \mathbf{RP}^5$ changes the discrete torsion of the RR or NS B -field, and so one can switch between $SO(N)$ and $Sp(N/2)$ gauge groups. D5-branes on homology 2-cycles of the base of conifolds and orbifolds have also been studied [218, 383, 359, 407], and the conclusion is that they correspond to domain walls across which the rank of some factor in the product gauge group is incremented.

Another brane wrapping possibility is branes with two dimensions of spatial extent in AdS_5 . These become strings in the gauge theory when they are oriented with one dimension along the radial direction. In a particular model (an $SU(N)^3$ gauge theory whose string theory image is $AdS_5 \times S^5/\mathbb{Z}_3$) the authors of [359] elucidated their meaning: they are strings which give rise to a monodromy for the wave-functions of particles transported around them. The monodromy belongs to a discrete symmetry group of the gauge theory. The familiar example of such a phenomenon is the Aharonov-Bohm effect, where the electron’s wave-function picks up a $U(1)$ phase when it is transported around a tube of magnetic flux. The analysis of [359] extends beyond their specific model, and applies in particular to strings in $SO(N)$ gauge theories, with N even, obtained from wrapping a D3-brane on a generator of $H_1(\mathbf{RP}^5, \mathbb{Z})$, where the \mathbf{RP}^5 has no discrete torsion.

Finally, we turn to one of the most familiar examples of a non-perturbative object in gauge theory: the instanton. The obvious candidate in string theory to describe an instanton is the D-instanton, also known as the D(-1)-brane. The correspondence in

this case has been treated extensively in the literature [408, 409, 410, 411, 412, 413, 414, 415]. The presentation in [415] is particularly comprehensive, and the reader who is interested in a more thorough review of the subject can find it there. Note that the analysis of instantons in large N gauge theories is problematic since their contribution is (at least naively) highly suppressed; the k instanton contribution comes with a factor of $e^{-8\pi^2 k/g_{YM}^2} = e^{-8\pi^2 kN/\lambda}$ which goes like e^{-N} in the 't Hooft limit. Therefore, we can only discuss instanton contributions to quantities that get no other contributions to any order in the $1/N$ expansion. Luckily, such quantities exist in the $\mathcal{N} = 4$ SYM theory, like the one discussed below.

The Einstein metric on $AdS_5 \times S^5$ is unaffected by the presence of a D-instanton. The massless fields in five dimensions which acquire VEV's in the presence of a D-instanton are the axion and the dilaton: in a coordinate system for the Poincaré patch of AdS_5 where

$$ds^2 = \frac{R^2}{z^2} (dx_\mu^2 + dz^2) , \quad (4.24)$$

we have [409, 410, 411, 413], asymptotically as $z \rightarrow 0$,

$$e^\phi = g_s + \frac{24\pi}{N^2} \frac{z^4 \tilde{z}^4}{[\tilde{z}^2 + (x_\mu - \tilde{x}_\mu)^2]^4} + \dots , \quad (4.25)$$

$$\chi = \chi_\infty \pm (e^{-\phi} - 1/g_s) ,$$

for a D-instanton whose location in anti-de Sitter space is $(\tilde{x}_\mu, \tilde{z})$. It can be shown using the general prescription for computing correlation functions that this corresponds in the gauge theory to a VEV

$$\langle \text{Tr} F^2(x) \rangle = 192 \frac{\tilde{z}^4}{[\tilde{z}^2 + (x_\mu - \tilde{x}_\mu)^2]^4} , \quad (4.26)$$

which is exactly right for the self-dual background which describes the instanton in gauge theory. The action of a D-instanton, $2\pi/g_s$, also matches the action of the instanton, $8\pi^2/g_{YM}^2$, because of the relation $g_{YM}^2 = 4\pi g_s$. The result (4.26) is insensitive to whether the D-instanton is localized on the S^5 , since the field under consideration is an $SO(6)$ singlet. It is a satisfying verification of the interpretation of the variable z as inverse energy scale that the position \tilde{z} of the D-instanton translates into the size of the gauge theory instanton. In other words, we understand the AdS_5 factor (which appears in the moduli space of an $SU(2)$ instanton) as merely specifying the position of the D-instanton in the five-dimensional bulk theory.

In fact, at large N , a Yang-Mills instanton is parametrized not only by a point in AdS_5 , but also by a point in S^5 . The S^5 emerges from keeping track of the fermionic instanton zero modes properly [415]. The approach is to form a bilinear Λ^{AB} in the zero modes. Λ^{AB} is antisymmetric in the four-valued $SU(4)$ indices A and B , and satisfies

a hermiticity condition that makes it transform in the real $\mathbf{6}$ of $SO(6)$. Dual variables χ_{AB} can be introduced into the path integral which have the same antisymmetry and hermiticity properties: the possible values of χ_{AB} correspond to points in \mathbb{R}^6 . When the fermions are integrated out, the resulting determinant acts as a potential for the χ_{AB} fields, with a minimum corresponding to an S^5 whose radius goes into the determination of the overall normalization of correlation functions.

Building on the work of [408] on α' corrections to the four-point function of stress-tensors, the authors of [411] have computed contributions to correlators coming from instanton sectors of the gauge theory and successfully matched them with D-instanton calculations in string theory. It is not entirely clear why the agreement is so good, since the gauge theory computations rely on small 't Hooft coupling (while the string theory computations are for fixed g_{YM}^2 in the large N limit) and non-renormalization theorems are not known for the relevant correlators. The simplest example turns out to be the sixteen-point function of superconformal currents $\hat{\Lambda}_\alpha^A = \text{Tr}(\sigma^{\mu\nu} \alpha^\beta F_{\mu\nu}^- \lambda_{\beta^A})$, where $F_{\mu\nu}^-$ is the self-dual part of the field-strength, A is an index in the fundamental of $SU(4)$, α and β are Lorentz spinor indices, and μ and ν are the usual Lorentz vector indices. One needs sixteen insertions of $\hat{\Lambda}$ to obtain a non-zero result from the sixteen Grassmannian integrations over the fermionic zero modes of an instanton. The gauge theory result for gauge group $SU(2)$ turns out to be

$$\left\langle \prod_{p=1}^{16} g_{YM}^2 \hat{\Lambda}_{\alpha_p}^{A_p}(x_p) \right\rangle = \frac{2^{11} 3^{16}}{\pi^{10}} g_{YM}^8 e^{-\frac{8\pi^2}{g_{YM}^2} + i\theta_{YM}} \int \frac{d^4 \tilde{x} d\tilde{z}}{\tilde{z}^5} \int d^8 \eta d^8 \bar{\xi} \prod_{p=1}^{16} \left[\frac{\tilde{z}^4}{[\tilde{z}^2 + (x_p - \tilde{x})^2]^4} \frac{1}{\sqrt{\tilde{z}}} \left(\tilde{z} \eta_{\alpha_p}^{A_p} + (x_p - \tilde{x})_\mu \sigma_{\alpha_p \dot{\alpha}_p}^\mu \bar{\xi}^{\dot{\alpha}_p A_p} \right) \right]. \quad (4.27)$$

The superconformal currents $\hat{\Lambda}_\alpha^A$ are dual to spin 1/2 particles in the bulk: dilatinos in ten dimensions which we denote Λ . One of the superpartners of the well-known \mathcal{R}^4 term in the superstring action (see for example [416]) is the sixteen-fermion vertex [417]: in string frame,

$$\mathcal{L} = \frac{e^{-2\phi}}{\alpha'^4} \mathcal{R} + \dots + \left(\frac{e^{-\phi/2}}{\alpha'} f_{16}(\tau, \bar{\tau}) \Lambda^{16} + \text{c.c.} \right) + \dots, \quad (4.28)$$

where $f_{16}(\tau, \bar{\tau})$ is a modular form with weight $(12, -12)$, and τ is the complex coupling of type IIB theory:

$$\tau = \chi + ie^{-\phi} = \frac{\theta_{YM}}{2\pi} + \frac{4\pi i}{g_{YM}^2}. \quad (4.29)$$

There is a well-defined expansion of this modular form in powers of $e^{2\pi i \tau}$, $e^{-2\pi i \bar{\tau}}$, and g_{YM}^2 . Picking out the one-instanton contribution and applying the prescription for calculating Green's functions laid out in section 3.3, one recovers the form (4.27) up

to an overall factor. The overall factor can only be tracked down by redoing the gauge theory calculation with gauge group $SU(N)$, with proper attention paid to the saddle point integration over fermionic zero modes, as alluded to in the previous paragraph.

The computation of Green's functions such as (4.27) has been extended in [415] to the case of multiple instantons. Here one starts with a puzzle. The D-instantons effectively form a bound state because integrations over their relative positions converge. Thus the string theory result has the same form as (4.27), with only a single integration over a point (\tilde{x}, \tilde{z}) in AdS_5 . In view of the emergence of an S^5 from the fermionic zero modes at large N , the expectation on the gauge theory side is that the moduli space for k instantons should be k copies of $AdS_5 \times S^5$. But through an analysis of small fluctuations around saddle points of the path integral it was shown that most of the moduli are lifted quantum mechanically, and what is left is indeed a single copy of $AdS_5 \times S^5$ as the moduli space, with a prefactor on the saddle point integration corresponding to the partition function of the zero-dimensional $SU(k)$ gauge theory which lives on k coincident D-instantons. It is assumed that $k \ll N$. Although the k instantons “clump” in moduli space, their field configurations involve k commuting $SU(2)$ subgroups of the $SU(N)$ gauge group. The correlation functions computed in gauge theory have essentially the same form as (4.27). In comparing with the string theory analysis, one picks out the k -instanton contribution in the Taylor expansion of the modular form in (4.28). There is perfect agreement at large N for every finite k , which presumably means that there is some unknown non-renormalization theorem protecting these terms.

4.3 Deformations of the Conformal Field Theory

In this section we discuss deformations of the conformal field theory, and what they correspond to in its dual description involving string theory on AdS space. We will focus on the case of the $\mathcal{N} = 4$ field theory, though the general ideas hold also for all other examples of the AdS/CFT correspondence. We start in section 4.3.1 with a general discussion of deformations in field theory and in the dual description. Then in section 4.3.2 we use the AdS/CFT correspondence to prove a restricted c-theorem. In section 4.3.3 we discuss the interesting relevant and marginal deformations of the $\mathcal{N} = 4$ SYM field theory; and in section 4.3.4 we review what is known about these deformations from the point of view of type IIB string theory on $AdS_5 \times S^5$. The results we present will be based on [418, 148, 147, 149, 419, 145].

4.3.1 Deformations in the AdS/CFT Correspondence

Conformal field theories have many applications in their own right, but since our main interest (at least in the context of four dimensional field theories) is in studying non-conformal field theories like QCD, it is interesting to ask how we can learn about non-conformal field theories from conformal field theories. One way to break conformal invariance, described in section 3.6, is to examine the theory at finite temperature. However, it is also possible to break conformal invariance while preserving Lorentz invariance, by deforming the action by local operators,

$$S \rightarrow S + h \int d^4x \mathcal{O}(x), \quad (4.30)$$

for some Lorentz scalar operator \mathcal{O} and some coefficient h .

The analysis of such a deformation depends on the scaling dimension Δ of the operator \mathcal{O} ¹². If $\Delta < 4$, the effect of the deformation is strong in the IR and weak in the UV, and the deformation is called *relevant*. If $\Delta > 4$, the deformation is called *irrelevant*, and its effect becomes stronger as the energy increases. Since we generally describe field theories by starting with some UV fixed point and flowing to the IR, it does not really make sense to start with a CFT and perform an irrelevant deformation, since this would really require a new UV description of the theory. Thus, we will not discuss irrelevant deformations here. The last case is $\Delta = 4$, which is called a *marginal deformation*, and which does not break conformal invariance to leading order in the deformation. Generally, even if the dimension of an operator equals 4 in some CFT, this will no longer be true after deforming by the operator, and conformal invariance will be broken. Such deformations can be either *marginally relevant* or *marginally irrelevant*, depending on the dimension of the operator \mathcal{O} for finite small values of h . In special cases the dimension of the operator will remain $\Delta = 4$ for any value of h , and conformal invariance will be present for any value of h . In such a case the deformation is called *exactly marginal*, and the conformal field theories for all values of h are called a *fixed line* (generalizing the concept of a conformal field theory as a fixed point of the renormalization group flow). When a deformation is relevant conformal invariance will be broken, and there are various possibilities for the IR behavior of the field theory. It can either flow to some new conformal field theory, which can be free or interacting, or it can flow to a trivial field theory (this happens when the theory confines and there are no degrees of freedom below some energy scale Λ). We will encounter examples of all of these possibilities in section 4.3.3.

The analysis of deformations in the dual string theory on AdS space follows from our description of the matching of the partition functions in sections 3.1 and 3.3.

¹²If the operator does not have a fixed scaling dimension we can write it as a sum of operators which are eigenfunctions of the scaling operator, and treat the deformation as a sum of the appropriate deformations.

The field theory with the deformation (4.30) is described by examining string theory backgrounds in which the field ϕ on AdS space, which corresponds to the operator \mathcal{O} , behaves near the boundary of AdS space like $\phi(x, U) \xrightarrow{U \rightarrow \infty} hU^{\Delta-4}$, where $[\mathcal{O}] = \Delta$ and we use the coordinate system (2.27) (with U instead of u). In principle, we should sum over all backgrounds with this boundary condition. Note that, as mentioned in section 3.3, in Minkowski space this involves turning on the non-normalizable solution to the field equations for $\phi(x, U)$; turning on the normalizable mode (as done for instance in [420, 421, 422, 423, 424, 425, 426]) cannot be understood as a deformation of the field theory, but instead corresponds to a different state in the same field theory [427]¹³. As in the field theory, we see a big difference between the cases of $\Delta > 4$ and $\Delta < 4$. When $\Delta > 4$, the deformation grows as we approach the boundary, so the solution near the boundary will no longer look like AdS space; this is analogous to the fact that we need a new UV description of the field theory in this case. On the other hand, when $\Delta < 4$, the solution goes to zero at the boundary, so asymptotically the solution just goes over to the AdS solution, and the only changes will be in the interior. For $\Delta = 4$ the solution naively goes to a constant at the boundary, but one needs to analyze the behavior of the string theory solutions beyond the leading order in the deformation to see if the exact solution actually grows as we approach the boundary (a marginally irrelevant deformation), decreases there (a marginally relevant deformation) or goes to a constant (an exactly marginal deformation).

An exactly marginal deformation will correspond to a space of solutions of string theory, whose metric will always include an AdS_5 factor¹⁴, but the other fields can vary as a function of the deformation parameters. A relevant (or marginally relevant) deformation will change the behavior in the interior, and the metric will no longer be that of AdS space. If we start in the regime of large $g_s N$ where there is a supergravity approximation to the space, the deformation may be describable in supergravity terms, or it may lead to large fields and curvatures in the interior which will cause the supergravity approximation to break down. The IR behavior of the corresponding field theory will be reflected in the behavior of the string theory solution for small values of U (away from the boundary). If the solution asymptotes to an AdS solution also at small U , the field theory will flow in the IR to a non-trivial fixed point¹⁵. Note that the variables describing this AdS space may be different from the variables describing the original (UV) AdS space, for instance the form of the $SO(4, 2)$ isometries may be

¹³Some of the solutions considered in [423] may correspond to actual deformations of the field theory.

¹⁴The full space does not necessarily have to be a direct product $AdS_5 \times X$, but could also be a fibration of AdS_5 over X , which also has the $SO(4, 2)$ isometry group.

¹⁵Four dimensional field theories are believed [389] to have a c-theorem analogous to the 2-dimensional c-theorem [77] which states that the central charge of the IR fixed point will be smaller than that of the UV fixed point. We will discuss some evidence for this in the AdS context, based on the analysis of the low-energy gravity theory, in the next subsection.

different [147]. If the solution is described in terms of a space which has a non-zero minimal value of U (similar to the space which appears in the AdS-Schwarzschild black hole solution described in section 3.6, but in this case with the full $ISO(3,1)$ isometry group unbroken) the field theory will confine and be trivial in the IR. In other cases the geometrical description of the space could break down for small values of U ; presumably this is what happens when the field theory flows to a free theory in the IR.

4.3.2 A c-theorem

Without a detailed analysis of matter fields involved in non-anti-de Sitter geometries, there are few generalities one can make about the description of renormalization group flows in the AdS/CFT correspondence¹⁶. However, there is one general result in gravity [145] (see also [148]) which translates into a c-theorem via the correspondence. Let us consider D -dimensional metrics of the form

$$ds^2 = e^{2A(r)}(-dt^2 + d\vec{x}^2) + dr^2 . \quad (4.31)$$

Any metric with Poincaré invariance in the t, \vec{x} directions can be brought into this form by an appropriate choice of the radial variable r . Straightforward calculations yield

$$-(D-2)A'' = R_t^t - R_r^r = G_t^t - G_r^r = \kappa_D^2(T_t^t - T_r^r) \geq 0 . \quad (4.32)$$

In the second to last step we have used Einstein's equation, and in the last step we have assumed that the weak energy condition holds in the form

$$T_{\mu\nu}\zeta^\mu\zeta^\nu \geq 0 \quad (4.33)$$

for any null vector ζ^μ . This form of the weak energy condition is also known as the null energy condition, and it is obeyed by all fields which arise in Kaluza-Klein compactifications of supergravity theories to D dimensions. Thus, we can take it as a fairly general fact that $A'' \leq 0$ for $D > 2$. Furthermore, the inequality is saturated precisely for anti-de Sitter space, where the only contribution to $T_{\mu\nu}$ is from the cosmological constant. Thus in particular, any deformation of AdS_D arising from turning on scalar fields will cause A to be concave as a function of r . If we are interested in relevant deformations of the conformal field theory, then we should recover linear behavior in A near the boundary, which corresponds to the (conformal) ultraviolet limit in the field theory. Without loss of generality, then, we assume $A(r) \sim r/\ell$ as $r \rightarrow \infty$.

The inequality $A'' \leq 0$ implies that the function

$$\mathcal{C}(r) \equiv \frac{1}{A^{D-2}} \quad (4.34)$$

¹⁶See [428, 429, 430, 431, 432] for general discussions of the renormalization group flow in the context of the AdS/CFT correspondence.

decreases monotonically as r decreases. Now, suppose there is a region where A is nearly linear over a range of r corresponding to many orders of magnitude of $e^{A(r)}$. This is the bulk analog of a scaling region in the boundary field theory. The asymptotically linear behavior of $A(r)$ as $r \rightarrow \infty$ indicates an ultraviolet scaling region which extends arbitrarily high in energy. If $A(r)$ recovers linear behavior as $r \rightarrow -\infty$, there is an infrared scaling region; and there could also be large though finite scaling regions in between. Assuming odd bulk dimension D , the perfect AdS_D spacetime which any such scaling region approximates leads to an anomalous VEV

$$\langle T_\mu^\mu \rangle = \frac{\text{universal}}{A^{D-2}}, \quad (4.35)$$

where the numerator is a combination of curvature invariants which can be read off from the analysis of [226] (see section 3.2.2). The point is that in limits where conformal invariance is recovered, the expression (4.34) coincides with the anomaly coefficients of the boundary field theory, up to factors of order unity which are universal for all CFT's in a given dimension. Thus, $\mathcal{C}(r)$ is a c-function, and the innocuous inequality $A'' \leq 0$ amounts to a c-theorem provided that Einstein gravity is a reliable approximation to the bulk physics.

In geometries such as the interpolating kinks of [148, 147, 145] (discussed in more detail in section 4.3.4), the outer anti-de Sitter region is distinguishable from the inner one in that it has a boundary. There can only be one boundary (in Einstein frame) because A gets large and positive only once. In fact, the inner anti-de Sitter region has finite proper volume if the coordinates t and \vec{x} in (4.31) are made periodic. Supergravity is capable of describing irreversible renormalization group flows despite the reversibility of the equations, simply because the basic prescription for associating the partition functions of string theory and field theory makes use of the unique boundary.

4.3.3 Deformations of the $\mathcal{N} = 4$ $SU(N)$ SYM Theory

The most natural deformations to examine from the field theory point of view are mass deformations, that would give a mass to the scalar and/or fermion fields in the $\mathcal{N} = 4$ vector multiplet. One is tempted to give a mass to all the scalars and fermions in the theory, in order to get a theory that will flow to the pure Yang-Mills (YM) theory in the IR. Such a deformation would involve operators of the form $\text{Tr}(\phi^I \phi^I)$ for the scalar masses, and $[e^{\alpha\beta} \text{Tr}(\lambda_{\alpha A} \lambda_{\beta B}) + c.c.]$ for the fermion masses. In the weak coupling regime of small $\lambda = g_{YM}^2 N$, such deformations indeed make sense and would lead to a pure Yang-Mills theory in the IR. However, the analysis of this region requires an understanding of the string theory in the high-curvature region which corresponds to small λ , which is not yet available. With our present knowledge of string theory we are limited to analyzing the strong coupling regime of large λ , where supergravity is

a good approximation to the full string theory. In this regime there are two problems with the mass deformation described above :

- The operator $\text{Tr}(\phi^I \phi^I)$ is a non-chiral operator, so the analysis of section 3.2.1 suggests that for large λ it acquires a dimension which is at least as large as $\lambda^{1/4}$, and in particular for large enough values of λ it is an irrelevant operator. Thus, we cannot deform the theory by this operator for large λ . In any case this operator is not dual to a supergravity field, so analyzing the corresponding deformation requires going beyond the supergravity approximation.
- The pure YM theory is a confining theory which dynamically generates a mass scale Λ_{YM} , which is the characteristic mass scale for the particles (glueballs) of the theory. When we deform the $\mathcal{N} = 4$ theory by a mass deformation with a mass scale m , a one-loop analysis suggests that the mass scale Λ_{YM} will be given by $\Lambda_{YM} \sim m e^{-c/g_{YM}^2(m)N}$, where c is a constant which does not depend on N (arising from the one-loop analysis) and $g_{YM}^2(m)$ is the coupling constant at the scale m . Thus, we find that while for small λ we have $\Lambda_{YM} \ll m$ and there is a separation of scales between the dynamics of the massive modes and the dynamics of the YM theory we want to study, for large λ we have $\Lambda_{YM} \sim m$ and there is no such separation of scales (for non-supersymmetric mass deformations the one-loop analysis we made is not exact, but an exact analysis is not expected to change the qualitative behavior we describe). Thus, we cannot really study the pure YM theory, or any other confining theory (which does not involve all the fields of the original $\mathcal{N} = 4$ theory) as long as we are in the strong coupling regime where supergravity is a good approximation.

We will see below that, while we can find ways to get around the first problem and give masses to the scalar fields, there are no known ways to solve the second problem and study interesting confining field theories using the supergravity approximation. Of course, in the full string theory there is no such problem, and the mass deformation described above, for small λ , gives an implicit string theory construction of the non-supersymmetric pure YM theory.

In the rest of this section we will focus on the deformations that can arise in the strong coupling regime, and which may be analyzed in the supergravity approximation. As described in section 3.2.1, the only operators whose dimension remains small for large N and large λ are the chiral primary operators, so we are limited to deformations by these operators. Let us start by analyzing the symmetries that are preserved by such deformations. Most of the chiral operators are in non-trivial $SU(4)_R$ representations, so they break the $SU(4)_R$ group to some subgroup which depends on the representation of the operator we are deforming by. Generic deformations will also completely break the supersymmetry. One analyzes how much supersymmetry a

particular deformation breaks by checking how many supercharges annihilate it. For example, deformations which preserve $\mathcal{N} = 1$ supersymmetry are annihilated by the supercharges Q_α and $\bar{Q}_{\dot{\alpha}}$ of some $\mathcal{N} = 1$ subalgebra of the $\mathcal{N} = 4$ algebra. Given the structure of the chiral representations described in section 3.2.1 it is easy to see if a deformation by such an operator preserves any supersymmetry or not. Examples of deformations which preserve some supersymmetry are superpotentials of the form $W = h\text{Tr}(\Phi^{i_1}\Phi^{i_2}\dots\Phi^{i_n})$, which to leading order in h add to the Lagrangian a term of the form $[h\epsilon^{\alpha\beta}\text{Tr}(\lambda_{\alpha A_1}\lambda_{\beta A_2}\phi^{I_1}\dots\phi^{I_{n-2}}) + c.c.]$. These operators are part of the scalar operators described in section 3.2.1 arising at dimension $n + 1$ in the chiral multiplet. In order to preserve supersymmetry one must also add to the Lagrangian various terms of order h^2 , so we see that the question of whether a deformation breaks supersymmetry or not depends not only on the leading order operator we deform by but also on additional operators which we may or may not add at higher orders in the deformation parameter (note that the form of the chiral operators also changes when we deform, so an exact analysis of the deformations beyond the leading order in the deformation is highly non-trivial). Another example of a supersymmetry-preserving deformation is a superpotential of the form $W = h\text{Tr}(W_\alpha^2\Phi^{i_1}\dots\Phi^{i_{n-2}})$, which deforms the theory by some of the scalar operators arising at dimension $n + 2$ in the chiral multiplet (e.g. the dilaton deformation for $n = 2$, which actually preserves the full $\mathcal{N} = 4$ supersymmetry).

The list of chiral operators which correspond to marginal or relevant deformations was given in section 3.2.1. There is a total of 6 such operators, three of which are the lowest components of the chiral multiplets with $n = 2, 3, 4$ ¹⁷. These operators are traceless symmetric products of scalars $\mathcal{O}_n = \text{Tr}(\phi^{I_1}\phi^{I_2}\dots\phi^{I_n})$, which viewed as deformations of the theory correspond to non-positive-definite potentials for the scalar fields. Thus, at least if we are thinking of the theory on \mathbb{R}^4 where the scalars have flat directions before adding the potential, these deformations do not make sense since they would cause the theory to run away along the flat directions. In particular, the deformation in the **20'** which naively gives a mass to the scalars really creates a negative mass squared for at least some of the scalars, so it cannot be treated as a small deformation of the UV conformal theory at the origin of moduli space. We will focus here only on deformations by the other 3 operators, which all seem to make sense in the field theory.

One marginal operator of dimension 4 is the operator which couples to the dilaton, which is a **1** of $SU(4)_R$, of the form $[\text{Tr}(F_{\mu\nu}^2) + i\text{Tr}(F \wedge F) + \dots]$. Deforming by this operator corresponds to changing the coupling constant τ_{YM} of the field theory, and is known to be an exactly marginal deformation which does not break any of the

¹⁷In a $U(N)$ theory there is an additional scalar operator which is the lowest component of the $n = 1$ multiplet.

symmetries of the theory.

The other two relevant or marginal deformations are the scalars of dimension $n + 1$ in the $n = 2$ and $n = 3$ multiplets. Let us start by describing the relevant deformation, which is a dimension 3 operator in the $\mathbf{10}$ of $SU(4)_R$, of the form

$$\left[\epsilon^{\alpha\beta} \text{Tr}(\lambda_{\alpha A} \lambda_{\beta B}) + \text{Tr}([\phi^I, \phi^J] \phi^K) \right], \quad (4.36)$$

where the indices are contracted to be in the $\mathbf{10}$ of $SU(4)_R$ (which is in the symmetric product of two $\bar{\mathbf{4}}$'s and in the self-dual antisymmetric product of three $\mathbf{6}$'s). This operator is complex; obviously when we add it to the Lagrangian we need to add it together with its complex conjugate. The coefficient parametrizing the deformation is a complex number m^a in the $\mathbf{10}$ of $SU(4)_R$. Deforming by this operator obviously gives a mass to some or all of the fermion fields λ , depending on the exact values of m^a . For generic values of m^a , all the fermions will acquire a mass and supersymmetry will be completely broken. The scalars will then obtain a mass from loop diagrams in the field theory, so that the low-energy theory below a scale of order m^a will be the pure non-supersymmetric Yang-Mills theory. Unfortunately, as described above, for large $\lambda = g_{YM}^2 N$ this is not really a good description since this theory will confine at a scale Λ_{YM} of order m . However, for small λ this deformation does enable us to obtain the pure YM theory as a deformation of the $\mathcal{N} = 4$ theory.

It is interesting to ask what happens if we give a mass only to some of the fermions. In this case we may or may not preserve some amount of supersymmetry (obviously, preserving $\mathcal{N} = 1$ supersymmetry requires leaving at least one adjoint fermion massless). The deformations which preserve at least $\mathcal{N} = 1$ supersymmetry correspond to superpotentials of the form $W = m_{ij} \text{Tr}(\Phi^i \Phi^j)$. Choosing an $\mathcal{N} = 1$ subgroup breaks $SU(4)_R$ to $SU(3) \times U(1)_R$, and (if we choose the $U(1)$ normalization so that the supercharges decompose as $\mathbf{4} = \mathbf{3}_1 + \mathbf{1}_{-3}$) the $\mathbf{10}$ decomposes as $\mathbf{10} = \mathbf{6}_2 + \mathbf{3}_{-2} + \mathbf{1}_{-6}$. The SUSY preserving deformation m_{ij} is then in the $\mathbf{6}_2$ representation, and it further breaks both the $SU(3)$ and the $U(1)$. In a supersymmetric deformation we obviously need to also add masses of order m^2 to some of the scalars; naively this leads to a contradiction because, as described above, there are no reasonable scalar masses to add which are in chiral operators. However, at order m^2 we have to take into account also the mixings between operators which occur at order m in the deformation¹⁸; the form of the chiral operators changes after we deform, and they mix with other operators (in particular, the form of the operator which is an eigenvalue of the scaling operator changes when we turn on m). In the case of the supersymmetric mass deformation, at order m the chiral operator (4.36) described above mixes with the non-chiral $\text{Tr}(\phi^I \phi^I)$ operator giving the scalars a mass, so there is no contradiction. The simplest way to see this operator mixing in the SUSY-preserving case is to note that the $\mathcal{N} = 1$

¹⁸Similar mixings were recently discussed in [239].

SUSY transformations in the presence of a general superpotential include terms of the form $\{Q_\alpha, \lambda_{\beta i}\} \sim \epsilon_{\alpha\beta} \frac{d\bar{W}}{d\Phi^i}$, which lead to corrections of order m to $[Q^2, \mathcal{O}_2]$ which is the operator that we are deforming by.

There are two interesting ways to give a mass to only one of the fermions. One of them is a particular case of the SUSY-preserving deformation described above, of the form $W = m\text{Tr}(\Phi^1\Phi^1)$, which is an element of the $\mathbf{6}_2$ of $SU(3) \times U(1)$, and breaks $SU(4)_R \rightarrow SU(2) \times U(1)$ while preserving $\mathcal{N} = 1$ SUSY (but breaking the conformal invariance). The other possibility is to use the deformation in the $\mathbf{1}_{-6}$, which breaks SUSY completely but preserves an $SU(3)$ subgroup of $SU(4)_R$. To leading order in the deformation both possibilities give a mass to one fermion, but at order m^2 they differ in a way which causes one of them to break SUSY while the other further breaks $SU(3) \rightarrow SU(2) \times U(1)$. At weak coupling we can analyze the order m^2 terms in detail. In the SUSY-preserving deformation at order m^2 we turn on a scalar mass term of the form $|m|^2\text{Tr}[(\phi^1)^2 + (\phi^2)^2]$, which may be written in the form

$$\frac{|m|^2}{3}\text{Tr}[2(\phi^1)^2 + 2(\phi^2)^2 - (\phi^3)^2 - (\phi^4)^2 - (\phi^5)^2 - (\phi^6)^2] + \frac{|m|^2}{3}\text{Tr}[\phi^I\phi^I], \quad (4.37)$$

where the first term is one of the $\Delta = 2$ chiral operators in the $\mathbf{20}'$, and the second term is a non-chiral operator which arises from the operator mixing as described above (the appearance of the second term allows us to add the chiral operator in the first term without destroying the positivity of the scalar potential). In the non-SUSY deformation the chiral term is not turned on at any order in the deformation (the $\mathbf{20}'$ representation contains no singlets of $SU(3)$), and all the scalars get equal masses from the non-chiral term.

Which theory do we flow to in the IR after turning on such a single-fermion mass term? In the SUSY-preserving case one can show that we actually flow to an $\mathcal{N} = 1$ SCFT (and, in fact, to a fixed line of $\mathcal{N} = 1$ SCFTs). Naively, one chiral multiplet gets a mass, and we remain with the $\mathcal{N} = 1$ $SU(N)$ SQCD theory with two adjoint chiral multiplets, which is expected (based on the amount of matter in the theory) to flow to an interacting IR fixed point. In fact, one can prove [419] that there is an exactly marginal operator at that fixed point, which (generally) has a non-zero value in the IR theory we get after the flow described above. The full superpotential with the deformation is of the form $W = h\text{Tr}(\Phi^1[\Phi^2, \Phi^3]) + m\text{Tr}(\Phi^1\Phi^1)$ (where h is proportional to g_{YM}), and to describe the low-energy theory we can integrate out the massive field Φ^1 to remain with a superpotential $W = -\frac{h^2}{4m}\text{Tr}([\Phi^2, \Phi^3]^2)$ for the remaining massless fields. Naively this superpotential is irrelevant (its dimension at the UV fixed point at weak coupling is 5), but in fact one can show (for instance, using the methods of [387]) that it is exactly marginal in the IR theory, so there is a fixed line of SCFTs parametrized by the coefficient \tilde{h} of the superpotential $W = \tilde{h}\text{Tr}([\Phi^2, \Phi^3]^2)$. Upon starting from a particular value of g_{YM} in the UV and performing the supersymmetric

mass deformation, we will land in the IR at some particular point on the IR fixed line (i.e. some value of \tilde{h}). The unbroken global $U(1)$ symmetry of the theory becomes the $U(1)_R$ in the $\mathcal{N} = 1$ superconformal algebra in the IR.

It is more difficult to analyze the mass deformation which does not preserve SUSY (but preserves $SU(3)$), since we cannot use the powerful constraints of supersymmetry. Naively one would expect this deformation to lead to masses (from loop diagrams) for all of the scalars, but not for the fermions, since the $SU(3)$ symmetry prevents them from acquiring a mass. Then, the IR theory seems to be $SU(N)$ Yang-Mills coupled to three adjoint fermions, which presumably flows to an IR fixed point (this is what happens for supersymmetric theories with one-loop beta functions of the same order, but it is conceivable also that the theory may confine and generate a mass scale). There is no reason for such a fixed point to have any exactly marginal deformations (in fact, there are no known examples in four dimensions of non-supersymmetric theories with exactly marginal deformations), so presumably the flow starting from any value of g_{YM} always ends up at the same IR fixed point. We assumed that the deformation leads to positive masses squared for the scalars; it is also possible that it would give rise to negative masses squared for the scalars, in which case the theory on \mathbb{R}^4 would have no vacuum, as described above.

If we give a mass to two of the fermions, it is possible to do this with a superpotential of the form $W = m\text{Tr}(\Phi^1\Phi^2)$ which in fact preserves $\mathcal{N} = 2$ supersymmetry (it gives the $\mathcal{N} = 2$ SQCD theory with one massive adjoint hypermultiplet, which was discussed in [433]). This theory is known to dynamically generate a mass scale, at which the $SU(N)$ symmetry is broken (at a generic point in the moduli space) to $U(1)^{N-1}$, and the low-energy theory is the theory of $(N-1)$ free $U(1)$ vector multiplets. The behavior of this theory for large N was discussed in [434]. At special points in the moduli space there are massless charged particles, and at even more special points in the moduli space [435, 436, 437] there are massless electrically and magnetically charged particles and the theory is a non-trivial $\mathcal{N} = 2$ SCFT. It is not completely clear which point in the moduli space one would flow to upon adding the mass deformation to the $\mathcal{N} = 4$ theory. Presumably, without any additional fine-tuning one would end up at a generic point in the moduli space which corresponds to a free IR theory.

If we give a mass to two fermions while breaking supersymmetry (as above, this depends on the order m^2 terms that we add), we presumably end up in the IR with Yang-Mills theory coupled to two massless adjoint fermions. This theory is expected to confine at some scale Λ_{YM} (which for large $g_{YM}^2 N$ would be of the order of the scale m), and lead to a trivial theory in the IR. A similar confining behavior presumably occurs if we give a mass to three or four of the fermions (for three fermions we can give a mass while preserving SUSY, and we presumably flow in the IR to the confining $\mathcal{N} = 1$ pure SYM theory).

The only remaining deformation is the deformation by the $\Delta = 4$ operator in the **45** representation, which is in the $n = 3$ multiplet. A general analysis of this deformation is rather difficult, so we will focus here on the SUSY preserving case where the deformation is a superpotential of the form $W = h_{ijk} \text{Tr}(\Phi^i \Phi^j \Phi^k)$, with the coefficients h_{ijk} in the **10**₀ representation in the decomposition $\mathbf{45} = \mathbf{15}_4 + \mathbf{10}_0 + \mathbf{8}_0 + \mathbf{6}_{-4} + \bar{\mathbf{3}}_{-4} + \mathbf{3}_{-8}$. It turns out that one can prove (see [387] and references therein) that two of these ten deformations correspond to exactly marginal operators, that preserve $\mathcal{N} = 1$ superconformal invariance. This can be done by looking at a general $\mathcal{N} = 1$ theory with three adjoint chiral multiplets, a gauge coupling g , and a superpotential of the form

$$W = h_1 \text{Tr}(\Phi^1 \Phi^2 \Phi^3 + \Phi^1 \Phi^3 \Phi^2) + h_2 \text{Tr}((\Phi^1)^3 + (\Phi^2)^3 + (\Phi^3)^3) + h_3 \epsilon_{ijk} \text{Tr}(\Phi^i \Phi^j \Phi^k). \quad (4.38)$$

This particular superpotential is chosen to preserve a $\mathbb{Z}_3 \times \mathbb{Z}_3$ global symmetry, where one of the \mathbb{Z}_3 factors acts by $\Phi^1 \rightarrow \Phi^2, \Phi^2 \rightarrow \Phi^3, \Phi^3 \rightarrow \Phi^1$ and the other acts by $\Phi^1 \rightarrow \Phi^1, \Phi^2 \rightarrow \omega \Phi^2, \Phi^3 \rightarrow \omega^2 \Phi^3$ where ω is a third root of unity. The second \mathbb{Z}_3 symmetry prevents any mixing between the chiral operators Φ^i , and the first \mathbb{Z}_3 can then be used to show that they all have the same anomalous dimension $\gamma(g, h_1, h_2, h_3)$. The beta function may be shown (using supersymmetry) to be exactly proportional to this gamma function (with a coefficient which is a function of g), so that the requirement of conformal invariance degenerates into one equation ($\gamma = 0$) in the four variables g, h_1, h_2 and h_3 , which generically has a 3-dimensional space of solutions. This space of solutions corresponds to a 3-dimensional space of $\mathcal{N} = 1$ SCFTs. The general arguments we used so far do not tell us the form of the 3-dimensional space, but we can now use our analysis of the $\mathcal{N} = 4$ theory to learn more about it. First, we know that the $\mathcal{N} = 4$ line $g = h_3, h_1 = h_2 = 0$ is a subspace of this 3-dimensional space. We also know that at leading order in the deformation away from this subspace, $(h_3 + g)$, h_1 and h_2 correspond to marginal operators (as described above they couple to chiral operators of dimension 4), while $(h_3 - g)$ couples to a non-chiral operator (in the **15** of $SU(4)_R$ whose dimension is corrected away from $g = 0$ (and seems to be large for large $g_{YM}^2 N$)). Thus, we see that to leading order in the deformation around the $\mathcal{N} = 4$ fixed line, the exactly marginal deformations are given by h_1 and h_2 (which are two particular elements of the **10**₀ representation). It is not known if the other deformations in the **45** are marginally relevant, marginally irrelevant or exactly marginal.

4.3.4 Deformations of String Theory on $AdS_5 \times S^5$

As described in section 4.3.1, to analyze the deformations of section 4.3.3 in the AdS context requires finding solutions of string theory with appropriate boundary conditions. For the exactly marginal deformation in the **1**, which corresponds to the dilaton, we already know the solutions, which are just the $AdS_5 \times S^5$ solution with any value of

the string coupling τ_{IIB} . The other operators discussed above are identified in string theory with particular modes of the 2-form field B_{ab} with indices in the S^5 directions (we view B as a complex 2-form field which contains both the NS-NS and R-R 2-form fields). Thus, the dimension 3 mass deformation would be related to string theory backgrounds in which $B_{ab}(x, U, y) \xrightarrow{U \rightarrow \infty} mY_{ab}^{(1)}(y)/U$ for some spherical harmonics $Y_{ab}^{(1)}(y)$ on S^5 , and the dimension 4 deformations would be related to backgrounds with $B_{ab}(x, U, y) \xrightarrow{U \rightarrow \infty} hY_{ab}^{(2)}(y)$. It is clear from the identification of the superconformal algebra in the field theory and in the string theory that these deformations break the same supersymmetries in both cases; this can also be checked explicitly (say, to leading order in the deformation [418, 148]) by analyzing the SUSY variations of the type IIB supergravity fields. The existence of an exactly marginal deformation breaking the $\mathcal{N} = 4$ superconformal symmetry to $\mathcal{N} = 1$ superconformal symmetry suggests that the theorem of [438], that forbids flat space compactifications with different amounts of supersymmetry from being at a finite distance from each other in the string theory moduli space, is not valid in AdS compactifications [418, 148].

Since we know little about string theory in backgrounds with RR fields, our analysis of such solutions is effectively limited to the supergravity approximation. This already limits our discussion to large $\lambda = g_s N$, and it limits it further to cases where the solution does not develop large curvatures in the interior. In the supergravity limit one would want to find solutions of type IIB supergravity with the boundary conditions described above (with the rest of the fields having the same boundary conditions as in the $AdS_5 \times S^5$ case). Unfortunately, no such solutions are known, and they seem to be rather difficult to construct. There are 3 possible approaches to circumventing this problem of finding exact solutions to type IIB supergravity :

- One can try to construct solutions perturbatively in the deformation parameter, which should be easier than constructing the full exact solution. Unfortunately, this approach does not make sense for the relevant deformations, since already at leading order in the deformation (corresponding to the linearized equations of motion around the $AdS_5 \times S^5$ solution) we find that the solution ($B_{ab} \sim 1/U$) grows to be very large in the interior, so the perturbative expansion does not make sense. At best one may hope to have a perturbative expansion in a parameter like m/U (if m is the coefficient of a relevant operator of dimension $\Delta = 3$), but this only makes sense near the boundary. On the other hand, for marginal deformations, and especially for deformations that are supposed to be exactly marginal, this approach makes sense. Exactly marginal deformations correspond to solutions which do not depend on the AdS coordinates at all, so a perturbation expansion in the parameters of the deformation seems to be well-defined. In practice such a perturbation expansion is quite complicated, and can only be done in the first few orders in the deformation. In the case of the deformation by

h_1, h_2 which was described in field theory above, one can verify that it is an exactly marginal deformation to second order in the deformation, even though additional SUGRA fields need to be turned on at this order (including components of the metric with S^5 indices). This is in fact true for any deformation in the **45**. At third order one probably gets non-trivial constraints on which elements of the **45** can be turned on in an exactly marginal deformation, but the equations of motion of type IIB SUGRA have not yet been expanded to this order. Verifying that the deformations that are exactly marginal in the field theory correspond to exactly marginal deformations also in string theory on $AdS_5 \times S^5$ would be a non-trivial test of the AdS/CFT correspondence.

- There are no known non-trivial solutions of type IIB supergravity which are asymptotically of the form described above for the relevant or marginal deformations. However, there are several known solutions [174, 121] of type IIB supergravity (in addition to the $AdS_5 \times S^5$ solution) which involve AdS_5 spaces and have $SO(4, 2)$ isometries (these solutions need not necessarily be direct products $AdS_5 \times X$), and one can try to guess that they would be the end-points of flows arising from relevant deformations. As long as we are in the supergravity approximation, only solutions which are topologically equivalent to $AdS_5 \times S^5$ can be related by flows to the $AdS_5 \times S^5$ solution, so we will not discuss here other types of AdS_5 solutions.

One such solution was found in [174], which is of the form $AdS_5 \times X$, where X is an S^1 fiber over CP^2 (a “stretched five-sphere”), and there is also a 3-form field turned on in the compact directions (this is called a Pope-Warner type solution [439]). This solution has an $SU(3)$ isometry symmetry (corresponding to an $SU(3)$ global symmetry in the corresponding field theory), and it breaks all the supersymmetries. Thus, it is natural to try to identify it with the deformation by the non-supersymmetric single-fermion mass operator described in section 4.3.3, which has the same symmetries. Unfortunately, as discussed below, this solution seems to be unstable.

An additional solution, found in [121], exhibits an $SO(5)$ global symmetry. As discussed below, this solution also appears to be unstable.

- The most successful way (to date) of analyzing the appropriate solutions of type IIB supergravity has been to restrict attention to the five dimensional $\mathcal{N} = 8$ supergravity [124] sector of the theory, which includes only the $n = 2$ “supergraviton” multiplet from the spectrum described in section 3.2.1. Unlike the situation in flat-space compactifications, the five dimensional supergravity cannot be viewed as a low-energy limit of the ten dimensional supergravity compactification in any sense. For instance, the supergraviton multiplet contains fields of

$m^2 = -4/R^2$, while other multiplets (in the $n = 3, 4$ multiplets) which are not included in the truncation to the five dimensional supergravity theory involve massless fields on AdS_5 . However, it is conjectured that there does exist a consistent truncation of the type IIB supergravity theory on $AdS_5 \times S^5$ to the five dimensional $\mathcal{N} = 8$ supergravity, in the sense that every solution of the latter can be mapped into a solution of the full type IIB theory (with the other fields in type IIB supergravity being some functions of the five dimensional SUGRA fields). A similar truncation is believed to exist ([140, 114] and references therein) for the relation between 11 dimensional supergravity compactified on $AdS_4 \times S^7$ and the four dimensional $\mathcal{N} = 8$ gauged supergravity, and for the relation between 11 dimensional supergravity compactified on $AdS_7 \times S^4$ and the seven dimensional gauged supergravity, and the similarities between the two cases suggest that it may exist also in the $AdS_5 \times S^5$ case (though this has not yet been proven¹⁹). In the rest of this section we will assume that such a truncation exists and see what we can learn from it. Obviously, we can only learn from such a truncation about deformations of the theory by fields in the $n = 2$ multiplet, so we cannot analyze the marginal deformations in the **45** in this way.

The first thing one can try to do with the five dimensional $\mathcal{N} = 8$ supergravity is to find solutions to the equations of motion with an $SO(4, 2)$ isometry. These correspond to critical points of the scalar potential of $d = 5, \mathcal{N} = 8$ supergravity, which is a complicated function of the 42 ($=\mathbf{20}' + \mathbf{10}_c + \mathbf{1}_c$) scalar fields in the $n = 2$ multiplet. A full analysis of the critical points of this potential has not yet been performed, but there are 4 known vacua in addition to the vacuum corresponding to $AdS_5 \times S^5$:

(i) There is a non-supersymmetric vacuum with an unbroken $SU(3)$ gauge group. This vacuum is conjectured to correspond to the $SU(3)$ -invariant vacuum of the full type IIB supergravity theory described above, which, as mentioned above, could correspond to a mass deformation of the $\mathcal{N} = 4$ field theory. Additional evidence for this correspondence was presented in [148, 147], which constructed a solution of the five dimensional $\mathcal{N} = 8$ supergravity which interpolates between the $AdS_5 \times S^5$ solution and the $SU(3)$ -invariant solution, with the leading deformation from the $AdS_5 \times S^5$ solution corresponding exactly to the mass operator in the $\mathbf{1}_{-6}$ in the decomposition $\mathbf{10} = \mathbf{6}_2 + \mathbf{3}_{-2} + \mathbf{1}_{-6}$, which breaks $SU(4)_R \rightarrow SU(3)$. Since this solution is non-supersymmetric, one must verify that the classical solution is stable, namely that it does not contain tachyons whose mass is below the Breitenlohner-Freedman stability bound (in supersymmetric vacua this is guaranteed; using equation (3.14), such tachyons would correspond to operators of

¹⁹Partial evidence for this was given in [143]. See section 2.2.5 for further discussion.

complex dimension in the field theory which would contradict its unitarity). It has recently been shown [440] that there are scalars in the gauged supergravity multiplet which do violate the Breitenlohner-Freedman stability bound in the expansion around the $SU(3)$ -invariant solution²⁰ Thus, this is not a consistent vacuum of the supergravity theory. The AdS/CFT correspondence then implies that performing this mass deformation at strong coupling leads to some instability in the field theory (for instance, it could lead to negative masses squared for the scalar fields).

(ii) There is a non-supersymmetric vacuum with unbroken $SO(5)$ gauge symmetry, which is conjectured to be related to the $SO(5)$ -invariant compactification of type IIB supergravity which we mentioned above. The mass spectrum in this vacuum was computed in [147], where it was found that it has a tachyonic particle whose mass is below the stability bound. Thus, even classically this is not really a vacuum of the supergravity theory (presumably the tachyon would condense and the theory would flow to some different vacuum). It was found in [148, 147] that this “vacuum” is related to the $AdS_5 \times S^5$ vacuum by a deformation involving turning on one of the operators in the $\mathbf{20}'$ representation; presumably the instability of the supergravity solution is related to the instability of the field theory after performing this deformation.

(iii) There is [149, 419, 145] a vacuum with $SU(2) \times U(1)$ unbroken symmetry and 8 unbroken supercharges, corresponding to an $\mathcal{N} = 1$ SCFT in the field theory. There is no known corresponding solution of the full type IIB theory, but assuming that 5d SUGRA is a consistent truncation, such a solution must exist (though it is not guaranteed that all its curvature invariants will be small, as required for the consistency of the supergravity approximation). It is natural to identify this vacuum with the IR fixed point arising from the supersymmetric single-chiral-superfield mass deformation described in section 4.3.3. This is consistent with the form of the 5d SUGRA fields that are turned on in this solution, with the global symmetries of the solution, and with the fact that on both sides of the correspondence we have a fixed line of $\mathcal{N} = 1$ SCFTs (the parameter \tilde{h} of the fixed line corresponds to the dilaton on the string theory side; supersymmetry prohibits the generation of a potential for this field). Recently this identification was supported by the construction of the full solution interpolating between the $\mathcal{N} = 4$ fixed point and the $\mathcal{N} = 1$ fixed point in the 5d SUGRA theory [145]. Since we have some supersymmetry left in this case, one can also quantitatively test this correspondence by matching the global anomalies of the field theory

²⁰Except for orbifold constructions, there is no example at the time of writing of a non-supersymmetric AdS_5 vacuum which is definitely known to satisfy the stability bound. There are however non-orbifold, non-supersymmetric AdS_3 vacua which are perturbatively stable.

described in section 4.3.3 (the $SU(N)$ $\mathcal{N} = 1$ SQCD theory with two adjoint chiral multiplets and a superpotential $W \propto \text{Tr}([\Phi^2, \Phi^3]^2)$) with those of the corresponding SUGRA background, as described in section 3.2.2. The conformal anomalies were successfully compared in [419, 145] in the large N limit, giving some evidence for this correspondence (in particular, the conformal anomalies of this theory satisfy $a = c$, as required for a consistent supergravity approximation). The fact that the central charge corresponding to this solution is smaller than that of the $AdS_5 \times S^5$ solution with the same RR 5-form flux (note that the RR flux is quantized and does not change when we deform) means that this interpretation is consistent with the conjectured four dimensional c-theorem.

(iv) There is an additional background found in [149] with $SU(2) \times U(1) \times U(1)$ unbroken gauge symmetry and no supersymmetry. The mass spectrum of this background has not yet been computed, so it is not clear if it is stable or not. The SUGRA solution involves giving VEVs to fields both in the $\mathbf{20}'$ and in the $\mathbf{10}$, but it is not clear exactly what deformation of the original $AdS_5 \times S^5$ theory (if any) this background corresponds to.

In principle, one could also use the truncated five dimensional theory to analyze other relevant deformations in the $\mathbf{10}$, which are not expected to give rise to conformal field theories in the IR. Presumably most of them would lead to high curvatures in the interior, but perhaps some of them do not and can then be analyzed purely in supergravity.

To summarize, the analysis of deformations in string theory on $AdS_5 \times S^5$ is rather difficult, but the results that are known so far seem to be consistent with the AdS/CFT correspondence. The only known results correspond to deformations which lead to conformal theories in the IR; as discussed in section 4.3.3, these are also the only deformations which we would expect to be able to usefully study in general in the supergravity approximation. The most concretely analyzed deformation is the single-chiral-fermion mass deformation, which seems to lead to another AdS-type background of type IIB supergravity (though only the truncation of this background to the five dimensional supergravity is known so far). In non-supersymmetric cases the analysis of deformations is complicated (see, for instance, [338]) by the fact that quantum corrections are presumably important in lifting flat directions, so a classical supergravity analysis is not really enough and the full string theory seems to be needed.

Chapter 5

AdS₃

In this chapter we will study the relation between gravity theories (string theories) on AdS_3 and two dimensional conformal field theories. First we are going to describe some generalities which are valid for any AdS_3 quantum gravity theory, and then we will discuss in more detail IIB string theory compactified on $AdS_3 \times S^3 \times M^4$ with $M^4 = K3$ or T^4 .

AdS_3 quantum gravity is conjectured to be dual to a two dimensional conformal field theory which can be thought of as living on the boundary of AdS_3 . The boundary of AdS_3 (in global coordinates) is a cylinder, so the conformal field theory is defined on this cylinder. We choose the cylinder to have radius one, which is the usual convention for conformal field theories. Of course, all circles are equivalent since this is a conformal field theory, but we have to rescale energies accordingly. If the spacetime theory or the conformal field theory contain fermions then they have anti-periodic boundary conditions on the circle. The reason is that the circle is contractible in AdS_3 , and close to the “center” of AdS_3 a translation by 2π on the circle looks like a rotation by 2π , and fermions get a minus sign. So, the dual conformal field theory is in the NS-NS sector. Note that we will not sum over sectors as we do in string theory, since in this case the conformal field theory describes string theory on the given spacetime and all its finite energy excitations, and we do not have to second-quantize it.

5.1 The Virasoro Algebra

The isometry group of AdS_3 is $SL(2, \mathbb{R}) \times SL(2, \mathbb{R})$, or $SO(2, 2)$. The conformal group in two dimensions is infinite. This seems to be, at first sight, a contradiction, since in our previous discussion we identified the conformal group with the isometry group of AdS . However, out of the infinite set of generators only an $SL(2, \mathbb{R}) \times SL(2, \mathbb{R})$ subgroup leaves the vacuum invariant. The vacuum corresponds to empty AdS_3 , and this

subgroup corresponds to the group of isometries of AdS_3 . The other generators map the vacuum into some excited states. So, we expect to find that the other generators of the conformal group map empty AdS_3 into AdS_3 with (for instance) a graviton inside. These other generators are associated to reparametrizations that leave the asymptotic form of AdS_3 invariant at infinity. This problem was analyzed in detail in [441] and we will just sketch the argument here. The metric on AdS_3 can be written as

$$ds^2 = R^2(-\cosh^2 \rho d\tau^2 + \sinh^2 \rho d\phi^2 + d\rho^2). \quad (5.1)$$

When ρ is large (close to the boundary) this is approximately

$$ds^2 \sim R^2 \left[-e^{2\rho} d\tau^+ d\tau^- + d\rho^2 \right], \quad (5.2)$$

where $\tau^\pm \equiv \tau \pm \phi$. An infinitesimal reparametrization generated by a general vector field $\xi^\alpha(\tau, \phi, \rho)$ changes the metric by $g_{\alpha\beta} \rightarrow g_{\alpha\beta} + \nabla_\alpha \xi_\beta + \nabla_\beta \xi_\alpha$. If we want to preserve the asymptotic form of the metric (5.2), we require that [441]

$$\begin{aligned} \xi^+ &= f(\tau^+) + \frac{e^{-2\rho}}{2} g''(\tau^-) + O(e^{-4\rho}), \\ \xi^- &= g(\tau^-) + \frac{e^{-2\rho}}{2} f''(\tau^+) + O(e^{-4\rho}), \\ \xi^\rho &= -\frac{f'(\tau^+)}{2} - \frac{g'(\tau^-)}{2} + O(e^{-2\rho}), \end{aligned} \quad (5.3)$$

where $f(\tau^+)$ and $g(\tau^-)$ are arbitrary functions. Expanding the functions $f = \sum L_n e^{n\tau^+}$, $g = \sum \bar{L}_n e^{n\tau^-}$, we recognize the Virasoro generators L_n, \bar{L}_n . For the cases $n = 0, \pm 1$ one can find some isometries that reduce to (5.3) at infinity, are globally defined, and leave the metric invariant. These are the $SO(2, 2)$ isometries discussed above. For the other generators it is possible to find a globally defined vector field ξ , but it does not leave the metric invariant.

It is possible to calculate the classical Poisson brackets among these generators, and one finds that this classical algebra has a central charge which is equal to [441]

$$c = \frac{3R}{2G_N^{(3)}}, \quad (5.4)$$

where $G_N^{(3)}$ is the three dimensional Newton constant. So, this should also be the central charge of the dual conformal field theory, since (5.3) implies that these Virasoro generators are acting on the boundary as the Virasoro generators of a 1+1 dimensional conformal field theory.

A simple calculation of the central charge term (5.4) was given in [228]. Under a diffeomorphism of the form (5.3), the metric near the boundary changes to

$$ds^2 \rightarrow R^2 \left[-e^{2\rho} d\tau^+ d\tau^- + d\rho^2 + \frac{1}{2}(\partial_+^3 f)(d\tau^+)^2 + \frac{1}{2}(\partial_-^3 g)(d\tau^-)^2 \right]. \quad (5.5)$$

The metric retains its asymptotic form, but we have kept track of the subleading correction. This subleading correction changes the expectation value of the stress tensor. If we start with a zero stress tensor, we get

$$\langle T_{++} \rangle \rightarrow \frac{R}{16\pi G_N^{(3)}} \partial_+^3 f \quad (5.6)$$

after the transformation. Under a general conformal transformation, $\tau^+ \rightarrow \tau^+ + f(\tau^+)$, the stress tensor changes as

$$T_{++} \rightarrow T_{++} + 2\partial_+ f T_{++} + f \partial_+ T_{++} + \frac{c}{24\pi} \partial_+^3 f. \quad (5.7)$$

So, comparing (5.7) with (5.6) we can calculate the central charge (5.4).

It is also possible to show that if we have boundary conditions on the metric at infinity that in the dual conformal field theory correspond to considering the theory on a curved geometry, then we get the right conformal anomaly [226] (generalizing the discussion in section 3.2.2).

5.2 The BTZ Black Hole

Three dimensional gravity has no propagating degrees of freedom. But, if we have a negative cosmological constant, we can have black hole solutions. They are given by [442, 443]

$$ds^2 = -\frac{(r^2 - r_+^2)(r^2 - r_-^2)}{r^2} dt^2 + \frac{R^2 r^2}{(r^2 - r_+^2)(r^2 - r_-^2)} dr^2 + r^2 (d\phi + \frac{r_+ r_-}{r^2} dt)^2, \quad (5.8)$$

with $\phi \equiv \phi + 2\pi$. We can combine the temperature T and the angular momentum potential Ω into

$$\frac{1}{T_{\pm}} \equiv \frac{1}{T} \pm \frac{\Omega}{T}, \quad (5.9)$$

and their relation to the parameters in (5.8) is $r_{\pm} = \pi R(T_+ \pm T_-)$. The mass and angular momentum are

$$8G_N^{(3)} M = R + \frac{(r_+^2 + r_-^2)}{R}, \quad J = \frac{r_- r_+}{4G_N^{(3)} R}, \quad (5.10)$$

where we are measuring the mass relative to the AdS_3 space, which we define to have $M = 0$ (the scale of the mass is set by the radius of the circle in the dual CFT). This is not the usual convention, but it is much more natural in this context since we are

measuring energies with respect to the NS-NS vacuum. Note that the mass of a black hole is always at least

$$M_{min} = \frac{R}{8G_N^{(3)}} = \frac{c}{12}. \quad (5.11)$$

The black hole with this minimum mass (sometimes called the zero mass black hole) has a singularity at $r = r_+ = r_- = 0$. All these black holes are locally the same as AdS_3 but they differ by some global identifications [442, 443], i.e. they are quotients of AdS_3 . In theories that have supersymmetry it can be checked that the zero mass black hole preserves some supersymmetries provided that we make the fermions periodic as we go around the circle [444], which is something we have the freedom to do once the circle is not contractible in the gravity geometry. These supersymmetries commute with the Hamiltonian conjugate to t . Furthermore, we will see below that if we consider the near horizon geometry of branes wrapped on a circle with periodic boundary conditions for the spinors, we naturally obtain the BTZ black hole with mass M_{min} . This leads us to identify the $M = M_{min}$ BTZ black hole with the RR vacuum of the conformal field theory [444]. The energy M_{min} (5.11) is precisely the energy difference between the NS-NS vacuum and the RR vacuum. Of course, we could still have the $M = M_{min}$ BTZ black hole with anti-periodic boundary conditions as an excited state in the NS-NS sector.

Next, let us calculate the black hole entropy. The Bekenstein-Hawking entropy formula gives

$$S = \frac{\text{Area}}{4G_N^{(3)}} = \frac{2\pi r_+}{4G_N^{(3)}} = \frac{\pi^2 c}{3}(T_+ + T_-), \quad (5.12)$$

where we used (5.4). We can also calculate this in the conformal field theory. All we need is the central charge of the conformal field theory, which we argued had to be (5.4). Then, we can use the general formula [445] for the growth of states in a unitary conformal field theory [446, 278], which gives

$$S \sim \frac{\pi^2 c}{3}(T_+ + T_-). \quad (5.13)$$

Thus, we see that the two results agree. This result is valid for a general conformal field theory as long as we are in the asymptotic high energy regime (where energies are measured in units of the radius of the circle), so in particular we need that $T \gg 1$. When is the result (5.12) valid? In principle we would say that it is valid as long as the area of the horizon is much bigger than the Planck length, $r_+ \gg G_N^{(3)}$. This gives $T \gg 1/c$, which is a much weaker bound on the temperature for large c . So, we see that the corresponding conformal field theory has to be quite special, since the number of states should grow as determined by the asymptotics (5.13) for energies that are much smaller than one would expect for a generic conformal field theory.

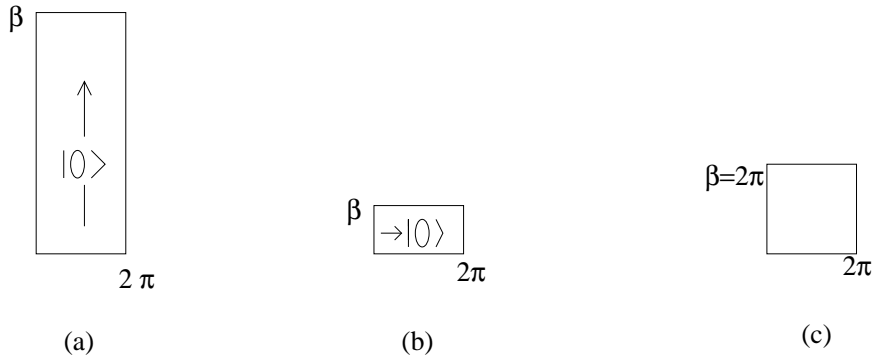

Figure 5.1: Calculation of the partition function at finite temperature through the Euclidean conformal field theory. Since the two directions are equivalent we can choose the “time” direction as we wish. The partition function is dual under $\beta \rightarrow 4\pi^2/\beta$. (a) At low temperatures β is large and only the vacuum propagates in the β direction. (b) At high temperatures, small β , only the crossed channel vacuum propagates in the ϕ direction. (c) When $\beta = 2\pi$ we have a sharp transition according to supergravity.

A related manifestation of this curious feature of the “boundary” conformal field theory is the following. We could consider the canonical ensemble by going to Euclidean space and making the Euclidean time coordinate periodic, $\tau = \tau + \beta$. We consider the case $\Omega = 0$, the general case is considered in [278]. The conformal field theory is then defined on a rectangular two-torus, and the free energy will be the partition function of the theory on this two-torus. Due to the thermal boundary condition in the NS sector, the two-torus ends up having NS-NS boundary conditions on both circles. In order to calculate the partition function in the dual gravitational theory we should find a three-manifold that has the two-torus as its boundary (the correspondence tells us to sum over all such manifolds). One possibility is to have the original AdS_3 space but with time identified, $\tau = \tau + \beta$. The value of the free energy is then given, to leading order, by the ground state energy of AdS_3 . This is the expected result for large β , where the torus is very elongated and only the vacuum propagates in the τ channel, see figure 5.1(a). For high temperatures, only the vacuum propagates in the crossed channel (fig. 5.1(b)), and this corresponds to the BTZ black hole in AdS_3 . Note that the Euclidean BTZ geometry is the same as AdS_3 but “on its side”, with $\tau \leftrightarrow \phi$, so now the τ circle is contractible. The transition between the two regimes occurs at $\beta = 2\pi$, which corresponds to a square torus (fig. 5.1(c)). This is a sharp transition when the gravity approximation is correct, i.e. when $R/G_N^{(3)} \sim c \gg 1$. This sharp transition will not be present in the partition function of a generic conformal field theory, for example it is not present if we consider c free bosons. When we discuss

in more detail the conformal field theories that correspond to string theory on AdS_3 , we will see that they have a feature that makes it possible to explain this transition. This sharp transition is the two dimensional version of the large N phase transition discussed in section 3.6.2 [185] (in this case c plays the role of N).

5.3 Type IIB String Theory on $AdS_3 \times S^3 \times M^4$

In this section we study IIB string theory on $AdS_3 \times S^3 \times M^4$ [278, 447]. Throughout this section $M^4 = K3$ or T^4 . In this case we can get some insight on the dual conformal field theory by deriving this duality from D-branes, as we did for the $AdS_5 \times S^5$ case. We start with type IIB string theory on M^4 . We consider a set of Q_1 D1 branes along a non-compact direction, and Q_5 D5 branes wrapping M^4 and sharing the non-compact direction with the D1 branes. All the branes are coincident in the transverse non-compact directions. The unbroken Lorentz symmetry of this configuration is $SO(1, 1) \times SO(4)$. $SO(1, 1)$ corresponds to boosts along the string, and $SO(4)$ is the group of rotations in the four non-compact directions transverse to both branes. This configuration also preserves eight supersymmetries, actually $\mathcal{N} = (4, 4)$ supersymmetry once we decompose them into left and right moving spinors of $SO(1, 1)$ ¹. It is possible to find the supergravity solution for this configuration (see [448] for a review) and then take the near horizon limit as we did in section 3.1 [5], and we get the metric (in string frame)

$$\frac{ds^2}{\alpha'} = \frac{U^2}{g_6 \sqrt{Q_1 Q_5}} (-dt^2 + dx_1^2) + g_6 \sqrt{Q_1 Q_5} \frac{dU^2}{U^2} + g_6 \sqrt{Q_1 Q_5} d\Omega_3^2. \quad (5.14)$$

This is $AdS_3 \times S^3$ with radius $R^2 = R_{AdS}^2 = R_{S^3}^2 = g_6 \sqrt{Q_1 Q_5} l_s^2$, where g_6 is the six dimensional string coupling. The full ten dimensional geometry also includes an M^4 factor. In this case the volume of the M^4 factor in the near-horizon geometry is proportional to Q_1/Q_5 , and it is independent of the volume of the original M^4 over which we wrapped the branes. In the full D1-D5 geometry, which includes the asymptotically flat region, the volume of M^4 varies, and it is equal to the above fixed value in the near horizon region [449, 450, 451, 452].

5.3.1 The Conformal Field Theory

The dual conformal field theory is the low energy field theory living on the D1-D5 system [453]. One of the properties of this conformal field theory that we will need

¹If $M^4 = K3$ we need that the sign of the D1 brane charge and the sign of the D5 brane charge are the same, otherwise we break supersymmetry (except for the single configuration with charges $(Q_5, Q_1) = (\pm 1, \mp 1)$).

is its central charge, so that we will be able to compare it with supergravity. We can calculate this central charge in a way that is not too dependent on the precise structure of the conformal field theory. The conformal field theory that we are interested in is the IR fixed point of the field theory living on D1-D5 branes. The field theory living on D1-D5 branes, before we go to the IR fixed point, is some $1 + 1$ dimensional field theory with $\mathcal{N} = (4, 4)$ supersymmetry. This amount of supersymmetry is equivalent to $\mathcal{N} = 2$ in four dimensions, so we can classify the multiplets in a similar fashion. There is a vector multiplet and a hypermultiplet. In two dimensions both multiplets have the same propagating degrees of freedom, four scalars and four fermions, but they have different properties under the $SU(2)_L \times SU(2)_R$ global R-symmetry. Under this group the scalars in the hypermultiplets are in the trivial representation, while the scalars in the vector multiplet are in the $(\mathbf{2}, \mathbf{2})$. On the fermions these global symmetries act chirally. The left moving vector multiplet fermions are in the $(\mathbf{1}, \mathbf{2})$, and the left moving hypermultiplet fermions are in the $(\mathbf{2}, \mathbf{1})$. The right moving fermions have similar properties with $SU(2)_L \leftrightarrow SU(2)_R$. The theory can have a Coulomb branch where the scalars in the vector multiplets have expectation values, and a Higgs branch where the scalars in the hypermultiplets have expectation values.

From the spacetime origin of the supercharges it is clear that the $SU(2)_L \times SU(2)_R$ global R-symmetry is the same as the $SO(4)$ symmetry of spatial rotations in the 4-plane orthogonal to the D1-D5 system [454, 455, 456]. The vector multiplets describe motion of the branes in the transverse directions, this is consistent with their $SO(4)$ transformation properties. The vector multiplet “expectation values” should be zero if we want the branes to be on top of each other. We have put quotation marks since expectation values do not exist in a $1 + 1$ dimensional field theory. It is possible to show that if Q_1 and Q_5 are coprime then, by turning on some of the M^4 moduli (more precisely some NS B-fields), one can remove the Coulomb branch altogether, forcing the branes to be at the same point in the transverse directions [457, 343].

Since the fermions transform chirally under $SU(2)_L$, this theory has a chiral anomaly. The chiral anomaly for $SU(2)_L$ is proportional to the number of left moving fermions minus the number of right moving fermions that transform under this symmetry. The ’t Hooft anomaly matching conditions imply that this anomaly should be the same at high and low energies [458]. At high energies (high compared to the IR fixed point) the anomaly is $k_a = N_H - N_V$, the difference between the number of vector multiplets and hypermultiplets. Let us now calculate this, starting with the T^4 case. On a D1-D5 brane worldvolume there are massless excitations coming from (1,1) strings, (5,5) strings and (1,5) (and (5,1)) strings. The (1,1) or (5,5) strings come from a vector multiplet of an $\mathcal{N} = (8, 8)$ theory, which gives rise to both a vector multiplet and a hypermultiplet of $\mathcal{N} = (4, 4)$ supersymmetry, so they do not contribute to the anomaly. The massless modes of the (1,5) strings come only in hypermultiplets, and

they contribute to the anomaly with $k_a = Q_1 Q_5$. For the K3 case the analysis is similar. The D5 branes are now wrapped on K3, so the (5,5) strings give rise only to a vector multiplet. The difference from the T^4 case comes from the fact that in the T^4 case the (5,5) hypermultiplet came from Wilson lines on the torus, and on K3 we do not have one-cycles so we do not have Wilson lines. On the fivebrane worldvolume there is (when it is wrapped on K3) an induced one-brane charge equal to $Q_1^{ind} = -Q_5$. The total D1 brane charge is equal to the sum of the charges carried by explicit D1 branes and this negative induced charge, $Q_1 = Q_1^{ind} + Q_1^{D1}$ [459]. Therefore, the number of D1 branes is really $Q_1^{D1} = Q_1 + Q_5$, and the number of (1,5) strings is $Q_1^{D1} Q_5$. So, we conclude that the anomaly is $k_a = Q_1^{D1} Q_5 - Q_5^2 = Q_1 Q_5$, which in the end is the same result as in the T^4 case. Note that in order to calculate this anomaly we only need to know the massless fields, since all massive fields live in larger representations which are roughly like a vector multiplet plus a hypermultiplet, and therefore they do not contribute to the anomaly.

When we are on the Higgs branch all the vectors become massive except for the center of mass multiplet, which contains fields describing the overall motion of all the branes in the four transverse directions. This is just a free multiplet, containing four scalar fields. On the Higgs branch, at the IR fixed point, the $SU(2)_L$ symmetry becomes a current algebra with an anomaly k_{cft} . The total anomaly should be the same, so that $k_a = k_{cft} - 1$. The last term comes from the center of mass $U(1)$ vector multiplet (which is not included in k_{cft}). So, we conclude that $k_{cft} = Q_1 Q_5 + 1$. Since the $U(1)$ vector multiplet is decoupled, we drop it in the rest of the discussion and we talk only about the conformal field theory of the hypermultiplets. The $\mathcal{N} = (4, 4)$ superconformal symmetry relates the anomaly in the $SU(2)$ current algebra to the central charge, $c = 6k_{cft} = 6(Q_1 Q_5 + 1)$. Using the value for the AdS_3 radius $R = (g_6^2 Q_1 Q_5)^{1/4} l_s$ and the three dimensional Newton constant $G_N^{(3)} = g_6^2 l_s^4 / 4R^3$, we can now check that (5.4) is satisfied to leading order for large k . This also ensures, as we saw above, that the black hole entropy comes out right.

Now we will try to describe this conformal field theory a bit more explicitly. We start with Q_5 D5 branes, and we view the D1 branes as instantons of the low-energy SYM theory on the five-branes [161]. These instantons live on M^4 and are translationally invariant (actually also $SO(1, 1)$ invariant) along time and the x_5 direction, where x_5 is the non compact direction along the D5 branes. See figure 5.2(a). This instanton configuration, with instanton number Q_1 , has moduli, which are the parameters that parameterize a continuous family of solutions (classical instanton configurations). All of these solutions have the same energy. Small fluctuations of this configuration (at low energies) are described by fluctuations of the instanton moduli. These moduli can fluctuate in time as well as in the x_5 direction. See figure 5.2(b). So, the low energy dynamics is given by a 1 + 1 dimensional sigma model whose target space is the

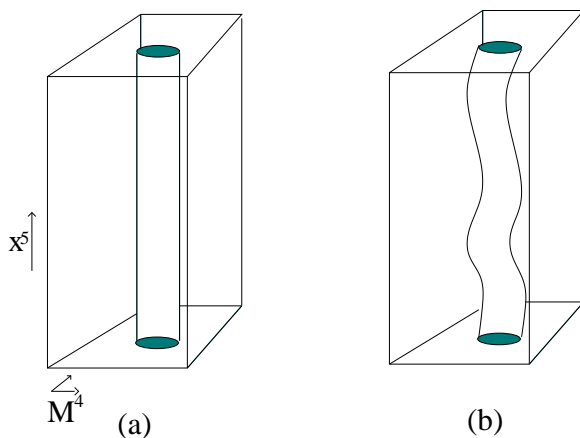

Figure 5.2: (a) The D1 branes become instantons on the D5 brane gauge theory. (b) The instanton moduli can oscillate in time and along x_5 .

instanton moduli space. Let us be slightly more explicit, and choose four coordinates x^6, \dots, x^9 parameterizing M^4 . The instantons are described in the UV SYM theory as $SU(Q_5)$ gauge fields $A_{6,7,8,9}(\xi^a; x^6, \dots, x^9)$ with field strengths which satisfy $F = *_4 F$, where $*_4$ is the epsilon symbol in M^4 and ξ^a are the moduli parameterizing the family of instantons. The dimension of the instanton moduli space for Q_1 instantons in $SU(Q_5)$ is $4k$, where

$$k \equiv Q_1 Q_5 \quad \text{for } T^4, \quad k \equiv Q_1 Q_5 + 1 \quad \text{for } K3. \quad (5.15)$$

The leading behaviour for large Q is the same. In the T^4 case we have four additional moduli coming from the Wilson lines of the $U(1)$ factor of $U(Q_5)$ [460]. It has been argued in [456, 461] that the instanton moduli space is a deformation of the symmetric product of k copies of M^4 , $Sym(M^4)^k \equiv (M^4)^k / S_k$. The deformation involves blowing up the fixed points of the orbifold, as well as modifying the B -fields that live at the orbifold point. We will discuss this in more detail later. The parameter that blows up the singularity can be identified with one of the supergravity moduli of this solution. For some particular value of these moduli (which are not to be confused with the moduli of the instanton configuration) the CFT will be precisely the symmetric product, but at that point the gravity approximation will not be valid, since we will see that the supergravity description predicts fewer states at low conformal weights than the symmetric product CFT. When we deform the symmetric product, some of the states can get large corrections and have high energies (i.e. they correspond to operators having high conformal weight). Other studies of this D1-D5 system include [462, 463, 464]

5.3.2 Black Holes Revisited

We remarked above that the BTZ black hole entropy can be calculated just from the value of the central charge, and therefore the gravity result agrees with the conformal field theory result. Note that the calculation of the central charge that we did above in the CFT is valid for any value of the coupling (i.e. the moduli), so the field theory calculation of the central charge and the entropy is valid also in the black hole regime (where the gravity approximation is valid). This should be contrasted to the $AdS_5 \times S^5$ case, where the field theory calculation of the entropy was only done at weak coupling (in two dimensions the entropy is determined by the central charge and cannot change as we vary moduli). In [465] corrections to the central charge in the gravity picture were analyzed.

We noticed above that the gravity description predicted a sharp phase transition when the temperature was $T = 1/(2\pi)$, and we remarked that the field theory had to have some special properties to make this happen. We will now explain qualitatively this phase transition. Our discussion will be qualitative because we will work at the orbifold point, and this is not correct if we are in the supergravity regime. We will see that the symmetric product has a feature that makes this sharp phase transition possible.

The orbifold theory can be interpreted in terms of a gas of strings [466, 467]. These are strings that wind along x_5 and move on M^4 . The total winding number is k . The strings can be singly wound or multiply wound. In the R-R sector it does not cost any energy to multiply wind the strings. If we have NS-NS boundary conditions, which are the appropriate ones to describe AdS_3 , it will cost some energy to multiply wind the strings. The energy cost in the orbifold CFT is the same as twice the conformal weight of the corresponding twist operator, which is $h = \bar{h} = w/4 + O(1/w)$ for a configuration with winding number w . If the strings are singly wound and we have a temperature of order one (or $1/2\pi$), we will not have many oscillation modes excited on these strings, and the entropy will be small. Note that the fact that we have many singly wound strings does not help, since we are supposed to symmetrize over all strings, so most of the strings will be in similar states and they will not contribute much to the entropy. So, the free energy of such a state is basically $F \sim 0$. On the other hand, if we multiply wind all the strings, we raise the energy of the system but we also increase the entropy [468], since now the energy gap of the system will be much lower (the multiply wound strings behave effectively like a field theory on a circle with a radius which is w times bigger). If we multiply wind w strings, with $w \gg 1$, we get an energy $E \sim w/2 + 2\pi^2 w T^2$, where the last term comes from thermal excitations along the string. The entropy is also larger, $S = 4\pi^2 w T$. So, the free energy is $F = E - TS = w/2 - 2\pi^2 w T^2$. Comparing this to the free energy of the state

with all strings singly wound, we see that the latter wins when $T < 1/(2\pi)$, and the multiply wound state wins when $T > 1/(2\pi)$. This explains the presence of the sharp phase transition at $T = 1/(2\pi)$ when we are at the orbifold point.

Note that the mass of the black hole at the transition point is $M = M_{min} + k/2$, which is (for large k) much bigger than the minimum mass for a BTZ black hole, like the situation in other $AdS_{d>3}$. We could have black holes which are smaller than this, but they cannot be in thermal equilibrium with an external bath. Of course they could be in equilibrium inside AdS_3 if we do not couple AdS_3 to an external bath to keep the temperature finite. In this case we are considering the microcanonical ensemble, and there are more black hole solutions that we could be considering [279, 284, 287].

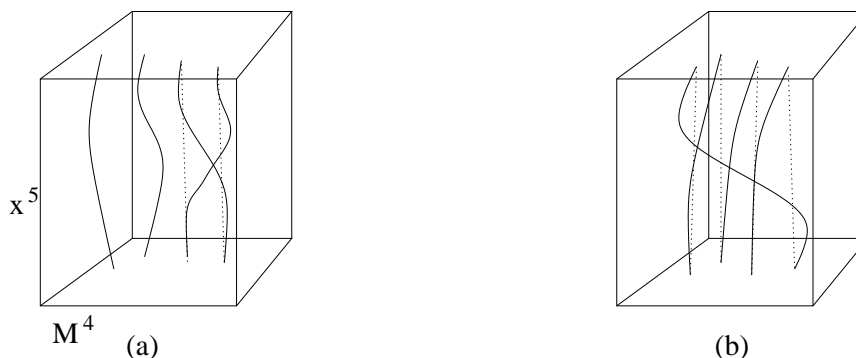

Figure 5.3: Some configurations with winding number four. (a) Two singly wound strings and one doubly wound string. (b) A maximally multiply wound configuration.

If we were considering the conformal field theory on a circle with RR boundary conditions, the corresponding supergravity background would be the $M = M_{min}$ BTZ black hole. This follows from the fact that we should have preserved supersymmetries that commute with the Hamiltonian (in AdS_3 the preserved supersymmetries do not commute with the Hamiltonian generating evolution in global time). In order to have these supersymmetries we need to have RR boundary conditions on the circle. Notice that the RR vacuum is not an excited state on the NS-NS vacuum, it is just in a different sector of the conformal field theory, even though the $M = M_{min}$ BTZ black hole appears in both sectors.

In the case with RR boundary conditions a black hole forms as soon as we raise the temperature (beyond $T \sim 1/k$). This seems at first sight paradoxical, since the temperature could be much smaller than one, which would be the natural energy gap for a generic conformal field theory on a circle. The reason that the energy gap is very small for this conformal field theory is due to the presence of “long”, multiply wound strings. In the RR sector all multiply wound strings have the same energy. But, as we

saw before, multiply wound strings lead to higher entropy states so they are preferred. In fact, one can estimate the energy gap of the system by saying that it will be of the order of the minimum energy excitation that can exist on a string multiply wound k -times, which is of the order of $1/k$. This estimate of the energy gap agrees with a semiclassical estimate as follows. We can trust the thermodynamic approximation for black holes as long as the specific heat is large enough [469]. For any system we need a large specific heat, $C_e \equiv \frac{\partial E}{\partial T}$, in order to trust the thermodynamic approximation. In this case $E \sim kT^2$, so the condition $C_e \gg 1$ boils down to $E \gg 1/k$. So, this estimate of the energy gap agrees with the conformal field theory estimate. Note that in the RR supergravity vacuum (the $M = M_{min}$ black hole) we could seemingly have arbitrarily low energy excitations as waves propagating on this space. The boundary condition on these waves at the singularity should be such that one gets the above gap, but in the gravity approximation $k = \infty$ and this gap is not seen. Note also that the $M = M_{min}$ black hole does not correspond to a single state (as opposed to the AdS_3 vacuum), but to a large number of states, of the order of $e^{2\pi\sqrt{2k}}$ for T^4 case and $e^{2\pi\sqrt{4k}}$ for $K3^2$.

There are other black holes that preserve some supersymmetries, which are extremal BTZ black holes with $M - M_{min} = J$ [444]. J is the angular momentum in AdS_3 , identified with the momentum along the S^1 in the CFT. Of course, these black holes will preserve supersymmetry only if the boundary conditions on S^1 are periodic, i.e. only if we are considering the RR sector of the theory. In the RR sector it becomes more natural to measure energies so that the RR vacuum has zero energy. The extremal black holes correspond to states in the CFT in the RR sector with no left moving energy, $\bar{L}_0 = 0$, and some right moving energy, $L_0 = J > 0$. The entropy of these states is

$$S = 2\pi\sqrt{kJ}. \quad (5.16)$$

This is the entropy as long as kL_0 is large, even for $L_0 = 1$. The reason for this is again the presence of multiply wound strings, that ensure that the asymptotic formula for the number of states in a conformal field theory is reached at very low values of L_0 . In this argument it is important that we are in the RR sector, and since we are counting BPS states we can deform the theory until we are at the symmetric product point, and then the argument we gave in terms of multiply wound strings is rigorous [13, 460].

It is possible to consider also black holes which carry angular momentum on S^3 . They are characterized by the eigenvalues J_L, J_R , of J_L^3 and J_R^3 of $SU(2)_L \times SU(2)_R$. These rotating black holes can be found by taking the near horizon limit of rotating black strings in six dimensions [470, 471]. Their metric is locally $AdS_3 \times S^3$ but with some discrete identifications [472]. Cosmic censorship implies that their mass has a

²An easy way to calculate this number of BPS states is to consider this configuration as a system of D1-D5 branes on $S^1 \times M^4$ and then do a U-duality transformation, transforming this into a system of fundamental string momentum and winding.

lower bound

$$E \equiv M - M_{min} \geq J_L^2/k + J_R^2/k. \quad (5.17)$$

We can also calculate the entropy for a general configuration carrying angular momenta $J_{L,R}$ on S^3 , linear momentum J on S^1 , and energy $E = M - M_{min}$:

$$S = 2\pi\sqrt{k(E+J)/2 - J_L^2} + 2\pi\sqrt{k(E-J)/2 - J_R^2}. \quad (5.18)$$

We can understand this formula in the following way [473, 454]. If we bosonize the $U(1)$ currents, $J_L \sim \frac{k}{2}\partial\phi$, and similarly for J_R , we can construct the operator $e^{iJ_L\phi}$ with conformal weight J_L^2/k . This explains why the minimum mass is (5.17). This also explains (5.18), since only a portion of the energy equal to $L_0 - J_L^2/k = (E+J)/2 - J_L^2/k$ can be distributed freely among the oscillators³.

5.3.3 Matching of Chiral-Chiral Primaries

The CFT we are discussing here, and also its string theory dual, have moduli (parameters of the field theory). At some point in the moduli space the symmetric product description is valid, and at that point the gravity description is strongly coupled and cannot be trusted. As we move away from that point we can get to regions in moduli space where we can trust the gravity description. The energies of most states will change when we change the moduli. There are, however, states that are protected, whose energies are not changed. These are chiral primary states [475]. The superconformal algebra contains terms of the form⁴

$$\begin{aligned} \{Q_r^{++}, Q_s^{--}\} &= 2L_{r+s} + 2(r-s)J_{r+s}^3 + \frac{c}{3}\delta_{r+s}(r^2 - \frac{1}{4}), \\ \{Q_r^{+-}, Q_s^{-+}\} &= 2L_{r+s} + 2(r-s)J_{r+s}^3 + \frac{c}{3}\delta_{r+s}(r^2 - \frac{1}{4}), \end{aligned} \quad (5.19)$$

where $Q_r^{\pm\pm} = (Q_{-r}^{\mp\mp})^\dagger$, and $r, s \in \mathbb{Z} + \frac{1}{2}$. The generators that belong to the global supergroup (which leaves the vacuum and AdS_3 invariant) have $r, s = \pm 1/2$. The first superscript indicates the eigenvalues under the global J_0^3 generator of $SU(2)$, and the second superscript corresponds to a global $SU(2)$ exterior automorphism of the algebra which is not associated to a symmetry in the theory. If we take a state $|h\rangle$ which has $L_0 = J_0^3$, then we see from (5.19) that $Q_{-1/2}^{+\pm}|h\rangle$ has zero norm, so in a unitary field theory it should be zero. Thus, these states are annihilated by $Q_{-1/2}^{+\pm}$. Moreover, if a state is annihilated by $Q_{-1/2}^{+\pm}$ then $L_0 = J_0^3$. These states are called right chiral primaries, and if $\bar{L}_0 = \bar{J}_0^3$ it is a left chiral primary. The possible values of J_0^3 for chiral

³Other black holes were studied in [474].

⁴Our normalization for J_0^3 follows the standard $SU(2)$ practice and differs by a factor of two from the $U(1)$ current in [475, 278, 447, 476].

primaries are bounded by $J_0^3 \leq c/6 = k$. This can be seen by computing the norm of $Q_{-3/2}^{\pm\pm}|h\rangle$. Note that k is the level of the $SU(2)$ current algebra. The values of J_0^3 for generic states are not bounded. The spins of $SU(2)$ current algebra primary fields are bounded by $J_0^3 \leq k/2$, which is *not* the same as the bound on chiral primaries.

Let us now discuss the structure of the supermultiplets under the $SU(1, 1|2)$ subgroup of the $\mathcal{N} = 4$ algebra [477]. This is the subgroup generated by the supercharges with $r, s = \pm 1/2$ in (5.19), plus the global $SU(2)$ generators J_0^a and the $SL(2, \mathbb{R})$ subgroup of the Virasoro algebra. The structure of these multiplets is the following. By acting with $Q_{1/2}^{\pm\pm}$ on a state we lower its energy, which is the L_0 eigenvalue. Energies are all positive in a unitary conformal field theory, since L_0 eigenvalues are related to scaling dimensions of fields which should be positive. So, we conclude that at some point $Q_{1/2}^{\pm\pm}$ will annihilate the state. Such a state is also annihilated by L_1 (5.19). We call such a state a primary, or highest weight, state. Then, we can generate all other states by acting with $Q_{-1/2}^{\pm\pm}$. See figure 5.4. This will give in general a set of $1 + 4 + 6 + 4 + 1$ states, where we organized the states according to their level. On each of these states we can then act with arbitrary powers of L_{-1} . However, we could also have a short representation where some of the $Q_{-1/2}$ operators annihilate the state. This will happen when $L_0 = \pm J_0^3$, i.e. only when we have a chiral primary (or an antichiral primary). Since by $SU(2)$ symmetry each chiral primary comes with an antichiral primary, we concentrate on chiral primaries. These short multiplets are of the form

$$\begin{array}{ccc}
\text{states} & J_0^3 & L_0 \\
|0\rangle & j & j \\
Q_{-1/2}^{-\pm}|0\rangle & j - 1/2 & j + 1/2 \\
Q_{-1/2}^{-+}Q_{-1/2}^{-}|0\rangle & j - 1 & j + 1.
\end{array} \tag{5.20}$$

The multiplet includes four states (which are $SL(2, \mathbb{R})$ primaries), except in the case that $j = 1/2$ when the last state is missing. We get a similar structure if we consider the right-moving part of the supergroup.

We will first consider states that are left and right moving chiral primaries, with $L_0 = J_0^3$ and $\bar{L}_0 = \bar{J}_0^3$. From now on we drop the indices on J_0^3, \bar{J}_0^3 , and denote the chiral primaries by (j, \bar{j}) . By acting with $Q_{-1/2}^{-\pm}$ and $\bar{Q}_{-1/2}^{-\pm}$ we generate the whole supermultiplet. We will calculate the spectrum of chiral-chiral primaries both in string theory (in the gravity approximation) and in the conformal field theory at the orbifold point. Since these states lie in short representations we might expect that they remain in short representations also after we deform the theory away from the orbifold point. Actually this argument is not enough, since in principle short multiplets could combine and become long multiplets. In the K3 case we can give a better argument. We will see that all chiral primaries that appear are bosonic in nature, while we see from figure 5.4 that we need some bosonic and some fermionic chiral primaries to make a long multiplet. Therefore, all chiral primaries must remain for any value of the moduli.

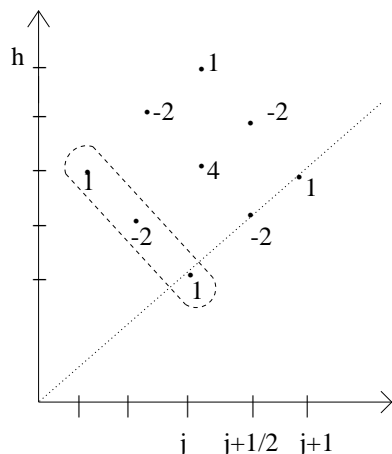

Figure 5.4: Structure of $SU(1,1|2)$ multiplets. We show the spectrum of possible j 's and conformal weights. We show only the $SL(2, \mathbb{R})$ primaries that appear in each multiplet and their degeneracies. The minus sign denotes opposite statistics. The full square is a long multiplet. The encircled states form a short multiplet. Four short multiplets can combine into a long multiplet.

Let us start with the conformal field theory. Since these states are protected by supersymmetry we can go to the orbifold point $Sym(M^4)^k$. The chiral primaries in this case can be understood as follows. In a theory with $\mathcal{N} = (4, 4)$ supersymmetry we can do calculations in the RR sector and then translate them into results about the NS-NS sector. This process is called “spectral flow”, and it amounts to an automorphism of the $\mathcal{N} = 4$ algebra. Under spectral flow, the chiral primaries of the NS-NS sector (that we are interested in) are in one to one correspondence with the ground states of the RR sector. It is easier to compute the properties of the RR ground states of the theory. Orbifold conformal field theories, like $Sym(M^4)^k$, can be thought of as describing a gas of strings winding on a circle, the circle where the CFT is defined, with total winding number k and moving on M^4 . The ground state energies of a singly wound string and a multiply wound string are the same if we are in the RR sector. Then, we can calculate a partition function over the RR ground states. It is more convenient to relax the constraint on the total winding number by introducing a chemical potential for the winding number, and then we can recover the result with fixed winding number by extracting the appropriate term in the partition function as in [466]. Since our conformal field theory has fixed k we will be implicitly assuming that we are extracting the appropriate term from the partition function. The RR ground states for the strings moving on M^4 are the same as the ground states of a quantum mechanical supersymmetric sigma model on M^4 . It was shown by Witten [478] that

these are in one-to-one correspondence with the harmonic forms on M^4 . Let us denote by h_{rs} the number of harmonic forms of holomorphic degree r and antiholomorphic degree s . States with degree $r + s$ odd are fermionic, and states with $r + s$ even are bosonic. In the case of $K3$ $h_{00} = h_{22} = h_{20} = h_{02} = 1$ and $h_{11} = 20$. In the case of T^4 $h_{00} = h_{22} = h_{20} = h_{02} = 1$, $h_{01} = h_{10} = h_{12} = h_{21} = 2$, and $h_{11} = 4$. A form with degrees (r, s) gives rise to a state with angular momenta $(j, \bar{j}) = ((r - 1)/2, (s - 1)/2)$. The partition function in the RR sector becomes [466]

$$\sum_{k \geq 0} p^k \text{Tr}_{\text{Sym}(M^4)^k} [(-1)^{2J+2\bar{J}} y^J \bar{y}^{\bar{J}}] = \frac{1}{\prod_{n \geq 1} \prod_{r,s} (1 - p^n y^{(r-1)/2} \bar{y}^{(s-1)/2})^{(-1)^{r+s} h_{rs}}}, \quad (5.21)$$

where the trace is over the ground states of the RR sector. Spectral flow boils down to the replacement $p \rightarrow p y^{1/2} \bar{y}^{1/2}$. Thus, we get the NS-NS partition function, giving a prediction for the chiral primaries,

$$\sum_k p^k \text{Tr}_{\text{Sym}(M^4)^k} [(-1)^{2J+2\bar{J}} y^J \bar{y}^{\bar{J}}] = \frac{1}{\prod_{n \geq 0} \prod_{r,s} (1 - p^{n+1} y^{(n+r)/2} \bar{y}^{(n+s)/2})^{(-1)^{r+s} h_{rs}}}, \quad (5.22)$$

where here the trace is over the chiral-chiral primaries in the NS-NS sector.

Now, we should compare this with supergravity. In supergravity we start by calculating the spectrum of single particle chiral-chiral primaries. We then calculate the full spectrum by considering multiparticle states. Each single particle state contributes with a factor $(1 - y^j \bar{y}^{\bar{j}})^{-d(j, \bar{j})}$ to the partition function, where $d(j, \bar{j})$ is the total number of single particle states with these spins. The supergravity spectrum was calculated in [278, 479, 480, 447]. The number of single particle states is given by

$$\sum_{j, \bar{j}} d(j, \bar{j}) y^j \bar{y}^{\bar{j}} = \sum_{n,r,s \geq 0} h_{rs} y^{\frac{n+r}{2}} \bar{y}^{\frac{n+s}{2}} - 1. \quad (5.23)$$

We have excluded the identity, which is not represented by any state in supergravity. So, the gravity partition function is given by

$$\text{Tr}_{\text{Sugra}} [(-1)^{2J+2\bar{J}} y^J \bar{y}^{\bar{J}}]_{\text{c-c primaries}} = \frac{1}{\prod_{n \geq 0} \prod'_{r,s} (1 - y^{(n+r)/2} \bar{y}^{(n+s)/2})^{(-1)^{r+s} h_{rs}}}, \quad (5.24)$$

where \prod' means that we are not including the term with $n = r = s = 0$.

Let us discuss some of the particles appearing in (5.23) and (5.24) more explicitly. Some of them are special because they carry only left moving quantum numbers or only right moving quantum numbers. For example, we have the $(0, 1)$ and $(1, 0)$ states that are related to the $SU(2)_L$ and $SU(2)_R$ gauge fields on AdS_3 . These $SU(2)$ symmetries come from the $SO(4)$ isometries of the 3-sphere. These gauge fields have a Chern-Simons action [481, 138] and they give rise to $SU(2)$ current algebras on the boundary [25, 154]. The chiral primary in the current algebra is the operator J_{-1}^+ , which has

the quantum numbers mentioned above. When we apply $Q_{-1/2}^{--}Q_{-1/2}^{-+}$ to this state we get the left moving stress tensor. Again, this should correspond to part of the physical modes of gravity on AdS_3 . Pure gravity in three dimensions is a theory with no local degrees of freedom. In fact, it is equivalent to an $SL(2, \mathbb{R}) \times SL(2, \mathbb{R})$ Chern-Simons theory [481, 482, 483, 484]. This gives rise to some physical degrees of freedom living at the boundary. It was argued that we get a Liouville theory at the boundary [485, 486, 487, 488, 489], which includes a stress tensor operator. In the T^4 case we also have some other special particles which correspond to fermion zero modes $(1/2, 0)$ and $(0, 1/2)$. These fermion zero modes are the supersymmetric partners of the $U(1)$ currents associated to isometries of T^4 . The six dimensional theory corresponding to type IIB string theory on T^4 has 16 vector fields transforming in the spinor of $SO(5, 5)$. From the symmetric product we get only 8 currents ($4_L + 4_R$). The other eight are presumably related to an extra copy of T^4 appearing in the CFT due to the Wilson lines of the $U(1)$ in $U(Q_5)$ [460, 490].

Besides these purely left-moving or purely right-moving modes, which are not so easy to see in supergravity, all other states arise as local bulk excitations of supergravity fields on AdS_3 and are clearly present. Higher values of j typically correspond to higher Kaluza-Klein modes of lower j fields. More precisely, we have n $(1/2, 1/2)$ states where $n = h_{11} + 1$ [278, 479, 447]. By applying Q 's, each of these states gives rise to four $SU(2)$ -neutral scalar fields, which have conformal weights $h = \bar{h} = 1$. Therefore, they correspond to massless fields in spacetime by (3.14). These are the $4n$ moduli of the supergravity compactification, which are identified with the moduli of the conformal field theory. In the conformal field theory $4h_{11}$ of them correspond to deformations of each copy of M^4 in the symmetric product, while the extra four are associated to a blowup mode, the blowup mode of the \mathbb{Z}_2 singularity that arises when we exchange two copies of M^4 . Next, we have $n + 1$ fields with quantum numbers $(1, 1)$, n of these are higher order Kaluza Klein modes of the n fields we had before, and the new one corresponds to deformations of the S^3 . Each of these states gives rise to $SU(2)$ -neutral fields with positive mass, since we have to apply Q 's twice and we get $h = \bar{h} = 2$. These are the n fixed scalars of the supergravity background plus one more field related to changing the size of the S^3 . The fields with j, \bar{j} 's above these values are just higher Kaluza Klein modes of the fields we have already mentioned explicitly. See [278, 479, 447] for a more systematic treatment and derivation of these results.

Now, we want to compare the supergravity result with the gauge theory results. In (5.22) there is an ‘‘exclusion principle’’ since the total power of p has to be p^k , thus limiting the total number of particles. In supergravity (5.24) we do not have any indication of this exclusion principle. Even if we did not know about the conformal field theory, from the fact that there is an $\mathcal{N} = 4$ superconformal spacetime symmetry we get a bound on the angular momentum of the chiral primaries $j \leq k$. However, this

bound is less restrictive than implied by (5.22). There are multi-particle states with $j < k$ that are excluded from (5.22). The bounds from (5.22) appear for very large angular momenta and, therefore, very large energies, where we would not necessarily trust the gravity approximation. In fact, the gravity result and the conformal field theory result match precisely, as long as the conformal weight or spin of the chiral primaries is $j, \bar{j} \leq k/2$. One can show that the gravity description exactly matches the $k \rightarrow \infty$ limit of (5.22) [447]. This limit is extracted from (5.22) by noticing that there is a factor of $(1-p)$ in the denominator, which is related to the identity operator. So, we can extract the $k \rightarrow \infty$ limit by multiplying (5.22) by $(1-p)$ and setting $p \rightarrow 1$. In principle, we could get precise agreement between the conformal field theory calculation and the supergravity calculation if we incorporate the exclusion principle by assigning a “degree” to each supergravity field, as explained in [476], and then considering only multiparticle states with degree smaller than k . One can further wonder whether there is something special that happens at $j = k/2$, when the exclusion principle starts making a difference. Since we are considering states with high conformal weight and angular momentum it is natural to wonder whether there are any black hole states that could appear. There are black holes which carry angular momentum on S^3 . These black holes are characterized by the two angular momenta J_L, J_R , of $SU(2)_L \times SU(2)_R$. The minimum black hole mass for given angular momenta was given in (5.17), $M_{min}(J_L, J_R) = k/2 + J_L^2/k + J_R^2/k$, where we used $c = 6k$ and (5.4). We see that these masses are always bigger than the mass of the chiral primary states with angular momenta (J_L, J_R) , except when $J_L = J_R = k/2$. So we see that something special is happening at $j = k/2$, since at this point a black hole appears as a chiral primary state. Connections between this exclusion principle and quantum groups and non-commutative geometry were studied in [491, 492].

5.3.4 Calculation of the Elliptic Genus in Supergravity

We could now consider states which are left moving chiral primaries and anything on the right moving side. These states are also in small representations, and one might be tempted to compute the spectrum of chiral primaries at the orbifold point and then try to match it to supergravity. However, this is not the correct thing to do, and in fact the spectrum does not match [493]. It is not correct because some chiral primary states could pair up and become very massive non-chiral primaries. In the case of chiral-anything states, a useful tool to count the number of states, which gives a result that is independent of the deformations of the theory, is the “elliptic genus”, which is the partition function

$$Z_k = Tr_{RR}[(-1)^{2j+2\bar{j}} q^{L_0} \bar{q}^{\bar{L}_0} y^j]. \quad (5.25)$$

This receives contributions only from the left moving ground states, $\bar{L}_0 = 0$. These states map into (chiral, anything) under spectral flow, i.e. states that are chiral primaries on the left moving side but are unrestricted on the right moving side.

The number of states contributing to the elliptic genus goes like $e^{2\pi\sqrt{nk}}$ for large powers q^n . This raised some doubts that (5.25) would agree with supergravity. The elliptic genus diverges when we take the limit $k \rightarrow \infty$. The origin of this divergence is the contribution of the (2, 0) form, which is a chiral primary on the left but it carries zero conformal weight on the right. So, we get a contribution of order k from the fact that this state could be occupied k times without changing the powers of q or y . The function that has a smooth limit in the $k \rightarrow \infty$ limit is then Z_k^{NS}/k . In the K3 case this function is

$$\lim_{k \rightarrow \infty} \frac{Z_k^{NS}}{k} = \frac{\prod_{m \geq 1} (1 - q^{m/2} y^{1/2})^2 (1 - q^{m/2} y^{-1/2})^2 (1 - q^{m/2})^{20}}{\prod_{m \geq 1} (1 - q^{m/2} y^{m/2})^{24} (1 - q^{m/2} y^{-m/2})^{24}}. \quad (5.26)$$

We can now compare this expression to the supergravity result. In the supergravity result we explicitly exclude the contribution of the (2, 0) form, since it is directly related to the factor of k that we extracted, but we keep the contribution of the (0, 2) form and the rest of the fields. The supergravity result then agrees precisely with (5.26) [476]. Both in the supergravity calculation and in the conformal field theory calculation at the orbifold point there are many fields of the form (chiral, anything), but most of them cancel out to give (5.26). For example, we can see that the only supergravity single particle states that contribute for large powers of $y^{>1/2}$ are the (chiral, chiral) and (chiral, antichiral) states. One can further incorporate the exclusion principle in supergravity by assigning degrees to the various fields, and then one finds that the elliptic genus agrees up to powers of q^h with $h \leq (k+1)/4$ [476]. Here again this is the point where a black hole starts contributing to the elliptic genus. It is an extremal rotating black hole with angular momentum $J_L = k/2$ and $J_R = 0$, which has $L_0 = k/4$ and $\bar{L}_0 = k/2$.

5.4 Other AdS_3 Compactifications

We start by discussing the compactifications discussed in the last section more broadly, and then we will discuss other AdS_3 compactifications. In the previous section we started out with type IIB string theory compactified on M^4 to six dimensions. The theory has many charges carried by string like objects, which come from branes wrapping on various cycles of M^4 . These charges transform as vectors under the duality group of the theory $SO(5, n)$, where $n = 21, 5$ for the $K3$ and T^4 cases respectively. These $5 + n$ strings correspond to the fundamental and D strings, the NS and D five-branes wrapped on M^4 , and to D3 branes wrapped on the $n + 1$ two-cycles of M^4 . A

general charge configuration is given by a vector q^I transforming under $SO(5, n)$. The radius of curvature of the gravity solution is proportional to q^2 , $R^4 \sim q^2$, where we use the $SO(5, n)$ metric. In the K3 case $q^2 > 0$ for supersymmetric configurations. The six dimensional space-time theory has $5n$ massless scalar fields, which parameterize the coset manifold $SO(5, n)/SO(5) \times SO(n)$ [494]. When we choose a particular charge vector, with $q^2 > 0$, we break the duality group to $SO(4, n)$, and out of the original $5n$ massless scalars n becomes massive and have values determined by the charges (and the other scalars) [495]. The remaining $4n$ scalars are massless and represent moduli of the supergravity compactification and, therefore, moduli of the dual conformal field theory. Note that the conformal field theory involves the instanton moduli space, but here the word “moduli” refers to the parameters of the CFT, such as the shape of T^4 , etc.

If we start moving in this moduli space we sometimes find that the gravity solution is best described by doing duality transformations [457, 343]. One interesting region in moduli space is when the system is best described in terms of a system of NS fivebranes and fundamental strings. This is the S-dual version of the D1-D5 system that we were considering above. In this NS background the radius of the S^3 and of AdS_3 is $R^2 = Q_5 \alpha'$, and it is independent of Q_1 . Actually, Q_1 only enters through the six dimensional string coupling, which in this case is a fixed scalar $g_6^2 = Q_5/Q_1$. The volume of M^4 is a free scalar in this case. The advantage of this background is that one can solve string theory on it to all orders in α' , since it is a WZW model, actually an $SL(2, \mathbb{R}) \times SU(2)$ WZW model. String propagation in $SL(2, \mathbb{R})$ WZW models were studied in [496, 497, 498, 499, 500, 501, 502, 503, 504, 505, 506, 507, 508, 509, 510, 511, 512, 513, 514, 515, 516]. Thus, in this case we can also consider states corresponding to massive string modes, etc. We can also define the spacetime Virasoro generators in the full string theory, and check that they act on string states as they should [509, 510, 511]⁵. In the string theory description the Virasoro symmetry appears directly in the formalism as a spacetime symmetry. One can also study D-branes in these AdS_3 backgrounds [519]. Conditions for spacetime supersymmetry for string theory on $SL(2, \mathbb{R})$ WZW backgrounds were studied in [520, 521]. In the D1-D5 configuration it is much harder to solve string theory, since RR backgrounds are involved. Classical actions for strings on these backgrounds were written in [522, 523, 524]. However, a formulation of string theory on these backgrounds was proposed in [525] (see also [526, 521, 527]). For some values of the moduli the CFT is singular. What this means is that we will have a continuum of states in the cylinder picture. In the picture with NS charges this happens, for example, when all RR B-fields on M^4 are zero. This continuum of states comes from fundamental strings stretching close to the boundary of AdS_3 . These states

⁵Configurations with NS fluxes that lead to AdS_{2d+1} spaces were studied in [517]. It has also been suggested [518] that (2,1) strings can describe AdS_3 spaces.

have finite energy, even though they are long, due to the interaction with the constant three form field strength, $H = dB_{NS}$, on AdS_3 [342, 343].

A simple variation of the previous theme is to quotient (orbifold) the three-sphere by a $\mathbb{Z}_N \subset SU(2)_L$. This preserves $\mathcal{N} = (4, 0)$ supersymmetry. This quotient changes the central charge of the theory by a factor of N through (5.4) (since the volume of the S^3 is smaller by a factor of N). It is also possible to obtain this geometry by considering the near horizon behavior of a D1-D5 + KK monopole system, or equivalently a D1-D5 system near an A_N singularity. It is possible to analyze the field theory by using the methods in [344], and using the above anomaly argument one can calculate the right moving central charge. The left moving central charge should be calculated by a more detailed argument. When we have NS 5 branes and fundamental strings on an A_N singularity, the worldsheet theory is solvable, and one can calculate the spectrum of massive string states, etc. [528]. One can also consider also both RR and NS fluxes simultaneously [529]. Other papers analyzing aspects of these quotients or orbifolds are [530, 530, 531, 532, 533].

A related configuration arises if we consider M-theory on M^6 , where $M^6 = T^6, T^2 \times K3$ or CY_3 , and we wrap M5 branes on a four-cycle in M^6 with non-vanishing triple self-intersection number. Then, we get a string in five dimensions, and the near horizon geometry of the supergravity solution is $AdS_3 \times S^2 \times M_f^6$, where the subscript on M_f^6 indicates that the vector moduli of M^6 are fixed scalars. In this case we get again an $\mathcal{N} = (0, 4)$ theory, and the $SU(2)_R$ symmetry is associated to rotations of the sphere. It is possible to calculate the central charge by counting the number of moduli of the brane configuration. Some of the moduli correspond to geometric deformations and some of them correspond to B -fields on the fivebrane worldvolume [534, 535]. A supergravity analysis of this compactification was done in [447, 536].

Another interesting case is string theory compactified on $AdS_3 \times S^3 \times S^3 \times S^1$, which has a large $\mathcal{N} = 4$ symmetry [537, 538, 539]. This algebra is sometimes called \mathcal{A}_γ . It includes an $SU(2)_k \times SU(2)_{k'} \times U(1)$ current algebra. The relative sizes of the levels of the two $SU(2)$ factors are related to the relative sizes of the radii of the spheres. This case seems to be conceptually simpler than the case with an M^4 , since all the spacetime dimensions are associated to a symmetry of the system⁶. In [537] a geometry like this was obtained from branes, except that the S^1 was replaced by \mathbb{R} , and it is not clear which brane configuration gives the geometry with the S^1 . This makes it more difficult to guess the dual conformal field theory. In [538] a CFT dual was proposed for this system in the case that $k = k'$. One starts with a theory with a free boson and four free fermions, which has large $\mathcal{N} = 4$ symmetry. Let us call this theory CFT_3 . Then, we can consider the theory based on the symmetric product $Sym(CFT_3)^k$. The

⁶In the case of T^4 one can show that the $U(1)^4$ symmetries of the torus can be viewed as the $k' \rightarrow \infty$ limit of the large $\mathcal{N} = 4$ algebra [460].

space-time theory has two moduli, which are the radius of the circle and the value of the RR scalar. These translate into the radius of the compact $U(1)$ -boson in CFT_3 and a blow up mode of the orbifold. In [539] a dual CFT was proposed for the general case ($k \neq k'$).

Another interesting example is the D1-D5 brane system in Type I string theory [540, 541, 542]. The $\mathcal{N} = (0, 4)$ theory on the D1 brane worldvolume theory encodes in the Yukawa couplings the ADHM data for the construction of the moduli space of instantons [543, 544]. What distinguishes the Type I system from the Type IIB case is the $SO(32)$ gauge group in the open string sector. When the D5 branes wrap a compact space M^4 with $M^4 = T^4, K3$, the near horizon geometry of the Type I supergravity solution is $AdS_3 \times S^3 \times M^4$ [542]. As in the previous examples, one is lead to conjecture a duality between Type I string theory on $AdS_3 \times S^3 \times M^4$ and the two-dimensional $(0, 4)$ SCFT in the IR limit of the D1 brane worldvolume theory. The supergroup of the Type I compactification is $SU(1, 1|2) \times SL(2, \mathbb{R}) \times SU(2)$, and the Kaluza-Klein spectrum in the supergravity can be analyzed as in [447]. The correspondence to the two-dimensional SCFT has not been much explored yet.

The relation between AdS_3 compactifications and matrix theory [26] was addressed in [545].

5.5 Pure Gravity

One might suspect that the simplest theory we could have on AdS_3 is pure Einstein gravity. In higher dimensions this is not possible since pure gravity is not renormalizable, so the only known sensible quantum gravity theory is string theory, but in three dimensions gravity can be rewritten as a Chern-Simons theory [483, 484], and this theory is renormalizable. Gravity in three dimensions has no dynamical degrees of freedom. We have seen, nevertheless, that it has black hole solutions when we consider gravity with a negative cosmological constant [442] (5.8). So, it should at least describe the dynamics of these black holes, black hole collisions, etc. It has been argued that this Chern-Simons theory reduces to a Liouville theory at the boundary [485, 487, 488, 546], with the right central charge (5.4). Naively, using the Cardy formula, this Liouville theory does not seem to give the same entropy as the black holes, but the Cardy formula does not hold in this case (Liouville theory does not satisfy the assumptions that go into the Cardy formula). Hopefully, these problems will be solved once it is understood how to properly quantize Liouville theory. Since we have the right central charge it seems that we should be able to calculate the BTZ black hole entropy [446], but Liouville theory is very peculiar and the entropy seems smaller [547]. Other papers studying AdS pure gravity or BTZ black holes in pure gravity include [548, 286, 549, 550, 551, 552, 553, 554, 555, 556, 557, 558, 559, 560, 561, 562, 563, 564,

565, 566, 567].

The Chern-Simons approach to gravity has also led to a proposal for a black hole entropy counting in this pure gravity theory. In that approach the black hole entropy is supposed to come from degrees of freedom in the Chern-Simons theory that become dynamical when a horizon is present [568].

One interesting question in three dimensional gravity is whether we should consider the Chern-Simons theory on a fixed topology or whether we should sum over topologies. Naively it is the second possibility, however it could be that the sum over topologies is already included in the Chern-Simons path integral over a fixed topology.

In any case, three dimensional pure gravity is part of the full string theory compactifications, and it would be interesting to understand it better.

The situation is similar if one studies pure AdS_3 supergravities [138, 486, 569].

5.6 Greybody Factors

In this section we consider an extremal or near extremal black string in six dimensions. We take the direction along the string to be compact, with radius $R_5 \gg l_s$. We need to take it to be compact since classically an infinite black string is unstable [570, 571]⁷. Here we assume that the temperature is small enough so that the configuration is classically stable⁸. We take a configuration with D1 brane charge Q_1 and D5 brane charge Q_5 . The general solution with these charges, and arbitrary energy and momentum along the string, has the following six dimensional Einstein metric⁹ [471, 572] :

$$\begin{aligned}
 ds_E^2 = & \left(1 + \frac{r_0^2 \sinh^2 \alpha}{r^2}\right)^{-1/2} \left(1 + \frac{r_0^2 \sinh^2 \gamma}{r^2}\right)^{-1/2} \left[-dt^2 + dx_5^2 \right. \\
 & \left. + \frac{r_0^2}{r^2} (\cosh \sigma dt + \sinh \sigma dx_5)^2 + \left(1 + \frac{r_0^2 \sinh^2 \alpha}{r^2}\right) ds_{M^4}^2 \right] \\
 & + \left(1 + \frac{r_0^2 \sinh^2 \alpha}{r^2}\right)^{1/2} \left(1 + \frac{r_0^2 \sinh^2 \gamma}{r^2}\right)^{1/2} \left[\left(1 - \frac{r_0^2}{r^2}\right)^{-1} dr^2 + r^2 d\Omega_3^2 \right].
 \end{aligned} \tag{5.27}$$

We consider the case that the internal space $M^4 = T^4$. In general we will also have some scalars that are non-constant. These become fixed scalars in the near-horizon

⁷It might seem that we can avoid the instability of [570, 571] by going very near extremality. Note, however, that for an infinite string it is entropically favorable to create a Schwarzschild black hole threaded by an extremal string.

⁸A general supergravity analysis of the various regimes in the D1-D5 system was given in [288].

⁹Throughout this section we use the six dimensional Einstein metric, related to the six dimensional string metric by $g_E = e^{-\phi_6} g_{str}$, where ϕ_6 is the six dimensional dilaton.

AdS_3 limit. In this case there are five fixed scalars, which are three self-dual NS B-fields, a combination of the RR scalar and the four-form on T^4 , and finally the volume of T^4 . If we take the first four to zero at infinity they stay zero throughout the solution. Then, the physical volume of T^4 is

$$\nu(r) \equiv \frac{\text{Volume}}{(2\pi)^4 \alpha'^2} = v \left(1 + \frac{r_0^2 \sinh^2 \gamma}{r^2} \right)^{-1} \left(1 + \frac{r_0^2 \sinh^2 \alpha}{r^2} \right), \quad (5.28)$$

where $v = \nu(\infty)$ is the value of the dimensionless volume at infinity. The solution (5.27) is parameterized by the four independent quantities $\alpha, \gamma, \sigma, r_0$. There are two extra parameters which enter through the charge quantization conditions, which are the radius of the x_5 dimension R_5 and the volume v of T^4 . The three charges are

$$\begin{aligned} Q_1 &= \frac{1}{4\pi^2 \alpha' \sqrt{v}} \int \nu * H' = \frac{\sqrt{v} r_0^2}{2\alpha'} \sinh 2\alpha, \\ Q_5 &= \frac{1}{4\pi^2 \sqrt{v} \alpha'} \int H' = \frac{r_0^2}{2\sqrt{v} \alpha'} \sinh 2\gamma, \\ N &= \frac{R_5^2 r_0^2}{2\alpha'^2} \sinh 2\sigma, \end{aligned} \quad (5.29)$$

where $*$ is the Hodge dual in the six dimensions x^0, \dots, x^5 and H' is the RR 3-form field. The last charge N is related to the momentum around the S^1 by $P_5 = N/R_5$. All three charges are normalized to be integers.

The ADM energy of this solution is

$$M = \frac{R_5 r_0^2}{2\alpha'^2} (\cosh 2\alpha + \cosh 2\gamma + \cosh 2\sigma). \quad (5.30)$$

The Bekenstein-Hawking entropy is

$$S = \frac{A_{10}}{4G_N^{(10)}} = \frac{A_6}{4G_N^{(6)}} = \frac{2\pi R_5 r_0^3}{\alpha'^2} \cosh \alpha \cosh \gamma \cosh \sigma, \quad (5.31)$$

where A is the area of the horizon and we have used the fact that in the six dimensional Einstein metric $G_N^{(6),E} = \alpha'^2 \pi^2 / 2$. The Hawking temperature is

$$T = \frac{1}{2\pi r_0 \cosh \alpha \cosh \gamma \cosh \sigma}. \quad (5.32)$$

The near extremal black string corresponds to the case that R_5 is large and the total mass is just above the rest energy of the branes. By “rest energy” of the branes we mean the mass given by the BPS bound,

$$E = M - Q_5 R_5 \sqrt{v} - \frac{Q_1 R_5}{\sqrt{v}}. \quad (5.33)$$

Note that this includes the mass due to the excitations carrying momentum along the circle. In the limit that $\alpha' \rightarrow 0$ with E, R_5 and N fixed we automatically go into the regime described by the conformal field theory living on the D1-D5 system which is decoupled. Instead, we are going to take here α' small but nonzero, so that we keep some coupling of the CFT to the rest of the degrees of freedom. The geometry is AdS_3 (locally) close to the horizon, but far away it is just the flat six dimensional space $\mathbb{R}^{1,4} \times S^1$. In this limit we can approximate the six dimensional geometry by

$$ds_E^2 = f^{-1/2} \left[-dt^2 + dx_5^2 + \frac{r_0^2}{r^2} (\cosh \sigma dt + \sinh \sigma dx_5)^2 \right] + f^{1/2} (dr^2 + r^2 d\Omega_3^2), \quad (5.34)$$

where

$$f = \left(1 + \frac{r_1^2}{r^2} \right) \left(1 + \frac{r_5^2}{r^2} \right), \quad r_5^2 = \alpha' Q_5 \sqrt{v}, \quad r_1^2 = \alpha' Q_1 / \sqrt{v}. \quad (5.35)$$

Let us consider a minimally coupled scalar field, ϕ , i.e. a scalar field that is *not* a fixed scalar. Let us send a quantum of that field to the black string, and calculate the absorption cross section for low energies. This calculation was already discussed in section 1.3.3, but for the reader's convenience we resummaries the computations here. The low-energy condition is

$$\omega \ll 1/r_5, 1/r_1. \quad (5.36)$$

We will consider here just an s-wave configuration. We also set the momentum in the direction of the string of the incoming particle to zero, the general case can be found in [18, 573]. Separation of variables, $\phi = e^{-i\omega t} \chi(r)$, leads to the radial equation

$$\left[\frac{h}{r^3} \partial_r h r^3 \partial_r + \omega^2 f \right] \chi = 0, \quad h = 1 - \frac{r_0^2}{r^2}. \quad (5.37)$$

Close to the horizon, a convenient radial variable is $z = h = 1 - r_0^2/r^2$. The matching procedure can be summarized as follows:

$$\begin{aligned} \text{far region: } & \left[\frac{1}{r^3} \partial_r r^3 \partial_r + \omega^2 \right] \chi = 0, \\ & \chi = A \frac{J_1(\omega r)}{r^{3/2}}, \\ \text{near region: } & \left[z(1-z) \partial_z^2 + \left(1 - i \frac{\omega}{2\pi T_H} \right) (1-z) \partial_z + \frac{\omega^2}{16\pi^2 T_L T_R} \right] z^{\frac{i\omega}{4\pi T_H}} \chi = 0, \\ & \chi = z^{-\frac{i\omega}{4\pi T_H}} F \left(-i \frac{\omega}{4\pi T_L}, -i \frac{\omega}{4\pi T_R}; 1 - i \frac{\omega}{2\pi T_H}; z \right), \end{aligned} \quad (5.38)$$

where T_L, T_R are defined in terms of the Hawking temperature T_H and the chemical potential, μ , which is conjugate to momentum on S^1 :

$$\frac{1}{T_{L,R}} \equiv \frac{1 \pm \mu}{T_H}, \quad T_{L,R} = \frac{r_0 e^{\pm \sigma}}{2\pi r_1 r_5}. \quad (5.39)$$

After matching the near and far regions together and comparing the infalling flux at infinity and at the horizon, one arrives at

$$\sigma_{\text{abs}} = \pi^3 r_1^2 r_5^2 \omega \frac{e^{\frac{\omega}{T_H}} - 1}{\left(e^{\frac{\omega}{2T_L}} - 1\right) \left(e^{\frac{\omega}{2T_R}} - 1\right)}. \quad (5.40)$$

Notice that this has the right form to be interpreted as the creation of a pair of particles along the string.

According to the AdS_3/CFT_2 correspondence, we can replace the near horizon region by the conformal field theory. The field ϕ couples to some operator \mathcal{O} in the conformal field theory [574] :

$$S_{\text{int}} = \int dt dx_5 \mathcal{O}(t, x_5) \phi(t, x_5, \vec{0}). \quad (5.41)$$

Then, the absorption cross section can be calculated by

$$\begin{aligned} \sigma &\sim \frac{1}{N_i} \sum_i \sum_f \left| \langle f | \int dt dx_5 \mathcal{O}(t, x_5) e^{ik_0 t + ik_5 x_5} | i \rangle \right|^2 \\ &\sim \frac{1}{N_i} \sum_i \int e^{ik_0 t + ik_5 x_5} \langle i | \mathcal{O}(t, x_5) \mathcal{O}^\dagger(0, 0) | i \rangle \\ &\sim \int e^{ik_0 t + ik_5 x_5} \langle \mathcal{O}(t, x_5) \mathcal{O}^\dagger(0, 0) \rangle_\beta, \end{aligned} \quad (5.42)$$

where we have summed over final states in the CFT and averaged over initial states. We will calculate the numerical coefficients later. The average over initial states is essentially an average over a thermal ensemble, since the number of states is very large so the microcanonical ensemble is the same as a thermal ensemble. So, the final result is that we have to compute the two point function of the corresponding operator over a thermal ensemble. This essentially translates into computing the correlation function on the Euclidean cylinder, and the result is proportional to (5.40) [16, 575, 574]. This argument reproduces the functional dependence on ω of (5.40). For other fields (non-minimally coupled) the functional dependence on ω is determined just in terms of the conformal weight of the associated operator.

Let us emphasize that the matching procedure (5.38) is valid only in the low energy regime (5.36). In this regime the typical gravitational size of the configuration, which is of order r_5 , is much smaller than the Compton wavelength of the particle. See figure 1.4. In fact, note that in the connecting region $r \sim r_5$ the function ϕ does not vary very much. Let us see this more explicitly. We see from (5.37) that we can approximate the equation by something like $\omega^2 r_5^2 \phi + \phi'' = 0$. From (5.36) we see that the variation of ϕ is very small over this connecting region. Furthermore, since absorption will turn out to be small, we can approximate the value of ϕ at the origin by the value it has in flat space. So, we can directly match the values of ϕ at the origin for a wave propagating in flat space with the value of ϕ near the boundary of AdS_3 .

In order to match the numerical coefficient we need to determine the numerical coefficient in the two-point function of the operator \mathcal{O} . This can be done for minimally coupled scalars using a non-renormalization theorem, as it was done for the case of absorption of gravitons on a D3 brane. The argument is the following. We first notice that the moduli space of minimally coupled scalars in supergravity is $SO(4, 5)/SO(4) \times SO(5)$. This is a homogeneous space with some metric, so the gravity Lagrangian in spacetime will include

$$S = \frac{1}{2\kappa_6^2} \int d^6x g_{ab}(\phi) \partial\phi^a \partial\phi^b. \quad (5.43)$$

The fields ϕ^a couple to operators \mathcal{O}_a , and we are interested in computing

$$\langle \mathcal{O}_a(x) \mathcal{O}_b(0) \rangle = \frac{G_{ab}}{x^4}. \quad (5.44)$$

The operators \mathcal{O}_a are a basis of marginal deformations of the CFT, and G_{ab} is the metric on the moduli space of the CFT. Since the conformal field theory has $\mathcal{N} = (4, 4)$ supersymmetry, this metric is highly constrained. In fact, it was shown in [576] that it is the homogeneous metric on $SO(4, 5)/SO(4) \times SO(5)$ (up to global identifications). Since the CFT moduli space is the same as the supergravity moduli space, the two metrics could differ only by an overall numerical factor $G_{ab} = Dg_{ab}$, where D is a number. In order to compute this number we can go to a point in moduli space where the CFT is just the orbifold $Sym(T^4)^k$. This point corresponds to having a single D5 brane and $k = Q_5 Q_1$ D1 branes. We can also choose the string coupling to be arbitrarily small. For example, we can choose the scalar ϕ to be an off-diagonal component of the metric on T^4 . The absorption cross section calculation then reduces to the one done in [16], which we now review. We take the metric on the four-torus to be $g_{ij} = \delta_{ij} + h_{ij}$, where h is a small perturbation, and choose $\phi = h_{12}$. The bulk action for ϕ then reduces to

$$\frac{1}{2\kappa_6^2} \int d^6x \frac{1}{2} (\partial\phi)^2. \quad (5.45)$$

The coupling of h to the fields on the D1 branes can be derived by expanding the Born-Infeld action. The leading term is

$$S = \frac{1}{2\pi g_s \alpha'} \int dt dx_5 \left[\frac{1}{2} (\partial X^i)^2 + h_{12}(\tau, \sigma, \vec{x} = 0) \partial X^1 \partial X^2 + \text{fermions} \right]. \quad (5.46)$$

To extract the cross-section we take $R_5 = \infty$, but the volume of the transverse space

V finite, and we use the usual 2-d S-matrix formulas:

$$\begin{aligned}
\frac{1}{\sqrt{2\kappa_6}}\phi(t, \vec{x}) &= \sum_{\vec{k}} \int \frac{dk_5}{(2\pi)} \frac{1}{\sqrt{V}2k^0} \left(a_k^{12} e^{ik \cdot x} + \text{h.c.} \right), \\
\frac{1}{\sqrt{2\pi g_s \alpha'}} X^i(t, x^5) &= \int \frac{dk_5}{2\pi} \frac{1}{\sqrt{2k^0}} \left(a_k^i e^{ik \cdot x} + \text{h.c.} \right), \\
|\tilde{i}\rangle &= (a_k^{12})^\dagger |0\rangle, \quad |\tilde{f}\rangle = (a_p^1)^\dagger (a_q^2)^\dagger |0\rangle, \\
\langle \tilde{f} | V_{\text{int}} | \tilde{i} \rangle &= \frac{\sqrt{2\kappa_6} p \cdot q}{\sqrt{V}}, \\
\Gamma(k^0) &= \frac{2Q_1 Q_5}{2k^0 2p^0 2q^0} \int \frac{dp^5}{2\pi} \frac{dq^5}{2\pi} |\langle \tilde{f} | V_{\text{int}} | \tilde{i} \rangle|^2 2\pi \delta(p^5 + q^5) 2\pi \delta(\omega - p^0 - q^0), \\
\sigma_{\text{abs}} &= V\Gamma(\omega) = \pi^3 \alpha'^2 Q_1 Q_5 \omega.
\end{aligned} \tag{5.47}$$

Since we have put the four transverse dimensions into a box of volume V , the flux of the h_{ij} gravitons on the brane is $\mathcal{F} = 1/V$. To find the cross-section we divide the net decay rate by the flux. The unusual factors of $\sqrt{2\kappa_6}$ and $1/\sqrt{2\pi g_s \alpha'}$ come from the coefficients of the kinetic terms for h_{12} and X^i (5.45)(5.46). The leading factor of 2 in the equation for $\Gamma(k^0)$ in (5.47) is there because there are two distinguishable final states that can come out of a given h_{12} initial state: an X^1 boson moving left and an X^2 boson moving right, or X^1 moving right and X^2 moving left. The factor of $Q_1 Q_5$ comes from the fact that we have $Q_1 Q_5$ D1 branes. Note that the delta function constraints plus the on shell conditions imply that $p^0 = q^0 = p^5 = -q^5 = \omega/2$ and $p \cdot q = \omega^2/2$.

The final answer in (5.47) agrees with the zero temperature limit of (5.40). As we remarked before, the thermal-looking factors in (5.40) can be derived just by doing a calculation of the two point function on the cylinder [574]. Finally, we should remark that this calculation implies that the metric on the moduli space of the CFT has an overall factor of $k = Q_1 Q_5$ as compared with the metric that appears in the six dimensional gravity action (5.43). This blends in perfectly with the expectations from AdS_3/CFT_2 , since in the AdS_3 region, by the time we go down to three dimensions, we get factors of the volume of the S^3 and the radius of AdS_3 which produce the correct factor of k in the gravity answer for the metric on the moduli space.

Of course, this absorption cross section calculation is also related to the time reversed process of Hawking emission. Indeed, the Hawking radiation rates calculated in gravity and in the conformal field theory coincide.

Many other greybody factors were calculated and compared with the field theory predictions [17, 573, 577, 578, 579, 574, 580, 66, 581, 582, 583, 584, 585, 586, 73, 587, 588, 589, 590, 591, 592, 593, 594, 595]. In some of these references the ‘‘effective string’’ model is mentioned. This effective string model is essentially the conformal field theory

at the orbifold point $Sym(T^4)^k$. Some of the gravity calculations did not agree with the effective string calculation. Typically that was because either the energies considered were not low enough, or because one needed to take into account the effect of the deformation in the CFT away from the symmetric product point in the moduli space.

5.7 Black Holes in Five Dimensions

If we Kaluza-Klein reduce, using [596, 597], the metric (5.27) on the circle along the string, we get a five dimensional charged black hole solution :

$$ds_5^2 = -\lambda^{-2/3} \left(1 - \frac{r_0^2}{r^2}\right) dt^2 + \lambda^{1/3} \left[\left(1 - \frac{r_0^2}{r^2}\right)^{-1} dr^2 + r^2 d\Omega_3^2 \right], \quad (5.48)$$

where

$$\lambda = \left(1 + \frac{r_0^2 \sinh^2 \alpha}{r^2}\right) \left(1 + \frac{r_0^2 \sinh^2 \gamma}{r^2}\right) \left(1 + \frac{r_0^2 \sinh^2 \sigma}{r^2}\right). \quad (5.49)$$

This is just the five-dimensional Schwarzschild metric, with the time and space components rescaled by different powers of λ . The solution is manifestly invariant under permutations of the three boost parameters, as required by U-duality. The event horizon is clearly at $r = r_0$. The coordinates we have used present the solution in a simple and symmetric form, but they do not always cover the entire spacetime. When all three charges are nonzero, the surface $r = 0$ is a smooth inner horizon. This is analogous to the situation in four dimensions with four charges [598, 599].

The mass, entropy and temperature of this solution are the same as those calculated above for the black string (5.30)(5.31)(5.32). It is interesting to take the extremal limit $r_0 \rightarrow 0$ with $r_0 e^\gamma$, $r_0 e^\alpha$, $r_0 e^\sigma$ finite and nonzero. This is an extremal black hole solution in five dimensions with a non-singular horizon which has non-zero horizon area. The entropy becomes

$$S = 2\pi \sqrt{Q_1 Q_5 N}, \quad (5.50)$$

which is independent of all the continuous parameters in the theory, and depends only on the charges (5.29). We can calculate this entropy as follows [13]. These black hole states saturate the BPS bound, so they are BPS states. Thus, we should find an ‘‘index’’, which is a quantity that is invariant under deformations and counts the number of BPS states. Such an index was computed in [13] for the case where the internal space was $M^4 = K3$ and in [460] for $M^4 = T^4$. These indices are also called helicity supertrace formulas [600]. Once we know that they do not receive contributions from non-BPS quantities, we can change the parameters of the theory and go to a point where we can do the calculation, for example, we can take R_5 to be large and then go to the point where we have the $Sym(M^4)^k$ description.

It is interesting that we can also consider near extremal black holes, in the approximation that the contribution to the mass of two of the charges is much bigger than the third and much bigger than the mass above extremality. This region in parameter space is sometimes called the “dilute gas” regime. In the five dimensional context it is natural to take $R_5 \sim l_s$, and at first sight we would not expect the CFT description to be valid. Nevertheless, it is “experimentally” observed that the absorption cross section is still (5.40), since the calculation is exactly the same as the one we did above. This suggests that the CFT description is also valid in this case. A qualitative explanation of this fact was given in [468], where it was observed that the strings could be multiply wound leading to a very low energy gap, much lower than $1/R_5$, and of the right order of magnitude as expected for a 5d black hole.

Almost all that we said in this subsection can be extended to four dimensional black holes.

Chapter 6

Other AdS Spaces and Non-Conformal Theories

6.1 Other Branes

6.1.1 M5 Branes

There exist six dimensional $\mathcal{N} = (2, 0)$ SCFTs, which have sixteen supercharges, and are expected to be non-trivial isolated fixed points of the renormalization group in six dimensions (see [93] and references therein). As a consequence, they have neither dimensionful nor dimensionless parameters. These theories have an $Sp(2) \simeq SO(5)$ R-symmetry group.

The A_{N-1} $(2, 0)$ theory is realized as the low-energy theory on the worldvolume of N coincident M5 branes (five branes of M theory). The $\mathcal{N} = (2, 0)$ supersymmetry algebra includes four real spinors of the same chirality, in the $\mathbf{4}$ of $SO(5)$. Its only irreducible massless matter representation consists of a 2-form $B_{\mu\nu}$ with a self-dual field strength, five real scalars and fermions. It is called a tensor multiplet. For a single 5-brane the five real scalars in the tensor multiplet define the embedding of the M5 brane in eleven dimensions. The R-symmetry group is the rotation group in the five dimensions transverse to the M5 worldvolume, and it rotates the five scalars. The low-energy theory on the moduli space of flat directions includes r tensor multiplets (where for the A_{N-1} theories $r = N - 1$). The moduli space is parametrized by the scalars in the tensor multiplets. It has orbifold singularities (for the A_{N-1} theory it is $\mathbb{R}^{5(N-1)}/S_N$) and the theory at the singularities is superconformal. The self-dual 2-form $B_{\mu\nu}$ couples to self-dual strings. At generic points on the moduli space these strings are BPS saturated, and at the superconformal point their tension goes to zero.

The A_{N-1} $(2, 0)$ superconformal theory has a Matrix-like DLCQ description as quantum mechanics on the moduli space of A_{N-1} instantons [601]. In this description the

chiral primary operators are identified with the cohomology with compact support of the resolved moduli space of instantons, which is localized at the origin [602]. Their lowest components are scalars in the symmetric traceless representations of the $SO(5)$ R-symmetry group.

The eleven dimensional supergravity metric describing N M5 branes is given by¹

$$\begin{aligned}
 ds^2 &= f^{-1/3}(-dt^2 + \sum_{i=1}^5 dx_i^2) + f^{2/3}(dr^2 + r^2 d\Omega_4^2), \\
 f &= 1 + \frac{\pi N l_p^3}{r^3},
 \end{aligned}
 \tag{6.1}$$

and there is a 4-form flux of N units on the S^4 .

The near horizon geometry of (6.1) is of the form $AdS_7 \times S^4$ with the radii of curvature $R_{AdS} = 2R_{S^4} = 2l_p(\pi N)^{1/3}$. Note that since $R_{AdS} \neq R_{S^4}$ this background is not conformally flat, unlike the $AdS_5 \times S^5$ background discussed above. Following similar arguments to those of section 3.1 leads to the conjecture that the A_{N-1} (2, 0) SCFT is dual to M theory on $AdS_7 \times S^4$ with N units of 4-form flux on S^4 [5].

The eleven dimensional supergravity description is applicable for large N , since then the curvature is small in Planck units. Corrections to supergravity will go like positive powers of $l_p/R_{AdS} \sim N^{-1/3}$; the supergravity action itself is of order $M_p^9 \sim N^3$ (instead of N^2 in the $AdS_5 \times S^5$ case). The known corrections in M theory are all positive powers of $l_p^3 \sim 1/N$, suggesting that the (2, 0) theories have a $1/N$ expansion at large N . The bosonic symmetry of the supergravity compactification is $SO(6, 2) \times SO(5)$. The $SO(6, 2)$ part is the conformal group of the SCFT, and the $SO(5)$ part is its R-symmetry.

The Kaluza-Klein excitations of supergravity contain particles with spin less than two, so they fall into small representations of supersymmetry. Therefore, their masses are protected from quantum (M theory) corrections. As in the other examples of the duality, these excitations correspond to chiral primary operators of the A_{N-1} (2, 0) SCFT, whose scaling dimensions are protected from quantum corrections. The spectrum of Kaluza-Klein harmonics of supergravity on $AdS_7 \times S^4$ was computed in [603]. The lowest components of the SUSY multiplets are scalar fields with

$$m^2 R_{AdS}^2 = 4k(k-3), \quad k = 2, 3, \dots
 \tag{6.2}$$

They fall into the k -th order symmetric traceless representation of $SO(5)$ with unit multiplicity. The $k = 1$ excitation is the singleton that can be gauged away except on the boundary of AdS . It decouples from the other operators and can be identified with the free “center of mass” tensor multiplet on the field theory side.

¹Our conventions are such that the tension of the M2 brane is $T_2 = 1/(2\pi)^2 l_p^3$.

Using the relation between the dimensions of the operators Δ and the masses m of the Kaluza-Klein excitations $m^2 R_{AdS}^2 = \Delta(\Delta - 6)$, the dimensions of the corresponding operators in the SCFT are $\Delta = 2k$, $k = 2, 3, \dots$ [604, 605, 606, 607]. These are the dimensions of the chiral primary operators of the A_{N-1} $(2, 0)$ theory as found from the DLCQ description². The expectation values of these operators parametrize the space of flat directions of the theory, $(\mathbb{R}^5)^{N-1}/S_N$. The dimensions of these operators are the same as the naive dimension of the product of k free tensor multiplets, though there is no good reason for this to be true (unlike the $d = 4$ $\mathcal{N} = 4$ theory, where the dimension had to be similar to the free field dimension for small λ , and then for the chiral operators it could not change as we vary λ). For large N , the $k = 2$ scalar field with $\Delta = 4$ is the only relevant deformation of the SCFT and it breaks the supersymmetry. All the non-chiral fields appear to have large masses in the large N limit, implying that the corresponding operators have large dimensions in the field theory.

The spectrum includes also a family of spin one Kaluza-Klein excitations that couple to 1-form operators of the SCFT. The massless vectors in this family couple to the dimension five R-symmetry currents of the SCFT. The massless graviton couples to the stress-energy tensor of the SCFT. As in the $d = 4$ $\mathcal{N} = 4$ case, the chiral fields corresponding to the different towers of Kaluza-Klein harmonics are related to the scalar operators associated with the Kaluza-Klein tower (6.2) by the supersymmetry algebra. For each value of (large enough) k , the SUSY multiplets include one field in each tower of Kaluza-Klein states. Its $SO(5)$ representation is determined by the representation of the scalar field. For instance, the R-symmetry currents and the energy-momentum tensor are in the same supersymmetry multiplet as the scalar field corresponding to $k = 2$ in equation (6.2).

As we did for the D3 branes in section 4.1, we can place the M5 branes at singularities and obtain other dual models. If we place the M5 branes at the origin of $\mathbb{R}^6 \times \mathbb{R}^5/\Gamma$ where Γ is a discrete subgroup of the $SO(5)$ R-symmetry group, we get $AdS_7 \times S^4/\Gamma$ as the near horizon geometry. With $\Gamma \subset SU(2) \subset SO(5)$ which is an ADE group we obtain theories with $(1, 0)$ supersymmetry. The analysis of these models parallels that of section 4.1.1. In particular, the matching of the Γ -invariant supergravity Kaluza-Klein modes and the field theory operators has been discussed in [608].

Another example is the D_N $(2, 0)$ SCFT. It is realized as the low-energy theory on the worldvolume of N M5 branes at an $\mathbb{R}^5/\mathbb{Z}_2$ orientifold singularity. The \mathbb{Z}_2 reflects the five coordinates transverse to the M5 branes and changes the sign of the 3-form field C of eleven dimensional supergravity. The near horizon geometry is the smooth space $AdS_7 \times \mathbf{RP}^4$ [604]. In the supergravity solution we identify the fields at points on the sphere with the fields at antipodal points, with a change of the sign of the C

²The DLCQ description corresponded to the theory including the free tensor multiplet, so it included also the $k = 1$ operator.

field. This identification projects out half of the Kaluza-Klein spectrum and only the even k harmonics remain. An additional chiral field arises from a M2 brane wrapped on the 2-cycle in \mathbf{RP}^4 , which is non-trivial due to the orientifolding; this is analogous to the Pfaffian of the $SO(2N)$ $d = 4$ $\mathcal{N} = 4$ SYM theories which is identified with a wrapped 3-brane [216] (as discussed in section 4.1.2). The dimension of this operator is $\Delta = 2N$. To leading order in $1/N$ the correlation functions of the other chiral operators are similar to those of the A_{N-1} SCFT. The D_N theories also have a DLCQ Matrix description as quantum mechanics on the moduli space of D_N instantons [601]. This moduli space is singular. One would expect to associate the spectrum of chiral primary operators with the cohomology with compact support of some resolution of this space, but such a resolution has not been constructed yet.

A different example is the $(1, 0)$ six dimensional SCFT with E_8 global symmetry, which is realized on the worldvolume of M5 branes placed on top of the nine brane in the Hořava-Witten [609] compactification of M theory on $\mathbb{R}^{10} \times S^1/\mathbb{Z}_2$. The conjectured dual description is in terms of M theory on $AdS_7 \times S^4/\mathbb{Z}_2$ [610]. The \mathbb{Z}_2 action has a fixed locus $AdS_7 \times S^3$ on which a ten dimensional $\mathcal{N} = 1$ E_8 vector multiplet propagates. The chiral operators fall into short representations of the supergroup $OSp(6, 2|2)$. In [611] E_8 neutral and charged operators of the $(1, 0)$ theory were matched with Kaluza-Klein modes of bulk fields and fields living on the singular locus, respectively.

Correlation functions of chiral primary operators of the large N $(2, 0)$ theory can be computed by solving classical differential equations for the supergravity fields that correspond to the field theory operators. Two and three point functions of the chiral primary operators have been computed in [612].

The $(2, 0)$ SCFT has Wilson surface observables [613], which are generalizations of the operator given by $W(\Sigma) = \exp(i \int_{\Sigma} B_{\mu\nu} d\sigma^{\mu\nu})$ in the theory of a free tensor multiplet, where Σ is a two dimensional surface. A prescription for computing the Wilson surface in the dual M theory picture has been given in [294]. It amounts, in the supergravity approximation, to the computation of the minimal volume of a membrane bounded at the boundary of AdS_7 by Σ . The reasoning is analogous to that discussed in section 3.5, but here instead of the strings stretched between D-branes, M2 branes are stretched between M5 branes. Such an M2 brane behaves as a string on the M5 branes worldvolume, with a tension proportional to the distance between the M5 branes. By separating one M5 brane from N M5 branes this string can be used as a probe of the SCFT on the worldvolume of the N M5 branes, analogous to the external quarks discussed in section 3.5. If we consider two such parallel strings with length l and distance L and of opposite orientation, the resulting potential per unit length is [294]

$$\frac{V}{l} = -c \frac{N}{L^2}, \quad (6.3)$$

where c is a positive numerical constant. The dependence on L is as expected from conformal invariance. The procedure for Wilson surface computations has been applied also to the computation of the operator product expansion of Wilson surfaces, and the extraction of the OPE coefficients of the chiral primary operators [612].

The six dimensional A_{N-1} theory can be wrapped on various two dimensional manifolds. At energies lower than the inverse size of the manifolds, the low-energy effective description is in terms of four dimensional $SU(N)$ gauge theories. The two dimensional manifold and its embedding in eleven dimensions determine the amount of supersymmetry of the gauge theory. The simplest case is a wrapping on T^2 which preserves all the supersymmetry. This results in the $\mathcal{N} = 4$ $SU(N)$ SCFT, with the complex gauge coupling being the complex structure τ of the torus. In general, when the two dimensional manifold is a holomorphic curve (Riemann surface), called a supersymmetric cycle, the four dimensional theory is supersymmetric. For $\mathcal{N} = 2$ supersymmetric gauge theories the Riemann surface is the Seiberg-Witten curve and its period matrix gives the low energy holomorphic gauge couplings τ_{ij} ($i, j = 1, \dots, N - 1$) [614, 615, 616, 353]. For $\mathcal{N} = 1$ supersymmetric gauge theories the Riemann surface has genus zero and it encodes holomorphic properties of the supersymmetric gauge theory, namely the structure of its moduli space of vacua [617]. For a generic real two dimensional manifold the four dimensional theory is not supersymmetric. Some qualitative properties of the QCD string [618] and the θ vacua follow from the wrapping procedure. Of course, in the non-supersymmetric cases the subtle issue of stability has to be addressed as discussed in section 4.1. In general it is not known how to compute the near-horizon limit of 5-branes wrapped on a general manifold. At any rate, it seems that the theory on M5 branes is very relevant to the study of four dimensional gauge theories. The M5 branes theory will be one starting point for an approach to studying pure QCD in section 6.2.

Other works on M5 branes in the context of the AdS/CFT correspondence are [619, 620, 621, 622, 623, 624, 625, 626, 627, 628, 629, 630].

6.1.2 M2 Branes

$\mathcal{N} = 8$ supersymmetric gauge theories in three dimensions can be obtained by a dimensional reduction of the four dimensional $\mathcal{N} = 4$ gauge theory. The automorphism group of the $\mathcal{N} = 8$ supersymmetry algebra is $SO(8)$. The fermionic generators of the $\mathcal{N} = 8$ supersymmetry algebra transform in the real two dimensional representation of the $SO(2, 1)$ Lorentz group, and in the $\mathbf{8}_s$ representation of the $SO(8)$ automorphism algebra. The massless matter representation of the algebra consists of eight bosons in the $\mathbf{8}_v$ and eight fermions in the $\mathbf{8}_c$ of $SO(8)$. Viewed as a dimensional reduction of the vector multiplet of the four dimensional $\mathcal{N} = 4$ theory which has six real scalars,

one extra scalar is the component of the gauge field in the reduced dimension and the second extra scalar is the dual to the vector in three dimensions.

An $\mathcal{N} = 8$ supersymmetric Yang-Mills Lagrangian does not possess the full $SO(8)$ symmetry. It is only invariant under an $SO(7)$ subgroup. At long distances it is expected to flow to a superconformal theory that exhibits the $SO(8)$ R-symmetry (see [93] and references therein). The flow will be discussed in the next section. This IR conformal theory is realized as the low-energy theory on the worldvolume of N overlapping M2 branes. For a single M2 brane, the eight real scalars define its embedding in eleven dimensions. The R-symmetry group is the rotation group in the eight transverse dimensions to the M2 worldvolume, which rotates the eight scalars.

The eleven dimensional supergravity metric describing N M2 branes is given by

$$\begin{aligned} ds^2 &= f^{-2/3}(-dt^2 + dx_1^2 + dx_2^2) + f^{1/3}(dr^2 + r^2 d\Omega_7^2), \\ f &= 1 + \frac{32\pi^2 N l_p^6}{r^6}, \end{aligned} \tag{6.4}$$

and there are N units of flux of the dual to the 4-form field on S^7 .

The near horizon geometry of (6.4) is of the form $AdS_4 \times S^7$ with the radii of curvature $2R_{AdS} = R_{S^4} = l_p(32\pi^2 N)^{1/6}$. One conjectures that the three dimensional $\mathcal{N} = 8$ SCFT on the worldvolume of N M2 branes is dual to M theory on $AdS_4 \times S^7$ with N units of flux of the dual to the 4-form field on S^7 [5].

The supergravity description is applicable for large N . Corrections to supergravity will be proportional to positive powers of $l_p/R_{AdS} \sim N^{-1/6}$; the known corrections are all proportional to powers of $l_p^3 \sim N^{-1/2}$. The supergravity action itself is in this case proportional to $M_p^9 \sim N^{3/2}$, so this will be the leading behavior of all correlation functions in the large N limit. The bosonic symmetry of the supergravity compactification is $SO(3,2) \times SO(8)$. As is standard by now, the $SO(3,2)$ part is identified with the conformal group of the three dimensional SCFT, and the $SO(8)$ part is its R-symmetry. The fermionic symmetries may also be identified. We can relate the chiral fields of the SCFT with the Kaluza-Klein excitations of supergravity whose spectrum was analyzed in [631, 632].

The lowest component of the supersymmetry multiplets is a family of scalar excitations with

$$m^2 R_{AdS}^2 = \frac{1}{4}k(k-6), \quad k = 2, 3, \dots \tag{6.5}$$

They fall into the k -th order symmetric traceless representation of $SO(8)$ with unit multiplicity. The dimensions of the corresponding operators in the $\mathcal{N} = 8$ SCFT are $\Delta = k/2$, $k = 2, 3, \dots$ [604, 605, 607]. Their expectation values parametrize the space of flat directions of the theory, $(\mathbb{R}^8)^{N-1}/S_N$. When viewed as the IR limit of the three dimensional $\mathcal{N} = 8$ Yang-Mills theory, some of these operators can be identified as

$\text{Tr}(\phi^{I_1} \dots \phi^{I_k})$ where ϕ^I are the seven scalars of the vector multiplet. As noted above, the eighth scalar arises upon dualizing the vector field, which we can perform explicitly only in the abelian case. The other chiral fields are all obtained by the action of the supersymmetry generators on the fields of (6.5).

Unlike the $(2, 0)$ SCFTs, the $d = 3$ $\mathcal{N} = 8$ theories do not have a simple DLCQ description (see [633]), and the spectrum of their chiral operators is not known. The above spectrum is the prediction of the conjectured duality, for large N .

We can place the M2 branes at singularities and obtain other dual models, as in section 4.1. If we place the M2 branes at the origin of $\mathbb{R}^3 \times \mathbb{R}^8 / \Gamma$ with Γ a discrete subgroup of the $SO(8)$ R-symmetry group, we get $AdS_4 \times S^7 / \Gamma$ as the near horizon geometry. One class of models is when $\Gamma \subset SU(2) \times SU(2)$ is a cyclic group. It is generated by multiplying the complex coordinates $z_{1,2,3,4}$ of $\mathbb{C}^4 \simeq \mathbb{R}^8$ by $\text{diag}(e^{2\pi i/k}, e^{-2\pi i/k}, e^{2\pi i a/k}, e^{-2\pi i a/k})$ for relatively prime integers a, k . When $a = 1, k = 2$ the near horizon geometry is $AdS_4 \times \mathbf{RP}^7$ with a dual $\mathcal{N} = 8$ theory, which is the IR limit of the $SO(2N)$ gauge theory [604]. As in section 4.1.2, one can add a discrete theta angle to get additional theories [634, 635]. When $a = \pm 1, k > 2$ one gets $\mathcal{N} = 6$ supersymmetry, while for $a \neq \pm 1$ the supersymmetry is reduced to $\mathcal{N} = 4$. Other models are obtained by non cyclic Γ . As for the D3 branes [347] and the M5 branes [608], the Γ -invariant supergravity Kaluza-Klein modes and the field theory operators of some of these models have been analyzed in [636].

Another class of models is obtained by putting the M2 branes at hypersurface singularities defined by the complex equation

$$x^2 + y^2 + z^2 + v^3 + w^{6k-1} = 0, \quad (6.6)$$

where k is an integer. The near horizon geometry is of the form $AdS_4 \times H$, where H is topologically equivalent to S^7 but in general not diffeomorphic to it. Some of these examples, $k = 1, \dots, 28$, correspond to the known exotic seven-spheres. The expected supersymmetry is at least $\mathcal{N} = 2$ and may be $\mathcal{N} = 3$, depending on whether the R-symmetry group corresponding to the isometry group of the metric on the exotic seven spheres is $SO(2)$ or $SO(3)$. An example with $\mathcal{N} = 1$ supersymmetry is when H is the squashed seven sphere which is the homogeneous space $(Sp(2) \times Sp(1)) / (Sp(1) \times Sp(1))$. In this case the R-symmetry group is trivial ($SO(1)$).

A general classification of possible near horizon geometries of the form $AdS_4 \times H$ and related SCFTs in three dimensions is given in [333, 332]. Most of these SCFTs have not been explored yet.

Other works on M2 branes in the context of the AdS/CFT correspondence are [637, 638, 639, 640, 401, 641, 642, 643, 644, 645, 339, 646].

6.1.3 Dp Branes

Next, we discuss the near-horizon limits of other Dp branes. They give spaces which are different from AdS, corresponding to the fact that the low-energy field theories on the Dp branes are not conformal.

The Dp branes of the type II string are charged under the Ramond-Ramond $p + 1$ -form potential. Their tension is given by $T_p \simeq 1/g_s l_s^{p+1}$ and is equal to their Ramond-Ramond charge. They are BPS saturated objects preserving half of the 32 supercharges of Type II string theories. The low energy worldvolume theory of N flat coinciding Dp branes is thus invariant under sixteen supercharges. It is the maximally supersymmetric $p + 1$ dimensional Yang-Mills theory with $U(N)$ gauge group. Its symmetry group is $ISO(1, p) \times SO(9 - p)$, where the first factor is the $p + 1$ dimensional Poincaré group and the second factor is the R-symmetry group. The theory can be obtained as a dimensional reduction of $\mathcal{N} = 1$ SYM in ten dimensions to $p + 1$ dimensions. Its bosonic fields are the gauge fields and $9 - p$ scalars in the adjoint representation of the gauge group. The scalars parametrize the embedding of the Dp branes in the $9 - p$ transverse dimensions. The $SO(9 - p)$ R-symmetry group is the rotation group in these dimensions, and the scalars transform in its vector representation. In the following we will discuss the decoupling limit of the brane worldvolume theory from the bulk and the regions of validity of different descriptions.

The Yang-Mills gauge coupling in the Dp brane theory is given by

$$g_{YM}^2 = 2(2\pi)^{p-2} g_s l_s^{p-3} . \quad (6.7)$$

The decoupling from the bulk (field theory) limit is the limit $l_s \rightarrow 0$ where we keep the Yang-Mills coupling constant and the energies fixed. For $p \leq 3$ this implies that the theory decouples from the bulk and that the higher g_s and α' corrections to the Dp brane action are suppressed. For $p > 3$, as seen from (6.7), the string coupling goes to infinity and we need to use a dual description to analyze this issue.

Let $u \equiv r/\alpha'$ be a fixed expectation value of a scalar. At an energy scale u , the dimensionless effective coupling constant of the Yang-Mills theory is

$$g_{eff}^2 \sim g_{YM}^2 N u^{p-3} . \quad (6.8)$$

The perturbative Yang-Mills description is applicable when $g_{eff}^2 \ll 1$.

The ten dimensional supergravity background describing N Dp branes is given by the string frame metric

$$\begin{aligned} ds^2 &= f^{-1/2} (-dt^2 + \sum_{i=1}^p dx_i^2) + f^{1/2} \sum_{i=p+1}^9 dx_i^2 , \\ f &= 1 + \frac{c_p g_{YM}^2 N}{l_s^4 u^{7-p}} , \end{aligned} \quad (6.9)$$

with a constant $c_p = 2^{6-2p} \pi^{(9-3p)/2} \Gamma((7-p)/2)$. The background has a Ramond-Ramond $p+1$ -form potential $A_{0\dots p} = (1-f^{-1})/2$, and a dilaton

$$e^{-2(\phi-\phi_\infty)} = f^{(p-3)/2} . \quad (6.10)$$

After a variable redefinition

$$z = \frac{2\sqrt{c_p g_{YM}^2 N}}{(5-p)u^{\frac{5-p}{2}}} , \quad (6.11)$$

the field theory limit of the metric (6.9) for $p < 5$ takes the form [647, 648]

$$ds^2 = \alpha' \left(\frac{2}{5-p} \right)^{\frac{7-p}{5-p}} (c_p g_{YM}^2 N)^{\frac{1}{5-p}} z^{\frac{3-p}{5-p}} \left\{ \frac{-dt^2 + d\vec{x}^2 + dz^2}{z^2} + \frac{(5-p)^2}{4} d\Omega_{8-p}^2 \right\} , \quad (6.12)$$

with the dilaton

$$e^\phi \sim \frac{g_{eff}^2}{N} . \quad (6.13)$$

The curvature associated with the metric (6.12) is

$$\mathcal{R} \sim \frac{1}{l_s^2 g_{eff}} . \quad (6.14)$$

In the form of the metric (6.12) it is easy to see that the UV/IR correspondence, as described in section 3.1.3, leads to the relationship $\lambda \sim z$ between wavelengths in the dual field theories and distances in the gravity solution. Through (6.11) we can then relate energies in the field theory to distances in the u variable.

In the limit of infinite u the effective string coupling (6.13) vanishes for $p < 3$. This corresponds to the UV freedom of the Yang-Mills theory. For $p > 3$ the coupling increases and we have to use a dual description. This corresponds to the fact that the Yang-Mills theory is non renormalizable and new degrees of freedom are required at short distances to define the theory. The isometry group of the metric (6.12) is $ISO(1, p) \times SO(9-p)$. The first factor corresponds to the Poincaré symmetry group of the Yang-Mills theory and the second factor corresponds to its R-symmetry group.

For each Dp brane we can plot a phase diagram as a function of the two dimensionless parameters g_{eff} and N [647]. Different regions in the phase diagram have a good description in terms of different variables. As an example consider the D2 branes in Type IIA string theory. The dimensionless effective gauge coupling (6.8) is now $g_{eff}^2 \sim g_{YM}^2 N/u$. The perturbative Yang-Mills description is valid for $g_{eff} \ll 1$. When $g_{eff} \sim 1$ we have a transition from the perturbative Yang-Mills description to the Type IIA supergravity description. The Type IIA supergravity description is valid

when both the curvature is string units (6.14) and the effective string coupling (6.13) are small. This implies that N must be large.

When $g_{eff} > N^{2/5}$ the effective string coupling becomes large. In this region we grow the eleventh dimension x_{11} and the good description is in terms of an eleven dimensional theory. We can uplift the D2 brane solution (6.12) and (6.13) to an eleven dimensional background that reduces to the ten dimensional background upon Kaluza-Klein reduction on x_{11} . This can be done using the relation between the ten dimensional Type IIA string metric ds_{10}^2 and the eleven dimensional metric ds_{11}^2 ,

$$ds_{11}^2 = e^{4\phi/3}(dx_{11}^2 + A^\mu dx_\mu)^2 + e^{-2\phi/3}ds_{10}^2 . \quad (6.15)$$

ϕ and A_μ are the Type IIA dilaton and RR gauge field. The 4-form field strength is independent of x_{11} .

The curvature of the eleven dimensional metric in eleven dimensional Planck units l_p is given by

$$\mathcal{R} \sim \frac{e^{2\phi/3}}{l_p^2 g_{eff}} \sim \frac{g_{eff}^{2/3}}{l_p^2 N^{2/3}} . \quad (6.16)$$

When the curvature (6.16) is small we can use the eleven dimensional supergravity description.

The metric (6.15) corresponds to the M2 branes solution smeared over the transverse direction x_{11} . The near-horizon limit of the supergravity solution describing M2 branes localized in the compact dimension x_{11} has the form (6.4), but with a harmonic function f of the form

$$f = \sum_{n=-\infty}^{\infty} \frac{32\pi^2 l_p^6 N}{(r^2 + (x_{11} - x_{11}^0 + 2\pi n R_{11})^2)^3} , \quad (6.17)$$

where r is the radial distance in the seven non-compact transverse directions and $x_{11} \sim x_{11} + 2\pi R_{11}$. x_{11}^0 corresponds to the expectation value of the scalar dual to the vector in the three dimensional gauge theory. The expression for the harmonic function (6.17) can be Poisson resummed at distances much larger than $R_{11} = g_{YM}^2 l_s^2$, leading to

$$f = \frac{6\pi^2 N g_{YM}^2}{l_s^4 u^5} + O(e^{-u/g_{YM}^2}) . \quad (6.18)$$

The difference between the localized M2 branes solution and the smeared one is the exponential corrections in (6.18). They can be neglected at distances $u \gg g_{YM}^2$, or in terms of the dimensionless parameters when $g_{eff} \ll N^{1/2}$. According to (6.11) this corresponds to distance scales in the field theory of order \sqrt{N}/g_{YM}^2 . In this region we can still use the up lifted D2 brane solution since it is the same as the one coming from (6.17) up to exponentially small corrections. When $g_{eff} \gg N^{1/2}$, which corresponds to very low energies $u \ll g_{YM}^2$, the sum in (6.17) is dominated by the $n = 0$ contribution.

This background is of the form (6.4) (with $f = 32\pi^2 N l_p^6 / r^6$), namely the near-horizon limit of M2 branes in eleven non-compact dimensions. This is the superconformal theory which we discussed in the previous section. In figure 6.1 we plot the transition between the different descriptions as a function of the energy scale u . We see the flow from the high energy $\mathcal{N} = 8$ super Yang-Mills theory realized on the worldvolume of D2 branes to the low energy $\mathcal{N} = 8$ SCFT realized on the worldvolume on M2 branes.

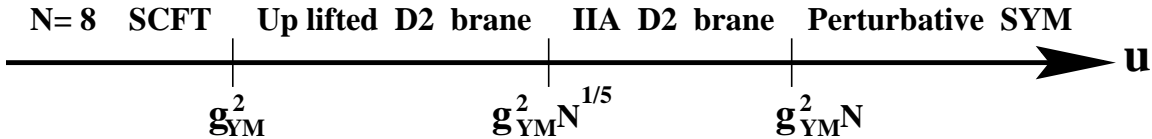

Figure 6.1: The different descriptions of the D2 brane theory as a function of the energy scale u . We see the flow from the high energy $\mathcal{N} = 8$ super Yang-Mills theory to the low energy $\mathcal{N} = 8$ SCFT.

A similar analysis can be done for the other Dp branes of the Type II string theories. In the D0 branes case one starts at high energies with a perturbative super quantum mechanics description. At intermediate energies the good description is in terms of the Type IIA D0 brane solution. At low energies the theory is expected to describe matrix black holes [649]. In the D1 branes case one starts in the UV with a perturbative super Yang-Mills theory in two dimensions. In the intermediate region the good description is in terms of the Type IIB D1 brane solution. The IR limit is described by the $Sym^N(\mathbb{R}^8)$ orbifold SCFT. The D3 branes correspond to the $\mathcal{N} = 4$ SCFT discussed extensively above.

In the D4 branes case, the UV definition of the theory is obtained by starting with the six dimensional $(2, 0)$ SCFT discussed in section 6.1.1, and compactifying it on a circle. At high energies, higher than the inverse size of the circle, we have a good description in terms of the $(2, 0)$ SCFT (or the $AdS_7 \times S^4$ background of M theory). The intermediate description is via the background of the Type IIA D4 brane. Finally at low energies we have a description in terms of perturbative super Yang-Mills theory in five dimensions. In the D5 branes case we have a good description in the IR region in terms of super Yang-Mills theory. At intermediate energies the system is described by the near-horizon background of the Type IIB D5 brane, and in the UV in terms of the solution of the Type IIB NS5 branes. We will discuss the NS5 brane theories in the next section.

Consider now the system of N D6 branes of Type IIA string theory. As before, we can attempt at a decoupling of the seven dimensional theory on the D6 branes worldvolume from the bulk by taking the string scale to zero and keeping the energies and the seven

dimensional Yang-Mills coupling fixed. The effective Yang-Mills coupling (6.8) is small at low energies $u \ll (g_{YM}^2 N)^{-1/3}$ and super Yang-Mills is a good description in this regime. The curvature in string units (6.14) is small when $u \gg (g_{YM}^2 N)^{-1/3}$ while the effective string coupling (6.13) is small when $u \ll N/g_{YM}^{2/3}$. In between these limits we can use the Type IIA supergravity solution.

When $u \sim N/g_{YM}^{2/3}$ the effective string coupling is large and we should use the description of D6 branes in terms of eleven dimensional supergravity compactified on a circle with N Kaluza-Klein monopoles. Equivalently, the description is in terms of eleven dimensional supergravity on an ALE space with an A_{N-1} singularity. When $u \gg N/g_{YM}^{2/3}$ the curvature of the eleven dimensional space vanishes and, unlike the lower dimensional branes, there does not exist a seven dimensional field theory that describes the UV. In fact, the D6 brane worldvolume theory does not decouple from the bulk.

A simple way to see that the D6 brane worldvolume theory does not decouple from the bulk is to note that now in the decoupling limit we keep $g_{YM}^2 \sim g_s l_s^3$ fixed. When we lift the D6 branes solution to M theory, this means that the eleven dimensional Planck length $l_p^3 = g_s l_s^3$ remains fixed, and therefore gravity does not decouple. Another way to see that gravity does not decouple is to consider the system of D6 branes at finite temperature in the decoupling limit. For large energy densities above extremality, $E/V \gg N/l_p^7$, we need the eleven dimensional description. This is given by an uncharged Schwarzschild black hole at the ALE singularity. The associated Hawking temperature is $T_H \sim 1/\sqrt{N l_p^9 E/V}$ and there is Hawking radiation to the asymptotic region of the bulk eleven dimensional supergravity. Generally, the worldvolume theories of Dp branes with $p > 5$ do not decouple from the bulk.

The supergravity computation of the Wilson loop, discussed in section 3.5, can be carried out for the Dp brane theories. For instance for the N D2 branes theory one gets for the quark antiquark potential, using the type IIA SUGRA D2 brane solution [294],

$$V = -c \frac{(g_{YM}^2 N)^{1/3}}{L^{2/3}}, \quad (6.19)$$

where c is a positive numerical constant. In view of the discussion above, this result should be trusted only for loops with sizes $1/g_{YM}^2 N \ll L \ll \sqrt{N}/g_{YM}^2$. For smaller loops the computation fails because we go into the perturbative regime, where the potential becomes logarithmic. For larger loops we get into the $AdS_4 \times S^7$ region.

Other works on Dp branes in the context of the AdS/CFT correspondence are [650, 648, 651, 652, 653, 654, 655, 656, 657].

6.1.4 NS5 Branes

The NS5 branes of Type II string theories couple magnetically to the NS-NS $B_{\mu\nu}$ field, and they are magnetically dual to the fundamental string. Their tension is given by $T_{NS} \simeq 1/g_s^2 l_s^6$. Like the Dp branes, they are BPS objects that preserve half of the supersymmetry of Type II theories. A fundamental string propagating in the background of N parallel NS5 branes is described far from the branes by a conformal field theory with non trivial metric, B field and dilaton, constructed in [658]. The string coupling grows as the string approaches the NS5 branes. At low energies the six dimensional theory on the worldvolume of N Type IIB NS5 branes is a $U(N)$ $\mathcal{N} = (1, 1)$ super Yang-Mills theory, which is free in the IR. However, it is an interacting theory at intermediate energies. At low energies the theory on the worldvolume of N Type IIA NS5 branes is the A_{N-1} $(2, 0)$ SCFT discussed above.

The six dimensional theories on the worldvolume of NS5 branes of Type II string theories were argued [659] to decouple from the bulk in the limit

$$g_s \rightarrow 0, \quad l_s = \text{fixed} . \quad (6.20)$$

This is because the effective coupling on the NS5 branes (e.g. the low-energy Yang-Mills coupling in the type IIB case) is $1/l_s$, while the coupling to the bulk modes goes like g_s . However, the computation of [660] showed that in this limit there is still Hawking radiation to the tube region of the NS5 brane solution, suggesting a non decoupling of the worldvolume theory from the bulk. In the spirit of the other correspondences discussed previously, one can reconcile the two by conjecturing [215] that string or M theory in the NS5 brane background in the limit (6.20), which includes the tube region, is dual to the decoupled NS5 brane worldvolume theory (“little string theory”). In particular, the fields in the tube which are excited in the Hawking radiation correspond to objects in the decoupled NS5 brane theory. In the following we will mainly discuss the Type IIA NS5 brane theory³.

The Type IIA NS5 brane may be considered as the M5 brane localized on the eleven dimensional circle. Therefore its metric is that of an M5 brane at a point on a transverse circle. In such a configuration the near horizon metric of N NS5 branes can be written as [647, 215]

$$\begin{aligned} ds^2 &= l_p^2 \left(f^{-1/3} (-dt^2 + \sum_{i=1}^5 dx_i^2) + f^{2/3} (dx_{11}^2 + du^2 + u^2 d\Omega_3^2) \right) , \\ f &= \sum_{n=-\infty}^{\infty} \frac{\pi N}{(u^2 + (x_{11} - 2\pi n/l_s^2)^2)^{3/2}} . \end{aligned} \quad (6.21)$$

The x_{11} coordinate is periodic and has been rescaled by l_p^3 ($x_{11} \equiv x_{11} + 2\pi/l_s^2$). The background also has a 4-form flux of N units on $S^1 \times S^3$.

³Type IIB NS5 branes at orbifold singularities are discussed in [661].

At distances larger than $l_s\sqrt{N}$ the NS5 brane theory is described by the A_{N-1} (2, 0) SCFT. Indeed, in the extreme low energy limit $l_s \rightarrow 0$ the sum in (6.21) is dominated by the $n = 0$ term and the background is of the form $AdS_7 \times S^4$. This reduces to the conjectured duality between M theory on $AdS_7 \times S^4$ and the (2, 0) SCFT, discussed previously. However, the NS5 brane theory is not a local quantum field theory at all energy scales since at short distances it is not described by a UV fixed point. To see this one can take l_s to infinity (or u to infinity) in (6.21) and get a Type IIA background with a linear dilaton. It has the topology of $\mathbb{R}^{1,5} \times \mathbb{R} \times S^3$ with $g_s^2(\phi) = e^{-2\phi/l_s\sqrt{N}}$, where ϕ is the \mathbb{R} coordinate. This is in accord with the fact that the NS5 brane theory exhibits a T-duality property upon compactification on tori (note that in this background a finite radius in field theory units corresponds to a finite radius in string theory units on the string theory side of the correspondence, unlike the previous cases we discussed).

The NS5 brane theories have an A-D-E classification. This can be seen by viewing them as Type II string theory on K3 with A-D-E singularities in the decoupling limit (6.20). The NS5 brane theories have an $SO(4)$ R-symmetry which we identify with the $SO(4)$ isometry of S^3 . The IIA NS5 brane theories have a moduli space of vacua of the form $(\mathbb{R}^4 \times S^1)^r/\mathcal{W}$ where r is the rank of the A-D-E gauge group and \mathcal{W} is the corresponding Weyl group. It is parametrized by the \mathcal{W} -invariant products of the $5r$ scalars in the r tensor multiplets. They fall into short representations of the supersymmetry algebra. We can match these chiral operators with the string excitations in the linear dilaton geometry describing the large u region of (6.21). The string excitations, in short representations of the supersymmetry algebra, in the linear dilaton geometry were analyzed in [215]. Indeed, they match the spectrum of the chiral operators in short representations of the NS5 brane theories. Actually, due to the fact that the string coupling goes to zero at the boundary of the linear dilaton solution, one can compute here the precise spectrum of chiral fields in the string theory, and find an agreement with the field theory even for finite N (stronger than the large N agreement that we described in section 3.2).

As in the dualities with local quantum field theories, also here one can compute correlation functions by solving differential equations on the NS5 branes background (6.21). Since in this case the boundary is infinitely far away, it is more natural to compute correlation functions in momentum space, which correspond to the S-matrix in the background (6.21). The computation of two point functions of a scalar field was sketched in [215] and described more rigorously in [662]. The NS5 brane theories are non-local, and this causes some differences in the matching between M theory and the non-gravitational NS5 brane theory in this case. One difference from the previous cases we discussed is that in the linear dilaton backgrounds if we put a cutoff at some value of the radial coordinate (generalizing the discussion of [175] which we reviewed in

section 3.1.3), the volume enclosed by the cutoff is not proportional to the area of the boundary (which it is in AdS space). Thus, if holography is valid in these backgrounds (in the sense of having a number of degrees of freedom proportional to the boundary area) it is more remarkable than holography in AdS space.

6.2 QCD

The proposed extension of the duality conjecture between field theories and superstring theories to field theories at finite temperature, as described in section 3.6, opens up the exciting possibility of studying the physically relevant non supersymmetric gauge theories. Of particular interest are non supersymmetric gauge theories that exhibit asymptotic freedom and confinement. In this section, we will discuss an approach to studying pure (without matter fields) QCD_p in p dimensions using a dual superstring description. We will be discussing mainly the cases $p = 3, 4$.

The approach proposed by Witten [185] was to start with a maximally supersymmetric gauge theory on the $p + 1$ dimensional worldvolume of N Dp branes. One then compactifies the supersymmetric theory on a circle of radius R_0 and imposes anti-periodic boundary conditions for the fermions around the circle. Since the fermions do not have zero frequency modes around the circle they acquire a mass $m_f \sim 1/R_0$. The scalars then acquire a mass from loop diagrams, and at energies much below $1/R_0$ they decouple from the system. The expected effective theory at large distances compared to the radius of the circle is pure QCD in p dimensions. Note that a similar approach was discussed in the treatment of gauge theories at finite temperature T in section 3.6, where the radius of the circle is proportional to $1/T$. The high temperature limit of the supersymmetric gauge theory in $p + 1$ dimensions is thus described by a non supersymmetric gauge theory in p dimensions.

The main obstacle to the analysis is clear from the discussions of the duality between string theory and quantum field theories in the previous sections. The string approach to weakly coupled gauge theories is not yet developed. Most of the available tools are applicable in the supergravity limit that describes the gauge theory with a large number of colors and large 't Hooft parameter. In this regime we cannot really learn directly about QCD, since the typical scale of candidate QCD states (glueballs) is of the same order of magnitude (for QCD_4 , or a larger scale for QCD_3) as the scale $1/R_0$ of the mass of the “extra” scalars and fermions. A related issue is that at short distances asymptotically free gauge theories are weakly coupled and the dual supergravity description is not valid. Therefore, we will be limited to a discussion in the strong coupling region of the gauge theories and in particular we will not be able to exhibit asymptotic freedom.

One may hope that a full solution of the classical ($g_s = 0$) string theory will provide a description of large N gauge theories for all couplings (in the 't Hooft limit). To study the gauge theories with a finite number of colors requires the quantum string theory. However, there is also a possibility that the gauge description is valid for weak coupling and the string theory description is valid for strong coupling with no smooth crossover between the two descriptions. In such a scenario there is a phase transition at $\lambda = \lambda_c$ [315, 316]. This will prevent us from using the string description to study QCD, and will prevent classical string theory from being the master field for large N QCD.

In the last part of this section we will briefly discuss another approach, based on a suggestion by Polyakov [48], to study non supersymmetric gauge theories via a non supersymmetric string description. In this approach one can exhibit asymptotic freedom qualitatively already in the gravity description. In the IR there are gravity solutions that exhibit confinement at large distances as well as strongly coupled fixed points.

6.2.1 QCD₃

The starting point for studying QCD₃ is the $\mathcal{N} = 4$ superconformal $SU(N)$ gauge theory in four dimensions which is realized as the low energy effective theory of N coinciding parallel D3 branes. As outlined above, the three-dimensional non-supersymmetric theory is constructed by compactifying this theory on $\mathbb{R}^3 \times \mathbf{S}^1$ with anti-periodic boundary conditions for the fermions around the circle. The boundary conditions break supersymmetry explicitly and as the radius R_0 of the circle becomes small, the fermions decouple from the system since there are no zero frequency modes. The scalar fields in the four dimensional theory will acquire masses at one-loop, since supersymmetry is broken, and these masses become infinite as $R_0 \rightarrow 0$. Therefore in the infrared we are left with only the gauge field degrees of freedom and the theory should be effectively the same as pure QCD₃.

We will now carry out the same procedure in the dual superstring (supergravity) picture. As has been extensively discussed in the previous sections, the $\mathcal{N} = 4$ theory on \mathbb{R}^4 is conjectured to be dual to type IIB superstring theory on $\text{AdS}_5 \times \mathbf{S}^5$ with the metric (3.5) or (3.6).

Recall that the dimensionless gauge coupling constant g_4 of the $\mathcal{N} = 4$ theory is related to the string coupling constant g_s as $g_4^2 \simeq g_s$. In the 't Hooft limit, $N \rightarrow \infty$ with $g_4^2 N \simeq g_s N$ fixed, the string coupling constant vanishes, $g_s \rightarrow 0$. Therefore, we could study the $\mathcal{N} = 4$ theory using the tree level string theory in the AdS space (3.6). If also $g_s N \gg 1$, the curvature of the AdS space is small and the string theory is approximated by classical supergravity.

Upon compactification on \mathbf{S}^1 with supersymmetry breaking boundary conditions,

(3.6) is replaced by the Euclidean black hole geometry [181, 185] ⁴

$$ds^2 = \alpha' \sqrt{4\pi g_s N} \left(u^2 (h(u) d\tau^2 + \sum_{i=1}^3 dx_i^2) + h(u)^{-1} \frac{du^2}{u^2} + d\Omega_5^2 \right), \quad (6.22)$$

where τ parametrizes the compactifying circle (with radius R_0 in the field theory) and

$$h(u) = 1 - \frac{u_0^4}{u^4}. \quad (6.23)$$

The $x_{1,2,3}$ directions correspond to the \mathbb{R}^3 coordinates of QCD₃. The horizon of this geometry is located at $u = u_0$ with

$$u_0 = \frac{1}{2R_0}. \quad (6.24)$$

The supergravity approximation is applicable for $N \rightarrow \infty$ and $g_s N \gg 1$, so that all the curvature invariants are small. The metric (6.22) describes the Euclidean theory, the Lorentzian theory is obtained by changing $\sum_{i=1}^3 dx_i^2 \rightarrow -dt^2 + dx_1^2 + dx_2^2$. Notice that this is not the same as the Wick rotation that leads to the near extremal black hole solution (3.98).

From the point of view of QCD₃, the radius R_0 of the compactifying circle provides the ultraviolet cutoff scale. To obtain large N QCD₃ itself (with infinite cutoff), one has to take $g_4^2 N \rightarrow 0$ as $R_0 \rightarrow 0$ so that the three dimensional effective coupling $g_3^2 N = g_4^2 N / (2\pi R_0)$ remains at the intrinsic energy scale of QCD₃. g_3^2 is the classical dimensionful coupling of QCD₃. The effective dimensionless gauge coupling of QCD₃ at the distance scale R_0 is therefore $g_s N$.

The proposal is that Type IIB string theory on the AdS black hole background (6.22) provides a dual description to QCD₃ (with the UV cutoff described above). The limit in which the classical supergravity description is valid, $g_s N \gg 1$, is the limit where the typical mass scale of QCD₃, $g_3^2 N$, is much larger than the cutoff scale $1/R_0$. It is the opposite of the limit that is required in order to see the ultraviolet freedom of the theory. Therefore, with the currently available techniques, we can only study large N QCD₃ with a fixed ultraviolet cutoff R_0^{-1} in the strong coupling regime. It should be emphasized that by strong coupling we mean here that the coupling is large compared to the cutoff scale, so we really have many more degrees of freedom than just those of QCD₃. QCD₃ is the theory which we would get in the limit of vanishing bare coupling, which is the opposite limit to the one we are taking.

This is analogous to, but not the same as, the lattice strong coupling expansion with a fixed cutoff given by the lattice spacing a (which is analogous to R_0 here). There,

⁴The stability issue of this background is discussed in [663].

QCD₃ is obtained in the limit $g_3^2 a \rightarrow 0$ while strong coupling lattice QCD₃ is the theory at large $g_3^2 a$. An important difference in the approach that we take, compared to the lattice description, is that we have full Lorentz invariance in the three gauge theory coordinates. The regularization of the gauge theory in the dual string theory description is provided by a one higher dimensional theory, the theory on D3 branes.

In the limit $R_0 \rightarrow 0$ the geometry (6.22) is singular. As discussed above, in this limit the supergravity description is not valid and we have to use the string theory description.

Confinement

As we noted before, the gauge coupling of QCD₃ g_3^2 has dimensions of mass, and it provides a scale already for the classical theory. The effective dimensionless expansion parameter at a length scale l , $g_3^2(l) \equiv l g_3^2$, goes to zero as $l \rightarrow 0$. Therefore, like QCD₄, the theory is free at short distances. Similarly, at a large length scale l the effective coupling becomes strong. Therefore, the interesting IR physics is non-perturbative.

In three dimensions the Coulomb potential is already confining. This is a logarithmic confinement $V(r) \sim \ln(r)$. Lattice simulations provide evidence that in QCD₃ at large distances there is confinement with a linear potential $V(r) \sim \sigma r$.

To see confinement in the dual description we will consider the spatial Wilson loop. In a confining theory the vacuum expectation value of the Wilson loop operator exhibits an area law behavior [664]

$$\langle W(C) \rangle \simeq \exp(-\sigma A(C)) , \quad (6.25)$$

where $A(C)$ is the area enclosed by the loop C . The constant σ is called the string tension. The area law (6.25) is equivalent to the quark-antiquark confining linear potential $V(L) \sim \sigma L$. This can be simply seen by considering a rectangular loop C with sides of length T and L in Euclidean space as in figure 6.2. For large T we have, when $V(L) \sim \sigma L$ and interpreting T as the time direction,

$$\langle W(C) \rangle \sim \exp(-TV(L)) \sim \exp(-\sigma A(C)) . \quad (6.26)$$

The prescription to evaluate the vacuum expectation value of the Wilson loop operator in the dual string description has been introduced in section 3.5. It amounts to computing

$$\langle W(C) \rangle = \int \exp(-\mu(D)) , \quad (6.27)$$

where $\mu(D)$ is the regularized area of the worldsheet of a string D bounded at infinity by C .

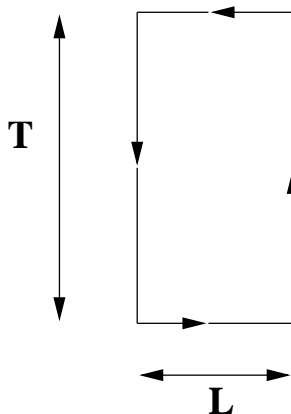

Figure 6.2: A confining quark-antiquark linear potential $V(L) \sim \sigma L$ can be extracted from the Wilson loop obeying an area law $\langle W(C) \rangle \sim \exp(-\sigma TL)$.

We will work in the supergravity approximation in which (6.27) is approximated by

$$\langle W(C) \rangle = \exp(-\mu(D)) , \quad (6.28)$$

where $\mu(D)$ is the minimal area of a string worldsheet D bounded at infinity by C .

This prescription has been applied in section 3.5 to the calculation of the Wilson loop in the $\mathcal{N} = 4$ theory which is not a confining theory. Indeed, it has been found there that it exhibits a Coulomb like behavior. The basic reason was that when we scaled up the loop C by $x^i \rightarrow \alpha x^i$ with a positive number α , we could use conformal invariance to scale up D without changing its (regularized) area. Therefore D was not proportional to $A(C)$. When scaling up the loop the surface D bends in the interior of the AdS space. In the case when such a bending is limited by the range of the radial coordinate one gets an area law. This is the case in the models at hand, in which the coordinate u in (6.22) is bounded from below by u_0 as in figure 6.3.

The evaluation of the classical action of the string worldsheet bounded by the loop C at infinite u is straightforward, as done in section 3.5 [327, 665]. The string minimizes its length by going to the region with the smallest possible metric component g_{ii} (where i labels the \mathbb{R}^3 directions), from which it gets the contribution to the string tension. The smallest value of g_{ii} in the metric (6.22) is at the horizon. Thus, we find that the Wilson loop exhibits an area law (6.25), where the string tension is given by the g_{ii} component of the metric (6.22) evaluated at the horizon $u = u_0$ times a numerical factor $\frac{1}{2\pi}$:

$$\sigma = \frac{1}{2\pi} \sqrt{4\pi g_s N} u_0^2 = \frac{(g_s N)^{1/2}}{4\sqrt{\pi} R_0^2} . \quad (6.29)$$

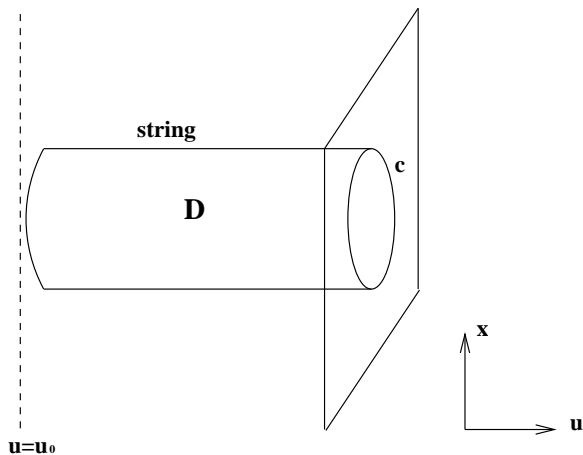

Figure 6.3: The worldsheet of the string D is bounded at infinite u by the loop C . The string tends to minimize its length by going to the region with smallest metric component g_{ii} , which in this case is near the horizon $u = u_0$. The energy between the quark and the antiquark is proportional to the distance L between them and to the string tension which is $\sigma = \frac{1}{2\pi}g_{ii}(u_0)$.

The way supergravity exhibits confinement has an analog in the lattice strong coupling expansion, as first demonstrated by Wilson [664]. The leading contribution in the lattice strong coupling expansion to the string tension is the minimal tiling by plaquettes of the Wilson loop C as we show in figure 6.4. This is analogous to the minimal area of the string worldsheet D ending on the loop C in figure 6.3. One important difference is that in the supergravity description the space is curved. Of course, a computation analogous to the Wilson loop computations we described in section 3.5 which would be done in flat space would also exhibit confinement, since the minimal area of the string worldsheet D ending on the loop C is simply the area enclosed by the loop itself.

The quark-antiquark linear potential $V = \sigma L$ can have corrections arising from the fluctuations of the thin tube (string) connecting the quark and antiquark. Lüscher studied a leading correction to the quark-antiquark potential at large separation L . Within a class of bosonic effective theories in flat space that describe the vibrations of the thin flux tubes he found a universal term, $-c/L$, called a Lüscher term [666] :

$$V = \sigma L - c/L . \tag{6.30}$$

For a flux tube in d space-time dimensions $c = (d - 2)/24\pi$. Lattice QCD calculations of the heavy quark potential have not provided yet a definite confirmation of this subleading term. This term can also not be seen order by order in the lattice strong

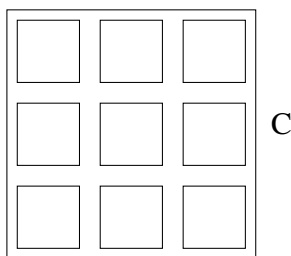

Figure 6.4: The leading contribution in the lattice strong coupling expansion to the string tension is the minimal tiling by plaquettes of the Wilson loop C .

coupling expansion. Subleading terms in this expansion are of the non minimal tiling type, as in figure 6.5, and correct only the string tension but not the linear behavior of the potential.

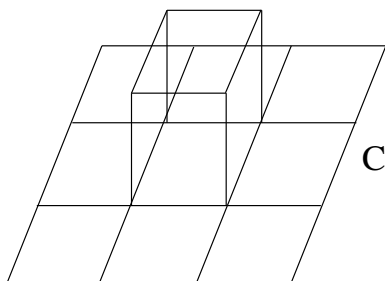

Figure 6.5: Subleading contribution in the lattice strong coupling expansion to the string tension, which is a non minimal tiling of the Wilson loop. This is the lattice analog of the fluctuations of the string worldsheet.

The computation of the vacuum expectation value of the Wilson loop (6.28) based on the minimal area of the string worldsheet D does not exhibit the Lüscher term [667]. This is not surprising. Even if the Lüscher term exists in QCD_3 , it should originate from the fluctuations of the string worldsheet (6.27) that have not been taken into account in (6.28). Some analysis of these fluctuations has been done in [300], but the full computation has not been carried out yet.

Other works on confinement as seen by a dual supergravity description are [668, 669, 670, 299].

Mass Spectrum

If the dual supergravity description is in the same universality class as QCD₃ it should exhibit a mass gap. In the following we will demonstrate this property. We will also compute the spectrum of lowest glueball masses in the dual supergravity description. They will resemble qualitatively the strong coupling lattice picture. We will also discuss a possible comparison to lattice results in the continuum limit.

The mass spectrum in pure QCD can be obtained by computing the correlation functions of gauge invariant local operators (glueball operators) or Wilson loops, and looking for the particle poles. As we discussed extensively before, correlation functions of local operators are related (in some limit) to tree level amplitudes in the dual supergravity description. We will consider the two point functions of glueball operators \mathcal{O} (for instance, we could take $\mathcal{O} = \text{Tr}(F^2)$). For large $|x - y|$ it has an expansion of the form

$$\langle \mathcal{O}(x)\mathcal{O}(y) \rangle \simeq \sum c_i \exp(-M_i|x - y|) , \quad (6.31)$$

where M_i are called the glueball masses.

We will classify the spectrum of glueballs by J^{PC} where J is the glueball spin, P its parity and C its charge conjugation eigenvalue. The action of C on the gluon fields is [671]

$$C : A_\mu^a T_{ij}^a \rightarrow -A_\mu^a T_{ij}^a , \quad (6.32)$$

where the T^a 's are the hermitian generators of the gauge group. In string theory, charge conjugation corresponds to the worldsheet parity transformation changing the orientation of the open strings attached to the D-branes.

Consider first the lowest mass glueball state. It carries 0^{++} quantum numbers. One has to identify a corresponding glueball operator, namely a local gauge invariant operator with these quantum numbers. The lowest dimension operator with these properties is $\text{Tr}(F^2)$, and we have to compute its two point function. To do that we need to identify first the corresponding supergravity field that couples to it as a source at infinite u . This is the Type IIB dilaton field Φ .

The correspondence between the gauge theory and the dual string theory picture asserts that in the SUGRA limit the computation of the correlation function amounts to solving the field equation for Φ in the AdS black hole background (6.22),

$$\partial_\mu(\sqrt{g}g^{\mu\nu}\partial_\nu\Phi) = 0 . \quad (6.33)$$

In order to find the lowest mass modes we consider solutions of Φ which are independent of the angular coordinate τ and take the form $\Phi = f(u)e^{ikx}$. Plugging this in (6.33) we obtain the differential equation

$$\partial_u[u(u^4 - u_0^4)\partial_u f(u)] + M^2 u f(u) = 0, \quad M^2 = -k^2 . \quad (6.34)$$

The eigenvalues M^2 of this equation are the glueball masses squared.

At large u equation (6.34) has two independent solutions, whose asymptotic behavior is $f \sim \text{constant}$ and $f \sim 1/u^4$. We consider normalizable solutions and choose the second one. Regularity requires the vanishing of the derivative of $f(u)$ at the horizon. The eigenvalues M^2 can be determined numerically [672, 673, 674], or approximately via WKB techniques [672, 675].

One finds that:

- (i) There are no solutions with eigenvalues $M^2 \leq 0$.
- (ii) There is a discrete set of eigenvalues $M^2 > 0$.

This exhibits the mass gap property of the supergravity picture. In fact, even without an explicit solution of the eigenvalues M^2 of equation (6.34), the properties (i) and (ii) can be deduced from the structure of the equation and the requirement for normalizable and regular solutions [185].

The 0^{++} mass spectrum in the WKB approximation closely agrees with the more accurate numerical solution. It takes the form

$$M_{0^{++}}^2 \approx \frac{1.44n(n+1)}{R_0^2}, \quad n = 1, 2, 3, \dots \quad (6.35)$$

The mass spectrum (6.35), that corresponds to a massless mode of the string in ten dimensions, is proportional to the cutoff $1/R_0$ and not to $\sigma^{1/2}$, which is bigger by a power of $g_s N$ (6.29). This is qualitatively similar to what happens in strong coupling lattice QCD with lattice spacing a . As we will discuss in the next section, in the strong coupling lattice QCD description the lowest masses of glueballs are proportional to $1/a$. Note that in a stringy description of QCD we would expect the glueballs to correspond to string excitations, which are expected to have masses of order $\sigma^{1/2}$. Therefore in the supergravity limit, $g_s N \gg 1$, the glueballs that correspond to the string excitations are much heavier than the “supergravity glueballs” which we analyzed.

The natural scale for the glueball masses of continuum QCD₃ is $g_3^2 N$. Therefore to get to the continuum QCD₃ region we have to require $g_3^2 N \ll 1/R_0$ which implies $g_s N \ll 1$. As discussed above, our computation is performed in the opposite limit $g_s N \gg 1$. In particular, we do not have control over possible mixing between glueball states and the other scalars and fermionic degrees of freedom which are at the same mass scale $1/R_0$ in the field theory.

We can attempt a numerical comparison of the supergravity computations with the continuum limit of lattice QCD, obtained by taking the bare coupling to zero. Since these are computations at two different limits of the coupling value (of the original $\mathcal{N} = 4$ theory) there is a priori no reason for any agreement. Curiously, it turns out that ratios of the glueball excited state masses with $n > 1$ in (6.35) and the lowest mass $n = 1$ state are in reasonably good agreement with the lattice computations (within

the systematic and statistical error bars) [672, 676].

As a second example consider the spectrum of 0^{--} glueball masses. It can be computed via the field equations of the NS-NS 2-form field. The details of the computation can be found in [672] and, as in the 0^{++} case, the ratios of the glueball masses are found to be in good agreement with the lattice computations.

In closing the numerical comparison we note another curious agreement between the supergravity computation and the weak coupling lattice computations. This is for the ratio of the lowest mass 0^{++} and 0^{--} glueball states,

$$\begin{aligned} \left(\frac{M_{0^{--}}}{M_{0^{++}}}\right)_{\text{supergravity}} &= 1.50, \\ \left(\frac{M_{0^{--}}}{M_{0^{++}}}\right)_{\text{lattice}} &= 1.45 \pm 0.08 . \end{aligned} \tag{6.36}$$

As stressed above, the regime where we would have liked to compute the mass spectrum is in the limit of small $g_s N$ (or large ultraviolet cutoff $1/R_0$). In this limit the background is singular and we have to use the string theory description, which we lack. We can compute the subleading correction in the strong coupling expansion to the masses. This requires the inclusion of the α'^3 corrections to the supergravity action. The typical form of the masses is

$$M^2 = \frac{c_0 + c_1 \alpha'^3 / R^6}{R_0^2} , \tag{6.37}$$

with c_0 as in (6.35). The background metric is modified by the inclusion of the $\alpha'^3 \mathcal{R}^4$ string correction to the supergravity action. The modified metric has been derived in [290, 677]. Based on this metric the corrections to the masses c_1 have been computed in [672]. While these corrections significantly change the glueball masses, the corrections to the mass ratios turn out to be relatively small.

Lattice computations may exhibit lattice artifacts due to the finite lattice spacing. Removing them amounts to taking a sufficiently small lattice spacing such that effectively the right physics of the continuum is captured. Getting close to the continuum means, in particular, that deviations from Lorentz invariance are minimized.

Analogous “artifacts” are seen in the dual supergravity description. They correspond to Kaluza-Klein modes that are of the same mass scale as the glueball mass scale. There are Kaluza-Klein modes from the circle coordinate τ in (6.22) that provides the cutoff to the three dimensional theory. They have a typical mass scale of order $1/R_0$. There are also $SO(6)$ non-singlet Kaluza-Klein modes from the five-sphere in (6.22). In the field theory they correspond to operators involving the $SO(6)$ non-singlet scalar and fermion fields of the high-energy theory. They have a mass scale of order $1/R_0$ too.

The inclusion of the subleading α'^3 correction does not make the Kaluza-Klein modes sufficiently heavy to decouple from the spectrum [678, 672]. This means that the dual

supergravity description is also capturing physics of the higher dimensions, or of the massive scalar and fermion fields from the point of view of QCD₃. One hopes that upon inclusion of all the α' corrections, and taking the appropriate limit of small $g_s N$ (or large cutoff $1/R_0$), these Kaluza-Klein modes will decouple from the system and leave only the gauge theory degrees of freedom. Currently, we do not have control over the α' corrections, which requires an understanding of a two dimensional sigma model with a RR background. In section 6.2.3 we will use an analogy with lattice field theory to improve on our supergravity description and remove some of the Kaluza-Klein modes.

6.2.2 QCD₄

One starting point for obtaining QCD₄ is the (2, 0) superconformal theory in six dimensions realized on N parallel coinciding M5-branes, which was discussed in section 6.1. The compactification of this theory on a circle of radius R_1 gives a five-dimensional theory whose low-energy effective theory is the maximally supersymmetric $SU(N)$ gauge theory, with a gauge coupling constant $g_5^2 = 2\pi R_1$. To obtain QCD₄, one compactifies this theory further on another \mathbf{S}^1 of radius R_0 . The dimensionless gauge coupling constant g_4 in four dimensions is given by $g_4^2 = g_5^2/(2\pi R_0) = R_1/R_0$. As in the previous case, to break supersymmetry one imposes the anti-periodic boundary condition on the fermions around the second \mathbf{S}^1 . And, as in the previous case, to really get QCD₄ we need to require that the typical mass scale of QCD states, Λ_{QCD} , will be much smaller than the other mass scales in our construction ($1/R_1$ and $1/R_0$), and this will require going beyond the supergravity approximation. However, one can hope that the theory obtained from the supergravity limit will be in the same universality class as QCD₄, and we will give some evidence for this.

As discussed in section 6.1, the large N limit of the six-dimensional theory is M theory on $\text{AdS}_7 \times \mathbf{S}^4$. Upon compactification on the two circles and imposing anti-periodic boundary conditions for the fermions on the second \mathbf{S}^1 , we get M theory on a black hole background [185]. Taking the large N limit while keeping the 't Hooft parameter $2\pi\lambda = g_4^2 N$ finite requires $R_1 \ll R_0$. We can now use the duality between M theory on a circle and Type IIA string theory, and the M5 brane wrapping on the \mathbf{S}^1 of radius R_1 becomes a D4 brane. The large N limit of QCD₄ then becomes Type IIA string theory on the black hole geometry given by the metric

$$ds^2 = \frac{2\pi\lambda}{3u_0} u \left(4u^2 \sum_{i=1}^4 dx_i^2 + \frac{4}{9u_0^2} u^2 \left(1 - \frac{u_0^6}{u^6}\right) d\tau^2 + 4 \frac{du^2}{u^2 \left(1 - \frac{u_0^6}{u^6}\right)} + d\Omega_4^2 \right), \quad (6.38)$$

with a non constant dilaton background

$$e^{2\phi} = \frac{8\pi\lambda^3 u^3}{27u_0^3 N^2}. \quad (6.39)$$

The coordinates $x_i, i = 1, \dots, 4$, parametrize the \mathbb{R}^4 gauge theory space-time, the coordinate $u_0 \leq u \leq \infty$, and τ is an angular coordinate with period 2π . The location of the horizon is at $u = u_0$, which is related to the radius R_0 of the compactifying circle as

$$u_0 = \frac{1}{3R_0} . \quad (6.40)$$

Equivalently, we could have started with the five dimensional theory on the world-volume of N D4 branes and heated it up to a finite temperature $T = 1/2\pi R_0$. Indeed, the geometry (6.38) with the dilaton background (6.39) is the near horizon geometry of the non-extremal D4 brane background. But again, when we Wick rotate (6.38) back to Lorentzian signature we take one of the coordinates x_i as time. Notice that the string coupling (6.39) goes as $1/N$.

Confinement

QCD₄ at large distances is expected to confine with a linear potential $V(r) \sim \sigma r$ between non-singlet states. Therefore, the vacuum expectation value of the Wilson loop operator is expected to exhibit an area law behavior. In order to see this in the dual description we follow the same procedure as in QCD₃.

The string tension σ is given by the coefficient of the term $\sum_{i=1}^4 dx_i^2$ in the metric (6.38), evaluated at the horizon $u = u_0$, times a $\frac{1}{2\pi}$ numerical factor :

$$\sigma = \frac{4}{3}\lambda u_0^2 = \frac{4\lambda}{27R_0^2} . \quad (6.41)$$

In QCD₄ it is believed that confinement is a consequence of the condensation of magnetic monopoles via a dual Meissner effect. Such a mechanism has been shown to occur in supersymmetric gauge theories in four dimensions [679]. This has also been demonstrated to some extent on the lattice via the implementation of the 't Hooft Abelian Projection [680]. We will now see that this appears to be the mechanism also in the dual string theory description [293].

Consider the five dimensional theory on the world volume of the D4 branes. A magnetic monopole is realized as a D2 brane ending on the D4 brane [165]. It is a string in five dimensions. Upon compactification on a circle, the four dimensional monopole is obtained by wrapping the string on the circle. We can now compute the potential between a monopole and anti-monopole. This amounts to computing the action of a D2-brane interpolating between the monopole and the anti-monopole, which mediates the force between them as in figure 6.6(a). This is the electric-magnetic dual of the computation of the quark-anti-quark potential described above.

If the pair is separated by a distance L in the x_1 direction, and stretches along the x_2 direction (which we can interpret as the Euclidean time), the D2 brane coordinates

are τ, x_1, x_2 . The action per unit length in the x_2 direction is given by

$$V = \frac{1}{(2\pi)^2 \alpha'^{3/2}} \int_0^L d\tau dx_1 e^{-\phi} \sqrt{\det G} , \quad (6.42)$$

where G is the induced metric on the D2 brane worldvolume. We have to find a configuration of the D2-brane that minimizes (6.42). For $L > L_c$ where (up to a numerical constant) $L_c \sim R_0$, there is no minimal volume D2 brane configuration that connects the monopole and the anti-monopole and the energetically favorable configuration is as in figure 6.6(b). Therefore there is no force between the monopole and the anti-monopole, which means that the magnetic charge is screened. At length scales $L \gg R_0$ we expect pure QCD₄ as the effective description. We see that in this region confinement is accompanied by monopole condensation, as we expect.

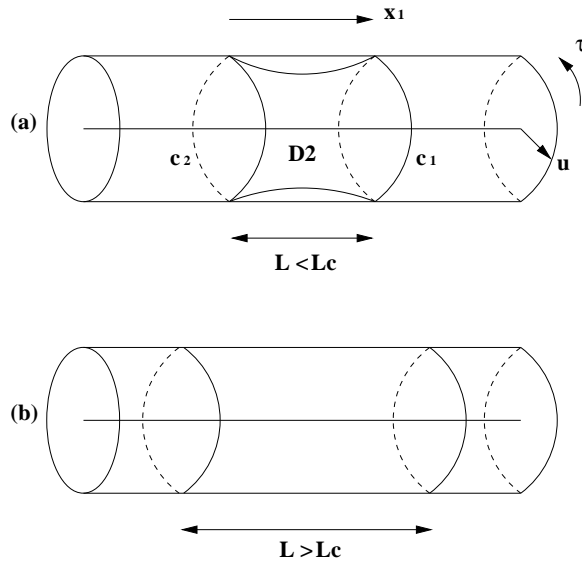

Figure 6.6: The magnetic monopole is a string in five dimensions and the four dimensional monopole is obtained by wrapping the string on the circle. The potential between a monopole (wrapped on c_1) and an anti-monopole (wrapped in the opposite orientation on c_2), separated by a distance L in the x_1 direction, amounts to computing the action of a D2-brane which mediates the force between them as in figure (a). For $L > L_c$ there is no minimal volume D2 brane configuration that connects the monopole and the anti-monopole and the energetically favorable configuration is as in figure (b), and then the magnetic charge is screened.

θ Vacua

In addition to the gauge coupling, four dimensional gauge theories have an additional parameter θ which is the coefficient of the $\text{Tr}(F \wedge F)$ term in the Lagrangian. The θ angle dependence of asymptotically free gauge theories captures non trivial dynamical information about the theory. Unlike in spontaneously broken gauge theories, it cannot be analyzed by an instanton expansion. What is required is an appropriate effective description of the theories at long wavelengths. Such an effective description is provided by the lattice. However, since the Lorentz invariance is lost by the discretization of space time, it is very difficult to study questions such as the behavior of the system under $\theta \rightarrow \theta + 2\pi$. Also, the construction of instantons which are the relevant objects in the analysis of the θ dependence is a rather non trivial task and involves delicate cooling techniques.

Another effective description may be provided by the description of the four dimensional gauge theories by the M5 brane wrapping a non supersymmetric cycle. Indeed, in this formalism, one sees that the vacuum energy exhibits the correct θ angle behavior in softly broken supersymmetric gauge theories [681].

In this subsection we use the dual string theory description to analyze the θ angle dependence in large N $SU(N)$ gauge theory [682]. Since the amplitude for an instanton is weighted by a factor $\exp(-8\pi^2 N/\lambda)$ where λ is the 't Hooft parameter (which we keep fixed), it naively seems that the instanton effects vanish as $N \rightarrow \infty$. However, unlike the $\mathcal{N} = 4$ gauge theory for instance, here one expects this not to be the case due to IR divergences in the theory.

Let us first review what we expect the behavior of the θ dependence to be from the field theory viewpoint. The Yang-Mills action is

$$I_{YM} = \int d^4x \text{Tr} \left(\frac{N}{4\lambda} F^2 + \frac{\theta}{16\pi^2} F \tilde{F} \right). \quad (6.43)$$

At large N we expect the energy of the vacuum to behave like $E(\theta) = N^2 C(\theta/N)$. The N^2 factor is due to the fact that this is the order of the number of degrees of freedom (this also follows from the standard scaling of the leading diagrams in the 't Hooft limit). The dependence on θ/N follows from (6.43) as is implied by the large N limit. θ is chosen to be periodic with period 2π . Since the physics should not change under $\theta \rightarrow \theta + 2\pi$ we require that $E(\theta + 2\pi) = E(\theta)$.

These conditions cannot be satisfied by a smooth function of θ/N . They can be satisfied by a multivalued function with the interpretation that there are N inequivalent vacua, and all of them are stable in the large N limit. The vacuum energy is then given by a minimization of the energy of the k^{th} vacuum E_k with respect to k

$$E(\theta) = \min_k E_k(\theta) = N^2 \min_k C((\theta + 2\pi k)/N), \quad (6.44)$$

for some function $C(\theta)$ which is quadratic in θ for small values of θ .

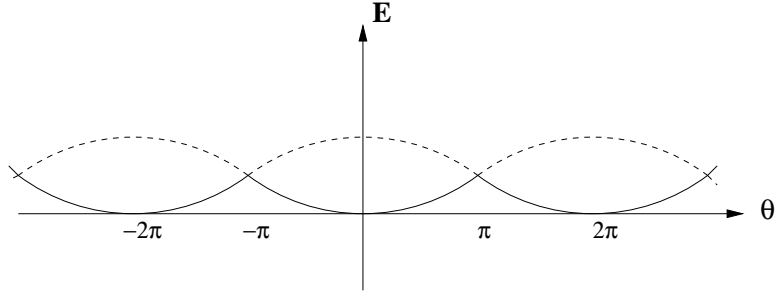

Figure 6.7: The energy of the vacuum is expected to be a multibranched function.

The function $E(\theta)$ is periodic in θ and jumps at some values of θ between different branches. The CP transformation acts by $\theta \rightarrow -\theta$ and is a symmetry only for $\theta = 0, \pi$. Therefore, $C(\theta) = C(-\theta)$. One expects an absolute minimum at $\theta = 0$ and a non vanishing of the second derivative of $E(\theta)$ with respect to θ , which corresponds to the topological susceptibility χ_t of the system as we will discuss later. Taking all these facts into account one conjectures in the leading order in $1/N$ that [683]

$$E(\theta) = \chi_t \min_k (\theta + 2\pi k)^2 + O(1/N) , \quad (6.45)$$

where χ_t is positive and independent of N . At $\theta = \pi$ the function exhibits the jump between the vacua at $k = 0$ and $k = -1$ and the spontaneous breaking of CP invariance.

In order to analyze the θ dependence in the dual string theory description with the background (6.38) we have to identify the θ parameter. This is done by recalling that the effective Lagrangian of N D4 branes in Type IIA string theory has the coupling

$$\frac{1}{16\pi^2} \int d^5x \varepsilon^{\rho\alpha\beta\gamma\delta} \mathcal{A}_\rho \text{Tr}(F_{\alpha\beta} F_{\gamma\delta}) , \quad (6.46)$$

where \mathcal{A} is the Type IIA RR 1-form and F is the $U(N)$ gauge field strength on the five dimensional brane worldvolume. Upon compactification of the D4 brane theory on a circle we see that the four dimensional θ parameter is related to the integral of the RR 1-form on the circle. Since it is a ten dimensional field it is a parameter from the worldvolume point of view.

In the dual description we define the parameters at infinite u . The θ parameter is defined as the integral of the RR 1-form component on the circle at infinite u

$$\theta = \int d\tau \mathcal{A}_\tau = 2\pi \mathcal{A}_\tau^\infty , \quad (6.47)$$

which is defined modulo $2\pi k, k \in \mathbb{Z}$.

The action for the RR 1-form takes the form

$$I = \frac{1}{2\kappa_{10}^2} \int d^{10}x \sqrt{g} \frac{1}{4} g^{\alpha\alpha'} g^{\beta\beta'} (\partial_\alpha \mathcal{A}_\beta - \partial_\beta \mathcal{A}_\alpha) (\partial_{\alpha'} \mathcal{A}_{\beta'} - \partial_{\beta'} \mathcal{A}_{\alpha'}) , \quad (6.48)$$

and the equation of motion for \mathcal{A} is

$$\partial_\alpha [\sqrt{g} g^{\beta\gamma} g^{\alpha\delta} (\partial_\gamma \mathcal{A}_\delta - \partial_\delta \mathcal{A}_\gamma)] = 0 . \quad (6.49)$$

The required solution $A_\tau(u)$ to (6.49), regular at $u = u_0$ and with vanishing field strength at infinite u (in order to have finite energy), takes the form

$$A_\tau(u) = A_\tau^\infty \left(1 - \frac{u_0^6}{u^6}\right) . \quad (6.50)$$

Evaluating the Type IIA action for the RR 1-form (6.48) with the solution (6.50) and recalling the $2\pi\mathbb{Z}$ ambiguity we get the vacuum energy (6.45) where χ_t is independent of N [682].

In order to check that the vacua labeled by k are all stable in the limit $N \rightarrow \infty$ we need a way to estimate their lifetime. The domain wall separating two adjacent vacua is constructed by wrapping a D6 brane of Type IIA string theory on the S^4 part of the metric [682]. Since the energy density of the brane at weak coupling is of order $1/g_s$ where g_s is the Type IIA string coupling, as $N \rightarrow \infty$ (with fixed $g_s N$) it is of order N . If we assume a mechanism for the decay of a k -th vacuum via a D6 brane bubble, its decay rate is of the order of e^{-N} . Thus, there is an infinite number of stable vacua in the infinite N limit.

One can repeat the discussion of confinement in the previous subsection for $\theta \neq 0$. When $\theta = 2\pi p/q$ with co-prime integers p, q the confinement is associated with a condensation of $(-p, q)$ dyons and realizes the mechanism of oblique confinement.

Mass Spectrum

The analysis of the mass spectrum of QCD₄ as seen by the dual description in the supergravity limit is similar to the one we carried out for QCD₃. It is illuminating to consider an analogous picture of strong coupling lattice QCD [293].

In strong coupling lattice QCD the masses of the lightest glueballs are of order $1/a$ where a is the lattice spacing. The reasoning is that in strong coupling lattice QCD the leading contribution to the correlator of two Wilson loops separated by distance L is from a tube with the size of one plaquette, as in figure 6.8, that connects the loops. With the Wilson lattice action the 0^{++} glueball mass is given by [684]

$$M_{0^{++}} = -4 \log(g_4^2 N) a^{-1} . \quad (6.51)$$

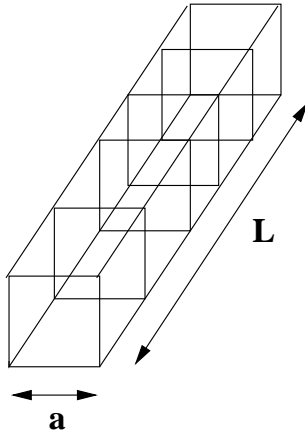

Figure 6.8: The leading contribution in strong coupling lattice QCD to the correlator of two Wilson loops, separated by distance L , is from a tube with the size of one plaquette that connects the loops. This leads to the lowest mass glueballs having a mass of the order of $1/a$, where a is the lattice spacing.

To make the connection with continuum QCD₄ we would like to sum the lattice strong coupling expansion $M_{0++} = F(g_4^2 N) a^{-1}$, and take the limit $a \rightarrow 0$ and $g_4 \rightarrow 0$ with

$$g_4^2 N \simeq \frac{1}{b \log(1/a \Lambda_{QCD})} \quad \text{as} \quad a \rightarrow 0, \quad (6.52)$$

where g_4 is the four dimensional coupling and b is the first coefficient of the β -function. We hope that in the limit (6.52) we will get a finite glueball mass measured in Λ_{QCD} units.

In the dual string theory description the analog of a is R_0 . The strong coupling expansion is analogous to the α' expansion of string theory. Supergravity is the leading contribution in this expansion. The lowest glueball masses M_g correspond to the zero modes of the string, and their mass is proportional to $1/R_0$. Another way to see that this limit resembles the strong coupling lattice QCD picture is to consider the Wilson loop correlation function $\langle W(C_1)W(C_2) \rangle$ as in figure 6.9(a).

For $L > L_c$, where L is the distance between the loops and L_c is determined by the size of the loops, there is no stable string worldsheet configuration connecting the two loops, as in figure 6.9(b). The string worldsheet that connects the loops as in figure 6.10(a) collapses and the two disks are now connected by a tube of string scale size as in figure 6.10(b), resembling the strong coupling lattice QCD picture. The correlation function is then mediated by a supergraviton exchange between the disks. Thus, the supergravitons are identified with the glueball states and the lowest glueball masses

turn out to be proportional to $1/R_0$ [293].

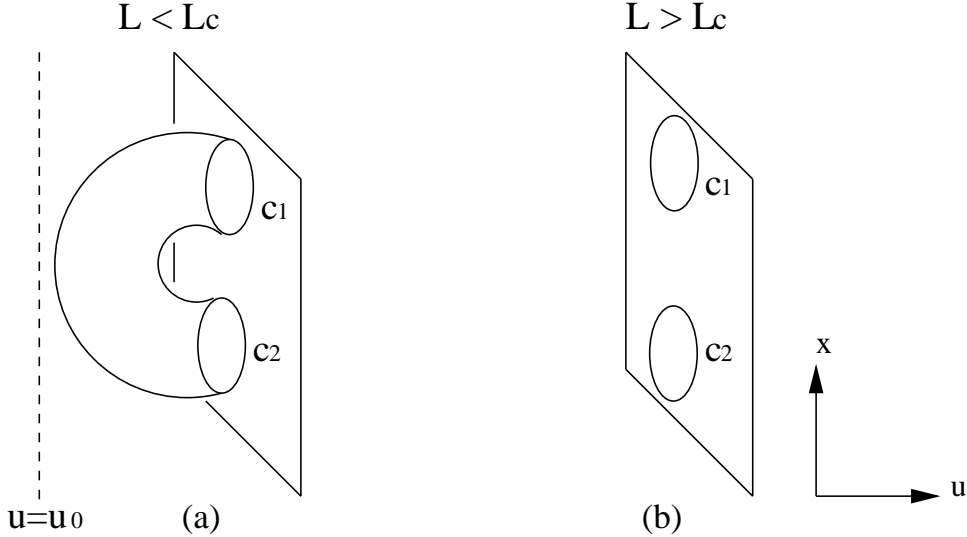

Figure 6.9: The Wilson loop correlation function in figure (a) is computed by minimization of the string worldsheet that interpolates between them. When the distance between the loops L is larger than L_c there is no stable string worldsheet configuration connecting the two loops as in figure (b).

As in strong coupling lattice QCD, to make the connection with the actual QCD₄ theory we need to sum the strong coupling expansion $M_g = F(g_4^2 N)/R_0$ and take the limit of $R_0 \rightarrow 0$ and $g_4 \rightarrow 0$ with

$$g_4^2 N \rightarrow \frac{1}{b \log(1/R_0 \Lambda_{QCD})} \quad \text{as} \quad R_0 \rightarrow 0. \quad (6.53)$$

Again, we hope that in the limit (6.53) we will get a finite glueball mass proportional to Λ_{QCD} .

In the limit (6.53) the background (6.38) is singular. Thus, to work at large N in this limit we need the full tree level string theory description and not just the SUGRA limit. The supergravity description will provide us with information analogous to that of strong coupling lattice QCD with a finite cutoff. However, since as discussed before the regularization here is done via a higher dimensional theory, we will have the advantage of a full Lorentz invariant description in four dimensions. What we should be worried about is whether we capture the physics of the higher dimensions as well (which from the point of view of QCD₄ correspond to additional charged fields).

In order to compute the mass gap we consider the scalar glueball 0^{++} . The 0^{++} glueball mass spectrum is obtained by solving the supergravity equation for any mode

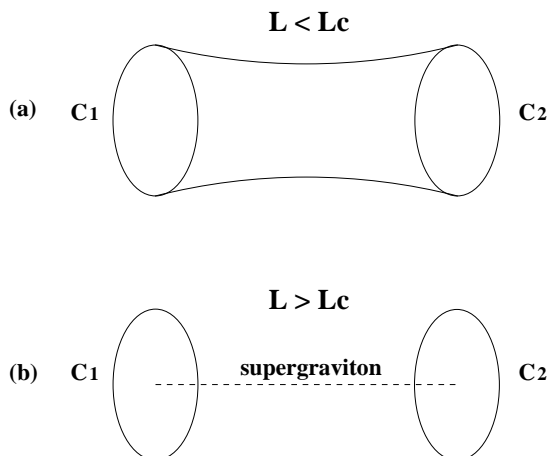

Figure 6.10: The string worldsheet that connects the loops in figure (a) collapses and the two disks are now connected by a tube of a string scale as in figure (b). The correlation function is mediated by a supergraviton exchange between the disks and the supergravitons are identified with the glueball states.

f that couples to 0^{++} glueball operators; we expect (and this is verified by the calculation) that the lightest glueball will come from a mode that couples to the operator $\text{Tr}(F^2)$. There are several steps to be taken in order to identify this mode and its supergravity equation. First, we consider small fluctuations of the supergravity fields on the background (6.38), (6.39). The subtlety that arises is the need to disentangle the mixing between the dilaton field and the volume factor which has been done in [685]. One then plugs the appropriate “diagonal” combinations of these fields into the supergravity equations of motion. The field/operator identification can then be done by considering the Born-Infeld action of the D4 brane in the gravitational background.

To compute the lowest mass modes we consider solutions of the form $f = f(u)e^{ikx}$ which satisfy the equation

$$\frac{1}{u^3} \partial_u [u(u^6 - u_0^6) \partial_u f(u)] + M^2 f(u) = 0 . \quad (6.54)$$

The eigenvalues M^2 are the glueball masses. The required solutions are normalizable and regular at the horizon. The eigenvalues M^2 can be determined numerically [685] or approximately via WKB techniques [675].

As in QCD_3 one finds that:

- (i) There are no solutions with eigenvalues $M^2 \leq 0$.
- (ii) There is a discrete set of eigenvalues $M^2 > 0$.

This exhibits the mass gap property of the supergravity picture.

The 0^{++} mass spectrum in the WKB approximation closely agrees with the more accurate numerical solution. It takes the form

$$M^2 \approx \frac{0.74n(n+2)}{R_0^2}, \quad n = 1, 2, 3, \dots \quad (6.55)$$

As in QCD_3 , the ratios of the glueball excited state masses with $n > 1$ in (6.55) and the lowest mass $n = 1$ state are in good agreement with the available lattice computations [685, 672].

As another example consider the 0^{-+} glueballs. The lowest dimension operator with these quantum numbers is $\text{Tr}(F\tilde{F})$. As we discussed previously, on the D4 brane worldvolume it couples to the RR 1-form \mathcal{A}_τ (6.46). Its equation of motion is given by (6.49). We look for solutions of the form $\mathcal{A}_\tau = f_\tau(u)e^{ikx}$. Plugging this into (6.49) we get

$$\frac{1}{u^5}(u^6 - u_0^6)\partial_u[u^7\partial_u f_\tau(u)] + u^4 M^2 f_\tau(u) = 0. \quad (6.56)$$

As for the 0^{++} glueball states, the ratios of the 0^{-+} glueball masses are found to be in good agreement with the lattice computations [685].

Finally, we note that the ratio of the lowest masses 0^{++} and 0^{-+} glueball states [685]

$$\begin{aligned} \left(\frac{M_{0^{-+}}}{M_{0^{++}}}\right)_{\text{supergravity}} &= 1.20, \\ \left(\frac{M_{0^{-+}}}{M_{0^{++}}}\right)_{\text{lattice}} &= 1.36 \pm 0.32, \end{aligned} \quad (6.57)$$

agrees with the lattice results too. Similar types of agreements in mass spectrum computations were claimed in strong coupling lattice QCD [686]. However, note that (as discussed above for QCD_3) other ratios, such as the ratio of the glueball masses to the square root of the string tension, are very different in the SUGRA limit from the results in QCD.

The computation of the mass gap in the dual supergravity picture is in the opposite limit to QCD. As in the supergravity description of QCD_3 , also here the Kaluza-Klein modes do not decouple. In this approach, in order to perform the computation in the QCD regime we need to use string theory. The surprising agreement of certain mass ratios with the lattice results may be a coincidence. Optimistically, it may have an underlying dynamical reason.

Confinement-Deconfinement Transition

We will now put the above four dimensional QCD-like theory at a finite temperature T (which should not be confused with $\frac{1}{2\pi R_0}$). We will see that there is a deconfinement transition. In order to consider the theory at finite temperature we go to Euclidean

space and we compactify the time direction t_E on a circle of radius β with antiperiodic fermion boundary conditions. Since we already had one circle (labeled by τ in (6.38)), we now have two circles with antiperiodic boundary conditions. So, we can have several possible gravity solutions. One is the original extremal D4 brane, another is the solution (6.38) and a third one is the same solution (6.38) but with τ and t_E interchanged. These last two solutions are possible only when the fermions have antiperiodic boundary conditions on the corresponding circles. One of the last two solutions always has lower free energy than the first, so we concentrate on these last two.

It turns out that the initial solution (6.38) has the lowest free energy for low temperatures, when $\beta = 1/T > 2\pi R_0$, while the one with $\tau \leftrightarrow t_E$ has the lowest free energy for $\beta = 1/T < 2\pi R_0$ (high temperatures). The entropy of these two solutions is very different, and therefore there is a first order phase transition, in complete analogy with the discussion in section 3.6. We do not know of a proof that there are no other solutions, but these two solutions have different topological properties, so there cannot be a smoothly interpolating solution. In any case, for very low and very high temperatures they are expected to be the dominant configurations (see [663])⁵. The entropy of the high temperature phase is of order N^2 , while the entropy of the low temperature phase is essentially zero since the number of states in the gravity picture is independent of the Newton constant.

If we compute the potential between a quark and an antiquark then in the low temperature phase it grows linearly, so that we have confinement, while in the high temperature phase the strings coming from the external quarks can end on the horizon, so that the potential vanishes beyond a certain separation. Thus, this is a confinement-deconfinement transition. It might seem a bit surprising at first sight that essentially the same solution can be interpreted as a confined and a deconfined phase at the same time. The point is that quark worldlines are timelike, therefore they select one of the two circles, and the physical properties depend crucially on whether this circle is contractible or not in the full ten-dimensional geometry.

Other Dynamical Aspects

In this subsection we comment on various aspects of QCD_4 as seen by the string description. We first show how the baryons appear in the dual string theory (M theory) picture. We will then compute other properties of the QCD vacuum, the topological susceptibility and the gluon condensate, as seen in the dual description.

Baryons

⁵There are other singular solutions [620], but the general philosophy is that we do not allow singular solutions unless we can give a physical interpretation for the singularity.

The baryon is an $SU(N)$ singlet bound state of N quarks. Since we do not have quarks in our theory, we need to put in external quarks as described in section 3.5, and then there is a baryon operator coupling N external quarks. As in the conformal case, also here it can be constructed as N open strings that end on a D4 brane that is wrapped on S^4 [293, 216], as in figure 6.11. If we view this geometry as arising from M-theory, then the strings are M2 branes wrapping the circle with periodic fermion boundary conditions and the D4 brane is an M5 fivebrane also wrapping this circle. Then, N M2 branes can end on this M5 brane as in [216]. There is a very similar picture of a baryon in strong coupling lattice QCD as is depicted in figure 6.12, where quarks are connected by flux links to a vertex.

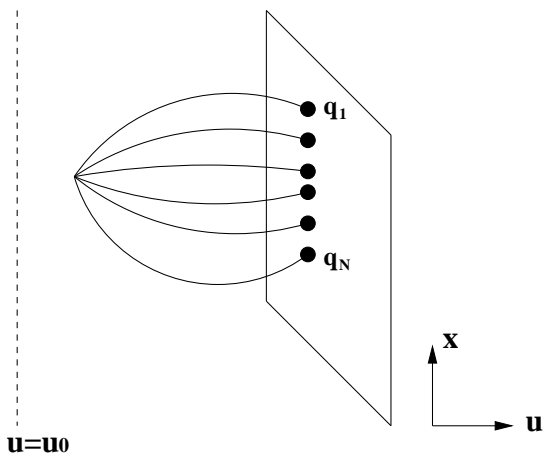

Figure 6.11: The baryon is an $SU(N)$ singlet bound state of N quarks. It is constructed as N open strings that join together at a point in the bulk AdS black hole geometry.

Several aspects of baryon physics can be seen from the string picture of figure 6.11 [216, 293]. The baryon energy is proportional to the string tension (6.41) and (in the limit of large distances between the quarks) to the sum of the distances between the N quark locations and the location of the baryon vertex in the four dimensional x -space [293, 392, 393]. (There is some subtlety in evaluating the baryon energy, and it was clarified in [394] in the case of $\mathcal{N} = 4$ gauge theory. See also [395, 399].) We may consider the baryon vertex as a fixed (non-dynamical) point in the Born Oppenheimer approximation. In such an approximation, the N quarks move independently in the potential due to the string stretched between them and the vertex. The baryon mass spectrum can be computed by solving the one body problem of the quark in this potential. Corrections to this spectrum can be computed by taking into account the potential between the quarks and the dynamics of the vertex. A similar analysis has been carried out in the flux tube model [687] based on the Hamiltonian strong coupling

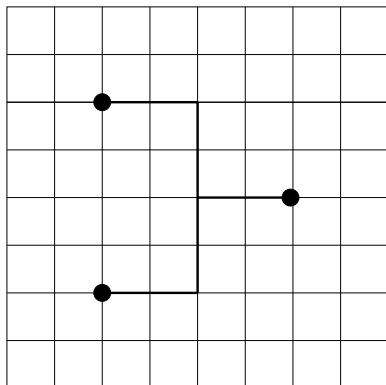

Figure 6.12: A baryon state in strong coupling lattice QCD. The quarks located at lattice sites are connected by flux links to a vertex. A similar picture is obtained by projecting the baryon vertex in figure 6.11 on x space.

lattice formulation [688].

In a confining theory we do not expect to see a baryonic configuration made from $k < N$ quarks. This follows for the above description. If we want to separate a quark we will be left with a string running to infinity, which has infinite energy.

Topological Susceptibility

The topological susceptibility χ_t measures the fluctuations of the topological charge of the QCD vacuum. It is defined by

$$\chi_t = \frac{1}{(16\pi^2)^2} \int d^4x \langle \text{Tr}(F\tilde{F}(x))\text{Tr}(F\tilde{F}(0)) \rangle . \quad (6.58)$$

At large N the Witten-Veneziano formula [689, 690] relates the mass $m_{\eta'}$ in $SU(N)$ Yang-Mills gauge theory with N_f quarks to the topological susceptibility of $SU(N)$ Yang-Mills theory without quarks:

$$m_{\eta'}^2 = \frac{4N_f}{f_\pi^2} \chi_t . \quad (6.59)$$

Equation (6.59) is applicable at large N where $f_\pi^2 \sim N$. In this limit $m_{\eta'}$ goes to zero and we have the $\eta' - \pi$ degeneracy.

Nevertheless, plugging the phenomenological values $N_f = 3$, $N = 3$, $m_{\eta'} \sim 1 \text{ GeV}$, $f_\pi \sim 0.1 \text{ GeV}$ in (6.59) leads to a prediction $\chi_t \sim (180 \text{ MeV})^4$, which is in surprising agreement with the lattice simulation for a finite number of colors [691].

Evaluating the 2-point function from the type IIA SUGRA action for the RR 1-form

(6.48) with the solution (6.50), we get the topological susceptibility

$$\chi_t = \frac{2\lambda^3}{729\pi^3 R_0^4} . \quad (6.60)$$

The supergravity result (6.60) depends on two parameters, λ and R_0 . This is the leading asymptotic behavior in $1/\lambda$ of the full string theory expression $\chi_t \sim (F(\lambda)/R_0)^4$. We would have liked to compute $F(\lambda)$, take the limit (6.53) and compare to the lattice QCD result. However, this goes beyond the currently available calculational tools.

It may be instructive, though, to consider the following comparison. Let us assume that there is a cross-over between the supergravity description and the continuum QCD description. We can estimate the cross-over point. In perturbative QCD we find $F(\lambda) \sim e^{-12\pi/11\lambda}$, therefore the cross-over point (to the $F \sim \lambda^{3/4}$ behavior of (6.60)) can be estimated to be at $\lambda \sim 12\pi/11$. Also, since the mass scale in the QCD regime is Λ_{QCD} , at the cross-over point $T = 1/2\pi R_0 \sim \Lambda_{QCD} \sim 200 \text{ MeV}$. Of course, we should bear in mind that at the cross-over point both the supergravity and perturbative QCD are not applicable descriptions. If we compare the topological susceptibility (6.60) at the correspondence point with the lattice result we get

$$\left(\frac{\chi_t^{\text{SUGRA}}}{\chi_t^{\text{Lattice}}} \right)^{1/4} = 1.7 . \quad (6.61)$$

It may be an encouraging sign that the number we get is of order one, though its level of agreement is not as good as the mass ratios of the glueball spectrum.

Gluon Condensation

The gluon condensate $\langle \frac{1}{4g_4^2} \text{Tr}(F^2(0)) \rangle$ is related by the trace anomaly to the energy density $T_{\mu\mu}$ of the QCD vacuum. In the supergravity picture the one point function of an operator corresponds to the first variation of the supergravity action. This quantity is expected to vanish by the equations of motion. However, the first variation is only required to vanish up to a total derivative term. Since asymptotically anti-de Sitter space has a time-like boundary at infinity, there is a possible boundary contribution. Indeed, unlike the $\mathcal{N} = 4$ case, the one point function of the $\text{Tr}(F^2)$ operator in the dual string theory description of QCD does not vanish.

It can be computed either directly or by using the relation between the thermal partition function and the free energy $Z(T) = \exp(-\mathcal{F}/T)$. This relates the free energy associated with the string theory (supergravity) background to the expectation value of the operator $\text{Tr}(F^2)$. One gets [685]

$$\langle \frac{1}{4g_4^2} \text{Tr}(F_{\mu\nu}^2(0)) \rangle = \frac{1}{8\pi} \frac{N^2}{\lambda} \sigma^2 . \quad (6.62)$$

The relation (6.62) between the gluon condensate and the string tension is rather general and applies for other regular backgrounds that are possible candidates for a dual description [692].

If we attempt again a numerical comparison with the lattice computation [693, 694] we find at the cross-over point

$$\left(\frac{(\text{Gluon condensate})^{\text{SUGRA}}}{(\text{Gluon condensate})^{\text{Lattice}}} \right)^{1/4} = 0.9 . \quad (6.63)$$

We should note that in field theory the gluon condensate is divergent, and there are subtleties (which are not completely settled) as to the relation between the lattice regularized result and the actual property of the QCD vacuum.

Finally, for completeness of the numerical status, we note that if we compare the string tension (6.41) at the cross-over point and the lattice result we get

$$\left(\frac{(\text{QCD string tension})^{\text{SUGRA}}}{(\text{QCD string tension})^{\text{Lattice}}} \right)^{1/2} = 2 . \quad (6.64)$$

6.2.3 Other Directions

In this subsection we briefly review other possible ways of describing non supersymmetric asymptotically free gauge theories via a dual string description. Additional possibilities are described in section 4.3.

Different Background Metrics

The string models dual to QCD_p that we studied exhibit the required qualitative properties, such as confinement, a mass gap and the θ dependence of the vacuum energy, already in the supergravity approximation. We noted that besides the glueball mass spectrum there exists a spectrum of Kaluza-Klein modes at the same mass scale. This indicates that the physics of the higher dimensions is not decoupling from the four dimensional physics⁶. The Kaluza-Klein states did not decouple upon the inclusion of the α'^3 correction, but one hopes that they do decouple in the full string theory framework. In the following we discuss an approach to removing some of them already at the supergravity level. It should be stressed, however, that this does not solve the issue of a possible mixing between the glueball states and states that correspond to the scalar and fermion fields, which for large λ are at the same mass scale in the field theory.

⁶From the field theory point of view it indicates that $SU(4)$ -charged fields and KK modes of five dimensional fields contribute in addition to the four dimensional gluons.

Again, the analogy with lattice gauge theory is useful. It is well known in the lattice framework that the action one starts with has a significant effect on the speed at which one gets to the continuum limit. One can add to the lattice action deformations which are irrelevant in the continuum limit and arrive at an appropriate effective description of the continuum theory while having a larger lattice spacing. Such actions are called improved actions.

A similar strategy in the dual supergravity description amounts to a modification of the background metric. The requirement is that the modification will better capture the effective description of the gauge theory while still having a finite cutoff (corresponding to finite λ in our case). On the lattice a criterion for improvement is Lorentz invariance. Here, since the cutoff is provided by a higher dimensional theory we have the full Lorentz invariance in any case. The improvement will be measured by the removal of the Kaluza-Klein modes. Note that we are attempting at an improvement in the strong coupling regime. Such ideas have only now begun to be explored on the lattice [695]. Till now, the effort of lattice computations was directed at the computation of the strong coupling expansion series.

Models that generalize the above background by the realization of the gauge theories on non-extremal rotating branes have been studied in [696, 692, 320]. The deformation of the background is parametrized by the angular momentum parameter. Kaluza-Klein modes associated with the circle have the form $\Phi = f(u)e^{ikx}e^{in\tau}$, $n > 0$. It has been shown that as one varies the angular momentum one decouples these Kaluza-Klein modes, while maintaining the stability of the glueball mass spectrum. This deformation is not sufficient to decouple also the Kaluza-Klein modes associated with the sphere part of the metrics (6.22) and (6.38), so we are still quite far from QCD.

The number of non-singular backgrounds is limited by the no hair theorem. One may consider more angular momenta, for instance. However, this does not seem to be sufficient to decouple all the Kaluza-Klein states [697, 698]. It is possible that we will need to appeal to non regular backgrounds in order to fully decouple the higher dimensional physics. Some non supersymmetric singular backgrounds of Type II supergravity that exhibit confinement were constructed and discussed in [421, 422, 423, 426].

Type 0 String Theory

The Type 0 string theories have worldsheet supersymmetry but no space-time supersymmetry as a consequence of a non-chiral GSO projection [699, 700]. Consider two types of such string theories, Type 0A and Type 0B. They do not have space-time fermions in their spectra. Nevertheless, they have a modular invariant partition function. The bosonic fields of these theories are like those of the supersymmetric Type

IIA and Type IIB string theories, with a doubled set of Ramond-Ramond fields. Type 0 string theories can be formally viewed as the high temperature limit of the Type II string theories. They contain a tachyon field \mathcal{T} .

Type 0 theories have D-branes. As in the Type II case, we can consider the gauge theories on the worldvolume of N such branes. These theories do not contain an open string tachyon. Moreover, the usual condensation of the tachyon could be avoided in the near horizon region as we explain below.

One particular example studied in [701] is the theory on N flat D3 branes in Type 0B theory. Since there is a doubled set of RR 4-form fields in Type 0B string theory, the D3 branes can carry two charges, electric and magnetic. The worldvolume theory of N flat electric D3 branes is a $U(N)$ gauge theory with six scalars in the adjoint representation of the gauge group. There are no fermionic fields. The classical action is derived by a dimensional reduction of the pure $SU(N)$ gauge theory action in ten dimensions. The six scalars are the components of the gauge fields in the reduced dimensions. The classical theory has an $SO(6)$ global symmetry that rotates the six scalars. This allows several possible parameters (from the point of view of renormalizable field theory) : a gauge coupling g_{YM} , a mass parameter for the scalars m and various scalar quartic potential couplings g_i , one of which appears in the classical Lagrangian. In the classical worldvolume action, the mass parameter is zero and the g_i are fixed in terms of g_{YM} , it is just the dimensional reduction of the ten dimensional bosonic Yang-Mills theory. Quantum mechanically, the parameters are corrected differently and can take independent values. The theory has a phase diagram depending on these parameters. Generically we expect to see in the diagram Coulomb-like (Higgs) phases, confinement phases and maybe non trivial RG fixed points arising from particular tunings of the parameters.

As in the case of D branes in Type II theories, one can conjecture here that the low-energy theory on the electric D3 branes has a dual non supersymmetric string description. At first sight this should involve a solution of $AdS_5 \times S^5$ type. The closed string tachyon might be allowed in AdS if the curvature is of the order of the string scale, since in that case the tachyon would obey the Breitenlohner-Freedman bound (2.42). The fact that the curvatures are of the order of the string scale renders the gravity analysis invalid. In principle we should solve the worldsheet string theory. Since we do not know how to do that at present we can just do a gravity analysis and hope that the full string theory analysis will give similar results. It was observed in [701] that the tachyon potential includes the terms

$$\frac{1}{2}m^2 e^{-2\Phi} \mathcal{T}^2 + |\mathcal{F}|^2 \left(1 + \mathcal{T} + \frac{\mathcal{T}^2}{2} \right), \quad (6.65)$$

where \mathcal{F} is the electric RR five form field strength (the magnetic one couples in a similar way but with $\mathcal{T} \rightarrow -\mathcal{T}$). The fact that the RR fields contribute positively to the mass

allows curvatures which, numerically, are a bit less than the string scale. Furthermore, it has been noticed in [702] that the first string correction to this background seems to vanish. These conditions on the curvature translate into the condition $g_s N < O(1)$ which is precisely what we expect to get in QCD.

An interesting feature is that, due to the potential (6.65) the tachyon would have a nonzero expectation value and that induces a variation of the dilaton field Φ in the radial coordinate via the equation [675, 702]

$$\nabla^2 \Phi = \frac{1}{8} m^2 e^{\Phi/2} \mathcal{T}^2, \quad m^2 = -\frac{2}{\alpha'}. \quad (6.66)$$

Since the radial coordinate is associated with the energy scale of the gauge theory, this variation may be interpreted as the flow of the coupling. In the UV (large radial coordinate) the tachyon is constant and one finds a metric of the form $AdS_5 \times S^5$. This indicates a UV fixed point. The coupling vanishes at the UV fixed point, and this makes the curvature of the gravity solution infinite in the UV, but that is precisely what is expected since the field theory is UV free. The running of the coupling is logarithmic, though it goes like $1/(\log E)^2$. However, the quark-antiquark potential goes as $1/\log E$ due to the square root in (3.95).

In the IR (small radial coordinate) the tachyon vanishes and one finds again a solution of the form $AdS_5 \times S^5$. In the IR the coupling is infinite. Therefore this solution seems to exhibit a strong coupling IR fixed point. However, since the dilaton is large, classical string theory is not sufficient to study the fixed point theory. The gravity solution at all energy scales u has not been constructed yet.

Generically one expects the gauge theory to have different phases parametrized by the possible couplings. The IR fixed point should occur as a particular tuning of the couplings. Indeed, other solutions at small radial coordinate were constructed in [703] that exhibit confinement and a mass gap. Moreover they were argued to be more generic than the IR fixed point solution.

It was pointed out in [704] that the theories on the D3 branes of Type 0B string theory are particular examples of the orbifold models of $\mathcal{N} = 4$ theory that we studied in section 4.1.1. The R-symmetry of $\mathcal{N} = 4$ theory is $SU(4)$, the spin cover of $SO(6)$. It has a center \mathbb{Z}_4 and one can orbifold with respect to it or its subgroups Γ . The theory on N flat electric D3 branes arises when the action of Γ on the Chan-Paton (color) indices is in a trivial representation. This orbifold is not in the class of “regular representations” which we discussed in section 4.1.1; in particular, in this case the beta function does not vanish in the planar diagram limit. If we study instead the theory arising on N self-dual D3-branes of type 0 (which may be viewed as bound states of electric and magnetic D3-branes) we find a theory which is in the class of “regular representation orbifolds” [705], and behaves similarly to type II D3-branes in the large N limit. We will not discuss this theory here.

As with the D branes in Type II string theory, we can construct a large number of non supersymmetric models in Type 0 theories by placing the D branes at singularities. One example is the theory of D3 branes of Type 0B string theory at a conifold singularity. As discussed in section 4.1.3, when placing N D3 branes of Type IIB string theory at a conifold the resulting low-energy worldvolume theory is $\mathcal{N} = 1$ supersymmetric $SU(N) \times SU(N)$ gauge theory with chiral superfields $A_k, k = 1, 2$ transforming in the (N, \bar{N}) representation and $B_l, l = 1, 2$ transforming in the (\bar{N}, N) representation, and with some superpotential.

On the worldvolume of N electric D3 branes of Type 0B string theory at a conifold there is a truncation of the fermions and one gets an $SU(N) \times SU(N)$ gauge theory with complex scalar fields $A_k, k = 1, 2$ transforming in the (N, \bar{N}) representation and $B_l, l = 1, 2$ transforming in the (\bar{N}, N) representation. This theory (at least if we set to zero the coefficient of the scalar potential which existed in the supersymmetric case) is asymptotically free. The gravity description of this model has been analyzed in [706]. In the UV one finds a solution of the form $AdS_5 \times T^{1,1}$ which indicates a UV fixed point. The effective string coupling vanishes in accord with the UV freedom of the gauge theory. In the IR one finds again a solution of the form $AdS_5 \times T^{1,1}$ with infinite coupling that points to a strong coupling IR fixed point. Of course, one expects the gauge theory to have different phases parametrized by the possible couplings. Indeed, there are other more generic solutions that exhibit confinement and a mass gap [706].

Other works on dual descriptions of gauge theories via the Type 0 D branes are [707, 708, 709, 710, 711, 712, 713].

Chapter 7

Summary and Discussion

We conclude by summarizing some of the successes and remaining open problems of the AdS/CFT correspondence.

From the field theory point of view we have learned and understood better many properties of the large N limit. Since 't Hooft's work [3] we knew that the large N limit of gauge theories should be described by strings, if the parameter $g_{YM}^2 N$ is kept fixed. Through the correspondence we have learned that not only does this picture really work (beyond perturbation theory where it was first derived), but that the Yang-Mills strings (made from gluons) are the same as the fundamental strings. Moreover, these strings move in higher dimensions, as was argued in [47]. These extra dimensions arise dynamically in the gauge theory. For some field theories the curvatures in the higher dimensional space could be small. The prototypical example is $\mathcal{N} = 4$ super-Yang-Mills with large N , $g_{YM}^2 N$. From this example we can obtain others by taking quotients, placing branes at various singularities, etc. (section 4.1). In all cases for which we can find a low-curvature gravity description we can do numerous calculations in the large N limit. We can calculate the spectrum of operators and states (sections 3.2, 3.4). We can calculate correlation functions of operators and of Wilson loops (sections 3.3, 3.5). We can calculate thermal properties, like the equation of state (section 3.6), and so on.

If the field theory is conformal the gravity solution will include an *AdS* factor. It is possible, in principle, to deform the theory by any relevant operators. In some cases fairly explicit solutions have been found for flows between different conformal field theories (section 4.3). A “*c*-theorem” for field theories in more than two dimensions was proven within the gravity approximation. It would be very interesting to generalize this beyond this approximation. It would also be interesting to understand better exactly what it is the class of field theories which have a gravity approximation. One constraint on such four dimensional conformal field theories, described in section 3.2.2, is that they must have $a = c$.

It is possible to give a field theory interpretation to various branes that one can have in the AdS description (section 4.2). Some correspond to baryons in the field theory, others to various defects like domain walls, etc. In the AdS_5 case D-instantons in the string theory correspond to gauge theory instantons in the field theory.

In general, the large N limit of a gauge theory should have a string theory description. Whether it also has a gravity description depends on how large the curvatures in this string theory are. If the curvatures are small, we can have an approximate classical gravity description. Otherwise, we should consider all string modes on the same footing. This involves solving the worldsheet theories for strings in Ramond-Ramond backgrounds. This is a problem that only now is beginning to be elucidated [525, 714, 715, 716, 717, 718, 719, 720, 721]. For non-supersymmetric QCD, or other theories which are weakly coupled (as QCD is at high energies), we expect to have curvatures at least of the order of the string scale, so that a proper understanding of strings on highly curved spaces seems crucial.

It is also possible to deform the $\mathcal{N} = 4$ field theory, breaking supersymmetry and conformal invariance, by giving a mass to the fermions or by compactifying the theory on a circle with supersymmetry breaking boundary conditions. Then, we have a theory that should describe pure Yang-Mills theory at low energies (sections 4.3, 3.6, 6.2). In the case of field theories compactified on a circle with supersymmetry breaking boundary conditions and large $g_{YM}^2 N$ at the compactification scale, one can show that the theory is confining, has a mass gap, has θ -vacua with the right qualitative properties and has a confinement-deconfinement transition at finite temperature. However, in the regime where the analysis can be done (small curvature) this theory includes many additional degrees of freedom beyond those in the standard bosonic Yang-Mills theory. In order to do quantitative calculations in bosonic Yang-Mills one would have to do calculations when the curvatures are large, which goes beyond the gravity approximation and requires understanding the propagation of strings in Ramond-Ramond backgrounds. Unfortunately, this is proving to be very difficult, and so far we have not obtained new results in QCD from the correspondence. As discussed in section 6.2, the gravity approximation resembles the strong coupling lattice QCD description [664], where the α' expansion of string theory corresponds to the strong coupling expansion. The gravity description has an advantage over the strong coupling lattice QCD description by being fully Lorentz invariant. This allows, for instance, the analysis of topological properties of the vacuum which is a difficult task in the lattice description. The AdS/CFT correspondence does provide direct evidence that QCD is describable as some sort of string theory (to the extent that we can use the name string theory for strings propagating on spaces whose radius of curvature is of the order of the string scale or smaller).

One of the surprising things we learned about field theory is that there are various

new large N limits which had not been considered before. For instance, we can take $N \rightarrow \infty$ keeping g_{YM} fixed, and the AdS/CFT correspondence implies that many properties of the field theory (like correlation functions of chiral primary operators) have a reasonable limiting behavior in this limit, though there is no good field theory argument for this. Similarly, we find that there exist large N limits for theories which are not gauge theories, like the $d = 3, \mathcal{N} = 8$ and $d = 6, \mathcal{N} = (2, 0)$ superconformal field theories, and for various theories with less supersymmetry. The existence of these limits cannot be derived directly in field theory.

The correspondence has also been used to learn about the properties of field theories which were previously only poorly understood. For instance, it has been used [343] to understand properties of two dimensional field theories with singular target spaces, and to learn properties of “little string theories”, like the fact that they have a Hagedorn behavior at high energies. The correspondence has also been used to construct many new conformal field theories, both in the large N limit and at finite N .

Another interesting case is topological Chern-Simons theory in three dimensions, which is related to a topological string theory in six dimensions [329]. In this case one can solve exactly both sides of the correspondence and see explicitly that it works.

The correspondence is also useful for studying non-conformal gauge theories, as we discussed in section 6.1.3. A particularly interesting case is the maximally supersymmetric quantum mechanical $SU(N)$ gauge theory, which is related to Matrix theory [26, 722, 723, 647, 724, 725, 726, 727, 728, 729, 730].

From the quantum gravity point of view we have now an explicit holographic description for gravity in many backgrounds involving an asymptotically AdS space. The field theory effectively sums over all geometries which are asymptotic to AdS . This defines the theory non-perturbatively. This also implies that gravity in these spaces is unitary, giving the first explicit non-perturbative construction of a unitary theory of quantum gravity,¹ albeit in a curved space background. Black holes are some mixed states in the field theory Hilbert space. Explicit microscopic calculations of black hole entropy and greybody factors can be done in the AdS_3 case (chapter 5).

Basic properties of quantum gravity, such as approximate causality and locality at low energies, are far from clear in this description [181, 279, 171, 179, 177, 731, 182], and it would be interesting to understand them better. We are also still far from having a precise mapping between general configurations in the gravitational theory and in the field theory (see [732, 178] for some attempts to go in this direction).

In principle one can extract the physics of quantum gravity in flat space by taking the large radius limit of physics in AdS space. Since we have not discussed this yet

¹In the context of Matrix theory [26] we need to take a large N limit which is not well understood in order to describe a theory of gravity in a space with no closed light-like curves.

in the review, let us expand on this here, following [733, 734, 180, 735] (see also [178, 736, 737, 738]). We would like to be able to describe processes in flat space which occur, for instance, at some fixed string coupling, with the energies and the size of the interaction region kept fixed in string (or Planck) units. Computations on AdS space are necessarily done with some finite radius of curvature; however, we can view this radius of curvature as a regulator, and take it to infinity at the end of any calculation, in such a way that the local physics remains the same. Let us discuss what this means for the $AdS_5 \times S^5$ case (the discussion is similar for other cases). We need to keep the string coupling fixed, and take $N \rightarrow \infty$ since the radius of curvature in Planck units is proportional to $N^{1/4}$. Note that this is different from the 't Hooft limit, and involves taking $\lambda \rightarrow \infty$. In order to describe a scattering process in space-time which has finite energies in this limit, it turns out that the energies in the field theory must scale as $N^{1/4}$ (measured in units of the scale of the S^3 which the field theory is compactified on; we need to work in global AdS coordinates to describe flat-space scattering). In this limit the field theory is very strongly coupled and the energies are also very high, and there are no known ways to do any computations on the field theory side. It would be interesting to compute anything explicitly in this limit. For example, it would be interesting to compute the entropy of a small Schwarzschild black hole, much smaller than the radius of AdS , to see flat-space Hawking radiation, and so on. If we start with $AdS_5 \times S^5$ this limit gives us the physics in flat ten dimensional space, and similarly starting with $AdS_4 \times S^7$ or $AdS_7 \times S^4$ we can get the physics in flat eleven dimensional space. It would be interesting to understand how the correspondence can be used to learn about theories with lower dimension, where some of the dimensions are compactified. A limit of string theory on $AdS_3 \times S^3 \times M^4$ may be used to give string theory on $\mathbb{R}^{5,1} \times M^4$, but it is not clear how to get four dimensional physics out of the correspondence.

One could, in principle, get four dimensional flat space by starting from $AdS_2 \times S^2$ compactifications. However, the correspondence in the case of AdS_2 spaces is not well understood. AdS_2 spaces arise as the near horizon geometry of extremal charged Reissner-Nordstrom black holes. Even though fields propagating in AdS_2 behave similarly to the higher dimensional cases [739], the problem is that any finite energy excitation seems to destroy the AdS_2 boundary conditions [342]. This is related to the fact that black holes (as opposed to black p -branes, $p > 0$) have an energy gap (see section 5.7), so that in the extreme low energy limit we seem to have no excitations. One possibility is that the correspondence works only for the ground states. Even then, there are instantons that can lead to a fragmentation of the spacetime into several pieces [740]. Some conformal quantum mechanics systems that are, or could be, related to AdS_2 were studied in [741, 742, 743, 729]. Aspects of Hawking radiation in AdS_2 were studied in [744].

In all the known cases of the correspondence the gravity solution has a timelike boundary². It would be interesting to understand how the correspondence works when the boundary is light-like, as in Minkowski space. It seems that holography must work quite differently in these cases (see [745, 746] for discussions of some of the issues involved). In the cases we understand, the asymptotic space close to the boundary has a well defined notion of time, which is the one that is associated to the gauge theory. It would be interesting to understand how holography works in other spacetimes, where we do not have this notion of time. Interesting examples are spatially closed universes, expanding universes, de-Sitter spacetimes, etc. See [747, 748, 749, 750] for some attempts in this direction. The precise meaning of holography in the cosmological context is still not clear [751, 752, 753, 754, 755, 756, 757].

To summarize, the past 18 months have seen much progress in our understanding of string/M theory compactifications on AdS and related spaces, and in our understanding of large N field theories. However, the correspondence is still far from realizing the hopes that it initially raised, and much work still remains to be done. The correspondence gives us implicit ways to describe QCD and related interesting field theories in a dual “stringy” description, but so far we are unable to do any explicit computations in the field theories that we are really interested in. The main hope for progress in this direction lies in a better understanding of string theory in RR backgrounds. The correspondence also gives us an explicit example of a unitary and holographic theory of quantum gravity. We hope this example can be used to better understand quantum gravity in flat space, where the issues of unitarity (the “information problem”) and holography are still quite obscure. Even better, one could hope that the correspondence would hint at a way to formulate string/M theory independently of the background. These questions will apparently have to wait until the next millennium.

Acknowledgements

We would like to thank T. Banks, M. Berkooz, A. Brandhuber, M. Douglas, D. Freedman, S. Giddings, D. Gross, G. Horowitz, K. Jansen, S. Kachru, D. Kutasov, E. Martinec, G. Moore, A. Rajaraman, N. Seiberg, E. Silverstein, L. Susskind, and E. Witten for many useful discussions. The research of O.A. was supported in part by DOE grant DE-FG02-96ER40559. O.A., J.M. and Y.O. would like to thank the Institute for Advanced Studies at the Hebrew University of Jerusalem for hospitality during part of this work. J.M. wants to thank the hospitality of the Institute for Advanced Study at Princeton, where he was a Raymond and Beverly Sackler Fellow. The research of J.M. was supported in part by DOE grant DE-FGO2-91ER40654, NSF grant PHY-9513835,

²This is not precisely true in the linear dilaton backgrounds described in section 6.1.4 [215].

the Sloan Foundation and the David and Lucile Packard Foundations. The research of S.S.G. was supported by the Harvard Society of Fellows, and also in part by the NSF under grant number PHY-98-02709, and by DOE grant DE-FGO2-91ER40654. S.S.G. also thanks the Institute for Theoretical Physics at Santa Barbara for hospitality. The research of H.O. was supported in part by National Science Foundation under Contract PHY-95-14797 and in part by the Director, Office of Science, Office of High Energy and Nuclear Physics, Division of High Energy Physics, of the U.S. Department of Energy under Contract DE-AC03-76SF00098.

Bibliography

- [1] M. B. Green, J. H. Schwarz, and E. Witten, “Superstring Theory,”. Cambridge University Press (1987).
- [2] J. Polchinski, “String Theory,”. Cambridge University Press (1998).
- [3] G. 't Hooft, “A Planar Diagram Theory for Strong Interactions,” *Nucl. Phys.* **B72** (1974) 461.
- [4] A. M. Polyakov, “Quantum Geometry of Bosonic Strings,” *Phys. Lett.* **103B** (1981) 207.
- [5] J. Maldacena, “The Large N limit of superconformal field theories and supergravity,” *Adv. Theor. Math. Phys.* **2** (1998) 231, [hep-th/9711200](#).
- [6] J. Polchinski, “Dirichlet Branes and Ramond-Ramond charges,” *Phys. Rev. Lett.* **75** (1995) 4724–4727, [hep-th/9510017](#).
- [7] G. 't Hooft, “Magnetic monopoles in unified gauge theories,” *Nucl. Phys.* **B79** (1974) 276–284.
- [8] A. M. Polyakov, “Particle spectrum in the quantum field theory,” *JETP Lett.* **20** (1974) 194–195.
- [9] E. Witten, “Bound States of Strings and p-Branes,” *Nucl. Phys.* **B460** (1996) 335–350, [hep-th/9510135](#).
- [10] I. R. Klebanov, “World volume approach to absorption by nondilatonic branes,” *Nucl. Phys.* **B496** (1997) 231, [hep-th/9702076](#).
- [11] S. S. Gubser, I. R. Klebanov, and A. A. Tseytlin, “String theory and classical absorption by three-branes,” *Nucl. Phys.* **B499** (1997) 217, [hep-th/9703040](#).
- [12] S. S. Gubser and I. R. Klebanov, “Absorption by branes and Schwinger terms in the world volume theory,” *Phys. Lett.* **B413** (1997) 41–48, [hep-th/9708005](#).
- [13] A. Strominger and C. Vafa, “Microscopic origin of the Bekenstein-Hawking entropy,” *Phys. Lett.* **B379** (1996) 99–104, [hep-th/9601029](#).
- [14] C. G. Callan and J. M. Maldacena, “D-Brane Approach to Black Hole Quantum Mechanics,” *Nucl. Phys.* **B472** (1996) 591–610, [hep-th/9602043](#).
- [15] G. T. Horowitz and A. Strominger, “Counting States of Near Extremal Black Holes,” *Phys. Rev. Lett.* **77** (1996) 2368–2371, [hep-th/9602051](#).
- [16] S. R. Das and S. D. Mathur, “Comparing decay rates for black holes and D-branes,” *Nucl. Phys.* **B478** (1996) 561–576, [hep-th/9606185](#).
- [17] A. Dhar, G. Mandal, and S. R. Wadia, “Absorption vs. decay of black holes in string theory and T symmetry,” *Phys. Lett.* **B388** (1996) 51–59, [hep-th/9605234](#).
- [18] J. Maldacena and A. Strominger, “Black hole grey body factors and d-brane spectroscopy,” *Phys. Rev.* **D55** (1997) 861–870, [hep-th/9609026](#).
- [19] S. S. Gubser, I. R. Klebanov, and A. M. Polyakov, “Gauge theory correlators from noncritical string theory,” *Phys. Lett.* **B428** (1998) 105, [hep-th/9802109](#).

- [20] E. Witten, “Anti-de Sitter space and holography,” *Adv. Theor. Math. Phys.* **2** (1998) 253, [hep-th/9802150](#).
- [21] A. Salam and E. Sezgin, eds., *Supergravities in Diverse Dimensions*, vol. 1 and 2. North-Holland, Amsterdam, Netherlands, 1989.
- [22] M. J. Duff, B. E. W. Nilsson, and C. N. Pope, “Kaluza-Klein Supergravity,” *Phys. Rept.* **130** (1986) 1.
- [23] H. J. Boonstra, B. Peeters, and K. Skenderis, “Duality and asymptotic geometries,” *Phys. Lett.* **B411** (1997) 59, [hep-th/9706192](#).
- [24] K. Sfetsos and K. Skenderis, “Microscopic derivation of the Bekenstein-Hawking entropy formula for nonextremal black holes,” *Nucl. Phys.* **B517** (1998) 179–204, [hep-th/9711138](#).
- [25] E. Witten, “Quantum Field Theory and the Jones Polynomial,” *Commun. Math. Phys.* **121** (1989) 351.
- [26] T. Banks, W. Fischler, S. H. Shenker, and L. Susskind, “M Theory as a Matrix Model: A Conjecture,” *Phys. Rev.* **D55** (1997) 5112–5128, [hep-th/9610043](#).
- [27] G. 't Hooft, “Dimensional Reduction in Quantum Gravity,” [gr-qc/9310026](#).
- [28] L. Susskind, “The World as a hologram,” *J. Math. Phys.* **36** (1995) 6377–6396, [hep-th/9409089](#).
- [29] J. D. Bekenstein, “Entropy Bounds and Black Hole Remnants,” *Phys. Rev.* **D49** (1994) 1912–1921, [gr-qc/9307035](#).
- [30] P. D. Vecchia, “An Introduction to AdS/CFT correspondence,” [hep-th/9903007](#).
- [31] M. R. Douglas and S. Randjbar-Daemi, “Two lectures on the AdS / CFT correspondence,” [hep-th/9902022](#).
- [32] J. L. Petersen, “Introduction to the Maldacena conjecture on AdS / CFT,” [hep-th/9902131](#).
- [33] I. R. Klebanov, “From three-branes to large N gauge theories,” [hep-th/9901018](#).
- [34] S. Coleman, “1/N,”. Proceedings of Int. School of Subnuclear Physics, Pointlike Structures Inside and Outside Hadrons, Erice, Italy, Jul 31-Aug 10, 1979.
- [35] A. V. Manohar, “Large N QCD,” [hep-ph/9802419](#).
- [36] A. A. Migdal, “Multicolor QCD as dual resonance theory,” *Ann. Phys.* **109** (1977) 365.
- [37] G. M. Cicuta, “Topological Expansion for $SO(N)$ and $Sp(2N)$ Gauge Theories,” *Nuovo Cim. Lett.* **35** (1982) 87.
- [38] D. J. Gross, “Two-dimensional QCD as a string theory,” *Nucl. Phys.* **B400** (1993) 161–180, [hep-th/9212149](#).
- [39] D. J. Gross and W. Taylor, “Two-dimensional QCD is a string theory,” *Nucl. Phys.* **B400** (1993) 181–210, [hep-th/9301068](#).
- [40] J. A. Minahan, “Summing over inequivalent maps in the string theory interpretation of two-dimensional QCD,” *Phys. Rev.* **D47** (1993) 3430–3436, [hep-th/9301003](#).
- [41] D. J. Gross and W. Taylor, “Twists and Wilson loops in the string theory of two-dimensional QCD,” *Nucl. Phys.* **B403** (1993) 395–452, [hep-th/9303046](#).
- [42] S. G. Naculich, H. A. Riggs, and H. J. Schnitzer, “Two-dimensional Yang-Mills theories are string theories,” *Mod. Phys. Lett.* **A8** (1993) 2223–2236, [hep-th/9305097](#).
- [43] S. Ramgoolam, “Comment on two-dimensional $O(N)$ and $Sp(N)$ Yang-Mills theories as string theories,” *Nucl. Phys.* **B418** (1994) 30, [hep-th/9307085](#).
- [44] S. Cordes, G. Moore, and S. Ramgoolam, “Large N 2-D Yang-Mills Theory and Topological String Theory,” *Commun. Math. Phys.* **185** (1997) 543, [hep-th/9402107](#).

- [45] P. Horava, “On QCD string theory and AdS dynamics,” *JHEP* **01** (1999) 016, [hep-th/9811028](#).
- [46] Y. M. Makeenko and A. A. Migdal, “Exact equation for the loop average in multicolor QCD,” *Phys. Lett.* **88B** (1979) 135.
- [47] A. M. Polyakov, “String theory and quark confinement,” *Nucl. Phys. Proc. Suppl.* **68** (1998) 1, [hep-th/9711002](#).
- [48] A. M. Polyakov, “The Wall of the Cave,” [hep-th/9809057](#).
- [49] G. W. Gibbons, “Antigravitating Black Hole Solutions with Scalar Hair in $N = 4$ Supergravity,” *Nucl. Phys.* **B207** (1982) 337.
- [50] G. W. Gibbons and K. Maeda, “Black Holes and Membranes in Higher Dimensional Theories with Dilaton Fields,” *Nucl. Phys.* **B298** (1988) 741.
- [51] C. G. Callan, R. C. Myers, and M. J. Perry, “Black Holes in String Theory,” *Nucl. Phys.* **B311** (1989) 673.
- [52] A. Dabholkar and J. A. Harvey, “Nonrenormalization of String Tension,” *Phys. Rev. Lett.* **63** (1989) 478.
- [53] A. Dabholkar, G. Gibbons, J. A. Harvey, and F. R. Ruiz, “Superstrings and Solitons,” *Nucl. Phys.* **B340** (1990) 33–55.
- [54] M. J. Duff and J. X. Lu, “Elementary five-brane solutions of $D = 10$ supergravity,” *Nucl. Phys.* **B354** (1991) 141–153.
- [55] D. Garfinkle, G. T. Horowitz, and A. Strominger, “Charged black holes in string theory,” *Phys. Rev.* **D43** (1991) 3140–3143.
- [56] C. G. Callan, J. A. Harvey, and A. Strominger, “Worldsheet Approach to Heterotic Instantons and Solitons,” *Nucl. Phys.* **B359** (1991) 611.
- [57] C. G. Callan, J. A. Harvey, and A. Strominger, “Worldbrane Actions for String Solitons,” *Nucl. Phys.* **B367** (1991) 60–82.
- [58] G. T. Horowitz and A. Strominger, “Black strings and P-branes,” *Nucl. Phys.* **B360** (1991) 197–209.
- [59] M. J. Duff, R. R. Khuri, and J. X. Lu, “String and five-brane solitons: Singular or nonsingular?,” *Nucl. Phys.* **B377** (1992) 281–294, [hep-th/9112023](#).
- [60] M. J. Duff, “Supermembranes,” [hep-th/9611203](#).
- [61] A. W. Peet, “The Bekenstein formula and string theory (N-brane theory),” *Class. Quant. Grav.* **15** (1998) 3291, [hep-th/9712253](#).
- [62] G. W. Gibbons, G. T. Horowitz, and P. K. Townsend, “Higher dimensional resolution of dilatonic black hole singularities,” *Class. Quant. Grav.* **12** (1995) 297–318, [hep-th/9410073](#).
- [63] J. Polchinski, “TASI Lectures on D-Branes,” [hep-th/9611050](#).
- [64] S. W. Hawking, “Particle Creation by Black Holes,” *Commun. Math. Phys.* **43** (1975) 199.
- [65] J. F. Futterman, F. Handler, and R. Matzner, *Scattering from Black Holes*. Cambridge University Press, Cambridge, UK, 1988.
- [66] S. S. Gubser, “Can the effective string see higher partial waves?,” *Phys. Rev.* **D56** (1997) 4984–4993, [hep-th/9704195](#).
- [67] S. R. Das, G. Gibbons, and S. D. Mathur, “Universality of low-energy absorption cross-sections for black holes,” *Phys. Rev. Lett.* **78** (1997) 417–419, [hep-th/9609052](#).
- [68] S. S. Gubser and A. Hashimoto, “Exact absorption probabilities for the D3-brane,” [hep-th/9805140](#).
- [69] W. G. Unruh, “Absorption Cross-Section of Small Black Holes,” *Phys. Rev.* **D14** (1976) 3251.

- [70] S. S. Gubser and A. Hashimoto, unpublished.
- [71] M. Cvetič, H. Lu, C. N. Pope, and T. A. Tran, “Exact absorption probability in the extremal six-dimensional dyonic string background,” [hep-th/9901002](#).
- [72] S. S. Gubser, A. Hashimoto, I. R. Klebanov, and M. Krasnitz, “Scalar absorption and the breaking of the world volume conformal invariance,” *Nucl. Phys.* **B526** (1998) 393, [hep-th/9803023](#).
- [73] M. Taylor-Robinson, “The D1-brane D5-brane system in six-dimensions,” [hep-th/9806132](#).
- [74] J. Erdmenger and H. Osborn, “Conserved currents and the energy momentum tensor in conformally invariant theories for general dimensions,” *Nucl. Phys.* **B483** (1997) 431–474, [hep-th/9605009](#).
- [75] S. L. Adler and W. A. Bardeen, “Absence of higher order corrections in the anomalous axial vector divergence equation,” *Phys. Rev.* **182** (1969) 1517–1536.
- [76] S. Coleman and J. Mandula, “All Possible Symmetries of the S Matrix,” *Phys. Rev.* **159** (1967) 1251.
- [77] A. B. Zamolodchikov, “Irreversibility of the flux of the renormalization group in a 2d field theory,” *JETP Lett.* **43** (1986) 730–732.
- [78] J. Polchinski, “Scale and conformal invariance in quantum field theory,” *Nucl. Phys.* **B303** (1988) 226.
- [79] G. Mack, “Introduction to conformal invariant quantum field theory in two dimensions and more dimensions,” Presented at NATO Advanced Summer Inst. on Nonperturbative Quantum Field Theory (Cargese Summer Inst.), Cargese, France, Jul 16-30, 1987.
- [80] E. S. Fradkin and M. Y. Palchik, “Conformal quantum field theory in D-dimensions,” Dordrecht, Netherlands: Kluwer (1996) 461 p. (Mathematics and its applications. 376).
- [81] E. S. Fradkin and M. Y. Palchik, “New developments in D-dimensional conformal quantum field theory,” *Phys. Rept.* **300** (1998) 1.
- [82] G. Mack and A. Salam, “Finite component field representations of the conformal group,” *Ann. Phys.* **53** (1969) 174–202.
- [83] M. Gunaydin and C. Saclioglu, “Oscillator like unitary representations of noncompact groups with a Jordan structure and the noncompact groups of supergravity,” *Commun. Math. Phys.* **87** (1982) 159.
- [84] I. Bars and M. Gunaydin, “Unitary Representations of Noncompact Supergroups,” *Commun. Math. Phys.* **91** (1983) 31.
- [85] M. Gunaydin and N. Marcus, “The Spectrum of the S^5 Compactification of the Chiral $N = 2, D = 10$ Supergravity and the Unitary Supermultiplets of $U(2, 2/4)$,” *Class. Quant. Grav.* **2** (1985) L11.
- [86] M. Gunaydin and N. Marcus, “The unitary supermultiplet of $N = 8$ conformal superalgebra involving fields of spin ≤ 2 ,” *Class. Quant. Grav.* **2** (1985) L19.
- [87] M. Gunaydin, P. van Nieuwenhuizen, and N. P. Warner, “General construction of the unitary representations of anti-de Sitter superalgebras and the spectrum of the S^4 compactification of eleven dimensional supergravity,” *Nucl. Phys.* **B255** (1985) 63.
- [88] M. Gunaydin and N. P. Warner, “Unitary supermultiplets of $OSp(8|4, \mathbb{R})$ and the spectrum of the S^7 compactification of eleven dimensional supergravity,” *Nucl. Phys.* **B272** (1986) 99.
- [89] M. Gunaydin, “Unitary highest weight representations of noncompact supergroups,” *J. Math. Phys.* **29** (1988) 1275.
- [90] D. Minic, “Kinematics of AdS_5 / CFT_4 duality,” [hep-th/9903079](#).
- [91] M. Luscher and G. Mack, “Global conformal invariance and quantum field theory,” *Comm. Math. Phys.* **41** (1975) 203.

- [92] W. Nahm, “Supersymmetries and their representations,” *Nucl. Phys.* **B135** (1978) 149.
- [93] N. Seiberg, “Notes on theories with 16 supercharges,” *Nucl. Phys. Proc. Suppl.* **67** (1998) 158, [hep-th/9705117](#).
- [94] V. G. Kac, “Representations of classical Lie superalgebras,”. Proceedings, Differential Geometrical Methods In Mathematical Physics.Ii., Berlin 1977, 597-626.
- [95] V. K. Dobrev and V. B. Petkova, “Group theoretical approach to extended conformal supersymmetry: function space realizations and invariant differential operators,” *Fortschr. Phys.* **35** (1987) 537.
- [96] V. K. Dobrev and V. B. Petkova, “All positive energy unitary irreducible representations of extended conformal supersymmetry,” *Phys. Lett.* **162B** (1985) 127.
- [97] S. Minwalla, “Restrictions imposed by superconformal invariance on quantum field theories,” *Adv. Theor. Math. Phys.* **2** (1998) 781–846, [hep-th/9712074](#).
- [98] S. J. Avis, C. J. Isham, and D. Storey, “Quantum Field Theory in Anti-de Sitter Spacetime,” *Phys. Rev.* **D18** (1978) 3565.
- [99] C. Burgess and C. Lutken, “Propagators and Effective Potentials in Anti-de Sitter Space,” *Phys. Lett.* **1153B** (1985) 137.
- [100] T. Inami and H. Ooguri, “One Loop Effective Potential in Anti-de Sitter Space,” *Prog. Theor. Phys.* **73** (1985) 1051.
- [101] P. Breitenlohner and D. Z. Freedman, “Positive Energy in Anti-De Sitter Backgrounds and Gauged Extended Supergravity,” *Phys. Lett.* **115B** (1982) 197.
- [102] P. Breitenlohner and D. Z. Freedman, “Stability in Gauged Extended Supergravity,” *Ann. Phys.* **144** (1982) 249.
- [103] S. W. Hawking, “The Boundary Condition for Gauged Supergravity,” *Phys. Lett.* **126B** (1983) 175.
- [104] L. Mezincescu and P. K. Townsend, “Positive Energy and the Scalar Potential in Higher Dimensional (Super) Gravity Theories,” *Phys. Lett.* **148B** (1984) 55.
- [105] W. Heidenreich, “All Liner Unitary Irreducible Representations of de Sitter Supersymmetry with Positive Energy,” *Phys. Lett.* **110B** (1982) 461.
- [106] P. K. Townsend, “Cosmological Constant in Supergravity,” *Phys. Rev.* **D15** (1977) 2802.
- [107] L. Mezincescu and P. K. Townsend, “Stability at a Local Maximum in Higher Dimensional Anti-de Sitter Space and Applications to Supergravity,” *Ann. Phys.* **160** (1985) 406.
- [108] G. W. Gibbons, C. M. Hull, and N. P. Warner, “The Stability of Gauged Supergravity,” *Nucl. Phys.* **B218** (1983) 173.
- [109] E. Witten, “A Simple Proof of Positive Energy Theorem,” *Commun. Math. Phys.* **80** (1981) 381.
- [110] R. Schoen and S.-T. Yau, “Proof of the Positive Mass Theorem II,” *Commun. Math. Phys.* **79** (1981) 231.
- [111] V. G. Kac, “Lie superalgebras,” *Adv. Math.* **26** (1977) 8.
- [112] M. Pernici, K. Pilch, and P. van Nieuwenhuizen, “Gauged Maximally Extended Supergravity in Seven Dimensions,” *Phys. Lett.* **143B** (1984) 103.
- [113] P. G. O. Freund and M. A. Rubin, “Dynamics of dimensional reduction,” *Phys. Lett.* **97B** (1980) 233.
- [114] H. Nastase, D. Vaman, and P. van Nieuwenhuizen, “Consistent nonlinear KK reduction of 11d supergravity on $AdS_7 \times S_4$ and self-duality in odd dimensions,” [hep-th/9905075](#).
- [115] M. Pernici, K. Pilch, P. van Nieuwenhuizen, and N. P. Warner, “Noncompact Gauging and Critical Points of Maximal Supergravity in Seven Dimensions,” *Nucl. Phys.* **B249** (1985) 381.

- [116] P. K. Townsend and P. van Nieuwenhuizen, “Gauged Seven-Dimensional Supergravity,” *Phys. Lett.* **125B** (1983) 41.
- [117] B. S. DeWitt and P. van Nieuwenhuizen, “Explicit Construction of the Exceptional Superalgebras $F(4)$ and $G(3)$,” *J. Math. Phys.* **23** (1982) 1953.
- [118] L. J. Romans, “The $F(4)$ Gauged Supergravity in Six Dimensions,” *Nucl. Phys.* **B269** (1986) 691.
- [119] S. Ferrara, A. Kehagias, H. Partouche, and A. Zaffaroni, “AdS₆ interpretation of 5-D superconformal field theories,” *Phys. Lett.* **B431** (1998) 57–62, [hep-th/9804006](#).
- [120] A. Brandhuber and Y. Oz, “The D4-D8 Brane System and Five Dimensional Fixed Points,” [hep-th/9905148](#).
- [121] P. van Nieuwenhuizen and N. P. Warner, “New compactifications of ten-dimensional and eleven-dimensional supergravity on manifolds which are not direct products,” *Commun. Math. Phys.* **99** (1985) 141.
- [122] P. van Nieuwenhuizen, Les Houches 1983 Lectures, B. de Witt and R. Stora eds., North-Holland.
- [123] M. Pernici, K. Pilch, and P. van Nieuwenhuizen, “Gauged $N = 8, D = 5$ Supergravity,” *Nucl. Phys.* **B259** (1985) 460.
- [124] M. Gunaydin, L. J. Romans, and N. P. Warner, “Compact and Noncompact Gauged Supergravity Theories in Five Dimensions,” *Nucl. Phys.* **B272** (1986) 598.
- [125] J. H. Schwarz, “Covariant Field Equations of Chiral $N = 2, D = 10$ Supergravity,” *Nucl. Phys.* **B226** (1983) 269.
- [126] H. J. Kim, L. J. Romans, and P. van Nieuwenhuizen, “The mass spectrum of chiral $\mathcal{N} = 2$ $d = 10$ supergravity on S^5 ,” *Phys. Rev.* **D32** (1985) 389.
- [127] D. Z. Freedman and H. Nicolai, “Multiplet Shortening in $OSp(N, 4)$,” *Nucl. Phys.* **B237** (1984) 342.
- [128] L. J. Romans, “Gauged $N = 4$ Supergravities in Five Dimensions and Their Magnetovac Backgrounds,” *Nucl. Phys.* **B267** (1986) 433.
- [129] R. D’Auria, P. Fre, E. Maina, and T. Regge, “A New Group Theoretical Technique for the Analysis of Bianchi Identities and Its Application to the Auxiliary Field Problem of $D = 5$ Supergravity,” *Ann. Phys.* **139** (1982) 93.
- [130] M. Gunaydin, G. Sierra, and P. K. Townsend, “The Geometry of $N = 2$ Maxwell-Einstein Supergravity and Jordan Algebras,” *Nucl. Phys.* **B242** (1984) 244.
- [131] M. Gunaydin, G. Sierra, and P. K. Townsend, “Quantization of the Gauge Coupling Constant in a Five-Dimensional Yang-Mills / Einstein Supergravity Theory,” *Phys. Rev. Lett.* **53** (1984) 322.
- [132] M. Gunaydin, G. Sierra, and P. K. Townsend, “Gauging the $d = 5$ Maxwell-Einstein Supergravity Theories: More on Jordan Algebras,” *Nucl. Phys.* **B253** (1985) 573.
- [133] B. de Wit and H. Nicolai, “ $N = 8$ Supergravity with Local $SO(8) \times SU(8)$ Invariance,” *Phys. Lett.* **108B** (1982) 285.
- [134] B. de Wit and H. Nicolai, “ $N = 8$ Supergravity,” *Nucl. Phys.* **B208** (1982) 323.
- [135] N. P. Warner, “Some New Extrema of the Scalar Potential of Gauged $N = 8$ Supergravity,” *Phys. Lett.* **128B** (1983) 169.
- [136] N. P. Warner, “Some Properties of the Scalar Potential in Gauged Supergravity Theories,” *Nucl. Phys.* **B231** (1984) 250.
- [137] B. de Wit and H. Nicolai, “Hidden Symmetry in $d = 11$ Supergravity,” *Phys. Lett.* **155B** (1985) 47.

- [138] A. Achucarro and P. K. Townsend, “Extended Supergravities in $d = (2 + 1)$ as Chern-Simons Theories,” *Phys. Lett.* **B229** (1989) 383.
- [139] M. Nishimura and Y. Tanii, “Supersymmetry in the AdS / CFT correspondence,” *Phys. Lett.* **B446** (1999) 37, hep-th/9810148.
- [140] B. de Wit and H. Nicolai, “The Consistency of the S^7 Truncation in $d = 11$ Supergravity,” *Nucl. Phys.* **B281** (1987) 211.
- [141] A. Chamblin, R. Emparan, C. V. Johnson, and R. C. Myers, “Charged AdS Black Holes and Catastrophic Holography,” hep-th/9902170.
- [142] M. Cvetič and S. S. Gubser, “Phases of R charged black holes, spinning branes and strongly coupled gauge theories,” hep-th/9902195.
- [143] M. Cvetič *et. al.*, “Embedding AdS black holes in ten-dimensions and eleven- dimensions,” hep-th/9903214.
- [144] E. Cremmer, “Supergravities in 5 Dimensions,”. Invited paper at the Nuffield Gravity Workshop, Cambridge, Eng., Jun 22 - Jul 12, 1980.
- [145] D. Z. Freedman, S. S. Gubser, K. Pilch, and N. P. Warner, “Renormalization group flows from holography supersymmetry and a c theorem,” hep-th/9904017.
- [146] S. Ferrara, M. Porrati, and A. Zaffaroni, “N=6 supergravity on AdS(5) and the SU(2,2/3) superconformal correspondence,” hep-th/9810063.
- [147] J. Distler and F. Zamora, “Nonsupersymmetric conformal field theories from stable anti-de Sitter spaces,” hep-th/9810206.
- [148] L. Girardello, M. Petrini, M. Porrati, and A. Zaffaroni, “Novel local CFT and exact results on perturbations of N=4 superYang Mills from AdS dynamics,” *JHEP* **12** (1998) 022, hep-th/9810126.
- [149] A. Khavaev, K. Pilch, and N. P. Warner, “New vacua of gauged N=8 supergravity in five-dimensions,” hep-th/9812035.
- [150] R. G. Leigh, “Dirac-Born-Infeld Action from Dirichlet Sigma-Model,” *Mod. Phys. Lett.* **A4** (1989) 2767.
- [151] G. W. Gibbons and P. K. Townsend, “Vacuum interpolation in supergravity via super p-branes,” *Phys. Rev. Lett.* **71** (1993) 3754–3757, hep-th/9307049.
- [152] E. Witten, “AdS / CFT correspondence and topological field theory,” *JHEP* **12** (1998) 012, hep-th/9812012.
- [153] N. Seiberg, private communication, February 1999.
- [154] S. Elitzur, G. Moore, A. Schwimmer, and N. Seiberg, “Remarks on the Canonical Quantization of the Chern-Simons-Witten Theory,” *Nucl. Phys.* **B326** (1989) 108.
- [155] C. Fronsdal, “The Dirac Supermultiplet,” *Phys. Rev.* **D26** (1982) 1988.
- [156] K. Pilch, P. van Nieuwenhuizen, and P. K. Townsend, “Compactification of $d = 11$ Supergravity on S^4 (Or $11 = 7 + 4$, Too),” *Nucl. Phys.* **B242** (1984) 377.
- [157] M. Gunaydin, B. E. W. Nilsson, G. Sierra, and P. K. Townsend, “Singletons and Superstrings,” *Phys. Lett.* **176B** (1986) 45.
- [158] E. Bergshoeff, A. Salam, E. Sezgin, and Y. Tanii, “Singletons, Higher Spin Massless States and the Supermembrane,” *Phys. Lett.* **205B** (1988) 237.
- [159] E. Bergshoeff, A. Salam, E. Sezgin, and Y. Tanii, “ $N = 8$ Supersingleton Quantum Field Theory,” *Nucl. Phys.* **B305** (1988) 497.
- [160] E. Bergshoeff, M. J. Duff, C. N. Pope, and E. Sezgin, “Compactifications of the Eleven-Dimensional Supermembrane,” *Phys. Lett.* **B224** (1989) 71.

- [161] M. R. Douglas, “Branes within branes,” [hep-th/9512077](#).
- [162] C. M. Hull and P. K. Townsend, “Unity of superstring dualities,” *Nucl. Phys.* **B438** (1995) 109–137, [hep-th/9410167](#).
- [163] A. A. Tseytlin, “Selfduality of Born-Infeld action and Dirichlet three-brane of type IIB superstring theory,” *Nucl. Phys.* **B469** (1996) 51–67, [hep-th/9602064](#).
- [164] M. B. Green and M. Gutperle, “Comments on three-branes,” *Phys. Lett.* **B377** (1996) 28–35, [hep-th/9602077](#).
- [165] M. R. Douglas and M. Li, “D-brane realization of N=2 superYang-Mills theory in four-dimensions,” [hep-th/9604041](#).
- [166] N. Seiberg and E. Witten, “Monopoles, duality and chiral symmetry breaking in N=2 supersymmetric QCD,” *Nucl. Phys.* **B431** (1994) 484–550, [hep-th/9408099](#).
- [167] M. Dine and N. Seiberg, “Comments on higher derivative operators in some SUSY field theories,” *Phys. Lett.* **B409** (1997) 239–244, [hep-th/9705057](#).
- [168] M. R. Douglas, D. Kabat, P. Pouliot, and S. H. Shenker, “D-branes and short distances in string theory,” *Nucl. Phys.* **B485** (1997) 85–127, [hep-th/9608024](#).
- [169] M. R. Douglas and W. Taylor, “Branes in the bulk of Anti-de Sitter space,” [hep-th/9807225](#).
- [170] S. R. Das, “Holograms of branes in the bulk and acceleration terms in SYM effective action,” [hep-th/9905037](#).
- [171] S. R. Das, “Brane waves, Yang-Mills theories and causality,” *JHEP* **02** (1999) 012, [hep-th/9901004](#).
- [172] A. Kehagias, “New type IIB vacua and their F theory interpretation,” *Phys. Lett.* **B435** (1998) 337, [hep-th/9805131](#).
- [173] S. S. Gubser, “Einstein manifolds and conformal field theories,” *Phys. Rev.* **D59** (1999) 025006, [hep-th/9807164](#).
- [174] L. J. Romans, “New Compactifications of Chiral $N = 2, d = 10$ Supergravity,” *Phys. Lett.* **153B** (1985) 392.
- [175] L. Susskind and E. Witten, “The Holographic bound in anti-de Sitter space,” [hep-th/9805114](#).
- [176] A. W. Peet and J. Polchinski, “UV / IR relations in AdS dynamics,” [hep-th/9809022](#).
- [177] D. Kabat and G. Lifschytz, “Gauge theory origins of supergravity causal structure,” [hep-th/9902073](#).
- [178] V. Balasubramanian, S. B. Giddings, and A. Lawrence, “What do CFTs tell us about Anti-de Sitter space-times?,” *JHEP* **03** (1999) 001, [hep-th/9902052](#).
- [179] G. T. Horowitz and N. Itzhaki, “Black holes, shock waves, and causality in the AdS / CFT correspondence,” *JHEP* **02** (1999) 010, [hep-th/9901012](#).
- [180] S. B. Giddings, “The Boundary S matrix and the AdS to CFT dictionary,” [hep-th/9903048](#).
- [181] G. T. Horowitz and S. F. Ross, “Possible resolution of black hole singularities from large N gauge theory,” *JHEP* **04** (1998) 015, [hep-th/9803085](#).
- [182] D. A. Lowe and L. Thorlacius, “AdS/CFT and the information paradox,” [hep-th/9903237](#).
- [183] D. Minic, “On the space-time uncertainty principle and holography,” *Phys. Lett.* **B442** (1998) 102, [hep-th/9808035](#).
- [184] O. Aharony and E. Witten, “Anti-de Sitter Space and the Center of the Gauge Group,” *JHEP* **11** (1998) 018, [hep-th/9807205](#).
- [185] E. Witten, “Anti-de Sitter space, thermal phase transition, and confinement in gauge theories,” *Adv. Theor. Math. Phys.* **2** (1998) 505, [hep-th/9803131](#).

- [186] F. Gonzalez-Rey, B. Kulik, I. Y. Park, and M. Rocek, “Selfdual effective action of N=4 superYang-Mills,” *Nucl. Phys.* **B544** (1999) 218, [hep-th/9810152](#).
- [187] J. Bagger and J. Wess, *Supersymmetry and Supergravity*. Princeton Series in Physics. Princeton University Press, Princeton, 1992.
- [188] O. Bergman, “Three Pronged Strings and 1/4 BPS States in $N = 4$ Super Yang-Mills Theory,” *Nucl. Phys.* **B525** (1998) 104, [hep-th/9712211](#).
- [189] K. Hashimoto, H. Hata, and N. Sasakura, “Three - string junction and BPS saturated solutions in SU(3) supersymmetric Yang-Mills theory,” *Phys. Lett.* **B431** (1998) 303–310, [hep-th/9803127](#).
- [190] T. Kawano and K. Okuyama, “String network and 1/4 BPS states in N=4 SU(N) supersymmetric Yang-Mills theory,” *Phys. Lett.* **B432** (1998) 338–342, [hep-th/9804139](#).
- [191] O. Bergman and B. Kol, “String Webs and 1/4 BPS Monopoles,” *Nucl. Phys.* **B536** (1998) 149, [hep-th/9804160](#).
- [192] K. Hashimoto, H. Hata, and N. Sasakura, “Multipronged strings and BPS saturated solutions in SU(N) supersymmetric Yang-Mills theory,” *Nucl. Phys.* **B535** (1998) 83, [hep-th/9804164](#).
- [193] K. Lee and P. Yi, “Dyons in N=4 supersymmetric theories and three pronged strings,” *Phys. Rev.* **D58** (1998) 066005, [hep-th/9804174](#).
- [194] N. Sasakura and S. Sugimoto, “M theory description of 1/4 BPS states in N=4 supersymmetric Yang-Mills theory,” [hep-th/9811087](#).
- [195] D. Tong, “A Note on 1/4 BPS states,” [hep-th/9902005](#).
- [196] M. Gunaydin, D. Minic, and M. Zagermann, “Novel supermultiplets of $SU(2, 2|4)$ and the AdS_5 / CFT_4 duality,” [hep-th/9810226](#).
- [197] L. Andrianopoli and S. Ferrara, “K-K Excitations on $AdS_5 \times S^5$ as $N = 4$ ‘Primary’ Superfields,” *Phys. Lett.* **B430** (1998) 248–253, [hep-th/9803171](#).
- [198] L. Andrianopoli and S. Ferrara, “‘Nonchiral’ Primary Superfields in the AdS_{d+1} / CFT_d Correspondence,” *Lett. Math. Phys.* **46** (1998) 265, [hep-th/9807150](#).
- [199] S. Ferrara and A. Zaffaroni, “Bulk gauge fields in AdS supergravity and supersingletons,” [hep-th/9807090](#).
- [200] M. Gunaydin, D. Minic, and M. Zagermann, “4-D doubleton conformal theories, CPT and II B string on $AdS_5 \times S^5$,” *Nucl. Phys.* **B534** (1998) 96–120, [hep-th/9806042](#).
- [201] L. Andrianopoli and S. Ferrara, “On Short and Long $SU(2, 2/4)$ Multiplets in the AdS/CFT Correspondence,” [hep-th/9812067](#).
- [202] M. Flato and C. Fronsdal, “One massless particle equals two Dirac singletons: elementary particles in a curved space. 6,” *Lett. Math. Phys.* **2** (1978) 421.
- [203] C. Fronsdal and M. Flato, “On Dis and Rac,” *Phys. Lett.* **97B** (1980) 236.
- [204] M. Flato and C. Fronsdal, “Quantum field theory of singletons: the Rac,” *J. Math. Phys.* **22** (1981) 1100.
- [205] E. Angelopoulos, M. Flato, C. Fronsdal, and D. Sternheimer, “Massless Particles, Conformal Group and de Sitter Universe,” *Phys. Rev.* **D23** (1981) 1278.
- [206] H. Nicolai and E. Sezgin, “Singleton representations of $OSp(N, 4)$,” *Phys. Lett.* **143B** (1984) 389.
- [207] M. Flato and C. Fronsdal, “Quarks of singletons?,” *Phys. Lett.* **B172** (1986) 412.
- [208] S. Ferrara and C. Fronsdal, “Conformal Maxwell theory as a singleton field theory on AdS_5 , IIB three-branes and duality,” *Class. Quant. Grav.* **15** (1998) 2153, [hep-th/9712239](#).
- [209] S. Ferrara and C. Fronsdal, “Gauge fields and singletons of AdS_{2p+1} ,” *Lett. Math. Phys.* **46** (1998) 157, [hep-th/9806072](#).

- [210] S. Ferrara and C. Fronsdal, “Gauge fields as composite boundary excitations,” *Phys. Lett.* **B433** (1998) 19–28, [hep-th/9802126](#).
- [211] S. Ferrara, C. Fronsdal, and A. Zaffaroni, “On N=8 supergravity on AdS₅ and N=4 superconformal Yang–Mills theory,” *Nucl. Phys.* **B532** (1998) 153, [hep-th/9802203](#).
- [212] S. Ferrara, M. A. Lledo, and A. Zaffaroni, “Born-Infeld corrections to D3-brane action in AdS(5) x S(5) and N=4, d = 4 primary superfields,” *Phys. Rev.* **D58** (1998) 105029, [hep-th/9805082](#).
- [213] S. R. Das and S. P. Trivedi, “Three-brane action and the correspondence between N=4 Yang–Mills theory and anti-De Sitter space,” *Phys. Lett.* **B445** (1998) 142, [hep-th/9804149](#).
- [214] P. Berglund, E. G. Gimon, and D. Minic, “The AdS/CFT correspondence and spectrum generating algebras,” [hep-th/9905097](#).
- [215] O. Aharony, M. Berkooz, D. Kutasov, and N. Seiberg, “Linear Dilatons, NS Five-Branes and Holography,” *JHEP* **10** (1998) 004, [hep-th/9808149](#).
- [216] E. Witten, “Baryons and branes in anti-de Sitter space,” *JHEP* **07** (1998) 006, [hep-th/9805112](#).
- [217] I. R. Klebanov and E. Witten, “Superconformal field theory on three-branes at a Calabi-Yau singularity,” *Nucl. Phys.* **B536** (1998) 199, [hep-th/9807080](#).
- [218] S. S. Gubser and I. R. Klebanov, “Baryons and domain walls in an N=1 superconformal gauge theory,” *Phys. Rev.* **D58** (1998) 125025, [hep-th/9808075](#).
- [219] D. Z. Freedman, S. D. Mathur, A. Matusis, and L. Rastelli, “Correlation functions in the CFT_d / AdS_{d+1} correspondence,” [hep-th/9804058](#).
- [220] G. Chalmers, H. Nastase, K. Schalm, and R. Siebelink, “R Current Correlators in N = 4 Super Yang–Mills Theory from Anti-de Sitter Supergravity,” *Nucl. Phys.* **B540** (1999) 247, [hep-th/9805105](#).
- [221] S. Deser and A. Schwimmer, “Geometric classification of conformal anomalies in arbitrary dimensions,” *Phys. Lett.* **B309** (1993) 279–284, [hep-th/9302047](#).
- [222] M. J. Duff, “Twenty years of the Weyl anomaly,” *Class. Quant. Grav.* **11** (1994) 1387–1404, [hep-th/9308075](#).
- [223] H. Osborn and A. Petkos, “Implications of conformal invariance in field theories for general dimensions,” *Ann. Phys.* **231** (1994) 311–362, [hep-th/9307010](#).
- [224] D. Anselmi, M. Grisaru, and A. Johansen, “A Critical Behavior of Anomalous Currents, Electric-Magnetic Universality and CFT in Four-Dimensions,” *Nucl. Phys.* **B491** (1997) 221–248, [hep-th/9601023](#).
- [225] D. Anselmi, D. Z. Freedman, M. T. Grisaru, and A. A. Johansen, “Nonperturbative Formulas for Central Functions of Supersymmetric Gauge Theories,” *Nucl. Phys.* **B526** (1998) 543, [hep-th/9708042](#).
- [226] M. Henningson and K. Skenderis, “The Holographic Weyl anomaly,” *JHEP* **07** (1998) 023, [hep-th/9806087](#).
- [227] M. Henningson and K. Skenderis, “Holography and the Weyl anomaly,” [hep-th/9812032](#).
- [228] V. Balasubramanian and P. Kraus, “A Stress Tensor for Anti-de Sitter Gravity,” [hep-th/9902121](#).
- [229] W. Mueck and K. S. Viswanathan, “Counterterms for the Dirichlet prescription of the AdS/CFT correspondence,” [hep-th/9905046](#).
- [230] S. Nojiri and S. D. Odintsov, “Conformal anomaly for dilaton coupled theories from AdS / CFT correspondence,” *Phys. Lett.* **B444** (1998) 92, [hep-th/9810008](#).
- [231] D. Anselmi and A. Kehagias, “Subleading corrections and central charges in the AdS / CFT correspondence,” [hep-th/9812092](#).

- [232] O. Aharony, J. Pawelczyk, S. Theisen, and S. Yankielowicz, “A Note on Anomalies in the AdS / CFT Correspondence,” [hep-th/9901134](#).
- [233] M. Blau, K. S. Narain, and E. Gava, “On subleading contributions to the AdS / CFT trace anomaly,” [hep-th/9904179](#).
- [234] S. Nojiri and S. D. Odintsov, “On the conformal anomaly from higher derivative gravity in AdS / CFT correspondence,” [hep-th/9903033](#).
- [235] S. Lee, S. Minwalla, M. Rangamani, and N. Seiberg, “Three point functions of chiral operators in $D = 4$, $N=4$ SYM at large N ,” *Adv. Theor. Math. Phys.* **2** (1999) 697, [hep-th/9806074](#).
- [236] E. D’Hoker, D. Z. Freedman, and W. Skiba, “Field theory tests for correlators in the AdS / CFT correspondence,” *Phys. Rev.* **D59** (1999) 045008, [hep-th/9807098](#).
- [237] F. Gonzalez-Rey, B. Kulik, and I. Y. Park, “Nonrenormalization of two point and three point correlators of $N=4$ SYM in $N=1$ superspace,” [hep-th/9903094](#).
- [238] K. Intriligator, “Bonus symmetries of $N=4$ superYang-Mills correlation functions via AdS duality,” [hep-th/9811047](#).
- [239] K. Intriligator and W. Skiba, “Bonus symmetry and the operator product expansion of $N=4$ super-yang-Mills,” [hep-th/9905020](#).
- [240] B. Eden, P. S. Howe, and P. C. West, “Nilpotent invariants in $N=4$ SYM,” [hep-th/9905085](#).
- [241] G. W. Gibbons and S. W. Hawking, “Action integrals and partition functions in quantum gravity,” *Phys. Rev.* **D15** (1977) 2752–2756.
- [242] I. Y. Aref’eva and I. V. Volovich, “On large N conformal theories, field theories in anti-de Sitter space and singletons,” [hep-th/9803028](#).
- [243] W. Muck and K. S. Viswanathan, “Conformal field theory correlators from classical scalar field theory on AdS_{d+1} ,” *Phys. Rev.* **D58** (1998) 041901, [hep-th/9804035](#).
- [244] H. Liu and A. A. Tseytlin, “ $D = 4$ superYang-Mills, $D = 5$ gauged supergravity, and $D = 4$ conformal supergravity,” *Nucl. Phys.* **B533** (1998) 88, [hep-th/9804083](#).
- [245] W. Muck and K. S. Viswanathan, “Conformal field theory correlators from classical field theory on anti-de Sitter space. 2. Vector and spinor fields,” *Phys. Rev.* **D58** (1998) 106006, [hep-th/9805145](#).
- [246] S. N. Solodukhin, “Correlation functions of boundary field theory from bulk Green’s functions and phases in the boundary theory,” *Nucl. Phys.* **B539** (1999) 403, [hep-th/9806004](#).
- [247] H. Liu and A. A. Tseytlin, “On four point functions in the CFT / AdS correspondence,” *Phys. Rev.* **D59** (1999) 086002, [hep-th/9807097](#).
- [248] D. Z. Freedman, S. D. Mathur, A. Matusis, and L. Rastelli, “Comments on 4 point functions in the CFT / AdS correspondence,” [hep-th/9808006](#).
- [249] E. D’Hoker and D. Z. Freedman, “Gauge boson exchange in AdS_{d+1} ,” [hep-th/9809179](#).
- [250] G. Chalmers and K. Schalm, “The Large N_c Limit of Four-Point Functions in $N = 4$ Super Yang-Mills Theory from Anti-de Sitter Supergravity,” [hep-th/9810051](#).
- [251] W. Muck and K. S. Viswanathan, “The Graviton in the AdS-CFT correspondence: Solution via the Dirichlet boundary value problem,” [hep-th/9810151](#).
- [252] E. D’Hoker and D. Z. Freedman, “General scalar exchange in AdS_{d+1} ,” [hep-th/9811257](#).
- [253] P. Minces and V. O. Rivelles, “Chern-Simons theories in the AdS / CFT correspondence,” [hep-th/9902123](#).
- [254] G. Arutyunov and S. Frolov, “Three-Point Green Function of the Stress-Energy Tensor in the AdS / CFT Correspondence,” [hep-th/9901121](#).

- [255] D. Z. Freedman, K. Johnson, and J. I. Latorre, “Differential regularization and renormalization: A New method of calculation in quantum field theory,” *Nucl. Phys.* **B371** (1992) 353–414.
- [256] M. Henningson and K. Sfetsos, “Spinors and the AdS / CFT correspondence,” *Phys. Lett.* **B431** (1998) 63–68, [hep-th/9803251](#).
- [257] A. M. Ghezelbash, K. Kaviani, S. Parvizi, and A. H. Fatollahi, “Interacting spinors - scalars and AdS / CFT correspondence,” *Phys. Lett.* **B435** (1998) 291, [hep-th/9805162](#).
- [258] G. E. Arutyunov and S. A. Frolov, “On the origin of supergravity boundary terms in the AdS / CFT correspondence,” *Nucl. Phys.* **B544** (1999) 576, [hep-th/9806216](#).
- [259] G. E. Arutyunov and S. A. Frolov, “Antisymmetric tensor field on AdS(5),” *Phys. Lett.* **B441** (1998) 173, [hep-th/9807046](#).
- [260] W. S. l’Yi, “Holographic projection of massive vector fields in AdS / CFT correspondence,” [hep-th/9808051](#).
- [261] A. Volovich, “Rarita-Schwinger field in the AdS / CFT correspondence,” *JHEP* **09** (1998) 022, [hep-th/9809009](#).
- [262] W. S. l’Yi, “Generating functionals of correlation functions of p form currents in AdS / CFT correspondence,” [hep-th/9809132](#).
- [263] W. S. l’Yi, “Correlators of currents corresponding to the massive p form fields in AdS / CFT correspondence,” *Phys. Lett.* **B448** (1999) 218, [hep-th/9811097](#).
- [264] A. S. Koshelev and O. A. Rytchkov, “Note on the massive Rarita-Schwinger field in the AdS / CFT correspondence,” *Phys. Lett.* **B450** (1999) 368, [hep-th/9812238](#).
- [265] R. C. Rashkov, “Note on the boundary terms in AdS / CFT correspondence for Rarita-Schwinger field,” [hep-th/9904098](#).
- [266] A. Polishchuk, “Massive symmetric tensor field on AdS,” [hep-th/9905048](#).
- [267] G. Dall’Agata, K. Lechner, and D. Sorokin, “Covariant actions for the bosonic sector of d = 10 IIB supergravity,” *Class. Quant. Grav.* **14** (1997) L195–L198, [hep-th/9707044](#).
- [268] G. Dall’Agata, K. Lechner, and M. Tonin, “D = 10, N = IIB supergravity: Lorentz invariant actions and duality,” *JHEP* **07** (1998) 017, [hep-th/9806140](#).
- [269] G. E. Arutyunov and S. A. Frolov, “Quadratic action for Type IIB supergravity on $AdS_5 \times S^5$,” [hep-th/9811106](#).
- [270] P. S. Howe and P. C. West, “The Complete $N = 2, d = 10$ Supergravity,” *Nucl. Phys.* **B238** (1984) 181.
- [271] E. D’Hoker, D. Z. Freedman, S. D. Mathur, A. Matusis, and L. Rastelli, “Graviton exchange and complete four point functions in the AdS / CFT correspondence,” [hep-th/9903196](#).
- [272] E. D’Hoker, D. Z. Freedman, S. D. Mathur, A. Matusis, and L. Rastelli, “Graviton and gauge boson propagators in AdS(d+1),” [hep-th/9902042](#).
- [273] H. Liu, “Scattering in anti-de Sitter space and operator product expansion,” [hep-th/9811152](#).
- [274] G. Chalmers and K. Schalm, “Holographic normal ordering and multiparticle states in the AdS / CFT correspondence,” [hep-th/9901144](#).
- [275] F. Gonzalez-Rey, I. Park, and K. Schalm, “A Note on four point functions of conformal operators in N=4 superYang-Mills,” *Phys. Lett.* **B448** (1999) 37, [hep-th/9811155](#).
- [276] E. D’Hoker, D. Z. Freedman, and L. Rastelli, “AdS/CFT four point functions: How to succeed at Z integrals without really trying,” [hep-th/9905049](#).
- [277] G. T. Horowitz and H. Ooguri, “Spectrum of large N gauge theory from supergravity,” *Phys. Rev. Lett.* **80** (1998) 4116–4118, [hep-th/9802116](#).

- [278] J. Maldacena and A. Strominger, “AdS₃ Black Holes and a Stringy Exclusion Principle,” *JHEP* **12** (1998) 005, [hep-th/9804085](#).
- [279] T. Banks, M. R. Douglas, G. T. Horowitz, and E. Martinec, “AdS Dynamics from Conformal Field Theory,” [hep-th/9808016](#).
- [280] J. L. F. Barbon and E. Rabinovici, “Extensivity versus holography in anti-de Sitter spaces,” *Nucl. Phys.* **B545** (1999) 371, [hep-th/9805143](#).
- [281] J. L. F. Barbon, I. I. Kogan, and E. Rabinovici, “On stringy thresholds in SYM / AdS thermodynamics,” *Nucl. Phys.* **B544** (1999) 104, [hep-th/9809033](#).
- [282] S. A. Abel, J. L. F. Barbon, I. I. Kogan, and E. Rabinovici, “String thermodynamics in D-brane backgrounds,” *JHEP* **04** (1999) 015, [hep-th/9902058](#).
- [283] A. Chamblin, R. Emparan, C. V. Johnson, and R. C. Myers, “Large N phases, gravitational instantons and the nuts and bolts of AdS holography,” *Phys. Rev.* **D59** (1999) 064010, [hep-th/9808177](#).
- [284] M. Li, E. Martinec, and V. Sahakian, “Black holes and the SYM phase diagram,” *Phys. Rev.* **D59** (1999) 044035, [hep-th/9809061](#).
- [285] A. W. Peet and S. F. Ross, “Microcanonical phases of string theory on $AdS_m \times S^n$,” *JHEP* **12** (1998) 020, [hep-th/9810200](#).
- [286] E. J. Martinec, “Conformal field theory, geometry, and entropy,” [hep-th/9809021](#).
- [287] E. Martinec and V. Sahakian, “Black holes and the superYang-Mills phase diagram. 2,” *Phys. Rev.* **D59** (1999) 124005, [hep-th/9810224](#).
- [288] E. Martinec and V. Sahakian, “Black Holes and Five-Brane Thermodynamics,” [hep-th/9901135](#).
- [289] S. W. Hawking and D. N. Page, “Thermodynamics of black holes in anti-de Sitter space,” *Commun. Math. Phys.* **87** (1983) 577.
- [290] S. S. Gubser, I. R. Klebanov, and A. A. Tseytlin, “Coupling constant dependence in the thermodynamics of N=4 supersymmetric Yang-Mills theory,” *Nucl. Phys.* **B534** (1998) 202, [hep-th/9805156](#).
- [291] D. J. Gross, M. J. Perry, and L. G. Yaffe, “Instability of Flat Space at Finite Temperature,” *Phys. Rev.* **D25** (1982) 330.
- [292] S. S. Gubser, I. R. Klebanov, and A. W. Peet, “Entropy and temperature of black 3-branes,” *Phys. Rev.* **D54** (1996) 3915–3919, [hep-th/9602135](#).
- [293] D. J. Gross and H. Ooguri, “Aspects of Large N Gauge Theory Dynamics as seen by String Theory,” *Phys. Rev.* **D58** (1998) 106002, [hep-th/9805129](#).
- [294] J. Maldacena, “Wilson loops in large N field theories,” *Phys. Rev. Lett.* **80** (1998) 4859, [hep-th/9803002](#).
- [295] S.-J. Rey and J. Yee, “Macroscopic strings as heavy quarks in large N gauge theory and anti-de Sitter supergravity,” [hep-th/9803001](#).
- [296] N. Drukker, D. J. Gross, and H. Ooguri, “Wilson Loops and Minimal Surfaces,” [hep-th/9904191](#).
- [297] G. 't Hooft, “A Property of Electric and Magnetic Flux in Nonabelian Gauge Theories,” *Nucl. Phys.* **B153** (1979) 141.
- [298] S. Forste, D. Ghoshal, and S. Theisen, “Stringy corrections to the Wilson loop in N=4 superYang- Mills theory,” [hep-th/9903042](#).
- [299] S. Naik, “Improved heavy quark potential at finite temperature from Anti-de Sitter supergravity,” [hep-th/9904147](#).
- [300] J. Greensite and P. Olesen, “Worldsheet Fluctuations and the Heavy Quark Potential in the AdS/CFT Approach,” [hep-th/9901057](#).

- [301] J. A. Minahan, “Quark - monopole potentials in large N superYang-Mills,” *Adv. Theor. Math. Phys.* **2** (1998) 559, [hep-th/9803111](#).
- [302] J. A. Minahan and N. P. Warner, “Quark potentials in the Higgs phase of large N supersymmetric Yang-Mills theories,” *JHEP* **06** (1998) 005, [hep-th/9805104](#).
- [303] I. I. Kogan and O. A. Solovev, “Gravitationally dressed RG flows and zigzag invariant strings,” *Phys. Lett.* **B442** (1998) 136, [hep-th/9807223](#).
- [304] I. I. Kogan and O. A. Solovev, “On zigzag invariant strings,” [hep-th/9901131](#).
- [305] S. Nojiri and S. D. Odintsov, “Running gauge coupling and quark - anti-quark potential from dilatonic gravity,” [hep-th/9904036](#).
- [306] K. Zarembo, “Wilson loop correlator in the AdS / CFT correspondence,” [hep-th/9904149](#).
- [307] E. Alvarez, C. Gomez, and T. Ortin, “String representation of Wilson loops,” *Nucl. Phys.* **B545** (1999) 217, [hep-th/9806075](#).
- [308] C. R. Graham and E. Witten, “Conformal anomaly of submanifold observables in AdS / CFT correspondence,” [hep-th/9901021](#).
- [309] D. Berenstein, R. Corrado, W. Fischler, and J. Maldacena, “The Operator Product Expansion for Wilson Loops and Surfaces in the Large N Limit,” [hep-th/9809188](#).
- [310] A. Strominger, unpublished notes, November, 1995.
- [311] G. T. Horowitz and J. Polchinski, “A Correspondence principle for black holes and strings,” *Phys. Rev.* **D55** (1997) 6189–6197, [hep-th/9612146](#).
- [312] N. Itzhaki, “A Comment on the entropy of strongly coupled N=4,” [hep-th/9904035](#).
- [313] A. Fotopoulos and T. R. Taylor, “Comment on two loop free energy in N=4 supersymmetric Yang- Mills theory at finite temperature,” [hep-th/9811224](#).
- [314] R. M. Wald, “Black hole entropy in Noether charge,” *Phys. Rev.* **D48** (1993) 3427–3431, [gr-qc/9307038](#).
- [315] M. Li, “Evidence for large N phase transition in N=4 superYang- Mills theory at finite temperature,” *JHEP* **03** (1999) 004, [hep-th/9807196](#).
- [316] Y. hong Gao and M. Li, “Large N strong / weak coupling phase transition and the correspondence principle,” [hep-th/9810053](#).
- [317] S. S. Gubser, “Thermodynamics of spinning D3-branes,” [hep-th/9810225](#).
- [318] K. Landsteiner, “String corrections to the Hawking-Page phase transition,” *Mod. Phys. Lett.* **A14** (1999) 379, [hep-th/9901143](#).
- [319] R.-G. Cai and K.-S. Soh, “Critical behavior in the rotating D-branes,” [hep-th/9812121](#).
- [320] M. Cvetič and S. S. Gubser, “Thermodynamic stability and phases of general spinning branes,” [hep-th/9903132](#).
- [321] M. M. Caldarelli and D. Klemm, “M theory and stringy corrections to Anti-de Sitter black holes and conformal field theories,” [hep-th/9903078](#).
- [322] P. Kraus, F. Larsen, and S. P. Trivedi, “The Coulomb branch of gauge theory from rotating branes,” *JHEP* **03** (1999) 003, [hep-th/9811120](#).
- [323] A. A. Tseytlin and S. Yankielowicz, “Free energy of N=4 superYang-Mills in Higgs phase and nonextremal D3-brane interactions,” *Nucl. Phys.* **B541** (1999) 145, [hep-th/9809032](#).
- [324] D. Birmingham, “Topological black holes in Anti-de Sitter space,” *Class. Quant. Grav.* **16** (1999) 1197, [hep-th/9808032](#).
- [325] J. Louko and D. Marolf, “Single exterior black holes and the AdS / CFT conjecture,” *Phys. Rev.* **D59** (1999) 066002, [hep-th/9808081](#).

- [326] S. W. Hawking, C. J. Hunter, and M. M. Taylor-Robinson, “Rotation and the AdS / CFT correspondence,” *Phys. Rev.* **D59** (1999) 064005, [hep-th/9811056](#).
- [327] S.-J. Rey, S. Theisen, and J. Yee, “Wilson-Polyakov Loop at Finite Temperature in Large N Gauge Theory and Anti-de Sitter Supergravity,” *Nucl.Phys.* **B527** (1998) 171–186, [hep-th/9803135](#).
- [328] A. Brandhuber, N. Itzhaki, J. Sonnenschein, and S. Yankielowicz, “Wilson loops in the large N limit at finite temperature,” *Phys. Lett.* **B434** (1998) 36–40, [hep-th/9803137](#).
- [329] R. Gopakumar and C. Vafa, “On the gauge theory / geometry correspondence,” [hep-th/9811131](#).
- [330] S. Kachru and E. Silverstein, “4-D conformal theories and strings on orbifolds,” *Phys. Rev. Lett.* **80** (1998) 4855, [hep-th/9802183](#).
- [331] J. M. Figueroa-O’Farrill, “Near horizon geometries of supersymmetric branes,” [hep-th/9807149](#).
- [332] B. S. Acharya, J. M. Figueroa-O’Farrill, C. M. Hull, and B. Spence, “Branes at Conical Singularities and Holography,” [hep-th/9808014](#).
- [333] D. R. Morrison and M. R. Plesser, “Nonspherical horizons. 1,” [hep-th/9810201](#).
- [334] K. Ray, “Candidates for anti-de Sitter horizons,” [hep-th/9904113](#).
- [335] J. M. Figueroa-O’Farrill, “On the supersymmetries of Anti-de Sitter vacua,” [hep-th/9902066](#).
- [336] M. J. Duff, H. Lu, and C. N. Pope, “ $AdS_5 \times S^5$ untwisted,” *Nucl. Phys.* **B532** (1998) 181, [hep-th/9803061](#).
- [337] C. N. Pope and P. van Nieuwenhuizen, “Compactifications of $d = 11$ supergravity on Kahler manifolds,” *Commun. Math. Phys.* **122** (1989) 281.
- [338] M. Berkooz and S.-J. Rey, “Nonsupersymmetric Stable Vacua of M Theory,” *JHEP* **01** (1999) 014, [hep-th/9807200](#).
- [339] M. Berkooz and A. Kapustin, “A Comment on nonsupersymmetric fixed points and duality at large N ,” [hep-th/9903195](#).
- [340] J. D. Brown and C. Teitelboim, “Neutralization of the Cosmological Constant by Membrane Creation,” *Nucl. Phys.* **B297** (1988) 787.
- [341] F. Dowker, J. P. Gauntlett, G. W. Gibbons, and G. T. Horowitz, “Nucleation of p-branes and fundamental strings,” *Phys. Rev.* **D53** (1996) 7115–7128, [hep-th/9512154](#).
- [342] J. Maldacena, J. Michelson, and A. Strominger, “Anti-de Sitter fragmentation,” *JHEP* **02** (1999) 011, [hep-th/9812073](#).
- [343] N. Seiberg and E. Witten, “The D1 / D5 system and singular CFT,” [hep-th/9903224](#).
- [344] M. R. Douglas and G. Moore, “D-branes, quivers, and ALE instantons,” [hep-th/9603167](#).
- [345] M. R. Douglas, B. R. Greene, and D. R. Morrison, “Orbifold resolution by D-branes,” *Nucl. Phys.* **B506** (1997) 84, [hep-th/9704151](#).
- [346] Y. hong Gao, “AdS / CFT correspondence and quotient space geometry,” *JHEP* **04** (1999) 005, [hep-th/9903080](#).
- [347] Y. Oz and J. Terning, “Orbifolds of $AdS_5 \times S^5$ and 4d Conformal Field Theories,” *Nucl. Phys.* **B532** (1998) 163–180, [hep-th/9803167](#).
- [348] A. Lawrence, N. Nekrasov, and C. Vafa, “On conformal field theories in four-dimensions,” *Nucl. Phys.* **B533** (1998) 199, [hep-th/9803015](#).
- [349] M. Bershadsky, Z. Kakushadze, and C. Vafa, “String Expansion as Large N Expansion of Gauge Theories,” *Nucl. Phys.* **B523** (1998) 59, [hep-th/9803076](#).

- [350] M. Bershadsky and A. Johansen, “Large N Limit of Orbifold Field Theories,” *Nucl. Phys.* **B536** (1998) 141, [hep-th/9803249](#).
- [351] M. Schmaltz, “Duality of nonsupersymmetric large N gauge theories,” *Phys. Rev.* **D59** (1999) 105018, [hep-th/9805218](#).
- [352] J. Erlich and A. Naqvi, “Nonperturbative tests of the parent / orbifold correspondence in supersymmetric gauge theories,” [hep-th/9808026](#).
- [353] E. Witten, “Solutions Of Four-Dimensional Field Theories Via M Theory,” *Nucl. Phys.* **B500** (1997) 3–42, [hep-th/9703166](#).
- [354] A. Hanany and A. M. Uranga, “Brane boxes and branes on singularities,” *JHEP* **05** (1998) 013, [hep-th/9805139](#).
- [355] P. S. Aspinwall, “Enhanced Gauge Symmetries and K3 Surfaces,” *Phys. Lett.* **B357** (1995) 329–334, [hep-th/9507012](#).
- [356] S. Gukov, “Comments on $N=2$ AdS orbifolds,” *Phys. Lett.* **B439** (1998) 23, [hep-th/9806180](#).
- [357] K. Konishi, “Anomalous supersymmetry transformation of some composite operators in SQCD,” *Phys. Lett.* **135B** (1984) 439.
- [358] K. Konishi and K. Shizuya, “Functional integral approach to chiral anomalies in supersymmetric gauge theories,” *Nuovo Cim.* **90A** (1985) 111.
- [359] S. Gukov, M. Rangamani, and E. Witten, “Dibaryons, strings and branes in AdS orbifold models,” *JHEP* **12** (1998) 025, [hep-th/9811048](#).
- [360] P. H. Frampton, “AdS / CFT string duality and conformal gauge field theories,” [hep-th/9812117](#).
- [361] P. H. Frampton and W. F. Shively, “Conformal $N=0$ $d = 4$ gauge theories from AdS / CFT superstring duality?,” [hep-th/9902168](#).
- [362] Z. Kakushadze, “Gauge theories from orientifolds and large N limit,” *Nucl. Phys.* **B529** (1998) 157, [hep-th/9803214](#).
- [363] Z. Kakushadze, “On large N gauge theories from orientifolds,” *Phys. Rev.* **D58** (1998) 106003, [hep-th/9804184](#).
- [364] Z. Kakushadze, “Anomaly free nonsupersymmetric large N gauge theories from orientifolds,” *Phys. Rev.* **D59** (1999) 045007, [hep-th/9806091](#).
- [365] Z. Kakushadze, “Large N gauge theories from orientifolds with NS-NS B flux,” *Nucl. Phys.* **B544** (1999) 265, [hep-th/9808048](#).
- [366] C. Ahn, K. Oh, and R. Tatar, “The Large N limit of $N = 1$ field theories from F theory,” [hep-th/9808143](#).
- [367] J. Park and A. M. Uranga, “A Note on superconformal $N=2$ theories and orientifolds,” *Nucl. Phys.* **B542** (1999) 139, [hep-th/9808161](#).
- [368] S. Gukov and A. Kapustin, “New $N=2$ superconformal field theories from M / F theory orbifolds,” *Nucl. Phys.* **B545** (1999) 283, [hep-th/9808175](#).
- [369] M. Gremm and A. Kapustin, “ $N=1$ theories, T duality, and AdS / CFT correspondence,” [hep-th/9904050](#).
- [370] A. Giveon and D. Kutasov, “Brane dynamics and gauge theory,” [hep-th/9802067](#).
- [371] R. L. Mkrchian, “The equivalence of $Sp(2N)$ and $SO(2N)$ gauge theories,” *Phys. Lett.* **105B** (1981) 174.
- [372] P. Cvitanovic and A. D. Kennedy, “Spinors in negative dimensions,” *Phys. Scripta* **26** (1982) 5.
- [373] A. Sen, “F theory and orientifolds,” *Nucl. Phys.* **B475** (1996) 562–578, [hep-th/9605150](#).

- [374] T. Banks, M. R. Douglas, and N. Seiberg, “Probing F Theory with Branes,” *Phys. Lett.* **B387** (1996) 278–281, [hep-th/9605199](#).
- [375] C. Vafa, “Evidence for F theory,” *Nucl. Phys.* **B469** (1996) 403–418, [hep-th/9602022](#).
- [376] O. Aharony, J. Sonnenschein, S. Yankielowicz, and S. Theisen, “Field Theory Questions for String Theory Answers,” *Nucl. Phys.* **B493** (1997) 177–197, [hep-th/9611222](#).
- [377] M. R. Douglas, D. A. Lowe, and J. H. Schwarz, “Probing F theory with multiple branes,” *Phys. Lett.* **B394** (1997) 297–301, [hep-th/9612062](#).
- [378] A. Fayyazuddin and M. Spalinski, “Large N superconformal gauge theories and supergravity orientifolds,” *Nucl. Phys.* **B535** (1998) 219, [hep-th/9805096](#).
- [379] O. Aharony, A. Fayyazuddin, and J. Maldacena, “The Large N Limit of $N = 2, N = 1$ Field Theories from Three-Branes in F Theory,” *JHEP* **07** (1998) 013, [hep-th/9806159](#).
- [380] R. de Mello Koch, A. Paulin-Campbell, and J. P. Rodrigues, “Nonholomorphic corrections from three-branes in F theory,” [hep-th/9903029](#).
- [381] A. M. Uranga, “Brane configurations for branes at conifolds,” *JHEP* **01** (1999) 022, [hep-th/9811004](#).
- [382] K. Dasgupta and S. Mukhi, “Brane constructions, conifolds and M theory,” [hep-th/9811139](#).
- [383] S. Gubser, N. Nekrasov, and S. Shatashvili, “Generalized conifolds and 4-Dimensional N=1 SuperConformal Field Theory,” *JHEP* **05** (1999) 003, [hep-th/9811230](#).
- [384] E. Lopez, “A Family of N=1 $SU(N)^k$ theories from branes at singularities,” *JHEP* **02** (1999) 019, [hep-th/9812025](#).
- [385] R. von Unge, “Branes at generalized conifolds and toric geometry,” *JHEP* **02** (1999) 023, [hep-th/9901091](#).
- [386] J. Erlich, A. Hanany, and A. Naqvi, “Marginal deformations from branes,” *JHEP* **03** (1999) 008, [hep-th/9902118](#).
- [387] R. G. Leigh and M. J. Strassler, “Exactly marginal operators and duality in four-dimensional N=1 supersymmetric gauge theory,” *Nucl. Phys.* **B447** (1995) 95–136, [hep-th/9503121](#).
- [388] D. P. Jatkar and S. Randjbar-Daemi, “Type IIB string theory on $AdS_5 \times T^{n(n-prime)}$,” [hep-th/9904187](#).
- [389] J. L. Cardy, “Is There a c -Theorem in Four Dimensions ?,” *Phys. Lett.* **B215** (1988) 749.
- [390] S. Forte and J. I. Latorre, “A Proof of the irreversibility of renormalization group flows in four-dimensions,” *Nucl. Phys.* **B535** (1998) 709, [hep-th/9805015](#).
- [391] L. Alvarez-Gaume and E. Witten, “Gravitational Anomalies,” *Nucl. Phys.* **B234** (1984) 269.
- [392] A. Brandhuber, N. Itzhaki, J. Sonnenschein, and S. Yankielowicz, “Baryons from Supergravity,” *JHEP* **07** (1998) 020, [hep-th/9806158](#).
- [393] Y. Imamura, “Baryon mass and phase transitions in large N gauge theory,” *Prog. Theor. Phys.* **100** (1998) 1263, [hep-th/9806162](#).
- [394] Y. Imamura, “Supersymmetries and BPS configurations on Anti-de Sitter space,” *Nucl. Phys.* **B537** (1999) 184, [hep-th/9807179](#).
- [395] C. G. Callan, A. Guijosa, and K. G. Savvidy, “Baryons and String Creation from the Five-Brane Worldvolume Action,” [hep-th/9810092](#).
- [396] E. Witten, “D-branes and K theory,” *JHEP* **12** (1998) 019, [hep-th/9810188](#).
- [397] M. Alishahiha, “(0,2) Theory and String Baryon in M Theory on $AdS_7 \times S^4$,” [hep-th/9811042](#).
- [398] B. Craps, J. Gomis, D. Mateos, and A. V. Proeyen, “BPS Solutions of a D5-Brane Worldvolume in a D3-Brane Background from Superalgebras,” [hep-th/9901060](#).

- [399] C. G. Callan, A. Guijosa, K. G. Savvidy, and O. Tafjord, “Baryons and Flux Tubes in Confining Gauge Theories from Brane Actions,” [hep-th/9902197](#).
- [400] R. R. Metsaev and A. A. Tseytlin, “Supersymmetric D3-brane action in $AdS(5) \times S(5)$,” *Phys. Lett.* **B436** (1998) 281, [hep-th/9806095](#).
- [401] P. Claus, “Super M-brane actions in $AdS_4 \times S^7$ and $AdS_7 \times S^4$,” *Phys. Rev.* **D59** (1999) 066003, [hep-th/9809045](#).
- [402] A. Bilal and C.-S. Chu, “D3-brane(s) in $AdS_5 \times S^5$ and N=4, N=2, N=1 SYM,” *Nucl. Phys.* **B547** (1999) 179, [hep-th/9810195](#).
- [403] P. Pasti, D. Sorokin, and M. Tonin, “On gauge fixed superbrane actions in AdS superbackgrounds,” *Phys. Lett.* **B447** (1999) 251, [hep-th/9809213](#).
- [404] A. Hanany and E. Witten, “Type IIB superstrings, BPS monopoles, and three-dimensional gauge dynamics,” *Nucl. Phys.* **B492** (1997) 152–190, [hep-th/9611230](#).
- [405] C. P. Bachas, M. R. Douglas, and M. B. Green, “Anomalous Creation of Branes,” *JHEP* **07** (1997) 002, [hep-th/9705074](#).
- [406] U. Danielsson, G. Ferretti, and I. R. Klebanov, “Creation of fundamental strings by crossing D-branes,” *Phys. Rev. Lett.* **79** (1997) 1984–1987, [hep-th/9705084](#).
- [407] K. Dasgupta and S. Mukhi, “Brane constructions, fractional branes and Anti-de Sitter domain walls,” [hep-th/9904131](#).
- [408] T. Banks and M. B. Green, “Nonperturbative Effects in AdS in Five-Dimensions $\times S^5$ String Theory and $d = 4$ SUSY Yang-Mills,” *JHEP* **05** (1998) 002, [hep-th/9804170](#).
- [409] C.-S. Chu, P.-M. Ho, and Y.-Y. Wu, “D Instanton in AdS_5 and Instanton in SYM_4 ,” *Nucl. Phys.* **B541** (1999) 179, [hep-th/9806103](#).
- [410] I. I. Kogan and G. Luzon, “D instantons on the boundary,” *Nucl. Phys.* **B539** (1999) 121, [hep-th/9806197](#).
- [411] M. Bianchi, M. B. Green, S. Kovacs, and G. Rossi, “Instantons in Supersymmetric Yang-Mills and D Instantons in IIB Superstring Theory,” *JHEP* **08** (1998) 013, [hep-th/9807033](#).
- [412] J. H. Brodie and M. Gutperle, “String corrections to four point functions in the AdS / CFT correspondence,” *Phys. Lett.* **B445** (1999) 296, [hep-th/9809067](#).
- [413] V. Balasubramanian, P. Kraus, A. Lawrence, and S. P. Trivedi, “Holographic Probes of anti-de Sitter Space-Times,” [hep-th/9808017](#).
- [414] N. Dorey, V. V. Khoze, M. P. Mattis, and S. Vandoren, “Yang-Mills instantons in the large N limit and the AdS / CFT correspondence,” *Phys. Lett.* **B442** (1998) 145, [hep-th/9808157](#).
- [415] N. Dorey, T. J. Hollowood, V. V. Khoze, M. P. Mattis, and S. Vandoren, “Multi-instanton calculus and the AdS / CFT correspondence in N=4 superconformal field theory,” [hep-th/9901128](#).
- [416] M. B. Green and M. Gutperle, “Effects of D instantons,” *Nucl. Phys.* **B498** (1997) 195, [hep-th/9701093](#).
- [417] M. B. Green, M. Gutperle, and H. hyun Kwon, “Sixteen fermion and related terms in M theory on T^2 ,” *Phys. Lett.* **B421** (1998) 149–161, [hep-th/9710151](#).
- [418] O. Aharony, S. Kachru and E. Silverstein, unpublished, presented by O. Aharony at the ITP program on Dualities in String Theory, April 1998, and at Strings ’98, June 1998, <http://www.itp.ucsb.edu/online/strings98/aharony>.
- [419] A. Karch, D. Lust, and A. Miemiec, “New N=1 superconformal field theories and their supergravity description,” [hep-th/9901041](#).
- [420] S. Nojiri and S. D. Odintsov, “Two boundaries AdS / CFT correspondence in dilatonic gravity,” *Phys. Lett.* **B449** (1999) 39, [hep-th/9812017](#).

- [421] A. Kehagias and K. Sfetsos, “On running couplings in gauge theories from type IIB supergravity,” [hep-th/9902125](#).
- [422] S. S. Gubser, “Dilaton driven confinement,” [hep-th/9902155](#).
- [423] L. Girardello, M. Petrini, M. Porrati, and A. Zaffaroni, “Confinement and condensates without fine tuning in supergravity duals of gauge theories,” [hep-th/9903026](#).
- [424] H. Liu and A. A. Tseytlin, “D3-brane D instanton configuration and N=4 super YM theory in constant selfdual background,” [hep-th/9903091](#).
- [425] A. Kehagias and K. Sfetsos, “On asymptotic freedom and confinement from type IIB supergravity,” [hep-th/9903109](#).
- [426] N. R. Constable and R. C. Myers, “Exotic scalar states in the AdS/CFT correspondence,” [hep-th/9905081](#).
- [427] V. Balasubramanian, P. Kraus, and A. Lawrence, “Bulk vs Boundary Dynamics in anti-de Sitter Space-Time,” *Phys. Rev.* **D59** (1999) 046003, [hep-th/9805171](#).
- [428] E. T. Akhmedov, “A Remark on the AdS / CFT correspondence and the renormalization group flow,” *Phys. Lett.* **B442** (1998) 152, [hep-th/9806217](#).
- [429] E. Alvarez and C. Gomez, “Geometric Holography, the Renormalization Group and the c Theorem,” *Nucl. Phys.* **B541** (1999) 441, [hep-th/9807226](#).
- [430] A. Gorsky, “Integrability of the RG flows and the bulk / boundary correspondence,” [hep-th/9812250](#).
- [431] M. Porrati and A. Starinets, “RG fixed points in supergravity duals of 4-D field theory and asymptotically AdS spaces,” [hep-th/9903085](#).
- [432] V. Balasubramanian and P. Kraus, “Space-time and the holographic renormalization group,” [hep-th/9903190](#).
- [433] R. Donagi and E. Witten, “Supersymmetric Yang-Mills theory and integrable systems,” *Nucl. Phys.* **B460** (1996) 299–334, [hep-th/9510101](#).
- [434] M. R. Douglas and S. H. Shenker, “Dynamics of SU(N) supersymmetric gauge theory,” *Nucl. Phys.* **B447** (1995) 271–296, [hep-th/9503163](#).
- [435] P. C. Argyres and M. R. Douglas, “New Phenomena in SU(3) Supersymmetric Gauge Theory,” *Nucl. Phys.* **B448** (1995) 93–126, [hep-th/9505062](#).
- [436] P. C. Argyres, M. R. Plesser, N. Seiberg, and E. Witten, “New N=2 Superconformal Field Theories in Four Dimensions,” *Nucl. Phys.* **B461** (1996) 71–84, [hep-th/9511154](#).
- [437] T. Eguchi, K. Hori, K. Ito, and S.-K. Yang, “Study of N=2 superconformal field theories in four- dimensions,” *Nucl. Phys.* **B471** (1996) 430–444, [hep-th/9603002](#).
- [438] T. Banks and L. J. Dixon, “Constraints on String Vacua with Space-Time Supersymmetry,” *Nucl. Phys.* **B307** (1988) 93–108.
- [439] C. N. Pope and N. P. Warner, “Two new classes of compactifications of $d = 11$ supergravity,” *Class. Quant. Grav.* **2** (1985) L1.
- [440] K. Pilch, private communication, June 1999.
- [441] J. D. Brown and M. Henneaux, “Central Charges in the Canonical Realization of Asymptotic Symmetries: an Example from Three-Dimensional Gravity,” *Commun. Math. Phys.* **104** (1986) 207.
- [442] M. Banados, C. Teitelboim, and J. Zanelli, “The Black hole in Three-Dimensional Space-Time,” *Phys. Rev. Lett.* **69** (1992) 1849–1851, [hep-th/9204099](#).
- [443] M. Banados, C. T. M. Henneaux, and J. Zanelli, “Geometry of the (2 + 1) Black Hole,” *Phys. Rev.* **D48** (1993) 1506–1525, [gr-qc/9302012](#).

- [444] O. Coussaert and M. Henneaux, “Supersymmetry of the (2 + 1) Black Holes,” *Phys. Rev. Lett.* **72** (1994) 183–186, [hep-th/9310194](#).
- [445] J. L. Cardy, “Operator content of two-dimensional conformally invariant theories,” *Nucl. Phys.* **B270** (1986) 186.
- [446] A. Strominger, “Black hole entropy from near horizon microstates,” *JHEP* **02** (1998) 009, [hep-th/9712251](#).
- [447] J. de Boer, “Six-dimensional supergravity on $S^3 \times AdS_3$ and 2-D conformal field theory,” [hep-th/9806104](#).
- [448] D. Youm, “Black holes and solitons in string theory,” [hep-th/9710046](#).
- [449] L. Andrianopoli, R. D’Auria, and S. Ferrara, “U Duality and Central Charges in Various Dimensions Revisited,” *Int. J. Mod. Phys.* **A13** (1998) 431, [hep-th/9612105](#).
- [450] S. Ferrara, R. Kallosh, and A. Strominger, “N=2 extremal black holes,” *Phys. Rev.* **D52** (1995) 5412–5416, [hep-th/9508072](#).
- [451] S. Ferrara and R. Kallosh, “Supersymmetry and attractors,” *Phys. Rev.* **D54** (1996) 1514–1524, [hep-th/9602136](#).
- [452] S. Ferrara and R. Kallosh, “Universality of supersymmetric attractors,” *Phys. Rev.* **D54** (1996) 1525–1534, [hep-th/9603090](#).
- [453] J. M. Maldacena, “Black holes in string theory,” [hep-th/9607235](#).
- [454] J. C. Breckenridge, R. C. Myers, A. W. Peet, and C. Vafa, “D-branes and Spinning Black Holes,” *Phys. Lett.* **B391** (1997) 93, [hep-th/9602065](#).
- [455] C. Vafa and E. Witten, “A Strong coupling test of S duality,” *Nucl. Phys.* **B431** (1994) 3–77, [hep-th/9408074](#).
- [456] C. Vafa, “Instantons on D-branes,” *Nucl. Phys.* **B463** (1996) 435–442, [hep-th/9512078](#).
- [457] R. Dijkgraaf, “Instanton Strings and HyperKahler Geometry,” *Nucl. Phys.* **B543** (1999) 545, [hep-th/9810210](#).
- [458] G. ’t Hooft (ed.) *et. al.*, “Recent Development in Gauge Theories,”. Proceedings, NATO Advanced Study Institute, Cargese, France, August 26 - September 8, 1979, New York, USA: Plenum (1980) 438 pp. (NATO Advanced Study Institutes Series: Series B, Physics, 59).
- [459] M. Bershadsky, C. Vafa, and V. Sadov, “D-Branes and Topological Field Theories,” *Nucl. Phys.* **B463** (1996) 420–434, [hep-th/9511222](#).
- [460] J. Maldacena, G. Moore, and A. Strominger, “Counting BPS Black Holes in Toroidal Type-II String Theory,” [hep-th/9903163](#).
- [461] E. Witten, “On the conformal field theory of the Higgs branch,” *JHEP* **07** (1997) 003, [hep-th/9707093](#).
- [462] M. S. Costa, “Black hole dynamics from instanton strings,” *JHEP* **11** (1998) 007, [hep-th/9807185](#).
- [463] S. F. Hassan and S. R. Wadia, “Gauge theory description of D-brane black holes: Emergence of the effective SCFT and Hawking radiation,” *Nucl. Phys.* **B526** (1998) 311, [hep-th/9712213](#).
- [464] S. F. Hassan and S. R. Wadia, “D-brane black holes: Large N limit and the effective string description,” *Phys. Lett.* **B402** (1997) 43–52, [hep-th/9703163](#).
- [465] K. Behrndt, I. Brunner, and I. Gaida, “AdS(3) gravity and conformal field theories,” *Nucl. Phys.* **B546** (1999) 65, [hep-th/9806195](#).
- [466] R. Dijkgraaf, G. Moore, E. Verlinde, and H. Verlinde, “Elliptic genera of symmetric products and second quantized strings,” *Commun. Math. Phys.* **185** (1997) 197, [hep-th/9608096](#).
- [467] R. Dijkgraaf, E. Verlinde, and H. Verlinde, “BPS spectrum of the five-brane and black hole entropy,” *Nucl. Phys.* **B486** (1997) 77–88, [hep-th/9603126](#).

- [468] J. M. Maldacena and L. Susskind, “D-branes and fat black holes,” *Nucl. Phys.* **B475** (1996) 679–690, [hep-th/9604042](#).
- [469] J. Preskill, P. Schwarz, A. Shapere, S. Trivedi, and F. Wilczek, “Limitations on the Statistical Description of Black Holes,” *Mod. Phys. Lett.* **A6** (1991) 2353–2362.
- [470] M. Cvetič and F. Larsen, “Near horizon geometry of rotating black holes in five- dimensions,” *Nucl. Phys.* **B531** (1998) 239, [hep-th/9805097](#).
- [471] M. Cvetič and D. Youm, “General Rotating Five-Dimensional Black Holes of Toroidally Compactified Heterotic String,” *Nucl. Phys.* **B476** (1996) 118–132, [hep-th/9603100](#).
- [472] M. Cvetič and F. Larsen, “Microstates of four-dimensional rotating black holes from near horizon geometry,” [hep-th/9805146](#).
- [473] J. C. Breckenridge, D. A. Lowe, R. C. Myers, A. W. Peet, A. Strominger, and C. Vafa, “Macroscopic and Microscopic Entropy of Near Extremal Spinning Black Holes,” *Phys. Lett.* **B381** (1996) 423–426, [hep-th/9603078](#).
- [474] N. Kaloper, “Entropy count for extremal three-dimensional black strings,” *Phys. Lett.* **B434** (1998) 285–293, [hep-th/9804062](#).
- [475] W. Lerche, C. Vafa, and N. P. Warner, “Chiral Rings in $N = 2$ Superconformal Theories,” *Nucl. Phys.* **B324** (1989) 427.
- [476] J. de Boer, “Large N elliptic genus and AdS / CFT correspondence,” [hep-th/9812240](#).
- [477] M. Gunaydin, G. Sierra, and P. K. Townsend, “The Unitary Supermultiplets of the $d = 3$ Anti-de Sitter and $d = 2$ Conformal Superalgebras,” *Nucl. Phys.* **B274** (1986) 429.
- [478] E. Witten, “Constraints on Supersymmetry Breaking,” *Nucl. Phys.* **B202** (1982) 253.
- [479] S. Deger, A. Kaya, E. Sezgin, and P. Sundell, “Spectrum of $D = 6$, $N=4b$ supergravity on AdS in three- dimensions $\times S^3$,” *Nucl. Phys.* **B536** (1998) 110, [hep-th/9804166](#).
- [480] F. Larsen, “The Perturbation spectrum of black holes in $N=8$ supergravity,” *Nucl. Phys.* **B536** (1998) 258, [hep-th/9805208](#).
- [481] A. Achúcarro and P. K. Townsend, “A Chern-Simons Action for Three-Dimensional Anti-de Sitter Supergravity Theories,” *Phys. Lett.* **B180** (1986) 89.
- [482] P. S. Howe, J. M. Izquierdo, G. Papadopoulos, and P. K. Townsend, “New supergravities with central charges and killing spinors in $(2+1)$ -dimensions,” *Nucl. Phys.* **B467** (1996) 183–214, [hep-th/9505032](#).
- [483] E. Witten, “ $(2 + 1)$ -Dimensional Gravity as an Exactly Soluble System,” *Nucl. Phys.* **B311** (1988) 46.
- [484] E. Witten, “Topology Changing Amplitudes in $(2 + 1)$ -dimensional Gravity,” *Nucl. Phys.* **B323** (1989) 113.
- [485] O. Coussaert, M. Henneaux, and P. van Driel, “The Asymptotic Dynamics of Three-Dimensional Einstein Gravity with a Negative Cosmological Constant,” *Class. Quant. Grav.* **12** (1995) 2961–2966, [gr-qc/9506019](#).
- [486] M. Banados, K. Bautier, O. Coussaert, M. Henneaux, and M. Ortiz, “Anti-de Sitter / CFT Correspondence in Three-Dimensional Supergravity,” *Phys. Rev.* **D58** (1998) 085020, [hep-th/9805165](#).
- [487] M. Banados, T. Brotz, and M. E. Ortiz, “Boundary Dynamics and the Statistical Mechanics of the $(2 + 1)$ -Dimensional Black Hole,” [hep-th/9802076](#).
- [488] M. Banados, “Global Charges in Chern-Simons Field Theory and the $(2 + 1)$ Black Hole,” *Phys. Rev.* **D52** (1996) 5816, [hep-th/9405171](#).
- [489] E. J. Martinec, “Matrix models of AdS gravity,” [hep-th/9804111](#).

- [490] F. Larsen and E. Martinec, “U(1) charges and moduli in the D1 - D5 system,” [hep-th/9905064](#).
- [491] A. Jevicki and S. Ramgoolam, “Noncommutative gravity from the AdS / CFT correspondence,” *JHEP* **04** (1999) 032, [hep-th/9902059](#).
- [492] Z. Chang, “Holography based on noncommutative geometry and the AdS / CFT correspondence,” [hep-th/9904101](#).
- [493] C. Vafa, “Puzzles at large N,” [hep-th/9804172](#).
- [494] L. J. Romans, “Selfduality for Interacting Fields: Covariant Field Equations for Six-Dimensional Chiral Supergravities,” *Nucl. Phys.* **B276** (1986) 71.
- [495] L. Andrianopoli, R. D’Auria, S. Ferrara, and M. A. Lledo, “Horizon geometry, duality and fixed scalars in six- dimensions,” *Nucl. Phys.* **B528** (1998) 218, [hep-th/9802147](#).
- [496] J. Balog, L. O’Raifeartaigh, P. Forgacs, and A. Wipf, “Consistency of string propagation on curved space-times: an SU(1,1) based counterexample,” *Nucl. Phys.* **B325** (1989) 225.
- [497] P. M. S. Petropoulos, “Comments on SU(1,1) string theory,” *Phys. Lett.* **B236** (1990) 151.
- [498] N. Mohammedi, “On the unitarity of string propagation on SU(1,1),” *Int. J. Mod. Phys.* **A5** (1990) 3201–3212.
- [499] I. Bars and D. Nemeschansky, “String propagation in backgrounds with curved space-time,” *Nucl. Phys.* **B348** (1991) 89–107.
- [500] S. Hwang, “No ghost theorem for SU(1,1) string theories,” *Nucl. Phys.* **B354** (1991) 100–112.
- [501] M. Henningson and S. Hwang, “The Unitarity of SU(1,1) fermionic strings,” *Phys. Lett.* **B258** (1991) 341–345.
- [502] M. Henningson, S. Hwang, P. Roberts, and B. Sundborg, “Modular invariance of SU(1,1) strings,” *Phys. Lett.* **B267** (1991) 350–355.
- [503] S. Hwang, “Cosets as gauge slices in SU(1,1) strings,” *Phys. Lett.* **B276** (1992) 451–454, [hep-th/9110039](#).
- [504] I. Bars, “Ghost - free spectrum of a quantum string in SL(2,R) curved space-time,” *Phys. Rev.* **D53** (1996) 3308–3323, [hep-th/9503205](#).
- [505] I. Bars, “Solution of the SL(2,R) string in curved space-time,” [hep-th/9511187](#).
- [506] Y. Satoh, “Ghost - free and modular invariant spectra of a string in SL(2,R) and three-dimensional black hole geometry,” *Nucl. Phys.* **B513** (1998) 213, [hep-th/9705208](#).
- [507] J. M. Evans, M. R. Gaberdiel, and M. J. Perry, “The No - ghost theorem and strings on AdS(3),” [hep-th/9812252](#).
- [508] J. M. Evans, M. R. Gaberdiel, and M. J. Perry, “The no ghost theorem for AdS(3) and the stringy exclusion principle,” *Nucl. Phys.* **B535** (1998) 152, [hep-th/9806024](#).
- [509] A. Giveon, D. Kutasov, and N. Seiberg, “Comments on string theory on AdS₃,” *Adv. Theor. Math. Phys.* **2** (1998) 733–780, [hep-th/9806194](#).
- [510] J. de Boer, H. Ooguri, H. Robins, and J. Tannenhauser, “String theory on AdS₃,” *JHEP* **12** (1998) 026, [hep-th/9812046](#).
- [511] D. Kutasov and N. Seiberg, “More Comments on String Theory on AdS₃,” [hep-th/9903219](#).
- [512] I. Pesando, “On the quantization of the GS type IIB superstring action on AdS(3) x S(3) with NSNS flux,” [hep-th/9903086](#).
- [513] O. Andreev, “On affine Lie superalgebras, AdS(3) / CFT correspondence and world sheets for world sheets,” [hep-th/9901118](#).
- [514] O. Andreev, “Unitary representations of some infinite dimensional Lie algebras motivated by string theory on AdS(3),” [hep-th/9905002](#).

- [515] K. Ito, “Extended superconformal algebras on AdS(3),” *Phys. Lett.* **B449** (1999) 48, [hep-th/9811002](#).
- [516] K. Hosomichi and Y. Sugawara, “Hilbert space of space-time SCFT in AdS(3) superstring and T^{4kp}/S_{kp} SCFT,” *JHEP* **01** (1999) 013, [hep-th/9812100](#).
- [517] J. de Boer and S. L. Shatashvili, “Two-dimensional conformal field theories on AdS(2d+1) backgrounds,” [hep-th/9905032](#).
- [518] M. J. O’Loughlin and S. Randjbar-Daemi, “AdS(3) x R as a target space for the (2,1) string theory,” *Nucl. Phys.* **B543** (1999) 170, [hep-th/9807208](#).
- [519] S. Stanciu, “D-branes in an AdS(3) background,” [hep-th/9901122](#).
- [520] A. Giveon and M. Rocek, “Supersymmetric string vacua on AdS(3) x N,” *JHEP* **04** (1999) 019, [hep-th/9904024](#).
- [521] D. Berenstein and R. G. Leigh, “Space-time supersymmetry in AdS(3) backgrounds,” [hep-th/9904040](#).
- [522] I. Pesando, “The GS type IIB superstring action on $AdS_3 \times S^3 \times T^4$,” *JHEP* **02** (1999) 007, [hep-th/9809145](#).
- [523] J. Rahmfeld and A. Rajaraman, “The GS string action on AdS(3) x S(3) with Ramond-Ramond charge,” [hep-th/9809164](#).
- [524] J. Park and S.-J. Rey, “Green-Schwarz superstring on $AdS_3 \times S^3$,” *JHEP* **01** (1999) 001, [hep-th/9812062](#).
- [525] N. Berkovits, C. Vafa, and E. Witten, “Conformal Field Theory of AdS Background with Ramond-Ramond Flux,” [hep-th/9902098](#).
- [526] M. Bershadsky, S. Zhukov, and A. Vaintrob, “PSL(n|n) sigma model as a conformal field theory,” [hep-th/9902180](#).
- [527] M. Yu and B. Zhang, “Light cone gauge quantization of string theories on AdS(3) space,” [hep-th/9812216](#).
- [528] D. Kutasov, F. Larsen, and R. G. Leigh, “String theory in magnetic monopole backgrounds,” [hep-th/9812027](#).
- [529] M. J. Duff, H. Lu, and C. N. Pope, “ $AdS_3 \times S^3$ (un)twisted and squashed, and an O(2,2,Z) multiplet of dyonic strings,” *Nucl. Phys.* **B544** (1999) 145, [hep-th/9807173](#).
- [530] Y. Sugawara, “N = (0,4) quiver SCFT(2) and supergravity on $AdS_3 \times S^2$,” [hep-th/9903120](#).
- [531] K. Behrndt, I. Brunner, and I. Gaida, “Entropy and conformal field theories of AdS(3) models,” *Phys. Lett.* **B432** (1998) 310–316, [hep-th/9804159](#).
- [532] S. Yamaguchi, Y. Ishimoto, and K. Sugiyama, “AdS(3) / CFT(2) correspondence and space-time N=3 superconformal algebra,” *JHEP* **02** (1999) 026, [hep-th/9902079](#).
- [533] V. Balasubramanian and F. Larsen, “Near horizon geometry and black holes in four dimensions,” *Nucl. Phys.* **B528** (1998) 229, [hep-th/9802198](#).
- [534] J. Maldacena, A. Strominger, and E. Witten, “Black hole entropy in M theory,” *JHEP* **12** (1997) 002, [hep-th/9711053](#).
- [535] R. Minasian, G. Moore, and D. Tsimpis, “Calabi-Yau black holes and (0,4) sigma models,” [hep-th/9904217](#).
- [536] A. Fujii, R. Kemmoku, and S. Mizoguchi, “D = 5 simple supergravity on $AdS_3 \times S^2$ and N=4 superconformal field theory,” [hep-th/9811147](#).
- [537] H. J. Boonstra, B. Peeters, and K. Skenderis, “Brane Intersections, Anti-de Sitter Space-Times and Dual Superconformal Theories,” *Nucl. Phys.* **B533** (1998) 127, [hep-th/9803231](#).
- [538] S. Elitzur, O. Feinerman, A. Giveon, and D. Tsabar, “String theory on $AdS_3 \times S^3 \times S^3 \times S^1$,” [hep-th/9811245](#).

- [539] J. de Boer, A. Pasquinucci, and K. Skenderis, “AdS / CFT dualities involving large 2-D N=4 superconformal symmetry,” [hep-th/9904073](#).
- [540] C. V. Johnson, “More Superstrings from Supergravity,” *Nucl. Phys.* **B537** (1999) 129–143, [hep-th/9805047](#).
- [541] J. L. F. Barbon, J. Manes, and M. A. Vazquez-Mozo, “Large N limit of Extremal Non-supersymmetric Black Holes,” *Nucl. Phys.* **B536** (1998) 279–300, [hep-th/9805154](#).
- [542] Y. Oz and D. Youm, “The D1 - D5 brane system in type I string theory,” *Phys. Lett.* **B451** (1999) 336, [hep-th/9901088](#).
- [543] M. R. Douglas, “Gauge Fields and D-Branes,” *J.Geom.Phys.* **28** (1998) 255, [hep-th/9604198](#).
- [544] E. Witten, “Sigma Models and the ADHM Construction of Instantons,” *J. Geom. Phys.* **15** (1995) 215, [hep-th/9410052](#).
- [545] K. Hosomichi and Y. Sugawara, “Multistrings on $AdS_3 \times S^3$ from matrix string theory,” [hep-th/9905004](#).
- [546] P. Oh and M.-I. Park, “Symplectic reduction and symmetry algebra in boundary Chern-Simons theory,” [hep-th/9805178](#).
- [547] S. Carlip, “What we don’t know about BTZ Black Hole Entropy,” *Class. Quant. Grav.* **15** (1998) 3609, [hep-th/9806026](#).
- [548] M. Banados, “Three-dimensional quantum geometry and black holes,” [hep-th/9901148](#).
- [549] Y. S. Myung, “Entropy problem in the AdS(3) / CFT correspondence,” [hep-th/9809172](#).
- [550] K. Behrndt, “Orbifolds of AdS(3) and fixpoints of the CFT,” [hep-th/9812169](#).
- [551] R. Emparan and I. Sachs, “Quantization of AdS(3) black holes in external fields,” *Phys. Rev. Lett.* **81** (1998) 2408–2411, [hep-th/9806122](#).
- [552] T. Lee, “The Entropy of the BTZ black hole and AdS / CFT correspondence,” [hep-th/9806113](#).
- [553] J. Navarro-Salas and P. Navarro, “A Note on Einstein gravity on AdS(3) and boundary conformal field theory,” *Phys. Lett.* **B439** (1998) 262, [hep-th/9807019](#).
- [554] J. Navarro-Salas and P. Navarro, “Virasoro orbits, AdS(3) quantum gravity and entropy,” [hep-th/9903248](#).
- [555] T. Nakatsu, H. Umetsu, and N. Yokoi, “Three-dimensional black holes and Liouville field theory,” [hep-th/9903259](#).
- [556] L. Chekhov, “AdS(3) / CFT(2) correspondence at finite temperature,” [hep-th/9903209](#).
- [557] O. Chandia, R. Troncoso, and J. Zanelli, “Dynamical content of Chern-Simons supergravity,” [hep-th/9903204](#).
- [558] M. Banados, “Twisted sectors in three-dimensional gravity,” [hep-th/9903178](#).
- [559] T. Brotz, M. Ortiz, and A. Ritz, “On modular invariance and 3-D gravitational instantons,” [hep-th/9903222](#).
- [560] D. H. Park and S. H. Yang, “Geodesic motions in (2+1)-dimensional charged black holes,” [gr-qc/9901027](#).
- [561] M. Banados and M. E. Ortiz, “The Central Charge in Three-Dimensional anti-de Sitter Space,” [hep-th/9806089](#).
- [562] Y. Yoshida and T. Kubota, “Asymptotic symmetry and general black hole solution in AdS(3) gravity,” [hep-th/9903240](#).
- [563] J.-H. Cho and S. Nam, “AdS(3) black hole entropy and the spectral flow on the horizon,” [hep-th/9903058](#).
- [564] S. Mano, “AdS(3) gravitational instantons from conformal field theory,” [hep-th/9903065](#).

- [565] M. Banados, “Notes on black holes and three-dimensional gravity,” [hep-th/9903244](#).
- [566] D. Birmingham, C. Kennedy, S. Sen, and A. Wilkins, “Geometrical finiteness, holography, and the BTZ black hole,” [hep-th/9812206](#).
- [567] S. Hyun, W. T. Kim, and J. Lee, “Statistical entropy and AdS / CFT correspondence in BTZ black holes,” *Phys. Rev.* **D59** (1999) 084020, [hep-th/9811005](#).
- [568] S. Carlip, “The (2+1)-Dimensional Black Hole,” *Class. Quant. Grav.* **12** (1995) 2853–2880, [gr-qc/9506079](#).
- [569] J. R. David, “Anti-de Sitter gravity associated with the supergroup $SU(1,1|2) \times SU(1,1|2)$,” [hep-th/9904068](#).
- [570] R. Gregory and R. Laflamme, “The Instability of Charged Black Strings and p -Branes,” *Nucl. Phys.* **B428** (1994) 399–434, [hep-th/9404071](#).
- [571] R. Gregory and R. Laflamme, “Black Strings and p -Branes are Unstable,” *Phys. Rev. Lett.* **70** (1993) 2837, [hep-th/9301052](#).
- [572] G. T. Horowitz, J. M. Maldacena, and A. Strominger, “Nonextremal black hole microstates and U duality,” *Phys. Lett.* **B383** (1996) 151–159, [hep-th/9603109](#).
- [573] S. S. Gubser and I. R. Klebanov, “Emission of charged particles from four-dimensional and five-dimensional black holes,” *Nucl. Phys.* **B482** (1996) 173–186, [hep-th/9608108](#).
- [574] J. Maldacena and A. Strominger, “Universal low-energy dynamics for rotating black holes,” *Phys. Rev.* **D56** (1997) 4975–4983, [hep-th/9702015](#).
- [575] S. R. Das and S. D. Mathur, “Interactions involving D-branes,” *Nucl. Phys.* **B482** (1996) 153–172, [hep-th/9607149](#).
- [576] S. Cecotti, “ $N=2$ Landau-Ginzburg vs. Calabi-Yau Sigma Models: Nonperturbative Aspects,” *Int. J. Mod. Phys.* **A6** (1991) 1749–1814.
- [577] S. S. Gubser and I. R. Klebanov, “Four-dimensional grey body factors and the effective string,” *Phys. Rev. Lett.* **77** (1996) 4491–4494, [hep-th/9609076](#).
- [578] C. G. Callan, S. S. Gubser, I. R. Klebanov, and A. A. Tseytlin, “Absorption of Fixed Scalars and the D-Brane Approach to Black Holes,” *Nucl. Phys.* **B489** (1997) 65–94, [hep-th/9610172](#).
- [579] I. R. Klebanov and M. Krasnitz, “Fixed scalar gray body factors in five-dimensions and four-dimensions,” *Phys. Rev.* **D55** (1997) 3250–3254, [hep-th/9612051](#).
- [580] M. Krasnitz and I. R. Klebanov, “Testing effective string models of black holes with fixed scalars,” *Phys. Rev.* **D56** (1997) 2173–2179, [hep-th/9703216](#).
- [581] S. D. Mathur, “Absorption of angular momentum by black holes and D- branes,” *Nucl. Phys.* **B514** (1998) 204, [hep-th/9704156](#).
- [582] I. R. Klebanov, A. Rajaraman, and A. A. Tseytlin, “Intermediate scalars and the effective string model of black holes,” *Nucl. Phys.* **B503** (1997) 157, [hep-th/9704112](#).
- [583] D. Birmingham, I. Sachs, and S. Sen, “Three-Dimensional Black Holes and String Theory,” *Phys. Lett.* **B413** (1997) 281, [hep-th/9707188](#).
- [584] K. Hosomichi, “Fermion Emission from Five-Dimensional Black Holes,” *Nucl. Phys.* **B524** (1998) 312, [hep-th/9711072](#).
- [585] J. R. David, G. Mandal, and S. R. Wadia, “Absorption and Hawking radiation of minimal and fixed scalars, and AdS / CFT correspondence,” [hep-th/9808168](#).
- [586] J. Y. Kim, H. W. Lee, and Y. S. Myung, “Origin of logarithmic corrections in three-dimensional Anti-de Sitter space,” [hep-th/9812016](#).
- [587] M. Cvetič and F. Larsen, “Grey body factors for rotating black holes in four- dimensions,” *Nucl. Phys.* **B506** (1997) 107, [hep-th/9706071](#).

- [588] M. Cvetič and F. Larsen, “General rotating black holes in string theory: Grey body factors and event horizons,” *Phys. Rev.* **D56** (1997) 4994–5007, [hep-th/9705192](#).
- [589] M. Cvetič and F. Larsen, “Black hole horizons and the thermodynamics of strings,” *Nucl. Phys. Proc. Suppl.* **62** (1998) 443, [hep-th/9708090](#).
- [590] M. Cvetič and F. Larsen, “Greybody factors for black holes in four-dimensions: Particles with spin,” *Phys. Rev.* **D57** (1998) 6297–6310, [hep-th/9712118](#).
- [591] H. W. Lee, N. J. Kim, and Y. S. Myung, “Dilaton test of holography between $AdS_3 \times S^3$ and 5-D black hole,” [hep-th/9805050](#).
- [592] H. J. W. Müller-Kirsten, N. Ohta, and J.-G. Zhou, “AdS(3) / CFT correspondence, Poincaré vacuum state and grey body factors in BTZ black holes,” *Phys. Lett.* **B445** (1999) 287, [hep-th/9809193](#).
- [593] N. Ohta and J.-G. Zhou, “Thermalization of Poincaré vacuum state and fermion emission from AdS(3) black holes in bulk boundary correspondence,” *JHEP* **12** (1998) 023, [hep-th/9811057](#).
- [594] E. Keski-Vakkuri, “Bulk and boundary dynamics in BTZ black holes,” *Phys. Rev.* **D59** (1999) 104001, [hep-th/9808037](#).
- [595] H. W. Lee, Y. S. Myung, and J. Y. Kim, “The Role of fixed scalars in scattering off a 5-D black hole,” *Phys. Rev.* **D58** (1998) 104006, [hep-th/9708099](#).
- [596] J. Maharana and J. H. Schwarz, “Noncompact symmetries in string theory,” *Nucl. Phys.* **B390** (1993) 3–32, [hep-th/9207016](#).
- [597] A. Sen, “Strong - weak coupling duality in four-dimensional string theory,” *Int. J. Mod. Phys.* **A9** (1994) 3707–3750, [hep-th/9402002](#).
- [598] M. Cvetič and D. Youm, “Singular BPS Saturated States and Enhanced Symmetries of Four-Dimensional $N=4$ Supersymmetric String Vacua,” *Phys. Lett.* **B359** (1995) 87–92, [hep-th/9507160](#).
- [599] M. Cvetič and D. Youm, “All the Static Spherically Symmetric Black Holes of Heterotic String on a Six Torus,” *Nucl. Phys.* **B472** (1996) 249, [hep-th/9512127](#).
- [600] E. Kiritsis, “Introduction to Nonperturbative String Theory,” [hep-th/9708130](#).
- [601] O. Aharony, M. Berkooz, S. Kachru, N. Seiberg, and E. Silverstein, “Matrix Description of Interacting Theories in Six Dimensions,” *Adv.Theor.Math.Phys.* **1** (1998) 148–157, [hep-th/9707079](#).
- [602] O. Aharony, M. Berkooz, and N. Seiberg, “Light-Cone Description of (2,0) Superconformal Theories in Six Dimensions,” *Adv.Theor.Math.Phys.* **2** (1998) 119–153, [hep-th/9712117](#).
- [603] P. V. Nieuwenhuizen, “The Complete Mass Spectrum of $d = 11$ Supergravity Compactified on S^4 and a General Mass Formula for Arbitrary Cosets on M_4 ,” *Class. Quantum Grav.* **2** (1985) 1.
- [604] O. Aharony, Y. Oz, and Z. Yin, “M Theory on $AdS_p \times S^{11-p}$ and Superconformal Field Theories,” *Phys.Lett.* **B430** (1998) 87–93, [hep-th/9803051](#).
- [605] S. Minwalla, “Particles on $AdS_{4/7}$ and Primary Operators on $M_{2/5}$ Brane Worldvolumes,” *JHEP* **10** (1998) 002, [hep-th/9803053](#).
- [606] R. G. Leigh and M. Rozali, “The Large N Limit of the (2,0) Superconformal Field Theory,” *Phys.Lett.* **B431** (1998) 311–316, [hep-th/9803068](#).
- [607] E. Halyo, “Supergravity on $AdS_{4/7} \times S^{7/4}$ and M Branes,” *JHEP* **04** (1998) 011, [hep-th/9803077](#).
- [608] C. Ahn, K. Oh, and R. Tatar, “Orbifolds $AdS_7 \times S^4$ and Six Dimensional (0, 1) SCFT,” *Phys.Lett.* **B442** (1998) 109–116, [hep-th/9804093](#).

- [609] P. Horava and E. Witten, “Heterotic and type I string dynamics from eleven- dimensions,” *Nucl. Phys.* **B460** (1996) 506–524, [hep-th/9510209](#).
- [610] M. Berkooz, “A Supergravity Dual of a (1,0) Field Theory in Six Dimensions,” *Phys.Lett.* **B437** (1998) 315–317, [hep-th/9802195](#).
- [611] E. G. Gimon and C. Popescu, “The Operator Spectrum of the Six-dimensional (1,0) Theory,” [hep-th/9901048](#).
- [612] R. Corrado, B. Florea, and R. McNees, “Correlation Functions of Operators and Wilson Surfaces in the $d = 6$, (0,2) Theory in the Large N Limit,” [hep-th/9902153](#).
- [613] O. J. Ganor, “Six-dimensional tensionless strings in the large N limit,” *Nucl. Phys.* **B489** (1997) 95–121, [hep-th/9605201](#).
- [614] S. Kachru and C. Vafa, “Exact results for $N=2$ compactifications of heterotic strings,” *Nucl. Phys.* **B450** (1995) 69–89, [hep-th/9505105](#).
- [615] S. Kachru, A. Klemm, W. Lerche, P. Mayr, and C. Vafa, “Nonperturbative results on the point particle limit of $N=2$ heterotic string compactifications,” *Nucl. Phys.* **B459** (1996) 537–558, [hep-th/9508155](#).
- [616] A. Klemm, W. Lerche, P. Mayr, C. Vafa, and N. Warner, “Selfdual strings and $N=2$ supersymmetric field theory,” *Nucl. Phys.* **B477** (1996) 746–766, [hep-th/9604034](#).
- [617] K. Hori, H. Ooguri, and Y. Oz, “Strong Coupling Dynamics of Four-Dimensional $N=1$ Gauge Theories from M Theory Fivebrane,” *Adv.Theor.Math.Phys.* **1** (1997) 1–52, [hep-th/9706082](#).
- [618] E. Witten, “Branes and the Dynamics of QCD,” *Nucl. Phys.* **B507** (1997) 658–690, [hep-th/9706109](#).
- [619] L. Castellani *et. al.*, “G / H M-branes and AdS($p+2$) geometries,” *Nucl. Phys.* **B527** (1998) 142, [hep-th/9803039](#).
- [620] J. G. Russo, “Einstein spaces in five-dimensions and seven-dimensions and nonsupersymmetric gauge theories,” *Phys. Lett.* **B435** (1998) 284, [hep-th/9804209](#).
- [621] R. Kallosh and A. Rajaraman, “Vacua of M theory and string theory,” *Phys. Rev.* **D58** (1998) 125003, [hep-th/9805041](#).
- [622] C. Grojean and J. Mourad, “Superconformal 6-D (2,0) theories in superspace,” *Class. Quant. Grav.* **15** (1998) 3397, [hep-th/9807055](#).
- [623] C. Ahn, H. Kim, and H. S. Yang, “SO(2N) (0,2) SCFT and M theory on $AdS_7 \times RP^4$,” *Phys. Rev.* **D59** (1999) 106002, [hep-th/9808182](#).
- [624] P. Claus, R. Kallosh, J. Kumar, P. Townsend, and A. V. Proeyen, “Conformal theory of M2, D3, M5 and D1-branes + D5-branes,” *JHEP* **06** (1998) 004, [hep-th/9801206](#).
- [625] P. Claus and R. Kallosh, “Superisometries of the AdS x S superspace,” *JHEP* **03** (1999) 014, [hep-th/9812087](#).
- [626] H. Awata and S. Hirano, “AdS(7) / CFT(6) correspondence and matrix models of M5-branes,” [hep-th/9812218](#).
- [627] J. Gutowski and G. Papadopoulos, “AdS calibrations,” [hep-th/9902034](#).
- [628] S. Forste, “Membrany corrections to the string anti-string potential in M5-brane theory,” [hep-th/9902068](#).
- [629] A. Fayyazuddin and D. J. Smith, “Localized intersections of M5-branes and four-dimensional superconformal field theories,” *JHEP* **04** (1999) 030, [hep-th/9902210](#).
- [630] F. Bastianelli and R. Zucchini, “Bosonic quadratic actions for 11-D supergravity on AdS(7/4) x S(4/7),” [hep-th/9903161](#).
- [631] B. Biran, A. Casher, F. Englert, M. Rooman, and P. Spindel, “The Fluctuating Seven Sphere in Eleven Dimensional Supergravity,” *Phys.Lett.* **B134** (1984) 179.

- [632] L. Castellani, R. D’Auria, P. Fre, K. Pilch, and P. V. Nieuwenhuizen, “The Bosonic Mass Formula for Freund-Rubin Solutions of $d = 11$ Supergravity General Coset Manifolds,” *Class. Quantum Grav.* **1** (1984) 339.
- [633] O. J. Ganor and S. Sethi, “New perspectives on Yang-Mills theories with sixteen supersymmetries,” *JHEP* **01** (1998) 007, [hep-th/9712071](#).
- [634] S. Sethi, “A Relation between $N=8$ gauge theories in three-dimensions,” *JHEP* **11** (1998) 003, [hep-th/9809162](#).
- [635] M. Berkooz and A. Kapustin, “New IR dualities in supersymmetric gauge theory in three-dimensions,” *JHEP* **02** (1999) 009, [hep-th/9810257](#).
- [636] R. Entin and J. Gomis, “Spectrum of Chiral Operators in Strongly Coupled Gauge Theories,” *Phys. Rev.* **D58** (1998) 105008, [hep-th/9804060](#).
- [637] S. Ferrara, A. Kehagias, H. Partouche, and A. Zaffaroni, “Membranes and five-branes with lower supersymmetry and their AdS supergravity duals,” *Phys. Lett.* **B431** (1998) 42–48, [hep-th/9803109](#).
- [638] J. Gomis, “Anti-de Sitter geometry and strongly coupled gauge theories,” *Phys. Lett.* **B435** (1998) 299, [hep-th/9803119](#).
- [639] C. Ahn, K. Oh, and R. Tatar, “Branes, orbifolds and the three-dimensional $N=2$ SCFT in the large N limit,” *JHEP* **11** (1998) 024, [hep-th/9806041](#).
- [640] B. de Wit, K. Peeters, J. Plefka, and A. Sevrin, “The M theory two-brane in $AdS_4 \times S^7$ and $AdS_7 \times S^4$,” *Phys. Lett.* **B443** (1998) 153, [hep-th/9808052](#).
- [641] K. Oh and R. Tatar, “Three-dimensional SCFT from M2-branes at conifold singularities,” *JHEP* **02** (1999) 025, [hep-th/9810244](#).
- [642] C. Ahn, H. Kim, B.-H. Lee, and H. S. Yang, “ $N=8$ SCFT and M theory on $AdS_4 \times RP^7$,” [hep-th/9811010](#).
- [643] M. J. Duff and J. T. Liu, “Anti-de Sitter black holes in gauged $N = 8$ supergravity,” [hep-th/9901149](#).
- [644] K. Furuuchi, N. Ohta, and J.-G. Zhou, “Space-time superalgebra in $AdS_4 \times S^7$ via supermembrane probe,” [hep-th/9902122](#).
- [645] D. Fabbri, P. Fre, L. Gualtieri, and P. Termonia, “M theory on $AdS_4 \times M^{11}$: The Complete $Osp(2|4) \times SU(3) \times SU(2)$ spectrum from harmonic analysis,” [hep-th/9903036](#).
- [646] G. Dall’Agata, “ $N=2$ conformal field theories from M2-branes at conifold singularities,” [hep-th/9904198](#).
- [647] N. Itzhaki, J. M. Maldacena, J. Sonnenschein, and S. Yankielowicz, “Supergravity and The Large N Limit of Theories With Sixteen Supercharges,” *Phys.Rev.* **D58** (1998) 046004, [hep-th/9802042](#).
- [648] H. J. Boonstra, K. Skenderis, and P. K. Townsend, “The domain wall / QFT correspondence,” *JHEP* **01** (1999) 003, [hep-th/9807137](#).
- [649] T. Banks, W. Fischler, I. R. Klebanov, and L. Susskind, “Schwarzschild black holes from matrix theory,” *Phys. Rev. Lett.* **80** (1998) 226–229, [hep-th/9709091](#).
- [650] N. Itzhaki, A. A. Tseytlin, and S. Yankielowicz, “Supergravity solutions for branes localized within branes,” *Phys. Lett.* **B432** (1998) 298–304, [hep-th/9803103](#).
- [651] N. Itzhaki, “D6 + D0 and five-dimensional spinning black hole,” *JHEP* **09** (1998) 018, [hep-th/9809063](#).
- [652] O. Pelc and R. Siebelink, “The D2 - D6 system and a fibered AdS geometry,” [hep-th/9902045](#).
- [653] A. Hashimoto and N. Itzhaki, “A Comment on the Zamolodchikov c-Function and the Black String Entropy,” [hep-th/9903067](#).

- [654] D. Youm, “Localized intersecting BPS branes,” [hep-th/9902208](#).
- [655] J. X. Lu and S. Roy, “Nonthreshold (f, Dp) bound states,” [hep-th/9904129](#).
- [656] J. X. Lu and S. Roy, “((F, D1), D3) bound state and its T dual daughters,” [hep-th/9905014](#).
- [657] J. L. F. Barbon and A. Pasquinucci, “Aspects of instanton dynamics in AdS / CFT duality,” [hep-th/9904190](#).
- [658] C.G.Callan, J.A.Harvey, and A. Strominger, “Supersymmetric String Solitons,” [hep-th/9112030](#).
- [659] N. Seiberg, “Matrix Description of M-theory on T^5 and T^5/Z_2 ,” *Phys.Lett.* **B408** (1997) 98–104, [hep-th/9705221](#).
- [660] J. M. Maldacena and A. Strominger, “Semiclassical decay of near extremal fivebranes,” *JHEP* **12** (1997) 008, [hep-th/9710014](#).
- [661] D.-E. Diaconescu and J. Gomis, “Neveu-Schwarz five-branes at orbifold singularities and holography,” [hep-th/9810132](#).
- [662] S. Minwalla and N. Seiberg, “Comments on the IIA (NS)five-brane,” [hep-th/9904142](#).
- [663] G. T. Horowitz and R. C. Myers, “The AdS / CFT correspondence and a new positive energy conjecture for general relativity,” *Phys. Rev.* **D59** (1999) 026005, [hep-th/9808079](#).
- [664] K. Wilson, “Confinement of quarks,” *Phys. Rev.* **D10** (1974) 2445.
- [665] A. Brandhuber, N. Itzhaki, J. Sonnenschein, and S. Yankielowicz, “Wilson Loops, Confinement, and Phase Transitions in Large N Gauge Theories from Supergravity,” *JHEP* **06** (1998) 001, [hep-th/9803263](#).
- [666] M. Luscher, “Symmetry Breaking Aspects of the Roughening Transition in Gauge Theories,” *Nucl. Phys.* **B180** (1981) 317.
- [667] J. Greensite and P. Olesen, “Remarks on the Heavy Quark Potential in the Supergravity Approach,” *JHEP* **08** (1998) 009, [hep-th/9806235](#).
- [668] H. Dorn and H. J. Otto, “Q anti-Q potential from AdS - CFT relation at T greater than or equal to 0: Dependence on orientation in internal space and higher curvature corrections,” *JHEP* **09** (1998) 021, [hep-th/9807093](#).
- [669] Y. Kinar, E. Schreiber, and J. Sonnenschein, “ $Q\bar{Q}$ Potential from Strings in Curved Spacetime - Classical Results,” [hep-th/9811192](#).
- [670] U. H. Danielsson, E. Keski-Vakkuri, and M. Kruczenski, “Vacua, propagators, and holographic probes in AdS / CFT,” *JHEP* **01** (1999) 002, [hep-th/9812007](#).
- [671] J. Mandula, G. Zweig, and J. Govaerts, “Covariant Lattice Glueball Fields,” *Nucl.Phys.* **B228** (1983) 109.
- [672] C. Csaki, H. Ooguri, Y. Oz, and J. Terning, “Glueball Mass Spectrum from Supergravity,” *JHEP* **01** (1999) 017, [hep-th/9806021](#).
- [673] R. M. Koch, A.Jevicki, M.Mihailescu, and J.P.Nunes, “Evaluation Of Glueball Masses From Supergravity,” *Phys. Rev.* **D58** (1998) 105009, [hep-th/9806125](#).
- [674] M. Zyskin, “A note on the glueball mass spectrum,” *Phys.Lett.* **B439** (1998) 373–381, [hep-th/9806128](#).
- [675] J. A. Minahan, “Glueball mass spectra and other issues for supergravity duals of QCD models,” *JHEP* **01** (1999) 020, [hep-th/9811156](#).
- [676] M. J. Teper, “ $SU(N)$ gauge Theories in (2 + 1) Dimensions,” *Phys.Rev.* **D59** (1999) 014512, [hep-lat/9804008](#).
- [677] J. Pawelczyk and S. Theisen, “ $AdS_5 \times S^5$ black hole metric at $O((\alpha')^3)$,” *JHEP* **09** (1998) 010, [hep-th/9808126](#).

- [678] H. Ooguri, H. Robins, and J. Tannenhauser, “Glueballs and Their Kaluza-Klein Cousins,” *Phys.Lett.* **B437** (1998) 77–81, [hep-th/9806171](#).
- [679] N. Seiberg and E. Witten, “Monopole Condensation, And Confinement In $N = 2$ Supersymmetric Yang-Mills Theory,” *Nucl. Phys.* **B426** (1994) 19–52, [hep-th/9407087](#).
- [680] G. 't Hooft, “Topology of the Gauge Condition and New Confinement Phases in Non Abelian Gauge Theories,” *Nucl. Phys.* **B190** (1981) 455–478.
- [681] Y. Oz and A. Pasquinucci, “Branes and Theta Dependence,” *Phys. Lett.* **B444** (1998) 318–326, [hep-th/9809173](#).
- [682] E. Witten, “Theta Dependence In The Large N Limit Of Four-Dimensional Gauge Theories,” *Phys.Rev.Lett.* **81** (1998) 2862–2865, [hep-th/9807109](#).
- [683] E. Witten, “Large N Chiral Dynamics,” *Annals Phys.* **128** (1980) 363.
- [684] M. Creutz, *Quarks, Gluons and Lattices*. Cambridge University Press, Cambridge, UK, 1983.
- [685] A. Hashimoto and Y. Oz, “Aspects of QCD dynamics from string theory,” [hep-th/9809106](#).
- [686] G. Munster, “Physical strong coupling expansion parameters and glueball mass ratios,” *Phys. Lett.* **B121** (1983) 53.
- [687] N. Isgur and J. Paton, “Flux-tube model for hadrons in QCD,” *Phys.Rev.* **D31** (1985) 2910.
- [688] J. Kogut and L. Susskind, “Hamiltonian Formulation of Wilson’s Lattice Gauge Theories,” *Phys. Rev.* **D11** (1975) 395.
- [689] E. Witten, “Current Algebra Theorems for the $U(1)$ Goldstone Boson,” *Nucl.Phys.* **B156** (1979) 269.
- [690] G. Veneziano, “ $U(1)$ Without Instantons,” *Nucl.Phys.* **B159** (1979) 213–224.
- [691] M. J. Teper, “Physics from the lattice: Glueballs in QCD: Topology: $SU(N)$ for all N ,” [hep-lat/9711011](#).
- [692] C. Csaki, Y. Oz, J. Russo, and J. Terning, “Large N QCD from Rotating Branes,” *Phys. Rev.* **D59** (1999) 065008, [hep-th/9810186](#).
- [693] M. Campostrini, A. D. Giacomo, and Y. Gunduc, “Gluon Condensation in $SU(3)$ Lattice Gauge Theory,” *Phys. Lett.* **B225** (1989) 393.
- [694] M. D’Elia, A. D. Giacomo, and E. Meggiolaro, “Field Strength Correlators in Full QCD,” *Phys. Lett.* **B408** (1997) 315, [hep-lat/9705032](#).
- [695] S. Dalley and B. van de Sande, “Glueball calculations in large- N_c gauge theory,” *Phys.Rev.Lett.* **82** (1999) 1088–1091, [hep-th/9810236](#).
- [696] J. Russo, “New Compactifications of Supergravities and Large N QCD,” [hep-th/9808117](#).
- [697] J. Russo and K. Sfetsos, “Rotating D3 branes and QCD in three dimensions,” [hep-th/9901056](#).
- [698] C. Csaki, J. Russo, K. Sfetsos, and J. Terning, “Supergravity Models for 3+1 Dimensional QCD,” [hep-th/9902067](#).
- [699] L. Dixon and J. Harvey, “String Theories in Ten Dimensions Without Space-Time Supersymmetry,” *Nucl. Phys.* **B274** (1986) 93.
- [700] N. Seiberg and E. Witten, “Spin Structures in String Theory,” *Nucl. Phys.* **B276** (1986) 272.
- [701] I. R. Klebanov and A. Tseytlin, “D-Branes and Dual Gauge Theories in Type 0 Strings,” [hep-th/9811035](#).
- [702] I. R. Klebanov and A. A. Tseytlin, “Asymptotic freedom and infrared behavior in the type 0 string approach to gauge theory,” *Nucl. Phys.* **B547** (1999) 143, [hep-th/9812089](#).
- [703] J. A. Minahan, “Asymptotic Freedom and Confinement from Type 0 String Theory,” [hep-th/9902074](#).

- [704] N. Nekrasov and S. L. Shatashvili, “On nonsupersymmetric CFT in four-dimensions,” [hep-th/9902110](#).
- [705] I. R. Klebanov and A. A. Tseytlin, “A Nonsupersymmetric large N CFT from type 0 string theory,” *JHEP* **03** (1999) 015, [hep-th/9901101](#).
- [706] M. Alishahiha, A. Brandhuber, and Y. Oz, “Branes at Singularities in Type 0 String Theory,” [hep-th/9903186](#).
- [707] G. Ferretti and D. Martelli, “On the construction of gauge theories from noncritical type 0 strings,” [hep-th/9811208](#).
- [708] K. Zarembo, “Coleman-Weinberg mechanism and interaction of D3-branes in type 0 string theory,” [hep-th/9901106](#).
- [709] I. I. Kogan and G. Luzon, “Scale invariance of Dirac condition $g(e) g(m) = 1$ in type 0 string approach to gauge theory,” [hep-th/9902086](#).
- [710] A. A. Tseytlin and K. Zarembo, “Effective potential in nonsupersymmetric $SU(N) \times SU(N)$ gauge theory and interactions of type 0 D3-branes,” [hep-th/9902095](#).
- [711] A. Armoni, E. Fuchs, and J. Sonnenschein, “Confinement in 4-D Yang-Mills theories from noncritical type 0 string theory,” [hep-th/9903090](#).
- [712] G. Ferretti, J. Kalkkinen, and D. Martelli, “Noncritical type 0 string theories and their field theory duals,” [hep-th/9904013](#).
- [713] M. S. Costa, “Intersecting D branes and black holes in type 0 string theory,” *JHEP* **04** (1999) 016, [hep-th/9903128](#).
- [714] R. R. Metsaev and A. A. Tseytlin, “Type IIB superstring action in $AdS_5 \times S^5$ background,” *Nucl. Phys.* **B533** (1998) 109, [hep-th/9805028](#).
- [715] I. Pesando, “A kappa fixed fixed type IIB superstring action on $AdS(5) \times S(5)$,” *JHEP* **11** (1998) 002, [hep-th/9808020](#).
- [716] R. Kallosh and J. Rahmfeld, “The GS string action on $AdS_5 \times S^5$,” *Phys. Lett.* **B443** (1998) 143, [hep-th/9808038](#).
- [717] R. Kallosh and A. A. Tseytlin, “Simplifying superstring action on $AdS_5 \times S^5$,” *JHEP* **10** (1998) 016, [hep-th/9808088](#).
- [718] D. Polyakov, “On the NSR formulation of string theory on $AdS_5 \times S^5$,” [hep-th/9812044](#).
- [719] L. Dolan and M. Langham, “Symmetric subgroups of gauged supergravities and AdS string theory vertex operators,” *Mod. Phys. Lett.* **A14** (1999) 517, [hep-th/9901030](#).
- [720] A. Rajaraman and M. Rozali, “On the quantization of the GS string on $AdS_5 \times S^5$,” [hep-th/9902046](#).
- [721] D. Berenstein and R. G. Leigh, “Superstring perturbation theory and Ramond-Ramond backgrounds,” [hep-th/9904104](#).
- [722] V. Balasubramanian, R. Gopakumar, and F. Larsen, “Gauge theory, geometry and the large N limit,” *Nucl. Phys.* **B526** (1998) 415, [hep-th/9712077](#).
- [723] S. Hyun, “The Background geometry of DLCQ supergravity,” *Phys. Lett.* **B441** (1998) 116, [hep-th/9802026](#).
- [724] J. McCarthy, L. Susskind, and A. Wilkins, “Large N and the Dine-Rajaraman problem,” *Phys. Lett.* **B437** (1998) 62, [hep-th/9806136](#).
- [725] S. P. de Alwis, “On the supergravity gauge theory correspondence and the matrix model,” *Phys. Rev.* **D59** (1999) 044029, [hep-th/9806178](#).
- [726] P. J. Silva, “On the relation of matrix theory and Maldacena conjecture,” [hep-th/9806188](#).
- [727] I. Chepelev, “Are Matrix theory and Maldacena’s conjecture related?,” [hep-th/9901033](#).

- [728] T. Yoneya, “Supergravity, AdS / CFT correspondence and matrix models,” [hep-th/9902200](#).
- [729] P. K. Townsend, “The M(atrrix) model / AdS(2) correspondence,” [hep-th/9903043](#).
- [730] J. Polchinski, “M theory and the light cone,” [hep-th/9903165](#).
- [731] D. Bak and S.-J. Rey, “Holographic view of causality and locality via branes in AdS / CFT correspondence,” [hep-th/9902101](#).
- [732] M. Berkooz, “A Proposal on some microscopic aspects of the AdS / CFT duality,” [hep-th/9807230](#).
- [733] J. Polchinski, “S matrices from AdS space-time,” [hep-th/9901076](#).
- [734] L. Susskind, “Holography in the flat space limit,” [hep-th/9901079](#).
- [735] J. Polchinski, L. Susskind, and N. Toumbas, “Negative energy, superluminosity and holography,” [hep-th/9903228](#).
- [736] I. Y. Aref’eva, “On the holographic S matrix,” [hep-th/9902106](#).
- [737] H. W. Lee and Y. S. Myung, “Scattering from an AdS(3) bubble and an exact AdS(3),” [hep-th/9903054](#).
- [738] M. Li, “Energy momentum conservation and holographic S matrix,” [hep-th/9904164](#).
- [739] A. Strominger, “AdS(2) quantum gravity and string theory,” *JHEP* **01** (1999) 007, [hep-th/9809027](#).
- [740] D. Brill, “Splitting of an extremal Reissner-Nordstrom throat via quantum tunneling,” *Phys. Rev.* **D46** (1992) 1560–1565, [hep-th/9202037](#).
- [741] J. Kumar, “Conformal mechanics and the Virasoro algebra,” *JHEP* **04** (1999) 006, [hep-th/9901139](#).
- [742] R. Kallosh, “Black holes and quantum mechanics,” [hep-th/9902007](#).
- [743] G. W. Gibbons and P. K. Townsend, “Black holes and Calogero models,” [hep-th/9812034](#).
- [744] M. Spradlin and A. Strominger, “Vacuum states for AdS(2) black holes,” [hep-th/9904143](#).
- [745] O. Aharony and T. Banks, “Note on the quantum mechanics of M theory,” *JHEP* **03** (1999) 016, [hep-th/9812237](#).
- [746] A. Hashimoto, “Holographic description of D3-branes in flat space,” [hep-th/9903227](#).
- [747] G. T. Horowitz and D. Marolf, “A New approach to string cosmology,” *JHEP* **07** (1998) 014, [hep-th/9805207](#).
- [748] C. M. Hull, “Timelike T duality, de Sitter space, large N gauge theories and topological field theory,” *JHEP* **07** (1998) 021, [hep-th/9806146](#).
- [749] C. M. Hull, “Duality and the signature of space-time,” *JHEP* **11** (1998) 017, [hep-th/9807127](#).
- [750] C. M. Hull and R. R. Khuri, “Branes, times and dualities,” *Nucl. Phys.* **B536** (1998) 219, [hep-th/9808069](#).
- [751] W. Fischler and L. Susskind, “Holography and cosmology,” [hep-th/9806039](#).
- [752] D. Bak and S.-J. Rey, “Holographic principle and string cosmology,” [hep-th/9811008](#).
- [753] R. Dawid, “A Speculative remark on holography,” *Phys. Lett.* **B451** (1999) 19, [hep-th/9811243](#).
- [754] S. K. Rama and T. Sarkar, “Holographic principle during inflation and a lower bound on density fluctuations,” *Phys. Lett.* **B450** (1999) 55, [hep-th/9812043](#).
- [755] R. Easther and D. A. Lowe, “Holography, cosmology and the second law of thermodynamics,” [hep-th/9902088](#).
- [756] D. Bak and S.-J. Rey, “Cosmic holography,” [hep-th/9902173](#).
- [757] N. Kaloper and A. Linde, “Cosmology vs. holography,” [hep-th/9904120](#).