

HOLOGRAPHY PRINCIPLE AND ARITHMETIC OF ALGEBRAIC CURVES

Yuri I. Manin, Matilde Marcolli

Max-Planck-Institut für Mathematik, Bonn, Germany

Abstract. According to the holography principle (due to G. 't Hooft, L. Susskind, J. Maldacena, et al.), quantum gravity and string theory on certain manifolds with boundary can be studied in terms of a conformal field theory on the boundary. Only a few mathematically exact results corroborating this exciting program are known. In this paper we interpret from this perspective several constructions which arose initially in the arithmetic geometry of algebraic curves. We show that the relation between hyperbolic geometry and Arakelov geometry at arithmetic infinity involves exactly the same geometric data as the Euclidean AdS_3 holography of black holes. Moreover, in the case of Euclidean AdS_2 holography, we present some results on bulk/boundary correspondence where the boundary is a non-commutative space.

§0. Introduction

0.1. Holography principle. Consider a manifold M^{d+1} (“bulk space”) with boundary N^d . The holography principle postulates the existence of strong ties between certain field theories on M and N respectively. For example, in the actively discussed Maldacena’s conjecture ([Mal], [Wi]), M^{d+1} is the anti de Sitter space AdS_{d+1} (or $\text{AdS}_{d+1} \times S^{d+1}$), N^d its conformal boundary. On the boundary one considers the large N limit of a conformally invariant theory in d dimensions, and on the bulk space supergravity and string theory (cf. e.g. [AhGuMOO], [Mal], [Suss], [’tH], [Wi], [WiY]).

The holography principle was originally suggested by ‘t Hooft in order to reconcile unitarity with gravitational collapse. In this case M is a black hole and N is the event horizon. Thus the bulk space should be imagined as (a part of) space–time.

There are other models where the boundary can play the role of space–time (Plato’s cave picture), with the bulk space involving an extra dimension (e. g. the renormalization group scale) and a Kaluza–Klein type reduction [AlGo], and “brane world scenarios” where one models our universe as a brane in higher dimensional space–time, with gravity confined to the brane.

In this paper we consider first of all a class of Euclidean AdS_3 bulk spaces which are quotients of the real hyperbolic 3–space \mathbf{H}^3 by a Schottky group. The boundary (at infinity) of such a space is a compact oriented surface with conformal structure, which is the same as a compact complex algebraic curve. Such spaces are analytic continuations of known (generally rotating) Lorentzian signature black

hole solutions, and they were recently studied from this perspective by K. Krasnov (cf. [Kr1]–[Kr4].)

0.2. Arithmetic geometry at infinity. Consider a projective algebraic curve X defined, say, over the field of rational numbers \mathbf{Q} . It can be given by equations with integer coefficients which defines a scheme $X_{\mathbf{Z}}$, “arithmetical surface”. X itself is the generic fiber of the projection $X_{\mathbf{Z}} \rightarrow \text{Spec } \mathbf{Z}$. Finite points of the “arithmetic curve” $\text{Spec } \mathbf{Z}$ are primes p , and the closed fibers of $X_{\mathbf{Z}}$ at finite distance are the reductions $X_{\mathbf{Z}} \bmod p$. One can also consider infinitesimal neighborhoods of p and the respective fibers which are simply reductions of $X_{\mathbf{Z}}$ modulo powers p^n . The limit of such reductions as $n \rightarrow \infty$ can be thought of as a p -adic completion of $X_{\mathbf{Z}}$.

A geometric analog of this picture is an algebraic surface fibered over an affine line (replacing $\text{Spec } \mathbf{Z}$.) We can complete the affine line to the projective one by adding a point at infinity, and extend the fibered surface by adding a closed fiber at infinity. If we want to imitate this in the arithmetic case, we should add somehow “the arithmetic infinity” to $\text{Spec } \mathbf{Z}$ and enhance the geometry of X by appropriate structures.

It was long known that the arithmetic infinity itself is represented by the embedding $\mathbf{Q} \rightarrow \mathbf{C}$ and considering the complex absolute value on an equal footing with p -adic valuations. In his paper [Ar] S. Arakelov demonstrated that Hermitian geometry of $X_{\mathbf{C}}$ constitutes an analog of p -adic completions of $X_{\mathbf{Z}}$. In particular, Green’s functions for appropriate metrics provide intersection indices of arithmetic curves at the infinite fiber. Arakelov’s arithmetic geometry was since then tremendously developed and generalized to arbitrary dimensions.

One aspect of p -adic geometry was, however, missing in Arakelov’s theory of arithmetical infinity: namely, an analog of the closed fiber $X_{\mathbf{Z}} \bmod p$ and the related picture of reductions modulo powers of p approximating the p -adic limit.

In Manin’s paper [Man2] it was suggested that this missing structure can be modeled by choosing a Schottky uniformization of $X(\mathbf{C})$ and treating this Riemann surface as the conformal boundary of the respective handlebody obtained by factoring out \mathbf{H}^3 with respect to the Schottky group. Comparing this structure with the p -adic case, one should keep in mind that only curves with maximally degenerate reduction (all components of genus zero) admit a p -adic Schottky uniformization (Mumford’s theory). Thus we imagine “the reduction modulo arithmetic infinity” to be maximally degenerate: a viewpoint which is supported by other evidence as well.

We see thus that the ∞ -adic geometry at arithmetic infinity, developed in [Man2], involves exactly the same geometric data *bulk space/boundary* as the Euclidean AdS_3 holography of black holes. Moreover, Arakelov’s intersection indices are built from Green’s functions, which form the basic building blocks for Polyakov

measures as well as the correlation functions of bosonic and fermionic field theories on X (see [ABMNV], [Man1], [Fay], [FeSo].)

In the first section of this paper we demonstrate that the expressions for these Green functions in terms of the geodesic configurations in the handlebody given in [Man2] can be nicely interpreted in the spirit of the holography principle.

A recent attempt to generalize [Man2] to higher dimensions is due to A. Werner ([We]). It would be interesting to discuss her construction as a case of holography.

0.3. Modular curves and non-commutative boundary. The second section is dedicated to the holography in 1+1 dimensions which we recognize in the approach to the theory of modular curves developed, in particular, in [ManMar]. In this case \mathbf{H}^3 is replaced by the upper complex half-plane \mathbf{H}^2 , and a Schottky group by a subgroup G of the modular group. The most interesting new feature is that the boundary of the quotient space considered in [ManMar] is a non-commutative space: it is the quotient $G \backslash \mathbf{P}^1(\mathbf{R})$ treated as a crossed product in the style of Connes. This might be of interest, because non-commutative boundaries of moduli spaces (e. g. that of instantons) play an increasingly important role in physics considerations.

In particular, we argue that one reason why little is known on AdS_{1+1} holography, unlike the much better understood case of AdS_{2+1} , is that a treatment of holography for AdS_{1+1} and its Euclidean counterpart \mathbf{H}^2 should take into account the presence of non-commutative geometry at the boundary.

0.4. Acknowledgment. We are grateful to Alain Connes who suggested the authors to look at [Man2] from the perspective of the holography principle. We also thank Kirill Krasnov for several useful and encouraging comments.

§1. Handlebodies as holograms

In this section we review the basic notions of the boundary and bulk geometry and function theory in the context of Schottky uniformization. Then we state and interpret the main formulas of [Man2] in the light of the holography principle.

1.1. Green's functions on Riemann surfaces. Consider a compact non-singular complex Riemann surface X and a divisor $A = \sum_x m_x(x)$ on it with support $|A|$. If we choose a positive real-analytic 2-form $d\mu$ on X , we can define the Green function $g_{\mu,A} = g_A$ as a real analytic function on $X \setminus |A|$. It is uniquely determined by the following conditions.

(i) *Laplace equation:*

$$\partial\bar{\partial} g_A = \pi i (\deg(A) d\mu - \delta_A)$$

where δ_A is the standard δ -current $\varphi \mapsto \sum_x m_x \varphi(x)$.

(ii) *Singularities*: if z is a local parameter in a neighborhood of x , then $g_A - m_x \log |z|$ is locally real analytic.

(iii) *Normalization*: $\int_X g_A d\mu = 0$.

Let now $B = \sum_y n_y(y)$ be another divisor, $|A| \cap |B| = \emptyset$. Put $g_\mu(A, B) := \sum_y n_y g_{\mu, A}(y)$. This is a number, symmetric and biadditive in A, B .

Generally, g_μ depends on μ . However, if $\deg A = \deg B = 0$, $g_{\mu, A, B}$ depends only on A, B . Notice that, as a particular case of the general Kähler formalism, to choose $d\mu$ is the same as to choose a real analytic Riemannian metric on X compatible with the complex structure. This means that $g_\mu(A, B) = g(A, B)$ are conformal invariants when both divisors are of degree zero. If moreover A is the divisor of a meromorphic function w_A , then

$$g(A, B) = \log \prod_{y \in |B|} |w_A(y)|^{n_y} = \operatorname{Re} \int_{\gamma_B} \frac{dw_A}{w_A} \quad (1.1)$$

where γ_B is a 1-chain with boundary B . This is directly applicable to divisors of degree zero on the Riemann sphere $\mathbf{P}^1(\mathbf{C})$.

This formula admits also a generalization to arbitrary A, B of degree zero on a Riemann surface of arbitrary genus. The logarithmic differential dw_A/w_A must be replaced by the differential of the third kind ω_A with pure imaginary periods and residues m_x at x . Then

$$g(A, B) = \operatorname{Re} \int_{\gamma_B} \omega_A. \quad (1.2)$$

If we drop the degree zero restriction, we can write an explicit formula for the basic Green's function $g_{\mu, x}(y)$ via theta functions in the case when μ is *the Arakelov metric* constructed with the help of an orthonormal basis of the differentials of the first kind. For a characterization of Arakelov's metric in a physical context, see [ABMNV], pp. 520–521.

1.1.1. Field theories on a Riemann surface X . Green's functions appear in explicit formulas for correlators of various field theories, insertion formulas, and Polyakov string measure. In [ABMNV] they are used in order to establish the coincidence of certain correlators calculated for fermionic, resp. bosonic fields on X (bosonization phenomenon.) See [Fay] for a thorough mathematical treatment.

1.2. Green's functions and bulk geometry: genus zero case. In this subsection X is the Riemann sphere $\mathbf{P}^1(\mathbf{C})$. It is convenient to start with a coordinate-free description of all basic objects.

Choose a two-dimensional complex vector space V and define $X = X_V$ as the space of one-dimensional vector subspaces in V . Define the respective bulk space

as a three-dimensional real manifold $\mathbf{H}^3 = \mathbf{H}_V$ whose points are classes $[h]$ of hermitian metrics h on V modulo dilations: $h \cong h'$ iff $h = \rho h'$ for some $\rho > 0$. Clearly, $PGL(V)$ acts on \mathbf{H}_V and X_V . The stabilizer of any $[h]$ is isomorphic to $SU(2)$. Any point $[h]$ defines a unique Kähler metric on X_V which is stabilized by the same subgroup as $[h]$ and in which the diameter of X_V equals one. This metric, in turn, determines a volume form $d\mu = d\mu_{[h]}$ on X_V .

The bulk space \mathbf{H}_V has a natural metric: the distance between $[h]$ and $[h']$ is the logarithm of the quotient of volumes of unit balls for h and h' , if one ball is contained in the other and their boundaries touch. In fact, \mathbf{H}_V becomes the hyperbolic three-space of constant curvature -1 . Its conformal infinity X_V can be invariantly described as the space of (classes of) unbounded ends of oriented geodesics.

We will now give a bulk space interpretation of two basic Green's functions $g((a) - (b), (c) - (d))$ and $g_\mu(z, w)$, where $d\mu$ corresponds to a point $u \in \mathbf{H}_V$ as explained above. To this end, introduce the following notation from [Man2]. If $a, b \in \mathbf{H}_V \cup X_V$, $\{a, b\}$ denotes the geodesic joining a to b and oriented in this direction. For a geodesic γ and a point a , $a * \gamma$ is the point on γ at which γ is intersected by the geodesic δ passing through a and orthogonal to γ . In particular, the distance from a to γ is the distance from a to $a * \gamma$. If two points p, q lie on an *oriented* geodesic γ , we denote by $\text{ordist}(p, q)$, or else $\ell_\gamma(p, q)$, the respective oriented distance.

1.2.1. Lemma. *We have*

$$g((a) - (b), (c) - (d)) = -\text{ordist}(a * \{c, d\}, b * \{c, d\}), \quad (1.3)$$

$$g_\mu(p, q) = \log \frac{e^{1/2}}{\cosh \text{dist}(u, \{p, q\})}. \quad (1.4)$$

The following Fig.1 illustrates the configurations of geodesics involved.

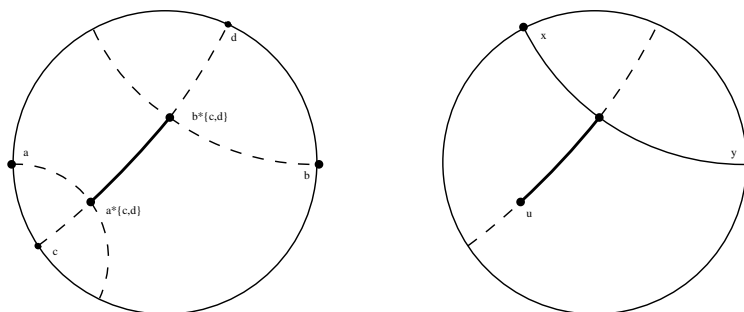

Fig. 1

We invite the reader to compare these configurations to the Feynman diagrams in [Wi] illustrating propagation between boundary and/or interior points.

To check, say, (1.3), it is convenient to introduce the standard coordinates (z, y) identifying \mathbf{H} with $\mathbf{C} \times \mathbf{R}_+$. Both sides of (1.3) are $PGL(V)$ -invariant. Hence it suffices to consider the case when $(a, b, c, d) = (z, 1, 0, \infty)$ in $\mathbf{P}^1(\mathbf{C})$. Then $\{c, d\} = \{0, \infty\}$ is the vertical coordinate semi-axis, and generally in (z, y) coordinates of \mathbf{H}^3 we have

$$a * \{c, d\} = (0, |z|), \quad b * \{c, d\} = (0, 1),$$

$$\text{ordist}((0, |z|), (0, 1)) = -\log |z|.$$

On the other hand, using the notation of (1.1), we obtain

$$g((a) - (b), (c) - (d)) = \log \frac{|w_{(a)-(b)}(c)|}{|w_{(a)-(b)}(d)|} = \log |z|.$$

The middle term of this formula involves the classical cross-ratio of four points on a projective line, for which it is convenient to have a special notation:

$$\langle a, b, c, d \rangle := \frac{w_{(a)-(b)}(c)}{w_{(a)-(b)}(d)}. \quad (1.5)$$

It is interesting to notice that not only the absolute value, but the argument of the cross-ratio (1.5) as well admits a bulk space interpretation:

$$\arg \frac{w_{(a)-(b)}(c)}{w_{(a)-(b)}(d)} = -\psi_{\{c,d\}}(a, b), \quad (1.6)$$

Here we denote by $\psi_\gamma(a, b)$ the oriented angle between the geodesics joining $a * \gamma$ to a and $b * \gamma$ to b , which can be measured after the parallel translation to, say, a . For a proof of this and other details we refer to [Man2], Prop. 2.2.

This expression is relevant in at least two contexts. First, it shows how the characteristics of rotating black holes are encoded in the complex geometry of the boundary (cf. (1.8) below for the genus 1 case). Second, it demonstrates that our formulas for the Green functions $g(A, B)$ given below can be refined to provide the bulk space avatars of the complex analytic expressions such that $\exp g(A, B)$ is the modulus squared of such expression. This is the well known phenomenon of holomorphic factorization.

We will now introduce a Schottky group Γ acting upon $\mathbf{H}^3 \cup \mathbf{P}^1(\mathbf{C})$ and consider the respective quotient spaces. The boundary will become a complex Riemann surface $X(\mathbf{C})$, whose genus equals to number of generators of Γ , and the bulk space turns into a handlebody $\Gamma \backslash \mathbf{H}^3$ “filling” this surface.

The boundary/bulk expressions for degree zero Green's functions and related quantities will be obtained from (1.3) with the help of an appropriate averaging over Γ . The geodesic configuration involved in the right hand side of (1.3) will have to be supplemented by its Γ -shifts and then projected into the handlebody. After such a projection, however, an expression like $a * \gamma$ will have to be replaced by an infinite sum over all geodesics starting, say, at a boundary point a and crossing γ orthogonally. Interpreting distances between such points involved in (1.3) also becomes a trickier business: the geodesic along which we measure this distance has to be made explicit. We will provide the details for the genus one case in 1.3 below. After gaining some experience, we can restrict ourselves to working in the covering bulk space \mathbf{H}^3 : it is well known that the geometry of non-simply connected spaces is best described in terms of the universal cover and its group of deck transformations. In 1.4 we explain this geometry for genus ≥ 2 case.

1.3. Genus 1 case and Euclidean BTZ black holes. Bañados–Teitelboim–Zanelli black holes ([BTZ]) are asymptotically AdS space-times which are obtained by global identifications of AdS_{2+1} by a discrete group of isometries Γ generated by a single loxodromic element.

The group of isometries of AdS_{2+1} is $SO(2, 2)$ as can be seen by considering the hyperboloid model of anti de Sitter space $-t^2 - u^2 + x^2 + y^2 = -1$ in $\mathbf{R}^{2,2}$.

The non-rotating case (see [ABBHP], [Kr1]) corresponds to the case where the group Γ lies in a diagonal $SO(2, 1) \cong PSL(2, \mathbf{R})$ in $SO(2, 2)$. In this case, there is a surface of time symmetry. This $t = 0$ slice is a two-dimensional Euclidean signature space with constant negative curvature, hence it has the geometry of the real hyperbolic plane \mathbf{H}^2 . The fundamental domain for the action of Γ on the $t = 0$ slice is given by a region in \mathbf{H}^2 bounded by two non-intersecting infinite geodesics, and the group Γ is generated by the element of $PSL(2, \mathbf{R})$ that identifies the two non-intersecting geodesics in the boundary of the fundamental domain, creating a surface with the topology of $S^1 \times \mathbf{R}$. The BTZ black hole is then obtained by evolving this $t = 0$ surface in the time direction in AdS_{2+1} , until it develops singularities at past and future infinity. The time evolution of the two geodesics in the boundary of the fundamental domain gives geodesic surfaces that are joined at the past and future singularities. The geodesic arc realizing the path of minimal length between the two non-intersecting geodesics is the event horizon of the BTZ black hole (see [ABBHP], [BTZ], [Kr1] for further details).

The Euclidean analog of the BTZ black hole is given by realizing the \mathbf{H}^2 slice as a hyperplane in \mathbf{H}^3 and “evolving” it by continuing the geodesics in \mathbf{H}^2 to geodesic surfaces in \mathbf{H}^3 . This produces a fundamental domain of the form illustrated in the Fig 2.

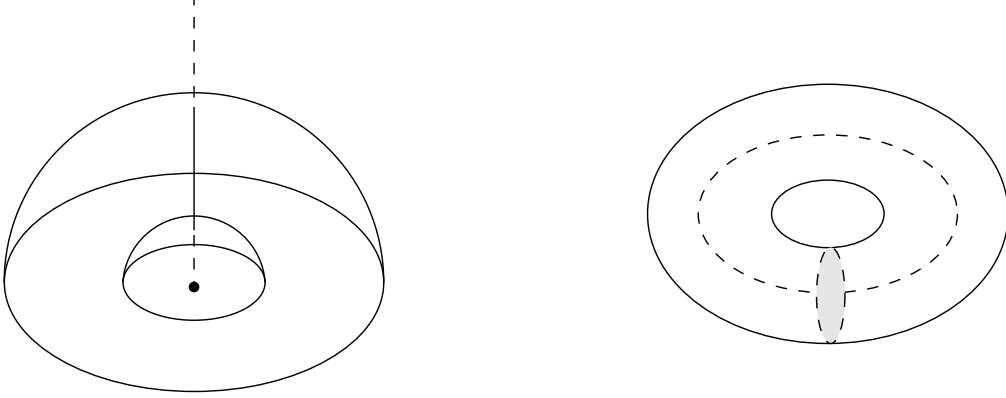

Fig. 2

The group $\Gamma \cong q^{\mathbf{Z}}$ is a Schottky group of rank one in $PSL(2, \mathbf{C})$, generated by the choice of an element $q \in \mathbf{C}^*$, $|q| < 1$. It acts on \mathbf{H}^3 by

$$\begin{pmatrix} q^{1/2} & 0 \\ 0 & q^{-1/2} \end{pmatrix} (z, y) = (qz, |q|y). \quad (1.7)$$

The quotient $\mathcal{X}_q = \mathbf{H}^3/(q^{\mathbf{Z}})$ is a solid torus with a hyperbolic structure and with the Jacobi uniformized elliptic curve $X_q(\mathbf{C}) = \mathbf{C}^*/(q^{\mathbf{Z}})$ as its boundary at infinity. The fundamental domain depicted on Fig. 2 is $|q|^2 < |z| \leq 1$, $|q|^2 < |z|^2 + y^2 \leq 1$.

The physical meaning of q is clarified by the following expression:

$$q = \exp\left(\frac{2\pi(i|r_-| - r_+)}{\ell}\right), \quad (1.8)$$

where the parameters r_{\pm} depend on mass M and angular momentum J of the black hole,

$$r_{\pm}^2 = \frac{1}{2} \left(M\ell \pm \sqrt{M^2\ell^2 + J} \right),$$

and ℓ determines the cosmological constant $\Lambda = -1/\ell^2$ and normalizes the metric as

$$ds^2 = \frac{\ell^2}{y^2} (|dz|^2 + dy^2).$$

This can be seen by writing the coordinates in the upper half space model of \mathbf{H}^3 in terms of Schwarzschild coordinates (r, τ, ϕ) with Euclidean time τ ,

$$z = \left(\frac{r^2 - r_+^2}{r^2 - r_-^2} \right)^{1/2} \exp\left(\left(\frac{r_+}{\ell} \phi - \frac{|r_-|}{\ell^2} \tau \right) + i \left(\frac{r_+}{\ell^2} \tau + \frac{|r_-|}{\ell} \phi \right) \right),$$

$$y = \left(\frac{r_+^2 - r_-^2}{r^2 - r_-^2} \right)^{1/2} \exp \left(\frac{r_+}{\ell} \phi - \frac{|r_-|}{\ell^2} \tau \right).$$

The transformation (1.6) can then be written as

$$(z, y) \mapsto (e^{2\pi(i|r_-|-r_+)/\ell} z, e^{-2\pi r_+/\ell} y).$$

This was already observed in [BKSW]. For $r_- \neq 0$, that is, not purely real q , the quotient space $X_q(\mathbf{C})$ represents a spinning black hole. We normalized our coordinates so that $\ell = 1$.

1.3.1. Determinant of the Dirac operator and Green's function. There are explicit formulas in terms of theta functions for the determinant of the Dirac operator twisted with a flat bundle on an elliptic curve. For a parameterized family of Dirac operators D_P , with P a Poincaré line bundle, whose restriction to a fiber X_q over $L \in \text{Pic}^0(X_q)$ is isomorphic to L , it is proved in [RS] that, up to a constant phase, we have

$$\det D_P(q; u, v) = q^{\frac{B_2(v)}{2}} \prod_{n=1}^{\infty} (1 - q^{n-v} e^{2\pi i u}) (1 - q^{n+v-1} e^{-2\pi i u}), \quad (1.9)$$

with $B_2(v) = v^2 - v + 1/6$ the second Bernoulli polynomial. It is shown in [AMV] that (1.9) is the operator product expansion of the path integral for fermions on the elliptic curve X_q .

On the other hand, the Arakelov Green function on X_q is essentially the logarithm of the absolute value of this expression:

$$g(z, 1) = \log \left(|q|^{B_2(\log |z| / \log |q|) / 2} |1 - z| \prod_{n=1}^{\infty} |1 - q^n z| |1 - q^n z^{-1}| \right) \quad (1.10)$$

(see [Man2], (4.6)).

To interpret various terms of (1.10) via geodesic configurations, we use (1.3) and (1.5) for various choices of the cross-ratio, for example, $|x| = |\langle x, 1, 0, \infty \rangle|$, $|1 - x| = |\langle x, 0, 1, \infty \rangle|$. More precisely, we introduce the following notation:

- $\{0, \infty\}$ in \mathbf{H}^3 becomes the closed geodesic γ_0 in the solid torus \mathcal{X}_q . Its length is $l(\gamma_0) = -\log |q|$ (cf. (1.6).)
- Choose a point x on the elliptic curve X_q and denote by the same letter x its unique lift to \mathbf{C} satisfying $|q| < |x| \leq 1$. In particular, 1 denotes both the number and the identity point of X_q .
- Denote by \bar{x} the point $x * \{0, \infty\}$ and also its image in γ_0 . Similarly, denote by $\bar{1} = 1 * \{0, \infty\} = (0, 1) \in \mathbf{H}^3$ and the respective point in γ_0 .

Fig. 3a depicts the relevant configurations:

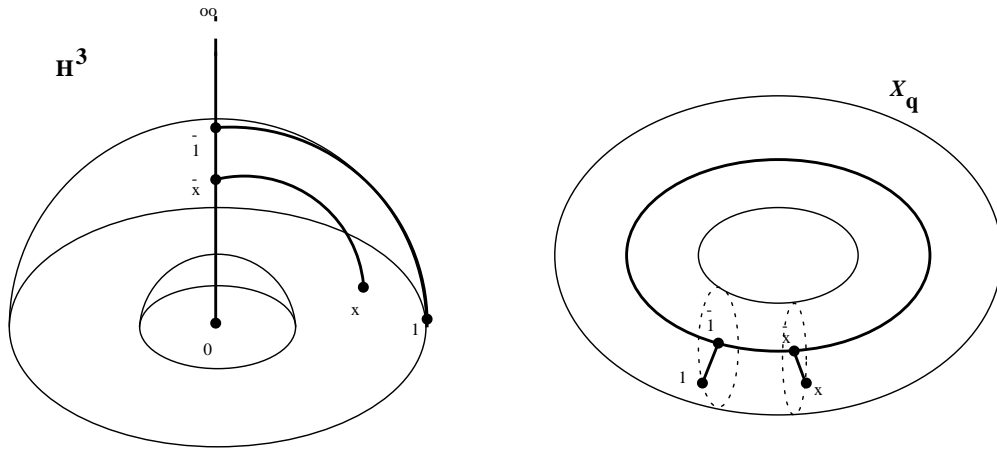

Fig. 3a

- Denote the image of $\{1, \infty\}$ by γ_1 . This is the geodesic starting at the boundary identity point and having γ_0 as its limit cycle at the other end. (As was explained in [Man2], this is one of the avatars of “reducing 1 modulo powers of arithmetic infinity”.) Denote by $\bar{0}$ the point $0 * \{1, \infty\}$, and also its image in the solid torus.

- Finally, put $\bar{x}_n = q^n x * \{1, \infty\}$, and denote its image in γ_1 by the same letter. Similarly, $\tilde{x}_n = q^n x^{-1} * \{1, \infty\}$ (cf. Fig. 3b.)

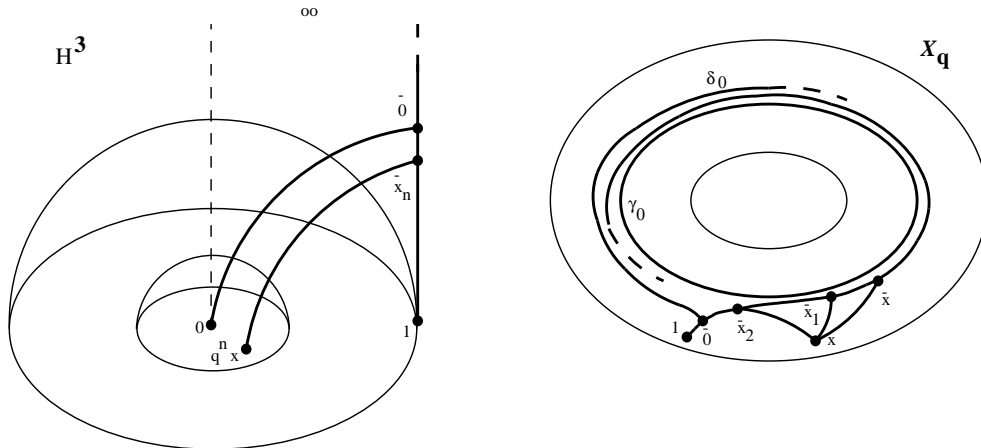

Fig. 3b

With this notation, we have:

1.3.2. Proposition. *Let $g(u, v)$ be the basic Green function with respect to the invariant measure of volume 1. Then $g(u, v) = g(uv^{-1}, 1)$, and*

$$g(x, 1) = -\frac{1}{2}l(\gamma_0) B_2 \left(\frac{\ell_{\gamma_0}(\bar{x}, \bar{1})}{l(\gamma_0)} \right) + \sum_{n \geq 0} \ell_{\gamma_1}(\bar{0}, \bar{x}_n) + \sum_{n \geq 1} \ell_{\gamma_1}(\bar{0}, \tilde{x}_n). \quad (1.11)$$

A contemplation will convince the reader that the meaning of the summation parameter n in the last expression consists in counting appropriate winding numbers of geodesics in \mathcal{X} starting at x along the closed geodesic γ_0 .

One can similarly write a more informative formula calculating the whole determinant of the Dirac operator (1.9) which involves winding numbers *around* γ_0 . using the formula (1.6) which provides the phases of cross-ratios in terms of angles and parallel translations of the relevant geodesic configurations. We leave this as an exercise for the reader.

1.4. Genus ≥ 2 case and Krasnov's Euclidean black holes. The construction of the BTZ black hole with Lorentzian signature can be generalized to other asymptotically AdS_{2+1} solutions, by prescribing global identifications on the $t = 0$ slice \mathbf{H}^2 of AdS_{2+1} , obtained by the action of a discrete subgroup of $PSL(2, \mathbf{R})$. Solutions of this type are described in [ABBHP]. They admit a Euclidean version which is a global quotient of \mathbf{H}^3 by the action of a discrete group of isometries Γ . We are especially interested in the case where $\Gamma \subset PSL(2, \mathbf{C})$ is a geometrically finite Schottky group. Such solutions were studied by Krasnov [Kr1], [Kr4], so we refer to them as Krasnov black holes. For this class of space-times, in the Euclidean case, the bulk space is a hyperbolic handlebody of genus $g \geq 2$, and the surface at infinity is a compact Riemann surface of genus g , with the complex structure determined by the Schottky uniformization.

1.4.1. Schottky groups and handlebodies. (i) *Loxodromic elements.* As in 1.2, we choose a 2-dimensional complex vector space V and study the group $PGL(2, V)$ and various spaces upon which it acts. A loxodromic element $g \in PGL(2, V)$, by definition, has two different fixed points in $P(V) = \mathbf{P}^1(\mathbf{C})$, the attracting one $z^+(g)$ and the repelling one $z^-(g)$. The eigenvalue $q(g)$ of g on the complex tangent space to $z^+(g)$ is called the multiplier of g . We have $|q(g)| < 1$.

(ii) *Schottky groups.* A Schottky group is a finitely generated discrete subgroup $\Gamma \subset PGL(V)$ consisting of loxodromic elements and identity. It is always free; its minimal number of generators p is called genus. Each Schottky group of genus p admits a marking. By definition, this is a family of $2p$ open connected domains D_1, \dots, D_{2p} in $P(V)$ and a family of generators $g_1, \dots, g_p \in \Gamma$ with the following

properties. The boundary C_i of D_i is a Jordan curve homeomorphic to S^1 , closures of D_i are pairwise disjoint; moreover, $g_k(C_k) \subset C_{p+k}$, and $g_k(D_k) \subset P(V) \setminus D_{p+k}$. A marking is called classical, if all D_i are circles. Every Schottky group admits a marking, but there are groups for which no classical marking exists.

(iii) Γ -invariant sets and their quotients. Any Schottky group Γ of genus p acts on \mathbf{H}_V faithfully and discretely. The quotient $\mathcal{X}_\Gamma := \Gamma \backslash \mathbf{H}_V$ is (the interior of) a handlebody of genus p .

Choose a marking and put

$$X_{0,\Gamma} := P(V) \setminus \bigcup_{k=1}^p (D_k \cup \overline{D}_{k+p}), \quad \Omega_\Gamma := \bigcup_{g \in \Gamma} g(X_{0,\Gamma}).$$

Γ acts on Ω_Γ faithfully and discretely, $X_{0,\Gamma}$ is a fundamental domain for this action, and the quotient $\Gamma \backslash \Omega_\Gamma$ is a complex Riemann surface of genus p . Every Riemann surface admits infinitely many different Schottky covers.

In the representation above, Γ acts upon Ω_Γ as on the boundary of a tubular neighborhood of a Cayley graph of Γ associated with generators g_k . Since they are free, the Cayley graph is an infinite tree each vertex of which has multiplicity $2p$: cf. Fig. 4 illustrating this for the case $p = 2$.

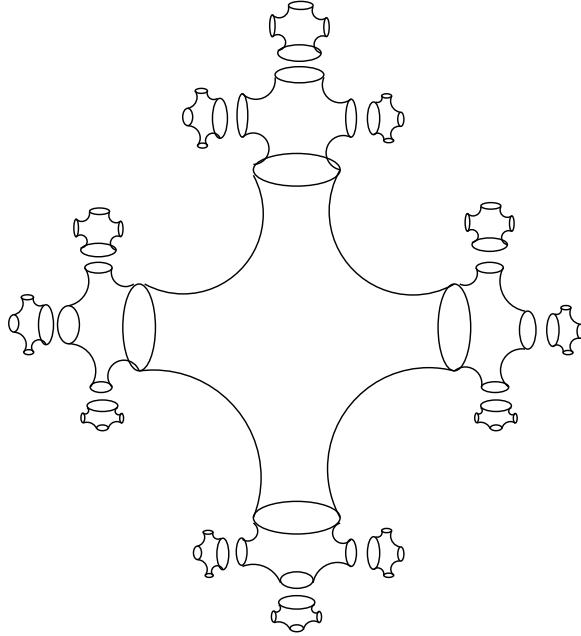

Fig. 4

As above, X_Γ can be identified with the boundary at infinity of \mathcal{X}_Γ : the set of equivalence classes of unbounded ends of geodesics in \mathcal{X}_Γ modulo the relation “distance = 0.”

A marking of Γ induces a marking of the 1–homology group $H_1(X_\Gamma, \mathbf{Z})$. Concretely, denote by a_k the class of the image of C_{p+k} (with its natural orientation.) Choose some points $x_k \in C_k$, $k = 1, \dots, p$, and pairwise disjoint oriented paths from x_k to $g_k(x_k)$ lying in $X_{0,\Gamma}$. Denote by b_k their classes in $H_1(X_\Gamma, \mathbf{Z})$. Clearly, $\{a_k, b_l\}$ form a basis of this group, satisfying $(a_k, a_l) = (b_k, b_l) = 0$, $(a_k, b_l) = \delta_{kl}$. Moreover, a_k generate the kernel of the map $H_1(X_\Gamma, \mathbf{Z}) \rightarrow H_1(\overline{\mathcal{X}}_\Gamma, \mathbf{Z})$ induced by the inclusion of the boundary.

The complement $\Lambda_\Gamma := P(V) \setminus \Omega_\Gamma$ is the minimal non–empty Γ –invariant set. Equivalently, it is the closure of the set of all fixed points $z^\pm(g)$, $g \in \Gamma, g \neq \text{id}$, or else the set of limit points of any orbit Γz_0 , $z_0 \in \mathbf{H}_V \cup P(V)$.

If $g = 1$, Λ_Γ consists of two points which can be chosen as $0, \infty$. For $g \geq 2$, Λ_Γ generally is an uncountable Cantor set (fractal). This is the main source of complications (and interesting developments). Denote by $a(\Gamma)$ the Hausdorff dimension of $\Lambda(\Gamma)$. It can be characterized as the convergence abscissa of any Poincaré series

$$\sum_{g \in \Gamma} \left| \frac{dg(z)}{dz} \right|^s$$

where z is any coordinate function on $P(V)$ with a zero and a pole in Ω_Γ . Generally $0 < a(\Gamma) < 2$. Convergence of our holography formulas below will hold only for $a(\Gamma) < 1$. For other characterizations of $a(\Gamma)$, see [Man2], p. 236, and the references therein.

Geodesics in the bulk space \mathbf{H}_V with ends on Λ_Γ become exactly all bounded geodesics in the quotient \mathcal{X}_Γ . Their convex hull \mathcal{C}_Γ is called the convex core of \mathcal{X}_Γ . The group Γ is geometrically finite if the convex core \mathcal{C}_Γ is of finite volume. In this case, the core \mathcal{C}_Γ is a compact 3–manifold with boundary, which is homeomorphic to and a strong deformation retract of \mathcal{X}_Γ .

1.4.2. AdS and Euclidean black holes. Consider a Fuchsian Schottky group Γ acting on \mathbf{H}^2 . The resulting quotient space is a non–compact Riemann surface with a certain number of infinite ends. The genus of the surface and the number of ends depend on the Schottky group, for instance, both topologies shown in the Fig. 5 arise as quotients of \mathbf{H}^2 by a Schottky group with two generators.

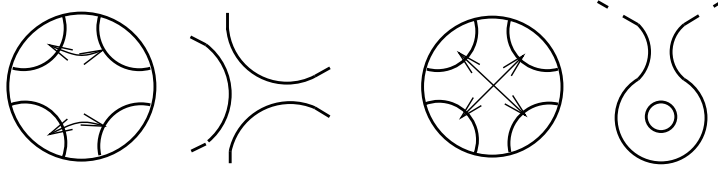

Fig. 5

An asymptotically AdS non-spinning black hole is obtained by extending these identifications globally to AdS_{2+1} , or, in other words, by evolving the $t = 0$ slice forward and backward in time. The geodesic surfaces extending the geodesics in the boundary of the fundamental domain in the $t = 0$ slice develop singularities in both forward and backward direction (see [ABBHP], [Kr1]) as illustrated in Fig. 6.

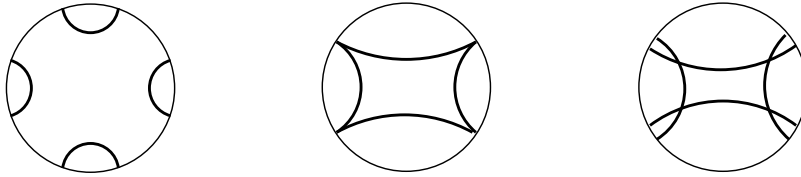

Fig. 6

The procedure used by Krasnov [Kr1] to construct the Euclidean version of these black holes follows the same line as in the case of the BTZ black hole, namely, the $t = 0$ slice is identified with a hyperplane in \mathbf{H}^3 and the geodesics in this hyperplane are continued to geodesic surfaces in \mathbf{H}^3 . The resulting quotients are special cases (non-rotating black holes) of the handlebodies \mathcal{X}_Γ constructed above in 1.4.1, in the case of real Schottky parameters. The general case of 1.4.1 includes also the more general case of spinning black holes considered by Krasnov in [Kr4].

Since Fuchsian Schottky groups are classical Schottky groups, the black holes obtained by the construction of Krasnov as Euclidean versions of the AdS black holes of [ABBHP] are quotients of \mathbf{H}^3 by a classical Schottky group on p generators, and the fundamental domain is a region in \mathbf{H}^3 delimited by $2p$ pairwise disjoint geodesic half spheres.

As observed in [BKS], the kinematic part of the Maldacena correspondence for spacetimes that are global quotients of \mathbf{H}^3 by a geometrically finite discrete group of isometries is provided by the correspondence between hyperbolic structures on

the bulk space and conformal structures on the boundary at infinity, [Sul]. (cf. also [Kh] on the correspondence between hyperbolic and conformal geometry viewed in the light of holography.) Below we will complement this by providing some dynamical content for the case of the Krasnov black holes.

1.5. Abelian differentials and Green functions on Schottky covers. In this subsection, we will calculate Green's functions of the form (1.2) for curves with a Schottky cover. The differentials of the third kind which can be obtained by a direct averaging of simple functions do not necessarily have pure imaginary periods. To remedy this, we will have to subtract from them some differentials of the first kind. Therefore we will start with the latter.

1.5.1. Differentials of the first kind. In the genus one case, if z is the projective coordinate whose divisor consists of the attractive and repelling point of a generator of Γ , a differential of the first kind can be written as

$$\omega = d \log z = d \log \frac{w_{(0)-(\infty)}(z)}{w_{(0)-(\infty)}(z_0)} = d \log \langle 0, \infty, z, z_0 \rangle$$

where z_0 is any point $\neq 0, \infty$. Generally, an appropriate averaging of this formula produces a differential of the first kind ω_g for any $g \in \Gamma$. In the following we assume that a marking of Γ is chosen. Denote by $C(|g)$ a set of representatives of $\Gamma/(g^{\mathbf{Z}})$, by $C(h|g)$ a similar set for $(h^{\mathbf{Z}}) \setminus \Gamma/(g^{\mathbf{Z}})$, and by $S(g)$ the conjugacy class of g in Γ . Then we have for any $z_0 \in \Omega_\Gamma$:

1.5.2. Proposition. (a) *If $a(\Gamma) < 1$, the following series converges absolutely for $z \in \Omega_\Gamma$ and determines (the lift to Ω_Γ of) a differential of the first kind on X_Γ :*

$$\omega_g = \sum_{h \in C(|g)} d_z \log \langle h z^+(g), h z^-(g), z, z_0 \rangle. \quad (1.12)$$

This differential does not depend on z_0 , and depends on g additively.

If the class of g is primitive (i. e. non-divisible in H), ω_g can be rewritten as

$$\omega_g = \sum_{h \in S(g)} d_z \log \langle z^+(h), z^-(h), z, z_0 \rangle. \quad (1.13)$$

(b) *If g_k form a part of the marking of Γ , and a_k are the homology classes described in 1.4.1 (iii), we have*

$$\int_{a_k} \omega_{g_l} = 2\pi i \delta_{kl}. \quad (1.14)$$

It follows that the map $g \bmod [\Gamma, \Gamma] \mapsto \omega_g$ embeds $H := \Gamma/[\Gamma, \Gamma]$ as a sublattice in the space of all differentials of the first kind.

(c) Denote by $\{b_l\}$ the complementary set of homology classes in $H_1(X_\Gamma, \mathbf{Z})$ as in 1.4.1. Then we have for $k \neq l$, with an appropriate choice of logarithm branches:

$$\tau_{kl} := \int_{b_k} \omega_{g_l} = \sum_{h \in C(g_k | g_l)} \log \langle z^+(g_k), z^-(g_k), h z^+(g_l), h z^-(g_l) \rangle. \quad (1.15)$$

Finally

$$\tau_{kk} = \log q(g_k) + \sum_{h \in C_0(g_k | g_k)} \log \langle z^+(g_k), z^-(g_k), h z^+(g_k), h z^-(g_k) \rangle. \quad (1.16)$$

where in $C_0(g_k | g_k)$ is $C(g_k | g_k)$ without the identity class.

For proofs, see [Man2], §8, and [ManD]. Notice that our notation here slightly differs from [Man2]; in particular, τ_{kl} here corresponds to $2\pi i \tau_{kl}$ of [Man2].

In the holography formulas below we will use (1.15) and (1.16) in order to calculate $\text{Re } \tau_{kl}$. The ambiguity of phases can then be discarded, and the cross-ratios must be replaced by their absolute values. Each resulting term can then be interpreted via a configuration of geodesics in the bulk spaces \mathbf{H}^3 and \mathcal{X}_Γ , similar to those displayed in Fig. 3a and Fig. 3b.

1.5.3. Differentials of the third kind and Green's functions. Let now $a, b \in \Omega_\Gamma$. Again assuming $a(\Gamma) < 1$, we see that the series

$$\nu_{(a)-(b)} := \sum_{h \in \Gamma} d_z \log \langle a, b, h z, h z_0 \rangle \quad (1.17)$$

absolutely converges and represents the lift to Ω_Γ of a differential of the third kind with residues ± 1 at the images of a, b . Moreover, its a_k periods vanish. Therefore, any linear combination $\nu_{(a)-(b)} - \sum_l X_l(a, b) \omega_{g_l}$ with real coefficients X_l will have pure imaginary a_k -periods in view of (1.14). If we find X_l so that the real parts of the b_k -periods of $\omega_{(a)-(b)} := \nu_{(a)-(b)} - \sum_l X_l(a, b) \omega_{g_l}$ vanish, we will be able to use this differential in order to calculate conformally invariant Green's functions. Hence our final formulas look as follows.

Equations for calculating $X_l(a, b)$:

$$\sum_{l=1}^p X_l(a, b) \text{Re } \tau_{kl} = \text{Re} \int_{b_k} \nu_{(a)-(b)} = \sum_{h \in S(g_k)} \log |\langle a, b, z^+(h), z^-(h) \rangle|. \quad (1.18)$$

Here k runs over $1, \dots, p$, $\text{Re } \tau_{kl}$ are calculated by means of (1.15) and (1.16), and b_k -periods of $\nu_{(a)-(b)}$ are given in §8 of [Man2].

Moreover,

$$\text{Re} \int_d^c \nu_{(a)-(b)} = \sum_{h \in \Gamma} \log |\langle a, b, hc, hd \rangle|, \quad (1.19)$$

$$\text{Re} \int_d^c \omega_{g_l} = \sum_{h \in S(g_l)} \log |\langle z^+(h), z^-(h), c, d \rangle|, \quad (1.20)$$

Hence finally

$$g((a) - (b), (c) - (d)) = \sum_{h \in \Gamma} \log |\langle a, b, hc, hd \rangle| - \sum_{l=1}^p X_l(a, b) \sum_{h \in S(g_l)} \log |\langle z^+(h), z^-(h), c, d \rangle|. \quad (1.20)$$

Here we have to thank Annette Werner for correcting the last formula in [Man2].

1.6. Discussion. (i) The most straightforward way to interpret formulas (1.3), (1.4), (1.11), (1.20) is to appeal to the picture of holographic particle detection of [BR]. In this picture, Green functions on the boundary detect geodesic movement and collisions of massive particles in the bulk space. Particles, being local objects, exist in the semiclassical limit.

More precisely, consider in the bulk space the theory of a scalar field of mass m . The propagator, in the notation of [BR] p.7, is

$$G(B(z), B(-z)) = \int \mathcal{D}P e^{i\Delta\ell(P)}, \quad (1.21)$$

where $\ell(P)$ is the length of the path P , $\Delta = 1 + \sqrt{1 + m^2}$, and the points $B(\pm z)$ in the bulk space correspond to some parameterized curve $b(\pm z)$ on the boundary at infinity, in the sense that the $B(\pm z)$ lie on a hypersurface obtained by introducing a cutoff on the bulk space.

In the semiclassical WKB approximation, the right hand side of (1.21) localizes at the critical points of action. Thus, it becomes a sum over geodesics connecting the points $B(\pm z)$,

$$G(B(z), B(-z)) = \sum_{\gamma} e^{-\Delta\ell(\gamma)}. \quad (1.22)$$

This has a logarithmic divergence when the cutoff $\epsilon \rightarrow 0$, that is, when the points $B(\pm z)$ approach the corresponding points on the boundary at infinity.

On the other hand, for the CFT on the boundary (in the case where the bulk space is just AdS_3), the boundary propagator is taken in the form in the form (pp. 6–7 of [BR])

$$\langle O(x), O(x') \rangle = \frac{1}{|x - x'|^{2\Delta}}.$$

In the case where the bulk space is globally AdS_3 , there is an identification of the propagators as the cutoff parameter $\epsilon \rightarrow 0$

$$T(z) \equiv \log G(B(z), B(-z)),$$

after removing the logarithmic divergence, where

$$T(z) = \log \langle O(b(z)), O(b(-z)) \rangle.$$

The appearance of the geodesic propagator (1.21) in the bulk space, written in the form (1.22) is somewhat similar to our exact formulas written in terms of geodesic configurations.

Moreover, passing to the Euclidean case, and reading our formula (1.3) for the genus zero case in this context provides a neater way of identifying propagators on bulk and boundary which does not require any cutoff. For assigned points on the boundary $\mathbf{P}^1(\mathbf{C})$, instead of choosing corresponding points in the bulk space $B(\pm z)$ with the help of a cutoff function and then comparing propagators in the limit, any choice of a divisor $(a) - (b)$ determines the points in the bulk space $a * \{c, d\}$ and $b * \{c, d\}$ in \mathbf{H}^3 , for boundary points $c, d \in \mathbf{P}^1(\mathbf{C})$, and a corresponding exact identification of the propagators.

If we then let $a \rightarrow c$ and $b \rightarrow d$, in (1.3) both the Green function and the geodesic length have a logarithmic divergence, as the points $a * \{c, d\}$ and $b * \{c, d\}$ also tend to the boundary points c and d , and this recovers the identification of the propagators used by the physicists as a limit case of formula (1.3), without any need to introduce cutoff functions.

Notice, moreover, that the procedure of §1.5.3, and in particular our (1.18) to compute the coefficients $X_l(a, b)$ is analogous to the derivation of the bosonic field propagator for algebraic curves in [FeSo], with the sole difference that, in the linear combination

$$\omega_{(a)-(b)} := \nu_{(a)-(b)} - \sum_l X_l(a, b) \omega_{g_l},$$

cf. equation (3.6) of [FeSo], the differentials of the third kind $\nu_{(a)-(b)}$ are determined in our (1.17) by the data of the Schottky uniformization, while, in the case considered in [FeSo], they are obtained by describing the algebraic curve as a branched cover of $\mathbf{P}^1(\mathbf{C})$. Then our (1.18) corresponds to (3.9) of [FeSo], and Proposition

1.5.2 shows that the bosonic field propagator on the algebraic curve $X(\mathbf{C})$, described by the Green function, can be expressed in terms of geodesics in the bulk space.

(ii) K. Krasnov in [Kr1] (cf. also [Kr2]–[Kr4]) establishes another holography correspondence which involves CFT interpreted as geometry of the Teichmüller or Schottky moduli space rather than that of an individual Riemann surface and its bulk handlebody. In his picture, the relevant CFT theory is the Liouville theory (existence of which is not yet fully established). An appropriate action for Liouville theory in terms of the Schottky uniformization was suggested L. Takhtajan and P. Zograf in [TaZo]. Krasnov identifies the value of this action at the stationary (“uniformizing”) point with the regularized volume of the respective Euclidean bulk space. According to [TaZo], this value provides the Kähler potential for the Weil–Petersson metric on the moduli space.

It would be interesting to clarify the geometric meaning of Krasnov’s regularized volume. Can it be calculated through the volume of the convex core of the bulk space? In the genus one case the answer is positive: both quantities are proportional to the length of the closed geodesic.

A recent preprint of J. Brock [Br1] establishes an approximate relationship between the Weil–Petersson metric and volumes of convex cores in a different, but related situation. Namely, instead of giving a local formula for the WP–distance “at a point” X , it provides an approximate formula for this distance between two Riemann surfaces X, Y which are far apart. The handlebody \mathcal{X} filling X is replaced by the quasi–Fuchsian hyperbolic 3–manifold $Q(X, Y)$ arising in the Bers simultaneous uniformization picture ([Be]) and having $X \cup Y$ as its conformal boundary at infinity. It turns out that at large distances $\ell_{WP}(X, Y)$ is comparable with the volume of *core* $Q(X, Y)$.

We expect that an exact formula relating these two quantities exists and might be derived using a version of Krasnov’s arguments.

In fact, the Krasnov black holes also have a description in terms of Bers simultaneous uniformization. By the results of Bowen [Bow], a collection C_0 of pairwise disjoint rectifiable arcs in $X_{0,\Gamma}$ with ends at $x_k \in C_k$ and $g_k(x_k)$, as described in §1.4.1(iii), determine a quasi–circle $C = \cup_{\gamma \in \Gamma} \gamma C_0$. The quotient $(C \cap \Omega_\Gamma)/\Gamma$ consists of a collection of closed curves in X_Γ whose homology classes give the b_k of §1.4.1(iii). The quasi–circle C divides $\mathbf{P}^1(\mathbf{C})$ into two domains of Bers simultaneous uniformization, with the handlebody \mathcal{X}_Γ (topologically a product of a non–compact Riemann surface and an interval) in the role of $Q(X, Y)$. This fits in with the results of Krasnov on the generally rotating case of Krasnov black holes discussed in [Kr4].

1.7. Non-archimedean holography. According to various speculations, space-time at the Planck scale should be enriched with non-archimedean geometry, possibly in adèlic form, so that space-time can be seen simultaneously at all non-archimedean and archimedean places. From this perspective, it is worth observing that the holography correspondence described in §1 admits a natural extension to the non-archimedean setting. In fact, the results of [Man2] on the Green functions on Riemann surfaces with Schottky uniformization and configurations of geodesics in the bulk space were motivated by the theory of p -adic Schottky groups and Mumford curves: cf. [Mum], [ManD], [GvP].

In the non-archimedean setting, we consider a finite extension K of \mathbf{Q}_p . Anti de Sitter space, or rather its Euclidean analog \mathbf{H}^3 , is replaced by the Bruhat-Tits tree \mathcal{T} with the set of vertices

$$\mathcal{T}^0 = \{A\text{-lattices of rank 2 in a 2-dim } K\text{-space } V\}/K^* \quad (1.22)$$

where A is the ring of integers of K . Vertices have valence $|\mathbf{P}^1(A/\mathfrak{m})|$, where \mathfrak{m} is the maximal ideal, and the length of each edge connecting two nearby vertices is $\log |A/\mathfrak{m}|$. The set of ends of the tree \mathcal{T} can be identified with $\mathbf{P}^1(K)$: this is the analog of the conformal boundary.

The analog in [ManD] of the formulas of Lemma 1.1.3, gives a quantitative formulation of the holographic correspondence in this non-archimedean setting, with the basic Green function on \mathcal{T} given by

$$G_{\mu(u)}(x, y) = \text{dist}_{\mathcal{T}}(u, \{x, y\}), \quad (1.23)$$

where the metric on the Bruhat-Tits tree \mathcal{T} is defined by assigning the length $\log |A/\mathfrak{m}|$ to each edge, so that (1.23) computes the length of the shortest chain of edges connecting the vertex u to the doubly infinite path in the tree containing the vertices x, y .

A triple of points in $\mathbf{P}^1(K)$ determines a unique vertex $v \in \mathcal{T}^0$ where the three ends connecting v to the given points in $\mathbf{P}^1(K)$ start along different edges. This configuration of edges is called a ‘‘cross-roads’’ in [Man2]. It provides an analog of the Feynman diagram of §2.4 of [Wi], where currents are inserted at points on the boundary and the interaction takes place in the interior, with half infinite paths in the Bruhat-Tits tree acting as the gluon propagators. Such propagators admit a nice arithmetic description in terms of reduction modulo the maximal ideal \mathfrak{m} .

For a subgraph of \mathcal{T} given by the half infinite path starting at a given vertex $v \in \mathcal{T}^0$ with end $x \in \mathbf{P}^1(K)$, let $\{v_0 = v, v_1, \dots, v_n \dots\}$ be the sequence of vertices along this path. We can define a ‘non-archimedean gluon propagator’ as such a graph together with the maps that assign to each finite path $\{v_0, \dots, v_n\}$ the reduction of x modulo \mathfrak{m}^n .

Consider the example of the elliptic curve with the Jacobi–Tate uniformization $K^*/(q^{\mathbf{Z}})$, with $q \in K^*$, $|q| < 1$. The group $q^{\mathbf{Z}}$ acts on \mathcal{T} like the cyclic group generated by an arbitrary hyperbolic element $\gamma \in PGL(2, K)$. The unique doubly infinite path in \mathcal{T} with ends at the pair of fixed points x^{\pm} of γ in $\mathbf{P}^1(K)$ gives rise to a closed ring in the quotient \mathcal{T}/Γ .

The quotient space \mathcal{T}/Γ is the non–archimedean version of the BTZ black hole, and this closed ring is the event horizon. From the vertices of this closed ring infinite ends depart, which correspond to the reduction map $X(K) \rightarrow X(A/\mathfrak{m})$.

Subgraphs of the graph \mathcal{T}/Γ correspond to all possible Feynman diagrams of propagation between boundary sources on the Tate elliptic curve $X(K)$ and interior vertices on the closed ring.

In the case of higher genus, the Schottky group Γ is a purely loxodromic free discrete subgroup of $PSL(2, K)$ of rank $g \geq 2$. The doubly infinite paths in \mathcal{T} with ends at the pairs of fixed points $x^{\pm}(\gamma)$ of the elements $\gamma \in \Gamma$ realize \mathcal{T}_{Γ} as a subtree of \mathcal{T} . This is the analog of realizing the union of fundamental domains $\cup_{\gamma} \gamma(\mathcal{F})$ as a tubular neighborhood of the Cayley graph of Γ in the archimedean case. The ends of the subtree \mathcal{T}_{Γ} constitute the limit set $\Lambda_{\Gamma} \subset \mathbf{P}^1(K)$. The complement $\Omega_{\Gamma} = \mathbf{P}^1(K) \setminus \Lambda_{\Gamma}$ gives the uniformization of the Mumford curve $X(K) \simeq \Omega_{\Gamma}/\Gamma$. This, in turn, can be identified with the ends of the quotient graph \mathcal{T}/Γ .

The quotients $\mathcal{X}_{\Gamma} = \mathcal{T}/\Gamma$ are non–archimedean Krasnov black holes, with boundary at infinity the Mumford curve $X(K)$. Currents at points in $X(K)$ propagate along the half infinite paths in the black hole that reaches a vertex on $\mathcal{T}_{\Gamma}/\Gamma$. Propagation between interior points happen along edges of $\mathcal{T}_{\Gamma}/\Gamma$, and loops in this graph give rise to quantum corrections to the correlation functions of currents in the boundary field theory, as happens with the Feynman diagrams of [Wi].

1.8. Holography and arithmetic topology. We have seen that, for an arithmetic surface $X_{\mathbf{Z}} \rightarrow \text{Spec } \mathbf{Z}$, it is possible to relate the geometry at arithmetic infinity to the physical principle of holography. Over a prime p , in the case of curves with maximally degenerate reduction, it is also possible to interpret the resulting Mumford theory of p –adic Schottky uniformization in terms of an arithmetic version of the holography principle. One can therefore formulate the question of whether some other arithmetic analog of holography persists for closed fibers $X_{\mathbf{Z}} \bmod p$.

A very different picture of the connection between 3–manifolds and arithmetics exists in the context of *arithmetic topology*, a term introduced by Reznikov [Rez] to characterize a dictionary of analogies between number fields and 3–manifolds. See also a nice overview by McMullen [Mc].

According to this dictionary, if L is a number field and \mathcal{O}_L its ring of algebraic integers, then $B = \text{Spec } \mathcal{O}_L$ is an analog of a 3–manifold, with primes representing

loops (knots in a 3–manifold). In our case, with $B = \text{Spec } \mathbf{Z}$, the local fundamental group $\text{Gal}(\bar{\mathbf{F}}_p/\mathbf{F}_p) \cong \hat{\mathbf{Z}}$ is generated by the Frobenius $\sigma_p : x \mapsto x^p$ acting on $\bar{\mathbf{F}}_p$.

The fiber of X over a prime p , in the dictionary of arithmetic topology, may be regarded as a 3–manifold that fibers over a circle. In fact, for a fixed prime ℓ , let S be the union of ℓ and the set of primes where X has bad reduction. Let $B = \text{Spec } S^{-1}\mathbf{Z}$. This satisfies $\hat{\pi}_1(B) = \text{Gal}(\bar{\mathbf{Q}}_S/\mathbf{Q})$. For $p \notin S$, the ℓ –adic Galois representation

$$\hat{\rho}_\ell : \text{Gal}(\bar{\mathbf{Q}}_S/\mathbf{Q}) \rightarrow \text{Aut}H_1(X, \mathbf{Z}_\ell) = GL(2g, \mathbf{Z}_\ell)$$

gives an arithmetic version of the monodromy, see [Mc], with the Frobenius σ_p that lifts to an element of $\text{Gal}(\bar{\mathbf{Q}}_S/\mathbf{Q})$. In the arithmetic topology dictionary, a prime p corresponds to a “loop” in the “3–manifold” B , hence the fiber $X_{\mathbf{Z}} \bmod p$ together with the Frobenius element σ_p can be regarded as the data of a 3–manifold that fibers over the “circle” p .

The question of a holographic correspondence for these arithmetic analogs of mapping tori may be related to results of J.Brock [Br2] on 3–manifolds that fiber over the circle, where the hyperbolic volume is related to the translation length of the monodromy, in the same way that relates the hyperbolic volume of the convex core to the Weil–Petersson distance of the surfaces at infinity in the case of Bers’ simultaneous uniformization in the main result of [Br1].

In our perspective, this result of [Br2] can be regarded as an extension of a form of holographic correspondence from the case of hyperbolic 3–manifolds with infinite ends and asymptotic boundary surfaces, to the case of a compact hyperbolic 3–manifolds which fibers over the circle, with the information previously carried by the boundary at infinity now residing in the fiber and monodromy. Thus, it is possible to ask whether, under the dictionary of arithmetic topology, a similar form of holographic correspondence exists for the fibers $X_{\mathbf{Z}} \bmod p$ regarded as arithmetic analogs of a 3–manifold fibering over the circle with monodromy σ_p . It is possible that such correspondence may be related to another analogy of arithmetic topology, which interprets the quantity $|\text{Tr}(\sigma_p)|$ as a measure of the “hyperbolic length” of the loop representing the prime p (cf. [Mc] Remark on p.134).

§2. Modular curves as holograms

In this section we suggest a different type of holography correspondence, this time related to AdS_{1+1} and its Euclidean version \mathbf{H}^2 .

In the case we consider, the bulk spaces will be modular curves. They are global quotients of the hyperbolic plane \mathbf{H}^2 by a finite index subgroup G of $PSL(2, \mathbf{Z})$. We identify \mathbf{H}^2 with the upper complex half–plane endowed with the metric dx^2/y^2 of curvature -1 . Its boundary at infinity is then $\mathbf{P}^1(\mathbf{R})$.

Modular curves have a very rich arithmetic structure, forming the essential part of the moduli stack of elliptic curves. In this classical setting, the modular curves have a natural algebro–geometric compactification, which consists of adding finitely many points at infinity, the cusps $G \backslash \mathbf{P}^1(\mathbf{Q})$. Cusps are the only boundary points at which G acts discretely (with stabilizers of finite index). The remaining part of the conformal boundary (after factorization) is not visible in algebraic (or for that matter analytic or C^∞) geometry, because irrational orbits of G in $\mathbf{P}^1(\mathbf{R})$ are dense.

In [ManMar] and [Mar] some aspects of the classical geometry and arithmetics of modular curves, such as modular symbols, the modular complex, and certain classes of modular forms, are recovered in terms of the non–commutative boundary $G \backslash \mathbf{P}^1(\mathbf{R})$ which is a non–commutative space in the sense of Connes, that is, a C^* –algebra Morita equivalent to the crossed product of G acting on some function ring of $\mathbf{P}^1(\mathbf{R})$. This way, the full geometric boundary of $\mathbf{P}^1(\mathbf{R})$ of \mathbf{H}^2 is considered as part of the compactification, instead of just $\mathbf{P}^1(\mathbf{Q})$. We argue here that this is the right notion of boundary to consider in order to have a holography correspondence for this class of bulk spaces. In particular, since we strive to establish that the bulk spaces and their boundaries carry essentially the same information, we call the quotients $G \backslash \mathbf{P}^1(\mathbf{R})$ *non–commutative modular curves*.

2.1. Non–commutative modular curves. In the following $\Gamma = PSL(2, \mathbf{Z})$ and G is a finite index subgroup of Γ . Denoting by \mathbf{P} the coset space $\mathbf{P} = \Gamma/G$, we can represent the modular curve $X_G := G \backslash \mathbf{H}^2$ as the quotient

$$X_G = \Gamma \backslash (\mathbf{H}^2 \times \mathbf{P}), \quad (2.1)$$

and its non–commutative boundary as the C^* –algebra

$$C(\mathbf{P}^1(\mathbf{R}) \times \mathbf{P}) \rtimes \Gamma \quad (2.2)$$

Morita equivalent to $C(\mathbf{P}^1(\mathbf{R})) \rtimes G$.

There is a dynamical system associated to the equivalence relation defined by the action of a Fuchsian group of the first kind on its limit set, as in the case of our $G \backslash \mathbf{P}^1(\mathbf{R})$. The dynamical system can be described as a Markov map $T_G : S^1 \rightarrow S^1$ as in [BowSer].

In [ManMar] we gave a different formulation in terms of a dynamical system related to the action of Γ on $\mathbf{P}^1(\mathbf{R}) \times \mathbf{P}$. This dynamical system generalizes the classical shift of the continued fraction expansion in the form

$$T : [0, 1] \times \mathbf{P} \rightarrow [0, 1] \times \mathbf{P}$$

$$T(x, t) = \left(\frac{1}{x} - \left\lfloor \frac{1}{x} \right\rfloor, \left(\begin{array}{cc} -[1/x] & 1 \\ 1 & 0 \end{array} \right) \cdot t \right). \quad (2.3)$$

Some aspects of the non-commutative geometry at the boundary of modular curves can be derived from an analysis of the ergodic theory of this dynamical system, cf. [ManMar], [Mar].

2.2. Holography. The 1 + 1-dimensional Anti de Sitter space-time AdS_{1+1} has $SL(2, \mathbf{R})$ as group of isometries. Passing to Euclidean signature, AdS_{1+1} is replaced by \mathbf{H}^2 , so that we can regard the modular curves X_G as Euclidean versions of space-times obtained as global quotients of AdS_{1+1} by a discrete subgroup of isometries. Notice that, unlike the case of spacetimes with AdS_{2+1} geometry, the case of AdS_{1+1} space-times is relatively little understood, though some results on AdS_{1+1} holography are formulated in [MMS], [Str]. We argue that one reason for this is that a picture of holography for AdS_{1+1} space-times should take into account the possible presence of non-commutative geometry at the boundary.

There are three types of results from [ManMar] that can be regarded as manifestations of the holography principle. On the bulk space, these results can be formulated in terms of the Selberg zeta function, of certain classes of modular forms of weight two, and of modular symbols, respectively.

2.2.1. Selberg zeta function. In order to formulate our first results, we consider the Ruelle transfer operator for the shift (2.3),

$$(L_s f)(x, t) = \sum_{k=1}^{\infty} \frac{1}{(x+k)^{2s}} f\left(\frac{1}{x+k}, \begin{pmatrix} 0 & 1 \\ 1 & k \end{pmatrix} \cdot t\right). \quad (2.4)$$

On a suitable Banach space of functions (cf. [May], [ManMar]), the operator L_s is nuclear of order zero for $Re(s) > 1/2$, hence it has a Fredholm determinant

$$\det(1 - L_s) = \exp\left(-\sum_{\ell=1}^{\infty} \frac{\text{Tr} L_s^\ell}{\ell}\right). \quad (2.5)$$

The Selberg zeta function for the modular curve X_G encodes the length spectrum of the geodesic flow. Via the Selberg trace formula, this function also encodes information on the spectral properties of the Laplace-Beltrami operator. In terms of closed geodesics, we have

$$Z_G(s) = \prod_{\gamma \in \text{Prim}} \prod_{m=0}^{\infty} \left(1 - e^{-(s+m)\text{length}(\gamma)}\right), \quad (2.6)$$

where Prim is the set of primitive closed geodesics in X_G . We have the following result [ManMar] (see also [ChMay], [LewZa1], [LewZa2], [May]).

2.2.2. Proposition. *Consider a finite index subgroup $G \subset \Gamma$, with $\Gamma = PSL(2, \mathbf{Z})$ or $PGL(2, \mathbf{Z})$. In the case $\Gamma = PGL(2, \mathbf{Z})$ we have*

$$Z_G(s) = \det(1 - L_s), \quad (2.7)$$

and in the case $\Gamma = PSL(2, \mathbf{Z})$ we have

$$Z_G(s) = \det(1 - L_s^2). \quad (2.8)$$

We can interpret this statement as an instance of holography correspondence, if we regard the left hand side of (2.7) and (2.8) as a partition function on the bulk space, and the right hand side as the corresponding boundary field theory. More precisely, the results of [Lew], [LewZa1], [LewZa2] provide an explicit correspondence between eigenfunctions of the transfer operator L_s and eigenfunctions of the Laplacian (Maass wave forms). This explicit transformation provides a kind of holography correspondence between fields on the bulk space and a theory on the boundary, which can be interpreted as a lattice spin system with the shift operator (2.3).

To make a connection to the point of view of Arakelov geometry considered in §1, it is known that the Arakelov Green function evaluated at two different cusps can be estimated in terms of the constant term of the Laurent expansion around 1 of the logarithmic derivative of the Selberg zeta function, e.g. in the case of $G = \Gamma_0(N)$. This means that, by Proposition 2.2.1, such estimates can be given in terms of the transfer operator L_s , which only depends on the boundary (2.2) of X_G .

2.2.3. Modular symbols. In the classical theory of modular curves, modular symbols are the homology classes

$$\varphi(s) = \{g(0), g(i\infty)\}_G \in H_1(X_G, \text{cusps}, \mathbf{Z}) \quad (2.9)$$

with $gG = s \in \mathbf{P}$, determined by the image in X_G of geodesics in \mathbf{H} with ends at points of $\mathbf{P}^1(\mathbf{Q})$.

In [ManMar] we have shown that the homology $H_1(X_G, \text{cusps}, \mathbf{Z})$ can be described canonically in terms of the boundary (2.2) in the following way.

2.2.4. Proposition. *In the case $\Gamma = PSL(2, \mathbf{Z}) = \mathbf{Z}/2 * \mathbf{Z}/3$, the Pimsner six term exact sequence ([Pim]) for the K -theory of the crossed product C^* -algebra (2.2) gives a map*

$$\alpha : K_0(C(\mathbf{P}^1(\mathbf{R}) \times \mathbf{P})) \rightarrow K_0(C(\mathbf{P}^1(\mathbf{R}) \times \mathbf{P}) \rtimes \mathbf{Z}/2) \oplus K_0(C(\mathbf{P}^1(\mathbf{R}) \times \mathbf{P}) \rtimes \mathbf{Z}/3).$$

The kernel of this map satisfies

$$Ker(\alpha) \cong H_1(X_G, \text{cusps}, \mathbf{Z}). \quad (2.10)$$

In particular, the modular symbols (2.9) are identified with elements in $\text{Ker}(\alpha)$:

$$\{g(0), g(i\infty)\}_G \leftrightarrow \delta_s - \delta_{\sigma(s)}, \quad (2.11)$$

where δ_s is the projector in $C(\mathbf{P}^1(\mathbf{R}) \times \mathbf{P})$ given by the function equal to one on the sheet $\mathbf{P}^1(\mathbf{R}) \times \{s\}$ and zero elsewhere.

Via the six terms exact sequence, the elements of $\text{Ker}(\alpha)$ can be identified with (the image of) elements in $K_0(C(\mathbf{P}^1(\mathbf{R}) \times \mathbf{P}) \rtimes \Gamma)$. Thus, modular symbols, that is, homology classes of certain geodesics in the bulk space correspond to (differences of) projectors in the algebra of observables on the boundary space.

2.2.5. Modular forms. Finally, we discuss from this perspective some results of [ManMar], [Mar], which give a correspondence between certain classes of functions on the bulk space and on the boundary.

As the class of functions on the boundary, we consider functions

$$\ell(f, \beta) = \sum_{k=1}^{\infty} f(q_k(\beta), q_{k-1}(\beta)). \quad (2.12)$$

Here f is a complex valued function defined on pairs of coprime integers (q, q') with $q \geq q' \geq 1$ and with $f(q, q') = O(q^{-\epsilon})$ for some $\epsilon > 0$, and $q_k(\beta)$ are the successive denominators of the continued fraction expansion of $\beta \in [0, 1]$. The summing over pairs of successive denominators is what replaces modularity, when “pushed to the boundary”.

We consider the case of $G = \Gamma_0(N)$, and the function

$$f(q, q') = \frac{q + q'}{q^{1+t}} \int_{\left\{0, \frac{q'}{q}\right\}_{\Gamma_0(N)}} \omega, \quad (2.13)$$

with ω such that the pullback $\pi_G^*(\omega)/dz$ is an eigenform for all Hecke operators. Consider the corresponding $\ell(f, \beta)$ defined as in (2.12). We have the following result.

2.2.6. Proposition. *For almost all β , the series (2.12) for the function (2.13) converges absolutely. Moreover, we have*

$$C(f, \beta) := \sum_{n=1}^{\infty} \frac{q_{n+1}(\beta) + q_n(\beta)}{q_{n+1}(\beta)^{1+t}} \left\{ 0, \frac{q_n(\beta)}{q_{n+1}(\beta)} \right\}_{\Gamma_0(N)} \quad (2.14)$$

which defines, for almost all β a homology class in $H_1(X_G, \text{cusps}, \mathbf{R})$ satisfying

$$\ell(f, \beta) = \int_{C(f, \beta)} \omega \quad (2.15)$$

with integral average

$$\int_{[0,1]} \ell(f, \beta) d\beta = \left(\frac{\zeta(1+t)}{\zeta(2+t)} - \frac{L_\omega^{(N)}(2+t)}{\zeta^{(N)}(2+t)^2} \right) \int_0^{i\infty} \Phi(z) dz, \quad (2.16)$$

with $L_\omega^{(N)}$ the Mellin transform of Φ with omitted Euler N -factor, and $\zeta(s)$ the Riemann zeta, with corresponding $\zeta^{(N)}$.

Results of this type can be regarded, on the one hand, as an explicit correspondence between a certain class of fields on the bulk space (Mellin transforms of modular forms of weight two), and the class of fields (2.12) on the boundary. It also provides classes (2.14) which correspond to certain configurations of geodesics in the bulk space. These can be interpreted completely in terms of the boundary. In fact the results of Proposition 2.2.4 can be rephrased also in terms of cyclic cohomology (cf. [ManMar], [Nis]), so that the classes (2.14) in $H_1(X_G, \text{cusps}, \mathbf{R})$ can be regarded as elements in the cyclic cohomology of the algebra (2.2). Thus, expressions such as the right hand side of (2.16), which express arithmetic properties of the modular curve can be recast entirely in terms of a suitable field theory on the boundary (2.2).

References

- [AhGuMOO] O. Aharony, S. Gubser, J. Maldacena, H. Ooguri, Y. Oz. *Large N field theories, string theory and gravity*. Phys. Rep. 323 (2000), no. 3-4, 183–386.
- [AlGo] E. Álvarez, C. Gómez. *Geometric holography, the renormalization group and the c-theorem*. Nuclear Phys. B 541 (1999), no. 1-2, 441–460.
- [ABMNV] L. Alvarez-Gaumé, J.-B. Bost, G. Moore, Ph. Nelson, and C. Vafa, *Bosonization on higher genus Riemann surfaces*. Comm. Math. Phys. 112(3) (1987), 503–552.
- [AMV] L. Alvarez-Gaumé, G. Moore, and C. Vafa, *Theta functions, modular invariance, and strings*. Comm. Math. Phys. 106(1) (1986), 1–40.
- [ABBHP] S. Åminneborg, I. Bengtsson, D. Brill, S. Holst, and P. Peldán, *Black holes and wormholes in 2 + 1 dimensions*. Classical and Quantum Gravity, 15(3) (1998), 627–644.
- [Ar] S. Ju. Arakelov, *An intersection theory for divisors on an arithmetic surface*. Izv. Akad. Nauk SSSR Ser. Mat. 38:1179–1192, 1974.
- [BR] V. Balasubramanian, S. Ross, *Holographic particle detection*. Phys. Rev. D (3) 61 (2000), no. 4, 12 pp.
- [BTZ] M. Bañados, C. Teitelboim, J. Zanelli, *Black hole in three-dimensional spacetime*. Phys. Rev. Lett. 69 (1992), no. 13, 1849–1851.

- [Be] L. Bers, *Simultaneous uniformization..* Bull. AMS 66 (1960), 94–97.
- [BKSW] D. Birmingham, C. Kennedy, S. Sen, and A. Wilkins, *Geometrical finiteness, holography, and the Bañados–Teitelboim–Zanelli black hole.* Phys. Rev. Lett. 82(21) (1999), 4164–4167.
- [Bow] R. Bowen. *Hausdorff dimension of quasicircles.* Inst. Hautes Études Sci. Publ. Math. 50, (1979), 11–25.
- [BowSer] R. Bowen, C. Series, *Markov maps associated with Fuchsian groups.* Inst. Hautes Études Sci. Publ. Math. 50 (1979), 153–170.
- [Br1] J. F. Brock. *The Weil–Petersson metric and volumes of 3-dimensional hyperbolic convex cores.* e-Print math.GT/0109048
- [Br2] J. F. Brock. *Weil–Petersson translation distance and volumes of mapping tori,* preprint arXiv:math.GT/0109050.
- [ChMay] C. H. Chang, D. H. Mayer, *Thermodynamic formalism and Selberg’s zeta function for modular groups.* Regul. Chaotic Dyn. 5(3) (2000), 281–312.
- [Fay] J. Fay. *Kernel functions, analytic torsion, and moduli spaces.* Memoirs of the AMS, vol. 96, N 464, AMS, Providence RA, 1992.
- [FeSo] F. Ferrari, J. Sobczyk, *Bosonic field propagators on algebraic curves.* J. Math. Phys. 41(9) (2000), 6444–6462.
- [GvP] L. Gerritzen, M. van der Put, *Schottky groups and Mumford curves.* Springer, 1980.
- [Kh] A. Kholodenko. *Boundary conformal field theories, limit sets of Kleinian groups and holography.* J. Geom. Phys. 35, N. 2-3 (2000), 193–238.
- [Kr1] K. Krasnov, *Holography and Riemann surfaces.* Adv. Theor. Math. Phys. 4(4) (2000).
- [Kr2] K. Krasnov, *3D gravity, point particles and Liouville theory.* e-Print arXiv:hep-th/0008253
- [Kr3] K. Krasnov, *On holomorphic factorization in asymptotically AdS 3D gravity.* e-Print arXiv:hep-th/0109198
- [Kr4] K. Krasnov, *Analytic continuation for asymptotically AdS 3D gravity.* e-Print arXiv:gr-qc/0111049.
- [Lew] J. Lewis, *Spaces of holomorphic functions equivalent to the even Maass cusp forms.* Invent. Math. 127(2) (1997), 271–306.
- [LewZa1] J. Lewis, D. Zagier, *Period functions and the Selberg zeta function for the modular group.* In: The Mathematical Beauty of Physics, Adv. Series in Math. Physics 24, World Scientific, Singapore, 1997, pp. 83–97.
- [LewZa2] J. Lewis, D. Zagier, *Period functions for Maass wave forms. I.* Ann. of Math. (2) 153(1) (2001), 191–258.

- [Mal] J. Maldacena. *The large N limit of superconformal field theories and supergravity*. Adv. Theor. Math. Phys. 2(2) (1998), 231–252.
- [MMS] J. Maldacena, J. Michelson, A. Strominger. *Anti-de Sitter fragmentation*. J. High Energy Phys. 1999, no. 2, Paper 11, 23 pp.
- [Man1] Yu. I. Manin. *The partition function of the Polyakov string can be expressed in terms of theta-functions*. Phys. Lett. B 172:2 (1986), 184–185.
- [Man2] Yu. I. Manin. *Three-dimensional hyperbolic geometry as ∞ -adic Arakelov geometry*. Invent. Math. 104(2) (1991), 223–243.
- [ManD] Yu. I. Manin, V. Drinfeld, *Periods of p -adic Schottky groups*, J. reine angew. Math. 262/263 (1973), 239–247.
- [ManMar] Yu. I. Manin, M. Marcolli, *Continued fractions, modular symbols, and non-commutative geometry*. e-Print arXiv:math.NT/0102006.
- [Mar] M. Marcolli, *Limiting modular symbols and the Lyapunov spectrum*. e-Print arXiv:math.NT/0111093.
- [May] D. H. Mayer, *Continued fractions and related transformations*. In: Ergodic Theory, Symbolic Dynamics and Hyperbolic Spaces, Eds. T. Bedford et al., Oxford University Press, Oxford 1991, pp. 175–222.
- [Mc] C. T. McMullen, *From dynamics on surfaces to rational points on curves*. Bull. Amer. Math. Soc. (N.S.) 37(2) (2000), 119–140.
- [Mum] D. Mumford, *An analytic construction of degenerating curves over complete local rings*. Compositio Math. 24 (1974), 129–174.
- [Nis] V. Nistor, *Group cohomology and cyclic cohomology of crossed products*, Invent. Math. 99 (1990), 411–424.
- [Pim] M. Pimsner. *KK -groups of crossed products by groups acting on trees*, Invent. Math. 86 (1986), 603–634.
- [RS] D. B. Ray and I. M. Singer. *Analytic torsion for complex manifolds*. Ann. of Math. (2), 98 (1973), 154–177.
- [Rez] A. Reznikov, *Three-manifolds class field theory*. Selecta Math. (N.S.) 3(3) (1997), 361–399.
- [Str] A. Strominger. *AdS_2 quantum gravity and string theory*. J. High Energy Phys. 1999, no. 1, Paper 7, 19 pp.
- [Sul] D. Sullivan. *On the ergodic theory at infinity of an arbitrary discrete group of hyperbolic motions*. In *Riemann surfaces and related topics: Proceedings of the 1978 Stony Brook Conference*, pp. 465–496, Princeton Univ. Press 1981.
- [Suss] L. Susskind. *The world as a hologram*. J. Math. Phys. 36 (1995), no. 11, 6377–6396.

[TaZo] L. Takhtajan, P. Zograf. *On uniformization of Riemann surfaces and the Weyl–Petersson metric on Teichmüller and Schottky spaces*. Math. USSR Sbornik, 60 (1988), 297–313.

[’tH] G. ’t Hooft. *Dimensional Reduction in Quantum Gravity*. e–Print arXiv:gr-qc/9310026.

[We] A. Werner. *Arakelov intersection indices of linear cycles and the geometry of buildings and symmetric spaces*. e–Print arXiv:math.AG/0006128.

[Wi] E. Witten, *Anti de Sitter space and holography*. Adv. Theor. Math. Phys. 2(2) (1998), 253–291.

[WiY] E. Witten, S.–T. Yau. *Connectedness of the boundary in the AdS/CFT correspondence*. Adv. Theor. Math. Phys. 3(6) (1999), 1635–1655 .