

# $B_s^0$ Decays and $B$ Leptonic Decays

R. Van Kooten

Indiana University, Physics Dept., Swain West 117, Bloomington, IN 47405, U.S.A.

Branching fractions of  $B_s^0$  decays into specific  $CP$  eigenstates are presented, and these and other results are combined in world averages to evaluate implications on the width difference between mass or  $CP$  eigenstates,  $\Delta\Gamma_s$ . New results on purely leptonic decays of  $B$  hadrons from the Tevatron and  $B$  factories are also presented.

## 1. Overview

Many results from the  $B_s^0$  system from the conference were presented elsewhere. First two-sided limits on the mass difference of eigenstates or particle-antiparticle oscillation frequency  $\Delta m_s$  were presented by DØ [1] and a first measurement by CDF [2]. Another parameter describing the  $B_s^0$  system is the width difference between eigenstates,  $\Delta\Gamma_s$ . Following an introduction to the theory of  $\Delta\Gamma_s$ , remaining  $B_s^0$  branching fraction results are described and combined with measurements of the  $B_s^0$  lifetime and  $\Delta\Gamma_s$  from other conference contributions [2, 3] to form a world average of  $\Delta\Gamma_s$  to compare with Standard Model (SM) predictions.

A very different topic of  $B$  leptonic decays is then covered. These decays, such as  $B_s^0 \rightarrow \ell^+ \ell^-$  are very sensitive to new physics. Others such as the first observation of  $B^+ \rightarrow \tau^+ \nu_\tau^1$  are sensitive both to new physics and to the value of the CKM matrix element  $V_{ub}$ .

## 2. Theory of $B_s^0$ System and $\Delta\Gamma_s$

The phenomenon of particle-antiparticle mixing and oscillations of neutral mesons is both a fascinating quantum mechanical system, and a sensitive probe of the flavor sector of the SM, parametrized by the CKM matrix. In particular, for the  $B_s^0$  system, we want to probe *all* parts of the matrix evolution equation:

$$i \frac{d}{dt} \begin{pmatrix} B_s^0 \\ \bar{B}_s^0 \end{pmatrix} = \begin{pmatrix} M - \frac{i\Gamma}{2} & M_{12} - \frac{i\Gamma_{12}}{2} \\ M_{12}^* - \frac{i\Gamma_{12}^*}{2} & M - \frac{i\Gamma}{2} \end{pmatrix} \begin{pmatrix} B_s^0 \\ \bar{B}_s^0 \end{pmatrix}. \quad (1)$$

In the SM,  $B_s^0$ - $\bar{B}_s^0$  mixing is caused by flavor-changing weak interaction box diagrams that induce non-zero off-diagonal elements in the above [4]. The mass eigenstates, defined as the eigenvectors of the above matrix, are different from the flavor eigenstates, with a heavy and light mass eigenstate, respectively:

$$|B_{sH}\rangle = p|B_s^0\rangle + q|\bar{B}_s^0\rangle; \quad |B_{sL}\rangle = p|B_s^0\rangle - q|\bar{B}_s^0\rangle, \quad (2)$$

with  $|p|^2 + |q|^2 = 1$ . If  $CP$  is conserved in mixing in the  $B_s^0$  system, then  $|q| = |p| = 1/\sqrt{2}$ , and

$$|B_{sH}\rangle = |B^{CP\text{-odd}}\rangle; \quad |B_{sL}\rangle = |B^{CP\text{-even}}\rangle, \quad (3)$$

i.e.,  $B^{CP\text{-odd}}$  is defined as the  $B_s^0$  state that does not decay to  $D_s^+ D_s^-$ . Matrix elements can be extracted experimentally by measuring a mass and width difference between eigenstates:

$$\begin{aligned} \Delta m_s &= M_H - M_L \approx 2|M_{12}|; \\ \Delta\Gamma_s &= \Gamma_L - \Gamma_H \approx 2|\Gamma_{12}| \cos\phi. \end{aligned} \quad (4)$$

Note the sign convention for  $\Delta\Gamma_s$  compared to  $\Delta m_s$ . In this convention, the SM prediction for  $\Delta\Gamma_s$  is positive. The phase angle  $\phi$  is expected to be small in the SM,  $\phi \approx 0.3^\circ$ , and  $\cos\phi$  is often assumed to be unity in  $\Delta\Gamma_s$  measurements. Finally, an average width is defined as  $\Gamma_s = (\Gamma_L + \Gamma_H)/2$ . Note that the measured lifetime of the  $B_s^0$  will depend on the mix of  $CP$  eigenstates involved in its decay. A more fundamental lifetime based on the average width is defined as  $\bar{\tau} = 1/\Gamma_s$ , with lifetimes of the light and heavy mass eigenstates defined as:  $\tau_L = 1/\Gamma_L$  and  $\tau_H = 1/\Gamma_H$ .

The parameter  $\Gamma_{12}$  is dominated by the decay path  $b \rightarrow c\bar{c}s$  in decays into final states common to both  $B_s^0$  ( $\bar{b}s$ ) and  $\bar{B}_s^0$  ( $b\bar{s}$ ). Examples of such decays are  $B_s^0 \rightarrow J/\psi\phi$  and  $B_s^0 \rightarrow D_s^{(*)+} D_s^{(*)-}$ , as shown in Fig. 1.

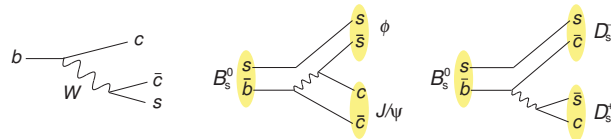

Figure 1: Example  $B_s^0$  decays giving rise to a non-zero  $\Gamma_{12}$ .

The analogous decay diagram for a width difference in the  $B_d^0$  system substitutes a  $d$  quark for the  $s$  quark. This decay is Cabibbo suppressed, hence  $\Delta\Gamma_d$  is negligible. In the case of  $\Delta\Gamma_s$ , decays into  $CP$ -even final states increase the value of  $\Delta\Gamma_s$ , while decays into  $CP$ -odd final states decrease it.

<sup>1</sup>Charge conjugate states are included implicitly throughout.

### 3. Measurements of $Br(B_s^0 \rightarrow D_s^{(*)+} D_s^{(*)-})$

The decay  $B_s^0 \rightarrow D_s^+ D_s^-$  is into a final state that is purely  $CP$  even. Under various theoretical assumptions [5], the inclusive decay into these ground states plus the excited states  $B_s^0 \rightarrow D_s^{(*)+} D_s^{(*)-}$  is also  $CP$  even to within 5%. This conclusion will likely need re-examination due to the restrictive assumptions taken; however, proceeding with this assumption, measurements of this branching fraction can be used to extract  $\Delta\Gamma_s$  (for the phase angle  $\phi = 0$ ):

$$\frac{\Delta\Gamma_s}{\Gamma_s} \approx \frac{2Br(B_s^0 \rightarrow D_s^{(*)+} D_s^{(*)-})}{1 - Br(B_s^0 \rightarrow D_s^{(*)+} D_s^{(*)-})/2}. \quad (5)$$

In the above and the following, since flavor tagging is *not* used, branching fractions include  $\bar{B}_s^0$  in the initial state and are properly averaged. There are new measurements for the branching fraction for this decay channel from CDF, DØ, and Belle. Only one measurement has been previously published [6] by ALEPH from a study of correlated  $\phi\phi$  production in  $Z^0$  decays.

#### 3.1. CDF Measurement of $Br(B_s^0 \rightarrow D_s^+ D_s^-)$

The CDF Collaboration uses 355 pb<sup>-1</sup> of data to fully reconstruct the decay  $B_s^0 \rightarrow D_s^+ D_s^-$  for the first time [7], where the  $D_s$  is reconstructed via fully hadronic decays  $D_s \rightarrow \phi(\rightarrow K^+ K^-)\pi$ ,  $3\pi$ , or  $K^* K$ . The rate is then normalized to the larger signal of  $B_s^0 \rightarrow D_s^+ D^-$ , where  $D^- \rightarrow K\pi\pi$ . In addition, many more hadronic channels with similar topology (decays into two secondary resonances with three tracks each) are studied in detail with larger statistics. Combining all  $D_s$  modes, CDF obtains a clean signal of  $23.5 \pm 5.5$  candidates with negligible background as shown in Fig. 2.

Using the PDG [8] value of  $Br(D_s \rightarrow \phi\pi)$ , CDF obtains as a preliminary result:

$$\frac{Br(B_s^0 \rightarrow D_s^+ D_s^-)}{Br(B_s^0 \rightarrow D_s^+ D^-)} = 1.67 \pm 0.41 (\text{stat.}) \pm 0.12 (\text{syst.}) \pm 0.24 (f_s/f_d) \pm 0.39 (Br_{\phi\pi}). \quad (6)$$

Work continues by CDF to use this ratio of branching fractions to extract  $\Delta\Gamma_s$ . Hints for the other modes into excited states exist, and there are good prospects with 1 fb<sup>-1</sup> of data.

#### 3.2. DØ Measurement of $Br(B_s^0 \rightarrow D_s^{(*)+} D_s^{(*)-})$

The DØ Collaboration has made a measurement [9] of the inclusive branching fraction  $Br(B_s^0 \rightarrow$

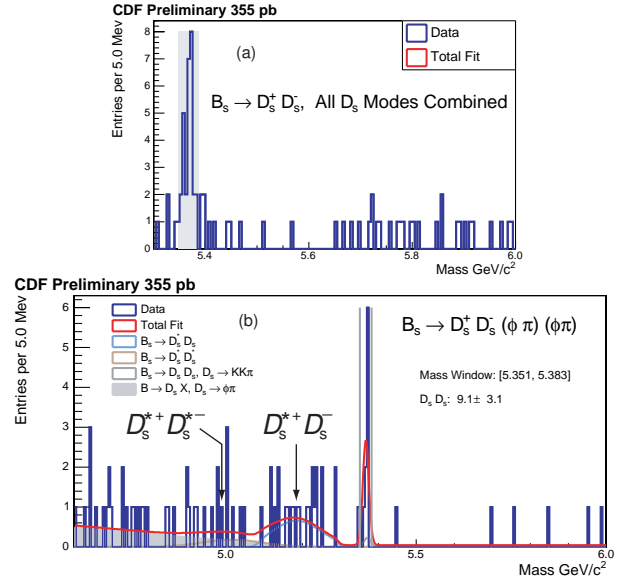

Figure 2: (a) CDF Combined  $B_s^0 \rightarrow D_s^+ D_s^-$  invariant mass plot. Grey band shows the 40 MeV wide signal region. (b)  $B_s^0 \rightarrow D_s^+ D_s^- (\phi\pi^+)(\phi\pi^-)$  wide range data fit.  $D_s^{(*)+} D_s^-$  and  $D_s^{(*)-} D_s^+$  modes fitted with templates are also shown.

$D_s^{(*)+} D_s^{(*)-}$ ), where one  $D_s^{(*)}$  is reconstructed in the hadronic mode  $\phi(\rightarrow K^+ K^-)\pi$ , and the other semileptonically into  $\phi\mu\nu$ . Normalization is made to large statistics decay mode  $B_s^0 \rightarrow D_s^{(*)+} \mu^- \nu$ , i.e., measuring:

$$R = \frac{Br(B_s^0 \rightarrow D_s^{(*)+} D_s^{(*)-}) \cdot Br(D_s \rightarrow \phi\mu\nu)}{Br(B_s^0 \rightarrow D_s^{(*)-} \mu^+ \nu)}, \quad (7)$$

where many systematic uncertainties cancel the ratio. A sample of 15.2k candidates of  $B_s^0 \rightarrow D_s^- \mu^+ \nu X$  in approximately 1 fb<sup>-1</sup> of data is first isolated where  $D_s^- \rightarrow \phi\pi^-$  is observed in association with a close-by  $\mu^+$ . An additional  $\phi$  is then searched for in this sample. Correlated production of excess  $\phi$  mesons when examining a  $D_s$  invariant mass window, and excess  $D_s$  mesons when examining a  $\phi$  mass window is observed as shown in Fig. 3.

A simultaneous unbinned likelihood fit to these distributions, and also to mass sidebands to estimate backgrounds, finds a total number of  $\mu\phi D_s$  candidates of  $19.3 \pm 7.8$ . Small estimated contributions from  $B \rightarrow D_s^{(*)+} D_s^{(*)-} KX$ ,  $B_s^0 \rightarrow D_s^{(*)+} D_s^{(*)-} X$ ,  $D_s^{(*)} \mu\phi\nu X$  and  $c\bar{c} \rightarrow \mu\phi D_s^{(*)}$  are subtracted. Using PDG [8] branching fractions in Eq. 7, as well as combining the PDG measurement with BaBar's new measurement of  $Br(D_s \rightarrow \phi\pi)$  [10], the preliminary branching fraction

$$Br(B_s^0 \rightarrow D_s^{(*)+} D_s^{(*)-}) = 0.071 \pm 0.035 (\text{stat.})_{-0.025}^{+0.029} (\text{syst.}) \quad (8)$$

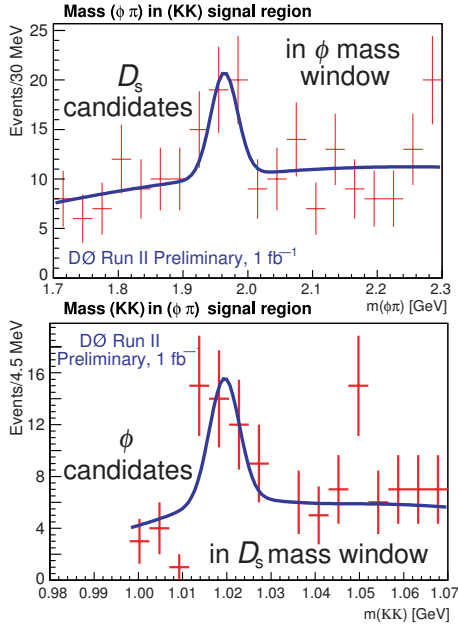

Figure 3: Top: DØ  $M(\phi\pi)$  invariant mass for candidates within a second  $\phi$  mass window indicating  $D_s$  decays; bottom:  $M(K^+K^-)$  invariant mass for candidates within a  $D_s$  mass window showing  $\phi$  decays.

is measured. Assuming that Eq. 5 is correct,

$$\frac{\Delta\Gamma_{CP}}{\Gamma_s} \approx \frac{\Delta\Gamma_s}{\Gamma_s} = 0.142 \pm 0.064 \text{ (stat.)}_{-0.050}^{+0.058} \text{ (syst.)} \quad (9)$$

is determined.

### 3.3. Belle Limits on $B_s^0$ Decay Modes

In June 2005, a three-day engineering run at KEKB at the center-of-mass energy corresponding to the mass of the  $\Upsilon(5S)$  allowed Belle to collect  $1.86 \text{ fb}^{-1}$  of data [11], including produced  $B_s^{(*)}\bar{B}_s^{(*)}$  pairs. From this initial sample Belle was able to reconstruct the hadronic decays  $B_s^0 \rightarrow D_s^+\pi^-$ ,  $K^+K^-$ , and  $D_s^{(*)+}D_s^{(*)-}$ , the channel of interest. Numbers of observed candidates for the latter were too small to allow measurement of the branching fraction, but preliminary limits of:

$$\begin{aligned} Br(B_s^0 \rightarrow D_s^+ D_s^-) &< 7.1\%, \\ Br(B_s^0 \rightarrow D_s^{*+} D_s^-) &< 12.7\%, \\ Br(B_s^0 \rightarrow D_s^{*+} D_s^{*-}) &< 27.3\%, \end{aligned} \quad (10)$$

were set. KEKB is capable of producing  $1 \text{ fb}^{-1}$  of integrated luminosity per day at the  $\Upsilon(5S)$ , and a possible 50-day long run in the future can allow the measurement of  $Br(B_s^0 \rightarrow D_s^{(*)+} D_s^{(*)-})$  to a relative precision of 25%, already competitive with the Tevatron measurements. Due to their lack of boost, lifetime and oscillation measurements are significantly more difficult

at the  $\Upsilon(5S)$ , but the  $B$  factories can contribute to the measurement of these important branching fractions.

For completeness of reporting  $B_s^0$  branching fraction measurements, Belle has also taken advantage of their excellent electromagnetic calorimeter to use this same data sample to place a preliminary limit of  $Br(B_s^0 \rightarrow \gamma\gamma) < 0.56 \times 10^{-4}$  at 90% C.L., already a factor of three improvement over the PDG value [8]. This decay mode is more sensitive to new physics than other penguin decay modes, and  $R$ -parity violating SUSY and fourth generation models can increase the SM prediction of  $(0.5 - 1.0) \times 10^{-6}$  for this branching fraction by up to two orders of magnitude.

## 4. Combining and Comparing $\Delta\Gamma_s$ Results

The most direct experimental results come from the Tevatron from CDF [12] and DØ [13] (described elsewhere in the proceedings [2]) where reconstructed decays  $B_s^0 \rightarrow J/\psi\phi$  are separated into  $CP$ -even and  $CP$ -odd components from fits to angular distributions of  $J/\psi$  and  $\phi$  decay products as a function of proper decay time. A weighted average of CDF and DØ indicates that this decay is  $(17 \pm 4)\%$   $CP$  odd at time  $t = 0$ , i.e., is a dominantly  $CP$ -even decay. Figure 4(a) shows the one sigma contours ( $\Delta \log(\text{Likel.}) = 0.5$ ) for the two experimental results and their combination (following the procedure outlined in Ref. [14]). This combination results in a Tevatron average from  $B_s^0 \rightarrow J/\psi\phi$  decays of<sup>2</sup>:

$$\begin{aligned} \Delta\Gamma_s &= 0.18 \pm 0.09 \text{ ps}^{-1}, \\ \bar{\tau} &= \frac{1}{\Gamma_s} = 1.520 \pm 0.068 \text{ ps}. \end{aligned} \quad (11)$$

Precise measurements of the flavor-specific lifetime of the  $B_s^0$  can further constrain  $\Delta\Gamma_s$  and  $\Gamma_s$ . These flavor-specific decays are dominated by semileptonic decays of the  $B_s^0$ , i.e.,  $B_s^0 \rightarrow D_s\ell\nu$  where the flavor of the meson, i.e., whether it is  $B_s^0$  or  $\bar{B}_s^0$  can be determined by the charge sign of the lepton. These decays are 50%  $CP$ -even and 50%  $CP$ -odd at time  $t = 0$ , and each component decays away with a different lifetime. A superposition of two exponentials thus results with decay widths  $\Gamma_s \pm \Delta\Gamma_s/2$ . Fitting to a single exponential results in a measure of a flavor-specific lifetime where [15]:

$$\tau(B_s^0)_{fs} = \frac{1}{\Gamma_s} \frac{1 + \left(\frac{\Delta\Gamma_s}{2\Gamma_s}\right)^2}{1 - \left(\frac{\Delta\Gamma_s}{2\Gamma_s}\right)^2}. \quad (12)$$

<sup>2</sup>The experimental measurements presented are really of  $2|\Gamma_{12}|\cos\phi$ . The phase angle  $\cos\phi$  is not measured, and in the context of new physics,  $\cos\phi$  can have any sign.

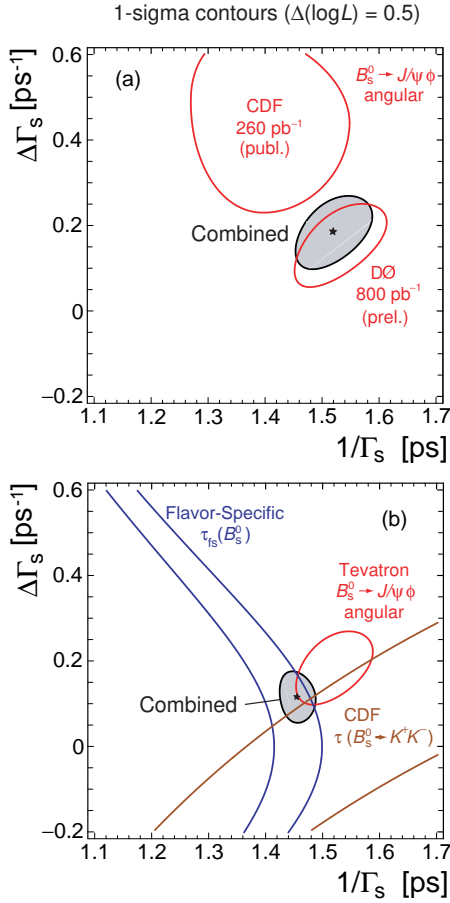

Figure 4: (a) Combination of the two experimental results separating the  $CP$ -even and  $CP$ -odd components from angular distributions of products in the decay  $B_s^0 \rightarrow J/\psi\phi$  as a function of proper time; (b) combination including the world average flavor-specific  $B_s^0$  lifetime (50%  $CP$ -even, 50%  $CP$ -odd at time  $t = 0$ ) and the CDF result of the  $B_s^0$  lifetime from  $B_s^0 \rightarrow K^+K^-$  decays.

Updating the world average flavor-specific lifetime value from the Heavy Flavor Averaging Group (HFAG) [14] with the new semileptonic  $B_s^0$  lifetime measurement from DØ submitted for publication [2, 16], a value of

$$\tau(B_s^0)_{\text{fs}} = 1.457 \pm 0.042 \text{ ps} \quad (13)$$

is obtained, giving the one-sigma band indicated on Fig. 4(b).

Lastly, CDF has made a preliminary measurement [3] of the  $B_s^0$  lifetime in decays  $B_s^0 \rightarrow K^+K^-$  of

$$\tau(B_s^0 \rightarrow K^+K^-) = 1.53 \pm 0.18 \pm 0.02 \text{ ps}. \quad (14)$$

This mode should be  $CP$  even to within 5%, and hence measures the lifetime of the “light” mass eigenstate  $\tau_L = 1/\Gamma_L$  and gives the one-sigma constraint as indicated on Fig. 4(b).

In the absence of new sources of  $CP$  violation in the penguin-dominated  $b \rightarrow su\bar{u}$  decay amplitude, the lifetime in Eq. 14 corresponds to  $1/\Gamma_L$ , the theory behind the extraction of  $\Delta\Gamma_s$  using these inputs is considered to be valid and they are combined, to form world averages of:

$$\begin{aligned} \Delta\Gamma_s &= 0.12 \pm 0.06 \text{ ps}^{-1}, \\ \bar{\tau} &= \frac{1}{\Gamma_s} = 1.455 \pm 0.032 \text{ ps}, \end{aligned} \quad (15)$$

as shown by the shaded region in Fig. 4.

The previously described DØ measurement of  $Br(B_s^0 \rightarrow D_s^{(*)+}D^{(*)-})$  in conjunction with Eq. 5 can be used to compare with this world average. Although there are worries that there may possibly be more  $CP$ -odd component in this mode [17], an additional 5% theory systematic is added in quadrature and assuming that Eq. 5 is valid, the resultant additional constraint is shown in Fig. 5(a) and combined with the previous inputs.

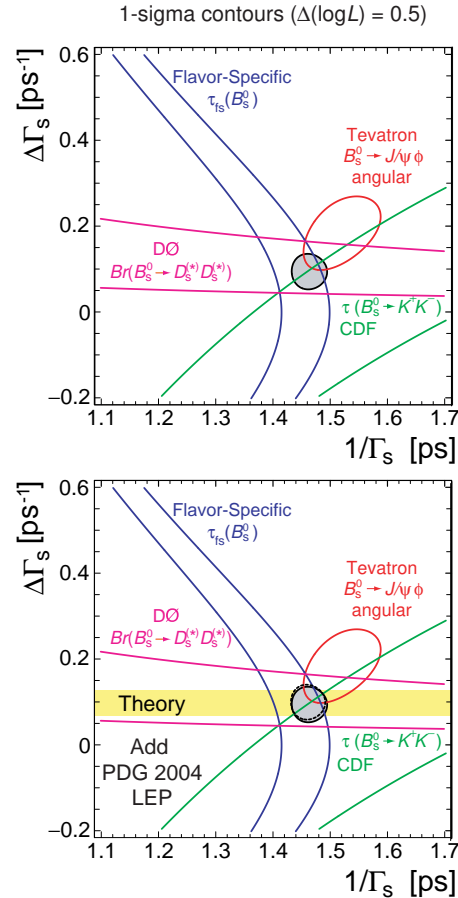

Figure 5: (a) Combination (shaded region) including the DØ measurement of  $Br(B_s^0 \rightarrow D_s^{(*)+}D^{(*)-})$ ; (b) combination (dashed line) when all prior measurements are included (PDG 2004), and comparison to the SM prediction (horizontal band) with  $f_{B_s}$  fixed to 260 MeV.

When all the inputs of PDG 2004 [18] are included, only a slight shift is observed in the total world average (Fig. 5(b)) indicating the degree of weight of new Tevatron measurements since 2004. With all available inputs, the world average values are then:

$$\begin{aligned}\Delta\Gamma_s &= 0.097 \pm 0.042 \text{ ps}^{-1}, \\ \bar{\tau} &= \frac{1}{\Gamma_s} = 1.461 \pm 0.030 \text{ ps}.\end{aligned}\quad (16)$$

The result for  $\Delta\Gamma_s$  is currently  $2.3\sigma$  from zero. A comparison to a theoretical prediction [19] of

$$\Delta\Gamma_s = (0.10 \pm 0.03) \left( \frac{f_{B_s}}{260 \text{ MeV}} \right)^2 \text{ ps}^{-1}, \quad (17)$$

depicted as a horizontal shaded band in Fig. 5(b), shows agreement with the SM, although errors are still large. It should be noted that  $\Delta\Gamma_s \approx 2|\Gamma_{12}| \cos\phi$ , and new physics could result in larger values of  $\phi$  that would then tend to *reduce* the measured value of  $\Delta\Gamma_s$ . The experimental result can also be expressed as the two different lifetimes of the mass eigenstates:

$$\begin{aligned}\tau_L &= \frac{1}{\Gamma_L} = 1.364 \pm 0.046 \text{ ps}, \\ \tau_H &= \frac{1}{\Gamma_H} = 1.573 \pm 0.061 \text{ ps}.\end{aligned}\quad (18)$$

Finally, we can test the predicted relationship [4]:

$$\frac{\Delta\Gamma_s}{\Delta m_s} \approx \left| \frac{\Gamma_{12}}{M_{12}} \right| = \mathcal{O} \left( \frac{m_b^2}{M_W^2} \right) \approx 4 \times 10^{-3}, \quad (19)$$

with a more precise prediction [19] of:

$$\frac{\Delta\Gamma_s}{\Delta m_s} = (47 \pm 8) \times 10^{-4}. \quad (20)$$

Using results on  $\Delta m_s$  [1, 2] and the world average  $\Delta\Gamma_s$  determined here, we find from experimental measurements:

$$\begin{aligned}\frac{\Delta\Gamma_s}{\Delta m_s} &= \frac{0.097 \pm 0.042 \text{ ps}^{-1}}{17.33_{-0.21}^{+0.42} \pm 0.07 \text{ ps}^{-1}} \\ &= (56 \pm 24) \times 10^{-4},\end{aligned}\quad (21)$$

again showing (disappointingly!) agreement with the SM prediction.

## 5. Leptonic Decays of $B$ Hadrons

### 5.1. Leptonic Decays $B_d^0, B_s^0 \rightarrow \mu^+ \mu^-$

Decays of the type  $B_d^0, B_s^0 \rightarrow \mu^+ \mu^-$  provide an excellent window into new physics that would tend to enhance rates above their predicted SM values. These decays represented by the diagrams of Fig. 6, are

highly suppressed by a factor of  $(m_\ell/m_B)^2$ . As a result, decays into electrons are effectively out of reach of collider experiments, even if very much enhanced; decays into  $\tau$  leptons are the least suppressed, but it is difficult to isolate these rare decays experimentally. Decays into muons are therefore in the “sweet spot”, i.e., relatively straight forward to isolate experimentally, and within reach of observability if enhanced by new physics. The SM predicts [20]:

$$Br_{SM}(B_s^0 \rightarrow \mu^+ \mu^-) = (3.35 \pm 0.32) \times 10^{-9}, \quad (22)$$

with  $Br(B_d^0 \rightarrow \mu^+ \mu^-)$  suppressed by another factor of  $|V_{td}/V_{ts}|^2 \approx 0.03$ .

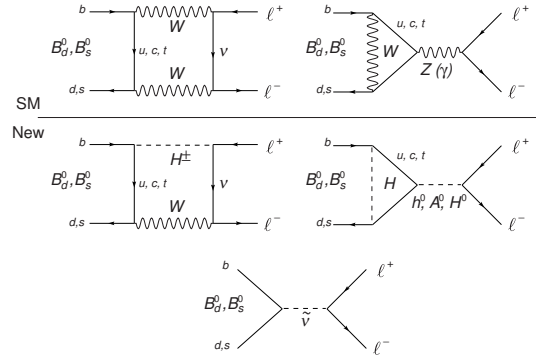

Figure 6: Feynman diagrams responsible for the decay  $B_d^0, B_s^0 \rightarrow \ell^+ \ell^-$ .

These branching fractions will grow as  $\tan^6 \beta$  in the Minimal Supersymmetric Standard Model (MSSM), and as  $\tan^4 \beta$  in Two-Higgs Doublet Models (2HDM) when charged Higgs bosons,  $H^\pm$ , take the place of  $W^\pm$  bosons in box and triangle diagrams, as well as neutral SUSY Higgs bosons replacing  $Z^0$  exchange [21] as shown in Fig. 6 Contributions to enhanced signal are also possible through  $s$ -channel exchange of  $R$ -parity violating SUSY particles.

Limits on these decay rates are now dominated by the Tevatron experiments. Starting with dimuon triggers, and requiring opposite-sign muons, there are very large backgrounds due to Drell-yan  $\mu^+ \mu^-$  continuum, sequential semimuonic decays in  $b \rightarrow c \rightarrow s$ , double semileptonic decays  $b\bar{b} \rightarrow \mu^+ \mu^- X$ , and  $b/c \rightarrow \mu^+ + \text{fake}$ . Both DØ [22] and CDF [3, 23] examine similar discriminating variables: since the  $B_s^0$  has lifetime, transverse decay length significance or probability of significance; angle between the  $\mu\mu$  vector and decay length vector (i.e., the “pointing consistency”); and isolation of the muons to reduce the background due to multiple muons from regular  $B$  hadron decays. CDF combines these variables into a likelihood ratio, while DØ decides where to cut on each variable using a random grid search for optimization. After all cuts, the distribution of the likelihood ratio versus invariant mass of the  $\mu^+ \mu^-$  pair for CDF, and the  $\mu^+ \mu^-$  invariant mass for the DØ search is shown in Fig. 7.

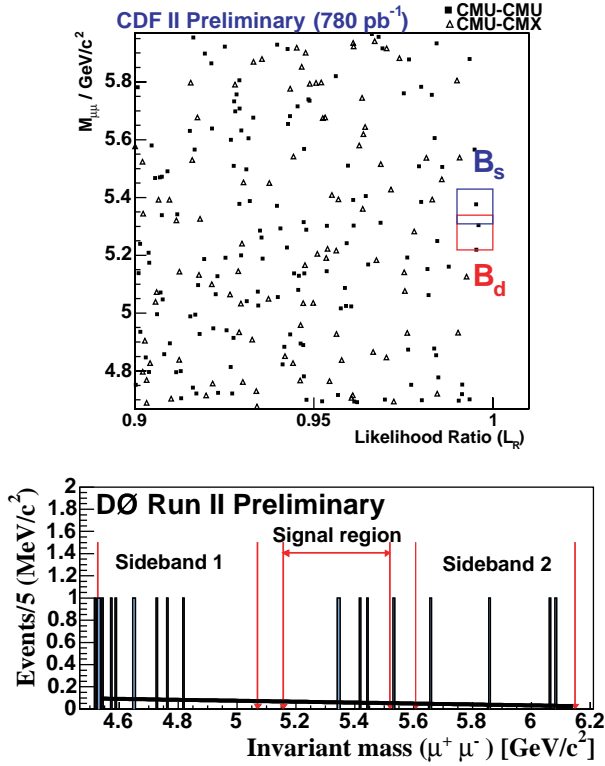

Figure 7: Top: CDF  $\mu^+\mu^-$  invariant mass distribution versus the event likelihood ratio (for  $L_R > 0.90$ ) for events passing baseline requirements; bottom: D0  $\mu^+\mu^-$  invariant mass distribution in signal and sideband regions.

Data sidebands are used to estimate expected backgrounds in the search regions in each case, and limits derived from the number of observed candidates compared to the number of expected. Both experiments normalize the the number of mesons observed in the  $B^+ \rightarrow J/\psi(\rightarrow \mu^+\mu^-)K^+$  decay mode with the advantage of large statistics and the muon identification efficiency being the same. CDF has the mass resolution to separate the  $B_d^0$  mass from the  $B_s^0$  mass, while D0 places limits on only  $B_s^0$  decays. Limit results are presented in Table I.

Table I Limits on the rare branching fraction  $Br(B_s^0 \rightarrow \mu^+\mu^-)$ .

Experiment	Int. Lumin.	Status	Limit (95% C.L.)
CDF	780 pb <sup>-1</sup>	Prel.	$< 1.0 \times 10^{-7}$
CDF & D0	$\approx 300$ pb <sup>-1</sup> each	Publ.	$< 1.5 \times 10^{-7}$
D0	700 pb <sup>-1</sup>	Prel.	$< 2.3 \times 10^{-7}$ (expected limit)
D0	300 pb <sup>-1</sup>	Prel.	$< 4.0 \times 10^{-7}$

The CDF preliminary limit on  $Br(B_d^0 \rightarrow \mu^+\mu^-)$  is  $< 3.0 \times 10^{-8}$ , which is a factor approximately

three times more stringent than the next best limit (from BaBar [24]). The CDF preliminary limit on  $Br(B_s^0 \rightarrow \mu^+\mu^-)$  in the Table above is currently the world's best and provides powerful constraints on new physics. Examples are stringent constraints on minimal SO(10) models with soft SUSY breaking [25], as well as mSUGRA models predicting neutralinos and cross sections consistent with relic density [26], with branching fraction limits complementary to cross section limits excluded by dark matter search experiments.

## 5.2. Decay $B_s^0 \rightarrow \mu^+\mu^-\phi$

Although not strictly a purely leptonic decay, the search for  $B_s^0 \rightarrow \mu^+\mu^-\phi$  is reported for completeness. This flavor-changing neutral-current (FCNC) decay can proceed through the diagrams of Fig. 8 with a branching fraction of  $Br_{SM}(B_s^0 \rightarrow \mu^+\mu^-\phi) \approx 1.6 \times 10^{-6}$  predicted by the SM, excluding long-distance effects from charmonium resonances [27]. The long term goal is to observe this mode to be able to investigate FCNC  $b \rightarrow s\ell^+\ell^-$  transitions in the  $B_s^0$  system, just as inclusive  $B \rightarrow X_s\ell^+\ell^-$  and exclusive  $B \rightarrow K^{(*)}\ell^+\ell^-$  are observed at  $B$  factories and agree with the SM. There is the potential for enhancement in these modes in various SUSY and 2HDM models.

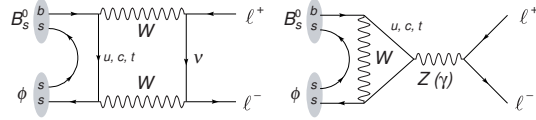

Figure 8: Feynman diagrams responsible for the decay  $B_s^0 \rightarrow \phi\mu^+\mu^-$ .

D0 has searched for the exclusive mode  $B_s^0 \rightarrow \phi\mu^+\mu^-$  [28]. The analysis follows the same procedure as for searching for  $B_s^0 \rightarrow \mu^+\mu^-$  except that a  $\phi$  meson is added via the decay  $\phi \rightarrow K^+K^-$  and vertexed with the  $\mu^+\mu^-$ . The same discriminating variables are used, but the cut values are re-optimized. Resonant regions of  $J/\psi, \psi(2S) \rightarrow \mu^+\mu^-$  are removed, and normalization is made to the resonant mode  $B_s^0 \rightarrow J/\psi(\rightarrow \mu^+\mu^-)\phi$ . Zero events are observed in the signal region, with an expectation of  $1.6 \pm 0.4$  events. From this a limit of

$$Br(B_s^0 \rightarrow \mu^+\mu^-\phi) < 4.1 \times 10^{-6} \text{ (95\% C.L.)} \quad (23)$$

is found. This is a factor of ten improvement over the previous limit and only a factor of three more than the SM prediction – the Tevatron should be able to observe this mode before the end of Run 2b.

## 5.3. Leptonic Decay $B_d^0 \rightarrow \tau^+\tau^-$

The decay  $B_d^0 \rightarrow \tau^+\tau^-$  is the least helicity suppressed as pointed out previously, but is the most dif-

difficult to isolate experimentally due to the two to four missing neutrinos. Limits previously did not exist for this channel, and as a result, a “loophole” existed allowing for certain models involving leptoquark couplings and SUSY  $\tan\beta$  enhancements above the SM prediction of  $Br_{SM}(B_d^0 \rightarrow \tau^+\tau^-) = 1.2 \times 10^{-7}$ .

BaBar has now placed the first ever limit [29] on this channel. Starting with 280k fully reconstructed  $B_d^0 \rightarrow D^{(*)}X$  decays (referred to as the companion  $B$ ) as indicated by the peak in Fig. 9(a) in the variable  $m_{ES} = \sqrt{E_{beam}^{*2} - p_B^{*2}}$ , where  $E_{beam}^*$  is the beam energy in the CM frame, and  $p_B^*$  is the reconstructed companion- $B$  momentum. One-prong  $\tau$  decays are then searched for in the rest of the event after removing all neutral and charged kaons. Kinematics of charged daughter momenta and the residual energy in the calorimeter are fed into an artificial neural network to separate signal from background. After cutting on the network output, the signal is as shown in Fig. 9(b), with  $263 \pm 19$  candidates observed in the data with an expected background of  $281 \pm 40$  candidates. From this, a limit:

$$Br(B_d^0 \rightarrow \tau^+\tau^-) < 3.4 \times 10^{-3} \text{ (90\% C.L.)} \quad (24)$$

is determined.

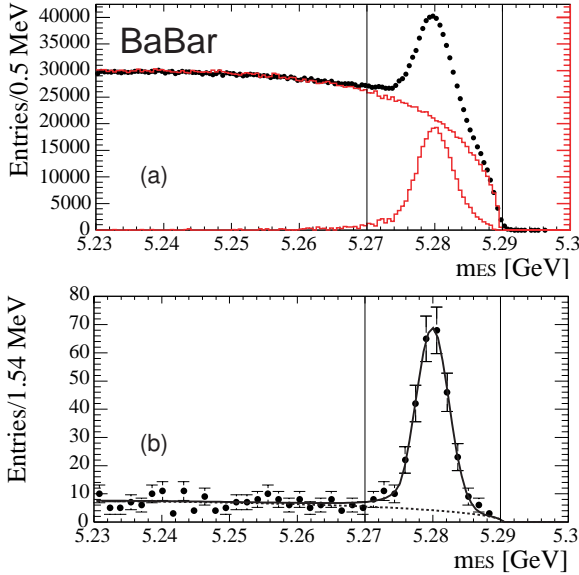

Figure 9: (a) Signal of 280k fully reconstructed  $B_d^0$  companion- $B$  events in variable  $m_{ES}$  (see text); (b) remaining background events following all cuts to isolate  $B_d^0 \rightarrow \tau^+\tau^-$  consistent with predicted background.

#### 5.4. Leptonic Decay $B^+ \rightarrow \tau^+\nu_\tau$

The decay  $B^+ \rightarrow \ell^+\nu_\ell$  proceeds through a  $W$ -annihilation diagram as shown in Fig. 10 and the

branching fraction is then given by:

$$Br_{SM}(B^+ \rightarrow \ell^+\nu_\ell) = \frac{G_F^2 m_B}{8\pi} m_\ell^2 \left(1 - \frac{m_\ell^2}{m_B^2}\right)^2 f_B^2 |V_{ub}|^2 \tau_B, \quad (25)$$

providing access to the CKM matrix element  $|V_{ub}|$ , and more importantly, to  $f_B$  if  $|V_{ub}|$  is taken as an external input. Alternatively, if a charged Higgs boson ( $H^\pm$ ) exchange is possible, then

$$Br(B^+ \rightarrow \ell^+\nu_\ell) = Br_{SM}(B^+ \rightarrow \ell^+\nu_\ell) \cdot (1 - (\tan^2 \beta / m_H^2) m_B^2)^2, \quad (26)$$

providing access to the SUSY parameter  $\tan\beta$  and the charged Higgs mass  $m_H$  [30]. There have been no new results in  $B^+ \rightarrow e^+\nu_e$  or  $B^+ \rightarrow \mu^+\nu_\mu$  since 2004, but there is now the first observation of  $B^+ \rightarrow \tau^+\nu_\tau$  from Belle.

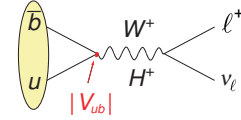

Figure 10: Feynman diagram responsible for  $B^+ \rightarrow \tau^+\nu_\tau$  decay in the SM, as well as the possibility of probing for the existence of charged Higgs bosons.

Belle’s analysis [11, 31] proceeds in a similar fashion to the Babar analysis above, i.e., one  $B_d^0$  is fully reconstructed, and in the remainder of the event, a search is made for a topology of one- or three-prong  $\tau$  decays (in five modes). The properties of the remaining event are compared with expected signal and background. Figure 11 shows the distribution of excess energy in the electromagnetic calorimeter showing a  $4.0\sigma$  excess over expectation at low values indicating the presence of  $B^+ \rightarrow \tau^+\nu_\tau$  decays. This excess translates into a measurement from Belle of:

$$Br(B^+ \rightarrow \tau^+\nu_\tau) = (0.106^{+0.034+0.018}_{-0.028-0.016})\%, \quad (27)$$

that is the first measurement of this branching fraction. In the the SM, this can also be translated into a measurement of:

$$f_B |V_{ub}| = (7.73^{+1.24+0.066}_{-1.02-0.058}) \times 10^{-4} \text{ GeV}, \quad (28)$$

and using the HFAG world average value of  $|V_{ub}|$  [14],

$$f_B = 0.176^{+0.028+0.020}_{-0.023-0.018} \text{ GeV}, \quad (29)$$

that is the first direct measurement of this decay parameter. Implications of this measurement for constraints on the CKM unitarity triangle can be found in Ref. [32].

For completeness, the BaBar limit [33] on this branching fraction is

$$Br(B^+ \rightarrow \tau^+\nu_\tau) < 2.6 \times 10^{-3} \text{ (90\% C.L.)} \\ = (0.13^{+0.10}_{-0.09})\%. \quad (30)$$

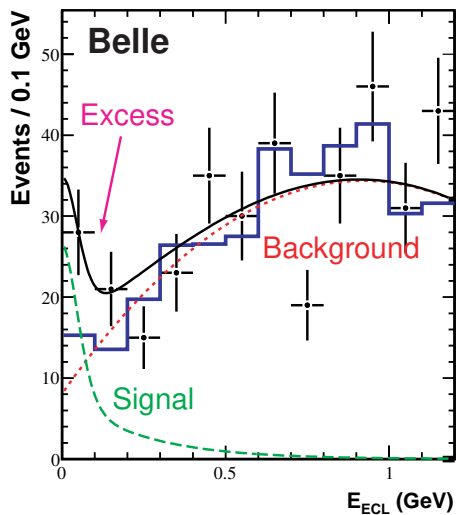

Figure 11: Distribution of excess energy in the electromagnetic calorimeter after all selection requirements. Data and background MC samples are represented by points with error bars and the solid histogram, respectively. The solid curve shows the result of the fit with the sum of the signal shape (dashed) and background shape (dotted).

## 6. Summary

In summary, the  $B_s^0$  system is now being probed from all sides. First evidence of  $B_s^0$  oscillations and their frequency gives  $\Delta m_s$ , but branching fraction measurements and lifetimes into specific  $CP$  eigenstate mixtures now gives a world average of  $\Delta\Gamma_s$  that is  $2.3\sigma$  from zero, and also consistent with the SM.

In the field of leptonic and FCNC  $B_s^0$  decays, the best limits now come from the Tevatron, providing strong constraints on new physics as they approach the SM predicted values. These limits will improve as Run 2b collects more data. The first ever limit from BaBar on the branching fraction for  $B_d^0 \rightarrow \tau^+\tau^-$  has been presented, and first ever observation for the decay  $B^+ \rightarrow \tau^+\nu_\tau$  has been shown by Belle.

## Acknowledgments

The author wishes to thank the organizers of the conference for a very enjoyable and informative program, the many physics analysis representatives from DØ CDF, BaBar, and Belle for providing results, and U. Nierste for useful discussions.

## References

[1] D. Buchholz, *DØ Hot Topics*, FPCP 2006 Proceedings, FPCP06\_113, arXiv:hep-ex/0605090;

V. M. Abazov *et al.* [DØ Collaboration], *First direct two-sided bound on the  $B_s^0$  oscillation frequency*, accepted for publication in Phys. Rev. Lett., arXiv:hep-ex/0603029.

[2] G. Gomez-Ceballos, J. Piedra, *B Mixing and Lifetimes at the Tevatron*, FPCP 2006 Proceedings, FPCP\_143

[3] D. Tonelli, *CDF Hot Topics*, FPCP 2006 Proceedings, FPCP06\_112, arXiv:hep-ex/0605038.

[4] K. Anikeev *et al.*, *B physics at the Tevatron: Run II and beyond*, arXiv:hep-ph/0201071.

[5] R. Aleksan, A. Le Yaouanc, L. Oliver, O. Pene and J. C. Raynal, Phys. Lett. B **316**, 567 (1993).

[6] R. Barate *et al.* [ALEPH Collaboration], Phys. Lett. **B486**, 286 (2000).

[7] CDF Note 7925, *Observation of exclusive  $B_s \rightarrow D_s^+ D_s^-$ ,  $D_s \rightarrow \phi\pi(3\pi, K^*K)$ ,  $D^+ \rightarrow K\pi\pi$  with  $355 \text{ pb}^{-1}$  in Run II*, March 29, 2006.

[8] S. Eidelman *et al.*, Phys. Lett. **B592**, 1 (2004) and 2005 partial web update for edition 2006.

[9] DØ Note 5068-CONF, *Measurement of the Branching Ratio  $Br(B_s^0 \rightarrow D_s^{(*)+} D_s^{(*)-})$  with the DØ Experiment*, March 21, 2006.

[10] B. Aubert *et al.* [BaBar Collaboration], Phys. Rev. D **71**, 091104 (2005).

[11] K. Ikado, *Hot topics from Belle experiment*, FPCP 2006 Proceedings, fcp06\_114, arXiv:hep-ex/0605068.

[12] D. Acosta *et al.* [CDF Collaboration], Phys. Rev. Lett. **94**, 101803 (2005), arXiv:hep-ex/0412057.

[13] DØ Conference Note 5052, *Measurement of the Lifetime Difference in the  $B_s^0$  System*, 22 March 2006.

[14] Heavy Flavor Averaging Group (HFAG), *Averages of b-hadron properties at the end of 2005*, arXiv:hep-ex/0603003.

[15] K. Hartkorn and H.-G. Moser, Eur. Phys. J. **C8**, 381 (1999).

[16] V. M. Abazov [DØ Collaboration], *A precise measurement of the  $B_s^0$  lifetime*, arXiv:hep-ex/0604046, submitted to Phys. Rev. Lett.

[17] Private communication, U. Nierste, May 2006.

[18] Heavy Flavor Averaging Group (HFAG) [www.slac.stanford.edu/xorg/hfag/osc/index.html](http://www.slac.stanford.edu/xorg/hfag/osc/index.html).

[19] Update of result by U. Nierste in M. Beneke, G. Buchalla, C. Greub, A. Lenz and U. Nierste, Phys. Lett. B **459**, 631 (1999), arXiv:hep-ph/9808385.

[20] M. Blanke, A.J. Buras, D. Guadagnoli and C. Tarantino, *Minimal flavour violation waiting for precise measurements of  $\Delta m_s$ ,  $|V_{ub}|$ ,  $\gamma$ , an  $B_{s,d}^0 \rightarrow \mu^+\mu^-$* , arXiv:hep-ph/0604057; A.J. Buras, Phys. Lett. B **566**, 115 (2003).

[21] K.S. Babu and C.F. Kolda, Phys. Rev. Lett. **93**, 032001 (2004); C.S. Huang, W. Liao, Q.S. Yan and S.H. Zhu, Phys. Rev. D **63**, 114201 (2001) [Erratum-ibid.



- D **64**, 059902 (2001)];  
H.E. Logan and U. Nierste, Nucl. Phys. B **586**, 39 (2000).
- [22] DØ Note 4733-CONF, *Update of the Upper Limit on the Rare Decay  $B_s^0 \rightarrow \mu^+\mu^-$  with the DØ Detector*.
- [23] CDF Public Note 8176, *Search for  $B_s^0 \rightarrow \mu^+\mu^-$  and  $B_d^0 \rightarrow \mu^+\mu^-$  Decays in  $p\bar{p}$  Collisions with CDF II*.
- [24] B. Aubert *et al.* [BABAR Collaboration], Phys. Rev. Lett. **94**, 221803 (2005).
- [25] R. Dermisek, S. Raby, L. Roszkowski and R. Ruiz de Austri, JHEP **0509**, 029 (2005), arXiv:hep-ph/0507233.
- [26] S. Baek, Y. G. Kim and P. Ko, JHEP **0502**, 067 (2005), arXiv:hep-ph/040603.
- [27] C.Q. Geng and C.C. Liu, J. Phys. G **29**, 1103 (2003).
- [28] DØ Note 4862-CONF, *Search for the Rare Decay  $B_s^0 \rightarrow \mu^+\mu^-$  with the DØ Detector*, 27 June 2005.
- [29] B. Aubert *et al.* [BABAR Collaboration], *A search for the rare decay  $B_d^0 \rightarrow \tau^+\tau^-$  at BABAR*, submitted to Phys. Rev. Lett., arXiv:hep-ex/0511015.
- [30] W.S. Hou, Phys. Rev. D **48**, 2342 (1993).
- [31] K. Ikado *et al.* [Belle Collaboration], *Evidence of the purely leptonic decay  $B^- \rightarrow \tau^- \bar{\nu}_\tau$* , submitted to Phys. Rev. Lett., arXiv:hep-ex/0604018.
- [32] CKMfitter Group (J. Charles *et al.*), Eur. Phys. J. **C41**, 1-131 (2005), arXiv:hep-ph/0406184, updated results and plots available at: <http://ckmfitter.in2p3.fr> .
- [33] B. Aubert *et al.* [BABAR Collaboration], Phys. Rev. D **73**, 057101 (2006), arXiv:hep-ex/0507069.