

SURGERY ON LAGRANGIAN AND LEGENDRIAN SINGULARITIES

Mikhail Entov

Department of Mathematics
Stanford University
Stanford, CA 94305
USA

Current address:
Department of Mathematics
Tel Aviv University
Ramat Aviv, Tel Aviv 69978
Israel

e-mail: entov@math.tau.ac.il

May 28, 2018

Abstract

Let $\pi : E \rightarrow M$ be a smooth fiber bundle whose total space is a symplectic manifold and whose fibers are Lagrangian. Let L be an embedded Lagrangian submanifold of E . In the paper we address the following question: how can one simplify the singularities of the projection $\pi : L \rightarrow M$ by a Hamiltonian isotopy of L inside E ? We give an answer in the case when $\dim L = 2$ and both L and M are orientable. A weaker version of the result is proved in the higher-dimensional case. Similar results hold in the contact category.

As a corollary one gets an answer to one of the questions of V. Arnold about the four cusps on the caustic in the case of the Lagrangian collapse. As another corollary we disprove Y. Chekanov's conjecture about singularities of the Lagrangian projection of certain Lagrangian tori in \mathbf{R}^4 .

1 Introduction and statement of main results

1.1 Statement of the problem and an informal statement of results

Let us start with the Lagrangian case. Suppose that $\pi : E \rightarrow M$ is a *Lagrangian fiber bundle*, i.e. E is a symplectic manifold and the fibers of π are Lagrangian submanifolds of E . The restriction of π on a Lagrangian submanifold $L \subset E$ is called *the Lagrangian projection of L* . The singularities of the Lagrangian projection $\pi : L \rightarrow M$ are called *the Lagrangian singularities of L* .

Suppose that $L \subset E$ is an embedded Lagrangian submanifold. We would like to deform L in order to simplify the singularities of its Lagrangian projection $\pi : L \rightarrow M$ as much as we can. More precisely, we are interested in the following question:

Can we deform the Lagrangian submanifold $L \subset E$ by a Hamiltonian isotopy so that the singularities of the Lagrangian projection of the new submanifold on M are at worse folds? And in general, what singularities can be obtained in this way?

This problem is motivated in particular by the V.Arnold's question asking whether one can kill the Lagrangian cusp-singularities by a Hamiltonian isotopy in the case of some special Lagrangian cylinder in \mathbf{R}^4 (called “Lagrangian collapse” – see [7] and Example 1.12 below for a detailed discussion). Also Y.Chekanov conjectured in [11] that for some special Lagrangian tori in \mathbf{R}^4 that he had constructed the Lagrangian cusp-singularities cannot be removed by a Hamiltonian isotopy.

The answer to the questions above given in this paper can be formulated as follows. All the Lagrangian singularities higher than folds (like cusps, swallowtails etc.) can be killed by a C^0 -small Hamiltonian isotopy *maybe at the expense of creating additional folds*, provided that there is no obstruction for such a homotopy on the level of 1-jets of the involved maps (in other words, if there is no *formal obstruction*). We will prove this statement in the case when L is a closed orientable two-dimensional surface and a weaker version of the statement will be proved in the higher-dimensional case.

The Legendrian case is completely parallel to the Lagrangian one (see Section 1.8).

Thus, Lagrangian (Legendrian) singularities higher than folds are “soft” from the point of view of symplectic (contact) topology – one can get rid of them, if there is no formal obstruction for that. However the Lagrangian and Legendrian folds are “rigid” from the same point of view: they may

not be killed, even if there is no formal obstruction for that. For instance, for any n one can construct an embedded Legendrian sphere $L \subset J^1S^n$ which is smoothly isotopic and Legendrian regularly homotopic to the zero-section (and therefore there is no formal obstruction to kill all the folds by a Legendrian isotopy) but which is *not* Legendrian isotopic to the zero-section (see [14]). Legendrian submanifolds with analogous properties can also be constructed in the space $ST^*\mathbf{R}^n$ (see [14]). Similar examples have been independently constructed by P.Pushkar' and E.Ferrand (see [15]).

An important assumption

From the very beginning we assume that for all Lagrangian (Legendrian) submanifolds in this paper and all Lagrangian (Legendrian) singularities or of singularities of tangency to a foliation, are contained in a compact part of the submanifold away from the boundary, if there is one. All deformations are supposed to be compactly supported and identical near the boundary.

The singularities of the map $\pi : L \rightarrow M$ can be interpreted as singularities of tangency of the submanifold $L \subset E$ to the foliation $Vert$ of E by the fibers of $\pi : E \rightarrow M$. According to the Lagrangian neighborhood theorem [25],[26], we can find a neighborhood \mathcal{U} of the zero-section in T^*L and a map $F : \mathcal{U} \rightarrow E$ which sends the zero-section onto L and which is a symplectic embedding of \mathcal{U} onto a neighborhood of L in E . Now, if we identify L with the zero-section in T^*L , then instead of singularities of tangency of $L \subset E$ to $Vert$ we can consider the singularities of tangency of the zero-section $L \subset T^*L$ to the induced Lagrangian foliation $\mathcal{F} = F^*(Vert)$ of \mathcal{U} .

Thus instead of the original question we may consider the following harder problem:

*Let \mathcal{F} be a Lagrangian foliation of a neighborhood \mathcal{U} of the zero-section L in T^*L . How can the singularities of tangency of L to \mathcal{F} change when we deform L by a Hamiltonian isotopy inside \mathcal{U} ?*

1.2 The structure of Lagrangian singularities: basic definitions

First we introduce a notational convention: by a *Lagrangian distribution* along an embedded Lagrangian submanifold $\Lambda \subset T^*L$ we always mean a

field of Lagrangian planes in $T(T^*L)$ defined on Λ . If \mathcal{N} is a Lagrangian distribution along Λ , we write \mathcal{N}_x for a fiber of \mathcal{N} at $x \in \Lambda$.

Definition 1.1 We say that a Lagrangian distribution \mathcal{N} along L is Σ^2 -nonsingular, if at any point $x \in L$ we have $\dim(T_x L \cap \mathcal{N}_x) \leq 1$. Otherwise \mathcal{N} is called Σ^2 -singular.

The term Σ^2 comes from the Thom-Boardman hierarchy of singularities (see [23], [9]). According to the singularity theory (see e.g. [4]) the singularities of tangency of a Lagrangian submanifold $L \subset T^*L$ to a generic Σ^2 -nonsingular Lagrangian distribution \mathcal{N} form a “complete flag” $L^n = V_0 \supset V_1 \supset V_2 \supset \dots \supset V_{n+1} = \emptyset$ of (not necessarily connected) smooth submanifolds of L . Namely, along $L \setminus V_1$ the distribution \mathcal{N} is transversal to L , along V_1 the distribution planes cut out a line field in the tangent planes of L , and then $V_2 \subset V_1$ is exactly the set of points where this line field is not transversal to V_1 , $V_3 \subset V_2$ is exactly the set of points where the line field is not transversal to V_2 etc. According to the Thom-Boardman terminology, along $L \setminus V_1$ the singularities of tangency are of type Σ^1 , along $V_2 \setminus V_3$ the singularities are of type Σ^{11} etc.

For $i \geq 2$ there exists a natural coorientation of V_{i-1} in V_{i-2} along $V_i \setminus V_{i+1}$, (see Definition 2.6), and the submanifold V_1 has a natural coorientation in L coming from the *Maslov coorientation* of Lagrangian folds (see [1]). We express all these coorientations by means of some unit normal vector fields v_i (with respect to some Riemannian metric fixed once and forever). Thus for $i \geq 2$ the unit vector field v_i is defined along $V_i \setminus V_{i+1}$ and is normal to V_{i-1} in V_{i-2} , and the unit vector field v_1 is defined along V_1 and is normal to V_1 in L .

Definition 1.2 A Σ^2 -nonsingular Lagrangian distribution \mathcal{N} on L is called a *fold-type Lagrangian distribution*, if the submanifold V_1 in the flag above is smooth and $\dim(\mathcal{N}_x \cap T_x V_1) = 0$ for any $x \in V_1$. In other words, $V_i = \emptyset$ for any $i > 1$.

Suppose that we have a Σ^2 -nonsingular Lagrangian distributions \mathcal{N} and \mathcal{N}' along, respectively, some Lagrangian submanifolds L and L' in T^*M . Let $\{V_i, v_i\}$ (resp. $\{V'_i, v'_i\}$) denote the data describing as above the singularities of tangency of \mathcal{N} to L (resp. \mathcal{N}' to L').

We say that the singularities of tangency of \mathcal{N} to L are *equivalent* to the singularities of tangency of \mathcal{N}' to L' , if there exists an isotopy between L and L' in T^*M which maps the data $\{V_i, v_i\}$ into the corresponding data $\{V'_i, v'_i\}$ (also see Definition 2.4).

1.3 Double folds

Before stating the main results of the paper we need to define a particular combination of singularities.

Definition 1.3 Let \mathcal{N} be a Lagrangian distribution along L . Let $S_1^{n-1}, S_2^{n-1} \subset L$ be embedded spheres such that S_2^{n-1} bounds a ball B^n in L and the sphere S_1^{n-1} lies inside that ball.

We say that L has a *double fold* with respect to \mathcal{N} along the spheres $S_1^{n-1}, S_2^{n-1} \subset L$, if the restriction of \mathcal{N} on a neighborhood of the ball B^n is a fold-type distribution that has singularities of tangency to L only along the spheres S_1^{n-1} and S_2^{n-1} and the (Maslov) coorientations of both spheres in L point in the opposite directions.

In general, a pair of spheres $S_1^{n-1}, S_2^{n-1} \subset L$ as above equipped with opposite coorientations will be called a *double fold pair of (cooriented) spheres*.

Remark 1.4 In a small neighborhood U of the ball B^n from Definition 1.3 we can reduce \mathcal{N} and L by a symplectomorphism to a specific form so that

- (i) the neighborhood U is presented as an open set in the standard symplectic space \mathbf{R}^{2n} with the standard Darboux coordinates $p_1, \dots, p_n, q_1, \dots, q_n$;
- (ii) the Lagrangian distribution \mathcal{N} is identified with a field of affine Lagrangian planes parallel to the vertical (p_1, \dots, p_n) -plane;
- (iii) the Lagrangian submanifold L has a “mushroom”-type shape with respect to the vertical plane field \mathcal{N} as on Fig. 1.

See Section 8 for details.

1.4 The main results

Let us identify L with the zero-section in T^*L and let \mathcal{F} be a Lagrangian foliation defined on a neighborhood of L in T^*L . Also let \mathcal{N} be a generic Σ^2 -nonsingular Lagrangian distribution along L .

We first state the result for the case when $\dim L = 2$ and all manifolds and distributions are orientable (Theorem A). Then we present a weaker version of the result for a general L of any dimension (Theorem B).

Lagrangian singularities of the Thom-Boardman type Σ^2 generically have codimension 3 (see [2],[4]). Therefore a generic Lagrangian distribution along a two-dimensional surface is Σ^2 -nonsingular.

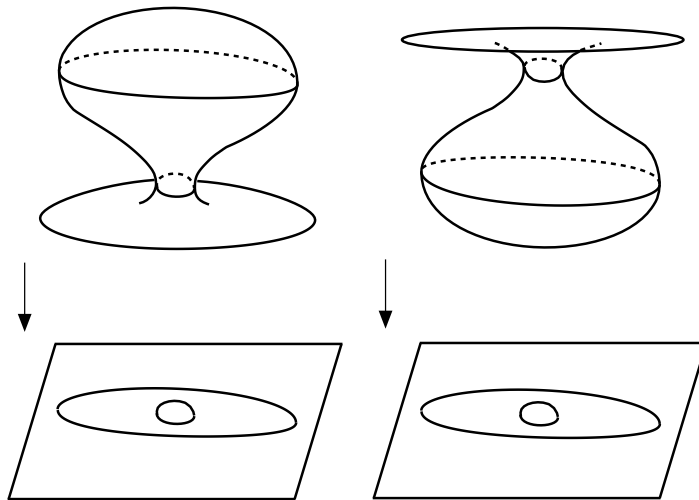

Figure 1: Double folds.

Theorem A *Suppose that L is an oriented surface and that the Lagrangian foliation \mathcal{F} and the Lagrangian distribution \mathcal{N} are oriented. Suppose also that the oriented Lagrangian distributions $\mathcal{F}|_L$ and \mathcal{N} along L can be connected in the class of such distributions.*

*Then there exists a Hamiltonian isotopy $\{h_t(L)\}$, $0 \leq t \leq 1$, such that the singularities of tangency of the Lagrangian submanifold $h_1(L) \subset T^*L$ to \mathcal{F} are equivalent to the union of the singularities of tangency of L to \mathcal{N} and a number of additional double fold pairs of circles in L .*

The Hamiltonian isotopy above can be chosen in such a way that it is compactly supported and arbitrarily C^0 -small and so that $\max_{t,\gamma} \left| \int_{h_t(\gamma)} pdq \right|$ is also arbitrarily C^0 -small (by γ we denote a path in L).

Remark 1.5 The hypothesis of Theorem A is a necessary condition for the existence of a C^0 -small Hamiltonian isotopy which deforms L into a Lagrangian submanifold whose singularities of tangency to \mathcal{F} are equivalent to the singularities of tangency of L to \mathcal{N} . Indeed, if there exists such a Hamiltonian isotopy $\{h_t(L)\}$, $0 \leq t \leq 1$, then there exists a homotopy $\{(h_t^{-1})_*(\mathcal{F})\}$ in the class of Lagrangian distributions along L connecting

$\mathcal{F}|_L$ with a Lagrangian distribution $(h_1^{-1})_*(\mathcal{F})$, so that the singularities of tangency of $(h_1^{-1})_*(\mathcal{F})$ to L are equivalent to the singularities of tangency of \mathcal{N} to L .

In the higher-dimensional case one has the following weaker result (as compared to Theorem A).

Theorem B *Suppose that $\dim L \geq 2$. Suppose also that the Lagrangian distribution $\mathcal{F}|_L$ along L is generic and Σ^2 -nonsingular and that it can be connected with \mathcal{N} in the class of Σ^2 -nonsingular Lagrangian distributions along L .*

*Then there exists a Hamiltonian isotopy $\{h_t(L)\}$, $0 \leq t \leq 1$, such that the singularities of tangency of the Lagrangian submanifold $h_1(L) \subset T^*L$ to \mathcal{F} are equivalent to the union of the singularities of tangency of L to \mathcal{N} and a number of additional double fold pairs of spheres in L .*

In particular, if \mathcal{N} is a fold-type distribution, then all the singularities of tangency of $h_1(L)$ to \mathcal{F} are folds.

The Hamiltonian isotopy above can be chosen in such a way that it is compactly supported and arbitrarily C^0 -small and so that $\max_{t,\gamma} \left| \int_{h_t(\gamma)} pdq \right|$ is also arbitrarily C^0 -small.

Unlike in Theorem A, the hypothesis of Theorem B is not a necessary condition for the existence of a Hamiltonian isotopy that deforms L into a Lagrangian submanifold whose singularities of tangency to \mathcal{F} are equivalent to the singularities of tangency of L to \mathcal{N} . The reason is that we require the homotopy between $\mathcal{F}|_L$ and \mathcal{N} to lie in the class of Σ^2 -nonsingular and not in the class of *all* Lagrangian distributions along L (see Remark 1.5).

1.5 Corollaries of Theorem A

First we explicitly describe the possible sets of Lagrangian singularities on a given closed Lagrangian surface.

If L is generic, its Lagrangian singularities form a closed 1-dimensional submanifold $V_1 \subset L$ (the closure of the set of Lagrangian folds) with a 0-dimensional submanifold $V_2 \subset V_1$ of Lagrangian cusps. The submanifold V_1 is equipped with a coorienting unit vector field v_1 , corresponding to the Maslov coorientation of the Lagrangian folds in L . The points of the zero-dimensional submanifold V_2 are equipped with unit vectors (denoted altogether by v_2) normal to V_1 , that arise from the characteristic directions

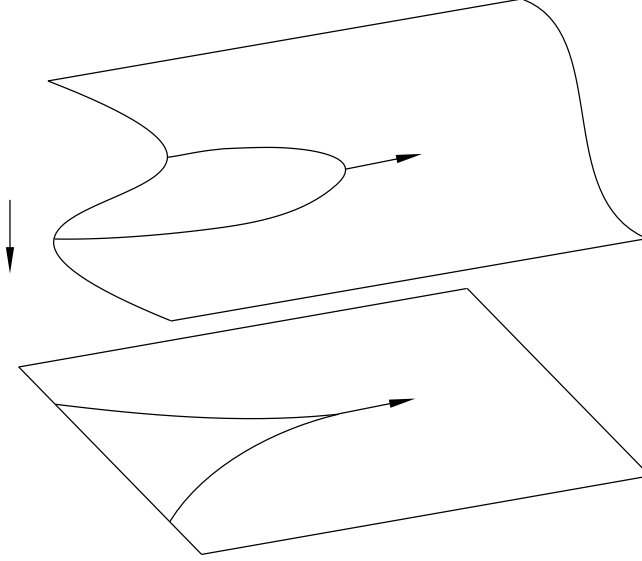

Figure 2: The characteristic direction of a cusp on the caustic and the corresponding vector at the cusp-singularity point of the Lagrangian submanifold.

of cusps on the caustic (i.e. on the set of critical values of the Lagrangian projection) – see Fig.2. Thus the structure of the Lagrangian singularities is described by the data $\{V_1, V_2, v_1, v_2\}$.

Since V_1 is cooriented in L it subdivides L into two parts L_1 and L_2 with the common boundary V_1 . Suppose the V_2 consist of $n_1 + n_2$ points so that at n_1 of the points the vectors v_2 are directed into L_2 and at the rest n_2 points into L_1 .

Now suppose that L is an embedded closed oriented Lagrangian submanifold in T^*M , where M is an oriented surface. Let $c(L) \in H^1(L)$ be the Maslov class and let d be the degree of the Lagrangian projection $L \rightarrow M$ (in particular, if M is not closed, $d = 0$). It is well known that

- (A) V_1 realizes a homology class Poincaré-dual to $c(L)$ (V_1 is cooriented and therefore also oriented because L is oriented);
- (B) $\chi(L_1) - \chi(L_2) + n_1 - n_2 = d\chi(M)$ (this formula holds for any smooth map $L \rightarrow M$, see e.g. [17],[12]).

Corollary 1.6 *Suppose that a formal data $\{V_1, V_2, v_1, v_2\}$ on L satisfies the conditions (A) and (B) above. Then there exists a (generic) Lagrangian*

submanifold $L' \subset T^*M$ Hamiltonian isotopic to L such that the singularities of the Lagrangian projection $L' \rightarrow M$ are equivalent to the union of $\{V_1, V_2, v_1, v_2\}$ and of a number of double fold pairs of cooriented circles in L .

The Hamiltonian isotopy above can be chosen in such a way that it is compactly supported and arbitrarily C^0 -small and so that $\max_{t, \gamma} \left| \int_{h_t(\gamma)} pdq - \int_{\gamma} pdq \right|$ is also arbitrarily C^0 -small.

Corollary 1.7 *Let L be an embedded orientable Lagrangian submanifold in T^*M , where M is an orientable surface. Then L is Hamiltonian isotopic to a Lagrangian submanifold $L_1 \subset T^*M$ such that all the singularities of the Lagrangian projection $L_1 \rightarrow M$ are folds.*

The Hamiltonian isotopy can be chosen in such a way that it is compactly supported and arbitrarily C^0 -small and so that $\max_{t, \gamma} \left| \int_{h_t(\gamma)} pdq - \int_{\gamma} pdq \right|$ is also arbitrarily C^0 -small.

Corollaries 1.6, 1.7 follow from Theorem A and from the general results (see Propositions 4.1, 4.2, 4.3) which classify the homotopy classes of oriented Lagrangian distributions along an oriented surface and describe what singularities can be realized as singularities of tangency of L to an oriented Σ^2 -nonsingular Lagrangian distribution (see Section 4).

Corollary 1.7, in particular, disproves a conjecture by Y. Chekanov [11] that for certain Lagrangian tori in \mathbf{R}^4 the Lagrangian projection necessarily has at least 4 cusp singularities.

Now let us consider the case when $i : L \rightarrow T^*M$ is a Lagrangian immersion and both L and M are orientable surfaces. It follows from the Lagrangian neighborhood theorem [25], [26] that there exists a symplectic immersion F of a neighborhood \mathcal{U} of L in T^*L onto a neighborhood of $i(L)$ in T^*M . Then one has the following version of Corollary 1.7.

Corollary 1.8 *Let $i : L \rightarrow T^*M$ and $F : \mathcal{U} \rightarrow T^*M$ be as above. Then there exists a Hamiltonian isotopy of L into L_1 inside $\mathcal{U} \subset T^*L$ so that all singularities of the Lagrangian projection of an immersed Lagrangian submanifold $F(L_1) \subset T^*M$ on M are folds.*

The Hamiltonian isotopy can be chosen in such a way that it is compactly supported and arbitrarily C^0 -small and so that $\max_{t,\gamma} \left| \int_{F \circ h_t(\gamma)} pdq - \int_{F(\gamma)} pdq \right|$ is also arbitrarily C^0 -small.

1.6 Importance of some of the assumptions in the results above

Remark 1.9 The claims of Corollaries 1.7,1.8 are not necessarily true, if we do not require the orientability of both L and M . For instance, if M is an orientable surface without boundary, L is closed and $\chi(L)$ is odd (which implies that L is non-orientable), then a purely topological obstruction dictates that the number of cusp-singularities for *any smooth map* from L to M is necessarily odd (see [27],[23],[17],[19],[12]).

Remark 1.10 The claims of Theorems A,B and of their Corollaries 1.6, 1.7, 1.8 might not be true, if one does not allow additional double folds – see the discussion about the “rigidity” of folds in Section 1.1.

1.7 The case of a Lagrangian manifold defined by a generating function. Lagrangian collapse

We recall the definition of a *generating function* for a Lagrangian (Legendrian) submanifold.

Definition 1.11 Let K be a manifold and let $f : M \times K \rightarrow \mathbf{R}$ be a function. Consider the graph $\text{Graph}(df)$ of df in $T^*(M \times K)$. This is an exact Lagrangian submanifold of the symplectic space $T^*(M \times K)$. Consider a coisotropic surface $\Sigma \subset T^*(M \times K)$ defined as the set of those 1-forms on $M \times K$ which vanish along the fibers of the projection $M \times K \rightarrow K$. The characteristic foliation on Σ provides a fibration of Σ over T^*M .

We apply to $\text{Graph}(df)$ and Σ the standard construction called the *Lagrangian reduction*. Namely, suppose that $\text{Graph}(df)$ intersects Σ transversally. Then the intersection $\text{Graph}(df) \cap \Sigma$ is a smooth manifold which under the fibration $\Sigma \rightarrow T^*M$ projects into an immersed exact Lagrangian submanifold $L \subset T^*M$. In such a situation f is called a *generating function* for L .

If instead of $\text{Graph}(df)$ we take a graph of a closed 1-form λ on $M \times K$, such that the graph intersects Σ transversally, then the same construction gives us an immersed (and not necessarily exact) Lagrangian submanifold of T^*M , which, we say, is *defined by the generating form λ* .

Using a similar construction (called the *Legendrian reduction*) one can start with a function on $M \times K$, consider a Legendrian submanifold in the 1-jet space $J^1(M \times K)$ which is the graph of the 1-jet of f and define a *Legendrian submanifold of J^1M generated by the function $f : M \times K \rightarrow \mathbf{R}$*

The Lagrangian submanifold in T^*M generated by a function $f : M \times K \rightarrow \mathbf{R}$ is defined in local coordinates by the formula

$$\begin{cases} p = \partial f(q, \xi) / \partial q \\ 0 = \partial f(q, \xi) / \partial \xi \end{cases}$$

A Legendrian submanifold in J^1M generated by $f : M \times K \rightarrow \mathbf{R}$ is defined in local coordinates by the formula

$$\begin{cases} z = f(q, \xi) \\ p = \partial f(q, \xi) / \partial q \\ 0 = \partial f(q, \xi) / \partial \xi \end{cases}$$

Here q, p (resp. q, p, z) are the standard local Darboux coordinates on T^*M (resp. J^1M) and ξ stands for some local coordinates on K .

The following important example is due to V.Arnold, who calls it ‘‘Lagrangian collapse’’ [7].

Example 1.12 Let L be an embedded Lagrangian submanifold of $T^*\mathbf{R}^2$ generated by the function $f(q_1, q_2, \xi) = q_1 \cos \xi + q_2 \sin \xi$ defined on $\mathbf{R}^2 \times S^1$. The question posed by V.Arnold ([7], also see [5]) is whether the caustic of Lagrangian projection of a (generic) Lagrangian submanifold Hamiltonian isotopic to L in $T^*\mathbf{R}^2$ always has at least 4 cusps. In [7] V.Arnold proved that there must be at least 4 such cusps, if the Hamiltonian isotopy is sufficiently C^1 -small. Corollary 1.7 gives a negative answer to the question in the general case. In Section 6 we present an explicit sequence of surgeries on the singularities of the Lagrangian projection of L that eliminate all the cusps on the caustic (and each of these surgeries can be realized by a C^0 -small Hamiltonian isotopy of L). S.Ivankov previously constructed a deformation of L in the class of *immersed* Lagrangian submanifolds which eliminates all the cusps on the caustic (unpublished).

In conjunction with Example 1.12 one might also ask the following question: is it possible to choose the C^0 -small Hamiltonian isotopy destroying the cusps in Example 1.12 so that it is covered by a deformation of the generating function f in the class of generating functions defined on $\mathbf{R}^2 \times S^1$? The following proposition provides an answer to this question.

Proposition 1.13 *Suppose that an embedded Lagrangian submanifold $L \subset T^*M$ is generated by a function f defined (on an open subset of) $M \times K^1$, where K is a (connected) 1-dimensional manifold.*

Then L can be deformed by a Hamiltonian isotopy into a new Lagrangian submanifold L_1 such that the canonical Lagrangian projection of L_1 on M has only fold-type singularities. Moreover, this Hamiltonian isotopy can be covered by a deformation $\{f_t\}$ of the generating function f in the class of generating functions defined (on an open subset of) $M \times K^1$.

The deformation $\{f_t\}$ can be made compactly supported and arbitrarily C^1 -small.

Remark 1.14 Statements similar to Proposition 1.13 can be proved (by exactly the same method as Proposition 1.13) for a Lagrangian submanifold generated by a 1-form defined on $M \times K^1$ and also in the case of an Lagrangian submanifold.

Corollary 1.15 *The C^0 -small Hamiltonian isotopy destroying the cusps in Example 1.12 can be chosen so that it is covered by a deformation of the generating function $f(q_1, q_2, \xi) = q_1 \cos \xi + q_2 \sin \xi$ as a function defined on $\mathbf{R}^2 \times S^1$ (see Example 6.2 in Section 6). The deformation of the function f is compactly supported and can be made arbitrarily C^1 -small*

Remark 1.16 One can prove a strengthened version of Proposition 1.13 similar to Theorem B that says what kind of singularities can be realized (up to possible additional double folds) by a deformation of a generating function f in the class of generating functions defined on (an open subset of) $M \times K^1$ – see Proposition 6.4.

1.8 The Legendrian case

Now let us discuss the Legendrian case. Suppose that $\pi : E \rightarrow M$ is a Legendrian fiber bundle, i.e. E is a contact manifold and the fibers of π

are Legendrian submanifolds of E . The restriction of π on a Legendrian submanifold $L \subset E$ is called *the Legendrian projection of L* . The singularities of the Legendrian projection $\pi : L \rightarrow M$ are called *the Legendrian singularities of L* .

Suppose that $L \subset E$ is an embedded Legendrian submanifold. In the same fashion as before we can use the Legendrian neighborhood theorem [20] (similar to the Lagrangian neighborhood theorem of Weinstein) and reduce the question about the singularities of a Legendrian projection $L \rightarrow M$ to a question about the singularities of tangency of the zero-section in J^1L to a Legendrian foliation defined on a neighborhood of the zero-section.

Observe that under the canonical projection $J^1L \rightarrow T^*L$ Legendrian planes are mapped into Lagrangian planes and this projection establishes a one-to-one correspondence between Legendrian submanifolds of J^1L and exact immersed Lagrangian submanifolds of T^*L . The singularities of tangency of a Legendrian submanifold of J^1L to a Legendrian distribution are the same as for the corresponding (immersed) Lagrangian submanifold and the corresponding Lagrangian distribution downstairs in T^*L . (A Legendrian distribution along a submanifold $\Lambda \subset J^1L$ is a field of Legendrian planes in $T(J^1L)$ defined on Λ .) A C^0 -small Hamiltonian isotopy $\{h_t(L)\}$ of the zero-section of T^*L , such that $\max_{t,\gamma} \left| \int_{h_t(\gamma)} pdq \right|$ is small, corresponds to a C^0 -small contact isotopy of the zero-section of J^1L . In general, we can carry over everything we said before for the Lagrangian case to the Legendrian case by projecting a Legendrian submanifold Λ into T^*L , considering the corresponding Lagrangian (symplectic) object there and then lifting it upstairs to J^1L as a Legendrian (contact) object.

Thus all theorems, corollaries and remarks above for the Lagrangian case have direct analogs in the Legendrian case.

For example, the following Legendrian analog of Theorem A can be immediately deduced from Theorem A. Let us identify L with the zero-section of J^1L . Let \mathcal{F} be a Legendrian foliation defined on a neighborhood of L in J^1L , and let \mathcal{N} be a generic Σ^2 -nonsingular Legendrian distribution along L (the definition of a Σ^2 -nonsingular Legendrian distribution can be given in the same fashion as Definition 1.1 in the Lagrangian case).

Theorem A' *Let L be an oriented surface and suppose that the Legendrian foliation \mathcal{F} and the Legendrian distribution \mathcal{N} are oriented. Suppose also that the oriented Legendrian distributions $\mathcal{F}|_L$ and \mathcal{N} along L can be connected in the class of such distributions.*

Then L is contact isotopic to a Legendrian submanifold $L_1 \subset J^1L$ such

that the singularities of tangency of L_1 to \mathcal{F} are equivalent to the union of the singularities of tangency of L to \mathcal{N} and a number of additional double fold pairs of spheres in L .

The contact isotopy can be made compactly supported and arbitrarily C^0 -small.

The Legendrian counterpart for Corollary 1.7 has been independently announced by P.Pushkar'.

1.9 The sketch of basic ideas used in the proofs of the main results.

The methods we use to prove theorems originate from [13]. First, we prove Theorem B using the following idea. As we said in Section 1.2, a description of singularities of tangency of L to a generic Σ^2 -nonsingular Lagrangian distribution along L can be given by a “complete flag” $L^n \supset V_1 \supset V_2 \supset \dots \supset V_{n+1} = \emptyset$ of (not necessarily connected) smooth submanifolds of L , equipped with some vector fields v_i . In general, such an object (a “complete flag” of submanifolds equipped with appropriate vector fields) will be called a *chain* (see Section 2).

Consider a homotopy $\{\mathcal{N}^t\}$ connecting \mathcal{F} with \mathcal{N} in the class of Σ^2 -nonsingular Lagrangian distributions along L (see Theorem B). We follow the homotopy $\{\mathcal{N}^t\}$ and see what kind of bifurcations happen to the chains associated with each \mathcal{N}^t . Since we are working only with Σ^2 -nonsingular Lagrangian distributions, we can use the classification of the *typical* bifurcations of the singularities of tangency of L to \mathcal{N}^t , i.e. the classification of the typical surgeries on the submanifolds from a chain associated with each Lagrangian distribution \mathcal{N}^t (see [3],[4]). These surgeries can be, roughly speaking, of “birth” and “death” types (following the terminology from [13] we call them *direct* and *inverse* surgeries). By possibly creating additional spheres of folds we can always decompose a “death”-type bifurcation into a product of “birth”-type ones and, thus from the homotopy $\{\mathcal{N}^t\}$ we obtain a “code” – a sequence of “birth”-type bifurcations (direct surgeries) – see Section 2.

Then we consider the singularities of tangency of \mathcal{F} to L and, given a “code”, or a sequence of bifurcations (direct surgeries), we deform L in T^*L in several steps so that the singularities of tangency of \mathcal{F} to L change at each step according to the corresponding “prescribed” bifurcation (direct surgery) from the “code”.

Proposition 1.13 is proved by similar methods. To prove Theorem A we reduce it by certain tricks to Theorem B.

1.10 A brief review of the paper by sections

The paper is organized as follows. In Section 2 we introduce the notions of a chain and of a direct surgery which are our main tools in dealing with singularities of maps. In Section 3 we prove Theorem B modulo the technical details which are discussed in Section 7. In Section 4 we discuss the two-dimensional case and prove Theorem A and the Corollaries 1.6,1.7. In Section 5 we introduce the necessary setup for the case when a Lagrangian submanifold is defined by a generating function. In Section 6 we prove Proposition 1.13 and discuss in details the example of Lagrangian collapse. In Section 7 we prove our main technical result which shows that a direct surgery can be realized by a deformation of a generating function. In Section 8 we explain how to create double folds and what are the “normal forms” for them.

1.11 Acknowledgments

I am deeply grateful to Y.Eliashberg for the numerous helpful discussions and encouragement. He suggested the problem to me and generously and patiently shared with me his ideas on the subject. Without him this work would have never been completed. I am grateful to M.Kazarian for pointing out the mistakes in an earlier version of the paper and for his help in correcting them. I thank Y.Chekanov, N.Mishachev, D.Novikov and V.Zakalyukin for the useful conversations and encouragement. I am indebted to L.Polterovich and to the referee for their remarks on the manuscript.

2 Chains and direct surgeries

In this section we recall some basic notions concerning the structure of singularities (see [13]). Let V^n be an (immersed) submanifold of E^{n+N} ($n \geq 2$). Let us assume for simplicity that the manifold E is equipped with some Riemannian metric.

Definition 2.1 A *weak chain* \mathcal{V} on V is the following object:

a) a sequence of submanifolds of V : $V = V_0 \supset V_1 \supset \dots \supset V_k \supset V_{k+1} = \emptyset$, $k \leq n+1$, $\dim V_i = n-i$, $i = 0, \dots, k$ (we also set $V_{-1} = E^{n+N}$);

b) some unit vector fields v_i , $i = 2, \dots, k$, where each v_i is defined on $V_i \setminus V_{i+1}$, is normal to V_{i-1} in V_{i-2} and cannot be extended (as such a unit normal vector field) to any subset $C \subset V_i$ which has a nontrivial intersection with V_{i+1} .

We are going to use the notion of a weak chain to describe the structure of singularities of tangency of V to a plane field \mathcal{N} on E . Such singularities can be described by an appropriate weak chain equipped with an additional vector field v_1 over $V_1 \setminus V_2$. We are interested in the following two different situations and for each of these situations v_1 is defined differently.

Case I: $E = T^*L$, V is a Lagrangian submanifold of E and \mathcal{N} is a Σ^2 -nonsingular Lagrangian distribution along V .

Case II: $E = M^n \times K^1$, $V^n \subset E^{n+1}$ is a submanifold, \mathcal{N} is a line field on a neighborhood of V in $M \times K^1$.

We need to consider two cases in order to distinguish later between general Hamiltonian isotopies of a Lagrangian submanifold and those of them which can be covered by a deformation of generating functions with a fixed one-dimensional space of additional variables (as needed for Proposition 1.13). In the rest of this section we discuss the first case. The second case will be discussed in Section 5. Thus in the remainder of this section $E = T^*L$ and V is a Lagrangian submanifold of T^*L .

Definition 2.2 A *chain on V* is a weak chain on V equipped with an additional unit vector field v_1 defined on the *whole* V_1 and normal to V_1 in V_0 .

Example 2.3 A chain on a 2-dimensional surface is a union of mutually non-intersecting cooriented curves with some marked points on them. Each marked point is equipped with a unit vector normal to the curve this marked point lies on. An example of a chain in the two-dimensional case is presented on Fig. 3.

Definition 2.4 Two chains (weak chains) on two submanifolds $V_1, V_2 \subset E$ are called *equivalent*, if there exists an isotopy between V_1 and V_2 in E which maps one chain (weak chain) into another.

The following Definition 2.6 shows what chains have to do with singularities. First, we need an auxiliary lemma.

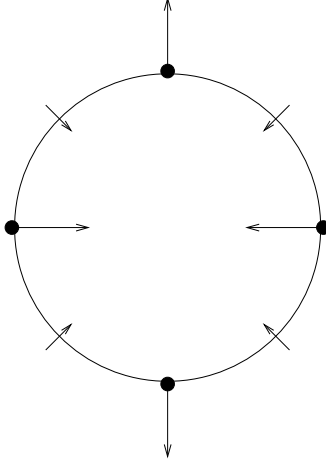

Figure 3: The chain corresponding to the Lagrangian collapse.

Lemma 2.5 *Let $x \in V$ be a point. If \mathcal{N} is a Σ^2 -nonsingular Lagrangian distribution defined along a neighborhood of x in V , then it can be extended to a Lagrangian foliation of a neighborhood of x in T^*L .*

Proof of Lemma 2.5. If \mathcal{N} is transversal to V near x , then the statement follows from the Lagrangian neighborhood theorem [25],[26].

Otherwise, consider a neighborhood U of x in V over which \mathcal{N} is defined. Consider those points of U where \mathcal{N} is not transversal to V . The intersection of \mathcal{N} with T_*V at each such point is a line. Extend this line field to a 1-dimensional subbundle l of \mathcal{N} over U . The orthogonal complement (with respect to a Riemannian metric) of l in \mathcal{N} is an isotropic bundle l^\perp over U . Therefore (see [25]) there exist symplectic coordinates (\mathbf{p}, \mathbf{q}) , $\mathbf{p} = (p_1, \dots, p_n)$, $\mathbf{q} = (q_1, \dots, q_n)$, on a neighborhood of x in T^*L in which V is given by the equation $\mathbf{q} = 0$ and l^\perp (defined over the Lagrangian \mathbf{p} -plane) is given by the equations $\mathbf{p} = 0$, $q_n = 0$. In these new coordinates it is easy to extend the line field l from the \mathbf{p} -plane to a neighborhood of x in T^*L so that the plane field spanned by l and l^\perp is integrable. ■

Definition 2.6 [13] Let \mathcal{N} be a generic Σ^2 -nonsingular Lagrangian distribution along a Lagrangian submanifold $V \subset T^*L$. We define *the chain on V associated with \mathcal{N}* as follows.

First, we define the weak chain. For each point of V we extend \mathcal{N} to a Lagrangian foliation of the neighborhood of x in T^*L . Then using this extension and the fact that \mathcal{N} is generic we identify V and \mathcal{N} in a neighborhood of x in T^*L with some local model. Using this local model we determine to which V_i in the chain the point x should belong and define the corresponding vector field v_i at x . Up to the equivalence of chains, the resulting chain does not depend on the extension of \mathcal{N} and on the identification of a neighborhood of x in T^*L with the local model.

Let us start with constructing a local model. Consider a map $\mu_s : \mathbf{R}^n \rightarrow \mathbf{R}^{n+N}$, $s = 0, \dots, n$, given by the formula

$$\mu_s(t_1, \dots, t_{n-1}, x) = (t_1, \dots, t_{n-1}, \sum_{i=1}^{s-1} t_i x^i + x^{s+1}, x, 0, \dots, 0).$$

Let us denote by \mathcal{L} an N -dimensional vector bundle on \mathbf{R}^{n+N} formed by the fibers of the projection $\pi : \mathbf{R}^{n+N} = \mathbf{R}^n \times \mathbf{R}^N \rightarrow \mathbf{R}^n$. Let us denote by σ_s , $s = 2, \dots, n$, the unit vector in \mathbf{R}^{n+N} at $0 \in \mathbf{R}^{n+N}$ pointing in the positive direction of the axis t_{s-1} .

Let us use Lemma 2.5 and extend \mathcal{N} to a neighborhood of x in T^*L . Then, according to [21], since \mathcal{N} is generic, for each point $x \in V$ there exists a neighborhood U of x in T^*L , a diffeomorphism $h : U \rightarrow \mathbf{R}^{n+N}$ and an integer number s ($0 \leq s \leq n$) such that $h(x) = 0 \in \mathbf{R}^{n+N}$, $h(V \cap U) = \mu_s(\mathbf{R}^n)$ and dh maps $\mathcal{N}|_U$ onto \mathcal{L} .

Thus for each point $x \in V$ we have a correctly defined number s . The closure of the set of points for which the number is equal to s is a smooth closed $(n-s)$ -dimensional submanifold V_s of V . Obviously, $V_0 = V$. We set V_{-1} to be T^*L .

If $x \in V_s \setminus V_{s+1}$, $s \geq 2$, then the vector $d(h^{-1})(\sigma_s)$ is tangent to V_{s-2} and transversal to V_{s-1} . We define the vector v_s at x to be a unit vector normal to V_{s-1} in V_{s-2} so that it defines the same coorientation of V_{s-1} in V_{s-2} as the vector $d(h^{-1})(\sigma_s)$.

Thus we have defined the weak chain. We define the vector field v_1 to be a unit vector field on V_1 normal to V_1 in V and coorienting V_1 in V according to the canonical Maslov coorientation of V_1 in V (see [1]). These conditions uniquely define the vector field v_1 .

Thus we have defined a weak chain and a vector field v_1 . One can check that it is, indeed, a chain. Up to the equivalence of chains this chain does

not depend on the choices made in the construction.

Remark 2.7 In the two-dimensional case the way in which we associate a vector v_2 to each cusp (to each point in V_2) can be seen on Fig. 2.

Remark 2.8 Consider the Lagrangian distribution $Vert$ along a Lagrangian submanifold $V \subset T^*L$ which associates to each point $x \in V$ the tangent space at p to the fiber of the projection $\pi : T^*L \rightarrow L$ which contains x . Assume that the Lagrangian distribution $Vert$ is generic and Σ^2 -nonsingular. Consider a weak chain on V associated with $Vert$ as in Definition 2.6. In this weak chain the set $V_i \setminus V_{i+1}$ consists of those points in V where the map $\pi|_V : V \rightarrow L$ has a singularity of the Thom-Boardman

type $\underbrace{\Sigma^{11\dots 1}}_{i \text{ times}}$.

In fact, this weak chain is completely determined by the map $\pi : V \rightarrow L$ (one can actually associate a weak chain to any smooth map $f : V^n \rightarrow L^n$ which has only $\Sigma^{11\dots 1}$ singularities [13]).

When a Lagrangian distribution \mathcal{N} along V changes, some bifurcations may happen to the chain on V associated with \mathcal{N} . There are two sorts of such typical bifurcations: *direct surgeries* and *inverse surgeries*. Let us start with defining a direct surgery as a formal operation on a chain. We first define a necessary setup needed to perform a direct surgery.

Definition 2.9 [13] A *basis of a direct surgery* of order $s \geq 1$ and index $p \geq 0$ is formed by a chain \mathcal{V} and an embedding $\phi : D^p \times [-1, 1] \rightarrow V_{s-1}$. When $p = 0, s = n$ this embedding must be equipped with a pair of nonzero vectors ν_1, ν_2 which are normal to V_{n-1} in V_{n-2} and which have opposite directions; we also assume in this case that $\phi(D^0 \times [-1, 1]) \subset V_{n-1} \setminus V_{n-2}$. When $p = 0, s = 1$, then, in addition to the data above, the basis includes a pair of nonzero vectors ν_3, ν_4 tangent to the curve $\phi : D^0 \times [-1, 1] \rightarrow V_1$ at the two endpoints and pointing either both inside the curve or both outside the curve.

All this data has to satisfy the following conditions:

- a) $\phi(D^p \times 0) \cap V_s = \phi(D^p \times [-1, 1]) \cap V_{s+1} = \phi(\partial D^p \times 0)$ and the intersections are normal;
- b) $\phi(D^p \times [-1, 1]) \cap V_s = \phi(\partial D^p \times [-1, 1])$ and the intersection is normal;
- c) the vector field $v_{s+1}|_{\phi(\partial D^p \times 0)}$ points inside the disk $\phi(D^p \times 0)$;

- d) If $s > 1$ the vector fields $v_s|_{\phi(\partial D^p \times 1)}$ and $v_s|_{\phi(\partial D^p \times \{-1\})}$ can be extended over $\phi(D^p \times 1)$ and, respectively over $\phi(D^p \times \{-1\})$, as vector fields normal to V_{s-1} in V_{s-2} .
- e) If $s = 1$, the vector field $v_1|_{\phi(\partial D^p \times 0)}$ points either everywhere inside or everywhere outside the connected component of $V_0 \setminus V_1$ which contains $\phi(D^p \times 0)$.

We recall the definition of a *direct surgery*.

Definition 2.10 [13] Suppose that a chain \mathcal{V} and an embedding $\phi : D^p \times [-1, 1] \rightarrow V_{s-1}$ (possibly with a pair of vectors ν_1, ν_2 or ν_3, ν_4) form a basis of a direct surgery of order s and index p . The result of the direct surgery associated with the basis is a new chain \mathcal{V}' defined as follows.

For $i \neq s, s+1$ let us put $V'_i = V_i$ and let us define the pair $V'_s \supset V'_{s+1}$ of submanifolds of the manifold $V'_{s-1} = V_{s-1}$ as the result of the simultaneous attachment of a handle of index p to the pair $V_s \supset V_{s+1}$ along $\phi(D^p \times 0)$ in V_{s-1} . In other words, we do the following. We consider a (closed) tubular neighborhood T of $\phi(D^p \times 0)$ in V_{s-1} (more precisely, in a normal bundle of $\phi(D^p \times 0)$ in V_{s-1}) and present it as a product $T = T_1 \times [-1, 1]$, where

- (i) T_1 is in general position with respect to $\phi(D^p \times [-1, 1])$ in V_{s-1} ;
- (ii) $T_1 \cap V_s = T \cap V_{s+1}$.

We put $N = T \cap V_s$, $N_1 = T \cap V_{s+1} = T_1 \cap V_s$ and define V'_s as $V'_s = (V_s \setminus N) \cup \partial T$. If $N_1 \neq \emptyset$ and $(V_{s+1} \setminus N_1) \cap \partial T_1 = \emptyset$, then we put $V'_{s+1} = V_{s+1} \setminus N_1$, else we put $V'_{s+1} = (V_{s+1} \setminus N_1) \cup \partial T_1$. Finally we smoothen the corners to get smooth manifolds V'_s and V'_{s+1} .

The vector fields v'_i are defined as follows. For $i \neq s-1, s, s+1$ we set $v'_i = v_i$. We can define v'_{s-1} (and in the case when $p > 0$ also v'_s, v'_{s+1}) uniquely (up to the equivalence of chains), if we require that v'_{s-1}, v'_s, v'_{s+1} coincide with v_{s-1}, v_s, v_{s+1} respectively outside of a neighborhood of $\phi(D^p \times [-1, 1])$ in V and that together with the already constructed objects V'_i and v'_i they form a chain.

If $p = 0$, then the surgery adds to V_s another connected component ∂T and to V_{s+1} another connected component $\tilde{V} \subset \partial T$. When $1 < s < n$ we define v'_s, v'_{s+1} by requiring in addition that the field $v'_{s+1}|_{\tilde{V}}$ points outside T . This additional requirement together with the requirements above determines v'_s, v'_{s+1} uniquely (up to the equivalence of chains). If $s = n$, then $\tilde{V} = \emptyset$ and we define v'_s at the points $\phi(D^0 \times \{-1\})$ and $\phi(D^0 \times 1)$ as ν_1 and ν_2 respectively. Finally, if $p = 0, s = 1$ we define v_1

on ∂T as a vector field normal to ∂T in V_0 which agrees with ν_3, ν_4 at the endpoints of $\phi(D^0 \times [-1, 1])$

The chain we obtain is unique up to the equivalence of chains.

From now on, whenever we speak about a direct surgery along a disk D^p , we omit ϕ and identify $\phi(D^p)$ with D^p and $\phi(D^p \times [-1, 1])$ with $D^p \times [-1, 1]$.

An *inverse surgery*, as a formal operation on a chain, can be defined in a spirit similar to the definition of a direct surgery (see [13] for details). Inverse surgeries are exactly the operations on chains inverse to direct surgeries.

The following proposition is analogous to a result mentioned in [13] and can be proved (as the result in [13]) by the methods developed in [3] (also see Section 22.4 of [4]).

Proposition 2.11 *Let $\{\mathcal{N}^t\}$ be a generic 1-parameter family of Σ^2 -nonsingular Lagrangian distributions along V ($\dim V \geq 2$). Then the chain on V associated with \mathcal{N}^1 can be obtained from the chain associated with \mathcal{N}^0 by a sequence of direct and inverse surgeries.*

Example 2.12 All possible direct surgeries for the two-dimensional case are presented on Fig. 4. The actual changes of a surface (with respect to a fixed vertical line field) are presented on Fig. 5. The possible inverse surgeries are exactly the opposite operations.

Proposition 2.13 [13] *Consider an inverse surgery on a chain $\mathcal{V} = \{V_i, v_i\}$ which transforms \mathcal{V} into another chain $\mathcal{V}' = \{V'_i, v'_i\}$. Suppose that the inverse surgery is an inverse of a direct surgery of order s along a disk D^p (i.e. this direct surgery transforms \mathcal{V}' into \mathcal{V}). Suppose also that there exists an embedding $\alpha : D^1 \rightarrow V_0$ which satisfies the following properties:*

(i) $\alpha(0) \in \partial D^p$, $\alpha(1) \notin \partial D^p$, $\alpha(D^1) \cap V_1 = \alpha(\partial D^1)$ and $\alpha(D^1)$ is normal to V_1 at $\alpha(\partial D^1)$;

(ii) the vectors from the vector field v_1 at the endpoints of $\alpha(D^1)$ either both point inside $\alpha(D^1)$ or both point outside of it.

Then the inverse surgery can be represented as a composition of direct surgeries.

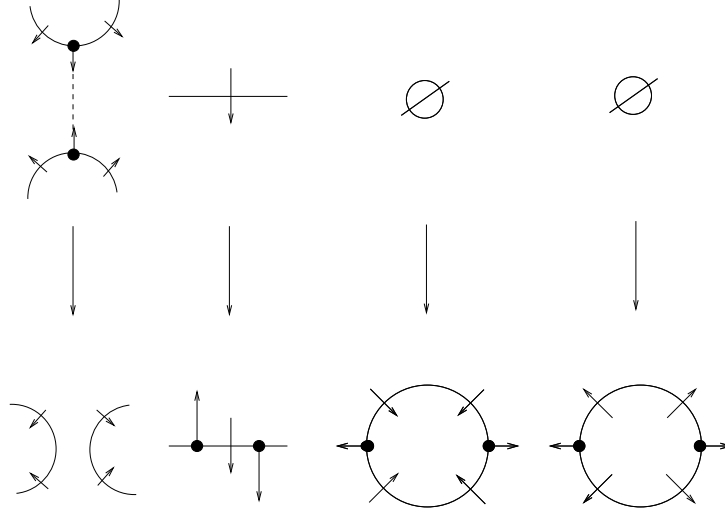

Figure 4: The list of possible direct surgeries for the two-dimensional case.

Definition 2.14 [13] We call an inverse surgery satisfying the hypothesis of Proposition 2.13 *complete*.

Example 2.15 The proof of Proposition 2.13 in the two-dimensional case is presented on Fig. 6.

3 Proof of Theorem B

In this section we state that a direct surgery can be realized by a Hamiltonian isotopy. We also state that by a Hamiltonian isotopy we can create additional double fold pairs of spheres in a neighborhood of a point in L at which the foliation \mathcal{F} is transversal to L . The proofs of the statements are contained in the subsequent sections. From these results we deduce Theorem B.

Notational convention.

From now on we do not distinguish between L and the zero-section of T^*L . We denote by the same letter \mathcal{F} the foliation on a neighborhood \mathcal{U} of the

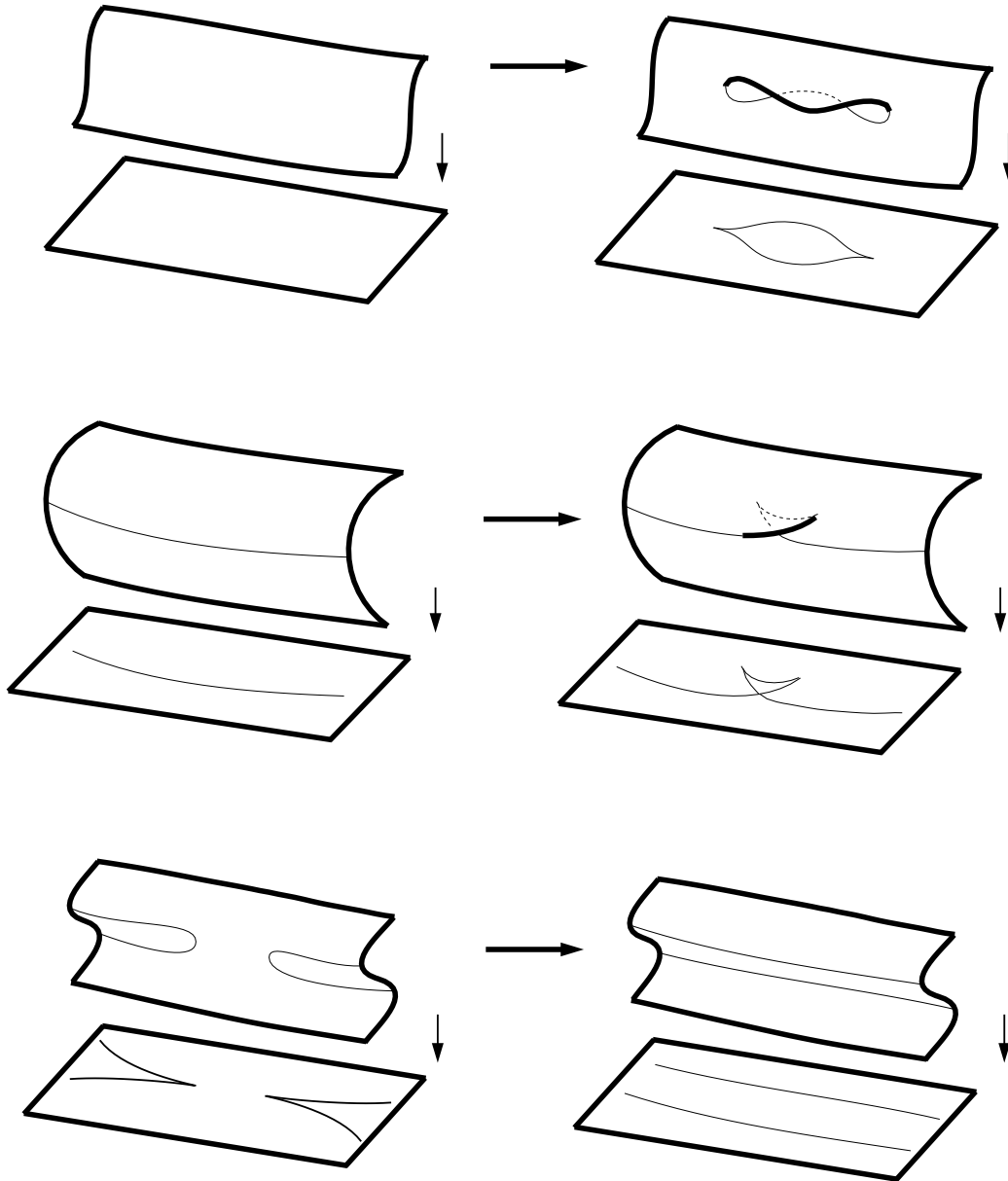

Figure 5: Direct surgeries viewed as changes of surfaces with respect to a projection.

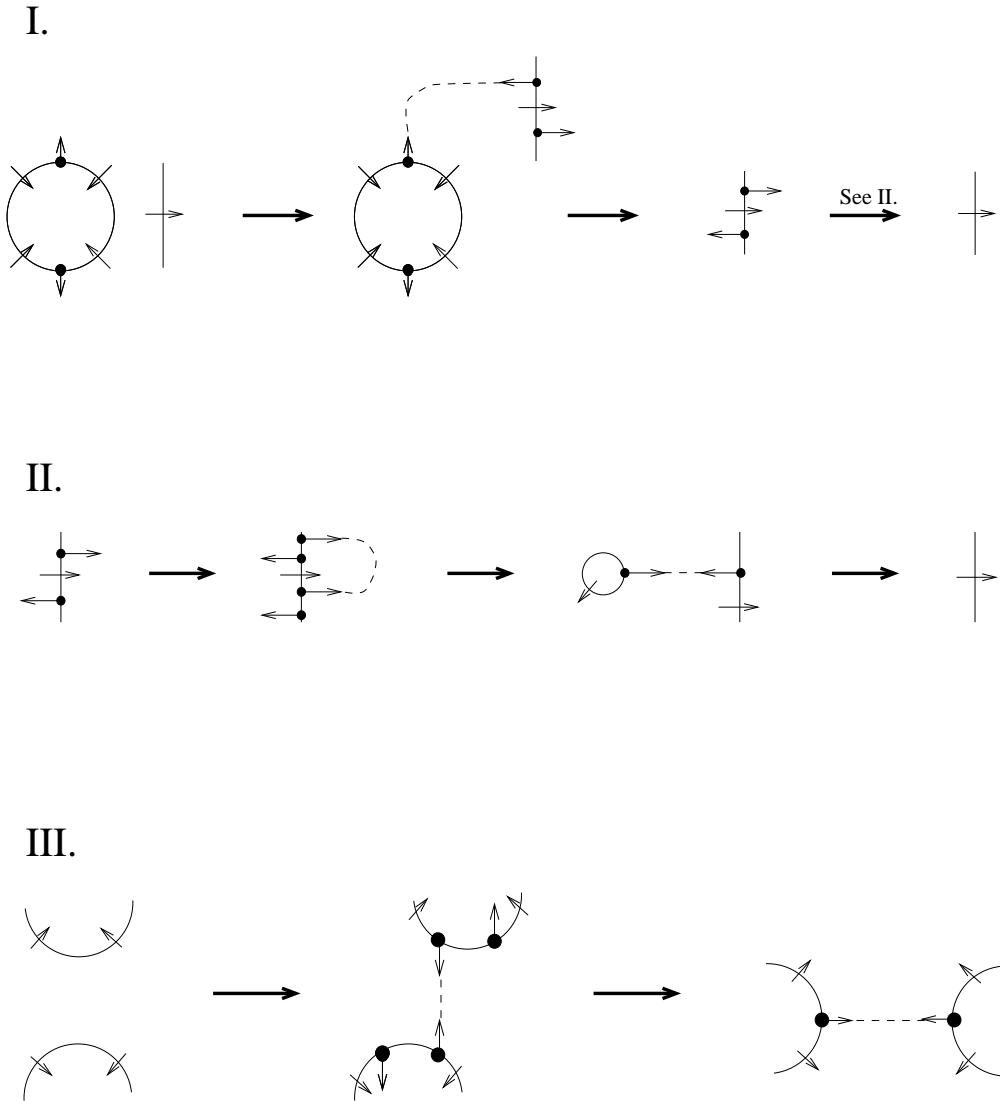

Figure 6: Complete inverse surgeries presented as compositions of direct surgeries in the two-dimensional case.

zero-section L in T^*L and the Lagrangian distribution along L induced by this foliation.

Proposition 3.1 *Let \mathcal{V} be the chain on L associated with \mathcal{F} and let \mathcal{V}_1 be the result of a direct surgery of order s , $s \geq 1$, along a disk $D^p \subset V_{s-1}$. Then for any neighborhood U of D^p there exists a Hamiltonian flow $\{h_t\}$, $0 \leq t \leq 1$, such that:*

(i) *the chain \mathcal{V}_1 is equivalent to the chain on the Lagrangian submanifold $L_1 = h_1(L)$ associated with \mathcal{F} ;*

(ii) *$h_t = \text{id}$ outside U for any t , $0 \leq t \leq 1$.*

The Hamiltonian isotopy $\{h_t\}$ above can be chosen in such a way that it is compactly supported and arbitrarily C^0 -small and so that $\max_{t,\gamma} \left| \int_{h_t(\gamma)} pdq \right|$ is also arbitrarily C^0 -small.

We will prove Proposition 3.1 in Section 6.

Proposition 3.2 *Let $B \subset L$ be a ball in L such that \mathcal{F} is transversal to L along B . Let \mathcal{V} be the chain on L associated with \mathcal{F} . Consider a new chain \mathcal{V}_1 on L which is a union of \mathcal{V} and a double fold pair of spheres lying in B .*

Then there exists a Hamiltonian isotopy $\{h_t(L)\}$, $0 \leq t \leq 1$, of L such that the chain \mathcal{V}_1 is equivalent to the chain on L associated with the Lagrangian distribution $(h_1)_^{-1}(\mathcal{F})$ along L .*

The Hamiltonian isotopy $\{h_t\}$ can be chosen in such a way that it is compactly supported and arbitrarily C^0 -small and so that $\max_{t,\gamma} \left| \int_{h_t(\gamma)} pdq \right|$ is also arbitrarily C^0 -small.

Any of the two possible combinations of Maslov coorientations of S_1 and S_2 can be realized by a Hamiltonian isotopy as above.

We will prove Proposition 3.2 in Section 8.

Proof of Theorem B. Let $\{\mathcal{N}^t\}$ be a deformation connecting \mathcal{F} with \mathcal{N} in the class of Σ^2 -nonsingular Lagrangian distributions along L . We apply Proposition 2.11 and get a sequence of direct and inverse surgeries associated to the homotopy $\{\mathcal{N}^t\}$. Then we deform L step by step by C^0 -small Hamiltonian isotopies so that the chain on the deformed submanifold (which we identify with L) associated with \mathcal{F} changes according to the given surgery.

Namely, let us take the first surgery from the sequence. If it is a *direct surgery*, we realize it by a C^0 -small Hamiltonian isotopy with the help of Proposition 3.1.

If it is a *complete inverse surgery*, then we use Proposition 2.13 and decompose this inverse surgery into a product of direct surgeries reducing the problem to the previous situation.

If this is an inverse surgery which is *not complete*, we make it complete by the following trick. We can pick a point $x \in L$ at which \mathcal{F} is transversal to L and, using Proposition 3.2, create (by a C^0 -small Hamiltonian isotopy supported in an arbitrarily small neighborhood of x) a double fold along some spheres S_1 and S_2 . We can assume then that the result of the inverse surgery is the chain \mathcal{V}_1 formed by \mathcal{V} and the spheres S_1 and S_2 . By an appropriate choice of x and of the Maslov coorientations orientations of S_1 and S_2 (see Proposition 3.2) we can always make the inverse surgery complete and reduce the problem to the previous case.

Thus we can deform L by a C^0 -small Hamiltonian isotopy into a new Lagrangian submanifold $L' \subset \mathcal{U} \subset T^*L$. Consider a small tubular neighborhood of L' in \mathcal{U} . This tubular neighborhood is symplectomorphic to a neighborhood of the zero-section in T^*L by the Lagrangian neighborhood theorem [25],[26]. Therefore we can identify L' with L , take the next surgery from the sequence and repeat the whole procedure for the new L . Then we take the next surgery from the sequence etc.

Thus working step by step, we construct a sequence of compactly supported and arbitrarily C^0 -small Hamiltonian isotopies of L . According to Proposition 3.2, each of the Hamiltonian isotopies can be chosen so that, if we fix a path γ in L and consider its deformation $\{\gamma_t\}$ under the isotopy, then the number $|\int_{\gamma_t} pdq|$ is bounded by a uniform arbitrarily small number which does not depend on t and γ . The composition of all the isotopies above gives us the necessary Hamiltonian isotopy $\{h_t(L)\}$. The chain on $h_1(L)$ associated with \mathcal{F} is equivalent to the union of the chain \mathcal{V} associated with \mathcal{N} and possibly a number of additional double fold pairs of spheres that we might have created when we decomposed an incomplete inverse surgery into a product of direct surgeries. ■

4 The two-dimensional case

4.1 Preliminaries

Let us start with a discussion of the Grassmannian Λ_2^+ of oriented Lagrangian planes in the standard symplectic space \mathbf{R}^4 . This Grassmannian can be represented as the quotient $U(2)/SO(2)$ which is diffeomorphic to $S^2 \times S^1$ (see e.g. [1] or [6]).

Let us fix a Lagrangian plane o in \mathbf{R}^4 . Let o^+, o^- be the two points in Λ_2^+ corresponding to the plane o taken with the two possible orientations. The points in Λ_2^+ corresponding to oriented Lagrangian planes which are not transversal to o in \mathbf{R}^4 form a 2-dimensional surface $\Sigma \subset \Lambda_2^+$ which is smooth outside o^+ and o^- and which has isolated singularities at o^+ and o^- topologically equivalent to the Morse singularity of the cone $\{(x, y, z) \in \mathbf{R}^3 \mid x^2 + y^2 - z^2 = 0\}$ at zero. Topologically the surface Σ is formed by some two spheres S_+ and S_- glued to each other at the two points o^+ and o^- . The homology classes of S_+ and S_- are equal (up to sign) to the homology class of $S^2 \times \{pt\}$ in $\Lambda_2^+ \cong S^2 \times S^1$. The complement $\Lambda_2^+ \setminus \Sigma$ consists of two connected components homeomorphic to a three-dimensional ball. These two components, the “positive” one and the “negative” one, correspond to the two possible orientations of \mathbf{R}^4 : a point in the “positive” (resp. the “negative”) component corresponds to an oriented Lagrangian plane transversal to o which together with o^+ defines the positive (resp. the negative) orientation of \mathbf{R}^4 with respect to the symplectic form ω . The canonical Maslov coorientation of $\Sigma \setminus \{o^+, o^-\}$ (see [1]) points from the “positive” component to the “negative” one on one of the spheres S_+, S_- and from the “negative” component to the “positive” component on another. Locally, Σ subdivides a small neighborhood of o^- (resp. o^+) into three connected components. One of them (a “big” one) has a common boundary with the two others and contains the oriented Lagrangian planes which together with o^- (resp. o^+) determine the positive orientation of \mathbf{R}^4 .

Another way to describe Σ is the following. Take a line l in the plane o . The oriented Lagrangian planes in \mathbf{R}^4 containing l form a simple closed curve $\gamma_l \subset \Sigma$ in the Grassmannian Λ_2^+ . For any $l \subset o$ the curve γ_l passes through o^+ and o^- . The surface Σ is formed by a revolving curve γ_l as the line l revolves (counterclockwise) in o^+ , and a full turn of l in \mathbf{RP}^1 corresponds to a full turn of γ_l in Σ . By specifying that we rotate l counterclockwise in o^+ , we have chosen some generators g_1, g_2 of $\pi_1(S_1 \setminus \{o^+, o^-\})$, $\pi_1(S_2 \setminus \{o^+, o^-\})$. This also determines a specific orientation for each curve γ_l .

Each curve γ_l from above represents a generator C_1 of the fundamental group $\pi_1(\Lambda_2^+) \cong \mathbf{Z}$. Moreover, the curve γ_l is oriented and so we can fix a

specific generator $c_1 \in H^1(\Lambda_2^+)$ as a cohomology class dual to C_1 . We define an orientation of Λ_2^+ by requiring that the intersection number of C_1 with the oriented disk bounded by g_i is 1. The disk bounded by g_i is oriented in such a way that g_i rotates counterclockwise with respect to the orientation of the disk. Another representative of C_1 can be obtained by taking any plane $o_1 \in \Lambda_2^+$ and taking the closed path $\varsigma_{o_1}(t) = e^{\pi it} o_1$, $0 \leq t \leq 1$.

Let $c_2 \in H^2(\Lambda_2^+)$ be the cohomology class dual to the homology class $S^2 \times \{pt\}$ in $S^2 \times S^1$, where the orientation of $S^2 \times \{pt\}$ is chosen so that the intersection number of $S^2 \times \{pt\}$ with $\{pt\} \times S^1$ (oriented as above) is equal to 1 with respect to the orientation of the whole space Λ_2^+ chosen as above.

Consider a (constant) oriented Lagrangian plane field o^+ on \mathbf{R}^4 . Let $L^2 \subset \mathbf{R}^4$ be an (immersed) oriented Lagrangian surface with boundary such that L is transversal to o over ∂L . Let $f : L \rightarrow \Lambda_2^+$ be the Gaussian map of L . Then $c = f^*c_1 \in H^1(L, \partial L)$ is the Maslov class of L with respect to o (or with respect to the Lagrangian projection of \mathbf{R}^4 along o) – see [1]. Also observe that since L is oriented each component of ∂L acquires a canonical orientation and therefore we have a canonical trivialization of T_*L near ∂L . This allows us to define the (relative) Euler class $e \in H^2(L, \partial L)$ of the oriented plane bundle o^+ on L . One can check that with our choice of orientations the class e is induced by f from the generator c_2 (see [10] or [24], p.239). More precisely, the trivialization of T_*L along the boundary ∂L correctly defines a map $f^* : H^2(\Lambda^+) \rightarrow H^2(L/\partial L) \cong H^2(L, \partial L)$. This finishes the discussion of the Grassmannian Λ_2^+ .

Now we want to extend the definitions of Maslov and Euler classes to the case of an oriented Lagrangian distribution \mathcal{N} along an oriented surface (with boundary) L identified with the zero-section of T^*L . As before we consider only those Lagrangian distributions which are transversal to L near ∂L . In particular, this implies that there exists a unique almost complex structure J defined near ∂L on T^*L so that (near ∂L) one has $J(T_*L) = \mathcal{N}$ and so that J is tamed by the canonical symplectic form $\omega = d(pdq)$ on T^*L . (We say that an almost complex structure J on T^*L is tame, or is tamed by the symplectic form ω , if $\omega(Jv, v) > 0$ and $\omega(Jv, Jv) = \omega(v, v)$ for any nonzero $v \in T_*(T^*L)$). This almost complex structure J , defined near ∂L , can be extended to a tame almost complex structure on the whole T^*L . Together J and ω define a Riemannian metric g , where $g(x, y) = \omega(x, Jy)$, $x, y \in T_*(T^*L)$.

If we consider the canonical trivialization of T_*L near ∂L , we can use J to find the canonical trivialization of \mathcal{N} near ∂L . Therefore there exists a correctly defined (relative) Euler class $e(\mathcal{N}) \in H^2(L, \partial L) \cong \mathbf{Z}$ of \mathcal{N} .

To define the Maslov class of \mathcal{N} in this situation one should imitate the definition for the case of a Lagrangian submanifold of \mathbf{R}^{2n} in the following way. Take a point $x \in L$ and choose some g -orthogonal bases in the tangent space $T_x L$ to the zero-section $L \subset T^*L$ and in the Lagrangian plane \mathcal{N}_x . There exists a unique unitary linear operator $u(x)$ on the complex Hermitian space $T_x(T^*L)$ which maps the basis of $T_x L$ into the basis of \mathcal{N}_x . (This operator $u(x)$ is an element of the fiber over x of the principal $U(2)$ -bundle over T^*L defined by J and g). The map $f(x) = \det^2(u(x))$ from L to the circle $\mathbf{S}^1 = e^{i\phi} \subset \mathbf{C}$ is correctly defined and does not depend on the choice of the bases above. Observe that since $\mathcal{N} = J(T_*L)$, the map f is identically equal to 1 near ∂L . Let c' be the generator of $H^1(\mathbf{S}^1, pt)$ corresponding to the counterclockwise orientation of \mathbf{C} . The cohomology class $c(\mathcal{N}) = f^*(c') \in H^1(L, \partial L)$ is called the *Maslov class* of the Lagrangian distribution \mathcal{N} along L .

The Maslov class of \mathcal{N} can also be seen in the following way. As we mentioned before, a generic Lagrangian distribution along L is Σ^2 -nonsingular because Lagrangian singularities of the Thom-Boardman type Σ^2 generically have codimension 3 (see [2],[4]). Assume now that \mathcal{N} is generic and consider the chain on L associated with \mathcal{N} (see Definition 2.6). The submanifold V_1 from this chain, cooriented by the vector field v_1 , defines a cohomological class $c(\mathcal{N}) \in H^1(L, \partial L)$, which is nothing else but the Maslov class of \mathcal{N} .

4.2 Auxiliary results

Let L be an oriented two-dimensional compact surface (possibly with boundary).

Proposition 4.1 *Let \mathcal{N}^1 and \mathcal{N}^2 be two oriented Lagrangian distributions coinciding near ∂L . Then \mathcal{N}^1 and \mathcal{N}^2 are homotopic (rel. ∂L) as oriented Lagrangian distributions if and only if their Euler and Maslov classes are equal.*

Let \mathcal{N} be a generic Σ^2 -nonsingular oriented Lagrangian distribution along L . Consider the submanifold V_1 from the chain on L associated with \mathcal{N} . Since L and \mathcal{N} are oriented, V_1 subdivides L into two parts L_1 and L_2 so that over L_1 (resp. L_2) the oriented submanifold L and \mathcal{N} together define a positive (resp. the negative) orientation of T^*L .

Proposition 4.2 [17],[12] *In the situation as above let us assume that there are n_1 points in V_2 at which the vectors v_2 point inside L_1 and n_2 points where v_2 points inside L_2 . Then $\chi(L_1) - \chi(L_2) + n_1 - n_2 = e(\mathcal{N})$.*

Proposition 4.3 *A chain \mathcal{V} on L can be realized as a chain associated with some Σ^2 -nonsingular oriented Lagrangian distribution along L if and only if it satisfies the following property:*

the submanifold V_1 from the chain \mathcal{V} subdivides L into two different (not necessarily connected) parts with the common boundary V_1 .

Proof of Proposition 4.1. Suppose that \mathcal{N}^1 and \mathcal{N}^2 are homotopic rel. ∂L . It follows from the definition that the Maslov classes of \mathcal{N}^1 and \mathcal{N}^2 are equal. The Euler classes also have to be equal since \mathcal{N}^1 and \mathcal{N}^2 are isomorphic rel. ∂L .

Now suppose that $c(\mathcal{N}^1) = c(\mathcal{N}^2)$, $e(\mathcal{N}^1) = e(\mathcal{N}^2)$. Consider a vector bundle $E \rightarrow L$ which associates to each point $x \in L$ the tangent space $T_x(T^*L)$. Consider a fiber bundle $\Lambda_2^+(E) \rightarrow L$ which associates to each point $x \in L$ the Grassmannian of oriented Lagrangian planes in the fiber of E over x . Any oriented Lagrangian distribution \mathcal{N} on L is a section of the fiber bundle $\Lambda_2^+(E) \rightarrow L$. We triangulate L into small simplices so that over each 2-simplex the vector bundle $E \rightarrow L$ is trivial. It follows from Section 4.1 and from the standard obstruction theory that the equality $c(\mathcal{N}^1) = c(\mathcal{N}^2)$ allows to extend a homotopy between \mathcal{N}^1 and \mathcal{N}^2 from the 0-skeleton of the triangulation to the 1-skeleton (keeping it identical near ∂L), and the equality $e(\mathcal{N}^1) = e(\mathcal{N}^2)$ allows to extend a homotopy between \mathcal{N}^1 and \mathcal{N}^2 from the 1-skeleton to the 2-skeleton (again keeping it identical near ∂L). ■

Proof of Proposition 4.2. Take some small tubular neighborhoods in L of each closed curve $\gamma_i \subset V_1$ and cut L open along the boundaries of those tubular neighborhoods. Over each piece L'_i that does not intersect V_1 the plane bundle \mathcal{N} is isomorphic to $\pm T_*L'_i$ (the sign depends on the orientations, i.e. whether $L'_i \subset L_1$ or $L'_i \subset L_2$). Therefore, $e(\mathcal{N}|_{L'_i}) = \pm \chi(L'_i)$. Orient each γ_i in such a way that, if we rotate a positive tangent vector to γ_i by 90 degrees counterclockwise, we get a normal vector which points into L_1 . It follows from the discussion in Section 4.1 that over each cylindrical piece L''_i containing a curve $\gamma_i \subset V_1$ the Euler class $e(\mathcal{N}|_{L''_i})$ is equal to the rotation number of the line field $\mathcal{N} \cap T_*L \subset T_*L$ defined on the oriented curve γ_i (in the oriented plane bundle T_*L). This rotation number is equal to $n'_2 - n'_1$, where n'_1 and n'_2 are the numbers of cusps (points from V_2) lying on γ_i at which the vector v_2 points inside L_1 and L_2 respectively.

Adding up the Euler numbers for all pieces of L'_i and L''_i we get the required formula. ■

Proof of Proposition 4.3. Obviously, if L and \mathcal{N} are oriented, then V_1 subdivides L into two parts with the common boundary V_1 .

Suppose now that V_1 subdivides L into the two parts L_1 and L_2 (“positive” and “negative”) as above. One can easily define \mathcal{N} near V_1 so that \mathcal{N} has the prescribed singularities of tangency to L along V_1 and so that for any x near V_1 , $x \notin V_1$, the oriented planes $T_x(L)$ and \mathcal{N}_x together define the positive (resp. the negative) orientation of the ambient space $T_x(T^*L)$, if x lies in L_1 (resp. L_2). To extend of \mathcal{N} to the rest of L means to extend a section of a fiber bundle with a contractible fiber from a submanifold of the base to the whole base (see Section 4.1 and the proof of Proposition 4.1). This can always be done. ■

4.3 Proofs of Corollaries 1.6,1.7

First, we use the Lagrangian neighborhood theorem in the same way as before but instead of the singularities of the Lagrangian projection $L \rightarrow M$ we consider the singularities of tangency of the zero-section of T^*L to the foliation $\mathcal{F} = F^*(Vert)$, where $Vert$ is the foliation of T^*M by the fibers of the cotangent bundle and F is a symplectomorphism between a neighborhood of the zero-section of T^*L and a neighborhood of L in T^*M . Observe that the Euler class $e(\mathcal{F})$ is necessarily even.

Proof of Corollary 1.6. According to Proposition 4.3, there exists an oriented Σ^2 -nonsingular Lagrangian distribution \mathcal{N} along L , such that the chain on L associated with \mathcal{N} is equivalent to the chain $\{T^*L \supset L \supset V_1 \supset V_2; v_1, v_2\}$. Then we finish the proof by applying Theorem A and Propositions 4.1 and 4.2 to the distributions \mathcal{N} and \mathcal{F} . ■

Proof of Corollary 1.7. Consider the chain $\mathcal{V} = \{V_j, v_j\}$ on the zero-section $L \subset T^*L$ associated with the Σ^2 -nonsingular oriented Lagrangian distribution \mathcal{F} . Let L_1 and L_2 as before denote the two parts of L with the common boundary V_1 .

If the submanifold V_2 is non-empty, we construct another chain on L in the following way. We take the chain \mathcal{V} , choose some points x_1, \dots, x_k in

the interior part of L_1 and some points y_1, \dots, y_m in the interior part of L_2 . Then we add to $V_1 \setminus V_2$ some $k+m$ new small circles around the points $x_1, \dots, x_k, y_1, \dots, y_m$, and after that we remove V_2 from the chain (i.e. we erase all points of V_2 from the curves which form V_1). In this way we obtain a new chain which we call \mathcal{V}' . Using the formula from Proposition 4.2 and according to Proposition 4.3, since $e(\mathcal{F})$ is even, we get that the number of points in the original submanifold V_2 is even. Therefore we can find some appropriate numbers k and m so that for the new chain \mathcal{V}' and for the new parts L'_1, L'_2 of L (defined in the same way as L_1 and L_2 above) we have the following formula: $\chi(L'_1) - \chi(L'_2) = e(\mathcal{F})$. We finish the proof by applying Corollary 1.6 to the chain \mathcal{V}' . ■

4.4 Proof of Theorem A

An outline of the proof. As before we assume that \mathcal{F} and \mathcal{N} coincide near ∂L . Our strategy is to reduce Theorem A to Theorem B. Initially \mathcal{F} and \mathcal{N} may not be homotopic in the class of Σ^2 -nonsingular oriented Lagrangian distributions along L . Indeed, Lagrangian singularities of the type Σ^2 are (generically) of codimension 3 and therefore (generically) at some discrete moments a homotopy between \mathcal{F} and \mathcal{N} may pass through a Σ^2 -nonsingular distribution. In order to overcome this problem we construct some special Hamiltonian isotopy $\{h_t(L)\}$, $0 \leq t \leq 1$, supported in an arbitrarily small neighborhood of a point in L , so that in the course of this isotopy at exactly one moment t the Lagrangian submanifold $h_t(L)$ has a single point of Σ^2 -singularity of tangency to the fixed foliation \mathcal{F} . Then we replace \mathcal{F} by a new Lagrangian distribution $h_1^{-1}(\mathcal{F})$ along L . We show that we can apply to L a number of isotopies of the same kind as $\{h_t\}$, each time changing \mathcal{F} as above, so that at the end instead of the original \mathcal{F} we get a Lagrangian distribution \mathcal{F}_1 homotopic to \mathcal{N} in the class of Σ^2 -nonsingular oriented Lagrangian distributions along L . Then we apply Theorem B to the distributions \mathcal{F}_1 and \mathcal{N} . This finishes the outline of the proof.

We start with considering the same setup as in the proof of Proposition 4.1. Namely, we consider a vector bundle $E \rightarrow L$ which to each point $x \in L$ associates the tangent space $T_x(T^*L)$. Consider a fiber bundle $\Lambda_2^+(E) \rightarrow L$ which associates to each point $x \in L$ the Grassmannian of oriented Lagrangian planes in the fiber of E over x . Both \mathcal{F} and \mathcal{N} can be viewed as sections of $\Lambda_2^+(E) \rightarrow L$. We triangulate L into small simplices so that over each 2-simplex the vector bundle $E \rightarrow L$ is trivial.

Lemma 4.4 *Suppose that the Lagrangian distributions \mathcal{F} and \mathcal{N} are homotopic as oriented Lagrangian distributions along a closed simplex Δ from the triangulation and coincide near $\partial\Delta$. Then there exists a Hamiltonian isotopy $\{h_t(\Delta)\}$, $0 \leq t \leq 1$, such that along Δ the Lagrangian distribution $(h_1^{-1})_*(\mathcal{F})$ is homotopic to \mathcal{N} in the class of Σ^2 -nonsingular Lagrangian distributions (and this homotopy is supposed to be identical near the boundary of Δ).*

The Hamiltonian isotopy can be chosen in such a way that it is arbitrarily C^0 -small, supported inside Δ and so that $\max_{t,\gamma} \left| \int_{h_t(\gamma)} pdq \right|$ is also arbitrarily C^0 -small.

Proof of Lemma 4.4. We can assume that the simplex Δ is sufficiently small. Then, without loss of generality, we can identify Δ with a neighborhood $U \subset \mathbf{R}^2$ of zero inside the zero-section $\mathbf{R}^2 \subset \mathbf{R}^4$. We can also identify the restriction of the vector bundle $E \rightarrow L$ on Δ with the tautological vector bundle which associates to each point of $\mathbf{R}^2 \subset \mathbf{R}^4$ the ambient space \mathbf{R}^4 . Since \mathcal{F} and \mathcal{N} coincide near $\partial\Delta$ these two distributions along Δ together form a spheroid $S(\Delta)$ in Λ_2^+ . By the hypothesis of the lemma this spheroid is contractible. Let us choose a particular homotopy $\{S_t(\Delta)\}$, $0 \leq t \leq 1$, which contracts the spheroid $S(\Delta)$ to a point in Λ_2^+ . We can assume that this homotopy is generic. Then there is a finite number of moments t at each of which the deformation $\{S_t(\Delta)\}$ passes transversally through exactly one of the points $o^+, o^- \in \Lambda_2^+$. Without loss of generality we can consider the case when there is exactly one such moment t and at this moment the deformation $\{S_t(\Delta)\}$ passes transversally through the point o^+ .

Sublemma 4.5 *There exists a Hamiltonian isotopy $\{h_t(U)\}$, $0 \leq t \leq 1$, of U in \mathbf{R}^4 which satisfies the following property:*

for any t the Lagrangian submanifold $h_t(U)$ coincides with U near ∂U so that under the Gaussian map $h_t(U)$ and U together form a spheroid in Λ_2^+ which is homotopic to the spheroid $S_t(\Delta)$ in $\Lambda_2^+ \setminus \{o^-, o^+\}$.

The Hamiltonian isotopy can be chosen in such a way that it is arbitrarily C^0 -small, supported inside U and so that $\max_{t,\gamma} \left| \int_{h_t(\gamma)} pdq \right|$ is also arbitrarily C^0 -small.

Proof of Sublemma 4.5. Let us pick a point $x \in \Delta$ at which the planes $T_x L$ and \mathcal{F}_x together define a negative (with respect to the standard symplectic form) orientation on the ambient symplectic space T^*L at x . (If

such an x does not exist, it means that \mathcal{F} and \mathcal{N} are already homotopic as Σ^2 -nonsingular oriented Lagrangian distributions along Δ).

We use the Darboux theorem and reduce our problem to a local model in \mathbf{R}^4 , where L is identified with the (“horizontal”) (q_1, q_2) -plane and \mathcal{F} is identified with the foliation of \mathbf{R}^4 by the planes parallel to the (“vertical”) (p_1, p_2) -plane. Here p_1, p_2, q_1, q_2 denote the standard symplectic coordinates on \mathbf{R}^4 . We identify the (oriented) (p_1, p_2) -plane in \mathbf{R}^4 with the point $o^+ \in \Lambda_2^+$, so that the (oriented) (q_1, q_2) -plane together with o^+ define a negative orientation of \mathbf{R}^4 with respect to the standard symplectic form $dp \wedge dq$. We will also use the notation $r = 1/2(q_1^2 + q_2^2)$, $R = 1/2(p_1^2 + p_2^2 + q_1^2 + q_2^2)$.

Given a number δ one can find a small enough number ϵ and a big enough number N to construct a family of functions $\{f_\tau(q_1, q_2)\}$, $-\epsilon \leq \tau \leq \epsilon$, so that the following conditions are fulfilled for any τ :

- (i) the function is equal to 0, when $r \geq 3\delta$, and equal to $-q_1^2 q_2 + q_2^3/3$, when $\delta/10 \leq r \leq 2\delta$;
- (ii) $f_\tau(q_1, q_2) = -q_1^2 q_2 + q_2^3/3 + \tau(q_1^2 + q_2^2)$ when $r \leq \delta/N$;
- (iii) f_τ does not have critical points when $\delta/N \leq r \leq \delta/10$.

Consider a Lagrangian submanifold $L_\tau \subset \mathbf{R}^4$ generated by the function f_τ . Each L_τ has a nonsingular projection on L and is Hamiltonian isotopic to L (and this Hamiltonian isotopy is identical at infinity).

Let $H(R)$ be non-negative function, linear and decreasing on $[0, \delta/2]$, decreasing and concave up on $[\delta/2, \delta]$ and equal to zero outside of $[0, \delta]$. Consider the Hamiltonian flow $\{h'_t\}$, $0 \leq t \leq T$, $T = -\pi/2H_R(0)$, corresponding to the Hamiltonian function H on \mathbf{R}^4 , where by H_R we denote the derivative of H with respect to R . Let us apply this Hamiltonian flow to the deformation L_τ . A direct calculation shows that for any $\tau < 0$ and any $0 \leq t \leq T$ the Lagrangian submanifold $h'_t(L_\tau)$ has no Σ^2 -singularities of the Lagrangian projection on the zero-section L . It also shows that for any $\tau \geq 0$ there exists a unique t , $0 \leq t \leq T$, such that the Lagrangian submanifold $h'_t(L_\tau)$ has a single point where its tangent plane coincides with the vertical plane o^+ and has no other Σ^2 -singularities of the Lagrangian projection on L . One also sees from the calculation that under the Gaussian map the Lagrangian submanifolds $h'_T(L_{-\epsilon})$ and $h'_T(L_\epsilon)$ together form a small (basic) spheroid around the point $o^+ \in \Lambda_2^+$ (i.e. this spheroid is homotopic in $\Lambda_2^+ \setminus \{o^+, o^-\}$ to a boundary of a small ball in Λ_2^+ centered at o^+). Let us denote by $\{h_t\}$ the Hamiltonian isotopy between L and $h'_T(L_\epsilon)$ that we have constructed. This Hamiltonian isotopy realizes (under the Gaussian map) a transversal passage through o^+ in Λ_2^+ . To realize a passage in the opposite direction we need to change simultaneously t to $-t$ in the construction of h'_t and τ to $-\tau$ in the construction of $\{f_\tau\}$.

One easily sees that by taking sufficiently C^0 -small deformation $\{f_\tau\}$ and sufficiently C^1 -small Hamiltonian function $H(R)$ we can make the Hamiltonian isotopy $\{h_t\}$ arbitrarily C^0 -small, supported inside an arbitrarily small neighborhood of x and such that $|\int_{h_t(\gamma)} pdq|$ is uniformly arbitrarily C^0 -small for any t and any path γ in L . This finishes the construction of the special Hamiltonian isotopy $\{h_t\}$. Sublemma 4.5 is proved. ■

End of the proof of Lemma 4.4. By applying a necessary number of times the Hamiltonian isotopy constructed in Sublemma 4.5 we can change \mathcal{F} , and accordingly the spheroid $S(\Delta)$, so that this spheroid becomes contractible in $\Lambda^+ \setminus \{o^-, o^+\}$. It means that we can construct a Hamiltonian isotopy $\{h_t(\Delta)\}$ such that the oriented Lagrangian distribution $(h_1^{-1})_*(\mathcal{F})$ is homotopic to \mathcal{N} in the class of Σ^2 -nonsingular Lagrangian distributions along Δ . Lemma 4.4 is proved. ■

End of the proof the theorem. The obstruction to the homotopy between \mathcal{F} and \mathcal{N} in the class of Σ^2 -nonsingular Lagrangian distributions along the 1-skeleton of L lies in $H^1(L, \partial L; \pi_1(\Lambda_2^+ \setminus \{2 \text{ points}\})) \cong H^1(L, \partial L; \mathbf{Z})$. As in Proposition 4.1 one can see that this obstruction is equal to zero because $c(\mathcal{F}) = c(\mathcal{N})$ by the hypothesis of the theorem and Proposition 4.1. Hence we can deform \mathcal{F} into \mathcal{N} in the class of Σ^2 -nonsingular oriented Lagrangian distributions near the 1-skeleton of L .

By the hypothesis of the theorem and by Proposition 4.1 we have that $e(\mathcal{F}) = e(\mathcal{N})$. Therefore using the standard obstruction theory methods we can choose the previous homotopy over the 1-skeleton so that for each closed 2-simplex Δ of the triangulation the distributions \mathcal{F} and \mathcal{N} coincide near $\partial\Delta$ and are homotopic as oriented Lagrangian distributions along Δ .

Then we apply Lemma 4.4 to each 2-simplex Δ and get a new oriented Lagrangian distribution $(h_1^{-1})_*(\mathcal{F})$ along L which coincides with \mathcal{N} near ∂L and which is homotopic to \mathcal{N} in the class of Σ^2 -nonsingular Lagrangian distributions along the whole L . Therefore Theorem B can be applied and this finishes the proof of Theorem A. ■

5 Singularities and generating functions

Let us now consider the case of an immersed Lagrangian submanifold $L \subset T^*M$, which is generated by a function f defined on an open subset U of

$M \times K^N$, where K^N is a (connected) manifold of dimension N .

Definition 5.1 In a situation as above let us define $V_L \subset U \subset M \times K^N$ as $V_L = \{(q, \xi) \mid \partial f / \partial \xi(q, \xi) = 0\}$ (by (q, ξ) we denote local coordinates on $M \times K^N$).

There exists a natural diffeomorphism F between V_L and L . The diffeomorphism F maps the singularities of the natural projections $P : V_L \rightarrow M$ and $\pi : L \rightarrow M$ onto each other. On the other hand, as it follows from Section 2, we can use Definition 2.6 and construct a chain \mathcal{V} on L . Under the diffeomorphism F the chain \mathcal{V} is mapped into a chain \mathcal{V}_1 on V_L .

Definition 5.2 The chain \mathcal{V}_1 on V_L defined as above is called the *chain induced by L* .

Let us now consider Case II mentioned in Section 2, i.e. the case when $\dim K = 1$ and L is generated by a function defined on (an open subset of) $M \times K^1$. In this case in addition to the chain \mathcal{V}_1 induced on V by L we can define a similar object called α -chain which, unlike \mathcal{V}_1 , uses some information about the function f .

Definition 5.3 [13] Let $V^n \subset M^n \times K^1$ be a submanifold. An α -chain on V is a weak chain $\mathcal{V}' = \{V_i, v'_j\}, i \geq -1, j \geq 2$, on V equipped with a unit vector field v'_1 defined over $V_1 \setminus V_2$. This vector field v'_1 has to satisfy the following properties:

- (i) v'_1 is normal to $V_0 = V$ in $V_{-1} = M \times K^1$;
- (ii) v'_1 cannot be extended (as a vector field normal to V_0 in V_{-1}) to any subset $C \subset V_1$ that has a nontrivial intersection with V_2 .

Remark 5.4 In [13] α -chains are called simply *chains*.

Definition 5.5 Two α -chains on two submanifolds $V_1, V_2 \subset M \times K^1$ are called *equivalent*, if there exists an isotopy between V_1 and V_2 in $M \times K^1$ which maps one α -chain into another.

Notational convention.

By an (oriented) *line field along a submanifold* $V \subset M \times K^1$ we mean a field of (oriented) lines in $T_*(M \times K^1)$ defined along V .

Definition 5.6 [13] Let $V \subset M \times K^1$ be a submanifold, and let \mathcal{L} be an (oriented) line field along V . We define an α -chain on V associated with \mathcal{L} in the following way. First, we define a *weak chain on V associated with \mathcal{L}* in the same way as we did in Definition 2.6. Then we define the vector field v'_1 in the same way as we defined the vector fields v_j , $j \geq 2$, in Definition 2.6. Namely, at each point $x \in V_1 \setminus V_2$ the vector $v'_1(x)$ is a unit normal vector to V in $M \times K^1$ such that its projection $P_*(v'_1(x))$ on M is an exterior normal to the boundary of $P(V) \subset M$ at $P(x)$, where $P : M \times K^1 \rightarrow M$ is the canonical projection.

One can check that since $\dim K = 1$ this construction indeed defines an α -chain and this α -chain is unique up to the equivalence of α -chains.

Let $Vert$ be a line field along V_L which to each point $x \in V_L$ associates the tangent space to the fiber of the projection $M \times K^1 \rightarrow M$ at x .

Definition 5.7 If L is generated by a function f , then the α -chain on V_L generated by f is an α -chain on V_L associated with the line field $Vert$.

Remark 5.8 Observe that the line field $Vert$ is tangent to V_i along V_{i+1} and transversal to V_i along $V_i \setminus V_{i+1}$, $i = 1, \dots, n$. At any point $x \in V_1 \setminus V_2$ the vector $v_1(x)$ from the chain on V induced by L determines an orientation of $Vert$ at x . It means that the first two derivatives of f along $Vert$ (in the direction given by the orientation) vanish at x and the third one is always positive. Similarly, if $x \in V_i \setminus V_{i+1}$, $i > 1$, then the first $i + 1$ derivatives of f along the oriented line field $Vert$ vanish at x and the $(i + 2)$ -nd one is nonzero.

We can also describe the α -chain on V_L generated by f in the following way. A choice of orientation of K^1 makes $Vert$ globally oriented. This allows us to define correctly the sign of the $(i + 2)$ -nd derivative of f along the positive direction of $Vert$ at each point $x \in V_i \setminus V_{i+1}$, $i \geq 1$. We call this sign $sign_1(x)$.

On the other hand, if we fix an orientation of K^1 then the signs of the partial derivatives of f with respect to ξ simultaneously coorient V_i in V_{i-1} , $i \geq 0$. Therefore to each point $x \in V_i \setminus V_{i+1}$, $i = 1, \dots, n$, we can associate another sign called $sign_2(x)$ which is taken to be plus, if the vector $v'_i(x)$ from the α -chain generated by f agrees with the previous coorientation of V_{i-1} in V_{i-2} , and minus otherwise. By a suitable choice of orientation of K^1 we can get that $sign_1(m) = sign_2(m)$ for any $x \in V_1$.

Thus instead of vector fields v'_i in the α -chain generated by f we can work with the signs of the derivatives $\partial^i f / \partial \xi^i$.

Example 5.9 (“Lagrangian collapse”) Consider a Lagrangian submanifold $L_\varepsilon \subset T^*(\mathbf{R}^2)$ generated by a function

$$f_\varepsilon(q_1, q_2, \xi) = q_1 \cos \xi + q_2 \sin \xi - \chi_\varepsilon(r) \cos 2\xi,$$

where $r = q_1^2 + q_2^2$ and $\chi_\varepsilon(r)$ is a function such that:

- (i) $0 \leq \chi_\varepsilon(r) \leq \varepsilon/2$ for any r ;
- (ii) $\chi_\varepsilon(r) = \varepsilon/2$, if $0 \leq r \leq 100$;
- (iii) $\chi_\varepsilon(r) = 0$, if $r \geq 1000$.

For a sufficiently small ε we get that L_ε is an embedded Lagrangian submanifold and $\partial^2 f / \partial \xi^2(q, \xi) \neq 0$, if $q_1^2 + q_2^2 > 100$.

The chain on the corresponding cylinder V_{L_ε} induced by L_ε is shown on Fig. 3. It consists of a circle of folds (V_1) with four cusps on it (V_2). The directions of the vector field v_1 on V_1 are shown by the small arrows, and the directions of v_2 on V_2 are shown by the big arrows.

The α -chain on V_{L_ε} generated by f_ε is shown on Fig. 7. The signs attached to each connected component of $V_1 \setminus V_2$ on the pictures are the signs of $\partial^3 f_\varepsilon / \partial \xi^3$ on those components (see Remark 5.8).

To define a direct surgery for α -chains we need to adjust the Definitions 2.9 and 2.10.

Definition 5.10 (Adjusted Definition 2.9 for α -chains) A *basis of a direct surgery* of order $s \geq 1$ and index $p \geq 0$ is formed by an α -chain \mathcal{V}' on V_L and an embedding $\phi : D^p \times [-1, 1] \rightarrow V_{s-1}$. This data must satisfy the same conditions as in Definition 2.9 except for the following:

- (i) there is no need for the vectors ν_3, ν_4 , when $p = 0, s = 1$;
- (ii) the condition e) is not needed;
- (iii) in the condition d) one should write $s \geq 1$ instead of $s > 1$.

Definition 5.11 (Adjusted Definition 2.10 for α -chains) Suppose that an α -chain \mathcal{V} on V_L and an embedding $\phi : D^p \times [-1, 1] \rightarrow V_{s-1}$ (possibly with a pair of vectors ν_1, ν_2) form a basis of a direct surgery of order s and index p . The result of the direct surgery associated with the basis is a new chain \mathcal{V}' on V_L defined in the same way as in Definition 2.10 but we should not single out the case $p = 0, s = 1$ (i.e. the same construction applies to any p and s).

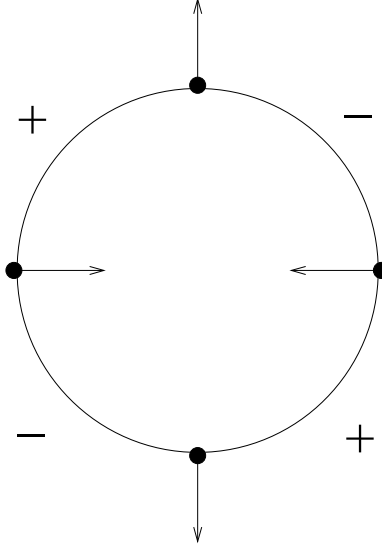

Figure 7: The α -chain corresponding to the Lagrangian collapse.

Remark 5.12 Suppose that L is generated by a function f . A basis of a direct surgery for the chain on L induces a corresponding basis of a direct surgery for the chain on V_L induced by L .

One can check that any basis of a direct surgery for the α -chain on V_L , generated by f , induces a basis of a direct surgery for the chain on V_L induced by L , *but not necessarily vice versa!*

Indeed, if we want to realize a direct surgery of order s along a disk D^p for the α -chain generated by f , we have to have that the signs of $\partial^{s+2}f/\partial\xi^{s+2}$ extend from the boundaries of each of the disks $D^p \times \{\pm 1\}$ to the disk itself. This might not hold for a basis of a direct surgery for the chain on V_L induced by L , if $p = 1$.

As before we can introduce the notion of an *inverse surgery* for α -chains as an operation inverse to a direct surgery. For an accurate definition of an inverse surgery as a formal operation on α -chains see [13]. The analogs of Propositions 2.11 and 2.13 for α -chains look as follows.

Proposition 5.13 [13] *Suppose that we have a generic 1-parameter family $\{\mathcal{L}^t\}$ of line fields along V . Then the α -chain on V associated with \mathcal{N}^1*

can be obtained from the α -chain associated with \mathcal{N}^0 by a sequence of direct and inverse surgeries.

Proposition 5.14 [13] *Consider an inverse surgery on an α -chain $\mathcal{V} = \{V_i, v_i\}$ which transforms \mathcal{V} into another α -chain $\mathcal{V}' = \{V'_i, v'_i\}$. Suppose that the inverse surgery is an inverse of a direct surgery of order s along a disk D^p (i.e. the direct surgery transforms \mathcal{V}' into \mathcal{V}). Suppose also that there exists an embedding $\alpha : D^1 \rightarrow V'_0$ which satisfies the following properties:*

- (i) $\alpha(D^1) \cap V'_1 = \alpha(\partial D^1)$ and $\alpha(D^1)$ is normal to V'_1 at $\alpha(\partial D^1)$;
- (ii) the vector field v_1 cannot be extended along $\alpha(D^1)$ as a normal vector field to V'_0 in V'_{-1} .

Then the inverse surgery can be represented as a composition of direct surgeries.

Definition 5.15 [13]. We call an inverse surgery satisfying the hypothesis of Proposition 5.14 *complete*.

6 Proofs of Propositions 3.1, 1.13. Lagrangian Collapse

Notational convention.

From now on by $B_r^l(x)$ we denote an l -dimensional ball of radius r with the center at x . By B_r^l we denote an l -dimensional ball of radius r with the center at $0 \in \mathbf{R}^l$. We omit the lower index for unit balls. By $S(x, r)$ we denote a sphere of radius r with the center at x .

Proof of Proposition 3.1. Let us first sketch the general idea of the proof. In a neighborhood of D^p in T^*L we introduce new symplectic coordinates so that the singularities of tangency of L to \mathcal{F} near the disk D^p become the singularities of Lagrangian projection of a Lagrangian submanifold in a cotangent bundle. This Lagrangian submanifold (in a neighborhood of D^p) is defined by a generating function. Then we reduce Proposition 3.1 to a problem concerning a deformation of this generating function. The latter problem is dealt with in the following proposition.

Proposition 6.1 *Let $L \subset T^*M$ be an embedded Lagrangian submanifold generated by a function f defined on an open subset of $M \times K^N$. Let \mathcal{V} be the chain induced by L on V_L . Let \mathcal{V}_1 be the result of a direct surgery on \mathcal{V} of order s ($s \geq 1$) along a disk $D^p \subset V_{s-1}$ whose projection from $M \times K^N$ to M is an embedded disk in M . Then for any sufficiently small neighborhood U of D^p in $M \times K^N$ there exists a 1-parametric family of functions $\{f_\tau\}$, $f = f_0$, $0 \leq \tau \leq 1$, such that*

- (i) *for any τ , $0 \leq \tau \leq 1$, the function f_τ generates an embedded Lagrangian submanifold $L_\tau \subset T^*M$ which is Hamiltonian isotopic to L ;*
- (ii) *the chain \mathcal{V}_1 is equivalent to the chain on $V_{L_1} \cong V_L$ induced by L_1 .*

The deformation $\{f_\tau\}$ can be made arbitrarily C^1 -small and supported inside U .

If $\dim K = 1$, \mathcal{V}' is the α -chain generated by f and α -chain \mathcal{V}'_1 is the result of a direct surgery on \mathcal{V}' of order s ($s \geq 1$) along a disk $D^p \subset V_{s-1}$, then we can achieve that \mathcal{V}'_1 is equivalent to the α -chain generated by the function f_1 on $V_{L_1} \cong V_L$.

We will prove Proposition 6.1 in Section 7.

End of the proof of Proposition 3.1. Since $p \leq n - 1$, we can assume that D^p is transversal to the foliation \mathcal{F} . Using the Lagrangian neighborhood theorem (see [25],[26]) we can find a symplectomorphism which identifies a small open tubular neighborhood U of D^p in T^*L with a product $U' \times B_\epsilon^n \subset T^*U' \cong \mathbf{R}^{2n}$ for some small ϵ , where $U' \supset D^p$ is a small tubular neighborhood of D^p in the Lagrangian subspace $\mathbf{R}^n \times 0 \subset \mathbf{R}^{2n}$ and the foliation \mathcal{F} restricted on U is formed by the leaves of the Lagrangian projection $\mathbf{R}^{2n} \rightarrow \mathbf{R}^n$ restricted on U . Thus we can present the singularities of tangency of L to \mathcal{F} near D^p as singularities of a Lagrangian projection.

Let L' be the part of L lying inside U (and U itself now is supposed to lie inside \mathbf{R}^{2n}). Since L' is contractible it follows from a theorem of Giroux [16] that L' can be generated by a function f defined on an open subset of $U' \times \mathbf{R}^N$ for some N . Since $D \subset U'$ we can apply Proposition 6.1 to the Lagrangian submanifold $L' \subset T^*U'$ and the generating function f . This finishes the proof of Proposition 3.1. ■

Example 6.2 Consider an embedded Lagrangian submanifold L in $T^*\mathbf{R}^2$ generated by the function $f(q_1, q_2, \xi) = q_1 \cos \xi + q_2 \sin \xi$ defined on $\mathbf{R}^2 \times S^1$

(as in Examples 1.12,5.9). Consider first a deformation of L given by the following deformation of f :

$$f_\varepsilon(q_1, q_2, \xi) = q_1 \cos \xi + q_2 \sin \xi - \chi_\varepsilon(r) \cos 2\xi$$

(as in Example 5.9). For ε close enough to 0 the function f_ε generates an embedded Lagrangian submanifold L_ε of $T^*\mathbf{R}^2$ which is Hamiltonian isotopic to L (as in Example 5.9). By choosing a sufficiently small ε the Hamiltonian isotopy can be made compactly supported and arbitrarily C^0 -small.

We take such an ε , consider the chain on V_{L_ε} induced by L_ε (see Example 2.12 and Fig. 3) and apply to it two subsequent direct surgeries as shown on Fig. 8. Punctured lines indicate the 1-dimensional disks along which we perform direct surgeries of index 1.

After applying the two surgeries we get a chain which is formed by one circle of folds with no cusps on it, i.e. after the surgery the submanifold V_1 is a circle and V_2 is empty. According to Proposition 3.1, such a chain corresponds to an *embedded* Lagrangian submanifold L_1 of $T^*\mathbf{R}^2$ which is Hamiltonian isotopic to L and which projects on \mathbf{R}^2 with only fold-type singularities.

However, the two surgeries we made (and hence the whole isotopy) cannot be realized by a deformation of the generating function f . To construct a Hamiltonian isotopy covered by a deformation of f we have to make direct surgeries for the α -chain generated by f_ε (see Example 5.9 and Fig. 7). These surgeries are shown on the Fig. 9. According to Proposition 6.1, we can realize these surgeries by arbitrarily C^0 -small Hamiltonian isotopies of L covered by arbitrarily C^1 -small deformations of the generating function.

Proof of Proposition 1.13. First, we need an analogue of Proposition 3.2 for α -chains. Similarly to what we did before, we call a pair of $(n-1)$ -dimensional embedded spheres $S_1, S_2 \subset V_L$ a *double fold pair of spheres*, if S_2^{n-1} bounds a ball in L and the sphere S_1^{n-1} lies inside that ball.

Consider the α -chain \mathcal{V} on $V_L \subset M \times K^1$ generated by f .

Proposition 6.3 *Let $B \subset L$ be a ball in V_L such that the restriction of the projection $P : V_L \rightarrow M$ on B is nonsingular. Consider a new α -chain \mathcal{V}_1 which is a union of \mathcal{V} and a double fold pair of spheres lying in B . Then there exists a deformation $\{f_t\}$, $0 \leq t \leq 1$, of $f = f_0$ in the class of generating functions defined on (an open subset of) $M \times K^1$, such that*

(i) *the deformation $\{f_t\}$ covers a Hamiltonian isotopy of L ;*

Surgery I.

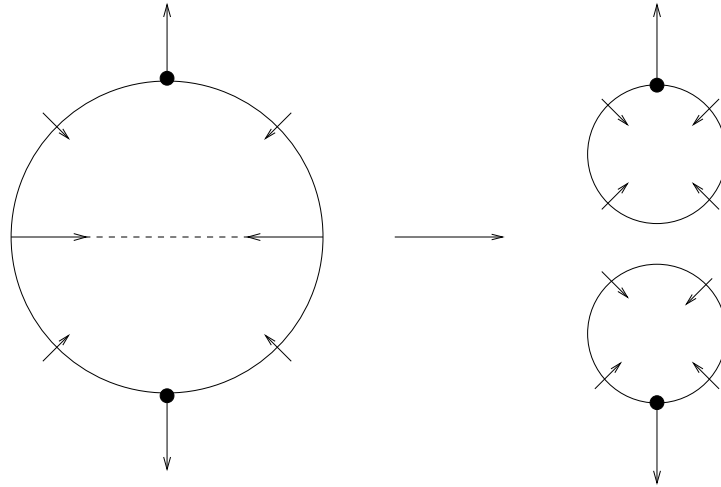

Surgery II.

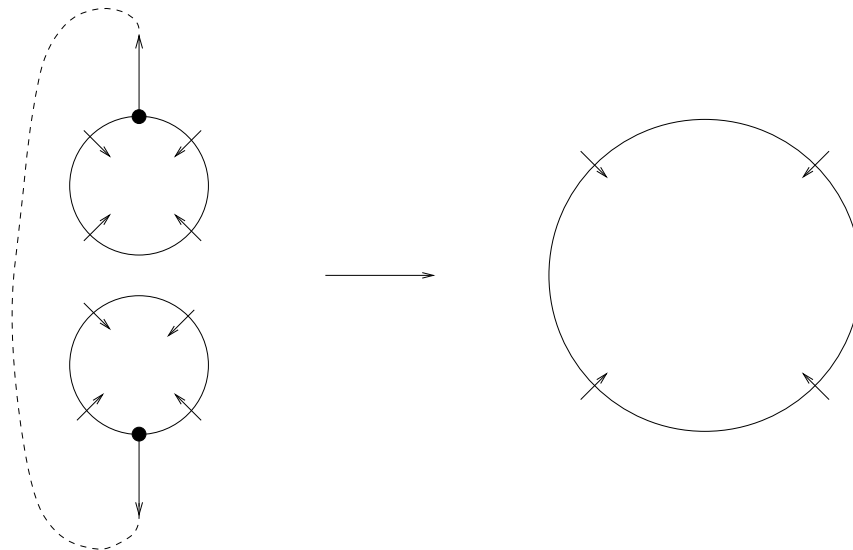

Figure 8: The direct surgeries killing the cusps (but not realizable by a deformation of the *global* generating function) for the Lagrangian collapse.

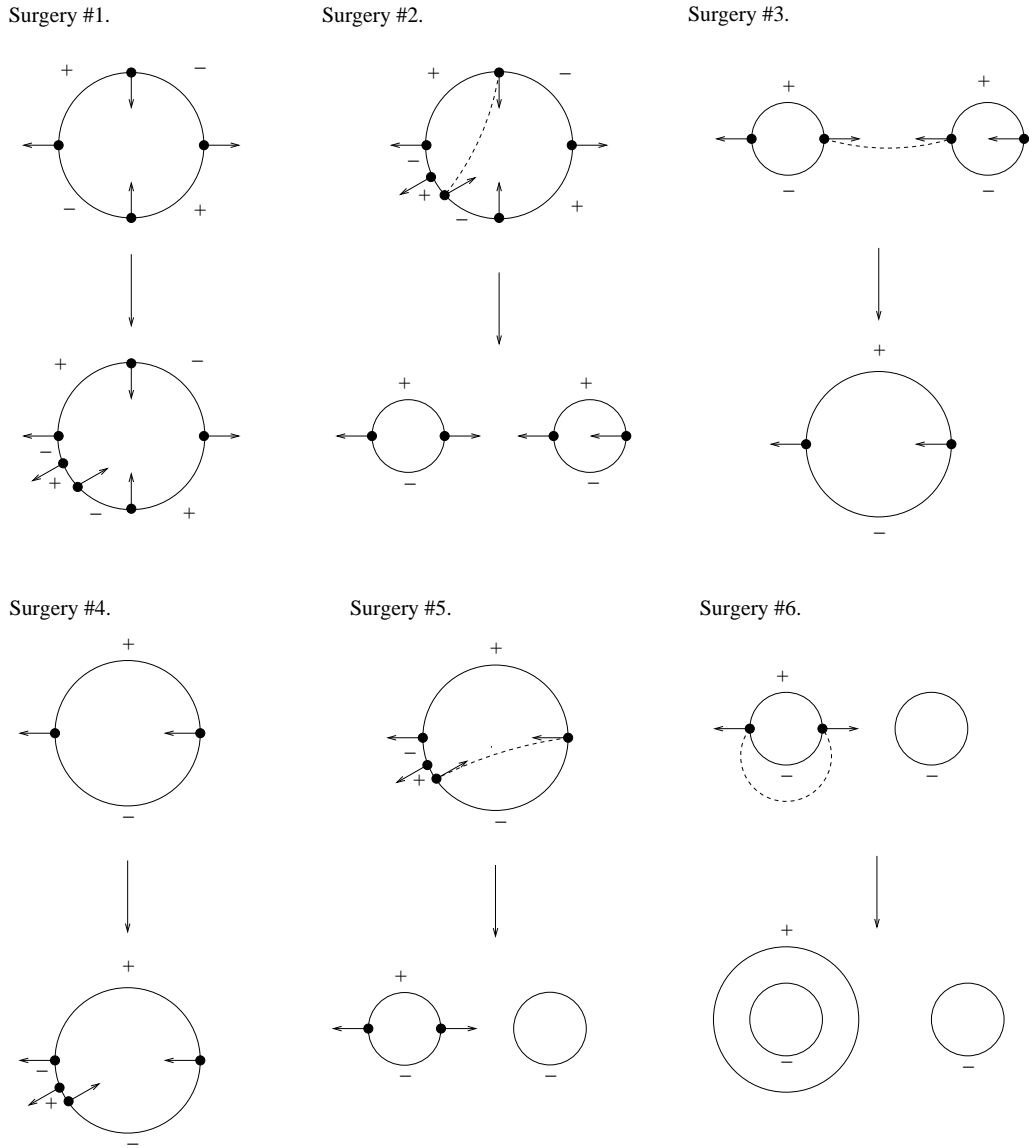

Figure 9: The direct surgeries killing the cusps and realizable by a deformation of the *global* generating function in the case of Lagrangian collapse.

(ii) the α -chain \mathcal{V}_1 is equivalent to the α -chain generated by f_1 .

The deformation $\{f_t\}$ can be made arbitrarily C^1 -small and supported inside B .

Any of the two possible combinations of the orientations of v'_1 on S_1 and S_2 can be realized by some deformation $\{f_t\}$ as above.

We will prove Proposition 6.3 along with Proposition 3.2 in Section 8.

End of the proof of Proposition 1.13. Consider the line field $Vert$ along V_L (see Definition 5.7) and let $Norm$ be the normal (oriented) line field along V_L .

The only obstruction for the line fields $Vert$ and $Norm$ to be homotopic as line fields along V_L lies in the homotopy group $\pi_n(RP^n) \cong \mathbf{Z}$. If L is noncompact or has a boundary, we may assume as before that $Vert$ and $Norm$ coincide near the boundary and outside of some compact subset of V_L and we look for a homotopy identical at those parts of V_L .

Suppose that the obstruction is equal to $k \neq 0$. Then we get rid of the obstruction by creating additional double folds on L and by cutting out small neighborhoods of the balls bounded by the interior spheres in each double fold pair of spheres. On the resulting manifold the obstruction vanishes.

Formally speaking, we do the following. We take k points $x_1, \dots, x_k \in V_L$ which are nonsingular for the projection $P : V_L \rightarrow M$. Using Proposition 6.3 we find a C^1 -small deformation $\{f_\tau\}$ of f which creates additional double folds along each pair of arbitrarily small concentric spheres $S(x_i, \epsilon)$, $S(x_i, 2\epsilon)$, $i = 1, \dots, k$. We still denote our manifold by V_L and our generating function by f .

According to Proposition 6.3, we can arrange the orientations of v'_1 on $S(x_i, \epsilon)$, $S(x_i, 2\epsilon)$, $i = 1, \dots, k$, in such a way that if we delete all the balls $B_{3/2\epsilon}^n(x_i)$, $i = 1, \dots, k$, from V_L , then on the new manifold V'_L the obstruction vanishes. Hence $Vert$ is homotopic to $Norm$ as a line field along the new manifold V'_L . Let us denote by $\{\mathcal{L}^t\}$ the homotopy between $Vert$ and $Norm$ that we have obtained. We apply Proposition 5.13 to the homotopy $\{\mathcal{L}^t\}$ and get a sequence of direct and inverse surgeries, corresponding to $\{\mathcal{L}^t\}$. After that we realize these surgeries by Hamiltonian isotopies as follows.

If we need to realize a *direct surgery* we proceed according to Proposition 6.1.

If at a given step we need to realize a *complete inverse surgery* we use Proposition 5.14 and decompose it into a product of direct surgeries. Thus the problem is reduced to the previous case.

If at a given step we have an inverse surgery which is *not complete*, we make it complete using the same trick we used in the proof of Theorem B. Namely, we use Proposition 6.3 and create an appropriate double fold in a neighborhood of an appropriate point by a C^1 -small deformation of the generating function. Then we form a new α -chain by adding the exterior sphere from the double fold pair of spheres to the chain which is the result of the inverse surgery. We can assume that this new chain is the result of the inverse surgery. It makes the inverse surgery complete and we reduce the problem to the previous case.

Thus we have constructed a sequence of arbitrarily C^0 -small Hamiltonian isotopies. The composition of all these isotopies gives us the required Hamiltonian isotopy of the original Lagrangian submanifold L . At each step the deformations of the Lagrangian submanifold were covered by a deformation of generating functions defined on (an open subset of) $M \times K^1$. Therefore the final Hamiltonian isotopy of L also satisfies this property. ■

By exactly the same argument we can prove the following strengthened version of Proposition 1.13.

Suppose again that an embedded Lagrangian submanifold $L \subset T^*M$ is generated by a function f defined on an open subset of $M \times K^1$, where K is a (connected) 1-dimensional manifold. Let \mathcal{N} be a generic oriented line field along V_L homotopic to $Vert$ as an oriented line field along V_L . Let \mathcal{V} be the α -chain on V_L associated with \mathcal{N} .

Proposition 6.4 *One can deform L by a Hamiltonian isotopy into a new Lagrangian submanifold L_1 such that the weak chain on V_{L_1} induced by L_1 is equivalent to the union of the α -chain \mathcal{V} and a number of additional double fold pairs of spheres in L . This Hamiltonian isotopy can be covered by a deformation $\{f_t\}$ of the generating function f in the class of generating functions defined on (an open subset of) $M \times K^1$.*

The deformation $\{f_t\}$ can be made compactly supported and arbitrarily C^1 -small.

The analogs of Proposition 6.4 can be proved in the case when $L \subset T^*M$ is an immersed Lagrangian submanifold and in the Legendrian case.

7 Proof of Proposition 6.1

We present a proof of Proposition 6.1 for the case $p \geq 1$. The case $p = 0$ can be done by similar methods.

A general outline of what we are going to do in this section is the following. We start with a neighborhood U of the disk D^p in $M \times K^N$, then we write the function f in a normal form on a smaller neighborhood $U' \subset U$ and then we construct a deformation $\{f_\tau\}$ of f which does not change f outside of U' .

Notational convention.

From now on let $t = (t_1, \dots, t_s)$, $y = (y_1, \dots, y_p)$, $z = (z_1, \dots, z_{n-s-p})$, $\xi = (\xi_1, \dots, \xi_N)$, $\bar{\xi} = (\xi_2, \dots, \xi_N)$. As before by B_r^l we denote an l -dimensional ball of radius r with the center at $0 \in \mathbf{R}^l$ and we omit the lower index for unit balls.

7.1 Auxiliary constructions

Lemma 7.1 *For an arbitrarily small neighborhood U of the disk D^p in $M \times K^N$ there exists a diffeomorphism $j : \mathbf{R}^{n+N} \rightarrow U$ such that the following conditions are fulfilled:*

(A) *on a neighborhood $U' \subset U$ of $j^{-1}(D^p) \subset \mathbf{R}^{n+N} = \mathbf{R}^p \times \mathbf{R}^{n-s-p} \times \mathbf{R}^s \times \mathbf{R} \times \mathbf{R}^{N-1}$ one has*

$$f \circ j(y, z, t, \xi_1, \bar{\xi}) = \lambda_{s+3}(y, z) \{ \xi_1^{s+3} + \theta(y, z) \xi_1^{s+1} + \sum_{i=1}^s t_i \xi_1^i \} + \lambda_0(y, z, t) - \sum_{i=2}^{2+k} \xi_i^2 + \sum_{i=3+k}^N \xi_i^2$$

for an integer number k , $0 \leq k \leq N - 1$, and some functions $\lambda_0(y, z, t)$, $\lambda_{s+3}(y, z)$, $\lambda_{s+3}(y, z) > 0$ on U' , $\theta(y, z) = \theta'(y, z) / \lambda_{s+3}(y, z)$, where a function $\theta'(y, z)$ satisfies the following conditions:

(A1) θ' is positive on $(\mathbf{R}^p \setminus B^p) \times B^{n-s-p}$, negative on $B^p \times (\mathbf{R}^{n-s-p} \setminus B^{n-s-p})$,

(A2) θ' has a nondegenerate critical point of index p at zero and it is the only critical point of θ' ;

(B1) j maps the fibers of the projection $\mathbf{R}^{n+N} \rightarrow \mathbf{R}^n$ into the fibers of the projection $M \times K^N \rightarrow M$;

(B2) j maps the line field parallel to the axis ξ_1 on \mathbf{R}^{n+N} into the line field $l = \ker dP$, where P is the restriction of the projection $M \times K^N \rightarrow M$ on V_L ;

$$(B3) \quad j^{-1}(D^p) \subset \mathbf{R}^p \times 0 \times 0 \times 0 \times 0;$$

$$(B4) \quad j^{-1}(V) \subset \mathbf{R}^p \times \mathbf{R}^{n-s-p} \times \mathbf{R}^s \times \mathbf{R} \times 0;$$

$$(B5) \quad j^{-1}(D^p \cup V_{s+1}), j^{-1}(D^p \times [-1, 1]) \subset \mathbf{R}^p \times \mathbf{R}^{n-s-p} \times 0 \times 0 \times 0 \subset j^{-1}(V_{s-1});$$

$$(B6) \quad j^{-1}(V_{s+1}) \subset \{(y, z, 0, 0, 0) \mid (y, z, 0, 0, 0) \in \mathbf{R}^p \times \mathbf{R}^{n-s-p} \times 0 \times 0 \times 0 \subset \mathbf{R}^{n+N}, \theta'(y, z) = 0\};$$

$$(B7) \quad j^{-1}(V_s) \cap (\mathbf{R}^p \times \mathbf{R}^{n-s-p} \times 0 \times 0 \times 0) = V_{s+1};$$

$$(B8) \quad j^{-1}(V_{s-1}) \subset \mathbf{R}^p \times \mathbf{R}^{n-s-p} \times 0 \times \mathbf{R} \times \mathbf{R}^{N-1}.$$

We prove Lemma 7.1 in Section 7.3.

Remark 7.2 Essentially Lemma 7.1 is about a *parametric Morin normal form* ([21], see also [4]) for singularities of the type $\Sigma^{11\dots 1}$. Similar result was implicitly used in the proof of Proposition 3.8 in [13]. Another result of this kind can be found in [18].

Now we can write explicitly the function f in a small neighborhood U' of D^p and our next step is to find a necessary C^1 -small deformation of f which changes f *only inside* U' . For this purpose we need the following construction which takes the rest of this section.

Let us use Lemma 7.1 and let us identify U with \mathbf{R}^{n+N} (so from now on we omit j everywhere). We can assume that $U' = B^p \times B^{n-s-p} \times B_{\varepsilon_1}^s \times B_{\varepsilon_2}^1 \times B^{N-1}$ (for some $\varepsilon_1, \varepsilon_2$). We can also assume that the function $\theta \leq C$ on U' for some positive constant C .

For any ϵ , $0 < \epsilon < \varepsilon_2$, there exist a number $\delta(\epsilon) > 0$ and an open ball $B_{r(\epsilon)}^s$, $r(\epsilon) < \varepsilon_1$, such that for any a , $-\delta \leq a \leq C$, and any $t \in B_{r(\epsilon)}^s$ all critical points of the function

$$x \rightarrow t_1 x^1 + \dots + t_s x^s + a x^{s+1} + x^{s+3}$$

are contained in $B_{\epsilon/2}^1$. Let $B_R^{n-s} \subset B^p \times B^{n-s-p}$ be a ball containing $D^p \subset \mathbf{R}^p \times \mathbf{R}^{n-s-p} \times 0 \times 0 \times 0$ such that on B_R^{n-s} one has $\theta(y, z) \geq -\delta(\epsilon)$. Then for any $(y, z, t) \in B_R^{n-s} \times B_{r(\epsilon)}^s$ all the critical points of the function

$$\xi_1 \rightarrow \xi_1^{s+3} + \theta(y, z) \xi_1^{s+1} + \sum_{i=1}^s t_i \xi_1^i$$

lie inside $B_{\epsilon/2}^1$. Let us choose an open ball $B_{R_1}^{n-s}$, $D^p \subset B_{R_1}^{n-s} \subset B_R^{n-s}$, and let us define a family of functions $\{\theta_\tau\} : \mathbf{R}^p \times \mathbf{R}^{n-s-p} \rightarrow \mathbf{R}$, $0 \leq \tau \leq 1$, with the following properties:

- (I) $\theta_0 = \theta$;
- (II) for any τ , $0 \leq \tau \leq 1$, $\theta_\tau = \theta$ outside $B_{R_1}^{n-s}$;
- (III) for any τ , $0 \leq \tau \leq 1$, $\theta_\tau(y, z) \geq -\delta(\epsilon)$ on B_R^{n-s} ;
- (IV) the function θ_1 is negative on B_R^{n-s} .

Hence for any τ and any $(y, z, t) \in B_R^{n-s} \times B_{r(\epsilon)}^s$ all the critical points of the function

$$\xi_1 \rightarrow \xi_1^{s+3} + \theta_\tau(y, z)\xi_1^{s+1} + \sum_{i=1}^s t_i \xi_1^i$$

lie inside $B_{\epsilon/2}^1$. Then we can easily find a family of functions $\{g_\tau\} : U' \rightarrow \mathbf{R}$, $0 \leq \tau \leq 1$, such that $g_0 = f$ on U' and for any τ

- (i) $g_\tau = f$ outside $B_{R_1}^{n-s} \times B_{r(\epsilon)}^s \times B_\epsilon^1$;
- (ii) $g_\tau(y, z, t, \xi_1, \bar{\xi}) = \lambda_{s+3}(y, z)(\xi_1^{s+3} + \theta_\tau(y, z)\xi_1^{s+1} + \sum_{i=1}^s t_i \xi_1^i) + \lambda_0(y, z, t) - \sum_{i=2}^{2+k} \xi_i^2 + \sum_{i=3+k}^N \xi_i^2$ on $B_R^{n-s} \times B_{r(\epsilon)/2}^s \times B_{\epsilon/2}^1$;
- (iii) $\partial g_\tau / \partial \xi_1 \neq 0$ outside $B_R^{n-s} \times B_{r(\epsilon)/2}^s \times B_{\epsilon/2}^1$.

7.2 End of the proof of Proposition 6.1

Let us define f_τ as f outside U and as g_τ inside U . Taking a sufficiently small ϵ we can make the deformation $\{f_\tau\}$ arbitrarily C^1 -small on U .

Let us check the condition (iii) from Proposition 6.1. It follows from Lemma 7.1 and from the construction of $\{g_\tau\}$ that we only need to check that the α -chain generated by the function $\Psi_1 : \mathbf{R}^n \times \mathbf{R} \rightarrow \mathbf{R}$ is obtained from the α -chain generated by the function $\Psi_0 : \mathbf{R}^n \times \mathbf{R} \rightarrow \mathbf{R}$ by a direct surgery along the disk D^p , where

$$\Psi_\tau(y, z, t, \xi_1) = \sum_{i=1}^{s-1} t_i \xi_1^i + \theta_\tau(y, z)\xi_1^{s+1} + \xi_1^{s+3} \quad (0 \leq \tau \leq 1).$$

In that case we indeed have the required surgery and therefore the condition (iii) holds.

Now let us check the condition (ii). Lemma 7.1 and the construction of $\{g_\tau\}$ imply that we only need to check that the function $\Psi_\tau : \mathbf{R}^n \times \mathbf{R} \rightarrow \mathbf{R}$

generates an embedded Lagrangian submanifold in $T^*\mathbf{R}^n$. For any fixed (y, z, t) and any $x_j \in \mathbf{R}$ ($j = 1, 2$) such that $\partial\Psi_\tau/\partial x(y, z, t, x_j) = 0$ we have that

$$\frac{\partial\Psi_\tau}{\partial t_1}(y, z, t, x_j) = x_j \quad (j = 1, 2).$$

Then necessarily $x_1 = x_2$. Hence the Lagrangian submanifold $L'_\tau \subset T^*L$ generated by $f_\tau|_U$ is embedded. Therefore, since we change f by an arbitrarily C^1 -small deformation in an arbitrarily small neighborhood of D^p , we get that the whole Lagrangian submanifold L_τ generated by f_τ is embedded. Thus L_τ is Lagrangian isotopic to L in the class of embedded Lagrangian submanifolds. Since this isotopy changes L only in a small neighborhood of the disk D^p , it does not change the periods of the canonical 1-form pdq on L . Hence L_τ is Hamiltonian isotopic to L .

Let us denote the Hamiltonian flow which deforms L into L_1 by $\{h_\tau\}$. Let us fix a point $x_0 \in L$ and let us consider the family of the action functions $\{A_\tau\}$, defined by the formula $A_\tau(x) = \int_{\gamma_\tau} pdq : L_\tau \rightarrow \mathbf{R}$, where γ_τ is a path in L_τ connecting $h_\tau(x_0)$ with x . The function A_τ is correctly defined because the Lagrangian submanifold L_τ is exact. Up to a global constant (independent of τ), A_τ is equal to f_τ for any τ . Hence $|\int_{h_\tau(\gamma)} pdq|$ can be made uniformly bounded by an arbitrarily small number independent of τ and a path γ in L . This finishes the proof of Proposition 6.1. ■

7.3 Proof of Lemma 7.1

Let us pick an arbitrary function $\theta'(y, z)$ that satisfies conditions (A1),(A2) of Lemma 7.1. Since D^p is a part of a basis of the direct surgery and since it projects into an embedded disk in M , one finds that for an arbitrarily small neighborhood U (diffeomorphic to \mathbf{R}^{n+N}) of D^p in $M \times K^N$ there exists a diffeomorphism $j : \mathbf{R}^{n+N} \rightarrow U$ which satisfies conditions (B1)–(B8) of Lemma 7.1. We call such a pair (U, j) a *good chart*.

We call a (local) change of coordinates in a neighborhood of $j^{-1}(D^p) \subset \mathbf{R}^{n+N} = \mathbf{R}^p \times \mathbf{R}^{n-s-p} \times \mathbf{R}^s \times \mathbf{R} \times \mathbf{R}^{N-1}$ *good*, if it has the form

$$(y, z, t, \xi_1, \bar{\xi}) \rightarrow (y, z, t, S_1(y, z, t, \xi_1, \bar{\xi}), S_2(y, z, t, \xi_1, \bar{\xi})),$$

$S_1 : \mathbf{R}^{n+N} \rightarrow \mathbf{R}$, $S_1(y, z, t, 0, \bar{\xi}) = 0$, $S_2 : \mathbf{R}^{n+N} \rightarrow \mathbf{R}^{N-1}$, $S_2(y, z, t, \xi_1, 0) = 0 \in \mathbf{R}^{N-1}$. Obviously, a good change of coordinates maps a good chart into another good chart.

We break the proof of Lemma 7.1 into several steps (Lemmas 7.3–7.7). Lemma 7.1 follows immediately from Lemma 7.7.

Lemma 7.3 *There exists a good chart (U, j) such that the function $f \circ j : \mathbf{R}^{n+N} \rightarrow \mathbf{R}$ has the form*

$$f \circ j(y, z, t, \xi) = \varphi(y, z, t, \xi_1) - \sum_{i=2}^{2+k} \xi_i^2 + \sum_{i=3+k}^N \xi_i^2$$

in a neighborhood of $j^{-1}(D^p)$ for some function φ and some integer k , $0 \leq k \leq N - 1$.

Lemma 7.4 *The function φ in Lemma 7.3 can be reduced to the form*

$$\varphi(y, z, t, \xi_1) = \sum_{i=0}^{s+3} \lambda_i(y, z, t) \xi_1^i, \quad (*)$$

where $\lambda_{s+3}(y, z, t) \neq 0$ for any (y, z, t) , and if $(y, 0, 0, 0, 0) \in j^{-1}(\partial D^p)$ then $\lambda_i(y, 0, 0) = 0$, $i = 1, \dots, s+2$.

Lemma 7.5 *One can assume that in Lemma 7.4*

$$\lambda_{s+3}(y, z, t) \equiv \pm 1, \quad \lambda_{s+2}(y, z, t) \equiv 0, \quad \lambda_i(y, z, 0) = 0, \quad i = 1, \dots, s,$$

and

$$\lambda_{s+1}(y, z, 0) = 0 \text{ iff } (y, z, 0, 0, 0) \in j^{-1}(\partial D^p).$$

Lemma 7.6 *One can assume that in Lemma 7.3*

$$\varphi(y, z, t, \xi_1) = \pm \xi_1^{s+3} + \lambda_{s+1}(y, z) \xi_1^{s+1} + t_s \xi_1^s + \dots + t_1 \xi_1 + \lambda_0(y, z, t),$$

where $\lambda_{s+1}(y, z) = 0$ iff $(y, z, 0, 0, 0) \in j^{-1}(\partial D^p)$.

Lemma 7.7 *There exists a good chart (U, j) such that*

$$f(y, z, t, \xi_1, \bar{\xi}) = \pm \lambda_{s+3} \xi_1^{s+3} + \theta'(y, z) \xi_1^{s+1} + t_s \xi_1^s + \dots + t_1 \xi_1 + \lambda_0(y, z, t) - \sum_{i=2}^{2+k} \xi_i^2 + \sum_{i=3+k}^N \xi_i^2$$

in a neighborhood of D^p .

In the proofs of the lemmas we use parametric versions of “the Morse lemma with parameters” ([2], see also [4]) and of the Tougeron theorem ([22], see also [4]). The parametric versions that we need for our case (when the corank of the function is equal to 1 for any value of the parameter) can be easily proved along the lines of the proofs of the standard “nonparametric” versions (see [4]). For example, the exact statement of the version of the Tougeron theorem that we need is as follows.

Parametric Tougeron theorem. *Suppose we have two families $\{f_a\} : (\mathbf{R}, 0) \rightarrow (\mathbf{R}, 0)$, $\{g_a\} : (\mathbf{R}, 0) \rightarrow (\mathbf{R}, 0)$, of germs of smooth functions, where the parameter a runs over a compact manifold. Suppose that for any a the singularities of f_a and g_a at zero have the same Milnor number μ_a and the same $(\mu_a + 1)$ -jet. Then there exists a smooth family $\{S_a\} : (\mathbf{R}, 0) \rightarrow (\mathbf{R}, 0)$ of germs of diffeomorphisms of \mathbf{R} which takes the family $\{f_a\}$ to the family $\{g_a\}$.*

From now on, given a good chart (U, j) , we identify \mathbf{R}^{n+N} with $U = j(\mathbf{R}^{n+N})$.

Proof of Lemma 7.3. For any point $\mathbf{x} = (y, z, t, \xi_1, 0) \in V$ the corank of the second differential of the function $f(y, z, t, \cdot, \cdot) : \mathbf{R} \times \mathbf{R}^{N-1} \rightarrow \mathbf{R}$ at \mathbf{x} is equal to 1 (because we do not allow any Σ^2 -singularities of tangency) and the kernel of its second differential is given by the axis ξ_1 in $\mathbf{R} \times \mathbf{R}^{N-1}$. Therefore $|\partial^2 f / \partial \xi_{i_1} \partial \xi_{i_2}(\mathbf{x})| \neq 0$, $i_1, i_2 = 2, \dots, N$, and thus the signature of the second differential of the function $f(y, z, t, \cdot, \cdot) : \mathbf{R} \times \mathbf{R}^{N-1} \rightarrow \mathbf{R}$ is constant in a neighborhood of the disk $D^p \subset \mathbf{R}^{n+N}$. By the parametric version of the “Morse lemma with parameters” there exists a good change of coordinates of the type $(y, z, t, \xi_1, \bar{\xi}) \rightarrow (y, z, t, \xi_1, S_2(y, z, t, \xi_1, \bar{\xi}))$ which reduces f to the necessary form. ■

Proof of Lemma 7.4. At any point $\mathbf{x} = (y, z, t, \xi_1, 0) \in V_k \setminus V_{k+1}$, $0 \leq k \leq s+1$, we have that $\partial^i f / \partial \xi_1^i(\mathbf{x}) = 0$, $i = 1, \dots, k+1$, and $\partial^{k+2} f / \partial \xi_1^{k+2}(\mathbf{x}) \neq 0$. A sufficiently small neighborhood of the disk D^p intersects V_i only if $i \leq s+1$. Therefore for any point $(y, z, t, 0, \bar{\xi})$ close enough to D^p the Milnor number of the function $f(y, z, t, \cdot, \bar{\xi}) : \mathbf{R} \rightarrow \mathbf{R}$ at zero is less or equal to $s+2$. Hence the parametric version of the Tougeron theorem provides us with a good change of coordinates of the type $(y, z, t, \xi_1, \bar{\xi}) \rightarrow (y, z, t, S_1(y, z, t, \xi_1, \bar{\xi}), \bar{\xi})$, which reduces φ to the necessary form.

For any $(y, 0, 0, 0, 0) \in \partial D^p$ we have $\lambda_i(y, 0, 0) = 0$, $i = 1, \dots, s+2$, $\lambda_{s+3}(y, 0, 0) \neq 0$. Moreover, the function λ_{s+3} does not change sign along

∂D^p (for $p > 1$ this is obvious; for $p = 1$ it follows from Definition 2.9 and from Remarks 5.8,5.12). Therefore there exists a function $\tilde{\lambda}_{s+3}$ on a neighborhood of D^p which does not vanish on that neighborhood and which coincides with λ_{s+3} on a neighborhood of ∂D^p . Applying the parametric version of the Tougeron theorem once again by a good change of coordinates we can reduce φ to the form (*) but with the function $\tilde{\lambda}_{s+3}$ in the place of λ_{s+3} . ■

Proof of Lemma 7.5. By a shift and a dilation of ξ_1 we obtain the first two conditions. The third condition follows from the fact that any point $(y, z, 0, 0, 0)$ belongs to V_{s-1} . The last condition holds because the disk D^p lies inside V_{s-1} and intersects V_{s+1} normally. ■

Proof of Lemma 7.6. According to Lemma 7.5, we can assume that we already have a good chart for which $\varphi(y, z, t, \xi_1) = \varphi_1(y, z, t, \xi_1) + \lambda_0(y, z, t)$, where

$$\varphi_1(y, z, t, \xi_1) = \pm \xi_1^{s+3} + \sum_{i=1}^{s+1} \lambda_i(y, z, t) \xi_1^i.$$

We also can assume that the original generating function f is generic (otherwise we could have C^∞ -slightly perturbed it at the very beginning). Therefore we can assume that for any $\mathbf{x} \in D^p$ the mapping

$$(y, z, t, \xi_1) \rightarrow (y, z, t, \varphi_1(y, z, t, \xi_1)) : \mathbf{R}^{s+1} \rightarrow \mathbf{R}^{s+1}$$

is RL -stable at \mathbf{x} (see [4]). In this case, since according to Lemma 7.5,

$$\partial \lambda_i / \partial y_j(y, z, 0) = 0, \partial \lambda_i / \partial z_k(y, z, 0) = 0,$$

$$i = 1, \dots, s, j = 1, \dots, p, k = 1, \dots, n - s - p,$$

the theorem from [4], ch. 9.5, implies that for the points $(y, z, t, 0, 0)$ close enough to D^p

$$\det \|\partial \lambda_i(y, z, t) / \partial t_j\| \neq 0 \quad (i, j = 1, \dots, s - 1).$$

So we can make a change of coordinates

$$(y, z, t_1, \dots, t_{s-1}, t_s, \xi_1, \bar{\xi}) \rightarrow (y, z, \lambda_1(y, z, t), \dots, \lambda_{s-1}(y, z, t), t_s, \xi_1, \bar{\xi})$$

in a neighborhood of D^p so that the new chart is good and in the new coordinates

$$\varphi_1(y, z, t, \xi_1) = \xi_1^{s+3} + \lambda_{s+1}(y, z, t)\xi_1^{s+1} + \lambda_s(y, z, t)\xi_1^s + \sum_{i=1}^{s-1} t_i \xi_1^i.$$

Applying the parametric version of the Tougeron theorem and using the fact that a good chart satisfies condition (B8) of Lemma 7.1 we can reduce φ_1 by a good change of coordinates to the following form:

$$\varphi_1(y, z, t, \xi_1) = \xi_1^{s+3} + \lambda_{s+1}(y, z)\xi_1^{s+1} + \lambda_s(y, z, t_s)\xi_1^s + \sum_{i=1}^{s-1} t_i \xi_1^i,$$

where $\lambda_{s+1}(y, z) = 0$ if and only if $(y, z, 0, 0, 0) \in V_{s+1}$ and $\lambda_s(y, z, t_s) = 0$ if and only if $t_s = 0$.

Since $\lambda_s(y, z, t_s) = 0$ if and only if $t_s = 0$ the function $\partial\lambda_s/\partial t_s$ does not change sign along D^p . Therefore after a C^∞ -small perturbation of λ_s (and thus a C^∞ -small perturbation of the generating function f) in a small neighborhood of D^p we can achieve that $\partial\lambda_s/\partial t_s \neq 0$ along D^p . Then we can make the change of coordinates

$$(y, z, t_1, \dots, t_{s-1}, t_s, \xi_1, \bar{\xi}) \rightarrow (y, z, t_1, \dots, t_{s-1}, \lambda_s(y, z, t), \xi_1, \bar{\xi})$$

in a neighborhood of D^p which would reduce φ to the necessary form. ■

Proof of Lemma 7.7. One only needs to use Lemma 7.6 and to observe that

- 1) according to our construction and the previous lemmas, the zero sets of the functions θ' and λ_{s+1} coincide;
- 2) according to the definition of a basis of a direct surgery, the sign of the function $\pm\lambda_{s+3}$ must be the same as the sign of the function λ_{s+1} inside D^p . ■

8 Double folds: creation and normal forms

A proof of Propositions 3.2 and 6.3. Let x be a point inside the ball B . We create a double fold near x by applying two subsequent direct surgeries and using Proposition 6.1. The surgeries for one of the two possible double folds in the two-dimensional case are shown on Fig. 10.

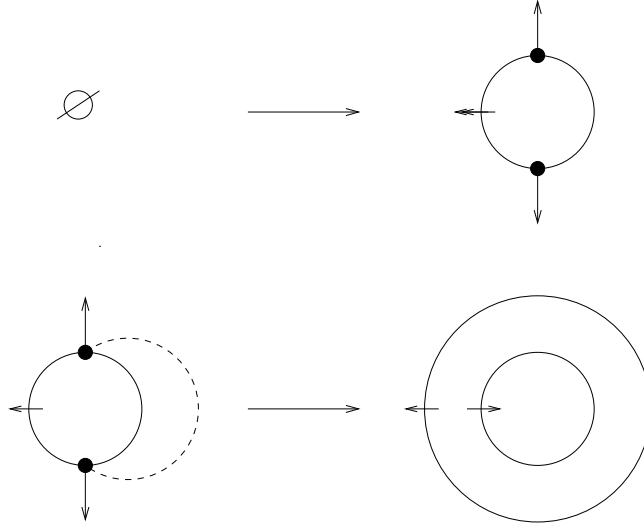

Figure 10: Creation of a double fold by direct surgeries.

More precisely, we first apply a direct surgery of order 1 and index 0 inside a neighborhood of x in B and create a sphere of folds S_1^{n-1} with a sphere of cusps $S_2^{n-2} \subset S_1^{n-1} \subset B$ on it. Let $B_1 \subset L$ be the ball bounded by S_1^{n-1} . The vector field v_2 on S_2^{n-2} necessarily points outside of B_1 and either one of two possible Maslov coorientations of S_1^{n-1} in L can be realized. Then we consider an embedded disk $D^{n-1} \subset L$ which lies in a small neighborhood of the ball B_1 so that $\partial D^{n-1} = S_2^{n-2}$ and the interior of D^{n-1} lies outside of the ball B_1 . We apply a direct surgery of index $n-1$ and order 1 along D^{n-1} and create a double fold that we need. According to Proposition 6.1, the direct surgeries above can be realized by an appropriate deformation of L . ■

Alternatively, we can present an explicit construction of a double fold using a deformation of generating functions.

Another proof of Propositions 3.2 and 6.3. We present a direct proof of Proposition 3.2. One can prove Proposition 6.3 using the same construction.

Again, let x be a point inside the ball B . Using the Darboux theorem for Lagrangian vector bundles (see e.g. [4]) we find some symplectic coordinates near x in T^*L so that near x the submanifold L is identified with

a neighborhood of the origin in the zero-section of $T^*\mathbf{R}^n$ and \mathcal{F} is identified with the foliation of $T^*\mathbf{R}^n$ by the leaves of the canonical Lagrangian projection $T^*\mathbf{R}^n \rightarrow \mathbf{R}^n$. Thus we can assume that $B = B^n \subset \mathbf{R}^n$ is the standard unit ball and then it is enough for us to construct a Hamiltonian isotopy of the ball B in $T^*\mathbf{R}^n$ with the required properties (the singularities of tangency to \mathcal{F} are now viewed as singularities of the Lagrangian projection $T^*\mathbf{R}^n \rightarrow \mathbf{R}^n$). We can construct this Hamiltonian isotopy of L by constructing a deformation of generating functions.

We start with a function on $\mathbf{R}^n \times \mathbf{R}$ which generates the zero-section $L \subset \mathbf{R}^4$. We then construct a deformation of this generating function f_0 which in a neighborhood of the origin deforms the flat $V_L = \mathbf{R}^n \times 0 \subset \mathbf{R}^n \times \mathbf{R}$ into a ‘‘mushroom’’ with respect to the ‘‘vertical’’ fibers of the projection $\mathbf{R}^n \times \mathbf{R} \rightarrow \mathbf{R}^n$ as on Fig. 1. The construction proceeds as follows.

Given an $\epsilon \in (0, 1)$ and r_1, r_2, r_3, r_4 , $0 < r_1 < r_2 < r_3 < r_4 < 1$, let $\{t_a(r)\} : \mathbf{R} \rightarrow \mathbf{R}$, $-\epsilon \leq a \leq 0$, be a smooth family of functions which satisfies the following properties for any a :

- (i) $t_a(r) \equiv 0$ outside of the interval $[r_1, r_4]$;
- (ii) $t_a(r)$ is a linear function on $[r_2, r_3]$ and $t_a(r_2) = 100a$, $t_a(r_3) = -100a$.

For sufficiently small $\epsilon, r_1, r_2, r_3, r_4$ we can construct a family of functions $\{f_a\} : B^n \times B^1 \rightarrow \mathbf{R}$, $-\epsilon \leq a \leq 0$, some balls $B_{r_5}^n, B_{r_6}^n$, $r_4 < r_5 < r_6 < 1$, and $B_{\delta_1}^1, B_{\delta_2}^1$, $0 < \delta_1 < \delta_2 < 1$, so that for any a , $-\epsilon \leq a \leq 0$, the following conditions hold:

- (i) inside $B_{r_5}^n \times B_{\delta_1}^1$ the function f_a is given by the formula

$$f_a(y, \xi) = \xi^4 + a\xi^2 + t_a(r)\xi,$$

$y = (y_1, \dots, y_n) \in B^n$, $r = r(b) = y_1^2 + \dots + y_n^2$, $\xi \in B^1$;

- (ii) $f_a(y, \xi) = \xi^2$, outside $B_{r_6}^n \times B_{\delta_2}^1$;
- (iii) for any a all the critical points of f_a with respect to the variable ξ lie inside $B_{r_5}^n \times B_{\delta_1}^1$.

Consider a smooth family of functions $\{g_\tau = f_{-\epsilon\tau}\}$, $0 \leq \tau \leq 1$, on $B^n \times \mathbf{R}$. For any τ the function g_τ generates an *embedded* Lagrangian submanifold in $T^*\mathbf{R}^n$ which, if we started with a sufficiently small ϵ , coincides with L outside of an arbitrarily small neighborhood of 0 in $T^*\mathbf{R}^n$. One easily checks that g_1 generates a Lagrangian submanifold $L_1 \subset T^*\mathbf{R}^n$ such that the only singularities of the Lagrangian projection on L_1 are some two

small spheres $S_1, S_2 \subset L_1$ of folds with the opposite Maslov coorientations. If we change $t_a(r)$ to $-t_a(r)$ in our construction, the Maslov coorientations of S_1 and S_2 change simultaneously and thus we can always get a necessary combination of them.

It is not hard to see that the deformation $\{g_\tau\}$ gives us a Lagrangian isotopy $\{L_\tau\}$ of L in $T^*\mathbf{R}^n$ which is identical outside B^n . This Lagrangian isotopy is actually a Hamiltonian isotopy $\{L_\tau = h_\tau(L)\}$ because under our deformation the periods of the canonical 1-form pdq on L do not change.

By an appropriate choice of $\epsilon, r_1, r_2, r_3, r_4$ the deformation $\{g_\tau\}$ can be made arbitrarily C^1 -small. Therefore the Hamiltonian isotopy $\{h_\tau\}$ can be chosen in such a way that it is arbitrarily C^0 -small and so that $|\int_{h_\tau(\gamma)} pdq|$ is uniformly bounded by an arbitrarily small number independent of τ and a path γ in L . ■

Now let us discuss normal forms for double folds mentioned in Remark 1.4.

Suppose that the zero-section $L \subset T^*L$ (resp. $L' \subset T^*L'$) has a double fold along some spheres S_1, S_2 (resp. S'_1, S'_2) with respect to a Lagrangian foliation \mathcal{F} (resp. \mathcal{F}'). Suppose that the Maslov coorientations of S_1 and S_2 form the same combination as for S'_1 and S'_2 . Let B (resp. B') be a ball in L (resp. L') bounded by S_2 (resp. S'_2), the larger of the two spheres of folds.

Proposition 8.1 *There exists a symplectomorphism F between a neighborhood of B in T^*L and a neighborhood of B' in T^*L' which maps the zero-section $L \subset T^*L$ into the zero-section $L' \subset T^*L'$ and \mathcal{F} into \mathcal{F}' (so it also has to map S_1 into S'_1 and S_2 into S'_2).*

In particular, for any L with a double fold along S_1 and S_2 we can find such a symplectomorphism F which identifies a small neighborhood of the ball B with a small neighborhood of one of the explicit double folds constructed in the second proof of Proposition 3.2 above.

Proof of Proposition 8.1. First, let us show that we can construct the symplectomorphism F in a neighborhood of each sphere of folds S_i .

Let S be one of the spheres S_1 and S_2 . Consider a small neighborhood \tilde{U} of the sphere S in T^*L . We can choose an almost complex structure J on \tilde{U} so that S lies in a single leaf A of the Lagrangian foliation $J(\mathcal{F})$ of \tilde{U} . A small neighborhood of S in A (still denoted by A) is an n -dimensional Lagrangian spherical annulus. Hence, using the Lagrangian neighborhood

theorem [25],[26] we can symplectically identify a small neighborhood of A in T^*L with a small neighborhood (still denoted by \tilde{U}) of the zero-section A in T^*A . Let us identify A with an n -dimensional spherical annulus in $\mathbf{R}^n \subset \mathbf{R}^{2n}$ (still denoted by A) given by the equations $p_1 = p_2 = \dots = p_n = 0, 2-\delta < \|q\| < 2+\delta$, where δ is very small. According to [16], we can find a generating function g for the Lagrangian submanifold $L \cap \tilde{U}$. This function g will be defined on an open subset of $A \times \mathbf{R}^N$ for some N . By the same argument as in the proof of Lemma 7.1 (see Section 7.3) we can reduce g to a normal form $g_{\alpha,\beta,Q}(q, \xi) = \xi_1^3 + \alpha(\mathbf{r})\xi_1 + \beta(q) + Q(\xi_2, \dots, \xi_n)$. Here q runs over a small neighborhood of S in A , $\xi = (\xi_1, \dots, \xi_N)$ are the coordinates on a neighborhood of zero in \mathbf{R}^N , $\mathbf{r} = q_1^2 + \dots + q_n^2$ and Q is a nondegenerate quadratic form. The function $\alpha(\mathbf{r})$ has a simple zero along S and the sign of $\partial\alpha/\partial\mathbf{r}$ on S depends on the Maslov coorientation of the sphere of folds S . Suppose there is another function $g_{\alpha',\beta',Q'}$ of this type such that the sign of $\alpha'(\mathbf{r})$ along S is the same as for $\alpha(\mathbf{r})$. Then it is not hard to show that there exists a symplectomorphism of \tilde{U} preserving the fibers of the Lagrangian projection and mapping the Lagrangian submanifold generated by $g_{\alpha,\beta,Q}$ into the Lagrangian submanifold generated by $g_{\alpha',\beta',Q'}$. Thus we have reduced L and \mathcal{F} in a neighborhood of S to the standard form. Therefore we can construct the necessary map F near each of the spheres S_1 and S_2 .

Now we need to extend F to a neighborhood of the rest of B . We can easily extend F to a neighborhood of the whole B as a *diffeomorphism* \tilde{F} which maps \mathcal{F} into \mathcal{F}' , L into L' and which identifies the symplectic form ω on T^*L into the symplectic form ω' on T^*L' (*only*) *along the zero-section* $L \subset T^*L$.

The form $\omega_1 = \tilde{F}^*\omega'$ is a symplectic form on a neighborhood U of B in T^*L which already coincides with ω along a subset $W \subset U$ which is a union of the zero-section L and of some neighborhoods of S_1 and S_2 in U . It suffices to find a symplectomorphism of a possibly smaller neighborhood $U_1 \subset U$ of B which is identical on W , which preserves the leaves of the foliation \mathcal{F} and the zero-section L and which maps the form ω on \tilde{U} into the form ω_1 . We find such a symplectomorphism using Moser's argument. Namely, let us consider a linear homotopy $\omega_\tau = \tau\omega + (1-\tau)\omega_1$, $0 \leq \tau \leq 1$. In a neighborhood of L this is a family of symplectic forms. Observe that the leaves of \mathcal{F} are Lagrangian submanifolds with respect to $\tilde{F}^*\omega'$ and hence with respect to any ω_τ . Observe also that we only need to construct the symplectomorphism near those points of L where \mathcal{F} is transversal to L . All this implies that we can solve the corresponding homological equation and find a (time-dependent) Hamiltonian vector field X_t on a neighborhood

$U_1 \subset U$ of B so that

- (i) X_t is zero at the points of W ;
- (ii) X_t is tangent to \mathcal{F} ;
- (iii) the Hamiltonian flow h_τ of X is defined in a neighborhood of $L \subset U_1$ and satisfies the property $(h_\tau)^*\omega = \omega_\tau$.

The Hamiltonian symplectomorphism h_1 combined with the diffeomorphism \tilde{F} gives the needed symplectomorphism between a neighborhood of B in T^*L and a neighborhood of B' in T^*L' . This finishes the proof of the proposition. ■

References

- [1] Arnold, V.I., *A characteristic class entering in quantization conditions*, *Funct. Analysis. and its Appl.* **1:1** (1967), 1-13.
- [2] Arnold, V.I., *Normal forms for functions near degenerate critical points, the Weyl groups A_k , D_k , E_k , and Lagrangian singularities*, *Funct. Analysis and its Appl.* **6** (1972), 254-272.
- [3] Arnold, V.I., *Wave front evolution and equivariant Morse lemma*, *Comm. in Pure and Appl. Math.* **29:6** (1976), 557-582.
- [4] Arnold, V.I., Gusein-Zade, S.M., Varchenko, A.N., *Singularities of Differential Maps*, Volume I, Birkhäuser, Boston-Basel-Stuttgart, 1985.
- [5] Arnold, V.I., *Spaces of functions with moderate singularities*, *Funct. Analysis and its Appl.* **23:3** (1989), 169-177.
- [6] Arnold, V.I., Givental, A.B., *Symplectic geometry*, in *Encyclopaedia of Math. Sciences: Dynamical Systems, Vol.IV*, Springer-Verlag, Berlin, 1990.
- [7] Arnold, V.I., *Topological Invariants of Plane Curves and Caustics*, AMS, Providence, 1994.
- [8] Arnold, V.I., *Invariants and perestroikas of fronts on a plane* (in Russian), *Trudy Mat. Inst. Steklov.* **209** (1995), 14-64.
- [9] Boardman, J.M., *Singularities of differentiable maps*, *Publ. Math. IHES* **33** (1967), 21-57.

- [10] Borel, A., *Sur la cohomologie des espaces fibrés principaux et des espaces homogènes de groupes de Lie compacts*, Ann. of Math. **57** (1953), 115-207.
- [11] Chekanov, Yu.V., *Lagrangian tori in a symplectic vector space and global symplectomorphisms*, Math. Z. **223**:4 (1996), 547-559.
- [12] Eliashberg, Y., *On singularities of folding type*, Math. of the USSR, Izvestija **4**:5 (1970), 1119-1134.
- [13] Eliashberg, Y., *Surgery of singularities of smooth mappings*, Math. of the USSR, Izvestija **6**:6 (1972), 1302-1326.
- [14] Entov, M., *On the necessity of the Legendrian fold singularities*, Intern. Mat. Res. Notices, **20**, 1999.
- [15] Ferrand, E., Pushkar', P., *Non cancellation of singularities on wave fronts*, C.R. Acad. Sci. (Paris), série I, **327**:8 (1998).
- [16] Giroux, E., *Formes génératrices d'immersions lagrangiennes dans un espace cotangent*, C. R. Acad. Sci. (Paris), série I, **306**:18 (1988), 761-764.
- [17] Haefliger, A., *Quelques remarques sur les applications d'une surface dans le plan*, Ann. Inst. Fourier **10** (1960), 47-60.
- [18] Igusa, K., *The space of framed functions*, Trans. AMS **301**:2 (1987), 431-477.
- [19] Levine, H., *The singularities, S_1^q* , Illinois J. Math. **8** (1964), 152-168.
- [20] Lychagin, V.V., *Local classification of non-linear first order partial differential equations*, Russ. Math. Surveys **30**:1 (1975), 105-175.
- [21] Morin, B., *Formes canoniques des singularités d'une application différentiable*, C.R. Acad. Sci. (Paris), série I, **260** (1965), 5662-5665, 6503-6506.
- [22] Tougeron, J.C., *Ideaux de fonctions différentiables*, Ann. Inst. Fourier **18**:1 (1968), 177-240.
- [23] Thom, R., *Les singularités des applications différentiables*, Ann. Inst. Fourier **6** (1956), 43-88.

- [24] Vassilyev, V.A., *Lagrange and Legendre Characteristic Classes*, Gordon and Breach, New York, 1988.
- [25] Weinstein, A., *Symplectic Manifolds and Their Lagrangian Submanifolds*, Adv. Math. **6** (1971), 329-346.
- [26] Weinstein, A., *Lectures on symplectic manifolds*. CBMS Conference Series, **29**. AMS, Providence, 1977.
- [27] Whitney, H., *On singularities of mappings of Euclidean spaces. I. Mappings of the plane into the plane*, Ann. of Math. **62**:3 (1955), 374-410.