

# EQUILEVEL ALGEBRAS

V.A. VASSILIEV

**ABSTRACT.** An equilevel algebra is a subalgebra of the space of smooth functions  $f : M \rightarrow \mathbb{R}$  distinguished in this space by finitely many conditions of the type  $f(x_i) = f(\tilde{x}_i)$ ,  $x_i \neq \tilde{x}_i \in M$ , or approximated by such subalgebras. For  $M = S^1$  or  $\mathbb{R}^1$ , the regular points of the variety of equilevel algebras of codimension  $k$  are known in knot theory as  $k$ -chord diagrams. The whole of this variety completes the space of chord diagrams in the same way as the Hilbert schemes complete the configuration spaces. We describe cell structures of the varieties of all equilevel algebras up to the codimension three in the space  $C^\infty(S^1, \mathbb{R})$  and compute their homology groups and characteristic classes of canonical vector bundles on them.

## 1. INTRODUCTION

**1.1. Chord diagrams, configuration spaces and their completions.** The  $k$ -th configuration space of a manifold  $M$  is the (naturally topologized) space of all unordered subsets of cardinality  $k$  in  $M$ . It is denoted by  $B(M, k)$ .

The homology groups of configuration spaces appear in many topological problems concerning the spaces of non-singular geometric objects (such as non-singular manifolds and generic maps, including immersions, functions without complicated critical points, and iterated loops of highly-connected spaces, see e.g. [8]). The reason for this is that the configuration spaces participate in an essential way in the natural stratification of the complementary “discriminant” sets of the corresponding singular objects (which have forbidden singularities at at least one point — and are therefore stratified in the correspondence with the number of these bad points, with strata fibered over possible collections of such points).

Every  $k$ -point configuration in a manifold  $M$  defines in an obvious way an ideal of codimension  $k$  in  $C^\infty(M, \mathbb{R})$ , so a natural completion  $\overline{B(M, k)}$  of the configuration space consists of all ideals of this codimension. An advantage of this completion is that the *regular vector bundle* on  $B(M, k)$  (whose fiber over a  $k$ -point set is the space of all real-valued functions on that set) can be continued to a vector bundle over  $\overline{B(M, k)}$ , and thus its characteristic classes can be studied in the context of the entire this closed set.

The *chord diagrams* are the finite collections of different pairs of points  $x_i \neq \tilde{x}_i \in M$ , see e.g. [1]–[3], [7]. They play a role analogous to that of configurations in the study of non-singular geometric objects, when the notion of singularity is formulated in the terms of the simultaneous behavior at two points: in particular, in the study of spaces of embeddings (including the knot theory), i.e., of maps without self-intersections of the image; spaces of maps without self-tangencies of the image, of strictly Morse functions (i.e., functions having no coinciding critical values at different points), etc. Each chord diagram  $((x_1, \tilde{x}_1), \dots, (x_k, \tilde{x}_k))$  defines a subalgebra in  $C^\infty(M, \mathbb{R})$  consisting of functions satisfying all conditions  $f(x_i) = f(\tilde{x}_i)$ .

---

2020 *Mathematics Subject Classification.* 55R80.

This work was supported by the Absorption Center in Science of the Ministry of Immigration and Absorption of the State of Israel.

The *equilevel algebras* of codimension  $k$  in  $C^\infty(M, \mathbb{R})$  are the subalgebras which are arbitrarily well approximated by algebras defined by  $k$ -chord diagrams. For example, such an algebra of codimension three in  $C^\infty(\mathbb{R}^1, \mathbb{R})$  can depend on two points  $A, B \in \mathbb{R}^1$  and one point  $(\alpha : \beta : \gamma) \in \mathbb{R}P^2$  and consist of all functions  $f : \mathbb{R}^1 \rightarrow \mathbb{R}$  such that

$$f(A) = f(B), \quad f'(A) = 0, \quad \text{and} \quad \alpha f'''(A) + \beta f''(A) + \gamma f'(B) = 0.$$

We denote by  $CD_k(M)$  (respectively, by  $\overline{CD}_k(M)$ ) the variety of all subalgebras of codimension  $k$  in  $C^\infty(M, \mathbb{R})$  defined by collections of chords (respectively, of all equilevel algebras of codimension  $k$ ).

For some applications of the varieties  $CD_k(M^1)$  and  $\overline{CD}_k(M^1)$  in knot theory and interpolation theory, see [9] and [10].

All equilevel algebras of codimension 1 and 2 in  $C^\infty(S^1, \mathbb{R})$  are listed in [10]. In particular, the variety  $\overline{CD}_1(S^1)$  is homeomorphic to the closed Moebius band; the homology groups of the space  $\overline{CD}_2(S^1)$  (both with rational and  $\mathbb{Z}_2$ -coefficients) are isomorphic to those of  $\mathbb{R}P^3$ , but the multiplication in the  $\mathbb{Z}_2$ -cohomology ring is different.

In the present work we list all such subalgebras of codimension 3 in  $C^\infty(S^1, \mathbb{R})$  and describe the natural structure of a CW-complex on the variety  $\overline{CD}_3(S^1)$  including all incidence coefficients of the corresponding cellular chain complex mod 2. It seems that this case of codimension 3 algebras demonstrates well all main problems and features of the general situation.

The computations in this cell complex imply the following information about the homology groups.

**Theorem 1.**  $H_0(\overline{CD}_3(S^1), \mathbb{Z}_2) \simeq H_1(\overline{CD}_3(S^1), \mathbb{Z}_2) \simeq \mathbb{Z}_2$ .  
 $H_2(\overline{CD}_3(S^1), \mathbb{Z}_2) \simeq H_3(\overline{CD}_3(S^1), \mathbb{Z}_2) \simeq \mathbb{Z}_2^2$ .  
 $H_i(\overline{CD}_3(S^1), \mathbb{Z}_2) \simeq 0$  for all  $i \geq 4$ .

**Definition 1.** The *canonical vector bundle* on  $\overline{CD}_k(M)$  is the  $k$ -dimensional bundle whose fiber over an equilevel algebra is the quotient space of  $C^\infty(M, \mathbb{R})$  by that algebra.

According to [10], the groups  $H^1(\overline{CD}_1(S^1), \mathbb{Z}_2)$  and  $H^1(\overline{CD}_2(S^1), \mathbb{Z}_2)$  are generated by the first Stiefel–Whitney classes of canonical bundles, and the group  $H^2(\overline{CD}_2(S^1), \mathbb{Z}_2)$  is generated by the second Stiefel–Whitney class (which in this case is equal to the square of the first class).

**Theorem 2.** *The group  $H^1(\overline{CD}_3(S^1), \mathbb{Z}_2)$  is generated by the first Stiefel–Whitney class  $w_1$  of the canonical bundle.*

*The group  $H^2(\overline{CD}_3(S^1), \mathbb{Z}_2)$  is generated by the classes  $w_1^2$  and  $w_2$  of the canonical bundle.*

*The class  $w_3$  of the canonical bundle is a non-trivial element of the group  $H^3(\overline{CD}_3(S^1), \mathbb{Z}_2)$ .*

## 2. FORMAL DEFINITION AND BASIC PROPERTIES OF EQUILEVEL ALGEBRAS

**2.1. Main definition.** Consider the space  $\text{Sym}^k(\text{Sym}^2(M))$  of all unordered collections of  $2k$  (not necessarily different) points in the algebraic manifold  $M$  that are somehow paired. The space  $CD_k^0(M)$  of such paired collections, whose  $2k$  points are all different, is an open subset in this space; each such collection defines a subalgebra (over  $\mathbb{R}$ ) of codimension  $k$  in  $C^\infty(M, \mathbb{R})$  consisting of functions satisfying the conditions  $f(x_i) = f(\tilde{x}_i)$ ,  $i = 1, \dots, k$ , for all pairs  $\{x_i, \tilde{x}_i\} \subset M$  of this collection.

Consider an arbitrary germ of an algebraic parametric curve  $\nu : [0, \varepsilon) \rightarrow \text{Sym}^k(\text{Sym}^2(M))$ , such that the set  $\nu(0, \varepsilon)$  belongs to this space  $CD_k^0(M)$ . For any  $t \in (0, \varepsilon)$  denote by  $\mathcal{F}_t$

the subalgebra defined by the chord diagram  $\nu(t)$ . Consider the union of all functions  $f \in C^\infty(M, \mathbb{R})$ , which are the limits in  $C^{2k}(M)$  topology of some functions  $f_t \in \mathcal{F}_t$  continuously depending on  $t$  as  $t \rightarrow +0$ . Obviously, this union is also a subalgebra in  $C^\infty(M, \mathbb{R})$ . By definition, the *equilevel algebras* of class  $\overline{CD}_k(M)$  are arbitrary subalgebras which can be defined in this way by the curves  $\nu$ .

**Remark 1.** In general, such a limit subalgebra does not uniquely define the point  $\nu(0)$ . For example, the subalgebra of class  $\overline{CD}_2(S^1)$  consisting of all functions satisfying the conditions  $f(a) = f(b) = f(c)$  for three different points  $a, b, c \in S^1$  can be defined by this construction with the point  $\nu(0) \in \text{Sym}^2(\text{Sym}^2(S^1))$  equal to any one of the points  $((a, b), (a, c))$ ,  $((a, b), (b, c))$ , or  $((a, c), (b, c))$ .

However, the set of all different points of  $M$  involved in the set  $\nu(0)$  of any such construction of an equilevel algebra is the same for all these constructions; it is called the *support* of that subalgebra. Obviously, the support of any equilevel algebra of codimension  $k$  consists of at most  $2k$  points.

**Proposition 1.** *Suppose that a subalgebra  $\mathcal{F} \subset C^\infty(M, \mathbb{R})$  of class  $\overline{CD}_k(M)$  has the above construction with the support consisting of points  $A_1, \dots, A_r$ , where each point  $A_i$  participates in  $\nu(0)$  with some multiplicity  $m_i$ ,  $m_1 + \dots + m_r = 2k$ . Then the subalgebra  $\mathcal{F}$  contains*

- a) all constant functions;
- b) the ideal

$$(1) \quad \mathfrak{M}_{A_1}^{m_1} \times \dots \times \mathfrak{M}_{A_r}^{m_r}$$

consisting of all functions vanishing at each point  $A_i$  with multiplicity  $m_i$ .

*Proof.* a) All algebras defined by chord diagrams  $\nu(t), t > 0$ , contain the space of constant functions.

b) Let  $f \in C^\infty(M, \mathbb{R})$  be an arbitrary function from the ideal (1). We must show that it is approximated by a continuous family of functions from the algebras defined by the chord diagrams  $\nu(t)$  as  $t$  tends to  $+0$ . By additivity and partition of unity, we can assume that  $f$  is non-zero only in a small neighborhood of one point  $A_i$  of the support of  $\mathcal{F}$ , and in the local coordinates  $x_1, \dots, x_n$  at this point this function is divisible by a monomial of degree  $m_i$ : so,  $f$  has the form

$$(2) \quad f_0 \cdot x_{p_1} \cdot x_{p_2} \cdot \dots \cdot x_{p_{m_i}},$$

where  $f_0$  is a smooth function equal identically to zero outside the coordinate neighborhood of  $A_i$ , and  $1 \leq p_1 \leq p_2 \leq \dots \leq p_{m_i} \leq n$ . For any  $t \in (0, \varepsilon)$ , let  $\tilde{A}_i^1(t), \dots, \tilde{A}_i^{m_i}(t)$  be arbitrarily ordered  $m_i$  endpoints of the  $k$ -chord diagram  $\nu(t)$  tending continuously to the point  $A_i$ . The 1-parametric family of functions

$$f_0 \cdot (x_{p_1} - x_{p_1}(A_i^1)) \cdot (x_{p_2} - x_{p_2}(A_i^2)) \cdot \dots \cdot (x_{p_{m_i}} - x_{p_{m_i}}(A_i^{m_i}))$$

belonging to the subalgebras corresponding to the points  $t \in (0, \varepsilon)$  then tends to the function (2).  $\square$

**Problem.** Let  $k$  be a natural number,  $A_1, \dots, A_r$  be some  $r$  distinct points in  $S^1$  ( $r \leq 2k$ ), and  $m_1, \dots, m_r$  be some  $r$  natural numbers with  $\sum m_r = 2k$ . Is it true that every subalgebra of codimension  $k$  in the space  $C^\infty(M, \mathbb{R})$ , containing the ideal (1) and all constant

functions, belongs to  $\overline{CD}_k(M)$  (i.e. can be obtained as a limit of subalgebras defined by  $k$ -chord diagrams)?

We will see below that this is true for  $k = 3$  and  $\dim M = 1$ .

**2.2. Fighting the infinite dimensional issues.** Let  $\mathcal{L}$  be an arbitrary finite-dimensional vector subspace of  $C^\infty(M, \mathbb{R})$  such that for any  $2k$  different points of  $M$  and any collection of  $(2k - 1)$ -jets of functions  $M \rightarrow \mathbb{R}$  at these points, there exists a function  $f \in \mathcal{L}$  whose  $(2k - 1)$ -jets at these  $2k$  points coincide with the given ones. In particular, this subspace  $\mathcal{L}$  is transversal to all ideals mentioned in statement b) of Proposition 1. Then every subalgebra of the class  $\overline{CD}_k(M)$  is completely characterized by its intersection with this subspace  $\mathcal{L}$  (and this intersection always is transversal).

Every chord diagram  $\nu(t)$ ,  $t > 0$ , arising in the above definition of equilevel algebras, defines a subspace of codimension  $k$  in  $\mathcal{L}$ , that is, a point of the Grassmann manifold  $G_{\dim \mathcal{L} - k}(\mathcal{L})$ . These points form an algebraic curve in this manifold and thus have a limit in it as  $t \rightarrow +0$ . This limit position then coincides with the intersection of  $\mathcal{L}$  with our equilevel algebra; thus the entire variety  $\overline{CD}_k(M)$  can be identified with a closed semialgebraic subvariety of the finite-dimensional algebraic Grassmann manifold.

**Corollary 1.** *Consider the Cartesian product*

$$(3) \quad \mathcal{O}_{A_1} \times \cdots \times \mathcal{O}_{A_r}$$

*of the spaces of germs of smooth functions at all the points  $A_1, \dots, A_r$  of the support of an equilevel subalgebra  $\mathcal{F}$ . The image of this subalgebra in the space (3) under the restriction map of  $C^\infty(M, \mathbb{R})$  is a subalgebra of codimension  $k$  in (3), and  $\mathcal{F}$  is equal to the preimage of this its image.  $\square$*

**2.3. A lower estimate of the group  $H^*(\overline{CD}_k(S^1), \mathbb{Z}_2)$ .** The group  $H^*(\overline{CD}_k(S^1), \mathbb{Z}_2)$  is “not smaller” than the cohomology group of the configuration space  $B(\mathbb{R}^2, k)$  (i.e. of the braid group with  $k$  strings, see [4]) in the following exact sense.

**Theorem 3.** *There exists a subspace  $\mathcal{B}_k \subset B(\mathbb{R}^2, k)$  and its continuous map  $\psi : \mathcal{B}_k \rightarrow \overline{CD}_k(S^1)$  such that the map*

$$(4) \quad H^*(B(\mathbb{R}^2, k), \mathbb{Z}_2) \rightarrow H^*(\mathcal{B}_k, \mathbb{Z}_2)$$

*induced by the identical embedding is monomorphic, and the image of this map (4) is a subgroup of the image of the map  $\psi^* : H^*(\overline{CD}_k(S^1), \mathbb{Z}_2) \rightarrow H^*(\mathcal{B}_k, \mathbb{Z}_2)$ .*

*Proof.*  $\mathcal{B}_k$  is the set of all unordered collections of  $k$  chords  $\{x_i < \tilde{x}_i\} \subset (0, 2\pi)$  such that the system of  $k$  conditions  $f(x_i) = f(\tilde{x}_i)$  defines a subspace of codimension  $k$  in  $C^\infty(S^1, \mathbb{R})$ . Each such chord can be considered as a point of the open triangle  $\{(x, y) : 0 < x < y < 2\pi\} \subset \mathbb{R}^2$ , so our collection is a point of  $B(\mathbb{R}^2, k)$ . The map  $\psi$  sends any such collection to the subspace defined by it.

Recall that the *regular vector bundle* over  $B(\mathbb{R}^2, k)$  (in particular over  $\mathcal{B}_k$ ) is the  $k$ -dimensional vector bundle, whose fiber over a  $k$ -point configuration is the space of  $\mathbb{R}$ -valued functions on that configuration. By Lemma 13 of [9], the regular bundle over  $\mathcal{B}_k$  is isomorphic to the bundle induced by the map  $\psi$  from the canonical bundle on  $\overline{CD}_k((0, 2\pi) \subset \overline{CD}_k(S^1))$  (see Definition 1 on page 2 above). Therefore, the subring of  $H^*(\mathcal{B}_k, \mathbb{Z}_2)$  multiplicatively generated by the Stiefel–Whitney classes of the regular bundle belongs to the image of the map  $\psi^*$ .

In [4] it is proved that the entire ring  $H^*(B(\mathbb{R}^2, k), \mathbb{Z}_2)$  is multiplicatively generated by Stiefel–Whitney classes of the regular bundle, hence the subring of  $H^*(\mathcal{B}_k, \mathbb{Z}_2)$  generated by such classes coincides with the image of the map  $H^*(B(\mathbb{R}^2, k), \mathbb{Z}_2) \rightarrow H^*(\mathcal{B}_k, \mathbb{Z}_2)$  induced by the identical embedding. By Lemma 16 of [9], this map is monomorphic.  $\square$

### 3. CLASSIFICATION OF EQUILEVEL ALGEBRAS OF CODIMENSION 3 IN $C^\infty(S^1, \mathbb{R})$ AND A CELL STRUCTURE ON $\overline{CD}_3(S^1)$ .

3.1. We divide the equilevel subalgebras of  $C^\infty(S^1, \mathbb{R})$  into two types: the algebras whose supports contain or do not contain the distinguished point  $\bullet = \{0, 2\pi\} \in S^1 \equiv [0, 2\pi]/(0 \cup 2\pi)$ . We will describe 130 families of such subalgebras of any of these two types. All these families are diffeomorphic to open disks of certain dimensions, thus defining a decomposition of the whole space  $\overline{CD}_3(S^1)$  into cells. The algebras which are moved to each other by an orientation preserving diffeomorphism of  $S^1$  taking the distinguished point to itself belong to the same cell, so the points of their supports are the parameters of these cells. Moreover, the uniform (in a sense) algebras with the same support also lie in the same cell. To each cell of the first type (consisting of algebras, whose supports do not contain the point  $\bullet$ ) a cell of the second type is related: its elements are the algebras whose supports are obtained from the supports of the former algebras by shifting them along the orientation of  $S^1$  until the point with the largest value of the coordinate comes to the distinguished point. Obviously, the dimension of the resulting cell is 1 less than that of the initial cell.

**Theorem 4.** *The space  $\overline{CD}_3(S^1)$  has the structure of a CW-complex with 260 cells. Namely, it contains 130 cells of the first type: 15 of dimension 6, 41 of dimension 5, 44 of dimension 4, 23 of dimension 3, 6 of dimension 2, and one of dimension 1; it also has the same number of cells of the second type of dimensions 5, 4, 3, 2, 1, and 0, respectively. All these cells are described below in §3, and their incidence coefficients are given in §5.*

3.2. **About the notation.** In the subsections 3.3–3.8 below we list the cells of the first type. The notations of the corresponding cells of the second type are obtained from the notations of the corresponding cells of the first type by placing the bar above them.

In the figures illustrating the algebras from these cells, the horizontal interval shows the open part  $(0, 2\pi)$  of the circle. Any simple arc connecting two its points  $A$  and  $B$  indicates the condition  $f(A) = f(B)$ ; a tripod with feet at the points  $A$ ,  $B$  and  $C$  means the double condition  $f(A) = f(B) = f(C)$ . An asterisk  $*$  at the point  $A$  indicates the condition  $f'(A) = 0$ , a double asterisk indicates the pair of conditions  $f'(A) = f''(A) = 0$ .

The double arc connecting two ordinary (i.e. not marked by asterisks) points  $A$  and  $B$  denotes a family of pairs of conditions  $f(A) = f(B)$  and  $f'(A) = \alpha f'(B)$ ; the second of these conditions depends on a real parameter  $\alpha \in \mathbb{R}^1 \setminus \{0\}$ . This double arc in the notation of a cell is always marked by a sign  $+$  or  $-$  indicating the sign of the parameter  $\alpha$ .

A once circled asterisk  $\otimes$  at the point  $A$  also depends on a parameter  $\alpha \in \mathbb{R}$  and means the pair of conditions  $f'(A) = 0$ ,  $f'''(A) = \alpha f''(A)$ . More complicated notations are explained where they appear.

3.3. **6-dimensional cells of  $\overline{CD}_3(S^1)$ .** There are exactly 15 such cells, see Fig. 1; they are parametrized by the points of the supports of their algebras and are characterized by the partition of these six (naturally ordered) points into the pairs.

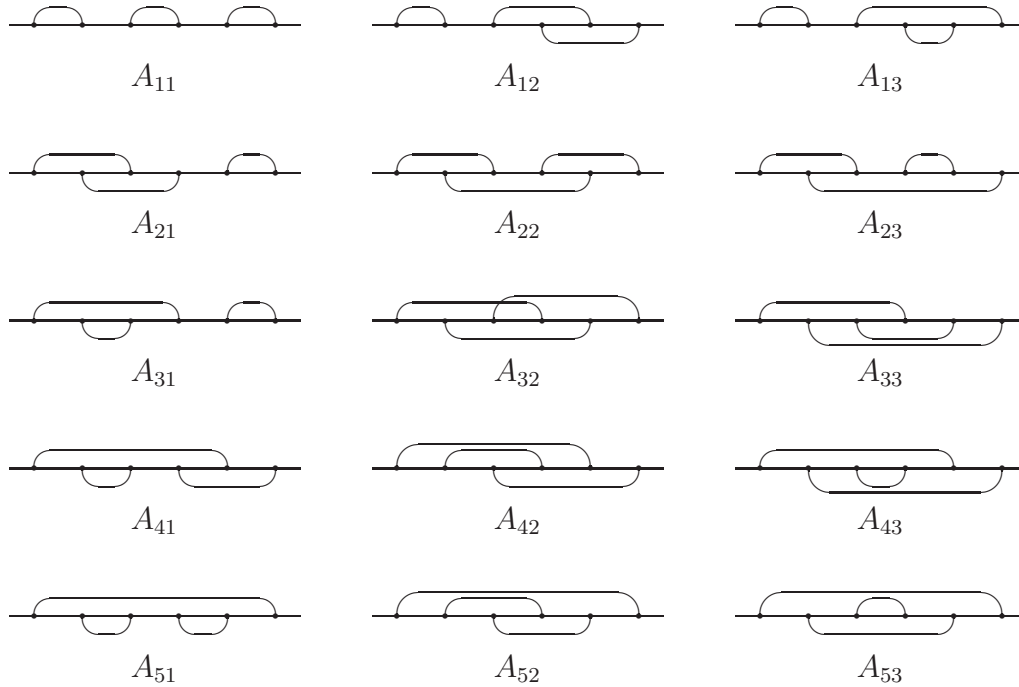

FIGURE 1. A

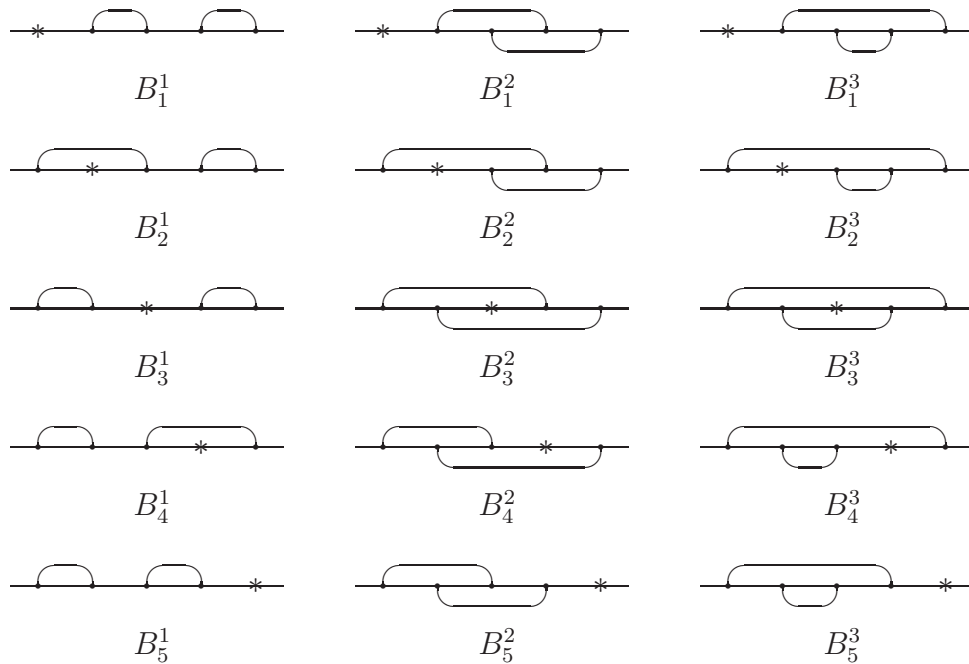
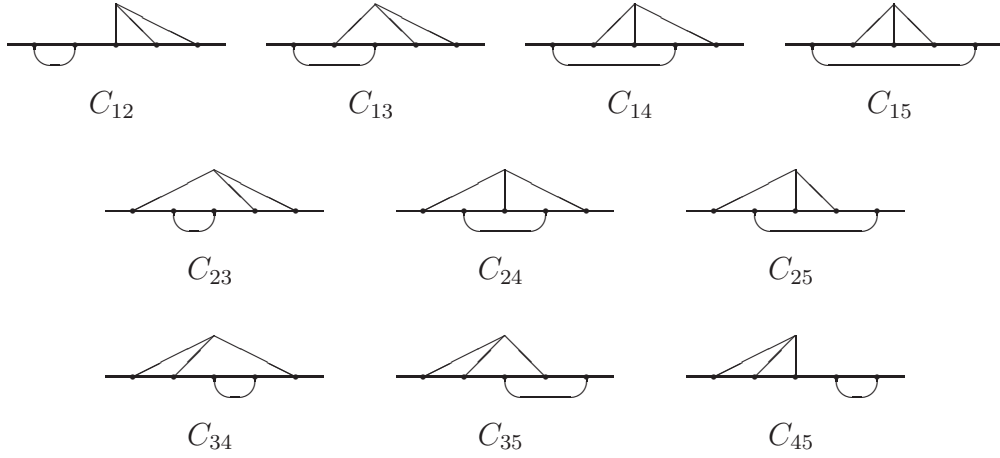
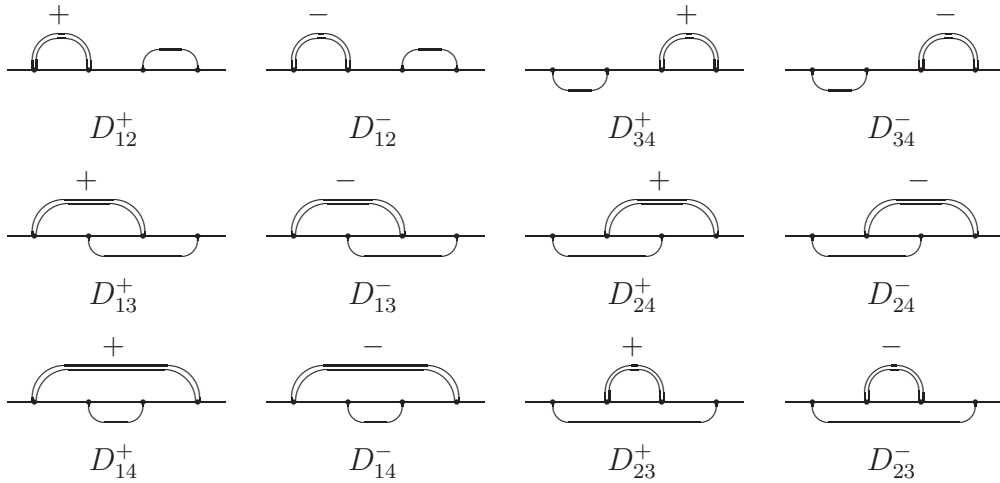

FIGURE 2. B

3.4. **5-dimensional cells.** There are 41 such cells of the first type, see Figs. 2, 3, 4, and 5. In addition, there are 15 5-dimensional cells  $\bar{A}_{ij}$  of the second type, corresponding to the cells described in the previous subsection.

 FIGURE 3.  $C$ 

 FIGURE 4.  $D$ 

The definition of cells of types  $B_i^j$  and  $C_{ij}$  is clear from their pictures, see Figs. 2 and 3. Each algebra of class  $D$  depends on a parameter  $\alpha \neq 0$  and four points  $A, B, C$  and  $D$  in  $S^1$ ; it consists of all functions  $f$  such that  $f(A) = f(B)$ ,  $f(C) = f(D)$ , and  $f'(A) = \alpha f'(B)$ . These algebras form the cells  $D_{ij}^+$  and  $D_{ij}^-$ , where the index  $\pm$  indicates the sign of  $\alpha$ , and the indices  $i < j$  are the numbers of the points  $A$  and  $B$  among all four points of the support.

Every algebra of class  $E$  depends on one point  $(\alpha : \beta : \gamma) \in \mathbb{R}P^2$ ,  $\alpha \cdot \beta \cdot \gamma \neq 0$ , and on three points  $A < B < C \in (0, 2\pi]$ . Namely, the algebra  $E((\alpha : \beta : \gamma); A, B, C)$  consists of all functions  $f$  such that  $f(A) = f(B) = f(C)$  and  $\alpha f'(A) + \beta f'(B) + \gamma f'(C) = 0$ . Such an algebra belongs to the cell  $E_+$  if  $C < 2\pi$  and all coefficients  $\alpha, \beta, \gamma$  have the same sign; it belongs to the

FIGURE 5.  $E_+$ ,  $E_1$ ,  $E_2$ ,  $E_3$ 

cell  $E_1$  (respectively,  $E_2$ ,  $E_3$ ) if also  $C < 2\pi$  and the sign of  $\alpha$  (respectively,  $\beta$ ,  $\gamma$ ) is different from the signs of the other two coefficients.

**3.5. 4-dimensional cells.** There are 44 four-dimensional cells of the first type in  $\overline{CD}_3(S^1)$ , see Figs. 6—13. The definitions of the subalgebras of classes  $a, b, c, d, e, g$  which form the cells with the corresponding names are clear from the pictures, see § 3.2.

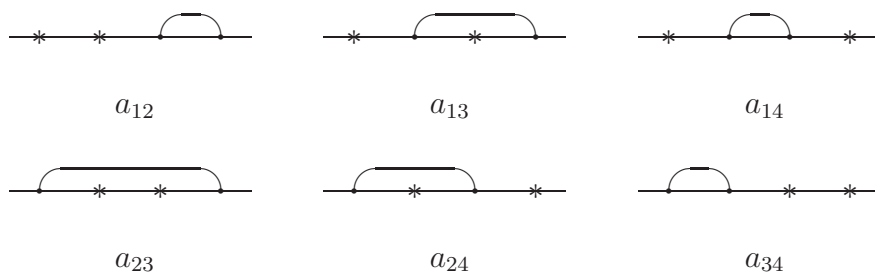
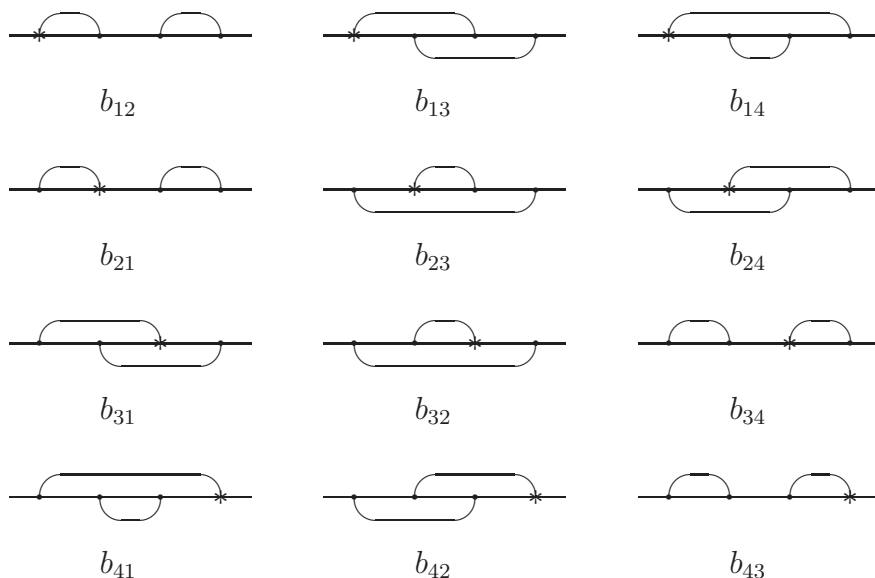
FIGURE 6.  $a$ FIGURE 7.  $b$



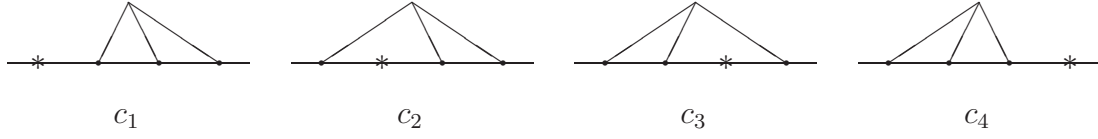

FIGURE 8. *c*

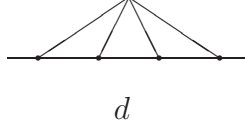

FIGURE 9. *d*

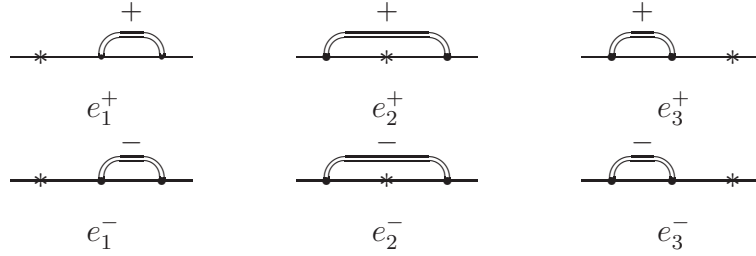

FIGURE 10. *e*

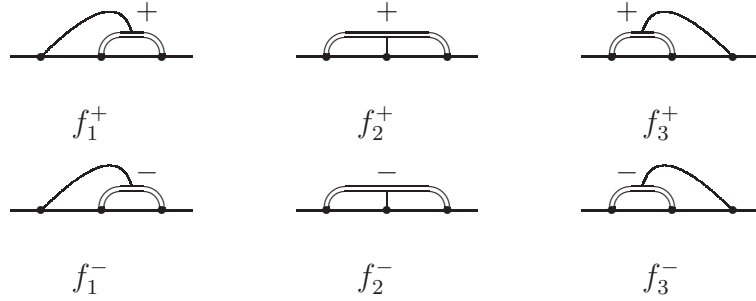

FIGURE 11. *f*

The algebras of class *f* depend on one real parameter  $\alpha \neq 0$  and three ordered points  $A, B, C$  of the support: each such algebra  $f(\alpha; A, B, C)$  consists of functions satisfying the conditions  $f(A) = f(B) = f(C)$ ,  $f'(A) = \alpha f'(B)$ . Obviously,  $f(\alpha; A, B, C) = f(\alpha^{-1}; B, A, C)$ .

The algebras of class *h* depend on two parameters  $\alpha \in \mathbb{R} \setminus 0$  and  $\beta \in \mathbb{R}$  and on two points  $A, B \in S^1$ . Namely, the algebra  $h(\alpha, \beta; A, B)$  consists of all functions  $f$  such that

$$f(A) = f(B), \quad f'(A) = \alpha f'(B), \quad f''(A) = \beta f'(B) + \alpha^2 f''(B).$$

These algebras satisfy the identity

$$h(\alpha, \beta; A, B) \equiv h(\alpha^{-1}, -\beta\alpha^{-3}; B, A).$$

They fill in two cells  $h^+$  and  $h^-$ , which are characterized by the sign of the parameter  $\alpha$ .

The algebras of class  $i$  depend on two points  $A, B \in S^1$  and one point  $(\alpha : \beta : \gamma) \in \mathbb{R}P^2$ ,  $\alpha \neq 0 \neq \gamma$ . Namely, the algebra  $i((\alpha : \beta : \gamma); A, B)$  consists of all functions  $f$  such that

$$(5) \quad f(A) = f(B), \quad f'(A) = 0, \quad \alpha f'''(A) + \beta f''(A) + \gamma f'(B) = 0.$$

Each such algebra of the first type belongs to the cell  $i_1^\pm$  or  $i_2^\pm$ , where the lower index is equal to 1 if  $A < B$  and to 2 if  $A > B$ ; the upper index  $\pm$  is the sign of the ratio  $\alpha/\gamma$ .

In addition, there are 41 four-dimensional cells  $\bar{B}_i^j, \bar{C}_{ij}, \bar{D}_{ij}^\pm, \bar{E}_*$  of the second type, corresponding to the five-dimensional cells described in Figs. 2–5.

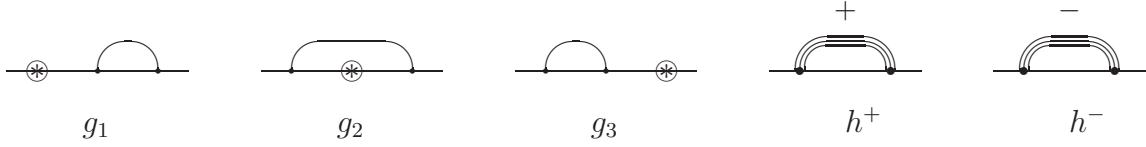

FIGURE 12.  $g$  and  $h$

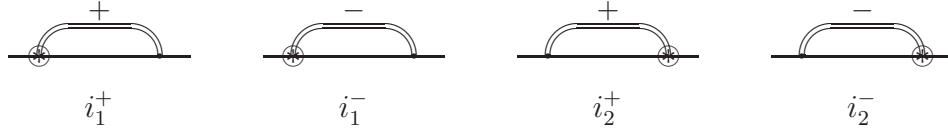

FIGURE 13.  $i$

**3.6. 3-dimensional cells.** There are 23 three-dimensional cells of the first type shown in Figs. 14–17. The definitions of the algebras of types  $U, V, W, X, Y$  are clear from their pictures.

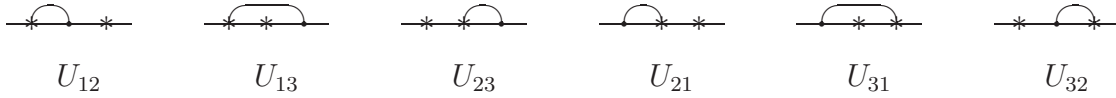

FIGURE 14.  $U$

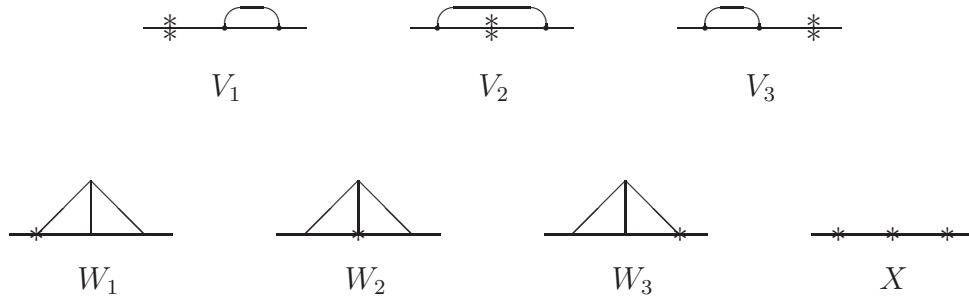

FIGURE 15.  $V, W$  and  $X$

Every algebra  $Z(\alpha; A, B)$  depends on a number  $\alpha \in \mathbb{R} \setminus \{0\}$  and two points  $A, B \in (0, 2\pi)$ . It consists of all functions  $f$  such that  $f(A) = f(B)$ ,  $f'(A) = 0$ , and  $f''(A) = \alpha f'(B)$ . These algebras form four cells  $Z_{1,2}^\pm$ , where the upper index  $+$  or  $-$  is the sign of  $\alpha$ , and the lower index is equal to 1 if  $A < B$  in  $(0, 2\pi)$  and to 2 if  $A > B$ .

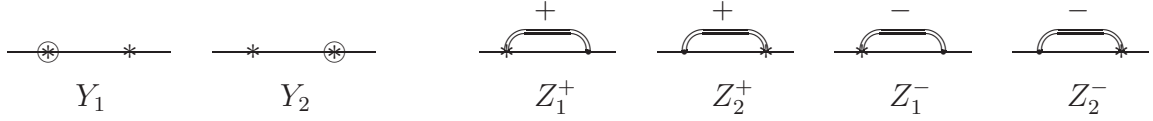

FIGURE 16.  $Y$  and  $Z$

The algebra  $T(\alpha; A, B)$  is defined for any  $\alpha \in \mathbb{R}$  and any two points  $A \neq B$  in  $(0, 2\pi)$ ; it consists of all functions  $f$  such that  $f(A) = f(B)$ ,  $f'(A) = 0$  and  $f'''(A) = \alpha f'''(B)$ . These algebras sweep out two cells  $T_1$  and  $T_2$  consisting of all algebras  $T(\alpha; A, B)$  with  $A < B$  (respectively,  $A > B$ ).



FIGURE 17.  $T$ ,  $J$  and  $S$

Each algebra  $J(\alpha, \beta; A)$  depends on two real parameters  $\alpha$  and  $\beta$  and its unique support point  $A \in S^1$ . It consists of all functions  $f$  such that

$$(6) \quad f'(A) = 0, \quad f'''(A) = 3\alpha f'''(A), \quad f^V(A) = 10\alpha f^{IV}(A) + \beta f'''(A) = 0.$$

These algebras of the first type (i.e., with  $A \neq \bullet$ ) form one cell  $J$ .

Each algebra  $S(\alpha, \beta; A)$  has the support at a single point  $A$ , depends on two parameters  $\alpha, \beta$ , and is defined by the conditions

$$(7) \quad f'(A) = 0, \quad f''(A) = 0, \quad f^V(A) = \alpha f^{IV}(A) + \beta f'''(A).$$

These algebras of the first type fill in one three-dimensional cell  $S$  with the parameters  $\alpha, \beta$  and  $A$ .

In addition, there are 44 three-dimensional cells  $\bar{a}_{12}, \dots, \bar{i}_2^-$  of the second type corresponding to the algebras shown in Figs. 6–13.

**3.7. 2-dimensional cells.** There are six two-dimensional cells of the first type shown in Figs. 18 and 19. The cell  $\Theta$  consists of subalgebras  $\Theta(\alpha; A)$ : each such subalgebra has the support at a single point  $A$ , depends on the parameter  $\alpha \in \mathbb{R}^1$ , and consists of functions  $f$  such that

$$f'(A) = 0, \quad f''(A) = 0, \quad f^{IV}(A) = \alpha f'''(A).$$

In addition, there are 23 two-dimensional cells of the second type corresponding to the algebras described in the previous subsection.

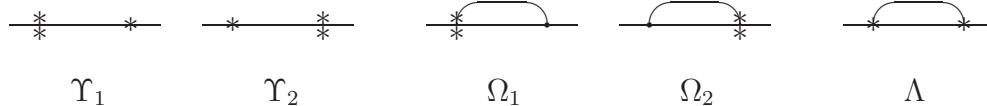
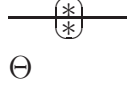
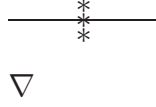

FIGURE 18.  $\Upsilon$ ,  $\Omega$  and  $\Lambda$

FIGURE 19.  $\Theta$ 

**3.8. 1- and 0-dimensional cells.** There is only one one-dimensional cell of the first type, see Fig. 20. It is swept out by algebras  $\nabla(A)$  defined by the condition  $f'(A) = f''(A) = f'''(A) = 0$ .

In addition, there are six one-dimensional cells  $\tilde{\Upsilon}_1, \dots, \Theta$  corresponding to the algebras described in the previous subsection.

FIGURE 20.  $\nabla$ 

Finally, there is the single 0-dimensional cell  $\bar{\nabla}$  defined by the condition  $f'(\bullet) = f''(\bullet) = f'''(\bullet) = 0$ .

The definitions of the algebras  $J$  and  $h$  easily imply the following two statements.

**Proposition 2.** *For any point  $A \in S^1$ , the closure of the set of all algebras  $J(\alpha, \beta; A)$  is homeomorphic to the projective plane and consists of the two-dimensional family of algebras  $J(\alpha, \beta; A)$ , the one-dimensional family of algebras  $\Theta(\alpha, A)$ , and one algebra  $\nabla(A)$ .  $\square$*

**Proposition 3.** *For any pair of points  $A$  and  $B$ , the closure of the union of all algebras  $h(\alpha, \beta; A, B)$  is homeomorphic to the projective plane and consists of two two-dimensional cells filled in by algebras of classes  $h^+$  and  $h^-$ , four intervals of classes  $Z_{1,2}^\pm$ , and three points of types  $\Omega_1, \Omega_2$  and  $\Lambda$ .  $\square$*

#### 4. COMPLETENESS OF THE LIST OF EQUILEVEL SUBALGEBRAS OF CODIMENSION 3

We need to prove that all such subalgebras in  $C^\infty(S^1, \mathbb{R})$  are described in Section 3. To do this, we separately classify all subalgebras of  $C^\infty(S^1, \mathbb{R})$  which satisfy the conclusions of Proposition 1 with  $k = 3$  and the supports consisting of 1, 2,  $\dots$ , 6 points. Later we will see that all these subalgebras indeed appear in  $\overline{CD}_3(S^1)$ .

**4.1. One-point support.** Let  $\mathcal{F}$  be an equilevel subalgebra of codimension 3 in  $C^\infty(S^1, \mathbb{R})$  with the support at the single point  $A \in S^1$ . By Proposition 1,  $\mathcal{F}$  contains the sixth power  $\mathfrak{M}_A^6$  of the maximal ideal in  $C^\infty(S^1, \mathbb{R})$  with the support at  $A$ , and also all constant functions. It cannot contain a function with  $f'(A) \neq 0$ , because in that case it would coincide with the whole  $C^\infty(S^1, \mathbb{R})$ . So,  $f'(A) = 0$  for all  $f \in \mathcal{F}$ . Then we have the following possibilities.

- 1)  $f'(A) = f''(A) = f'''(A) = 0$  for all elements of the algebra.

These are already three conditions and we get a single algebra depending only on the point  $A$ ; in our notations it is called  $\nabla(A)$ .

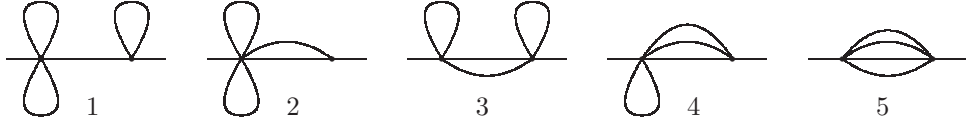

FIGURE 21. Limits of chords: two-point support

- 2)  $f'(A) = f''(A) \equiv 0$  for all  $f \in \mathcal{F}$ , but there are functions  $f \in \mathcal{F}$  with  $f'''(A) \neq 0$ . The algebra  $\mathcal{F} \cap \mathfrak{M}_A$  then defines a 2-subspace in the quotient space  $\mathfrak{M}_A^3/\mathfrak{M}_A^6$ , so it is given by one linear relation between the coefficients at  $x^3$ ,  $x^4$  and  $x^5$ : an identity of the form

$$(8) \quad \omega f^{(V)}(A) + \alpha f^{(IV)}(A) + \beta f'''(A) = 0$$

for some point  $(\omega : \alpha : \beta) \in \mathbb{R}P^2$  should be satisfied for all  $f \in \mathcal{F}$ . Any such relation does indeed provide an equilevel subalgebra of codimension 3. The case  $\omega = \alpha = 0$  was considered in the previous point 1) and contradicts the condition  $f \neq 0$  of the present point. The subalgebras satisfying the identities (8) with  $\omega \neq 0$  depend on two parameters  $\alpha/\omega$ ,  $\beta/\omega$  and the point  $A$ ; they form the cells  $S$  and  $\bar{S}$ , see §3.6. The algebras with  $\omega = 0$ ,  $\alpha \neq 0$  depend on the parameter  $\beta/\alpha$  and the point  $A$  and form the cells  $\Theta$  and  $\bar{\Theta}$ , see §3.7.

- 3)  $f'(A) \equiv 0$  for all  $f \in \mathcal{F}$ , but there exists a function  $f_0 \in \mathcal{F}$  equal to  $x^2 + \alpha x^3 + \omega x^4 + \varkappa x^5 \pmod{\mathfrak{M}_A^6}$ . We can assume that  $\omega = 0$  by subtracting  $\omega f_0^2$ . Our subalgebra defines a subspace of codimension 2 (and thus of dimension 2) in the quotient space  $\mathfrak{M}_A^2/\mathfrak{M}_A^6$ , so it is linearly spanned by  $f_0$  and  $f_0^2$  and is completely determined by the coefficients  $\alpha$  and  $\varkappa$  and the point  $A$ . All its elements therefore satisfy the conditions (6) with  $\beta = 60\varkappa$ . Thus the algebras of this kind with  $A \in (0, 2\pi)$  fill in a 3-dimensional cell called  $J$ ; the algebras with  $A = \bullet$  form the 2-dimensional cell  $\bar{J}$ .

**4.2. Algebras with two-point support.** Suppose that the support of the equilevel subalgebra  $\mathcal{F}$  of codimension 3 consists of two points  $A, B$ . The 3-chord diagrams  $\nu(t)$ ,  $t > 0$ , involved in constructing an equilevel algebra  $\mathcal{F}$  with two-point support  $\{A, B\} \subset S^1$ , tend to a graph with two vertices and three edges as  $t$  tends to  $+0$ . This graph can have only one of the five types shown in Fig. 21 (up to a reordering of the vertices in  $S^1$ ).

Let us analyze the subalgebras that can occur at the corresponding limit point  $\nu(0)$ .

1. If no chord tends to both points of the support, then one chord tends to one point and two chords tend to the other point. The first point gives us only one vanishing derivative condition. At the second point (called  $A$ ) we also necessarily have  $f' = 0$  for all  $f \in \mathcal{F}$ . Then our algebra  $\mathcal{F}$  is characterized by the image of  $\mathcal{F} \cap \mathfrak{M}_A$  under the evaluation homomorphism  $\mathfrak{M}_A \rightarrow C^\infty(S^1)/\mathfrak{M}_A^4$ , which is a subspace of codimension 1 in the two-dimensional space  $\mathfrak{M}_A^2/\mathfrak{M}_A^4$ . Let

$$(9) \quad f_0 = ax^2 + bx^3 + \dots$$

be a function whose class generates this subspace. If  $a = 0$  then we have the family of algebras  $\Upsilon(A, B)$  parametrized by two points  $A$  and  $B$  of the support and sweeping out two cells of first type characterized by the order of these two points in the interval  $(0, 2\pi)$ , see §3.7, and also two cells of second type. If  $a \neq 0$ , then  $f'''(A) = \frac{3b}{a} f''(A)$  for all  $f \in \mathcal{F}$ . The algebras  $\mathcal{F}$  of this kind depend on the coefficient  $\frac{b}{a}$  and the points  $A$

and  $B$ ; they form the 3-dimensional cells  $Y_1$  and  $Y_2$ , see §3.6, and also 2-dimensional cells  $\bar{Y}_1$  and  $\bar{Y}_2$ .

2. If the limit graph has the vertices  $A$  and  $B$  of valence 5 and 1, then we immediately get two relations  $f(A) = f(B)$  and  $f'(A)$ , and the third relation should distinguish a 2-subspace in the 3-dimensional space  $\mathfrak{M}_A^2/\mathfrak{M}_A^5$ . If  $f''(A) = 0$  for all functions of our algebra, then we have again an algebra of the class  $\Upsilon$ . Otherwise,  $\mathcal{F}$  contains a function  $f_0 = x^2 + ax^3 + bx^4$  and then our 2-subspace is generated by the classes of functions  $f_0$  and  $f_0^2$ , in particular it is completely characterized by the number  $a \equiv \frac{f_0'''(A)}{3f_0''(A)}$ . So we have an algebra of the class  $T$ , see Fig. 17.
3. The third graph of Fig. 21 immediately gives three conditions  $f(A) = f(B)$ ,  $f'(A) = 0 = f'(B)$ , and we have an algebra of the class  $\Lambda$  depending on only two points  $A$  and  $B$ .
4. The fourth graph assumes the two conditions  $f(A) = f(B)$  and  $f'(A) = 0$  for all elements of our algebra. The third condition should distinguish a two-subspace in the three-dimensional space  $(\mathfrak{M}_A^2 \times \mathfrak{M}_B)/(\mathfrak{M}_A^4 \times \mathfrak{M}_B^2)$ . If we have  $f'(B) = 0$  for all functions  $f \in \mathcal{F}$ , then  $\mathcal{F}$  is again of the class  $\Lambda$ . If  $f''(A) = 0$  for all  $f \in \mathcal{F}$ , then  $\mathcal{F}$  is of the class  $\Omega$ . In the remaining cases we have an algebra of the type  $i$ , see Fig. 13 in §3.5.
5. In the case of the fifth graph of Fig. 21 we have one condition  $f(A) = f(B)$ , and our algebra defines a two-dimensional subspace in the four-dimensional space  $\mathfrak{M}(A) \times \mathfrak{M}(B)/\mathfrak{M}^3(A) \times \mathfrak{M}^3(B)$ . If  $f'(A) = f'(B) = 0$  for all functions of the algebra, then it is of class  $\Lambda$ . If the first and the second derivatives of all  $f \in \mathcal{F}$  vanish at one endpoint (say,  $A$ ), then  $\mathcal{F}$  is an algebra of type  $\Omega$ . If only the first derivative vanishes identically at  $A$ , but the first derivative at  $B$  and the second derivative at  $A$  generally do not, then we again have a subalgebra of type  $i$ . Finally, suppose that there is a function  $f_0$  in our algebra with

$$(10) \quad f_0(A) = f_0(B) = 0, \quad f_0'(A) \neq 0 \neq f_0'(B).$$

Norming  $f_0'(B)$ , subtracting  $\frac{f_0''(B)}{2}f_0^2(B)$  and reducing modulo  $\mathfrak{M}_A^3 \times \mathfrak{M}_B^3$ , we can assume that  $f_0 \equiv \tilde{\varphi}$  in the local coordinate  $\tilde{\varphi} \equiv \varphi - \varphi(B)$  in a neighborhood of  $B$  and  $f_0 \equiv \alpha\hat{\varphi} + \frac{1}{2}\beta\hat{\varphi}^2$  in the coordinate  $\hat{\varphi} \equiv \varphi - \varphi(A)$  near  $A$ . These numbers  $\alpha$  and  $\beta$  completely characterize our subalgebra which in this case is of class  $h$ , see §3.5.

**Remark 2.** By the last construction, every function  $f_0$  satisfying the conditions (10) belongs to a single algebra of class  $h$  with support at the points  $A$  and  $B$ .

**4.3. Algebras with three-point support.** There can be eight types of graphs with three vertices describing the limit points  $\nu(0)$  of families of three-chord diagrams, see Fig. 22. The corresponding possible algebras of codimension 3 can be analyzed as in the previous subsection and give us the following classes of algebras.

1:  $X$ . 2:  $V$  and  $g$ . 3:  $U$ . 4:  $U$  and  $e$ . 5 and 6:  $W$ . 7:  $W$  and  $f$ . 8:  $W$ ,  $f$  and  $E$ .

**4.4. Algebras with four-point support.** There can be five types of limit graphs with four vertices, see Fig. 23.

They can provide the algebras of the following types. 1:  $a$ . 2:  $b$ . 3:  $c$ . 4:  $d$ . 5:  $b$  and  $D$ .

Also, there can be only two types of limit graphs with five vertices and only one type of limit graphs with six vertices, see Fig. 24. They give the algebras of classes  $B$ ,  $C$ , and  $A$ , respectively.

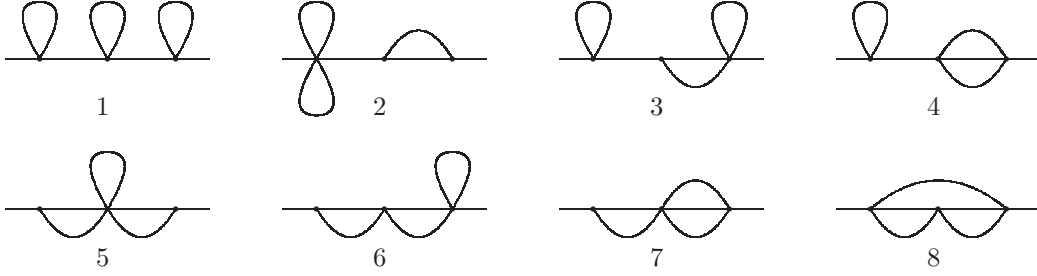

FIGURE 22. Limits of chord diagrams: three-point support

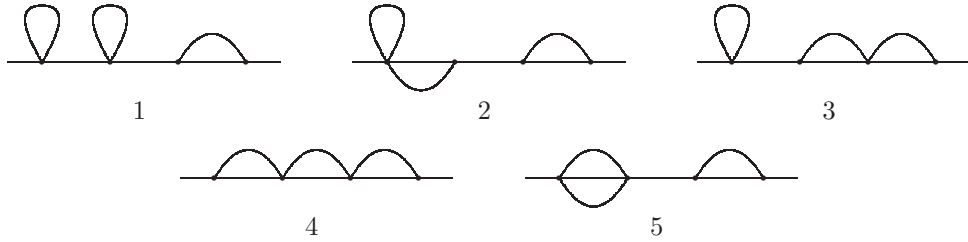

FIGURE 23. Limits of chord diagrams: four-point support



FIGURE 24. Limits of chord diagrams: five and six-point supports

The incidence coefficients of the boundary maps, which will be listed in §5, prove that all these algebras do indeed arise as results of chains of degenerations of 3-chord diagrams, and so define certain points of the space  $\overline{CD}_3(S^1)$ .

**4.5. Proof of Theorem 4.** Above we represented the semialgebraic variety  $\overline{CD}_3(S^1)$  as the union of non-intersecting open cells. The constructions of all these cells immediately imply that for each  $i$ -dimensional cell  $\beta_\alpha^i$  of this list there is a parametrization

$$(11) \quad \varphi_\alpha^i : D^i \rightarrow \overline{CD}_3(S^1) \subset G_{\dim \mathcal{L}-k}(\mathcal{L}),$$

where  $D^i$  is the open unit ball in  $\mathbb{R}^i$ , and  $\varphi_\alpha^i$  is a regular algebraic map that sends  $D^i$  diffeomorphically onto  $\beta_\alpha^i$ .

**Lemma 1.** *For each of the cells  $\beta_\alpha^i$  described in §3 there exists a continuous map  $\chi : \overline{D}^i \rightarrow \overline{CD}_3(S^1)$  of a closed ball of dimension  $i$ , which sends the inner part of this ball diffeomorphically to our cell.*

*Proof.* Let  $K^i \subset D^i \times \overline{CD}_3(S^1)$  be the graph of the map (11). By construction it is a semialgebraic subvariety in the algebraic manifold  $\mathbb{R}^i \times G_{\dim \mathcal{L}-k}(\mathcal{L})$ . Define the algebraic subvariety  $\Sigma \subset \mathbb{R}^i \times G_{\dim \mathcal{L}-k}(\mathcal{L})$  as the union of the algebraic closure of the variety  $K^i$  and the product  $\partial D^i \times G_{\dim \mathcal{L}-k}(\mathcal{L})$ . Let  $\psi : \Xi \rightarrow \mathbb{R}^i \times G_{\dim \mathcal{L}-k}(\mathcal{L})$  be a resolution of singularities of  $\Sigma$  (in the sense of [5], [6]), which is a diffeomorphism over the regular points of  $K^i$ . Let  $\tilde{K}^i \subset \Xi$  be the (topological) closure of the set  $\psi^{-1}(K^i)$ . The manifold  $\psi^{-1}(K^i)$  can approach the added points

of the set  $\tilde{K}^i \setminus \psi^{-1}(K^i)$  from different sides, so define the topological space  $\hat{K}^i$  as the set of pairs  $(x \in \tilde{K}^i, \text{a local connected component of } \psi^{-1}(K^i) \text{ near } x)$  with the topology in which the small neighborhoods  $\psi^{-1}(K^i)$  of such a point contain only the points of the corresponding component and the points of  $\hat{K}^i$  characterized by that component. By construction,  $\hat{K}^i$  is a smooth manifold with corners, whose interior part is diffeomorphic to the open ball  $D^i$ . Moreover, the lifting of the norm function from the space  $\mathbb{R}^i \supset D^i$  has in it the standard form: for any point of the corner near which the manifold  $\hat{K}^i$  is distinguished by the conditions  $z_1 \geq 0, \dots, z_p \geq 0$  in some local coordinates, this lifted function has the form  $1 - \theta(z_1, \dots, z_i) \cdot z_1^{c_1} \cdot \dots \cdot z_p^{c_p}$  for some smooth function  $\theta > 0$  and some natural numbers  $c_1, \dots, c_p$ . Then the boundary set of  $\hat{K}^i$  is homeomorphic to the standard  $(i-1)$ -dimensional sphere: indeed, any sufficiently neighboring level set of the lifted norm function contracts homeomorphically on it by the corresponding real Clemens structure, but such level sets are just the homeomorphic preimages of concentric spheres in  $\mathbb{R}^i$ . So the whole variety  $\hat{K}^i$  is homeomorphic to the standard closed  $i$ -dimensional ball. Its desired map to  $\overline{CD}_3(S^1)$  is the composition of the resolution map  $\psi$  and the obvious projection  $D^i \times \overline{CD}_3(S^1) \rightarrow \overline{CD}_3(S^1)$ .  $\square$

To check all properties of a CW-complex it remains to prove that for any of our cells  $\beta_\alpha^i$ , its boundary set  $\tilde{\beta}_\alpha^i \setminus \beta_\alpha^i$  belongs to the union of cells of lower dimensions. This follows easily from the constructions of these cells.  $\square$

## 5. BOUNDARY OPERATORS MOD 2

5.1. Consider the chain complex with coefficients in  $\mathbb{Z}_2$  defined by our cell decomposition of the variety  $\overline{CD}_3(S^1)$ . Most of the incidence coefficients that make up the formulas for its boundary operators  $C_i \rightarrow C_{i-1}$  are obvious: in particular, they are so if the incidence of cells is induced by the collision of only two points of the supports of the subalgebras from the larger cell (see for example the degeneration of cells of type  $A_{ij}$  into cells  $B_k^l$  or  $C_{kl}$ ), or by the boundary values of the numerical conditions on the derivatives at a fixed configuration (as in the case of the cells  $D_{ij}^\pm$  approaching the cells  $b_{ij}$  and  $b_{ji}$ ). The most difficult adjacencies are related with the simultaneous collision of many points: the asymptotics of these collisions impose some conditions on the derivatives of the functions from the algebras of the limit cells. We give here two illustrations.

### Approximation of a 5-dimensional cell of type $E$ by the 6-dimensional cell $A_{41}$ .

This adjacency is defined by the simultaneous contraction of the segments  $[A, B]$ ,  $[CD]$  and  $[EF]$  in the lower part of Fig. 25. Let the lengths of these segments be equal to  $\alpha\tau$ ,  $\beta\tau$  and  $\gamma\tau$  respectively (up to the higher degree terms in  $\tau$ ), where  $\tau \rightarrow +0$  is the parameter of the contraction. Let  $X, Y$  and  $Z$  be the respective limit points of these segments. At every moment of the contraction, all functions of the corresponding algebra satisfy the identity

$$f(F(\tau)) - f(E(\tau)) = (f(D(\tau)) - f(C(\tau))) + (f(B(\tau)) - f(A(\tau))),$$

which asymptotically implies  $\gamma f'(Z) = \beta f'(Y) + \alpha f'(X)$  for all functions  $f$  of the limit algebra. Here  $\alpha, \beta$  and  $\gamma$  are arbitrary positive coefficients for our choice, so the limit subalgebra is the algebra  $E((\alpha : \beta : -\gamma); X, Y, Z)$  of class  $E_3$ .

**Incidence coefficients**  $[a_{23}, S]$ . A typical function of the algebra  $a_{23}$  with four points of the support approaching the collision of all of them looks as shown in the top part of Fig. 26.



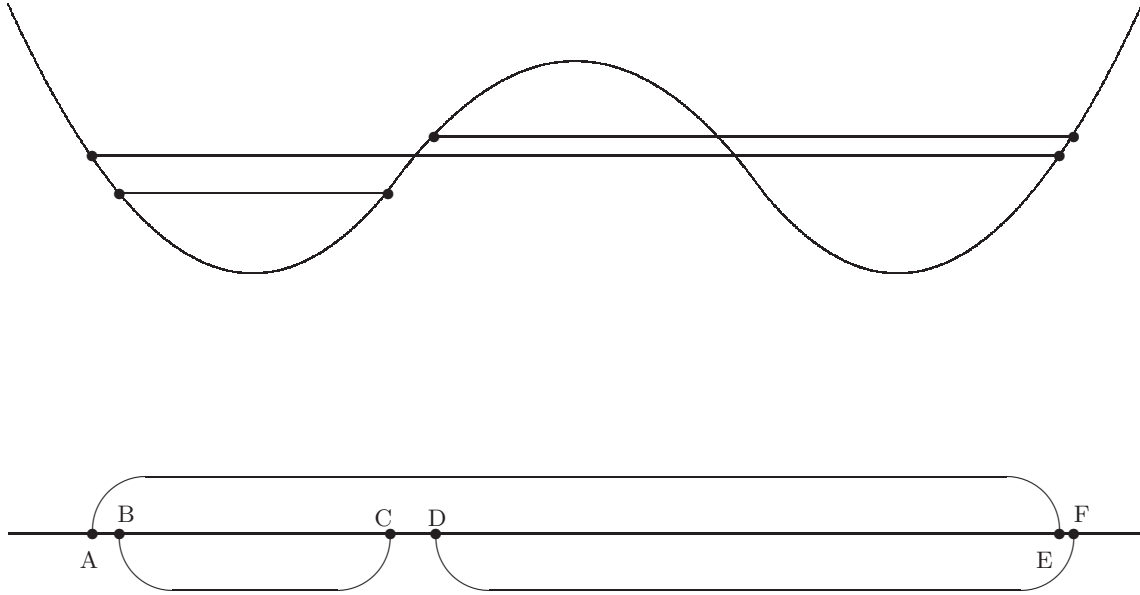

FIGURE 25. Incidence coefficient  $[A_{41}, E_3]$

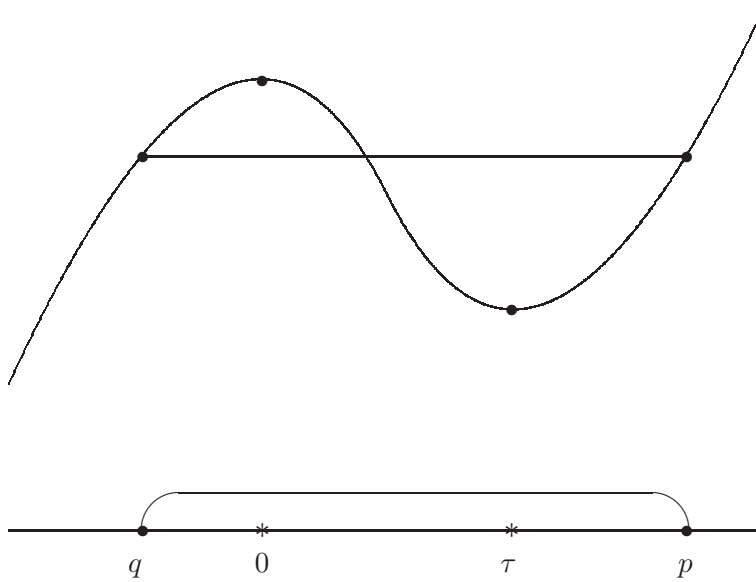

FIGURE 26. Incidence coefficients  $[a_{23}, S]$

Since the picture is translation invariant, we will assume that the left critical point of the  $a_{23}$  configuration is fixed (let us call it  $O$ ), and the other three points tend to it; let  $x$  be the local coordinate in  $S^1$  with center at  $O$ . Then all intermediate algebras defined by these configurations satisfy the condition  $f'(O) \equiv 0$ . Take the coordinate  $\tau$  of the other critical point as the parameter of the contraction. Let the coordinates  $p$  and  $q$  of the remaining two points of the configuration depend on  $\tau$  as

$$(12) \quad p(\tau) = \alpha\tau + \beta\tau^2 + \gamma\tau^3 + \dots,$$

$$(13) \quad q(\tau) = \lambda\tau + \mu\tau^2 + \varkappa\tau^3 + \dots,$$

where  $\alpha \geq 1$ ,  $\lambda \leq 0$ . At the end of the contraction, we have to obtain an algebra of type  $S$ , i.e. defined by the conditions  $f'(O) = 0$ ,  $f''(O) = 0$ , and an arbitrary prescribed linear relation between the values of  $f'''(O)$ ,  $f^{IV}(O)$  and  $f^V(O)$  for all its elements  $f$ . According to Proposition 1, this limit algebra is completely characterized by its intersection with the space  $\mathbb{R}^4$  of polynomials

$$(14) \quad ax^2 + bx^3 + cx^4 + dx^5,$$

which is transversal to  $\mathfrak{M}_O^6$  in the space  $\mathfrak{M}_O^2$ . Each algebra corresponding to a positive value of the parameter  $\tau$  intersects this space along the set of polynomials (14) which satisfy two linear conditions  $f(p) = f(q)$  and  $f'(\tau) = 0$ , i.e.,

$$(15) \quad a(p+q) + b(p^2 + pq + q^2) + c(p^3 + p^2q + pq^2 + q^3) + d(p^4 + p^3q + p^2q^2 + pq^3 + p^4) = 0,$$

$$(16) \quad 2a + 3b\tau + 4c\tau^2 + 5d\tau^3 = 0.$$

Both hyperplanes in  $\mathbb{R}^4$  defined by these conditions tend to the hyperplane  $\{a = 0\}$ , so to compute the limit position of their intersection (which should be a hyperplane of this hyperplane) we express the variable  $a$  from one of these equations and substitute it into the other:

$$(17) \quad b(2(p^2 + pq + q^2) - 3(p+q)\tau) + c(2(p^3 + p^2q + pq^2 + q^3) - 4(p+q)\tau^2) + \\ + d(2(p^4 + p^3q + p^2q^2 + pq^3 + p^4) - 5(p+q)\tau^3) = 0$$

Substituting the expressions (12), (13) for  $p$  and  $q$  into this equation, we obtain a linear equation on variables  $b$ ,  $c$ , and  $d$ , whose coefficients are certain polynomials in  $\tau$ . The lowest degree of the monomials of this polynomial at  $b$  (respectively,  $c$ ,  $d$ ) is equal to 2 (respectively, 3, 4). Therefore, to define a homogeneous limit condition on these coordinates (in which the asymptotics of the coefficients at  $b$ ,  $c$  and  $d$  will be of the same order), the monomials of degree 2 and 3 of the polynomial at  $b$  and the monomial of degree 3 at  $c$  should vanish. These conditions give us three equations on the coefficients  $\alpha$ ,  $\beta$ ,  $\lambda$  and  $\mu$ :

$$\begin{aligned} 2(\alpha^2 + \alpha\lambda + \lambda^2) - 3(\alpha + \lambda) &= 0, \\ 2(2\alpha\beta + \alpha\mu + \lambda\beta + 2\lambda\mu) - 3(\beta + \mu) &= 0, \\ 2(\alpha^3 + \alpha^2\lambda + \alpha\lambda^2 + \lambda^3) - 4(\alpha + \lambda) &= 0. \end{aligned}$$

This system is equivalent to the system

$$(18) \quad \alpha = \frac{\sqrt{3} + 1}{2}, \quad \lambda = \frac{-\sqrt{3} + 1}{2}, \quad \beta = \mu.$$

The coefficients of the degree 4 monomials at the variables  $b$ ,  $c$ , and  $d$  in (17) are then  $\sqrt{3}(\gamma + \varkappa) + 6\beta^2$ ,  $4\beta$ , and  $\frac{1}{2}$ , respectively. The relative values of these coefficients defined by appropriate values of  $\beta$ ,  $\gamma$  and  $\varkappa$  realize arbitrary points of  $\mathbb{R}P^2$ . This gives incidence coefficient  $[a_{23}, S] = 1$ .

**Remark 3.** The same calculation can also be applied to the cells of classes  $a_{13}$  and  $a_{24}$  instead of  $a_{23}$  and gives us the same values (18) for  $\alpha$  and  $\lambda$ . They imply the inequalities  $p > \tau$  and  $q < 0$ , which contradict the configurations of these classes. On the other hand, the contraction of supports of classes  $a_{12}$ ,  $a_{14}$  and  $a_{34}$  necessarily gives us limit functions satisfying the condition  $f'(O) = f''(O) = f'''(O) = 0$  which is not valid for almost all functions of an algebra of the class  $S$ . Thus the incidence coefficients  $[a_{ij}, S]$  are equal to 0 for all  $(i, j) \neq (2, 3)$ .

The similar (or simpler) considerations prove all formulas for the boundary operators  $\partial_i : C_i \rightarrow C_{i-1}$ ,  $i = 1, 2, 3, 4, 5, 6$ , of the cell complex. These formulas are listed in the following subsections 5.2, 5.3, 5.4, 5.5, 5.6, and 5.7, respectively.

5.2.  $\partial_1 : C_1 \rightarrow C_0$ . The complex  $\overline{CD}_3(S^1)$  contains only one 0-dimensional cell, so the boundary map  $C_1 \rightarrow C_0$  is trivial.

5.3.  $\partial_2 : C_2 \rightarrow C_1$ .

**Proposition 4.** *The boundary map  $C_2 \rightarrow C_1$  of the cell complex of the variety  $\overline{CD}_3(S^1)$  with coefficients in  $\mathbb{Z}_2$  defined by the cell decomposition described above is given by the formulas (19)–(47):*

$$\begin{aligned}
(19) \quad \partial(\Upsilon_1) &= \nabla + \bar{\Upsilon}_1 + \bar{\Upsilon}_2 \\
(20) \quad \partial(\Upsilon_2) &= \nabla + \bar{\Upsilon}_2 + \bar{\Upsilon}_1 \\
(21) \quad \partial(\Omega_1) &= \nabla + \bar{\Omega}_1 + \bar{\Omega}_2 \\
(22) \quad \partial(\Omega_2) &= \nabla + \bar{\Omega}_2 + \bar{\Omega}_1 \\
(23) \quad \partial(\Lambda) &= \nabla \\
(24) \quad \partial(\Theta) &= 0 \\
(25) \quad \partial(\bar{U}_{12}) &= \bar{\Upsilon}_1 + \bar{\Lambda} + \bar{\Omega}_2 + \bar{\Theta} \\
(26) \quad \partial(\bar{U}_{13}) &= \bar{\Omega}_1 + \bar{\Lambda} + \bar{\Upsilon}_2 + \bar{\Theta} \\
(27) \quad \partial(\bar{U}_{21}) &= \bar{\Upsilon}_1 + \bar{\Omega}_2 + \bar{\Lambda} + \bar{\Theta} \\
(28) \quad \partial(\bar{U}_{23}) &= \bar{\Omega}_1 + \bar{\Upsilon}_2 + \bar{\Lambda} + \bar{\Theta} \\
(29) \quad \partial(\bar{U}_{31}) &= \bar{\Lambda} + \bar{\Omega}_2 + \bar{\Upsilon}_2 + \bar{\Theta} \\
(30) \quad \partial(\bar{U}_{32}) &= \bar{\Lambda} + \bar{\Upsilon}_2 + \bar{\Omega}_2 + \bar{\Theta} \\
(31) \quad \partial(\bar{V}_1) &= \bar{\Omega}_1 + \bar{\Upsilon}_1 + \bar{\Omega}_2 \\
(32) \quad \partial(\bar{V}_2) &= \bar{\Omega}_1 + \bar{\Omega}_2 + \bar{\Upsilon}_1 \\
(33) \quad \partial(\bar{V}_3) &= \bar{\Upsilon}_2 \\
(34) \quad \partial(\bar{W}_1) &= \bar{\Omega}_1 + \bar{\Lambda} + \bar{\Omega}_2 \\
(35) \quad \partial(\bar{W}_2) &= \bar{\Omega}_1 + \bar{\Omega}_2 + \bar{\Lambda} \\
(36) \quad \partial(\bar{W}_3) &= \bar{\Lambda} \\
(37) \quad \partial(\bar{X}) &= \bar{\Upsilon}_1 \\
(38) \quad \partial(\bar{Y}_1) &= 0 \\
(39) \quad \partial(\bar{Y}_2) &= 0 \\
(40) \quad \partial(\bar{Z}_1^+) &= \bar{\Omega}_1 + \bar{\Lambda} + \bar{\Theta} \\
(41) \quad \partial(\bar{Z}_2^+) &= \bar{\Omega}_2 + \bar{\Lambda} + \bar{\Theta} \\
(42) \quad \partial(\bar{Z}_1^-) &= \bar{\Omega}_1 + \bar{\Lambda} + \bar{\Theta} \\
(43) \quad \partial(\bar{Z}_2^-) &= \bar{\Omega}_2 + \bar{\Lambda} + \bar{\Theta} \\
(44) \quad \partial(\bar{T}_1) &= 0 \\
(45) \quad \partial(\bar{T}_2) &= 0 \\
(46) \quad \partial(\bar{J}) &= 0 \\
(47) \quad \partial(\bar{S}) &= 0
\end{aligned}$$

The matrix of this operator (with non-trivial elements indicated by crosses) is given on page 36.

**Corollary 2.** *The kernel of this operator  $\partial_2 : C_2 \rightarrow C_1$  is generated by 23 linearly independent cycles (48)–(70):*

- (48)  $\Upsilon_1 + \Upsilon_2$
- (49)  $\Omega_1 + \Omega_2$
- (50)  $\Theta$
- (51)  $\bar{U}_{12} + \bar{U}_{21}$
- (52)  $\bar{U}_{13} + \bar{U}_{23}$
- (53)  $\bar{U}_{31} + \bar{U}_{32}$
- (54)  $\bar{V}_1 + \bar{V}_2$
- (55)  $\bar{W}_1 + \bar{W}_2$
- (56)  $\bar{Y}_1$
- (57)  $\bar{Y}_2$
- (58)  $\bar{Z}_1^+ + \bar{Z}_1^-$
- (59)  $\bar{Z}_2^+ + \bar{Z}_2^-$
- (60)  $\bar{T}_1$
- (61)  $\bar{T}_2$
- (62)  $\bar{J}$
- (63)  $\bar{S}$
- (64)  $\bar{U}_{12} + \bar{X} + \bar{Z}_2^+$
- (65)  $\bar{U}_{31} + \bar{V}_3 + \bar{Z}_2^+$
- (66)  $\bar{U}_{13} + \bar{V}_3 + \bar{Z}_1^+$
- (67)  $\Upsilon_1 + \bar{X} + \bar{V}_3 + \Lambda$
- (68)  $\bar{V}_1 + \Omega_1 + \Lambda + \bar{X}$
- (69)  $\bar{Z}_1^+ + \bar{Z}_2^+ + \bar{W}_1 + \bar{W}_3$
- (70)  $\bar{\Omega}_1 + \bar{\Lambda} + \bar{Z}_1^+ + \bar{Z}_2^+$

5.4.  $\partial_3 : C_3 \rightarrow C_2$ .

**Proposition 5.** *The boundary map  $C_3 \rightarrow C_2$  of the cell complex of the variety  $\overline{CD}_3(S^1)$  with coefficients in  $\mathbb{Z}_2$  is given (in the terms of both the generators of  $C_2$  described in §3.7 and the generators (48)–(70) of the subgroup  $\ker \partial_2 \subset C_2$ ) by the formulas (71)–(137):*

$$\begin{aligned}
(71) \quad \partial(J) &= 0 \\
(72) \quad \partial(S) &= 0 \\
(73) \quad \partial(T_1) &= \Theta + \bar{T}_1 + \bar{T}_2 = (50) + (60) + (61) \\
(74) \quad \partial(T_2) &= \Theta + \bar{T}_2 + \bar{T}_1 = (50) + (60) + (61) \\
(75) \quad \partial(U_{12}) &= \Upsilon_1 + \Lambda + \bar{U}_{12} + \bar{U}_{31} = (64) + (65) + (67) \\
(76) \quad \partial(U_{13}) &= \Omega_1 + \Lambda + \Theta + \bar{U}_{13} + \bar{U}_{32} = \\
&= (50) + (53) + (65) + (66) + (70) \\
(77) \quad \partial(U_{21}) &= \Upsilon_1 + \Omega_2 + \bar{U}_{21} + \bar{U}_{13} = \\
&= (49) + (51) + (64) + (66) + (67) + (70) \\
(78) \quad \partial(U_{23}) &= \Omega_1 + \Upsilon_2 + \bar{U}_{23} + \bar{U}_{12} = \\
&= (48) + (52) + (64) + (66) + (67) + (70) \\
(79) \quad \partial(U_{31}) &= \Lambda + \Omega_2 + \Theta + \bar{U}_{31} + \bar{U}_{23} = \\
&= (49) + (50) + (52) + (65) + (66) + (70) \\
(80) \quad \partial(U_{32}) &= \Lambda + \Upsilon_2 + \bar{U}_{32} + \bar{U}_{21} = \\
&= (48) + (51) + (53) + (64) + (65) + (67) \\
(81) \quad \partial(V_1) &= \Omega_1 + \Upsilon_1 + \bar{V}_1 + \bar{V}_3 = (67) + (68) \\
(82) \quad \partial(V_2) &= \Omega_1 + \Omega_2 + \bar{V}_2 + \bar{V}_1 = (49) + (54) \\
(83) \quad \partial(V_3) &= \Upsilon_2 + \Omega_2 + \bar{V}_3 + \bar{V}_2 = (48) + (49) + (54) + (67) + (68) \\
(84) \quad \partial(W_1) &= \Omega_1 + \Lambda + \bar{W}_1 + \bar{W}_3 = (69) + (70) \\
(85) \quad \partial(W_2) &= \Omega_1 + \Omega_2 + \bar{W}_2 + \bar{W}_1 = (49) + (55) \\
(86) \quad \partial(W_3) &= \Lambda + \Omega_2 + \bar{W}_3 + \bar{W}_2 = (49) + (55) + (69) + (70) \\
(87) \quad \partial(X) &= \Upsilon_1 + \Upsilon_2 = (48) \\
(88) \quad \partial(Y_1) &= \Theta + \bar{Y}_1 + \bar{Y}_2 = (50) + (56) + (57) \\
(89) \quad \partial(Y_2) &= \Theta + \bar{Y}_2 + \bar{Y}_1 = (50) + (56) + (57) \\
(90) \quad \partial(Z_1^+) &= \Omega_1 + \Lambda + \bar{Z}_1^+ + \bar{Z}_2^+ = (70) \\
(91) \quad \partial(Z_2^+) &= \Omega_2 + \Lambda + \Theta + \bar{Z}_2^+ + \bar{Z}_1^+ = (49) + (50) + (70) \\
(92) \quad \partial(Z_1^-) &= \Omega_1 + \Lambda + \Theta + \bar{Z}_1^- + \bar{Z}_2^- = (50) + (58) + (59) + (70) \\
(93) \quad \partial(Z_2^-) &= \Omega_2 + \Lambda + \bar{Z}_2^- + \bar{Z}_1^- = (49) + (58) + (59) + (70) \\
(94) \quad \partial(\bar{a}_{12}) &= \bar{V}_1 + \bar{U}_{23} + \bar{X} + \bar{U}_{32} + \bar{S} = \\
&= (52) + (53) + (63) + (65) + (66) + (68) + (70) \\
(95) \quad \partial(\bar{a}_{13}) &= \bar{U}_{13} + \bar{U}_{23} + \bar{U}_{32} + \bar{U}_{31} = (52) + (53) \\
(96) \quad \partial(\bar{a}_{14}) &= \bar{U}_{12} + \bar{X} + \bar{U}_{32} + \bar{V}_3 + \bar{S} = \\
&= (53) + (63) + (64) + (65)
\end{aligned}$$

$$\begin{aligned}
(97) \quad \partial(\bar{a}_{23}) &= \bar{U}_{13} + \bar{V}_2 + \bar{U}_{31} + \bar{X} + \bar{S} = \\
&= (54) + (63) + (65) + (66) + (68) + (70) \\
(98) \quad \partial(\bar{a}_{24}) &= \bar{U}_{12} + \bar{Y}_1 + \bar{U}_{21} + \bar{U}_{31} + \bar{U}_{32} + \bar{Y}_2 = \\
&= (51) + (53) + (56) + (57) \\
(99) \quad \partial(\bar{a}_{34}) &= \bar{X} + \bar{U}_{21} + \bar{V}_3 + \bar{U}_{31} + \bar{S} = \\
&= (51) + (63) + (64) + (65) \\
(100) \quad \partial(\bar{b}_{12}) &= \bar{V}_1 + \bar{W}_1 + \bar{U}_{12} + \bar{W}_3 + \bar{Z}_2^+ = \\
&= (64) + (68) + (69) + (70) \\
(101) \quad \partial(\bar{b}_{13}) &= \bar{W}_1 + \bar{Z}_1^+ + \bar{W}_3 + \bar{Z}_2^- + \bar{T}_2 = (59) + (61) + (69) \\
(102) \quad \partial(\bar{b}_{14}) &= \bar{U}_{13} + \bar{Z}_1^- + \bar{V}_3 = (58) + (66) \\
(103) \quad \partial(\bar{b}_{21}) &= \bar{V}_1 + \bar{W}_2 + \bar{U}_{21} + \bar{W}_1 + \bar{Z}_1^- = \\
&= (51) + (55) + (58) + (64) + (68) + (70) \\
(104) \quad \partial(\bar{b}_{23}) &= \bar{W}_1 + \bar{V}_2 + \bar{W}_2 + \bar{Z}_1^+ + \bar{U}_{12} = \\
&= (54) + (55) + (64) + (68) + (70) \\
(105) \quad \partial(\bar{b}_{24}) &= \bar{Z}_1^- + \bar{T}_1 + \bar{Z}_1^+ = (58) + (60) \\
(106) \quad \partial(\bar{b}_{31}) &= \bar{W}_3 + \bar{Z}_2^+ + \bar{T}_2 + \bar{W}_2 + \bar{Z}_1^- = (55) + (58) + (61) + (69) \\
(107) \quad \partial(\bar{b}_{32}) &= \bar{W}_2 + \bar{V}_2 + \bar{W}_3 + \bar{Z}_2^- + \bar{U}_{21} = \\
&= (51) + (54) + (55) + (59) + (64) + (68) + (69) + (70) \\
(108) \quad \partial(\bar{b}_{34}) &= \bar{U}_{23} + \bar{V}_3 + \bar{Z}_1^+ = (52) + (66) \\
(109) \quad \partial(\bar{b}_{41}) &= \bar{U}_{31} + \bar{Z}_2^+ + \bar{V}_3 = (65) \\
(110) \quad \partial(\bar{b}_{42}) &= \bar{Z}_2^- + \bar{Z}_2^+ + \bar{T}_2 = (59) + (61) \\
(111) \quad \partial(\bar{b}_{43}) &= \bar{U}_{32} + \bar{V}_3 + \bar{Z}_2^- = (53) + (59) + (65) \\
(112) \quad \partial(\bar{c}_1) &= \bar{W}_1 + \bar{U}_{23} + \bar{U}_{32} + \bar{W}_3 + \bar{T}_2 = \\
&= (52) + (53) + (61) + (65) + (66) + (69) \\
(113) \quad \partial(\bar{c}_2) &= \bar{W}_1 + \bar{W}_2 + \bar{U}_{31} + \bar{T}_1 + \bar{U}_{32} = (53) + (55) + (60) \\
(114) \quad \partial(\bar{c}_3) &= \bar{U}_{13} + \bar{W}_2 + \bar{W}_3 + \bar{T}_2 + \bar{U}_{31} = \\
&= (55) + (61) + (65) + (66) + (69) \\
(115) \quad \partial(\bar{c}_4) &= \bar{U}_{12} + \bar{U}_{21} + \bar{T}_2 = (51) + (61) \\
(116) \quad \partial(\bar{d}) &= \bar{W}_1 + \bar{W}_2 = (55) \\
(117) \quad \partial(\bar{e}_1^+) &= \bar{Z}_1^+ + \bar{U}_{23} + \bar{U}_{32} + \bar{Z}_2^- = (52) + (53) + (59) + (65) + (66) \\
(118) \quad \partial(\bar{e}_2^+) &= \bar{Z}_1^- + \bar{Z}_2^+ + \bar{U}_{13} + \bar{U}_{31} = (58) + (65) + (66) \\
(119) \quad \partial(\bar{e}_3^+) &= \bar{Z}_2^- + \bar{U}_{12} + \bar{U}_{21} + \bar{Z}_2^+ = (51) + (59) \\
(120) \quad \partial(\bar{e}_1^-) &= \bar{Z}_1^- + \bar{U}_{23} + \bar{U}_{32} + \bar{Y}_2 + \bar{Z}_2^+ + \bar{J} = \\
&= (52) + (53) + (57) + (58) + (62) + (65) + (66)
\end{aligned}$$

$$\begin{aligned}
(121) \quad \partial(\bar{e}_2^-) &= \bar{Z}_1^+ + \bar{Z}_2^- + \bar{U}_{13} + \bar{U}_{31} + \bar{J} + \bar{Y}_2 = \\
&= (57) + (59) + (62) + (65) + (66) \\
(122) \quad \partial(\bar{e}_3^-) &= \bar{Z}_2^+ + \bar{U}_{12} + \bar{U}_{21} + \bar{Y}_1 + \bar{Z}_2^- + \bar{J} = \\
&= (51) + (56) + (59) + (62) \\
(123) \quad \partial(\bar{f}_1^+) &= \bar{Z}_1^+ + \bar{W}_2 + \bar{W}_3 + \bar{Z}_2^- = (55) + (59) + (69) \\
(124) \quad \partial(\bar{f}_2^+) &= \bar{Z}_1^- + \bar{Z}_2^+ + \bar{W}_1 + \bar{W}_3 = (58) + (69) \\
(125) \quad \partial(\bar{f}_3^+) &= \bar{Z}_2^- + \bar{W}_1 + \bar{W}_2 + \bar{Z}_2^+ = (55) + (59) \\
(126) \quad \partial(\bar{f}_1^-) &= \bar{Z}_1^- + \bar{W}_2 + \bar{W}_3 + \bar{T}_2 + \bar{Z}_2^+ = (55) + (58) + (61) + (69) \\
(127) \quad \partial(\bar{f}_2^-) &= \bar{Z}_1^+ + \bar{Z}_2^- + \bar{W}_1 + \bar{W}_3 + \bar{T}_2 = (59) + (61) + (69) \\
(128) \quad \partial(\bar{f}_3^-) &= \bar{Z}_2^+ + \bar{W}_1 + \bar{W}_2 + \bar{T}_1 + \bar{Z}_2^- = (55) + (59) + (60) \\
(129) \quad \partial(\bar{g}_1) &= \bar{T}_1 + \bar{Y}_1 + \bar{T}_2 + \bar{J} = (56) + (60) + (61) + (62) \\
(130) \quad \partial(\bar{g}_2) &= \bar{T}_1 + \bar{T}_2 + \bar{J} + \bar{Y}_1 = (56) + (60) + (61) + (62) \\
(131) \quad \partial(\bar{g}_3) &= \bar{Y}_2 + \bar{J} = (57) + (62) \\
(132) \quad \partial(\bar{h}^+) &= \bar{Z}_1^+ + \bar{Z}_1^- + \bar{Z}_2^+ + \bar{Z}_2^- = (58) + (59) \\
(133) \quad \partial(\bar{h}^-) &= \bar{Z}_1^+ + \bar{Z}_1^- + \bar{Z}_2^+ + \bar{Z}_2^- = (58) + (59) \\
(134) \quad \partial(\bar{i}_1^+) &= \bar{Z}_1^+ + \bar{Z}_1^- + \bar{T}_1 = (58) + (60) \\
(135) \quad \partial(\bar{i}_1^-) &= \bar{Z}_1^+ + \bar{Z}_1^- + \bar{T}_1 = (58) + (60) \\
(136) \quad \partial(\bar{i}_2^+) &= \bar{Z}_2^+ + \bar{Z}_2^- + \bar{T}_2 = (59) + (61) \\
(137) \quad \partial(\bar{i}_2^-) &= \bar{Z}_2^+ + \bar{Z}_2^- + \bar{T}_2 = (59) + (61)
\end{aligned}$$

The matrix of this operator is given in pages 37–39.

**Corollary 3.** *The kernel of the map  $\partial : C_3 \rightarrow C_2$  is generated by 46 linearly independent cycles (138)–(183) :*

$$\begin{aligned}
(138) \quad & J \\
(139) \quad & S \\
(140) \quad & T_1 + T_2 \\
(141) \quad & T_2 + Z_1^+ + Z_1^- + \bar{h}^+ + \bar{g}_1 + \bar{e}_3^- + \bar{e}_3^+ \\
(142) \quad & U_{12} + U_{32} + X + \bar{e}_3^+ + \bar{c}_2 + \bar{f}_3^- \\
(143) \quad & U_{13} + Z_1^- + \bar{h}^+ + \bar{d} + \bar{c}_1 + \bar{c}_3 + \bar{b}_{41} + \bar{b}_{34} \\
(144) \quad & U_{21} + V_3 + \bar{a}_{23} + \bar{a}_{34} + X \\
(145) \quad & U_{23} + W_2 + V_3 + \bar{b}_{23} + \bar{b}_{34} \\
(146) \quad & U_{31} + \bar{b}_{41} + \bar{b}_{34} + W_2 + \bar{d} + Z_1^- + \bar{h}^+ \\
(147) \quad & U_{32} + V_3 + W_2 + Z_1^+ + \bar{b}_{32} + \bar{b}_{43} + \bar{f}_1^+ + \bar{f}_3^+ \\
(148) \quad & V_1 + W_2 + V_3 + X + \bar{a}_{23} + \bar{a}_{34} + \bar{b}_{14} + \bar{b}_{21} \\
(149) \quad & V_2 + \bar{a}_{23} + \bar{a}_{34} + W_2 + \bar{b}_{14} + \bar{b}_{21}
\end{aligned}$$



- (150)  $W_1 + W_2 + W_3$
- (151)  $W_1 + Z_1^+ + \bar{f}_1^+ + \bar{f}_3^+$
- (152)  $W_2 + Z_2^+ + \bar{d} + Z_1^- + \bar{h}^+$
- (153)  $Y_1 + Y_2$
- (154)  $Y_2 + Z_1^- + Z_1^+ + \bar{h}^+ + \bar{g}_3 + \bar{e}_3^- + \bar{e}_3^+$
- (155)  $Z_1^+ + Z_1^- + Z_2^+ + Z_2^-$
- (156)  $\bar{a}_{12} + \bar{b}_{24} + \bar{f}_3^- + \bar{b}_{21} + \bar{b}_{34} + \bar{a}_{14} + \bar{e}_3^+$
- (157)  $\bar{a}_{13} + \bar{e}_1^+ + \bar{e}_2^+ + \bar{h}^+$
- (158)  $\bar{a}_{14} + \bar{e}_3^+ + \bar{a}_{34} + \bar{c}_2 + \bar{f}_3^-$
- (159)  $\bar{a}_{23} + \bar{b}_{14} + \bar{b}_{23} + \bar{b}_{24} + \bar{a}_{34} + \bar{e}_3^+ + \bar{f}_3^-$
- (160)  $\bar{a}_{24} + \bar{g}_3 + \bar{e}_3^- + \bar{c}_2 + \bar{f}_3^-$
- (161)  $\bar{b}_{12} + \bar{b}_{21} + \bar{b}_{24} + \bar{b}_{34} + \bar{b}_{41} + \bar{c}_2 + \bar{e}_1^+ + \bar{e}_3^+ + \bar{f}_1^+ + \bar{f}_3^+$
- (162)  $\bar{b}_{13} + \bar{f}_2^-$
- (163)  $\bar{b}_{14} + \bar{c}_2 + \bar{c}_1 + \bar{c}_3 + \bar{b}_{24} + \bar{b}_{34}$
- (164)  $\bar{b}_{23} + \bar{b}_{32} + \bar{f}_1^+ + \bar{e}_3^+ + \bar{f}_3^+$
- (165)  $\bar{b}_{24} + \bar{i}_1^+$
- (166)  $\bar{b}_{31} + \bar{f}_1^-$
- (167)  $\bar{b}_{34} + \bar{e}_1^+ + \bar{b}_{43}$
- (168)  $\bar{b}_{41} + \bar{b}_{43} + \bar{c}_2 + \bar{f}_3^-$
- (169)  $\bar{b}_{42} + \bar{i}_2^+$
- (170)  $\bar{c}_1 + \bar{f}_2^- + \bar{e}_1^+$
- (171)  $\bar{c}_3 + \bar{f}_2^- + \bar{e}_2^+ + \bar{h}^+ + \bar{d}$
- (172)  $\bar{c}_4 + \bar{e}_3^+ + \bar{f}_1^- + \bar{f}_3^+ + \bar{d} + \bar{f}_1^+ + \bar{h}^+$
- (173)  $\bar{d} + \bar{i}_1^+ + \bar{f}_3^- + \bar{h}^+$
- (174)  $\bar{e}_1^+ + \bar{e}_1^- + \bar{g}_3 + \bar{h}^+$
- (175)  $\bar{e}_2^+ + \bar{e}_2^- + \bar{g}_3 + \bar{h}^+$
- (176)  $\bar{e}_3^+ + \bar{e}_3^- + \bar{i}_1^+ + \bar{h}^+ + \bar{i}_2^+ + \bar{g}_1$
- (177)  $\bar{f}_1^+ + \bar{f}_2^- + \bar{f}_3^+ + \bar{i}_2^+$
- (178)  $\bar{f}_1^- + \bar{f}_2^+ + \bar{f}_3^+ + \bar{i}_2^+$
- (179)  $\bar{f}_2^- + \bar{f}_2^- + \bar{f}_3^+ + \bar{f}_3^- + \bar{i}_1^+ + \bar{i}_2^+$
- (180)  $\bar{g}_1 + \bar{g}_2$
- (181)  $\bar{h}^+ + \bar{h}^-$
- (182)  $\bar{i}_1^+ + \bar{i}_1^-$
- (183)  $\bar{i}_2^+ + \bar{i}_2^-$

5.5.  $\partial_4 : C_4 \rightarrow C_3$ .

**Proposition 6.** *The boundary operator  $\partial_4 : C_4 \rightarrow C_3$  is given by the formulas (184)–(267) (both in terms of generators of the group  $C_3$  and generators (138) – (183) of its subgroup  $\ker \partial_3$ ).*

$$\begin{aligned}
(184) \quad \partial(a_{12}) &= V_1 + U_{23} + X + \bar{a}_{12} + \bar{a}_{14} = \\
&= (145) + (148) + (156) + (159) \\
(185) \quad \partial(a_{13}) &= U_{13} + U_{23} + U_{32} + Y_2 + \bar{a}_{13} + \bar{a}_{24} = \\
&= (143) + (145) + (147) + (154) + (157) + (160) + (164) + \\
&\quad + (168) + (170) + (171) \\
(186) \quad \partial(a_{14}) &= U_{12} + X + U_{32} + \bar{a}_{14} + \bar{a}_{34} = (142) + (158) \\
(187) \quad \partial(a_{23}) &= U_{13} + V_2 + U_{31} + S + \bar{a}_{23} + \bar{a}_{12} = \\
&= (139) + (143) + (146) + (149) + (156) + (158) + (163) \\
(188) \quad \partial(a_{24}) &= U_{12} + Y_1 + U_{21} + U_{31} + \bar{a}_{24} + \bar{a}_{13} = \\
&= (142) + (144) + (146) + (147) + (153) + (154) + (157) + \\
&\quad + (159) + (160) + (163) + (164) + (168) + (170) + (171) \\
(189) \quad \partial(a_{34}) &= X + U_{21} + V_3 + \bar{a}_{34} + \bar{a}_{23} = (144) \\
(190) \quad \partial(b_{12}) &= V_1 + W_1 + U_{12} + \bar{b}_{12} + \bar{b}_{41} = \\
&= (142) + (147) + (148) + (151) + (159) + \\
&\quad + (161) + (164) + (167) \\
(191) \quad \partial(b_{13}) &= W_1 + Z_1^+ + \bar{b}_{13} + \bar{b}_{42} = (151) + (162) + (169) + (177) \\
(192) \quad \partial(b_{14}) &= U_{13} + Z_1^- + \bar{b}_{14} + \bar{b}_{43} = \\
&= (143) + (163) + (165) + (168) + (173) \\
(193) \quad \partial(b_{21}) &= V_1 + W_2 + U_{21} + \bar{b}_{21} + \bar{b}_{14} = (144) + (148) \\
(194) \quad \partial(b_{23}) &= W_1 + V_2 + W_2 + Z_1^+ + \bar{b}_{23} + \bar{b}_{12} = \\
&= (149) + (151) + (159) + (161) + (167) + (168) \\
(195) \quad \partial(b_{24}) &= W_1 + Z_1^- + T_1 + \bar{b}_{24} + \bar{b}_{13} = \\
&= (140) + (141) + (151) + (162) + (165) + (176) + (177) \\
(196) \quad \partial(b_{31}) &= W_3 + Z_2^+ + T_2 + \bar{b}_{31} + \bar{b}_{24} = \\
&= (141) + (150) + (151) + (152) + (165) + (166) + + \\
&\quad (173) + (176) + (177) + (178) + (179) \\
(197) \quad \partial(b_{32}) &= W_2 + V_2 + W_3 + Z_2^- + \bar{b}_{32} + \bar{b}_{21} = \\
&= (149) + (150) + (151) + (152) + (155) + \\
&\quad + (159) + (164) + (165) + (173) \\
(198) \quad \partial(b_{34}) &= U_{23} + W_2 + V_3 + \bar{b}_{34} + \bar{b}_{23} = (145) \\
(199) \quad \partial(b_{41}) &= U_{31} + Z_2^+ + \bar{b}_{41} + \bar{b}_{34} = (146) + (152)
\end{aligned}$$

$$\begin{aligned}
(200) \quad \partial(b_{42}) &= W_3 + Z_2^- + \bar{b}_{42} + \bar{b}_{31} = \\
&= (150) + (151) + (152) + (155) + (166) + \\
&\quad + (169) + (173) + (177) + (178) + (179) \\
(201) \quad \partial(b_{43}) &= U_{32} + W_3 + V_3 + \bar{b}_{43} + \bar{b}_{32} = (147) + (150) + (151) \\
(202) \quad \partial(c_1) &= W_1 + U_{23} + U_{32} + \bar{c}_1 + \bar{c}_4 = \\
&= (145) + (147) + (151) + (164) + (167) + (170) + (172) + \\
&\quad + (173) + (178) + (179) \\
(203) \quad \partial(c_2) &= W_1 + W_2 + U_{31} + T_1 + \bar{c}_2 + \bar{c}_1 = \\
&= (140) + (141) + (146) + (151) + (167) + (168) + (170) + \\
&\quad + (173) + (176) + (177) \\
(204) \quad \partial(c_3) &= U_{13} + W_2 + W_3 + T_2 + \bar{c}_3 + \bar{c}_2 = \\
&= (141) + (143) + (150) + (151) + (167) + (168) + (170) + \\
&\quad + (173) + (176) + (177) \\
(205) \quad \partial(c_4) &= U_{12} + U_{21} + W_3 + \bar{c}_4 + \bar{c}_3 = \\
&= (142) + (144) + (147) + (150) + (151) + (159) + (163) + \\
&\quad + (164) + (167) + (170) + (172) + (173) + (178) + (179) \\
(206) \quad \partial(d) &= W_1 + W_2 + W_3 = (150) \\
(207) \quad \partial(e_1^+) &= Z_1^+ + U_{23} + U_{32} + \bar{e}_1^+ + \bar{e}_3^+ = \\
&= (145) + (147) + (164) + (167) \\
(208) \quad \partial(e_2^+) &= Z_1^- + Z_2^+ + U_{13} + U_{31} + \bar{e}_2^+ + \bar{e}_1^+ = \\
&= (143) + (146) + (152) + (170) + (171) \\
(209) \quad \partial(e_3^+) &= Z_2^- + U_{12} + U_{21} + \bar{e}_3^+ + \bar{e}_2^+ = \\
&= (142) + (144) + (147) + (152) + (155) + (159) + \\
&\quad + (163) + (164) + (167) + (170) + (171) \\
(210) \quad \partial(e_1^-) &= Z_1^- + U_{23} + U_{32} + Y_2 + \bar{e}_1^- + \bar{e}_3^- = \\
&= (145) + (147) + (154) + (164) + (167) + (174) \\
(211) \quad \partial(e_2^-) &= Z_1^+ + Z_2^- + U_{13} + U_{31} + J + \bar{e}_2^- + \bar{e}_1^- = \\
&= (138) + (143) + (146) + (152) + (155) + (170) + \\
&\quad + (171) + (174) + (175) \\
(212) \quad \partial(e_3^-) &= Z_2^+ + U_{12} + U_{21} + Y_1 + \bar{e}_3^- + \bar{e}_2^- = \\
&= (142) + (144) + (147) + (152) + (153) + (154) + (159) + \\
&\quad + (163) + (164) + (167) + (170) + (171) + (175) \\
(213) \quad \partial(f_1^+) &= Z_1^+ + W_2 + W_3 + \bar{f}_1^+ + \bar{f}_3^+ = (150) + (151) \\
(214) \quad \partial(f_2^+) &= Z_1^- + Z_2^+ + W_1 + W_3 + \bar{f}_2^+ + \bar{f}_1^+ = \\
&= (150) + (152) + (173) + (177) + (179) \\
(215) \quad \partial(f_3^+) &= Z_2^- + W_1 + W_2 + \bar{f}_3^+ + \bar{f}_2^+ = \\
&= (151) + (152) + (155) + (173) + (177) + (179)
\end{aligned}$$

$$\begin{aligned}
(216) \quad \partial(f_1^-) &= Z_1^- + W_2 + W_3 + T_2 + \bar{f}_1^- + \bar{f}_3^- = \\
&= (141) + (150) + (151) + (176) + (177) + (178) + (179) \\
(217) \quad \partial(f_2^-) &= Z_1^+ + Z_2^- + W_1 + W_3 + \bar{f}_2^- + \bar{f}_1^- = \\
&= (150) + (152) + (155) + (173) + (178) + (179) \\
(218) \quad \partial(f_3^-) &= Z_2^+ + W_1 + W_2 + T_1 + \bar{f}_3^- + \bar{f}_2^- = \\
&= (140) + (141) + (151) + (152) + (173) + (176) + (177) \\
(219) \quad \partial(g_1) &= T_1 + Y_1 + \bar{g}_1 + \bar{g}_3 = (140) + (141) + (153) + (154) \\
(220) \quad \partial(g_2) &= T_1 + T_2 + J + \bar{g}_2 + \bar{g}_1 = (138) + (140) + (180) \\
(221) \quad \partial(g_3) &= Y_2 + T_2 + \bar{g}_3 + \bar{g}_2 = (141) + (154) + (180) \\
(222) \quad \partial(h^+) &= Z_1^+ + Z_1^- + Z_2^+ + Z_2^- + S = (139) + (155) \\
(223) \quad \partial(h^-) &= Z_1^+ + Z_1^- + Z_2^+ + Z_2^- + J = (138) + (155) \\
(224) \quad \partial(i_1^+) &= Z_1^+ + Z_1^- + T_1 + S + \bar{i}_1^+ + \bar{i}_2^+ = \\
&= (139) + (140) + (141) + (176) \\
(225) \quad \partial(i_1^-) &= Z_1^+ + Z_1^- + T_1 + \bar{i}_1^- + \bar{i}_2^- = \\
&= (140) + (141) + (176) + (182) + (183) \\
(226) \quad \partial(i_2^+) &= Z_2^+ + Z_2^- + T_2 + S + \bar{i}_2^+ + \bar{i}_1^+ = \\
&= (139) + (141) + (155) + (176) \\
(227) \quad \partial(i_2^-) &= Z_2^+ + Z_2^- + T_2 + \bar{i}_2^- + \bar{i}_1^- = \\
&= (141) + (155) + (176) + (182) + (183) \\
(228) \quad \partial(\bar{B}_1^1) &= \bar{b}_{12} + \bar{a}_{12} + \bar{c}_1 + \bar{a}_{14} + \bar{b}_{43} + \bar{i}_2^+ = \\
&= (156) + (161) + (168) + (170) + (177) \\
(229) \quad \partial(\bar{B}_1^2) &= \bar{b}_{13} + \bar{c}_1 + \bar{e}_1^+ + \bar{i}_2^- + \bar{b}_{42} = \\
&= (162) + (169) + (170) + (183) \\
(230) \quad \partial(\bar{B}_1^3) &= \bar{b}_{14} + \bar{a}_{13} + \bar{e}_1^- + \bar{b}_{41} + \bar{g}_3 = \\
&= (157) + (163) + (165) + (167) + (168) + \\
&\quad + (170) + (171) + (173) + (174) \\
(231) \quad \partial(\bar{B}_2^1) &= \bar{b}_{12} + \bar{b}_{21} + \bar{c}_2 + \bar{a}_{24} + \bar{g}_1 + \bar{c}_1 + \bar{e}_1^- = \\
&= (160) + (161) + (165) + (167) + (168) + (170) + \\
&\quad + (174) + (176) + (177) \\
(232) \quad \partial(\bar{B}_2^2) &= \bar{b}_{13} + \bar{b}_{24} + \bar{c}_1 + \bar{e}_1^+ + \bar{i}_1^- = \\
&= (162) + (165) + (170) + (182) \\
(233) \quad \partial(\bar{B}_2^3) &= \bar{b}_{14} + \bar{b}_{23} + \bar{a}_{23} + \bar{c}_2 + \bar{a}_{14} + \bar{i}_1^+ = \\
&= (158) + (159) + (165)
\end{aligned}$$

$$\begin{aligned}
(234) \quad \partial(\bar{B}_3^1) &= \bar{a}_{12} + \bar{b}_{21} + \bar{b}_{34} + \bar{a}_{34} + \bar{c}_2 + \bar{i}_1^+ = \\
&= (156) + (158) + (165) \\
(235) \quad \partial(\bar{B}_3^2) &= \bar{b}_{24} + \bar{b}_{31} + \bar{c}_3 + \bar{e}_2^+ + \bar{i}_1^- = \\
&= (165) + (166) + (171) + (173) + (178) + (179) + (182) \\
(236) \quad \partial(\bar{B}_3^3) &= \bar{c}_2 + \bar{b}_{23} + \bar{b}_{32} + \bar{c}_3 + \bar{e}_2^- + \bar{g}_2 + \bar{a}_{24} = \\
&= (160) + (164) + (171) + (173) + (175) + \\
&\quad + (176) + (177) + (180) \\
(237) \quad \partial(\bar{B}_4^1) &= \bar{a}_{13} + \bar{b}_{34} + \bar{b}_{43} + \bar{g}_3 + \bar{e}_2^- = (157) + (167) + (175) \\
(238) \quad \partial(\bar{B}_4^2) &= \bar{b}_{31} + \bar{b}_{42} + \bar{c}_3 + \bar{e}_2^+ + \bar{i}_2^- = \\
&= (166) + (169) + (171) + (173) + (178) + (179) + (183) \\
(239) \quad \partial(\bar{B}_4^3) &= \bar{c}_3 + \bar{a}_{23} + \bar{b}_{32} + \bar{b}_{41} + \bar{a}_{34} + \bar{i}_2^+ = \\
&= (159) + (163) + (164) + (167) + (168) + (170) + (177) \\
(240) \quad \partial(\bar{B}_5^1) &= \bar{a}_{14} + \bar{c}_4 + \bar{a}_{34} + \bar{b}_{43} + \bar{b}_{41} + \bar{i}_2^+ = \\
&= (158) + (168) + (172) + (173) + (177) + (178) + (179) \\
(241) \quad \partial(\bar{B}_5^2) &= \bar{c}_4 + \bar{e}_3^+ + \bar{i}_2^- = \\
&= (172) + (173) + (177) + (178) + (179) + (183) \\
(242) \quad \partial(\bar{B}_5^3) &= \bar{a}_{24} + \bar{b}_{41} + \bar{e}_3^- + \bar{b}_{43} + \bar{g}_3 = (160) + (168) \\
(243) \quad \partial(\bar{C}_{12}) &= \bar{c}_1 + \bar{b}_{34} + \bar{b}_{43} + \bar{f}_2^- = (167) + (170) \\
(244) \quad \partial(\bar{C}_{13}) &= \bar{b}_{42} + \bar{f}_3^+ + \bar{f}_2^+ + \bar{f}_1^- = (169) + (178) \\
(245) \quad \partial(\bar{C}_{14}) &= \bar{b}_{24} + \bar{f}_2^+ + \bar{f}_3^- + \bar{f}_1^+ = (165) + (177) + (179) \\
(246) \quad \partial(\bar{C}_{15}) &= \bar{b}_{23} + \bar{b}_{32} + \bar{f}_2^- + \bar{c}_4 = \\
&= (164) + (172) + (173) + (178) + (179) \\
(247) \quad \partial(\bar{C}_{23}) &= \bar{c}_2 + \bar{b}_{41} + \bar{f}_3^- + \bar{b}_{43} = (168) \\
(248) \quad \partial(\bar{C}_{24}) &= \bar{f}_1^+ + \bar{f}_2^- + \bar{f}_3^+ + \bar{b}_{42} = (169) + (177) \\
(249) \quad \partial(\bar{C}_{25}) &= \bar{b}_{31} + \bar{f}_1^- = (166) \\
(250) \quad \partial(\bar{C}_{34}) &= \bar{b}_{14} + \bar{c}_3 + \bar{f}_1^- + \bar{b}_{41} = \\
&= (163) + (165) + (167) + (168) + (170) + (178) + (179) \\
(251) \quad \partial(\bar{C}_{35}) &= \bar{b}_{13} + \bar{f}_2^- = (162) \\
&\quad \partial(\bar{C}_{45}) = \bar{b}_{12} + \bar{b}_{21} + \bar{c}_4 + \bar{f}_1^- = \\
&= (161) + (165) + (167) + (168) + (172) + (173) \\
(252) \quad \partial(\bar{D}_{12}^+) &= \bar{f}_3^+ + \bar{e}_3^+ + \bar{b}_{12} + \bar{b}_{21} + \bar{f}_2^+ = \\
&= (161) + (165) + (167) + (168) + (177) + (179) \\
(253) \quad \partial(\bar{D}_{12}^-) &= \bar{f}_3^- + \bar{e}_3^- + \bar{g}_1 + \bar{b}_{12} + \bar{b}_{21} + \bar{f}_2^- + \bar{h}^- = \\
&= (161) + (165) + (167) + (168) + (176) + (177) + (181)
\end{aligned}$$

$$\begin{aligned}
(254) \quad \partial(\bar{D}_{13}^+) &= \bar{f}_2^+ + \bar{b}_{13} + \bar{b}_{31} + \bar{f}_1^+ = (162) + (166) + (177) + (178) \\
(255) \quad \partial(\bar{D}_{13}^-) &= \bar{f}_2^- + \bar{b}_{13} + \bar{b}_{31} + \bar{f}_1^- = (162) + (166) \\
(256) \quad \partial(\bar{D}_{14}^+) &= \bar{e}_2^+ + \bar{b}_{14} + \bar{b}_{41} = \\
&= (163) + (165) + (167) + (168) + (170) + (171) + (173) \\
(257) \quad \partial(\bar{D}_{14}^-) &= \bar{e}_2^- + \bar{h}^- + \bar{b}_{14} + \bar{b}_{41} + \bar{g}_3 = \\
&= (163) + (165) + (167) + (168) + (170) + (171) + \\
&\quad + (173) + (175) + (181) \\
(258) \quad \partial(\bar{D}_{23}^+) &= \bar{f}_1^+ + \bar{f}_3^+ + \bar{b}_{23} + \bar{b}_{32} + \bar{e}_3^+ = (164) \\
(259) \quad \partial(\bar{D}_{23}^-) &= \bar{f}_1^- + \bar{f}_3^- + \bar{g}_2 + \bar{h}^- + \bar{b}_{23} + \bar{b}_{32} + \bar{e}_3^- = \\
&= (164) + (176) + (177) + (178) + (179) + (180) + (181) \\
(260) \quad \partial(\bar{D}_{24}^+) &= \bar{b}_{24} + \bar{b}_{42} + \bar{i}_1^+ + \bar{i}_2^+ = (165) + (169) \\
(261) \quad \partial(\bar{D}_{24}^-) &= \bar{b}_{24} + \bar{b}_{42} + \bar{i}_1^- + \bar{i}_2^- = (165) + (169) + (182) + (183) \\
(262) \quad \partial(\bar{D}_{34}^+) &= \bar{e}_1^+ + \bar{b}_{34} + \bar{b}_{43} = (167) \\
(263) \quad \partial(\bar{D}_{34}^-) &= \bar{e}_1^- + \bar{g}_3 + \bar{b}_{34} + \bar{b}_{43} + \bar{h}^- = (167) + (174) + (181) \\
(264) \quad \partial(\bar{E}_+) &= \bar{f}_1^- + \bar{f}_2^- + \bar{f}_3^- + \bar{i}_1^+ = (178) + (179) \\
(265) \quad \partial(\bar{E}_1) &= \bar{f}_1^- + \bar{f}_2^+ + \bar{f}_3^+ + \bar{i}_2^- = (178) + (183) \\
(266) \quad \partial(\bar{E}_2) &= \bar{f}_1^+ + \bar{f}_2^- + \bar{f}_3^+ + \bar{i}_2^- = (177) + (183) \\
(267) \quad \partial(\bar{E}_3) &= \bar{f}_1^+ + \bar{f}_2^+ + \bar{f}_3^- + \bar{i}_1^- = (177) + (179) + (182)
\end{aligned}$$

The matrix of this operator is given in the pages 40–44 (the missing left bottom corner of this matrix, which contains all incidence coefficients between the four-dimensional generators  $\bar{B}_1^1$ – $\bar{E}_3$  of the second type and the three-dimensional generators  $U_{12}$ – $S$  of the first type, consists only of zeros).

5.6.  $\partial_5 : C_5 \rightarrow C_4$ .

**Proposition 7.** *The boundary operator  $\partial_5 : C_5 \rightarrow C_4$  is described by the formulas (268)–(323) and the matrix given in pages 44–48.*

$$\begin{aligned}
(268) \quad \partial(B_1^1) &= b_{12} + a_{12} + c_1 + a_{14} + \bar{B}_1^1 + \bar{B}_5^1 \\
(269) \quad \partial(B_1^2) &= b_{13} + c_1 + e_1^+ + \bar{B}_1^2 + \bar{B}_5^2 \\
(270) \quad \partial(B_1^3) &= b_{14} + a_{13} + e_1^- + \bar{B}_1^3 + \bar{B}_5^3 \\
(271) \quad \partial(B_2^1) &= b_{12} + b_{21} + c_2 + a_{24} + g_1 + \bar{B}_2^1 + \bar{B}_1^3 \\
(272) \quad \partial(B_2^2) &= b_{13} + b_{24} + i_1^- + \bar{B}_2^2 + \bar{B}_1^2 \\
(273) \quad \partial(B_2^3) &= b_{14} + b_{23} + a_{23} + c_2 + i_1^+ + \bar{B}_2^3 + \bar{B}_1^1
\end{aligned}$$

- (274)  $\partial(B_3^1) = a_{12} + b_{21} + b_{34} + a_{34} + \bar{B}_3^1 + \bar{B}_2^3$
- (275)  $\partial(B_3^2) = c_2 + b_{24} + b_{31} + c_3 + e_2^+ + \bar{B}_3^2 + \bar{B}_2^2$
- (276)  $\partial(B_3^3) = c_2 + b_{23} + b_{32} + c_3 + e_2^- + g_2 + \bar{B}_3^3 + \bar{B}_2^1$
- (277)  $\partial(B_4^1) = a_{13} + c_3 + b_{34} + b_{43} + g_3 + \bar{B}_4^1 + \bar{B}_3^3$
- (278)  $\partial(B_4^2) = b_{31} + b_{42} + i_2^- + \bar{B}_4^2 + \bar{B}_3^2$
- (279)  $\partial(B_4^3) = c_3 + a_{23} + b_{32} + b_{41} + i_2^+ + \bar{B}_4^3 + \bar{B}_3^1$
- (280)  $\partial(B_5^1) = a_{14} + c_4 + a_{34} + b_{43} + \bar{B}_5^1 + \bar{B}_4^3$
- (281)  $\partial(B_5^2) = c_4 + b_{42} + e_3^+ + \bar{B}_5^2 + \bar{B}_4^2$
- (282)  $\partial(B_5^3) = a_{24} + b_{41} + e_3^- + \bar{B}_5^3 + \bar{B}_4^1$
- (283)  $\partial(C_{12}) = c_1 + d + b_{34} + b_{43} + \bar{C}_{12} + \bar{C}_{15}$
- (284)  $\partial(C_{13}) = d + b_{42} + f_3^+ + \bar{C}_{13} + \bar{C}_{25}$
- (285)  $\partial(C_{14}) = d + b_{24} + f_2^+ + f_3^- + \bar{C}_{14} + \bar{C}_{35}$
- (286)  $\partial(C_{15}) = b_{23} + b_{32} + f_2^- + \bar{C}_{15} + \bar{C}_{45}$
- (287)  $\partial(C_{23}) = c_2 + b_{41} + f_3^- + \bar{C}_{23} + \bar{C}_{12}$
- (288)  $\partial(C_{24}) = f_1^+ + f_2^- + f_3^+ + \bar{C}_{24} + \bar{C}_{13}$
- (289)  $\partial(C_{25}) = b_{31} + d + f_2^+ + f_1^- + \bar{C}_{25} + \bar{C}_{14}$
- (290)  $\partial(C_{34}) = b_{14} + c_3 + f_1^- + \bar{C}_{34} + \bar{C}_{23}$
- (291)  $\partial(C_{35}) = b_{13} + d + f_1^+ + \bar{C}_{35} + \bar{C}_{24}$
- (292)  $\partial(C_{45}) = b_{12} + b_{21} + d + c_4 + \bar{C}_{45} + \bar{C}_{34}$
- (293)  $\partial(D_{12}^+) = f_3^+ + e_3^+ + b_{12} + b_{21} + \bar{D}_{12}^+ + \bar{D}_{14}^+$
- (294)  $\partial(D_{12}^-) = f_3^- + e_3^- + g_1 + b_{12} + b_{21} + \bar{D}_{12}^- + \bar{D}_{14}^-$
- (295)  $\partial(D_{13}^+) = f_2^+ + h^+ + b_{13} + b_{31} + i_2^+ + \bar{D}_{13}^+ + \bar{D}_{24}^+$
- (296)  $\partial(D_{13}^-) = f_2^- + b_{13} + b_{31} + i_2^- + \bar{D}_{13}^- + \bar{D}_{24}^-$
- (297)  $\partial(D_{14}^+) = e_2^+ + b_{14} + b_{41} + \bar{D}_{14}^+ + \bar{D}_{34}^+$
- (298)  $\partial(D_{14}^-) = e_2^- + h^- + b_{14} + b_{41} + \bar{D}_{14}^- + \bar{D}_{34}^-$
- (299)  $\partial(D_{23}^+) = f_1^+ + f_3^+ + b_{23} + b_{32} + \bar{D}_{23}^+ + \bar{D}_{12}^+$
- (300)  $\partial(D_{23}^-) = f_1^- + f_3^- + g_2 + h^- + b_{23} + b_{32} + \bar{D}_{23}^- + \bar{D}_{12}^-$
- (301)  $\partial(D_{24}^+) = f_2^+ + h^+ + b_{24} + b_{42} + i_1^+ + \bar{D}_{24}^+ + \bar{D}_{13}^+$
- (302)  $\partial(D_{24}^-) = f_2^- + b_{24} + b_{42} + i_1^- + \bar{D}_{24}^- + \bar{D}_{13}^-$
- (303)  $\partial(D_{34}^+) = e_1^+ + f_1^+ + b_{34} + b_{43} + \bar{D}_{34}^+ + \bar{D}_{23}^+$
- (304)  $\partial(D_{34}^-) = e_1^- + f_1^- + g_3 + b_{34} + b_{43} + \bar{D}_{34}^- + \bar{D}_{23}^-$
- (305)  $\partial(E_+) = f_1^- + f_2^- + f_3^- + i_1^+ + i_2^+$
- (306)  $\partial(E_1) = f_1^- + f_2^+ + f_3^+ + i_2^- + \bar{E}_1 + \bar{E}_3$
- (307)  $\partial(E_2) = f_1^+ + f_2^- + f_3^+ + \bar{E}_2 + \bar{E}_1$
- (308)  $\partial(E_3) = f_1^+ + f_2^+ + f_3^- + i_1^- + \bar{E}_3 + \bar{E}_2$

$$(309) \quad \partial(\bar{A}_{11}) = \bar{B}_1^1 + \bar{C}_{45} + \bar{B}_3^1 + \bar{C}_{12} + \bar{B}_5^1 + \bar{C}_{23} + \bar{E}_+$$

$$(310) \quad \partial(\bar{A}_{12}) = \bar{B}_1^2 + \bar{C}_{35} + \bar{C}_{12} + \bar{D}_{34}^+ + \bar{C}_{24} + \bar{E}_2$$

$$(311) \quad \partial(\bar{A}_{13}) = \bar{B}_1^3 + \bar{B}_4^1 + \bar{D}_{34}^- + \bar{D}_{14}^-$$

$$(312) \quad \partial(\bar{A}_{21}) = \bar{C}_{45} + \bar{B}_5^2 + \bar{D}_{12}^+ + \bar{E}_1$$

$$(313) \quad \partial(\bar{A}_{22}) = \bar{C}_{24} + \bar{E}_2 + \bar{C}_{14} + \bar{D}_{24}^- + \bar{E}_3$$

$$(314) \quad \partial(\bar{A}_{23}) = \bar{C}_{25} + \bar{B}_4^2 + \bar{C}_{13} + \bar{E}_1 + \bar{C}_{34} + \bar{D}_{14}^+$$

$$(315) \quad \partial(\bar{A}_{31}) = \bar{B}_2^1 + \bar{C}_{23} + \bar{B}_5^3 + \bar{D}_{12}^- + \bar{C}_{12} + \bar{D}_{34}^-$$

$$(316) \quad \partial(\bar{A}_{32}) = \bar{C}_{25} + \bar{C}_{13} + \bar{C}_{24} + \bar{C}_{35} + \bar{D}_{13}^+$$

$$(317) \quad \partial(\bar{A}_{33}) = \bar{C}_{13} + \bar{C}_{14} + \bar{D}_{24}^- + \bar{E}_3 + \bar{E}_1$$

$$(318) \quad \partial(\bar{A}_{41}) = \bar{C}_{35} + \bar{B}_2^2 + \bar{C}_{14} + \bar{E}_3 + \bar{C}_{12} + \bar{D}_{34}^+$$

$$(319) \quad \partial(\bar{A}_{42}) = \bar{C}_{25} + \bar{C}_{35} + \bar{C}_{24} + \bar{D}_{13}^- + \bar{E}_1 + \bar{C}_{13} + \bar{E}_2$$

$$(320) \quad \partial(\bar{A}_{43}) = \bar{C}_{14} + \bar{B}_3^2 + \bar{C}_{25} + \bar{C}_{34} + \bar{D}_{14}^+ + \bar{E}_3$$

$$(321) \quad \partial(\bar{A}_{51}) = \bar{C}_{34} + \bar{B}_2^3 + \bar{C}_{15} + \bar{B}_4^3 + \bar{C}_{23} + \bar{E}_+ + \bar{B}_5^1$$

$$(322) \quad \partial(\bar{A}_{52}) = \bar{C}_{15} + \bar{D}_{23}^+ + \bar{E}_2 + \bar{B}_5^2$$

$$(323) \quad \partial(\bar{A}_{53}) = \bar{C}_{23} + \bar{B}_3^3 + \bar{C}_{34} + \bar{D}_{23}^- + \bar{D}_{14}^- + \bar{B}_5^3$$

**Corollary 4.** *The kernel of this operator is generated by the right parts of the formulas (324)–(338).  $\square$*

5.7.  $\partial : C_6 \rightarrow C_5$ .

**Proposition 8.** *The boundary operator  $C_6 \rightarrow C_5$  is given by the formulas (324)–(338) and the matrix given in page 49.*

$$(324) \quad \partial(A_{11}) = B_1^1 + C_{45} + B_3^1 + C_{12} + B_5^1 + \bar{A}_{11} + \bar{A}_{51}$$

$$(325) \quad \partial(A_{12}) = B_1^2 + C_{35} + C_{12} + D_{34}^+ + \bar{A}_{12} + \bar{A}_{52}$$

$$(326) \quad \partial(A_{13}) = B_1^3 + C_{34} + B_4^1 + D_{34}^- + \bar{A}_{13} + \bar{A}_{53}$$

$$(327) \quad \partial(A_{21}) = C_{45} + C_{13} + B_5^2 + D_{12}^+ + \bar{A}_{21} + \bar{A}_{23}$$

$$(328) \quad \partial(A_{22}) = C_{24} + E_2 + \bar{A}_{22} + \bar{A}_{33}$$

$$(329) \quad \partial(A_{23}) = C_{25} + B_4^2 + C_{13} + E_1 + \bar{A}_{23} + \bar{A}_{43}$$

$$(330) \quad \partial(A_{31}) = B_2^1 + C_{23} + B_5^3 + D_{12}^- + \bar{A}_{31} + \bar{A}_{13}$$

$$(331) \quad \partial(A_{32}) = C_{25} + C_{13} + C_{24} + C_{35} + C_{14} + D_{13}^+ + D_{24}^+ + E_+$$

$$(332) \quad \partial(A_{33}) = C_{24} + C_{13} + C_{14} + D_{24}^- + E_3 + \bar{A}_{33} + \bar{A}_{42}$$

$$(333) \quad \partial(A_{41}) = C_{35} + B_2^2 + C_{14} + E_3 + \bar{A}_{41} + \bar{A}_{12}$$

$$(334) \quad \partial(A_{42}) = C_{25} + C_{35} + C_{24} + D_{13}^- + E_1 + \bar{A}_{42} + \bar{A}_{22}$$

$$(335) \quad \partial(A_{43}) = C_{23} + C_{14} + B_3^2 + C_{25} + C_{34} + D_{14}^+ + \bar{A}_{43} + \bar{A}_{41}$$

$$(336) \quad \partial(A_{51}) = C_{34} + B_2^3 + C_{15} + B_4^3 + C_{23} + E_+ + \bar{A}_{51} + \bar{A}_{11}$$

$$(337) \quad \partial(A_{52}) = C_{15} + D_{23}^+ + E_2 + \bar{A}_{52} + \bar{A}_{21}$$

$$(338) \quad \partial(A_{53}) = C_{23} + B_3^3 + C_{34} + D_{23}^- + D_{14}^- + \bar{A}_{53} + \bar{A}_{31}$$



## 6. HOMOLOGY GROUPS AND THEIR APPLICATIONS

Theorem 1 now has the following concretization.

**Proposition 9.** *The group  $H_1(\overline{CD}_3(S^1), \mathbb{Z}_2)$  is isomorphic to  $\mathbb{Z}_2$  and is generated by either of three cells  $\bar{\Omega}_1, \bar{\Omega}_2$  or  $\bar{\Theta}$  (all of which are homologous to each other).*

*The group  $H_2(\overline{CD}_3(S^1), \mathbb{Z}_2)$  is isomorphic to  $\mathbb{Z}_2^2$  and is generated by the classes of 1) the cell  $\bar{S}$  and 2) either of the cells  $\bar{Y}_1, \bar{Y}_2$ , and  $\bar{J}$ .*

*The group  $H_3(\overline{CD}_3(S^1), \mathbb{Z}_2)$  is isomorphic to  $\mathbb{Z}_2^2$  and is generated by the cycles  $\bar{h}^+ + \bar{h}^-$  and  $\bar{d} + \bar{i}_1^+ + \bar{f}_3^- + \bar{h}^+$ .*

*All groups  $H_i(\overline{CD}_3(S^1), \mathbb{Z}_2)$  with  $i \geq 4$  are trivial.*

*Proof.* All these statements follow directly from the formulas of the boundary operators given in the Propositions 4, 5, 6, 7 and 8.  $\square$

Theorem 2 of page 2 is covered by the following Propositions 10, 11, 12.

**Proposition 10.** *The first Stiefel–Whitney class of the canonical vector bundle on  $\overline{CD}_3(S^1)$  takes the non-trivial value on the cycle defined by the closure of the cell  $\bar{\Theta}$ .*

*The square of the first Stiefel–Whitney class of the canonical bundle on  $\overline{CD}_3(S^1)$  takes the non-zero value on the generator  $\bar{S}$  of the group  $H_2(\overline{CD}_3(S^1), \mathbb{Z}_2)$ , while the second Stiefel–Whitney class of the same bundle takes the zero value on this generator.*

*Proof.* In the restriction to the closure of the cell  $\bar{\Theta}$ , the canonical bundle is the sum of a two-dimensional constant bundle (normal in  $C^\infty(S^1, \mathbb{R})$  to the subspace of functions with  $f'(\bullet) = f''(\bullet) = 0$ ) and the tautological bundle over the space of one-dimensional subspaces in  $\mathfrak{M}_\bullet^3/\mathfrak{M}_\bullet^5 \simeq \mathbb{R}^2$ .

In the restriction to the closure of the cell  $\bar{S}$ , the canonical bundle is the sum of the same two-dimensional constant bundle and the tautological bundle over the space of one-dimensional subspaces in  $\mathfrak{M}_\bullet^3/\mathfrak{M}_\bullet^6 \simeq \mathbb{R}^3$ . Thus the values of the characteristic classes  $w_1^2$  and  $w_2$  of the canonical bundle on the cycle  $\bar{S}$  are equal to the values on  $\mathbb{R}P^2$  of the analogous classes of the tautological one-dimensional bundle.  $\square$

**Proposition 11.** *The second Stiefel–Whitney class of the canonical bundle takes the nonzero value on the generator  $\bar{J}$  of the group  $H_2(\overline{CD}_3(S^1), \mathbb{Z}_2)$ , while the square of the first Stiefel–Whitney class of this bundle takes the zero value on it.*

*Proof.* The cycle  $\bar{J}$  can be identified with a two-dimensional subvariety homeomorphic to  $\mathbb{R}P^2$  in the Grassmann manifold of two-dimensional subspaces of the space  $\mathfrak{M}_\bullet^2/\mathfrak{M}_\bullet^6 \simeq \mathbb{R}^4$ , see Proposition 2. The restriction of the canonical bundle to this manifold is equal to the sum of the one-dimensional constant bundle  $\mathfrak{M}_\bullet/\mathfrak{M}_\bullet^2$  and the two-dimensional tautological bundle of this Grassmann manifold.

**Lemma 2.** *The intersection indices of the cycle  $\{\bar{J}\}$  with the two-dimensional Schubert cells  $(1, 4)$  and  $(2, 3)$  of the Grassmann manifold  $G_2(\mathfrak{M}_\bullet^2/\mathfrak{M}_\bullet^6)$  are non-trivial.*

*Proof.* The homology class of the Schubert cell  $(1, 4)$  in the Grassmann manifold  $G_2(\mathbb{R}^4)$  can be realized by the set of all 2-subspaces containing a fixed one-dimensional space. Take for this the space spanned by a polynomial of the form  $x^2 + ax^3 + bx^4 + cx^5$ . Each polynomial  $f$  of this form belongs to a single subalgebra of the class  $J$ , which is spanned by  $f$  and  $f^2 \pmod{\mathfrak{M}_\bullet^6}$ .

The homology class of the Schubert cell  $(2, 3)$  can be realized by the variety of all two-subspaces contained in a fixed 3-dimensional subspace in  $\mathbb{R}^4$ . Take for this subspace the space of polynomials  $ax^2 + bx^3 + cx^4 + dx^5$  which belong to the 3-dimensional subspace distinguished by the condition  $a + \alpha b + \beta c + \gamma d = 0$  for a generic triple of coefficients  $(\alpha, \beta, \gamma)$ . Each such condition with  $\gamma \neq 0$  contains a unique subspace of class  $J$  spanned by the polynomials  $f_0 = x^2 + \frac{\beta}{2\gamma}x^3 + \frac{\alpha\beta - 2\gamma}{2\gamma^2}x^5$  and  $f_0^2 \pmod{\mathfrak{M}_\bullet^6}$ .  $\square$

It is easy to see that the intersection indices  $(\text{mod } 2)$  of two-dimensional Schubert cells in  $G_2(\mathbb{R}^4)$  satisfy the identities  $\langle (1, 4), (1, 4) \rangle = \langle (2, 3), (2, 3) \rangle = 1$ ,  $\langle (1, 4), (2, 3) \rangle = 0$ . Thus, the variety defined by the cycle  $\bar{J}$  in  $G_2(\mathfrak{M}_\bullet^2/\mathfrak{M}_\bullet^6)$  is homologous to the sum of Schubert cells  $(1, 4)$  and  $(2, 3)$ . It is also easy to compute that the pairings of these Schubert cells with Stiefel–Whitney classes are as follows:  $w_1^2((1, 4)) = 1$ ,  $w_2((1, 4)) = 0$ ,  $w_1^2((2, 3)) = 1$ ,  $w_2((2, 3)) = 1$ . This implies Proposition 11.  $\square$

Define the 3-dimensional cycle  $\tilde{h} \subset \overline{CD}_3(S^1)$  as the closure of the union of all algebras  $h(\alpha, \beta; A, B)$  where  $A$  and  $B$  are two opposite points of the circle  $S^1$ .

**Proposition 12.** *The third Stiefel–Whitney class of the canonical bundle takes the nonzero value on the cycle  $\tilde{h}$ .*

*Proof.* Let  $f_0$  be a generic vector in  $C^\infty(S^1, \mathbb{R})$ . For any  $k$ , the value of the  $k$ -th Stiefel–Whitney class of the canonical bundle on a  $k$ -dimensional cycle in  $\overline{CD}_k(S^1)$  is equal to the intersection index of this cycle with the variety of subalgebras containing the vector  $f_0$ . All the intersections of the cycle  $\tilde{h}$  with this variety (for  $k = 3$ ) are in an one-to-one correspondence with the pairs of opposite points of  $S^1$  at which the function  $f_0$  takes equal values. Indeed, a generic function  $f_0$  has only finitely many such pairs of points, and the derivative of  $f_0$  does not vanish at these points. By Remark 2 on page 14, for every such pair of points  $(A, A + \pi)$  there exists a unique algebra of the class  $h$  having the support at these points and containing the function  $f_0$ . The number of such pairs of points for a generic  $f_0$  is odd.  $\square$

**Remark 4.** It is easy to see that the cycle  $\tilde{h}$  is homologous to the cycle  $\bar{h}^+ + \bar{h}^-$ . The statement of Proposition 12 with  $\tilde{h}$  replaced by  $h^+ + h^-$  can be proved analogously: in this case the intersection points correspond to the points of  $S^1$  different from the basepoint  $\bullet$ , at which the function  $f_0$  takes the same value as at this basepoint.

**Proposition 13.** *The third Stiefel–Whitney class of the canonical bundle takes the zero value on the cycle  $\bar{d} + \bar{i}_1^+ + \bar{f}_3^- + \bar{h}^+$ .*

*Proof.* Take for  $f_0$  the function  $\sin \varphi$  or any generic function sufficiently close to it in  $C^1$ -topology. This function does not belong to any subalgebras from this cycle. Indeed, the functions from the algebras of classes  $d$  and  $f$  should take the same value at some three different points; each function from any algebra of class  $i$  has a critical point with the critical value equal to the value at some other point; each function from an algebra of the class  $h^+$  has a pair of points with the same value and equal signs of the derivative at these points. The boundary points of these cells consist of functions satisfying even stronger relations and also do not contain  $f_0$ .  $\square$

**Non-generic discriminant subspaces of finite dimensional knot spaces.** For any equi-level algebra of codimension 3 in  $C^\infty(S^1, \mathbb{R})$ , the space of all maps  $(f_1, f_2, f_3) : S^1 \rightarrow \mathbb{R}^3$ , all

whose three components  $f_i$  belong to this algebra, has codimension 9 in  $C^\infty(S^1, \mathbb{R}^3)$ ; correspondingly, the intersection of this space with a *generic* 11-dimensional vector subspace  $\mathcal{L}^{11} \subset C^\infty(S^1, \mathbb{R}^3)$  has dimension 2.

**Proposition 14** (cf. [10], Proposition 2). *For any 11-dimensional vector subspace  $\mathcal{L}^{11} \subset C^\infty(S^1, \mathbb{R}^3)$ , there exists a subalgebra of the class  $\overline{CD}_3(S^1)$  such that the set of maps  $f \in \mathcal{L}^{11}$  whose three components all belong to this algebra is at least three dimensional.*

*Proof.* In the opposite case, all subspaces of codimension 9 defined by equilevel algebras intersect  $\mathcal{L}^{11}$  transversally, so the third Cartesian degree of the canonical bundle over  $\overline{CD}_3(S^1)$  is isomorphic to a subbundle of the constant 11-dimensional bundle, and its orthogonal bundle in it is 2-dimensional. The total Stiefel–Whitney class of this orthogonal bundle is equal to  $(1 + w_1 + w_2 + w_3)^{-3}$  where  $(1 + w_1 + w_2 + w_3)$  is the total Stiefel–Whitney class of the canonical bundle. The degree three homogeneous component of this class is equal to  $w_3$  and is non-trivial by Proposition 12.  $\square$

**Remark 5.** This proof implies that every cycle in  $\overline{CD}_3(S^1)$  homologous to  $\tilde{h}$  or  $\bar{h}^+ + \bar{h}^-$  has a non-empty intersection with the set of algebras non-transversal to the given subspace  $\mathcal{L}^{11}$ .

In the terms of the knot theory, this proposition means that for each 11-dimensional approximating subspace  $\mathcal{L}^{11}$  of the knot space there exist the subspaces of the discriminant variety defined by equilevel algebras and intersecting this approximating space non-transversally.

## APPENDIX: MATRICES OF BOUNDARY OPERATORS

	$\bar{\Upsilon}_1$	$\bar{\Upsilon}_2$	$\bar{\Omega}_1$	$\bar{\Omega}_2$	$\bar{\Lambda}$	$\bar{\Theta}$	$\bar{\nabla}$
$\bar{\Upsilon}_1$	+	+					+
$\bar{\Upsilon}_2$	+	+					+
$\bar{\Omega}_1$			+	+			+
$\bar{\Omega}_2$			+	+			+
$\bar{\Lambda}$							+
$\bar{\Theta}$							
$\bar{U}_{12}$	+			+	+	+	
$\bar{U}_{13}$		+	+		+	+	
$\bar{U}_{21}$	+			+	+	+	
$\bar{U}_{23}$		+	+		+	+	
$\bar{U}_{31}$		+		+	+	+	
$\bar{U}_{32}$		+		+	+	+	
$\bar{V}_1$	+		+	+			
$\bar{V}_2$	+		+	+			
$\bar{V}_3$		+					
$\bar{W}_1$			+	+	+		
$\bar{W}_2$			+	+	+		
$\bar{W}_3$					+		
$\bar{X}$	+						
$\bar{Y}_1$							
$\bar{Y}_2$							
$\bar{Z}_1^+$			+		+	+	
$\bar{Z}_2^+$				+	+	+	
$\bar{Z}_1^-$			+		+	+	
$\bar{Z}_2^-$				+	+	+	
$\bar{T}_1$							
$\bar{T}_2$							
$\bar{J}$							
$\bar{S}$							

Boundary operator  $\partial_2 : C_2 \rightarrow C_1$ .

	$\Theta$	$\Upsilon_1$	$\Upsilon_2$	$\Omega_1$	$\Omega_2$	$\Lambda$	$\bar{U}_{12}$	$\bar{U}_{13}$	$\bar{U}_{21}$	$\bar{U}_{23}$	$\bar{U}_{31}$	$\bar{U}_{32}$	$\bar{V}_1$	$\bar{V}_2$	$\bar{V}_3$	$\bar{W}_1$	$\bar{W}_2$	$\bar{W}_3$	$\bar{X}$
$U_{12}$		+				+	+				+								
$U_{13}$	+			+		+		+				+							
$U_{21}$		+			+			+	+										
$U_{23}$			+	+			+			+									
$U_{31}$	+				+	+				+	+								
$U_{32}$			+			+			+			+							
$V_1$		+		+									+		+				
$V_2$				+	+								+	+					
$V_3$			+		+									+	+				
$W_1$				+		+										+		+	
$W_2$				+	+											+	+		
$W_3$					+	+											+	+	
$X$		+	+																
$Y_1$	+																		
$Y_2$	+																		
$Z_1^+$				+		+													
$Z_2^+$	+				+	+													
$Z_1^-$	+			+		+													
$Z_2^-$					+	+													
$T_1$	+																		
$T_2$	+																		
$J$																			
$S$																			
$\bar{a}_{12}$										+		+	+						+
$\bar{a}_{13}$								+		+	+	+							
$\bar{a}_{14}$							+					+			+				+
$\bar{a}_{23}$								+			+			+					+
$\bar{a}_{24}$							+		+		+	+							
$\bar{a}_{34}$									+		+				+				+
$\bar{b}_{12}$							+						+			+		+	
$\bar{b}_{13}$																+		+	
$\bar{b}_{14}$								+							+				
$\bar{b}_{21}$									+				+			+	+		
$\bar{b}_{23}$							+							+		+	+		
$\bar{b}_{24}$																			
$\bar{b}_{31}$																	+	+	
$\bar{b}_{32}$									+					+			+	+	
$\bar{b}_{34}$										+					+				
$\bar{b}_{41}$											+				+				
$\bar{b}_{42}$																			
$\bar{b}_{43}$												+			+				
$\bar{c}_1$										+		+				+		+	
$\bar{c}_2$											+	+				+	+		
$\bar{c}_3$								+	+								+	+	
$\bar{c}_4$							+		+										
$\bar{d}$																+	+		

Boundary map  $\partial_3 : C_3 \rightarrow C_2$ , left top

	$\bar{Y}_1$	$\bar{Y}_2$	$\bar{Z}_1^+$	$\bar{Z}_2^+$	$\bar{Z}_1^-$	$\bar{Z}_2^-$	$\bar{T}_1$	$\bar{T}_2$	$\bar{J}$	$\bar{S}$
$U_{12}$										
$U_{13}$										
$U_{21}$										
$U_{23}$										
$U_{31}$										
$U_{32}$										
$V_1$										
$V_2$										
$V_3$										
$W_1$										
$W_2$										
$W_3$										
$X$										
$Y_1$	+	+								
$Y_2$	+	+								
$Z_1^+$			+	+						
$Z_2^+$			+	+						
$Z_1^-$					+	+				
$Z_2^-$					+	+				
$T_1$							+	+		
$T_2$							+	+		
$J$										
$S$										
$\bar{a}_{12}$										+
$\bar{a}_{13}$										
$\bar{a}_{14}$										+
$\bar{a}_{23}$										+
$\bar{a}_{24}$	+	+								
$\bar{a}_{34}$										+
$\bar{b}_{12}$				+						
$\bar{b}_{13}$			+			+		+		
$\bar{b}_{14}$					+					
$\bar{b}_{21}$					+					
$\bar{b}_{23}$			+							
$\bar{b}_{24}$			+		+		+			
$\bar{b}_{31}$				+	+			+		
$\bar{b}_{32}$						+				
$\bar{b}_{34}$			+							
$\bar{b}_{41}$				+						
$\bar{b}_{42}$				+		+		+		
$\bar{b}_{43}$						+				
$\bar{c}_1$								+		
$\bar{c}_2$							+			
$\bar{c}_3$								+		
$\bar{c}_4$								+		
$\bar{d}$										

Boundary map  $\partial_3 : C_3 \rightarrow C_2$ , right top

	$\Theta$	$\Upsilon_1$	$\Upsilon_2$	$\Omega_1$	$\Omega_2$	$\Lambda$	$\bar{U}_{12}$	$\bar{U}_{13}$	$\bar{U}_{21}$	$\bar{U}_{23}$	$\bar{U}_{31}$	$\bar{U}_{32}$	$\bar{V}_1$	$\bar{V}_2$	$\bar{V}_3$	$\bar{W}_1$	$\bar{W}_2$	$\bar{W}_3$	$\bar{X}$
$\bar{e}_1^+$										+		+							
$\bar{e}_2^+$								+			+								
$\bar{e}_3^+$							+		+										
$\bar{e}_1^-$										+		+							
$\bar{e}_2^-$								+			+								
$\bar{e}_3^-$							+		+										
$\bar{f}_1^+$																	+	+	
$\bar{f}_2^+$																+		+	
$\bar{f}_3^+$																+	+		
$\bar{f}_1^-$																	+	+	
$\bar{f}_2^-$																+		+	
$\bar{f}_3^-$																+	+		
$\bar{g}_1$																			
$\bar{g}_2$																			
$\bar{g}_3$																			
$\bar{h}^+$																			
$\bar{h}^-$																			
$\bar{i}_1^+$																			
$\bar{i}_2^+$																			
$\bar{i}_1^-$																			
$\bar{i}_2^-$																			

Boundary map  $\partial_3 : C_3 \rightarrow C_2$ , left bottom

	$\bar{Y}_1$	$\bar{Y}_2$	$\bar{Z}_1^+$	$\bar{Z}_2^+$	$\bar{Z}_1^-$	$\bar{Z}_2^-$	$\bar{T}_1$	$\bar{T}_2$	$\bar{J}$	$\bar{S}$
$\bar{e}_1^+$			+			+				
$\bar{e}_2^+$				+	+					
$\bar{e}_3^+$				+	+					
$\bar{e}_1^-$		+		+	+				+	
$\bar{e}_2^-$		+	+			+			+	
$\bar{e}_3^-$	+			+		+			+	
$\bar{f}_1^+$			+			+				
$\bar{f}_2^+$				+	+					
$\bar{f}_3^+$				+	+	+				
$\bar{f}_1^-$				+	+			+		
$\bar{f}_2^-$			+			+		+		
$\bar{f}_3^-$				+		+	+			
$\bar{g}_1$	+						+	+	+	
$\bar{g}_2$	+						+	+	+	
$\bar{g}_3$		+							+	
$\bar{h}^+$			+	+	+	+				
$\bar{h}^-$			+	+	+	+				
$\bar{i}_1^+$			+		+		+			
$\bar{i}_2^+$				+		+		+		
$\bar{i}_1^-$			+		+		+			
$\bar{i}_2^-$				+		+		+		

Boundary map  $\partial_3 : C_3 \rightarrow C_2$ , right bottom

	$U_{12}$	$U_{13}$	$U_{21}$	$U_{23}$	$U_{31}$	$U_{32}$	$V_1$	$V_2$	$V_3$	$W_1$	$W_2$	$W_3$	$X$	$Y_1$	$Y_2$	$Z_1^+$	$Z_1^-$	$Z_2^+$	$Z_2^-$	$T_1$	$T_2$	$J$	$S$
$a_{12}$				+			+						+										
$a_{13}$		+		+		+									+								
$a_{14}$	+					+							+										
$a_{23}$		+			+			+															+
$a_{24}$	+		+		+									+									
$a_{34}$			+						+				+										
$b_{12}$	+						+			+													
$b_{13}$										+						+							
$b_{14}$		+															+						
$b_{21}$			+				+				+												
$b_{23}$								+		+	+					+							
$b_{24}$										+							+				+		
$b_{31}$												+						+				+	
$b_{32}$								+			+	+								+			
$b_{34}$				+					+		+												
$b_{41}$					+													+					
$b_{42}$													+						+				
$b_{43}$						+			+			+											
$c_1$				+		+				+													
$c_2$					+					+	+										+		
$c_3$		+									+	+										+	
$c_4$	+		+									+											
$d$										+	+	+											
$e_1^+$				+		+										+							
$e_2^+$		+			+												+	+					
$e_3^+$	+		+																	+			
$e_1^-$				+		+									+		+						
$e_2^-$		+			+											+			+				+
$e_3^-$	+		+											+				+					
$f_1^+$											+	+				+							
$f_2^+$										+		+					+	+					
$f_3^+$										+	+								+				
$f_1^-$											+	+					+					+	
$f_2^-$										+		+				+			+				
$f_3^-$										+	+							+			+		
$g_1$														+							+		
$g_2$																					+	+	+
$g_3$															+							+	
$h^+$																+	+	+	+				+
$h^-$																+	+	+	+			+	
$i_1^+$																+	+				+		+
$i_1^-$																+	+				+		
$i_2^+$																		+	+			+	+
$i_2^-$																		+	+			+	

Boundary operator  $\partial_4 : C_4 \rightarrow C_3$ , left top



	$\bar{a}_{12}$	$\bar{a}_{13}$	$\bar{a}_{14}$	$\bar{a}_{23}$	$\bar{a}_{24}$	$\bar{a}_{34}$	$\bar{b}_{12}$	$\bar{b}_{13}$	$\bar{b}_{14}$	$\bar{b}_{21}$	$\bar{b}_{23}$	$\bar{b}_{24}$	$\bar{b}_{31}$	$\bar{b}_{32}$	$\bar{b}_{34}$	$\bar{b}_{41}$	$\bar{b}_{42}$	$\bar{b}_{43}$	$\bar{c}_1$	$\bar{c}_2$	$\bar{c}_3$	$\bar{c}_4$	
$a_{12}$	+		+																				
$a_{13}$		+			+																		
$a_{14}$			+			+																	
$a_{23}$	+			+																			
$a_{24}$		+			+																		
$a_{34}$				+		+																	
$b_{12}$							+									+							
$b_{13}$								+										+					
$b_{14}$									+										+				
$b_{21}$									+	+													
$b_{23}$							+				+												
$b_{24}$								+				+											
$b_{31}$										+			+										
$b_{32}$										+				+									
$b_{34}$											+				+								
$b_{41}$															+	+							
$b_{42}$													+				+						
$b_{43}$														+				+					
$c_1$																			+				+
$c_2$																			+	+			
$c_3$																				+	+		
$c_4$																					+	+	
$d$																							
$e_1^+$																							
$e_2^+$																							
$e_3^+$																							
$e_1^-$																							
$e_2^-$																							
$e_3^-$																							
$f_1^+$																							
$f_2^+$																							
$f_3^+$																							
$f_1^-$																							
$f_2^-$																							
$f_3^-$																							
$g_1$																							
$g_2$																							
$g_3$																							
$h^+$																							
$h^-$																							
$i_1^+$																							
$i_1^-$																							
$i_2^+$																							
$i_2^-$																							

Boundary operator  $\partial_4 : C_4 \rightarrow C_3$ , center top

	$\bar{a}_{12}$	$\bar{a}_{13}$	$\bar{a}_{14}$	$\bar{a}_{23}$	$\bar{a}_{24}$	$\bar{a}_{34}$	$\bar{b}_{12}$	$\bar{b}_{13}$	$\bar{b}_{14}$	$\bar{b}_{21}$	$\bar{b}_{23}$	$\bar{b}_{24}$	$\bar{b}_{31}$	$\bar{b}_{32}$	$\bar{b}_{34}$	$\bar{b}_{41}$	$\bar{b}_{42}$	$\bar{b}_{43}$	$\bar{c}_1$	$\bar{c}_2$	$\bar{c}_3$	$\bar{c}_4$
$\bar{B}_1^1$	+		+				+											+	+			
$\bar{B}_1^2$								+									+		+			
$\bar{B}_1^3$		+							+							+						
$\bar{B}_2^1$					+		+			+										+	+	
$\bar{B}_2^2$								+				+								+		
$\bar{B}_2^3$			+	+					+		+										+	
$\bar{B}_3^1$	+					+				+					+						+	
$\bar{B}_3^2$												+	+									+
$\bar{B}_3^3$				+							+			+							+	+
$\bar{B}_4^1$		+													+			+				
$\bar{B}_4^2$													+				+					+
$\bar{B}_4^3$				+		+								+		+						+
$\bar{B}_5^1$			+			+										+		+				+
$\bar{B}_5^2$																						+
$\bar{B}_5^3$					+											+		+				
$\bar{C}_{12}$															+			+	+			
$\bar{C}_{13}$																	+					
$\bar{C}_{14}$												+										
$\bar{C}_{15}$										+				+								+
$\bar{C}_{23}$																+		+		+		
$\bar{C}_{24}$																	+					
$\bar{C}_{25}$													+									
$\bar{C}_{34}$									+							+					+	
$\bar{C}_{35}$								+														
$\bar{C}_{45}$							+			+												+
$\bar{D}_{12}^+$							+			+												
$\bar{D}_{12}^-$							+			+												
$\bar{D}_{13}^+$								+					+									
$\bar{D}_{13}^-$								+					+									
$\bar{D}_{14}^+$									+								+					
$\bar{D}_{14}^-$									+								+					
$\bar{D}_{23}^+$										+				+								
$\bar{D}_{23}^-$										+				+								
$\bar{D}_{24}^+$												+						+				
$\bar{D}_{24}^-$												+						+				
$\bar{D}_{34}^+$															+			+				
$\bar{D}_{34}^-$															+			+				
$\bar{E}_+$																						
$\bar{E}_1$																						
$\bar{E}_2$																						
$\bar{E}_3$																						

Boundary operator  $\partial_4 : C_4 \rightarrow C_3$ , center bottom

	$\bar{d}$	$\bar{e}_1^+$	$\bar{e}_2^+$	$\bar{e}_3^+$	$\bar{e}_1^-$	$\bar{e}_2^-$	$\bar{e}_3^-$	$\bar{f}_1^+$	$\bar{f}_2^+$	$\bar{f}_3^+$	$\bar{f}_1^-$	$\bar{f}_2^-$	$\bar{f}_3^-$	$\bar{g}_1$	$\bar{g}_2$	$\bar{g}_3$	$\bar{h}^+$	$\bar{h}^-$	$\bar{i}_1^+$	$\bar{i}_1^-$	$\bar{i}_2^+$	$\bar{i}_2^-$	
$a_{12}$																							
$a_{13}$																							
$a_{14}$																							
$a_{23}$																							
$a_{24}$																							
$a_{34}$																							
$b_{12}$																							
$b_{13}$																							
$b_{14}$																							
$b_{21}$																							
$b_{23}$																							
$b_{24}$																							
$b_{31}$																							
$b_{32}$																							
$b_{34}$																							
$b_{41}$																							
$b_{42}$																							
$b_{43}$																							
$c_1$																							
$c_2$																							
$c_3$																							
$c_4$																							
$d$																							
$e_1^+$		+		+																			
$e_2^+$		+	+																				
$e_3^+$			+	+																			
$e_1^-$					+		+																
$e_2^-$					+	+																	
$e_3^-$						+	+																
$f_1^+$								+		+													
$f_2^+$								+	+														
$f_3^+$									+	+													
$f_1^-$											+		+										
$f_2^-$											+	+											
$f_3^-$												+	+										
$g_1$														+		+							
$g_2$														+	+								
$g_3$															+	+							
$h^+$																							
$h^-$																							
$i_1^+$																				+		+	
$i_1^-$																					+		+
$i_2^+$																				+		+	
$i_2^-$																					+		+

Boundary operator  $\partial_4 : C_4 \rightarrow C_3$ , right top

	$\bar{d}$	$\bar{e}_1^+$	$\bar{e}_2^+$	$\bar{e}_3^+$	$\bar{e}_1^-$	$\bar{e}_2^-$	$\bar{e}_3^-$	$\bar{f}_1^+$	$\bar{f}_2^+$	$\bar{f}_3^+$	$\bar{f}_1^-$	$\bar{f}_2^-$	$\bar{f}_3^-$	$\bar{g}_1$	$\bar{g}_2$	$\bar{g}_3$	$\bar{h}^+$	$\bar{h}^-$	$\bar{i}_1^+$	$\bar{i}_1^-$	$\bar{i}_2^+$	$\bar{i}_2^-$	
$\bar{B}_1^1$																						+	
$\bar{B}_1^2$		+																					+
$\bar{B}_1^3$					+											+							
$\bar{B}_2^1$					+									+									
$\bar{B}_2^2$		+																				+	
$\bar{B}_2^3$																					+		
$\bar{B}_3^1$																					+		
$\bar{B}_3^2$			+																			+	
$\bar{B}_3^3$						+									+								
$\bar{B}_4^1$						+										+							
$\bar{B}_4^2$			+																				+
$\bar{B}_4^3$																						+	
$\bar{B}_5^1$																						+	
$\bar{B}_5^2$				+																			+
$\bar{B}_5^3$							+									+							
$\bar{C}_{12}$												+											
$\bar{C}_{13}$									+	+	+												
$\bar{C}_{14}$								+	+				+										
$\bar{C}_{15}$												+											
$\bar{C}_{23}$													+										
$\bar{C}_{24}$								+		+		+											
$\bar{C}_{25}$											+												
$\bar{C}_{34}$											+												
$\bar{C}_{35}$												+											
$\bar{C}_{45}$											+												
$\bar{D}_{12}^+$				+					+	+													
$\bar{D}_{12}^-$							+					+	+	+					+				
$\bar{D}_{13}^+$								+	+														
$\bar{D}_{13}^-$											+	+											
$\bar{D}_{14}^+$			+																				
$\bar{D}_{14}^-$						+											+		+				
$\bar{D}_{23}^+$				+				+		+													
$\bar{D}_{23}^-$							+				+		+		+				+				
$\bar{D}_{24}^+$																					+		+
$\bar{D}_{24}^-$																						+	+
$\bar{D}_{34}^+$		+																					
$\bar{D}_{34}^-$					+												+		+				
$\bar{E}_+$										+	+	+								+			
$\bar{E}_1$									+	+	+												+
$\bar{E}_2$								+		+		+											+
$\bar{E}_3$								+	+				+								+		

Boundary map  $\partial_4 : C_4 \rightarrow C_3$ , right bottom

	$a_{12}$	$a_{13}$	$a_{14}$	$a_{23}$	$a_{24}$	$a_{34}$	$b_{12}$	$b_{13}$	$b_{14}$	$b_{21}$	$b_{23}$	$b_{24}$	$b_{31}$	$b_{32}$	$b_{34}$	$b_{41}$	$b_{42}$	$b_{43}$	$c_1$	$c_2$	$c_3$	
$B_1^1$	+		+				+													+		
$B_1^2$								+												+		
$B_1^3$		+							+													
$B_2^1$					+		+			+												+
$B_2^2$								+				+										
$B_2^3$				+					+		+											+
$B_3^1$	+					+				+						+						
$B_3^2$											+	+									+	+
$B_3^3$											+			+							+	+
$B_4^1$		+													+				+			+
$B_4^2$													+					+				
$B_4^3$				+										+			+					+
$B_5^1$			+			+													+			
$B_5^2$																		+				
$B_5^3$					+											+						
$C_{12}$															+			+	+			
$C_{13}$																	+					
$C_{14}$												+										
$C_{15}$											+			+								
$C_{23}$																+					+	
$C_{24}$																						
$C_{25}$													+									
$C_{34}$									+													+
$C_{35}$								+														
$C_{45}$							+			+												
$D_{12}^+$							+			+												
$D_{12}^-$							+			+												
$D_{13}^+$								+					+									
$D_{13}^-$								+					+									
$D_{14}^+$									+								+					
$D_{14}^-$									+								+					
$D_{23}^+$											+			+								
$D_{23}^-$											+			+								
$D_{24}^+$												+						+				
$D_{24}^-$												+						+				
$D_{34}^+$															+			+				
$D_{34}^-$															+			+				
$E_+$																						
$E_1$																						
$E_2$																						
$E_3$																						
$\bar{A}_{11}$																						
$\bar{A}_{12}$																						
$\bar{A}_{13}$																						
$\bar{A}_{21}$																						
$\bar{A}_{22}$																						
$\bar{A}_{23}$																						
$\bar{A}_{31}$																						
$\bar{A}_{32}$																						
$\bar{A}_{33}$																						
$\bar{A}_{41}$																						
$\bar{A}_{42}$																						
$\bar{A}_{43}$																						
$\bar{A}_{51}$																						
$\bar{A}_{52}$																						
$\bar{A}_{53}$																						

	$c_4$	$d$	$e_1^+$	$e_1^-$	$e_2^+$	$e_2^-$	$e_3^+$	$e_3^-$	$f_1^+$	$f_1^-$	$f_2^+$	$f_2^-$	$f_3^+$	$f_3^-$	$g_1$	$g_2$	$g_3$	$h^+$	$h^-$	$i_1^+$	$i_1^-$	$i_2^+$	$i_2^-$
$B_1^1$																							
$B_1^2$			+																				
$B_1^3$				+																			
$B_2^1$																+							
$B_2^2$																						+	
$B_2^3$																					+		
$B_3^1$						+																	
$B_3^2$							+										+						
$B_3^3$																		+					
$B_4^1$																							
$B_4^2$																							+
$B_4^3$																						+	
$B_5^1$	+																						
$B_5^2$	+							+															
$B_5^3$									+														
$C_{12}$		+																					
$C_{13}$		+												+									
$C_{14}$		+										+						+					
$C_{15}$												+											
$C_{23}$																							+
$C_{24}$									+			+	+										
$C_{25}$		+								+	+												
$C_{34}$											+												
$C_{35}$		+							+														
$C_{45}$	+	+																					
$D_{12}^+$								+						+									
$D_{12}^-$									+						+	+							
$D_{13}^+$												+							+				+
$D_{13}^-$												+											+
$D_{14}^+$					+																		
$D_{14}^-$						+														+			
$D_{23}^+$									+				+										
$D_{23}^-$										+				+		+				+			
$D_{24}^+$											+								+		+		
$D_{24}^-$												+										+	
$D_{34}^+$			+						+														
$D_{34}^-$				+						+								+					
$E_+$										+		+		+							+		+
$E_1$										+	+		+										+
$E_2$										+		+	+										
$E_3$										+	+			+								+	
$\bar{A}_{11}$																							
$\bar{A}_{12}$																							
$\bar{A}_{13}$																							
$\bar{A}_{21}$																							
$\bar{A}_{22}$																							
$\bar{A}_{23}$																							
$\bar{A}_{31}$																							
$\bar{A}_{32}$																							
$\bar{A}_{33}$																							
$\bar{A}_{41}$																							
$\bar{A}_{42}$																							
$\bar{A}_{43}$																							
$\bar{A}_{51}$																							
$\bar{A}_{52}$																							
$\bar{A}_{53}$																							

	$\bar{B}_1^1$	$\bar{B}_1^2$	$\bar{B}_1^3$	$\bar{B}_2^1$	$\bar{B}_2^2$	$\bar{B}_2^3$	$\bar{B}_3^1$	$\bar{B}_3^2$	$\bar{B}_3^3$	$\bar{B}_4^1$	$\bar{B}_4^2$	$\bar{B}_4^3$	$\bar{B}_5^1$	$\bar{B}_5^2$	$\bar{B}_5^3$	$\bar{E}_+$	$\bar{E}_1$	$\bar{E}_2$	$\bar{E}_3$	$\bar{C}_{12}$	$\bar{C}_{13}$	$\bar{C}_{14}$		
$B_1^1$	+												+											
$B_1^2$		+												+										
$B_1^3$			+												+									
$B_2^1$			+	+																				
$B_2^2$		+			+																			
$B_2^3$	+					+																		
$B_3^1$						+	+																	
$B_3^2$					+			+																
$B_3^3$				+					+															
$B_4^1$									+	+														
$B_4^2$								+			+													
$B_4^3$							+					+												
$B_5^1$												+	+											
$B_5^2$										+				+										
$B_5^3$										+					+									
$C_{12}$																					+			
$C_{13}$																						+		
$C_{14}$																							+	
$C_{15}$																								+
$C_{23}$																					+			
$C_{24}$																						+		
$C_{25}$																								+
$C_{34}$																								
$C_{35}$																								
$C_{45}$																								
$D_{12}^+$																								
$D_{12}^-$																								
$D_{13}^+$																								
$D_{13}^-$																								
$D_{14}^+$																								
$D_{14}^-$																								
$D_{23}^+$																								
$D_{23}^-$																								
$D_{24}^+$																								
$D_{24}^-$																								
$D_{34}^+$																								
$D_{34}^-$																								
$E_+$																								
$E_1$																		+		+				
$E_2$																		+	+					
$E_3$																			+	+				
$\bar{A}_{11}$	+						+						+			+					+			
$\bar{A}_{12}$		+																	+		+			
$\bar{A}_{13}$			+							+												+		
$\bar{A}_{21}$														+				+						
$\bar{A}_{22}$																			+	+				+
$\bar{A}_{23}$											+							+				+		
$\bar{A}_{31}$				+												+					+			
$\bar{A}_{32}$																						+		
$\bar{A}_{33}$																		+		+		+		+
$\bar{A}_{41}$					+															+	+			+
$\bar{A}_{42}$																		+	+			+		
$\bar{A}_{43}$								+												+				+
$\bar{A}_{51}$						+						+	+			+								
$\bar{A}_{52}$														+					+					
$\bar{A}_{53}$									+						+									

	$\bar{C}_{15}$	$\bar{C}_{23}$	$\bar{C}_{24}$	$\bar{C}_{25}$	$\bar{C}_{34}$	$\bar{C}_{35}$	$\bar{C}_{45}$	$\bar{D}_{12}^+$	$\bar{D}_{12}^-$	$\bar{D}_{13}^+$	$\bar{D}_{13}^-$	$\bar{D}_{14}^+$	$\bar{D}_{14}^-$	$\bar{D}_{23}^+$	$\bar{D}_{23}^-$	$\bar{D}_{24}^+$	$\bar{D}_{24}^-$	$\bar{D}_{34}^+$	$\bar{D}_{34}^-$
$B_1^1$																			
$B_1^2$																			
$B_1^3$																			
$B_2^1$																			
$B_2^2$																			
$B_2^3$																			
$B_3^1$																			
$B_3^2$																			
$B_3^3$																			
$B_4^1$																			
$B_4^2$																			
$B_4^3$																			
$B_5^1$																			
$B_5^2$																			
$B_5^3$																			
$C_{12}$	+																		
$C_{13}$				+															
$C_{14}$						+													
$C_{15}$	+						+												
$C_{23}$		+																	
$C_{24}$			+																
$C_{25}$				+															
$C_{34}$		+			+														
$C_{35}$			+			+													
$C_{45}$					+		+												
$D_{12}^+$								+				+							
$D_{12}^-$									+				+						
$D_{13}^+$										+						+			
$D_{13}^-$											+						+		
$D_{14}^+$												+						+	
$D_{14}^-$													+						+
$D_{23}^+$								+						+					
$D_{23}^-$									+						+				
$D_{24}^+$										+						+			
$D_{24}^-$											+						+		
$D_{34}^+$														+				+	
$D_{34}^-$															+				+
$E_+$																			
$E_1$																			
$E_2$																			
$E_3$																			
$\bar{A}_{11}$		+					+												
$\bar{A}_{12}$			+			+												+	
$\bar{A}_{13}$													+						+
$\bar{A}_{21}$							+	+											
$\bar{A}_{22}$			+														+		
$\bar{A}_{23}$				+	+							+							
$\bar{A}_{31}$		+							+										+
$\bar{A}_{32}$			+	+		+				+									
$\bar{A}_{33}$																	+		
$\bar{A}_{41}$						+												+	
$\bar{A}_{42}$			+	+		+					+								
$\bar{A}_{43}$				+	+						+								
$\bar{A}_{51}$	+	+			+														
$\bar{A}_{52}$	+													+					
$\bar{A}_{53}$		+			+								+		+				

Boundary operator  $C_5 \rightarrow C_4$ , fourth and last page



	$A_{11}$	$A_{12}$	$A_{13}$	$A_{21}$	$A_{22}$	$A_{23}$	$A_{31}$	$A_{32}$	$A_{33}$	$A_{41}$	$A_{42}$	$A_{43}$	$A_{51}$	$A_{52}$	$A_{53}$
$B_1^1$	+														
$B_1^2$		+													
$B_1^3$			+												
$B_2^1$							+								
$B_2^2$										+					
$B_2^3$													+		
$B_3^1$	+														
$B_3^2$												+			
$B_3^3$															+
$B_4^1$			+												
$B_4^2$						+									
$B_4^3$													+		
$B_5^1$	+														
$B_5^2$				+											
$B_5^3$							+								
$C_{12}$	+	+													
$C_{13}$				+		+		+	+						
$C_{14}$								+	+	+		+			
$C_{15}$													+	+	
$C_{23}$							+					+	+		+
$C_{24}$					+			+	+		+				
$C_{25}$						+		+			+	+			
$C_{34}$			+									+	+		+
$C_{35}$		+						+		+	+				
$C_{45}$	+			+											
$D_{12}^+$				+											
$D_{12}^-$							+								
$D_{13}^+$								+							
$D_{13}^-$											+				
$D_{14}^+$												+			
$D_{14}^-$															+
$D_{23}^+$														+	
$D_{23}^-$															+
$D_{24}^+$								+							
$D_{24}^-$									+						
$D_{34}^+$		+													
$D_{34}^-$			+												
$E_+$								+					+		
$E_1$						+					+				
$E_2$					+									+	
$E_3$									+	+					
$\bar{A}_{11}$	+												+		
$\bar{A}_{12}$		+								+					
$\bar{A}_{13}$			+				+								
$\bar{A}_{21}$				+										+	
$\bar{A}_{22}$					+						+				
$\bar{A}_{23}$				+		+									
$\bar{A}_{31}$							+								+
$\bar{A}_{32}$															
$\bar{A}_{33}$					+				+						
$\bar{A}_{41}$										+		+			
$\bar{A}_{42}$									+		+				
$\bar{A}_{43}$						+						+			
$\bar{A}_{51}$	+												+		
$\bar{A}_{52}$		+												+	
$\bar{A}_{53}$			+												+

Boundary operator  $C_6 \rightarrow C_5$

## REFERENCES

- [1] D. Bar-Natan, *On the Vassiliev knot invariants*, *Topology* 34 (1995) 423–472.
- [2] J.S. Birman and X-S. Lin, *Knot polynomials and Vassiliev's invariants*, *Invent. Math.* 111 (1993) 225–270.
- [3] S. Chmutov, S. Duzhin, and J. Mostovoy, *Introduction to Vassiliev knot invariants*, Cambridge University Press, Cambridge, 2012, xvi+504 pp.
- [4] D.B. Fuchs, *Cohomologies of the braid group mod 2*, *Funct. Anal. Appl.*, 4:2 (1970), 143—151.
- [5] H. Hironaka, *Resolution of singularities of an algebraic variety over a field of characteristic zero*, *Ann. Math.* 79 109–326 (1964)
- [6] M. Spivakovsky, *Resolution of Singularities: An Introduction*. In: Cisneros Molina, J.L., Lê, D.T., Seade, J. (eds) *Handbook of Geometry and Topology of Singularities I*. Springer, Cham 2020, 183–242.
- [7] V.A. Vassiliev, *Cohomology of knot spaces*, in *Theory of Singularities and its Applications (Providence)* (V. I. Arnold, ed.), Amer. Math. Soc., Providence, 1990, 23–69.
- [8] V.A. Vassiliev, *Topology of discriminants and their complements*, *Proceedings of the International Congress of Mathematicians (Zürich, 1994)*, v. 1, Birkhäuser, Basel, 1995, 209–226.
- [9] V.A. Vassiliev, *Varieties of chord diagrams, braid group cohomology and degeneration of equality conditions*, *Pacific Journal of Mathematics*, 326:1 (2023), 135–160 , arXiv: 2108.00463
- [10] V.A. Vassiliev, *On the cohomology of varieties of chord diagrams*, arXiv: 2412.18508

WEIZMANN INSTITUTE OF SCIENCE

*Email address:* vavassiliev@gmail.com