



ω -Regular Robustness

Dana Fisman  

Department of Computer Science, Ben-Gurion University, Israel

Elina Sudit  

Department of Computer Science, Ben-Gurion University, Israel

Abstract

Roughly speaking, a system is said to be *robust* if it can resist disturbances and still function correctly. For instance, if the requirement is that the temperature remains in an allowed range $[l, h]$, then a system that remains in a range $[l', h'] \subset [l, h]$ is more robust than one that reaches l and h from time to time. In this example the initial specification is quantitative in nature, this is not the case in ω -regular properties. Still, it seems there is a natural robustness preference relation induced by an ω -regular property. E.g. for a property requiring that every request is eventually granted, one would say that a system where requests are granted two ticks after they are issued is more robust than one in which requests are answered ninety ticks after they are issued. In this work we manage to distill a *robustness preference relation* that is induced by a given ω -regular language. The relation is a semantic notion (agnostic to the given representation of L) that satisfies some natural criteria.

1 Introduction

A temporal logic formula classifies execution paths into two: the ones that satisfy it and the ones that do not. In various settings a finer classification is needed. Various quantitative formalisms can be used to specify which among two satisfying (resp. violating) executions is better (resp. worse). To qualify *better*, a natural notion is that of *robustness*. Loosely speaking, a system is *robust* if it can resist more disturbances and faults and still satisfy the property. For instance, consider a property requiring a surface to endure a weight of 60 Kg. Among two systems that satisfy it the one that endures a larger weight is more robust. Among two systems that violate it, still the one that endures a larger weight is preferable. In this example the nature of robustness is tied to the quantitative nature of weight, a similar quantitative aspect is present in many other studied notions of robustness. We, on the other hand, are interested in the robustness preference relation that seems to be induced from an ω -regular property itself, e.g. from a plain temporal logic formula in, say, LTL.

Notions of robustness Various works have considered problems related to robust verification and synthesis. In particular, robustness issues have been tackled in the context of timed systems, hybrid systems and cyber-physical systems [32, 21, 33, 17, 27]. The nature of robustness studied in these works relates to the inherent quantitative nature of these systems, e.g. realtime values of the atomic signals and/or the continuous (non-discrete) nature of time, and is thus very different from the notion of robustness we are looking for.

Focusing on ω -regular languages in the Boolean (aka qualitative) setting, numerous works considered robustness from the angle of assume-guarantee [36, 23, 11, 12, 10]. Considering robustness from a view that relates to cost of errors and edit distance metrics was pursued in [26] which suggested using weighted transducers for modeling deviations and faults by which one would like to measure the robustness of systems. Working with weighted transducers provides a general way to model deviations, but it leaves the task of defining how to model deviations to an outside source. These and other works on quantitative reasoning assume the automata or temporal logic are equipped with some numeric values reflecting weights or costs [20, 22, 35, 25, 19, 4, 3, 15, 16, 2, 34]. We are interested in a way to seam-

lessly obtain a robustness measure from a typical ω -regular specification (e.g. given by a temporal logic formula or an ω -automaton).

The desired notion of robustness It seems there is a natural notion of robustness that can be inferred from an ω -regular property (given e.g. by an ω -automaton) without additional means. We find that in many properties recurring in the literature, when comparing two words, it is obvious which should be considered more robust wrt the specification at hand. For example, in properties capturing response time one always considers words where the waiting time is shorter as more robust. Our main goal in the work presented here is to manage to distill the natural robustness preference relation that an ω -regular language induces.

A great inspiration for us is the work of Tabuada and Neider [45] which proposed rLTL, a multi-valued refinement of the semantics of the temporal logic LTL. Indeed, in terms of syntax the logic rLTL is identical to LTL, the difference is in the semantics. That is, in contrast to the above mentioned works, rLTL captures robustness that relates solely to a plain (non-quantified) LTL specification, and does not require additional inputs from the user. As a motivating example Tabuada and Neider give the following example.

▷ **Example 1.1 (Basic TN).** Consider the formula $\mathbf{G}a$ (always a) over the alphabet $\Sigma = \{a, b\}$. The word $w_1 = a^\omega$ satisfies it, and the words $w_2 = bbba^\omega$, $w_3 = (ab)^\omega$, $w_4 = aaab^\omega$, $w_5 = b^\omega$ do not. Still, our intuition tells us that w_2 falsifies it less than w_3 , that w_3 falsifies it less than w_4 , and that w_4 less than w_5 . Indeed, comparing w_2 and w_3 , we note that w_2 satisfies it all along except in the first three ticks whereas in w_3 it is violated infinitely often. Similar intuitions entail that w_3 falsifies it less than w_4 since in the former infinitely often the desired signal a holds, whereas in the latter from some point onward a no longer holds. Similar reasoning warrant that w_4 falsifies it less than w_5 , in which it is constantly violated.

The formal explanation of these intuitions that w_i is more robust (wrt $\mathbf{G}a$) than w_{i+1} for $1 \leq i < 5$ considers the formulas $\varphi_1 = \mathbf{G}a$ (always a), $\varphi_2 = \mathbf{F}\mathbf{G}a$ (eventually always a), $\varphi_3 = \mathbf{G}\mathbf{F}a$ (always eventually a), $\varphi_4 = \mathbf{F}a$ (eventually a), $\varphi_5 = \mathbf{G}\neg a$ (never a). Comparing the words w_1, w_2, w_3, w_4, w_5 we have that w_i satisfies φ_i yet w_i does not satisfy φ_j for $j < i$. To capture this Tabuada and Neider propose a 5-valued semantics, where the 5 values, roughly speaking, correspond to these five representative formulas. This idea has been extended to various other temporal logics [40, 41, 39] and is the baseline for the notion we seek for.

Inspired by these intuitions, we look for a preference relation on words, induced by an ω -regular language L that is refined into an infinite value semantics, in the following way.

▷ **Example 1.2 (Refined TN).** Using rLTL we can distinguish the satisfaction of w_1, \dots, w_5 above wrt $L_2 = \mathbf{G}a$. Since indeed $w_i \models \varphi_i$ and $w_i \not\models \varphi_j$ for $j < i$. However, we cannot distinguish $w'_3 = (a^{1000}ba^{999})^\omega$ from $w''_3 = (aba)^\omega$ since both satisfy φ_3 and do not satisfy φ_1 or φ_2 . But our intuition says that w'_3 is more robust than w''_3 since only one change in 2000 ticks is required to make w'_3 satisfy $\mathbf{G}a$ whereas one change in every 3 ticks is required to make w''_3 satisfy $\mathbf{G}a$. Note that Tabuada & Neider's approach regards the non-periodic, aka *transient* part of the word and deems $w_2 = bbba^\omega$ less robust than $w_1 = a^\omega$. We would like to make this distinction more refined and comparing $w'_2 = b^2a^\omega$ and $w''_2 = b^{100}a^\omega$ declare that w'_2 is more robust than w''_2 (wrt $\mathbf{G}a$). Similarly, we would like to distinguish $w'_4 = a^{10000}b^\omega$ from $w''_4 = a^3b^\omega$ and say that (wrt $\mathbf{G}a$) w'_4 is more robust than w''_4 .

Since our goal is hard to express formally — as our desire is to distill a supposedly natural robustness preference relation that is induced by a language — we provide a couple of more examples showing what we view as the natural robustness implied by common properties.

▷ **Example 1.3 (Response time, Starting time).** A common LTL property is $L = \mathbf{G}(r \rightarrow \mathbf{F}g)$ stipulating that every request (signal r) should eventually be followed by a grant (signal g). Assume the alphabet $\Sigma = 2^{\{r,g\}} = \{rg, r\bar{g}, \bar{r}g, \bar{r}\bar{g}\}$. Wrt L , many papers [9, 13, 12, 2, 8, 1, 30, 31] view $(r\bar{g} \cdot (\bar{r}\bar{g})^i \cdot \bar{r}g)^\omega$ as more robust than $(r\bar{g} \cdot (\bar{r}\bar{g})^j \cdot \bar{r}g)^\omega$ if $i < j$. That is, we view a trace where the response time is shorter as more robust compared to one where it is longer.

Wrt $L' = \text{reset}^* \cdot \text{start} \cdot (\text{busy}^* \cdot \text{done})^\omega$ for $i < j$ we require (using first letter abbreviations of the signals) $(r)^i s(b^k d)^\omega \triangleright_{L'} (r)^j s(b^k d)^\omega$ where \triangleright_L stands for *more robust wrt L*. That is, we view a trace where the *start* signal arrives earlier as more robust.

▷ **Example 1.4 (No redundant grants).** In the context of synthesis, it is observed that the above property $\mathbf{G}(r \rightarrow \mathbf{F}g)$ is not strong enough as it puts no requirements on issuing grants [9, 12]. In real implementations issuing grants is costly and often one strengthens this property by requiring no redundant grants. The resulting property is $L'' = \mathbf{G}(r \rightarrow \mathbf{F}g) \wedge \mathbf{G}(g \rightarrow \mathbf{X}[\neg g \mathbf{W}r]) \wedge [\neg g \mathbf{W}r]$. Here we would like $(r\bar{g} \cdot \bar{r}\bar{g} \cdot \bar{r}g)^\omega \triangleright_{L''} (r\bar{g} \cdot \bar{r}\bar{g} \cdot (\bar{r}\bar{g})^2)^\omega \triangleright_{L''} (r\bar{g} \cdot \bar{r}\bar{g} \cdot (\bar{r}\bar{g})^i)^\omega$ for $i > 2$. That is, we prefer traces with fewer redundant grants.

Our aim is to develop a notion of robustness that matches the above intuitions and is derived *solely* from a given ω -regular language L . The idea is to *distill* from L itself a preference relation \triangleright_L for which $w \triangleright_L w'$ entails that w is more robust than w' wrt L .

We do so by distilling from L a value function $\text{rbst}_L : \Sigma^\omega \rightarrow \mathbb{T}$ assigning word w a value from a totally ordered infinite set \mathbb{T} that captures its *robustness value* wrt L . Towards this semantic definition we introduce a semantic notion for the *rank* of the k -th letter of an infinite word w (wrt L) and the *color* of the k -th letter (wrt L). These rely on the notion of natural rank of an infinite word [24]. We also introduce the semantic notion of *dominant-suffixes* from which we entail a definition of equivalence classes \equiv^\diamond . The equivalence classes yield a definition of what we denote \mathcal{P}_L^\diamond and term *the robustness parity automaton* for L . The size of \mathcal{P}_L^\diamond may be exponential in the size of the minimal parity automaton for L . This is expected since it conveys more information, and all state-of-the-art canonical representation for ω -regular languages have the same lower bound blowup.¹

Due to space restrictions, some proofs, examples and figures are deferred to the appendix.

2 Preliminaries

We use \mathbb{B} for the set $\{\text{T}, \text{F}\}$ or $\{0, 1\}$. We use $[1..m]$ to denote the set $\{1, 2, \dots, m\}$. Given a word $v = \sigma_1 \sigma_2 \dots \sigma_m$ we use $v[i..j]$ for the prefix of v starting at σ_i and ending in σ_j , inclusive; and $v[..\bar{i}]$ (resp. $v[\bar{i}..]$) for the prefix (resp. suffix) of v that ends (resp. starts) in σ_i , inclusive. We use parenthesis instead of brackets if we want to exclude i and/or j . E.g. $v[2..\bar{5}] = \sigma_2 \sigma_3 \sigma_4$ and $v(2..\bar{5}) = \sigma_3 \sigma_4$, and $v[2..) = v[2..\bar{1}] = \sigma_2 \sigma_3 \dots \sigma_{m-1}$.

The set of all infinite words over Σ is denoted Σ^ω . A word $w \in \Sigma^\omega$ is termed a *lasso word* if $w = u(v)^\omega$ for some $u \in \Sigma^*$ and $v \in \Sigma^+$. We refer to u as the *spoke* of the lasso, and to v as its *period*. A pair (u, v) for $u \in \Sigma^*$ and $v \in \Sigma^+$ is a *representation* of the lasso word $u(v)^\omega$. Note that a lasso word $w \in \Sigma^\omega$ has many representations. E.g. $w = aa(ba)^\omega$ can be represented as (aa, ba) , (a, ab) , $(aabab, abab)$ etc.

A *deterministic ω -automaton* is a tuple $\mathcal{A} = (\Sigma, Q, q_0, \delta, \alpha)$ consisting of an alphabet Σ , a finite set Q of states, an initial state $q_0 \in Q$, a transition function $\delta : Q \times \Sigma \rightarrow Q$, and an acceptance condition α . We refer to the first four components of an automaton

¹ The canonical representation known so far for ω -regular languages are: the syntactic FORC [38], the recurrent FDFA [6], the limit FDFA [37], the colorful FDFA [28] and the precise parity automaton [14].

as the *automaton-structure*. A run of an automaton is defined in the usual manner. An ω -automaton accepts a word if the run on that word is accepting. There are various ω -acceptance conditions in the literature (e.g. parity, Rabin, Streett, Muller); all are defined with respect to the set of states visited infinitely often during a run. For a run $r = q_0q_1q_2\dots$ we define $\text{inf}(r) = \{q \in Q \mid \forall i \in \mathbb{N}. \exists j > i. q_j = q\}$.

The ω -acceptance condition we work with is parity. A *parity* acceptance condition is a mapping $\kappa : Q \rightarrow \{0, 1, \dots, k\}$ of the states to a number in a given bounded set $\{0, 1, \dots, k\}$, which we refer to as *ranks* (and we refer to $\kappa(q)$, for a state q , as the *rank* of q). For a subset $Q' \subseteq Q$, we use $\kappa(Q')$ for the set $\{\kappa(q) \mid q \in Q'\}$. A run r of a parity automaton is accepting if the minimal rank in $\kappa(\text{inf}(r))$ is even. We use DPA for deterministic parity automata. Henceforth, all languages mentioned in the paper are assumed to be ω -regular, i.e. accepted by DPA. It is well known that two ω -regular languages are equivalent iff they agree on the set of lasso words. Henceforth when we say $w \in \Sigma^\omega$ we mean w is a lasso word over Σ .

We use $\llbracket \mathcal{A} \rrbracket$ to denote the set of words accepted by a given acceptor \mathcal{A} . For $u \in \Sigma^*$, we use $\mathcal{A}(u)$ for the state we reach on reading u from the initial state. For $q \in Q$, we use \mathcal{A}_q for $(\Sigma, Q, q, \delta, \alpha)$, namely the automaton obtained from \mathcal{A} by making q the initial state. We associate with \mathcal{A} its automaton graph $G = (V, E)$ where $V = Q$ and $E = \{(v, v') \mid v' \in \delta(v, \sigma) \text{ for some } \sigma \in \Sigma\}$. A subset C of vertices (i.e., states) is termed a *strongly connected component* (SCC) if there is a non-empty path between any pair of vertices in C . An SCC is termed a *maximal strongly connected component* (MSCC) if there is no SCC $C' \supsetneq C$. Note that a run of an automaton \mathcal{A} on a word w must eventually stay within a single MSCC (i.e. visit no state outside of this MSCC). We term such an MSCC the *final* MSCC of w wrt L .

The *syntactic right congruence relation* for an ω -language L relates two finite words x and y if there is no infinite suffix z differentiating them, that is, for $x, y \in \Sigma^*$, $x \sim_L y$ if $\forall z \in \Sigma^\omega (xz \in L \iff yz \in L)$. We use $[u]_{\sim_L}$ (or simply $[u]$) for the equivalence class of u induced by \sim_L . A right congruence \sim can be naturally associated with an automaton structure (Σ, Q, q_0, δ) as follows: the set of states Q are the equivalence classes of \sim . The initial state q_0 is the equivalence class $[\epsilon]$. The transition function δ is defined by $\delta([u], \sigma) = [u\sigma]$. We use $\mathcal{A}[\sim]$ to denote the automaton structure induced by \sim .

3 Requirements for the robustness preference relation

Given an ω -regular language L , we would like to define a preference relation on ω -words, denoted \triangleright_L , such that $w_1 \triangleright_L w_2$ conveys that w_1 is more robust than w_2 with respect to L . We can do so by defining a value function $\text{rbst}_L : \Sigma^\omega \rightarrow \mathbb{T}$ and then defining $w \triangleright_L w'$ if $\text{rbst}_L(w) \geq \text{rbst}_L(w')$. As mentioned in the introduction, the definition should meet our intuitions and adhere to some mathematical properties. In the following we try to formalize the requirements from this definition.

▷ **Requirement 3.1 (Reflect disturbances wrt L).** First \triangleright_L has to *respect* L . Meaning, words in L should be preferred over words not in L . Second, when comparing two words w and w' that are both in L , roughly speaking, we would like w to be more robust than w' if more changes are required to make w not in L (compared to w'). If both w and w' are not in L we would like w to be more robust if fewer changes are required to make it in L .

▷ **Example 3.2.** For the specification $L_1 = \infty a$, both a^ω and $(ab)^\omega$ are accepted by the language. We expect a^ω to be preferred over $(ab)^\omega$ since intuitively, in the former there are more options to deviate (by taking an action different from a) and still satisfy the property.

▷ Requirement 3.3 (Meet and refine Tabuada and Neider's idea [45]). As discussed in the introduction, we would like the relation to convey the idea behind the definition of the 5-valued semantics of rLTL [45]. As exemplified in Ex. 1.1 wrt $L = \mathbf{G}a$ the relation should agree with the following order: $(a)^\omega \triangleright_L bbb(a)^\omega \triangleright_L (ba)^\omega \triangleright_L aaa(b)^\omega \triangleright_L (b)^\omega$. Furthermore, as explained in Ex. 1.2, we would like the relation to refine this order so that for every $i < j$ it agrees with the following: $\bullet b^i(a)^\omega \triangleright_L b^j(a)^\omega \bullet (b^i a)^\omega \triangleright_L (b^j a)^\omega \bullet (ba^j)^\omega \triangleright_L (ba^i)^\omega$.

▷ Requirement 3.4 (Convey response/ starting time). A classical LTL formula is $\mathbf{G}(r \rightarrow \mathbf{F}g)$ where r stands for a *request* signal and g for a *grant* signal. Conveying the time that elapses between issuing a request and receiving a grant, and preferring that grants arrive earlier appears often in the literature, see e.g. [9, 13, 12, 2, 8, 1, 30, 31]. Accordingly, as per Ex. 1.3 for $L = \mathbf{G}(a \rightarrow \mathbf{F}b)$ over $\Sigma = \{a, b, c\}$ we would like $(ac^i b)^\omega \triangleright_L (ac^j b)^\omega$ for every $i < j$, and for $L' = r^*s(b^k d)^\omega$, we would like $(r)^i s(b^k d)^\omega \triangleright_{L'} (r)^j s(b^k d)^\omega$ if $i < j$.

▷ Example 3.5. In a broader sense, if there is a requirement that some sequence of events occurs infinitely often, we prefer words where it occurs as often as possible. Consider $\Sigma = \{a, b\}$ and $L_4 = \infty ab$ requiring ab to occur infinitely often. The words $(ab)^\omega$ and $(ba)^\omega$ should be the most robust, and more robust than $(aabb)^\omega$, for instance.

▷ Requirement 3.6 (Sensitivity to both the periodic and transient parts of the word). Considering a lasso word $u(v)^\omega$, the periodic part v is more significant than u since v occurs infinitely many times in the word whereas u occurs just once. For this reason many aggregators considered in analysis of infinite words [15] such as LimSup , LimInf , LimSupAvg , etc. essentially ignore the transient part. An exception is DiscSum (discounted sum) which gives more weight to early events and thus is affected more by the transient part. The latter is definitely not suitable here, since we'd like the periodic part to be more significant. But neither are the formers, since they completely disregard the transient part, whereas if two words agree on the period we would like the spoke to determine which one is more robust. This is the case for instance in Ex. 1.2 where wrt $\mathbf{G}a$ we expect $b^i(a)^\omega \triangleright_L b^j(a)^\omega$ if $i < j$.²

▷ Requirement 3.7 (Duality). Robustness is sometimes used when considering words (resp. languages) that satisfy (resp. are subsumed in) the given language L and sometimes when considering words (resp. languages) that falsify (resp. are not subsumed by) the given language L . It is important for us that the defined robustness preference relation would refine both accepted and rejected words, and would do so in a symmetrical manner. Ideally, it should satisfy $w_1 \triangleright_L w_2$ iff $w_1 \triangleleft_{\bar{L}} w_2$ where \bar{L} is the complement language of L .

▷ Requirement 3.8 (Satisfaction bar). As per Req. 3.3, with respect to $L_2 = \mathbf{G}a$ we require $w_1=(a)^\omega \triangleright_L w_2=bbb(a)^\omega \triangleright_L w_3=(ba)^\omega \triangleright_L w_4=aaa(b)^\omega \triangleright_L w_5=(b)^\omega$. What if we consider $L_1 = \mathbf{G}\mathbf{F}a$ instead? We still expect the same order between these words. However, we would like to convey that for L_2 , the word w_1 is the only one satisfying it, whereas for L_1 all words w_i for $i \leq 3$ satisfy it. Using $\text{rbst}_L(w)$, the robustness value associated with word w wrt L , we require there is a clear bar between values of accepted and rejected words. Specifically, we demand $\text{rbst}_L(w) \geq \mathbb{0}$ iff $w \in L$ (where $\mathbb{0}$ is a special element of the value domain \mathbb{T}).

² We note that in [29] the well known notion of normalized edit distance on finite words (NED) was generalized to a *normalized edit distance on infinite words* ($\bar{\omega}$ -NED). While being defined as a function between a pair of words (rather than as a relation or value function induced from a given language) it does capture some of the intuitions discussed above, in particular measuring how many letters one should change to transform a word into another one. However, since it is based on the notion of LimSup it completely disregards the spoke of the word, contrary to the classification of Tabuada and Neider, and its refinement sought for here.

▷ Requirement 3.9 (Avoid debts). Consider the language $L = a\Sigma^\omega \vee bc^\omega$. If the first letter is a then there are no further requirements. If the first letter is b then there is a constant demand that c will hold in every future tick. Thus any word starting with a should be preferred over any word starting with b , which in a sense constantly creates a debt that should be satisfied in the future. The following examples further illustrate the requirement that words that create less debts should be preferred over words that create more debts.

▷ Example 3.10. Let L_3 be the language $\infty a \wedge (\infty aa \rightarrow \infty aaa)$ over the alphabet $\{a, b\}$. We expect $(ab)^\omega \triangleright_{L_3} (aaab)^\omega$ since after taking a it is safer to take a b than to take an a which requires taking a third a immediately after; or more accurately, seeing aa infinitely often requires seeing aaa infinitely often. We expect the most preferred word wrt L_3 to be a^ω since in debt terms we are in debt only once, and there is no word that creates zero debts.

The challenge in obtaining such a relation is that we require it to be derived solely from the given ω -regular language, without relying on a specific representation of it. That is, we want a *semantic* rather than a *syntactic* definition of the robustness preference relation.

4 Towards the definition of robustness preference relation

Next we would like to obtain a formal definition of the robustness value with respect to a given language. We require our definition to be semantic, namely derived from the language itself rather than from a particular representation of the language. To this aim we inspect our examples with respect to the *inclusion measure* of the Wagner hierarchy [46]. The inclusion measure is a semantic property — it holds on all ω -automata recognizing the same language, regardless if they are minimal, and regardless of their type (parity, Rabin, Streett, Muller, etc.). Note that for all (deterministic) ω -automata types the acceptance of a word w is determined using some condition on $\inf(\rho_w)$, where ρ_w is the run of the automaton on w . Thus, given an SCC S we can classify it as *accepting* (resp. *rejecting*) if $\inf(\rho_w) = S$ implies w is accepted (resp. rejected). The *inclusion measure* considers the SCCs of the automaton graph (all SCCs, not just MSCCs), and counts the maximal number of SCCs in an inclusion chain of SCCs $S_1 \subset S_2 \subset \dots \subset S_k$ where S_i is accepting iff S_{i+1} is rejecting for $1 \leq i < k$, a so called *alternating inclusion chain*. Wagner has shown that for a given language L this measure is the same for all ω -automata recognizing L [46], irrespective of the number of states or the automaton type [43], and is thus a semantic property. If the largest inclusion chain of an automaton for L is k and the innermost SCC is accepting (resp. rejecting), we say that $L \in \mathbb{DM}_k^+$ (resp. $L \in \mathbb{DM}_k^-$). If $L \in \mathbb{DM}_k^+$ and $L \in \mathbb{DM}_k^-$ we say $L \in \mathbb{DM}_k^\pm$.

Fig. B.1 shows the inclusion measure on parity automata for some of the discussed examples. We can see that $\mathcal{P}_1 \in \mathbb{DM}_2^-$, $\mathcal{P}_2 \in \mathbb{DM}_1^\pm$ and $\mathcal{P}_3 \in \mathbb{DM}_4^-$. Looking at \mathcal{P}_1 for ∞a and at \mathcal{P}_2 for $\mathbf{G}a$ and considering the words $w_1 = a^\omega$, $w_2 = bbba^\omega$, $w_3 = (ab)^\omega$, $w_4 = aaab^\omega$, $w_5 = b^\omega$ from Ex. 1.1 and Req. 3.3 we can see that words that eventually do not visit the rejecting component are preferred over words that visit it infinitely often which are preferred over words that eventually visit only it. Considering the words from Ex. 1.2 and the preferences $\bullet b^i(a)^\omega \triangleright_L b^j(a)^\omega \bullet (b^i a)^\omega \triangleright_L (b^j a)^\omega \bullet (ba^j)^\omega \triangleright_L (ba^i)^\omega$ for $i < j$ from Req. 3.3 we can see that words that spend less time on the rejecting component (or reach it fewer times) are preferred over words that spend more time on the rejecting components (or reach it more times). The reader is invited to check that this is the case in all other discussed examples.

Natural ranks of ω -words and their infixes

There is a tight correlation between the minimal number of ranks used by a parity automaton, and the inclusion measure of the language [42, 18, 43]. Based on this correlation Ehlers and Schewe have managed to define the semantic notion of *natural ranks of infinite words* [24].³ Given an ω -regular language $L \subseteq \Sigma^\omega$ and a word $w \in \Sigma^\omega$, its *natural rank* is a natural number in a range $\{0, 1, \dots, k\}$ that reflects the minimal (state-)rank it can receive in a parity automaton for L whose (state-)ranks are as low as possible. We use $\Omega_L^{\text{word}}(w)$ for the natural rank of w wrt L .

The definition of a natural rank of a word, follows the intuition of Niwinski and Walukiewicz in their construction for minimizing the number of ranks in a parity automaton [42]. The observation is that if a DPA requires n ranks then one can reveal in its transition graph a structure resembling a flower, in the sense that it has a center state q from which there are at least n loops (forming the petals of the flower) such that the minimal ranks visited along the different petals form a sequence $c_1 < c_2 < \dots < c_n$ of ranks with alternating parity. For instance, in \mathcal{P}_3 of Fig. B.1 there is a flower with center state 3 and petals b , ab , aab , $aaab$ with ranks 3, 2, 1, 0, respectively. This flower structure is useful for understanding the natural ranks as we explain next.

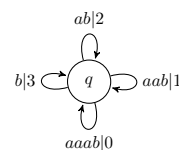

The following notations are needed for the formal definition of a natural rank. A word $z \in \Sigma^*$ is said to be a *suffix invariant* of $u \in \Sigma^*$ with respect to L if $uz \sim_L u$. That is, no suffix distinguishes between u and the word obtained by concatenating z to u . A word w' is *obtained from* $w = \sigma_1\sigma_2\sigma_3\dots$ *by an infinite series of injections* of suffix invariant words z_1, z_2, z_3, \dots at positions i_1, i_2, i_3, \dots if $w' = \sigma_1\sigma_2\dots\sigma_{i_1}z_1\sigma_{i_1+1}\sigma_{i_1+2}\dots\sigma_{i_2}z_2\sigma_{i_2+1}\dots$, where z_j is suffix invariant wrt $\sigma_1\dots\sigma_{i_j}$. We use $\text{inj}_I(w)$ for the set of words w' obtained from w by such an infinite series of injections at positions in $I = i_1, i_2, \dots$. The injections are the semantical way to capture the said flower structure. When such a flower structure exists with center state q , reached by word u , and v_1, v_2, \dots, v_k are petals, then $uv_i \sim_L u$ for all $i \in [1..k]$ and if $w = u(v_i)^\omega$ then $w' = u(v_i v_j)^\omega$ is in $\text{inj}_I(w)$ for all $j \in [1..k]$ and the respective I .

The formal definition of a natural rank is inductive, starting with 0 and 1 at the base (where 1 can also be obtained in the inductive step). Loosely speaking, a word w has natural rank 0 if it is in L , as are all words $w' \in \text{inj}_I(w)$ for some $I \subseteq \mathbb{N}$. Similarly, a word w has natural rank 1 if it is not in L and there exists $I \subseteq \mathbb{N}$ such that all $w' \in \text{inj}_I(w)$ either have rank 0 or are not in L . Inductively, a word has natural rank k if there exists $I \subseteq \mathbb{N}$ such that w is in L (resp. not in L) and k is even (resp. odd) and all words $w' \in \text{inj}_I(w)$ have a smaller natural rank or are also in (resp. not in) L , and there exists at least one word $w' \in \text{inj}_I(w)$ that has natural rank $k-1$.⁴ Below we give a slightly modified definition, with two additional base cases $-2, -1$. Their importance will be made clear in the sequel.

► **Definition 4.1** (Natural rank of an infinite word [24], slightly altered). *We define the **natural rank** of an infinite word w wrt L , denoted $\Omega_L^{\text{word}}(w)$ (or simply $\Omega^{\text{word}}(w)$ when L is clear*

³ The term used in [24] is *natural colors* but we want to reserve the word *color* for something else.

⁴ Note that the last part of this sentence (that there exists a words with natural rank $k-1$) need not hold for the case of rank 1 which can be obtained as one of the base cases rather than as the inductive step.

from the context) as follows.

$$\Omega_L^{\text{word}}(w) = \begin{cases} -2 & \text{if } \exists u \prec w. \forall z \in \Sigma^\omega. uz \in L \\ -1 & \text{else if } \exists u \prec w. \forall z \in \Sigma^\omega. uz \notin L \\ 0 & \text{else if } w \in L \text{ and } \exists I \subseteq \mathbb{N}. \forall w' \in \text{inj}_I(w). w' \in L \\ 1 & \text{else if } w \notin L \text{ and } \exists I \subseteq \mathbb{N}. \forall w' \in \text{inj}_I(w). w' \notin L \\ i & \text{else if } i = \min \left\{ j \left| \begin{array}{l} j \text{ is even iff } w \in L \text{ and } \exists I \subseteq \mathbb{N}. \\ \forall w' \in \text{inj}_I(w). (\Omega_L^{\text{word}}(w') < j \text{ or} \\ w' \in L \iff w \in L) \end{array} \right. \right\} \end{cases}$$

Note that Def. 4.1 makes use of the *existence* of a sequence I of injection points. For a given language L and given word w there could be sequences I' and I'' such that I' can be used in the definition to prove that the natural rank of w wrt L is what it is, while I'' cannot. Consider for instance $L_3 = \infty a \wedge (\infty aa \rightarrow \infty aaa)$ and $w = a^\omega$, we have that $\Omega_{L_3}^{\text{word}}(w) = 0$. The sequence $I'' = 1, 2, 3, 4, \dots$ cannot be used to show this, since, e.g. $(ab)^\omega \in \text{inj}_{I''}(w)$ yet $\Omega_{L_3}^{\text{word}}((ab)^\omega) = 2 > \Omega_{L_3}^{\text{word}}(w)$. The sequence $I' = 5, 10, 15, 20, \dots$ however, can be used, as for any injection in these points, the rank of the resulting word will be 0. Put otherwise, the definition of natural rank [24] is not specific about which sequence of points can be used, it merely requires that such a sequence exists.

▷ **Example 4.2.** On the discussed examples, whose parity automata are given in Fig.B.1, the following holds. For $L_1 = \infty a$ we have $\Omega_{L_1}^{\text{word}}((ab)^\omega) = 0$ and $\Omega_{L_1}^{\text{word}}(aaa(b)^\omega) = 1$. For $L_2 = \mathbf{G}a$ we have $\Omega_{L_2}^{\text{word}}(a^\omega) = 0$ and $\Omega_{L_2}^{\text{word}}(w) = -1$ for every $w \neq (a)^\omega$. For the language $L_3 = \infty a \wedge (\infty aa \rightarrow \infty aaa)$ we have $\Omega_{L_3}^{\text{word}}(a^5 b^\omega) = 3$, $\Omega_{L_3}^{\text{word}}(aa(ab)^\omega) = 2$, $\Omega_{L_3}^{\text{word}}(bbb(aab)^\omega) = 1$ and $\Omega_{L_3}^{\text{word}}(baba(aaab)^\omega) = 0$, and last $\Omega_{L_3}^{\text{word}}(bababb(a)^\omega) = 0$.

Note that the natural ranks alone do not suffice to obtain the desired order. E.g. wrt $L_1 = \infty a$ all words $(a)^\omega$, $bbb(a)^\omega$ and $(ab)^\omega$ have the same natural-rank 0 while we want to distinguish them and have $(a)^\omega \triangleright_{L_1} bbb(a)^\omega \triangleright_{L_1} (ab)^\omega$. We need a way to capture that $(a)^\omega$ stays forever within the accepting part of its SCC, whereas $bbb(a)^\omega$ spends some time at the subsumed rejecting SCC and $(ab)^\omega$ crosses to a subsumed rejecting component over and over.

To this aim we would like to associate a rank to the letters in a word, so that we can distinguish letters that remain in the same accepting SCC and letters that cross from an accepting SCC to a subsumed rejecting one. In a sense, we ask for any $k \in \mathbb{N}$ whether taking the k -th letter is desirable, where we view the k -th letter as part of a loop that the entire ω -word traverses infinitely often. We build on the definition of a natural rank of a period starting with v wrt a given spoke u as the maximal rank that such a period can get if it closes a loop on the spoke u [14], with some adaptation to non-negative and immaterial ranks.

► **Definition 4.3** (Natural rank of an infix [14], slightly altered). *Let $u \in \Sigma^*$, $v \in \Sigma^*$. Let $L_{u,v} = \{u(vz)^\omega \mid vz \in \Sigma^+, uvz \sim_L u\}$. The rank of a period starting with v following a spoke u , denoted $\Omega_L^{\text{infix}}(u, v)$, is*

$$\Omega_L^{\text{infix}}(u, v) = \begin{cases} -2 & \text{if } \forall w \in \Sigma^\omega. uvw \in L \\ -1 & \text{if } \forall w \in \Sigma^\omega. uvw \notin L \\ \max \{ \Omega_L^{\text{word}}(w) \mid w \in L_{u,v} \} & \text{if } L_{u,v} \neq \emptyset \\ \infty & \text{otherwise} \end{cases}$$

▷ **Example 4.4.** Wrt $L_3 = \infty a \wedge (\infty aa \rightarrow \infty aaa)$ we have that $\Omega^{\text{infix}}(\varepsilon, b) = 3$ (witnessed by $z = \varepsilon$), $\Omega^{\text{infix}}(\varepsilon, a) = 2$ (witnessed by $z = b$), $\Omega^{\text{infix}}(\varepsilon, aa) = 1$ (witnessed by $z = b$), and $\Omega^{\text{infix}}(\varepsilon, aaa) = 0$ (witnessed by $z = \varepsilon$). Note that Ω^{infix} is more informative than Ω^{word} since

$(a)^\omega = (aa)^\omega = (aaa)^\omega = a^\omega$, yet the different sequence of a 's have different Ω^{infix} . Since L_3 is prefix-independent, replacing the spoke ε with any other spoke u we get the same results.

► **Remark 4.5.** Note that reading a longer prefix of the period, its rank can only decrease, that is, $\Omega_L^{infix}(u, vy) \leq \Omega_L^{infix}(u, v)$. Moreover, if $u \sim_L xy$ then also $\Omega_L^{infix}(x, yv) \leq \Omega_L^{infix}(u, v)$ [14].

5 Defining the robustness value

Consider an infinite word w , if we look at the rank of its prefixes wrt some given spoke, it is a monotonically non-increasing sequence. When the minimum is reached, it will stay so and reading any additional letter, this sequence of ranks no longer provides any meaningful information regarding the next read letter. In order to get some meaningful information on the current letter we have to forget the past from time to time, and start looking at the rank of a period that does not start at the very beginning but rather at some later point. That is, we want to "reset" the calculation of ranks from time to time. If we reset in very long intervals, we still get the effect that the sequence of ranks from the last reset point is not very informative regarding late indices. If we reset very often we may get a result that is higher than the true rank of the index we are currently looking at. The challenge is thus to find the best places to make a reset, so that the observed rank provides the correct information regarding the desired index. Put otherwise, for each index k we'd like to determine what is the *dominant suffix* of $w[..k]$. If it is $w[j..k]$ then j is our reset point.

For instance, in the language ∞ab , given a prefix that ends with $a^i b$, it suffices to know that it ends with ab since what we care for is to see a b following an a , so the dominant suffix is ab . For $L_3 = \infty a \wedge (\infty aa \rightarrow \infty aaa)$ given a prefix that ends with a^i , if $i \geq 3$ it suffices to know that there is a suffix of three a 's, but we definitely do not want to shorten a suffix of three a 's to just one a . So the dominant suffix should be aaa if $i \geq 3$; aa if $i = 2$; and a if $i = 1$. In the following we develop the notions that will serve us in defining this formally.

5.1 Defining natural ranks of letters

Considering some infix of an infinite word, whose rank is, say d , we can say that its last index is *influential* if there exists a suffix of the given infix for which the last index makes a difference, namely it decreases the rank to d . Formally, this is defined as follows where $\Omega_L^{infix}(w, j, k)$ is used as a shorthand for $\Omega_L^{infix}(w[..j], w[j..k])$

► **Definition 5.1** (Influential index). *Let $w \in \Sigma^* \cup \Sigma^\omega$ and $L \subseteq \Sigma^\omega$. We say that index k of w is *influential* wrt index $i < k$ (and L) if there exists $j \in [i..k]$ such that*

$$\Omega_L^{infix}(w, j, k) < \Omega_L^{infix}(w, j, k-1) \quad \text{and} \quad \Omega_L^{infix}(w, j, k) = \Omega_L^{infix}(w, i, k).$$

See Ex. B.1 for an example showing how to calculate whether an index is influential.

We define the dominant suffix using the dominant index, the index from which the dominant suffix begins. If the current index is influential, namely it decreases the potential with regard to some suffix, it suffices to take the shortest suffix that has the same potential as the entire infix. If the current index is not influential, then for all suffixes, the value with this index is the same as the value without this index. The value of the last index alone, can be higher than the entire infix, and so we should reset to a suffix with the potential of the last letter alone. Here we reset to the longest such suffix, in order not to lose information. E.g. if the language is $\infty abcde$. Then the rank of the suffixes $a, ab, abc, abcd$ is 1, but of course after reading, say abc , we want the dominant suffix to be abc so we know to expect de .

► **Definition 5.2** (Dominant index). Let $w \in \Sigma^* \cup \Sigma^\omega$. Let $i \leq k \leq |w|$. The *dominant index* of w wrt i and k , denoted $\text{dom-ind}_L(w, i, k)$, is j where • If k is influential wrt i then $w[j..k]$ is the shortest suffix of $w[i..k]$ for which $\Omega_L^{\text{infix}}(w, j, k) = \Omega_L^{\text{infix}}(w, i, k)$. • Otherwise, $w[j..k]$ is the longest suffix of $w[i..k]$ for which $\Omega_L^{\text{infix}}(w, j, k) = \Omega_L^{\text{infix}}(w, k, k)$. When $w \in \Sigma^*$ we use $\text{dom-ind}_L(w, i)$ as a shorthand for $\text{dom-ind}_L(w, i, |w|)$.

From this definition we can associate with each index k an index $j_k \leq k$ that is the *reset point* for k . Intuitively, the natural rank of letter k (as we shortly define) can be computed from the suffix $w[j_k..k]$ rather than the entire prefix $w[..k]$.

► **Definition 5.3** (Reset points). Let $w \in \Sigma^* \cup \Sigma^\omega$ and k a natural number satisfying $k \leq |w|$. We define the *reset point* of k wrt w and L , denoted $r_w(k)$ inductively as follows. For the base case $r_w(0) = 0$. For $k > 0$, we let $r_w(k) = \text{dom-ind}_L(w, r_w(k-1), k)$.

The following claim asserts that computing the dominant index of k wrt any $i < r_w(k-1)$ is the same as wrt $r_w(k-1)$.

► **Claim 5.4.** $\text{dom-ind}_L(w, i, k) = \text{dom-ind}_L(w, r_w(k-1), k)$ for all $k \in \mathbb{N}$ and $i \leq r_w(k-1)$.

The following is a direct consequence of Clm. 5.4.

► **Corollary 5.5.** $\text{dom-ind}_L(w, 0, k) = \text{dom-ind}_L(w, r_w(k-1), k) = r_w(k)$.

► **Definition 5.6** (Dominant suffix). Let $v \in \Sigma^*$. The *dominant suffix* of v wrt L , denoted $\text{dom-suf}_L(v)$, is $v[r_v(|v|)..]$.

Applying Clm. 5.4 on the definition of dominant suffix we obtain the following.

► **Corollary 5.7.** $\text{dom-suf}_L(\text{dom-suf}_L(x) \cdot \sigma) = \text{dom-suf}_L(x\sigma)$ for every $x \in \Sigma^*$ and $\sigma \in \Sigma$.

We are now ready to define the natural rank of the k -th letter of an infinite word w .

► **Definition 5.8** (Natural rank of a letter). Let $w \in \Sigma^* \cup \Sigma^\omega$ and $k \leq |w|$. The *natural rank of the k -th letter* of w , denoted $\Omega_L^{\text{letter}}(w, k)$, is $\Omega_L^{\text{infix}}(w, r_w(k), k)$. For a finite word $v \in \Sigma^*$ we use $\Omega_L^{\text{letter}}(v)$ as an abbreviation for $\Omega_L^{\text{letter}}(v, |v|)$.

Ex. B.2 exemplifies how to calculate the natural ranks of two words wrt two languages.

The following theorem states a correlation between the minimal natural rank of the letters that occur infinitely often and the natural rank of the entire infinite word.

► **Theorem 5.9** (Natural rank words/ letters correlation). Let $L \subseteq \Sigma^\omega$ and w be a lasso word. Let n_1, n_2, \dots be such that $n_i = \Omega_L^{\text{letter}}(w, i)$. Then $\Omega_L^{\text{word}}(w) = d$ if and only if $\min \inf(n_1, n_2, \dots) = d$.

5.2 Defining colors and scores for letters and infixes

Now that each letter has its own rank, we can color the letters of the word following our intuitions from the Wagner hierarchy. Let $w = \sigma_1\sigma_2\dots$ be an infinite word. We would like to give the i -th letter of the word a *color* reflecting its transition between accepting/rejecting SCCs, and whether this is done in the direction of the inclusion chain or opposite to it.

Let $d = \Omega_L^{\text{letter}}(w, i)$ and $d' = \Omega_L^{\text{letter}}(w, i+1)$. We can *try* saying that the $i+1$ -th letter has color • *green* if d' is even and $d \geq d'$, • *yellow* if $d < d'$, • *red* if d' is odd and $d \geq d'$. Green and red letters represent moving to a subsuming SCC or staying in the same SCC, whereas yellow letters go against the direction of the inclusion chain. The distinction between green

and red depends on the nature of the SCC, namely whether it is accepting or rejecting. But this coloring scheme doesn't yet match the intuition from all of our examples. Consider the language $L_2 = \mathbf{G}a$ and its automaton \mathcal{P}_2 (Fig.B.1). We would like to say that $ba^\omega \triangleright b^{100}a^\omega$ but there is no difference in the colors of their letters — in both words, after taking the first letter, we reach a rejecting sink, and accordingly the rest of the letters are red all along.

This is since reading the first b , the property is already violated. Namely the b prefix cannot be recovered, even if the extension is a^ω , namely there was just one fault at the beginning and then everything was okay. For this reason we added the natural ranks -1 and -2 where -1 reflects that no extension of the read prefix is in the language, and -2 reflects that all extensions of the read prefix are in the language. Using these ranks we define the color of a letter, using the following notion of the *forgetful-version* of a word.

► **Definition 5.10** (Forgetful version of a word). *For a finite or infinite word $w = \sigma_1\sigma_2\dots$ its forgetful version wrt L , denoted $\text{fg}_L(w)$ (or simply $\text{fg}(w)$ when L is clear from the context) is defined inductively as follows: $\text{fg}_L(w) = \sigma'_1\sigma'_2\sigma'_3\dots$ where*

$$\sigma'_1 = \begin{cases} \sigma_1 & \text{if } \Omega_L^{\text{letter}}(\sigma_1) \geq 0 \\ \varepsilon & \text{otherwise} \end{cases} \quad \sigma'_{i+1} = \begin{cases} \sigma_{i+1} & \text{if } \Omega_L^{\text{letter}}(\sigma'_1 \cdots \sigma'_i \cdot \sigma_{i+1}) \geq 0 \\ \varepsilon & \text{otherwise} \end{cases}$$

For instance, the forgetful version of both ba^ω and $b^{100}a^\omega$ wrt $\mathbf{G}a$ is a^ω since $\Omega^{\text{word}}(bw) = -1$ for every $w \in \Sigma^\omega$. While this seems to forget too much, the following revised definition of colors of letters will not forget these b 's.

► **Definition 5.11** (Color of a letter). *Let $w = \sigma_1\sigma_2\dots \in \Sigma^\omega$. Let $d = \Omega^{\text{letter}}(\text{fg}(w[..\cdot i]) \cdot \sigma_i)$ and $d' = \Omega^{\text{letter}}(\text{fg}(w[..\cdot i]) \cdot \sigma_{i+1})$. The $i+1$ -th letter has color $\theta(d, d')$ where $\theta(d, d')$ is*

$$\begin{array}{lll} \text{white} & \text{if } d' = -2 & \text{green} & \text{if } d' \text{ is even and } d \geq d' & \text{yellow} & \text{if } d < d' \\ \text{black} & \text{if } d' = -1 & \text{red} & \text{if } d' \text{ is odd and } d \geq d' & & \end{array}$$

We use $\text{color}_w(i)$ for the color of the i -th letter in w (wrt L which is implicit).

Going back to our example of ba^ω and $b^{100}a^\omega$ wrt $\mathbf{G}a$ we get that the colors of ba^ω are black for the first letter, and green for the rest, whereas for $b^{100}a^\omega$ we get that the first 100 letters are colored black and the the rest are green, which provides information to conclude that ba^ω is more robust than $b^{100}a^\omega$. Given an infix of an infinite word we can count how many letters from each color it has.

► **Definition 5.12** (Infix colors). *Let $w \in \Sigma^\omega$ and consider its infix $w[j..k]$. Let $c_i = \text{color}_w(i)$ be the color of the i -th letter for $i \in [j..k]$. Let*

$$\begin{array}{llll} W = |\{i \in [j..k]: c_i = \text{white}\}| & G = |\{i \in [j..k]: c_i = \text{green}\}| & Y = |\{i \in [j..k]: c_i = \text{yellow}\}| \\ B = |\{i \in [j..k]: c_i = \text{black}\}| & R = |\{i \in [j..k]: c_i = \text{red}\}| & & \end{array}$$

We use $\text{colors}_w(j, k)$, for the tuple (W, G, Y, R, B) providing the number of letters of each color in the infix $w[i..j]$ (wrt L which is implicit).

Using the colors of an infix we can define the *score of the infix*. To this aim we note that green and red letters have the opposite influence on the acceptance of the word. In a sense, they cancel each other, and so the difference between the number of greens and the number of reds is what matters. The same is true for white and black letters. Accordingly we define:

► **Definition 5.13** (Score of an infix). *Let $w \in \Sigma^\omega$ and $j, k \in \mathbb{N}$. Let $\text{colors}_w(j, k) = (W, G, Y, R, B)$. The score of the infix $w[j..k]$ wrt L , denoted $\text{score}_w(j, k)$, is the tuple (WB, GR) where $WB = W - B$, $GR = G - R$. Its averaged score, denoted $\text{avgscore}_w(j, k)$ is $(\frac{WB}{l}, \frac{GR}{l})$ where $l = |w[j..k]|$.*

5.3 The robustness value definition and properties

As we shortly define, the robustness value is a tuple of numbers from a domain \mathbb{T} , where elements are compared component-wise and the leftmost bit is the most significant. Let $w \in \Sigma^\omega$ and assume (u, v) is a good decomposition of it.⁵ The abstract form of the robustness value of w is (a_w, s_v, s_u) where a_w , aka the *acceptance bit* is 1 if $w \in L$ and -1 otherwise; s_v is a tuple reflecting the *period-value* and s_u is a tuple reflecting the *spoke-value*. Obviously, the value should first take into account whether the word is accepted or not; and among the period and spoke, the period should be more dominant.

Note that the second and third components are the period's and spoke's *values*, not their *scores*. Moreover, as we explain next, the value of the spoke is computed in a different manner from the value of a period. For the value of the period, we would like v and vv to receive the same value, since they induce the same infinite word. Accordingly, the value of the period is its averaged score.

For the value of the spoke, things are a little bit more complicated. Here we would like to take into account the length of the spoke. But whether a shorter or a longer spoke is preferred depends on the relation between the averaged scores of the period and spoke. Consider the language $L = \infty a$, and the words $w_1 = bb(ab)^\omega$, $w_2 = bbbbb(ab)^\omega$. Clearly, w_1 with the shorter spoke should be determined more robust than w_2 with the longer spoke. But considering the same language and the words $w_3 = aa(ab)^\omega$ and $w_4 = aaaaa(ab)^\omega$, obviously w_4 with the longer spoke should be determined more robust than w_3 with the shorter spoke. Accordingly, the value of the spoke considers the difference between the averaged scores of the spoke and period, multiplied by the length of the spoke. Put otherwise, it asks for each letter of the spoke how much better or worse it is compared to the averaged score of the period, and sums these values. Note that a given lasso word has many decompositions into a spoke and a period, and different decompositions may yield different results. E.g. for $L_3 = \infty a \wedge (\infty aa \rightarrow \infty aaa)$ and $w = a^\omega$ we would like a decomposition where the period has aaa . If it has a shorter sequence of a 's the rank of the period would be wrong. For the spoke we would like the shortest spoke reaching a correct period. We thus define:

► **Definition 5.14** (The robustness decomposition). *Let $w \in \Sigma^\omega$ be a lasso word. Its *robustness decomposition* wrt L , denoted $rbst-dcmp_L(w)$ is the shortest decomposition (u, v) satisfying $w = uv^\omega$, $\Omega_L^{infix}(u, v) = \Omega_L^{word}(w)$.⁶*

We are finally ready to define the desired robustness value.

► **Definition 5.15** (The robustness value). *Let $rbst-dcmp_L(w) = (u, v)$ where $|u| = k$ and $|v| = l$. Let $\tau_u = avgscore_w(1, k)$, $\tau_v = avgscore_w(k+1, k+l)$, and a_w the acceptance bit. The *robustness value* of w wrt L , denoted $rbst_L(w)$ is the tuple $(a_w, \tau_v, k(\tau_u - \tau_v))$.*

Ex. B.3 provides examples of words, languages and the respective robustness value. The robustness values are elements in $\{-1, 1\} \times [-1, 1]^2 \times \mathbb{Q}^2$. Letting $\mathbb{T} = \{-1, 0, 1\} \times [-1, 1]^2 \times \mathbb{Q}^2$ and $\mathbb{0} = (0, 0, 0, 0, 0)$, it is immediate that the value function $rbst_L$ refines L , since its most significant component is the acceptance bit, which is positive iff $w \in L$.

► **Claim 5.16** (Satisfaction bar). $rbst_L(w) \geq \mathbb{0}$ iff $w \in L$.

⁵ We will shortly define what is a good decomposition.

⁶ I.e., for every x, y satisfying $w = xy^\omega$, $\Omega_L^{infix}(x, y) = \Omega_L^{word}(w)$ we have $|uv| < |xy|$.

It follows from Def. 5.13 that the score of an infix $w[j, k]$ wrt a language L is the negative of the score of $w[j, k]$ wrt \bar{L} , the complement of L . Obviously, this holds also for the averaged-score. Since this is also true for the acceptance bit, Def. 5.15 guarantees:

► **Claim 5.17** (Value wrt complement). $rbst_L(w) = -rbst_{\bar{L}}(w)$ for every w and L .

Using the robustness value we can define the robustness preference relation.

► **Definition 5.18** (The robustness preference relation). *The **robustness preference relation** is defined as follows. We say that $w_1 \succeq_L w_2$ if $rbst_L(w_1) \geq rbst_L(w_2)$ where \geq works component-wise and the left-most coordinate is the most significant.*

The duality theorem as required by Req. 3.7 clearly follows from Claim 5.17.

► **Claim 5.19** (Duality). Let $L \subseteq \Sigma^\omega$ be an ω -regular property, and \bar{L} its complement. Let $w_1, w_2 \in \Sigma^\omega$. Then $w_1 \succeq_L w_2 \iff w_1 \preceq_{\bar{L}} w_2$.

► **Corollary 5.20** (The robustness preference relation). *The robustness preference relation \succeq_L induced from L satisfies all our requirements.*

6 Computing the robustness value

We turn to ask how to calculate the robustness value of certain words with respect to a certain language. Ideally, we would like to have a DPA whose transitions can be colored in the same manner as we colored letters of the word so that there is a one-to-one match between the colors of the edges traversed during the run and the colors of the letters of the word. We show that such a DPA exists and the correspondence is tighter than just the colors: the ranks of states traversed while reading the word match exactly the ranks of the letters.

It is worth noting first that taking an arbitrary DPA for the language, even a minimal one with minimal ranks, does not produce the desired correlation. Indeed, Fig. B.2 shows three minimal DPAs with minimal ranks for the language ∞ab : \mathcal{P}_1 , \mathcal{P}_2 and \mathcal{P}_3 , but they often disagree on the sequence of ranks traversed when reading the same word. For instance, $(ab)^\omega$ gets ranks $(10)^\omega$ on \mathcal{P}_1 and \mathcal{P}_2 but $(1011)^\omega$ on \mathcal{P}_3 . The word $(aabb)^\omega$ gets ranks $(10)^\omega$ on \mathcal{P}_1 but $(1101)^\omega$ on \mathcal{P}_2 and \mathcal{P}_3 . Moreover, we expect the word $(ab)^\omega$ and $(aabb)^\omega$ to get ranks $1(00)^\omega$ and $1(1010)^\omega$ from which (applying our coloring scheme and computing the words value) we can infer that $(ab)^\omega$ is more robust. The DPA $\mathcal{P}_{L_4}^\star$ does provide the desired correlation. We can clearly see that the best ranked words have $(ab)^\omega$ as a suffix since the label of the only green cycle is ab (or ba), and a green cycle produces the best value.

The question is then how can we obtain a DPA that has the desired correspondence to our defined notion of Ω_L^{letter} . The prominent candidate is the *precise DPA* introduced in [14] in the context of passive learning, as it was developed from the notion of Ω_L^{infix} on which Ω_L^{letter} relies, and shares some of the intuitions of finding reset points. It turns out that it does not give the desired correlation, see Ex. B.5 and Ex. B.6.

Our proof that a DPA with the desired correlation exists has two steps: in the first step we show that a DPA that has the desired correlation between ranks exists, and in the next step we show that a DPA that has the desired correlation between both ranks and colors exists. We term the final DPA the *robustness DPA*. The second step is needed only when there are negative ranks. In all other cases the first step suffices. We call the automaton resulting from the first step the *vigor DPA* (to avoid something long as *pseudo-robustness*).

6.1 Getting the ranks correct: The vigor DPA \mathcal{P}_L^\diamond

Let $u, x, y \in \Sigma^*$ and $L \subseteq \Sigma^\omega$. Let $L_u = \{v^\omega \mid uv \sim_L u. uv^\omega \in L\}$. We define the *vigor-equivalent* classes induced by u wrt L .

► **Definition 6.1** (\equiv_u^\diamond). We say that x and y are *vigor-equivalent* wrt u and L , denoted $x \equiv_u^\diamond y$, if $\Omega_L^{\text{infix}}(u, \text{dom-suf}_{L_u}(xz)) = \Omega_L^{\text{infix}}(u, \text{dom-suf}_{L_u}(yz))$ for all $z \in \Sigma^*$.

From the vigor equivalence classes we can construct in the usual manner the respective automaton structure. Let \mathcal{A}_u^\diamond be the automaton induced by \equiv_u^\diamond . Adding rank to the states we can obtain a parity automaton \mathcal{P}_u^\diamond .

► **Definition 6.2** (\mathcal{P}_u^\diamond). \mathcal{P}_u^\diamond is the DPA obtained from $\mathcal{A}[\equiv_u^\diamond]$ by ranking state q_x by $\Omega_L^{\text{infix}}(u, x)$ where x is the smallest word in the shortlex order reaching q_x .⁷

► **Remark 6.3.** If x and y are the smallest words in the shortlex order reaching state q_x and q_y of \mathcal{P}_u^\diamond , resp. and x is a prefix of y then $\kappa(q_x) \geq \kappa(q_y)$.

We claim that \mathcal{P}_u^\diamond recognizes the language L_u and moreover, the ranks of states visited along the way match one to one the natural ranks induced by L_u .

► **Theorem 6.4** (Correctness of \mathcal{P}_u^\diamond). **1.** $\llbracket \mathcal{P}_u^\diamond \rrbracket = L_u$ and **2.** $\Omega_{L_u}^{\text{letter}}(v^\omega, k) = \kappa(\mathcal{P}_u^\diamond(v^\omega[..k]))$ for every $v \in \Sigma^+$ and $k \in \mathbb{N}$.

The DPAs for \mathcal{P}_u^\diamond for all equivalence classes can be combined into one DPA, that recognizes L and its traversed ranks match one-to-one Ω_L^{letter} of the respective letters.

► **Definition 6.5** (\mathcal{P}_L^\diamond). Assume \sim_L has m equivalent classes c_1, \dots, c_m . Let u_1, \dots, u_m be finite words representatives of c_1, \dots, c_m , resp. Let \mathcal{P}_L^\diamond be a DPA with automaton structure $\mathcal{A}[\sim_L] \times \mathcal{A}[\equiv_{u_1}^\diamond] \times \dots \times \mathcal{A}[\equiv_{u_m}^\diamond]$ and the ranking function $\kappa(c_i, q_1, \dots, q_m) = \kappa_i(q_i)$ where κ_i is the ranking function of $\mathcal{P}_{u_i}^\diamond$. The DPA \mathcal{P}_L^\diamond is termed the *vigor DPA* for L .

Fig.B.4 provides the vigor DPA for a language L_5 for which $|\sim_{L_5}| = 2$.

► **Theorem 6.6** (Correctness of \mathcal{P}_L^\diamond). **1.** $\llbracket \mathcal{P}_L^\diamond \rrbracket = L$ and **2.** $\Omega_L^{\text{letter}}(w, k) = \kappa(\mathcal{P}_L^\diamond(w[..k]))$ for every lasso word $w \in \Sigma^\omega$ and $k \in \mathbb{N}$.

► **Remark 6.7** (\equiv_L^\diamond). \mathcal{P}_L^\diamond 's aut structure corresponds to the equivalence classes \equiv_L^\diamond defined as follows: $x \equiv_L^\diamond y$ if and only if **1.** $x \sim_L y$ and **2.** for every equivalence class c of \sim_L : $x \equiv_c^\diamond y$.

From an arbitrary DPA to the vigor DPA

We turn to ask, given an arbitrary DPA \mathcal{P} for L , how can we construct the vigor DPA of L , \mathcal{P}_L^\diamond . Following Rem.6.7 this amounts to finding the equivalence classes of \equiv_L^\diamond .

To do so, we note first that we can find the equivalence classes of \sim_L by checking for every pair of states q_1, q_2 of \mathcal{P} whether $\llbracket \mathcal{P}_{q_1} \rrbracket = \llbracket \mathcal{P}_{q_2} \rrbracket$ where \mathcal{P}_q is the DPA obtained from \mathcal{P} by making q the initial state. DPA equivalence can be checked in polynomial time [44, 7].

Second, we note that there exists polynomial time procedures that lowers the rank of each state of a given DPA to the minimal rank possible (that does not change the language) [42, 18]. Next we show that from such a DPA \mathcal{P} we can compute $\Omega_L^{\text{infix}}(u, v)$ and $\text{dom-suf}_{L_u}(v)$.

⁷ Where $x < y$ by the *shortlex* order if $|x| < |y|$ or $|x| = |y|$ and x precedes y in the lexicographical order.

► **Lemma 6.8.** *Given a DPA \mathcal{P} and words $u \in \Sigma^*$, $v \in \Sigma^+$, we can compute $\Omega_L^{\text{infix}}(u, v)$ and $\text{dom-suf}_{L_u}(v)$ in time polynomial in $|uv| + |\mathcal{P}|$.*

The proof shows how to compute $\Omega_L^{\text{infix}}(u, v)$, from which we can compute whether index k of w is influential, and in turn the dominant suffix of a given finite word.

► **Lemma 6.9.** *Given a DPA \mathcal{P} for L , we can compute \mathcal{P}_L^\star in time polynomial in $|\mathcal{P}| + |\mathcal{P}_L^\star|$.*

The proof uses ideas of active learning [5] to compute the equivalence classes of \mathcal{P}_L^\star .

► **Remark 6.10.** We note that while this procedure is polynomial in the size of the given input DPA \mathcal{P} and the vigor DPA \mathcal{P}_L^\star , the size of \mathcal{P}_L^\star can be exponential in the size of \mathcal{P} as is the case for the precise DPA for a language [14]. A family of languages exhibiting this is L_n over $\Sigma_n = \{a_1, \dots, a_n\}$ requiring each letter of Σ_n to occur infinitely often. There is a DPA for L with n states, yet every permutation of Σ_n resides in its own equivalence class in $\equiv_{L_n}^\star$.

6.2 Getting the colors correct: the robustness DPA \mathcal{P}_L^\star

The vigor DPA \mathcal{P}_L^\star from Def. 6.5 provides the desired tight correlation between the ranks of the traversed edges and the ranks given to letters by Ω_L^{letter} . We can color the edges of the resulting DPA using $\theta(d, d')$ from Def. 5.11 where d and d' are the ranks of the edges' source and target. This, however, will induce a tight correlation to the color of the letters as per Def. 5.11 only in case there are no black or white letters. If such exist, then traversing a black (resp. white) edge will result in reaching a rejecting (resp. accepting) terminal MSCC of the DPA, and thus all subsequent transitions will be black (resp. white). Since the color of letters (Def. 5.11) builds on the forgetful version of the read prefix, there could be non-black (resp. non-white) letters after a black (resp. white) letter. Ex. B.7 exemplifies this issue. To remedy this we introduce a new type of acceptance for ω -automata: *forgetful parity*.

► **Definition 6.11** (Forgetful parity automaton). *A **forgetful parity automaton** is a tuple $(\Sigma, Q, q_0, \delta, \kappa)$ like a parity automaton, with two differences: **1.** the range of κ is $\{-2, -1, 0, \dots, k\}$, and **2.** there are ε -transitions. We require that if $\delta(q, \varepsilon)$ is defined then $\delta(q, \sigma)$ is undefined for every $\sigma \in \Sigma$. Thus, the automaton is deterministic. A run $\rho = q_0q_1q_2\dots$ of a forgetful parity automaton is accepting if either (*) there exists $i \in \mathbb{N}$ such that $\kappa(q_i) = -2$ and $\kappa(q_j) \geq 0$ for all $j < i$ or (**) $\kappa(q_i) \geq 0$ for all $i \in \mathbb{N}$ and $\min(\inf(\{\kappa(q_i) \mid i \in \mathbb{N}\}))$ is even.*

Note that (**) is the usual parity acceptance condition, and (*) reflects that the word reached a terminal accepting MSCC.

Given a forgetful parity automaton, we color its edges as follow: edge (q, σ, q') is colored $\theta(\kappa(q), \kappa(q'))$ using θ of Def. 5.11. An ε -edge is not colored. See Fig. B.5. Let $w = \sigma_1\sigma_2\dots \in \Sigma^\omega$ and let $\rho_w = q_0q_1q_2\dots$ be the run of a forgetful parity automaton \mathcal{P} on w . We use $e\text{-color}_w^{\mathcal{P}}(i)$ for the color of the edge (q_{i-1}, σ_i, q_i) .

► **Proposition 6.12** (The robustness DPA). *Let \mathcal{P}_L^\star be the vigor DPA for L . There exists a polynomial time procedure returning a forgetful DPA \mathcal{P}_L^\star such that $\llbracket \mathcal{P}_L^\star \rrbracket = \llbracket \mathcal{P}_L^\star \rrbracket$ and $e\text{-color}_w^{\mathcal{P}_L^\star}(i) = \text{color}_w(i)$ for all $w \in \Sigma^\omega$ and $i \in \mathbb{N}$. We term \mathcal{P}_L^\star the **robustness DPA** for L .*

The proof uses a simple procedure that replaces (q, σ, q') transitions to state q' in a terminal accepting MSCCs by (q, σ, q_\top) -transition to a dedicated state q_\top , and a respective ε -transition (q_\top, ε, q) , and similarly for transitions to terminal rejecting MSCCs. See Fig. B.6 and Fig. B.7 for the vigor and robustness DPAs for the languages in Ex. 1.4 and Ex. B.8.

6.3 Computing robustness values

The robustness value of a given word can be computed in polynomial time from the robustness automaton, as we show next. Following this, given two words we can compute which one is preferred according to the robustness preference relation.

► **Proposition 6.13.** *Given the robustness automaton \mathcal{P}_L^\star for L and a lasso representation (u, v) , we can compute $\text{rbst}_L(w^\omega)$ in polynomial time.*

The proof relies on the following claim correlating $\text{rbst-dcmp}_L()$ to the robustness DPA.

► **Claim 6.14.** Let \mathcal{P}_L^\star be the robustness DPA for L and let w be a lasso word. Let q be the first state reached in the final loop of the run of \mathcal{P} on w . Let u be the prefix of w read from the initial state to q and v the infix of w read from q to q . Then $\text{rbst-dcmp}_L(w) = (u, v)$.

7 Conclusion

We have shown that we can distill from a given ω -regular language L a robustness preference relation that refines Tabuada and Neider’s idea into an infinite domain, meets our intuitions in all provided examples, and satisfies the desired criteria of duality, value wrt the complement, and satisfaction bar. Towards this aim we provided semantical definitions for the natural rank and color of a letter of an ω -word wrt L , and the robustness decomposition of a lasso word. From these we have constructed the *robustness DPA* for L , a DPA whose equivalence classes capture the semantical notion of robustness, and has a one-to-one correspondence between the ranks and colors of the edges traversed when reading the word and the ranks and colors of the letters of the word.

Acknowledgments We thank Matan Pinkas and Oded Zimmerman for comments on an early draft of this paper.

References

- 1 S. Almagor and O. Kupferman. Good-enough synthesis. In *Computer Aided Verification - 32nd International Conference, CAV*, pages 541–563, 2020.
- 2 Shaull Almagor, Udi Boker, and Orna Kupferman. Formally reasoning about quality. *J. ACM*, 63(3), June 2016. doi:10.1145/2875421.
- 3 Rajeev Alur, Loris D’Antoni, Jyotirmoy V. Deshmukh, Mukund Raghothaman, and Yifei Yuan. Regular functions and cost register automata. In *28th Annual ACM/IEEE Symposium on Logic in Computer Science, LICS 2013, New Orleans, LA, USA, June 25-28, 2013*, pages 13–22. IEEE Computer Society, 2013. doi:10.1109/LICS.2013.65.
- 4 Rajeev Alur, Emmanuel Filiot, and Ashutosh Trivedi. Regular transformations of infinite strings. In *Proceedings of the 27th Annual IEEE Symposium on Logic in Computer Science, LICS 2012, Dubrovnik, Croatia, June 25-28, 2012*, pages 65–74. IEEE Computer Society, 2012. doi:10.1109/LICS.2012.18.
- 5 D. Angluin. Learning regular sets from queries and counterexamples. *Inf. Comput.*, 75(2):87–106, 1987.
- 6 D. Angluin and D. Fisman. Learning regular omega languages. *Theor. Comput. Sci.*, 650:57–72, 2016.
- 7 D. Angluin and D. Fisman. Constructing Concise Characteristic Samples for Acceptors of Omega Regular Languages. *Logical Methods in Computer Science*, Volume 20, Issue 4:10:1–10:59, November 2024. URL: [https://doi.org/10.46298/lmcs-20\(4:10\)2024](https://doi.org/10.46298/lmcs-20(4:10)2024).

- 8 Ezio Bartocci, Roderick Bloem, Dejan Nickovic, and Franz Röck. A counting semantics for monitoring LTL specifications over finite traces. In *Computer Aided Verification - 30th International Conference, CAV 2018, Held as Part of the Federated Logic Conference, FloC 2018, Oxford, UK, July 14-17, 2018, Proceedings, Part I*, pages 547–564, 2018.
- 9 R. Bloem, K. Chatterjee, T.A. Henzinger, and B. Jobstmann. Better quality in synthesis through quantitative objectives. In *Computer Aided Verification, 21st International Conference, CAV*, pages 140–156, 2009.
- 10 R. Bloem, H. Chockler, M. Ebrahimi, and O. Strichman. Specifiable robustness in reactive synthesis. *Formal Methods Syst. Des.*, 60(2):259–276, 2022.
- 11 R. Bloem, H.-J. Gamauf, G. Hofferek, B. Könighofer, and R. Könighofer. Synthesizing robust systems with RATS. In *Proceedings First Workshop on Synthesis, SYNT*, pages 47–53, 2012.
- 12 Roderick Bloem, Krishnendu Chatterjee, Karin Greimel, Thomas A. Henzinger, Georg Hofferek, Barbara Jobstmann, Bettina Könighofer, and Robert Könighofer. Synthesizing robust systems. *Acta Informatica*, 51(3-4):193–220, 2014.
- 13 Roderick Bloem, Karin Greimel, Thomas Henzinger, and Barbara Jobstmann. Synthesizing robust systems. volume 9, pages 85 – 92, 12 2009. doi:10.1109/FMCAD.2009.5351139.
- 14 León Bohn and Christof Löding. Constructing deterministic parity automata from positive and negative examples. *TheoretCS*, 3, 2024. URL: <https://doi.org/10.46298/theoretics.24.17>, doi:10.46298/THEORETICS.24.17.
- 15 U. Boker, K. Chatterjee, T.A. Henzinger, and O. Kupferman. Temporal specifications with accumulative values. *ACM Trans. Comput. Log.*, 15(4):27:1–27:25, 2014.
- 16 P. Bouyer, P. Gardy, and N. Markey. Quantitative verification of weighted kripke structures. In *Automated Technology for Verification and Analysis - 12th International Symposium, ATVA*, pages 64–80, 2014.
- 17 P. Bouyer, N. Markey, and O. Sankur. Robust reachability in timed automata and games: A game-based approach. *Theor. Comput. Sci.*, 563:43–74, 2015.
- 18 Olivier Carton and Ramón Maceiras. Computing the rabin index of a parity automaton. *RAIRO Theor. Informatics Appl.*, 33(6):495–506, 1999.
- 19 K. Chatterjee, L. Doyen, and T. A. Henzinger. Quantitative languages. *ACM Trans. Comput. Log.*, 11(4):23:1–23:38, 2010.
- 20 M. Chechik, S.M. Easterbrook, and B. Devereux. Model checking with multi-valued temporal logics. In *31st IEEE International Symposium on Multiple-Valued Logic, ISMVL*, pages 187–192, 2001.
- 21 Martin De Wulf, Laurent Doyen, Nicolas Markey, and Jean-François Raskin. Robust safety of timed automata. *Formal Methods in System Design*, 33(1):45–84, 2008.
- 22 Manfred Droste and Paul Gastin. Weighted automata and weighted logics. *Theor. Comput. Sci.*, 380(1-2):69–86, 2007.
- 23 R. Ehlers. Generalized rabin(1) synthesis with applications to robust system synthesis. In *NASA Formal Methods - Third Inter. Symp. NFM*, pages 101–115, 2011.
- 24 Rüdiger Ehlers and Sven Schewe. Natural colors of infinite words. In *42nd IARCS Annual Conference on Foundations of Software Technology and Theoretical Computer Science, FSTTCS*, pages 36:1–36:17, 2022.
- 25 M. Faella, A. Legay, and M. Stoelinga. Model checking quantitative linear time logic. In *Proc. of the Sixth Workshop on Quantitative Aspects of Programming Languages, QAPL*, pages 61–77, 2008.
- 26 Emmanuel Filiot, Nicolas Mazzocchi, Jean-François Raskin, Sriram Sankaranarayanan, and Ashutosh Trivedi. Weighted transducers for robustness verification. In *31st International Conference on Concurrency Theory, CONCUR 2020, September 1-4, 2020, Vienna, Austria (Virtual Conference)*, pages 17:1–17:21, 2020.
- 27 B. Finkbeiner, M. Fränzle, F. Kohn, and P. Kröger. A truly robust signal temporal logic: Monitoring safety properties of interacting cyber-physical systems under uncertain observation. *Algorithms*, 15(4):126, 2022.

- 28 Dana Fisman, Emmanuel Goldberg, and Oded Zimerman. A robust measure on fd-fas following duo-normalized acceptance. In Rastislav Královic and Antonín Kucera, editors, *49th International Symposium on Mathematical Foundations of Computer Science, MFCS 2024, August 26-30, 2024, Bratislava, Slovakia*, volume 306 of *LIPICs*, pages 53:1–53:17. Schloss Dagstuhl - Leibniz-Zentrum für Informatik, 2024. URL: <https://doi.org/10.4230/LIPICs.MFCS.2024.53>, doi:10.4230/LIPICs.MFCS.2024.53.
- 29 Dana Fisman, Joshua Grogin, and Gera Weiss. A normalized edit distance on infinite words. In *31st EACSL Annual Conference on Computer Science Logic, CSL 2023, February 13-16, 2023, Warsaw, Poland*, pages 20:1–20:20, 2023.
- 30 Thomas A. Henzinger and N. Ege Saraç. Quantitative and approximate monitoring. In *2021 36th Annual ACM/IEEE Symposium on Logic in Computer Science (LICS)*, pages 1–14, 2021. doi:10.1109/LICS52264.2021.9470547.
- 31 Thomas A. Henzinger, Nicolas Mazzocchi, and N. Ege Saraç. Abstract monitors for quantitative specifications. In Thao Dang and Volker Stolz, editors, *Runtime Verification*, pages 200–220, Cham, 2022. Springer International Publishing.
- 32 Thomas A Henzinger and Jean-François Raskin. Robust undecidability of timed and hybrid systems. In *International Workshop on Hybrid Systems: Computation and Control*, pages 145–159. Springer, 2000.
- 33 Rémi Jaubert and Pierre-Alain Reynier. Quantitative robustness analysis of flat timed automata. In *International Conference on Foundations of Software Science and Computational Structures*, pages 229–244. Springer, 2011.
- 34 O. Kupferman. Multi-valued reasoning about reactive systems. *Found. Trends Theor. Comput. Sci.*, 15(2):126–228, 2022.
- 35 O. Kupferman and Y. Lustig. Lattice automata. In *Verification, Model Checking, and Abstract Interpretation, 8th Int. Conf., VMCAI*, pages 199–213, 2007.
- 36 Vardi M Kupferman O. Synthesis with incomplete information. In *In: 2nd international conference on temporal logic. Manchester*, page 91–106, 1997.
- 37 Y. Li, S. Schewe, and Q. Tang. A novel family of finite automata for recognizing and learning ω -regular languages. In *Automated Technology for Verification and Analysis - 21st International Symposium, ATVA*, pages 53–73, 2023.
- 38 O. Maler and L. Staiger. On syntactic congruences for omega-languages. *Theor. Comput. Sci.*, 183(1):93–112, 1997.
- 39 Aniello Murano, Daniel Neider, and Martin Zimmermann. Robust alternating-time temporal logic. In *Logics in Artificial Intelligence - 18th European Conference, JELIA 2023, Dresden, Germany, September 20-22, 2023, Proceedings*, pages 796–813, 2023.
- 40 Satya Prakash Nayak, Daniel Neider, Rajarshi Roy, and Martin Zimmermann. Robust computation tree logic. In *NASA Formal Methods - 14th International Symposium, NFM 2022, Pasadena, CA, USA, May 24-27, 2022, Proceedings*, pages 538–556, 2022.
- 41 Daniel Neider, Alexander Weinert, and Martin Zimmermann. Robust, expressive, and quantitative linear temporal logics: Pick any two for free. *Inf. Comput.*, 285(Part):104810, 2022.
- 42 D. Niwinski and I. Walukiewicz. Relating hierarchies of word and tree automata. In *15th Annual Symposium on Theoretical Aspects of Computer Science (STACS)*, pages 320–331, 1998.
- 43 D. Perrin and J-E. Pin. *Infinite Words: Automata, Semigroups, Logic and Games*. Elsevier, 2004.
- 44 Sven Schewe. Beyond hyper-minimisation—minimising dbas and dpas is np-complete. In *IARCS Annual Conference on Foundations of Software Technology and Theoretical Computer Science, FSTTCS 2010, December 15-18, 2010, Chennai, India*, pages 400–411, 2010.
- 45 Paulo Tabuada and Daniel Neider. Robust linear temporal logic. In *25th EACSL Annual Conference on Computer Science Logic, CSL 2016, August 29 - September 1, 2016, Marseille, France*, pages 10:1–10:21, 2016.

46 K. W. Wagner. A hierarchy of regular sequence sets. In *Mathematical Foundations of Computer Science 1975, 4th Sym.*, volume 32 of *LNCS*, pages 445–449. Springer, 1975.

A Omitted proofs

► **Claim 5.4.** $\text{dom-ind}_L(w, i, k) = \text{dom-ind}_L(w, r_w(k-1), k)$ for all $k \in \mathbb{N}$ and $i \leq r_w(k-1)$.

Proof. Let $k \in \mathbb{N}$. If k is influential wrt $r_w(k-1)$ and j_k is the index witnessing this, then j_k also witnesses that k is influential wrt any $i < r_w(k-1)$.

Otherwise, k is not influential. If $k-1$ is influential then $\Omega_L^{\text{infix}}(w, k, k) > \Omega_L^{\text{infix}}(w, r_w(k-1), k-1)$ because there is necessarily a decrease in the infix rank when reading $w[k-1]$. That is, the dominant index for k is greater than $r_w(k-1)$ and it holds wrt to any $i < r_w(k-1)$.

Otherwise, both k and $k-1$ are not influential wrt $r_w(k-1)$ and $r_w(k-2)$ resp. Then, $w[r_w(k-1)..k-1]$ is the longest suffix of $w[..k-1]$ with the same infix rank as $\Omega_L^{\text{infix}}(w, k-1, k-1)$. Any suffix starting before $r_w(k-1)$ would decrease the infix rank. Also, $\Omega_L^{\text{infix}}(w, k, k) \geq \Omega_L^{\text{infix}}(w, k-1, k-1)$ because k is not influential. Hence, the start index of the longest suffix of $w[..k]$ with the same infix rank as $\Omega_L^{\text{infix}}(w, k, k)$ is at most $r_w(k-1)$. Therefore, the dominant index of k wrt any index $i \leq r_w(k-1)$ is the same. ◀

► **Definition A.1** (Determining index, determining suffix). Let $w \in \Sigma^* \cup \Sigma^\omega$. Let $i \leq k \leq |w|$. If k is not influential wrt w, i, L let $w[l..k]$ be the dominant suffix of $w[i..k]$. Let $w[j..k]$ be the shortest suffix of $w[l..k]$ for which $\Omega_L^{\text{infix}}(w, j, k) = \Omega_L^{\text{infix}}(w, l, k)$ and $\Omega_L^{\text{infix}}(w[j..k], w[j..k] \cdot v) = \Omega_L^{\text{infix}}(w[l..l], w[l..k] \cdot v)$ for all $v \in \Sigma^*$. Then $w[j..k]$ is the **determining suffix** of $w[i..k]$, denoted $\text{det-suf}_L(w, i, k)$, and j is the **determining index** of w wrt i, k and L , denoted $\text{det-ind}_L(w, i, k)$.

► **Theorem 5.9** (Natural rank words/ letters correlation). Let $L \subseteq \Sigma^\omega$ and w be a lasso word. Let n_1, n_2, \dots be such that $n_i = \Omega_L^{\text{letter}}(w, i)$. Then $\Omega_L^{\text{word}}(w) = d$ if and only if $\min \inf(n_1, n_2, \dots) = d$.

Proof. We show that $\min \inf(n_1, n_2, \dots) = d$ implies $\Omega_L^{\text{word}}(w) = d$. Since the range of d is finite this entails the other direction as well. The proof is by induction on d . For the base cases we consider $d \in \{-2, -1, 0, 1\}$.⁸ If $\min \inf(n_1, n_2, \dots) = -2$ then there exists at least $n \in \mathbb{N}$ such that $\Omega_L^{\text{letter}}(w, n) = -2$. It follows that $\Omega_L^{\text{infix}}(w, r_w(n), n) = -2$. Thus, by Def. 4.3 for all $w' \in \Sigma^\omega$ we have that $w[..n]w' \in L$. Hence $\Omega_L^{\text{word}}(w) = -2$. The argument for -1 is similar.

Otherwise, no negative rank is obtained by reading w . If $\min \inf(n_1, n_2, \dots) = 0$ then there exist $x \in \Sigma^*$ and $y \in \Sigma^+$ such that $w = x(y)^\omega$, and assuming $|x| = k$ and $|y| = l$, for every $m \in \mathbb{N}$ it holds that $\Omega_L^{\text{infix}}(w, k+ml, k+(m+1)l) = 0$. By Def. 4.3, it holds that $\Omega_L^{\text{infix}}(x, y) = \max\{\Omega_L^{\text{word}}(x(yz)^\omega) \mid xyz \sim_L x\}$. Since the maximal possible word rank is 0, and 0 is the minimal possible non-negative rank as well, then $\Omega_L^{\text{word}}(w) = 0$. The base case for $\min \inf(n_1, n_2, \dots) = 1$ is similar (since the case when the minimal rank is 0 is treated in the induction step).

For the induction step assume $\min \inf(n_1, n_2, \dots) = d$. Then there exists $n_0 \in \mathbb{N}$ such that $\Omega_L^{\text{letter}}(w, n) \geq d$ for all $n \geq n_0$ and in particular there exist $I = i_1, i_2, \dots$ such that $\Omega_L^{\text{letter}}(w, i_j) = d$ for all $j \in \mathbb{N}$. Since $\Omega_L^{\text{letter}}(w, i_j) = d$ then $\Omega_L^{\text{infix}}(w, r_w(i_j), i_j) = d$ for all $j \in \mathbb{N}$. Since w is ultimately periodic, there exists $x \in \Sigma^*$ and $y \in \Sigma^+$ such that $w = x(y)^\omega$, and assuming $|x| = k$ and $|y| = l$, for every $m \in \mathbb{N}$ it holds that $\Omega_L^{\text{infix}}(w, k+ml, k+(m+1)l) = d$.

⁸ Note that 1 can be obtained either from the induction base or the induction step.

Let $J = j_1, j_2, \dots \subseteq I$ such that $r_w(j_{n+1}) \geq j_n$ and $j_{n+1} - j_n = m \cdot l$ for some $m \in \mathbb{N}$. Note that if such J is a finite set of indices it means all the indices from some point have the same minimal rank and are not influential. According to Clm. A.2, their rank is the maximal rank in L . Then let J be such that $\det\text{-ind}(w, 0, j_{n+1}) \geq j_n$ and $j_{n+1} - j_n = m \cdot l$ for some $m \in \mathbb{N}$. Note that if such J is also a finite set of indices then any infinite set of indices will follow the requirements because current rank of the word is already the maximal so no injections could increase it. Let $w' \in \text{inj}_J(w)$, then $w' = x(y^m z)^\omega$ for some $z \in \Sigma^+$ such that $xy^m z \sim_L xy^m$. From Rem. 4.5 it holds that $\Omega_L^{\text{infix}}(x, y^m z) = d' \leq d$ and $\Omega_L^{\text{infix}}(x, y^m z') \in [d'..d]$ for every $z' \preceq z$. by Clm. A.3, $\Omega_L^{\text{letter}}(w', n') \leq \Omega_L^{\text{letter}}(w, m \cdot l)$ for infinitely many $n' \in \mathbb{N}$. From the periodicity of w' , we get that $\min \inf \{\Omega_L^{\text{letter}}(w', n)\}_{n \in \mathbb{N}} \in [d'..d]$. Hence, for every lasso word w' in $\text{inj}_J(w)$ we have that either $\min \inf \{\Omega_L^{\text{letter}}(w', n)\} = d'' < d$ or $\min \inf \{\Omega_L^{\text{letter}}(w', n)\} = d$. In the first case $\Omega_L^{\text{word}}(w') = d''$ by induction hypothesis. In the second case $w \in L$ iff $w' \in L$ from the parity of d . It thus follows from Def. 4.1 that $\Omega_L^{\text{word}}(w) = d$. \blacktriangleleft

► **Claim A.2.** Let $L \subseteq \Sigma^\omega$, m be the maximal rank in L , and $w \in \Sigma^\omega$. If there exists $n_0 \in \mathbb{N}$ such that for all $n > n_0$ the n -th index of w is non-influential then $\Omega^{\text{letter}}(w, n) = m$ for all $n > n_0$.

Proof. Assume towards contradiction that $\Omega^{\text{letter}}(w, n) = m'$ for some $m' < m$. Then, since n is a non-influential index, by Def. 5.1, Def. 5.2 and Def. 5.8, $\Omega_L^{\text{infix}}(w, r_w(n), n) = \Omega_L^{\text{infix}}(w, n, n) = m'$. This means that $\Omega_L^{\text{infix}}(w[.n], w[n]) < \Omega^{\text{infix}}(w[.n], \varepsilon)$. Thus, the n -th letter is influential. Contradiction. \blacktriangleleft

► **Claim A.3.** Let $L \subseteq \Sigma^\omega$ and $x \in \Sigma^*$. If $\Omega_L^{\text{letter}}(x, |x|) = d$ then $\Omega_L^{\text{letter}}(zx, |zx|) \leq d$ for all $z \in \Sigma^*$.

Proof. Let $z \in \Sigma^*$ be some finite word. We claim that since x is a suffix of zx then $\text{dom-suf}_L(x)$ is a suffix of $\text{dom-suf}_L(zx)$. Assume this is not the case and let $|z| = k$ and $|x| = l$, then $r_{zx}(k+l) = m > k$ and $r_x(l) < m - k$. By Cor. 5.5 $\text{dom-ind}_L(zx, m, k+l) = \text{dom-ind}_L(zx, m', k+l)$ for every $m' \in [0..m]$ and in particular $\text{dom-ind}_L(zx, m, k+l) = \text{dom-ind}_L(zx, k, k+l)$. Then, $\text{dom-ind}_L(zx, m, k+l) = \text{dom-ind}_L(x, 0, l)$ and $r_x(l) = m - k$, contradicting that $r_x(l) < m - k$. Hence, $\Omega_L^{\text{letter}}(zx, k+l) \leq \Omega_L^{\text{letter}}(x, l) = d$. \blacktriangleleft

► **Remark 6.3.** If x and y are the smallest words in the shortlex order reaching state q_x and q_y of \mathcal{P}_u^\diamond , resp. and x is a prefix of y then $\kappa(q_x) \geq \kappa(q_y)$.

Proof. Since x is a prefix of y we have $\Omega^{\text{infix}}(u, y) \leq \Omega^{\text{infix}}(u, x)$. Also, $\kappa(q_y) = \Omega^{\text{infix}}(u, y)$ and $\kappa(q_x) = \Omega^{\text{infix}}(u, x)$, as per Def. 6.2. Then $\kappa(q_y) = \Omega^{\text{infix}}(u, y) \leq \Omega^{\text{infix}}(u, x) = \kappa(q_x)$. \blacktriangleleft

► **Theorem 6.4** (Correctness of \mathcal{P}_u^\diamond). **1.** $\llbracket \mathcal{P}_u^\diamond \rrbracket = L_u$ and **2.** $\Omega_{L_u}^{\text{letter}}(v^\omega, k) = \kappa(\mathcal{P}_u^\diamond(v^\omega[.k]))$ for every $v \in \Sigma^+$ and $k \in \mathbb{N}$.

Proof. We show the second item. The first item follows from the second and Thm. 5.9.

We name the state of $\mathcal{A}[\sim]$ corresponding to class $[u]$ by q_x where x is the least word in the shortlex order that resides in $[u]$. Since \mathcal{A}_u^\diamond is the automaton structure induced from \equiv_u^\diamond , by definition for every word y if on reading y the automaton reaches state q_x then $y \equiv_u^\diamond x$. Assume $w[.k]$ reaches state q_x . Thus, $w[.k] \equiv_u^\diamond x$. It follows from Def. 6.1 that for all $z \in \Sigma^*$, in particular $z = \varepsilon$ we have $\Omega_{L_u}^{\text{infix}}(u, \text{dom-suf}_{L_u}(x)) = \Omega_{L_u}^{\text{infix}}(u, \text{dom-suf}_{L_u}(w[.k]))$. Note that the LHS is $\kappa(q_x) = \kappa(\mathcal{P}_u^\diamond(w[.k]))$ and the RHS is $\Omega_{L_u}^{\text{letter}}(w, k)$. Thus, the claim follows. \blacktriangleleft

► **Theorem 6.6** (Correctness of \mathcal{P}_L^\diamond). 1. $[\mathcal{P}_L^\diamond] = L$ and 2. $\Omega_L^{\text{letter}}(w, k) = \kappa(\mathcal{P}_L^\diamond(w[.k]))$ for every lasso word $w \in \Sigma^\omega$ and $k \in \mathbb{N}$.

Proof. We show the second item. The first item follows from the second and Thm. 5.9.

We use $\inf_{\sim_L}(w)$ for the set $\{[u]_{\sim_L} \mid \forall i. \exists j > i. w[.j] \in [u]\}$. Suppose $w = uv^\omega$, $u \sim_L uv$, $\Omega_L^{\text{word}}(w) = d$ and $\inf_{\sim_L}(w) = \{u_1, \dots, u_l\}$ and $m \geq l$ is the number of equivalence classes of \sim_L . Let y be a shortest infix of some repetition of v that suffices to conclude the rank of uv^ω . That is, $v^n = v'v''$ for some $n \in \mathbb{N}$, $v'v'' \in \Sigma^*$ and $v'' = xy$ for some $x, y \in \Sigma^*$ where $y = \text{dom-suf}_L(v'')$.⁹ Then $\Omega_L^{\text{infix}}(uv'x, y) = d$. Let u_i be such that $uv'xy'_i \sim_L u_i$ for some $y'_i y''_i = y$. Then $\Omega_L^{\text{infix}}(uv'xy'_i, y''_i y) = d$. It follows from Thm. 6.4 that $\kappa_i(\mathcal{P}_{u_i}(y''_i y)) = d$ for every $i \in [1..l]$.

Let $\rho_w = q_0, q_1, \dots$ be the run of \mathcal{P}_L^\diamond on w where $q_i = (c_i, p_{i,1}, p_{i,2}, \dots, p_{i,m})$. Then for every $i \in \mathbb{N}$ such that y is a suffix of $w[.i]$ we have that $\kappa_j(p_{i,j}) = d$ for all $j \in [1..l]$ and for infinitely many such i 's we have that $c_i \in [1..l]$. Thus, $\kappa(\mathcal{P}_L^\diamond(w[.i])) = \kappa_{c_i}(p_{i,c_i}) = d$ for infinitely many i 's. Recall that we have already established in Thm. 6.4 that for some $n_0 \in \mathbb{N}$ it holds that $\kappa_j(p_{n,j}) \geq d$ for every $n > n_0$ and $j \in [1..l]$. It follows that the minimal rank visited infinitely often by \mathcal{P} when running on w is $\Omega^{\text{word}}(w)$. ◀

► **Lemma 6.8.** Given a DPA \mathcal{P} and words $u \in \Sigma^*$, $v \in \Sigma^+$, we can compute $\Omega_L^{\text{infix}}(u, v)$ and $\text{dom-suf}_{L_u}(v)$ in time polynomial in $|uv| + |\mathcal{P}|$.

Proof. We start with the computation of $\Omega_L^{\text{infix}}(u, v)$.

First we compute the MSCCs of \mathcal{P} . A state is termed *transient* if it is not part of any MSCC (recall that a singleton $\{q\}$ is an MSCC only if there is a self-loop on q). Then we classify the MSCCs into *rejecting*, *accepting* or *mixed*. An MSCC is *rejecting* (resp. *accepting*) if all its ranks are odd (resp. even) and it is *mixed* otherwise. A rejecting (resp. accepting) MSCC is *terminal* if only rejecting (resp. accepting) MSCCs are reachable from it.

Let q_u and q_{uv} be the states reached on reading u and uv , resp. from the initial state. If q_{uv} is transient return ∞ , if q_{uv} resides in a rejecting (resp. accepting) terminal MSCC return -1 (resp. -2).

Otherwise, let d be the minimal rank visited when reading v starting from q_u . Remove all states with rank lower than d and check if there is a path from q_{uv} to q_u (can be done by a BFS). If so, $\Omega_L^{\text{infix}}(u, v) = d$. Otherwise, decrease d by 1 and perform the same for the new value. The runtime is $O(m|E| + |uv|)$ where m is the number of different ranks in the automaton, and E are the edges of \mathcal{P} .

For $\text{dom-suf}_{L_u}(v)$, let $l = |v|$. We compute first $d_1, d_2, d_3, \dots, d_l$ and $d'_1, d'_2, d'_3, \dots, d'_l$ where $d_i = \Omega^{\text{infix}}(u, v[i..])$ and $d'_i = \Omega^{\text{infix}}(u, v[i..])$ for $i \in [1..l]$. If there is an i for which $d_i < d'_i$, then l is influential. Once we know whether l is influential, we conclude whether $\text{dom-suf}_{L_u}(v)$ should be the longest or the shortest suffix available, as defined in Def. 5.2. If index l is not influential then the dominant index is the smallest j such that $d_j = d_l$. Otherwise, the dominant index is the biggest j such that $d_j = d_1$. Given j is the dominant index, the dominant suffix $\text{dom-suf}_{L_u}(v)$ is $v[j..]$. ◀

► **Lemma 6.9.** Given a DPA \mathcal{P} for L , we can compute \mathcal{P}_L^\diamond in time polynomial in $|\mathcal{P}| + |\mathcal{P}_L^\diamond|$.

Proof. First we find the equivalence classes of $[\mathcal{P}]$ as discussed above. Then for each equivalence class u , we can compute \equiv_u^\diamond , using an active learning algorithm such as L^* [5]

⁹ E.g., for L_3 , $u = b$, $v = bbaa$ we have $y = aa$. For L_3 , $u = b$, $v = a$ we have $y = aaa$.

where the observation table entry (x, y) is filled with the results of $\Omega_L^{\text{infix}}(u, \text{dom-suf}_{L_u}(xy))$ that by Lemma 6.8 can be answered in polynomial time. Equivalence queries are answered via the polynomial time equivalence algorithm [7] for \mathcal{P}_{q_u} where q_u is the state of \mathcal{P} reached by u . This will result in \mathcal{P}_u^\diamond . From $\mathcal{P}_{u_i}^\diamond$ of all equivalence classes u_i we can construct \mathcal{P}^\diamond following Def. 6.5. \blacktriangleleft

► **Proposition 6.12** (The robustness DPA). *Let \mathcal{P}_L^\diamond be the vigor DPA for L . There exists a polynomial time procedure returning a forgetful DPA \mathcal{P}_L^\star such that $\llbracket \mathcal{P}_L^\diamond \rrbracket = \llbracket \mathcal{P}_L^\star \rrbracket$ and $e\text{-color}_w^{\mathcal{P}_L^\star}(i) = \text{color}_w(i)$ for all $w \in \Sigma^\omega$ and $i \in \mathbb{N}$. We term \mathcal{P}_L^\star the **robustness DPA** for L .*

Proof. We modify \mathcal{P}^\diamond by removing -2 -terminal and -1 -terminal MSCCs, and introducing states q_\top ranked -2 (resp. q_\perp ranked -1) for every state q with a transition to -2 -terminal (resp. -1 -terminal) MSCC. Then, remove every edge (q, σ, q') where q' is in a -2 -terminal (resp. -1 -terminal) MSCC and replace it by an edge (q, σ, q_\top) (resp. (q, σ, q_\perp)) and an edge (q_\top, ε, q) (resp. $(q_\perp, \varepsilon, q)$). That is, for each such state q its own dedicated state q_\top (resp. q_\perp) is added. According to Def. 5.11, reading the letter σ by going through edge (q, σ, q_\top) (resp. (q, σ, q_\perp)) gets the white (resp. black) letter color, because the q_\top (resp. q_\perp) represents the accepting (resp. rejecting) terminal MSCCs. Therefore, the color of the corresponding edge is white (resp. black). Let \mathcal{P}^\star be the resulting forgetful parity automaton.

For the equality $\llbracket \mathcal{P}^\diamond \rrbracket = \llbracket \mathcal{P}^\star \rrbracket$, let $w \in \Sigma^\omega$, and let $\rho_w = q_0 q_1 q_2 \dots$ be the run of \mathcal{P}^\diamond on w and $\rho'_w = q'_0 q'_1 q'_2 \dots$ be the run of \mathcal{P}^\star on w . If a negative rank is never traversed by \mathcal{P}^\diamond then $\kappa(q_i) = \kappa(q'_i)$ for every i and so w is accepted by both \mathcal{P}^\diamond and \mathcal{P}^\star if the minimum rank visited infinitely often is even. If a negative rank is traversed by \mathcal{P}^\diamond , then if the first such rank is -2 , then for some j we have $\kappa(q_j) = -2$ and $\kappa(q_i) \geq 0$ for all $i < j$. In this case $\kappa(q_k) = -2$ for all $k > j$ and so $w \in \llbracket \mathcal{P}^\diamond \rrbracket$. Since in \mathcal{P}^\star we also have $\kappa'(q'_j) = -2$ and $\kappa'(q'_i) \geq 0$ for all $i < j$, by the definition of a forgetful DPA, $w \in \llbracket \mathcal{P}^\star \rrbracket$. Similarly, if the first negative rank is -1 then it is -1 all along in \mathcal{P}^\diamond and so $w \notin \llbracket \mathcal{P}^\diamond \rrbracket$ and it is not in $\llbracket \mathcal{P}^\star \rrbracket$ by the definition of a forgetful parity automaton.

Since \mathcal{P}^\diamond has the correct ranks, it has the correct colors of transitions when black/white edges are not involved. In \mathcal{P}^\star also runs with black/white edges are colored correctly since the transition to the dedicated state q_\top (resp. q_\perp) colors the edge correctly with white (resp. black) and then the ε -transition mimics the forgetfulness by going back to the same state and allowing all colors to be read from there. \blacktriangleleft

► **Proposition 6.13.** *Given the robustness automaton \mathcal{P}_L^\star for L and a lasso representation (u, v) , we can compute $\text{rbst}_L(uv^\omega)$ in polynomial time.*

Proof. Following Clm. 6.14 we can compute the robustness decomposition (x, y) of $w = uv^\omega$ in polynomial time, by finding the first state q the word loops at. By Prop. 6.12 there is a one-to-one correlation between the colors of the infixes x and y and the colors of the edges traversed when reading them in \mathcal{P}_L^\star . Applying Def. 5.13 we can compute the corresponding average scores τ_x and τ_y . We note that $w \in L$ if either a white edge is traversed in reading xy (and no black edge is traversed before) or the minimal rank visited when reading y from q is even. We set a_w accordingly. By Def. 5.15 the robustness value of w is $(a_w, \tau_y, |x|(\tau_x - \tau_y))$. All the procedures described above can be done in time polynomial in $|uv| + |P|$. \blacktriangleleft

► **Claim 6.14.** Let \mathcal{P}_L^\star be the robustness DPA for L and let w be a lasso word. Let q be the first state reached in the final loop of the run of \mathcal{P} on w . Let u be the prefix of w read from the initial state to q and v the infix of w read from q to q . Then $rbst-dcmp_L(w) = (u, v)$.

Proof. We have to show that (u, v) is the shortest decomposition satisfying $w = uv^\omega$, $\Omega_L^{infix}(u, v) = \Omega_L^{word}(w)$. Let d be the minimal rank on the v -loop from q . By Rem.6.7 we have that $uv \sim_L u$. By Thm.6.6 if $\rho_w = q_0q_1q_2\dots$ is the run of \mathcal{P}_L^\star on w , then $\kappa(q_i) = \Omega_L^{letter}(w, i)$ for every $i \in \mathbb{N}$. It follows that $\min(\inf\{\Omega_L^{letter}(w, i) \mid i \in \mathbb{N}\}) = d$. By Thm.5.9 $\Omega_L^{word}(w) = d$.

We show that $\Omega_L^{infix}(u, v) = d$. Assume this is not the case, then either (i) $\Omega_L^{infix}(u, v) = d' > d$ or (ii) $\Omega_L^{infix}(u, v) = d' < d$. In the first case, by Def.4.3 there exists $z \in \Sigma^*$ such that $\Omega_L^{word}(u(vz)^\omega) = d'$ and $uvz \sim_L u$. Note that the run of \mathcal{P}_L^\star on $u(vz)^\omega$ visits state q with rank $d < d'$. This contradicts Thm.5.9. In the second case, by Def.4.3 for all words $z \in \Sigma^*$ such that $uvz \sim_L u$ we have that $\Omega_L^{word}(u(vz)^\omega) \leq d'$. But for $z = \epsilon$ we know $\Omega_L^{word}(u(v\epsilon)^\omega) = d > d'$. Contradiction.

To see that it is the shortest such decomposition, let $|u| = l$ and q_1, q_2, \dots, q_l be the sequence of states obtained by reading u from q_ϵ . Note that $q_l = q$. Assume towards contradiction that there exists a shorter decomposition (u', v') of w . Since w is a lasso word and there is one final loop of w on \mathcal{P}_L^\star , it holds that the period v' is some rotation of v . Then $u' \prec u$ and there exists q_i for some $i \in [1..l)$ that reaches the final loop before q while reading u . This contradicts that q is the first state of the final loop that is reached. ◀

B Additional examples and figures

▷ **Example B.1 (Computing whether an index is influential).** Consider the language $L_3 = \infty a \wedge (\infty aa \rightarrow \infty aaa)$ from Ex.3.10. Let $w = abbaaaaabbba^\omega$. We show how to calculate whether k is influential wrt $i = 1$ for $k = 3, 5$.

For $k = 3$, following Def.5.1, we check whether there exists $j \in [1..3]$ for which there is a decrease in the natural rank of $w[j..k)$ when the last index k is taken into account. We thus compare the natural rank of ϵ to the rank of b (for $j=3$), of b compared to bb (for $j=2$), and of ab compared to abb (for $j=1$). We get that $\Omega_L^{infix}(ab, \epsilon) = 3$ and $\Omega_L^{infix}(ab, b) = 3$. There is no decrease in the natural rank. Similarly, $\Omega_L^{infix}(a, b) = 3$ and $\Omega_L^{infix}(a, bb) = 3$ and $\Omega_L^{infix}(\epsilon, ab) = 2$ and $\Omega_L^{infix}(\epsilon, abb) = 2$. That is, there is no decrease in natural rank of $w[j..k)$ for any j . Therefore, $k = 3$ is not influential wrt $i = 1$.

For $k = 5$, for searching for the index j that follows the requirements of Def.5.1 we compare the natural rank of ϵ and a (for $j=5$), of a and aa (for $j=4$), of ba and baa (for $j=3$), of bba and $bbaa$ (for $j=2$), and last of $abba$ and $abbaa$ (for $j=1$). We have $\Omega_L^{infix}(abba, \epsilon) = 3$ and $\Omega_L^{infix}(abba, a) = 2$, showing there is a decrease in the natural rank. Thus, there is at least one index j for which there is a decrease in the natural rank of $w[j..k)$, then $k=5$ is influential wrt $i=1$.

▷ **Example B.2.** Consider $L_3 = \infty a \wedge (\infty aa \rightarrow \infty aaa)$. Tbl.1 shows the calculation of the natural rank of the first 9 letters of the word $w = abbaaaaab\dots$, where the row $i_w(k)$ signifies whether the k -th index is influential. Tbl.2 does the same for the word $w = bbaababb\dots$ and $L_4 = \infty ab$.

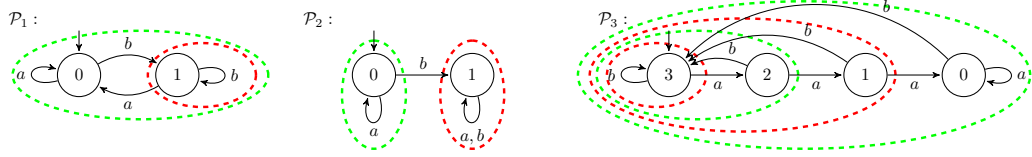

■ **Figure B.1** Parity automata $\mathcal{P}_1, \mathcal{P}_2, \mathcal{P}_3$ for the languages $L_1 = \infty a$ from Req. 3.8, $L_2 = \mathbf{G}a$ from Ex. 1.1 and Ex. 1.2 and $L_3 = \infty a \wedge (\infty aa \rightarrow \infty aaa)$ from Ex. 3.10, respectively, annotated with accepting (dashed green) and rejecting SCCs (dashed red) witnessing their inclusion measure.

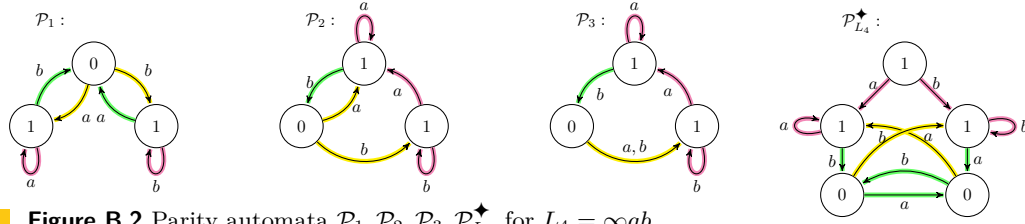

■ **Figure B.2** Parity automata $\mathcal{P}_1, \mathcal{P}_2, \mathcal{P}_3, \mathcal{P}_{L_4}^*$ for $L_4 = \infty ab$.

	w	a	b	b	a	a	a	a	b	\dots		
	k	0	1	2	3	4	5	6	7	8	9	\dots
	$i_w(k)$	T	F	F	T	T	T	T	T	F	F	\dots
	$r_w(k)$	0	1	2	2	4	4	4	5	6	9	\dots
	$dom-suf_{L_3}(w[.k])$	ω	ε	ε	ε	ε	ε	ε	ε	ε	ε	ε
	$\Omega_{L_3}^{letter}(w, k)$	3	2	3	3	2	1	0	0	0	3	\dots

■ **Table 1** For $w = abbaaaaab\dots$ and L_3

	w	b	b	a	a	b	a	b	b	b	\dots	
	k	0	1	2	3	4	5	6	7	8	9	\dots
	$i_w(k)$	F	F	T	F	T	T	T	F	F	F	\dots
	$r_w(k)$	0	1	1	2	3	4	5	6	7	7	\dots
	$dom-suf_{L_4}(w[.k])$	ω	ε	ε	ε	ε	ε	ε	ε	ε	ε	ε
	$\Omega_{L_4}^{letter}(w, k)$	1	1	1	0	1	0	0	0	1	1	\dots

■ **Table 2** For $w = bbaababbb\dots$ and L_4

▷ **Example B.3 (Robustness values).** Recall $L = \infty a$ and the words $w_1 = bb(ab)^\omega$, $w_2 = bbbbbb(ab)^\omega$, $w_3 = aa(ab)^\omega$ and $w_4 = aaaaa(ab)^\omega$. Note that by applying Def. 5.8 all a 's get rank 0 and all b 's get rank 1. The spoke of w_1 thus consists of two red letters and the period consists of one green and one yellow letters. Thus, τ_u is $(0, -1)$ and τ_v is $(0, \frac{1}{2})$. The robustness value of w_1 is $(1, (0, \frac{1}{2}), 2 \cdot (0, -1\frac{1}{2})) = (1, (0, \frac{1}{2}), (0, -3))$. Similarly, the robustness value of w_2 is $(1, (0, \frac{1}{2}), 5 \cdot (0, -1\frac{1}{2})) = (1, (0, \frac{1}{2}), (0, -7\frac{1}{2}))$. Thus, w_1 is more robust than w_2 .

The spoke of w_3 consists of two green letters and the period consists of one green and one yellow letters. Thus, τ_u is $(0, 1)$ and τ_v is $(0, \frac{1}{2})$. The robustness value of w_3 and w_4 are thus $(1, (0, \frac{1}{2}), 2 \cdot (0, \frac{1}{2})) = (1, (0, \frac{1}{2}), (0, 1))$ and $(1, (0, \frac{1}{2}), 5 \cdot (0, \frac{1}{2})) = (1, (0, \frac{1}{2}), (0, 2\frac{1}{2}))$, respectively. Thus, w_4 is more robust than w_3 .

Consider $w_5 = aa(b)^\omega$ and $w_6 = aaaaa(b)^\omega$ which are rejected. The spoke of w_5 consists of two green letters and one yellow letter while the period consists of only red letters. Then τ_u is $(0, 1)$ and τ_v is $(0, -1)$. The robustness value of w_5 and w_6 are thus $(-1, (0, -1), 2 \cdot (0, 2)) = (-1, (0, -1), (0, 4))$, and $(-1, (0, -1), 5 \cdot (0, 2)) = (-1, (0, -1), (0, 10))$, respectively. Hence, w_6 is more robust than w_5 .

▷ **Example B.4 (Four different DPAs for L_3).** Consider the language $L_3 = \infty a \wedge (\infty aa \rightarrow \infty aaa)$. The DPA \mathcal{P}_3 of Fig. B.1 recognizes L_3 and provides the desired correlation between the natural ranks of letters and state ranks. Note that by redirecting the self-loop on a from the state ranked 0 to any other state, we do not change the language. Thus, we get four different DPAs while only one of which is the desired one (has the tight correlation to letter-ranks).



■ **Figure B.3** The precise parity automata $\mathcal{P}_3^{\text{Precise}}$ and $\mathcal{P}_4^{\text{Precise}}$ for $L_3 = \infty a \wedge (\infty a a \rightarrow \infty a a a)$ and $L_4 = \infty a b$ resp. over $\Sigma = \{a, b\}$.

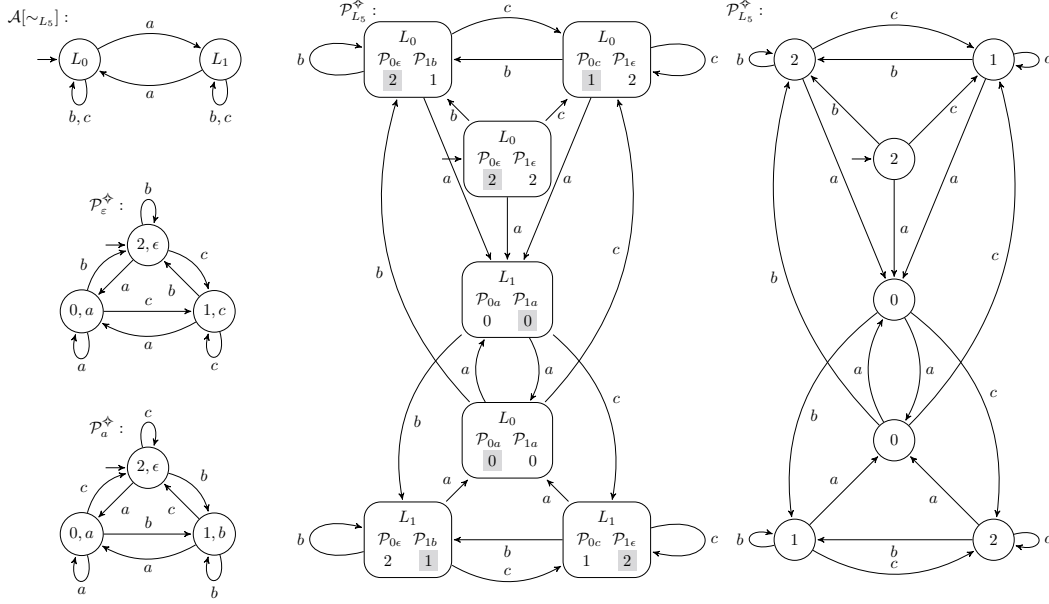

■ **Figure B.4** The vigor DPA for $L_5 = \infty a \vee (|w|_a \text{ is even} \wedge \neg \infty c) \vee (|w|_a \text{ is odd} \wedge \neg \infty b)$ over $\Sigma = \{a, b, c\}$, and the related components: $\mathcal{A}[\sim L_5]$ induced by the equivalence classes of L_5 , parity automata $\mathcal{P}_\epsilon^\diamond$ and \mathcal{P}_a^\diamond for the respective languages, as per Def. 6.5. There are two versions of the vigor DPA $\mathcal{P}_{L_5}^\diamond$ for L_5 : the one on the left shows the relation to the components as per Def. 6.5, whereas the one on the right shows only the final ranks.

▷ **Example B.5 (The precise DPA for L_3).** Consider again the language $L_3 = \infty a \wedge (\infty a a \rightarrow \infty a a a)$. The precise DPA [14] for L_3 is $\mathcal{P}_3^{\text{Precise}}$ from Fig. B.3. The precise DPA is transition-based rather than state-based (i.e. the ranks are on the transitions rather than the states) but this is not the issue. The issue is that it does not rank $(a)^\omega$ with 210000... as does the sequence of n_1, n_2, \dots where $n_i = \Omega_{L_3}^{\text{letter}}(a^\omega, i)$. Consequently it suggests that a^ω is not the most robust word for L_3 , contrary to what we require. Indeed, according to it $(ab)^\omega$ gets a better value (if we had used a reasonable adjustment of the coloring/score from state-based to transition-based).

▷ **Example B.6 (The precise DPA for L_4).** Consider again the language $L_4 = \infty a b$ from Fig. B.2. The precise DPA [14] for L_4 is $\mathcal{P}_4^{\text{Precise}}$ from Fig. B.3. We can see that the word $(ab)^\omega$ is ranked with $(10)^\omega$ instead of 10^ω as correlated with the natural rank and as we expect from the robustness DPA (see Ex. 3.5).

▷ **Example B.7 (Black edges issue).** Consider the DPA \mathcal{P}_2 from Fig. B.1. Applying the edge-coloring results in \mathcal{P}'_2 of Fig. B.5, so after reading a black edge all edges will be black. Thus

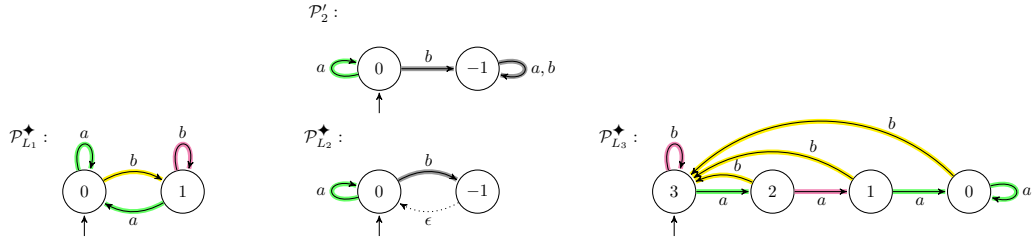

■ **Figure B.5** The robustness parity automata $\mathcal{P}^*_{L_1}, \mathcal{P}^*_{L_2}, \mathcal{P}^*_{L_3}$ for languages L_1, L_2, L_3 , resp. The DPA \mathcal{P}'_2 is what we would get from \mathcal{P}_2 of Fig. B.1 if we hadn't apply the conversion to the forgetful parity automaton as per Prop. 6.12, which is not what we want as explained in Ex. B.7.

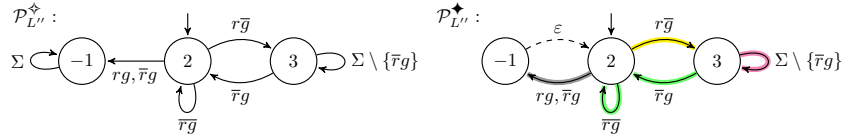

■ **Figure B.6** The vigor and robustness DPAs $\mathcal{P}^*_{L''}$ and $\mathcal{P}^*_{L''}$ for Ex. 1.4 with $\Sigma = \{rg, r\bar{g}, \bar{r}g, \bar{r}\bar{g}\}$.

the colors traversed when reading e.g. $aaabaaa$ will be $gggbbbb$ where g stands for *green* and b for *black* whereas we want $gggbggg$. This mismatch will be encountered whenever a black (resp. white) letter exists. This is since a black (resp. white) edge will transition to a rejecting (resp. accepting) MSCC, from which all edges will be black (resp. white). However, in Def. 5.11 after a black or a white letter is observed, other colors can be observed since the definition makes use of the forgetful version of the word which essentially forgets the black and white letters seen before. This issue called for the definition of forgetful-parity acceptance condition, from which we derive the robustness DPA $\mathcal{P}^*_{L_2}$ shown in Fig. B.5.

▷ **Example B.8 (Safe, danger, recover).** Consider the following property over the alphabet $\{s, d, r\}$ standing for *safe*, *danger* and *recover*, resp. As long as there are no issues the system is in *safe* mode. Once an issue has occurred, the system moves to *danger* mode. When this occurs, the system should eventually move to *recover* mode and until then stay in *danger* mode. From *recover* mode it should eventually move back to *safe* mode. Formally, the property is $L''' = \mathbf{G}(s \rightarrow \mathbf{X}[s\mathbf{W}d]) \wedge \mathbf{G}(d \rightarrow \mathbf{X}[d\mathbf{U}r]) \wedge \mathbf{G}(r \rightarrow \mathbf{X}[r\mathbf{U}s])$. Consider two words $(d^i r^j s^k)^\omega$ and $(d^{i'} r^{j'} s^{k'})^\omega$ and assume the period lengths are equal, that is, $i + j + k = i' + j' + k'$. To capture the intuition that safe actions are the preferred ones, we require $(d^i r^j s^k)^\omega \triangleright_{L'''} (d^{i'} r^{j'} s^{k'})^\omega$ if $i + j < i' + j'$, or equivalently $k > k'$.

Its vigor and robustness DPAs are given in Fig. B.7.

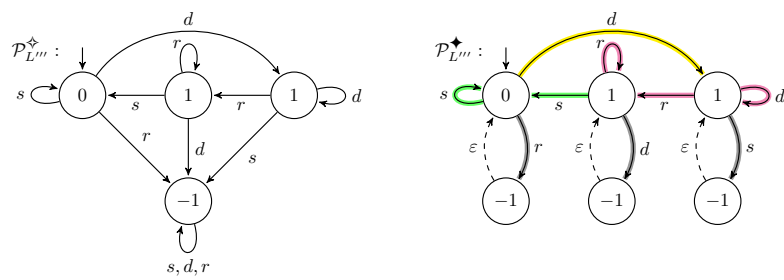

■ **Figure B.7** The vigor parity automaton $\mathcal{P}_{L''}^{\star}$ and its forgetful version, the robustness automaton $\mathcal{P}_{L''}^{\star}$ for Ex. B.8.

