

# On the sensitivity of CDAWG-grammars

Hiroto Fujimaru<sup>1</sup> and Shunsuke Inenaga<sup>2</sup>

<sup>1</sup>Department of Information Science and Technology  
fujimaru.hiroto.134@s.kyushu-u.ac.jp

<sup>2</sup>Department of Informatics, Kyushu University, Japan  
inenaga.shunsuke.380@m.kyushu-u.ac.jp

## Abstract

The *compact directed acyclic word graphs* (CDAWG) [Blumer et al. 1987] of a string is the minimal compact automaton that recognizes all the suffixes of the string. CDAWGs are known to be useful for various string tasks including text pattern searching, data compression, and pattern discovery. The *CDAWG-grammar* [Belazzougui & Cunial 2017] is a grammar-based text compression based on the CDAWG. In this paper, we prove that the CDAWG-grammar size  $g$  can increase by at most an additive factor of  $4e + 4$  than the original after any single-character edit operation is performed on the input string, where  $e$  denotes the number of edges in the corresponding CDAWG before the edit.

## 1 Introduction

The *compact directed acyclic word graphs* (CDAWG) [5] of a string is the minimal compact automaton that recognizes all the suffixes of the string. CDAWGs are known to be useful for various string tasks including text pattern searching [7, 10], data compression [4, 3, 15], and pattern discovery [16].

Basically, CDAWGs are equivalent to “minimized” suffix trees, meaning that CDAWGs can be obtained by merging isomorphic subtrees of suffix trees [17]. Due to this nature, as in the case of suffix trees of which each edge string label  $x$  is represented by a pair  $(i, j)$  of positions satisfying  $T[i..j] = x$ , classical implementations of CDAWGs also require  $\Theta(n)$  space to explicitly store a copy of the string  $T$  being indexed, where  $n = |T|$ . This significantly limits the size of strings on which the CDAWGs are built. Still, the number  $e$  of the edges in the CDAWG tends to be small for some highly repetitive strings [14, 2, 13].

The task of representing the edge labels of the CDAWG without storing the input string  $T$  was first achieved by Belazzougui and Cunial [4, 3], via a connection from CDAWGs to *grammar-based compressions*. They observed that the reversed CDAWG induces a context free grammar (CFG) that only generates the input string  $T$ , which is hereafter named as the *CDAWG-grammar*, which requires  $O(e)$  space where  $e$  denotes the number of CDAWG edges. By augmenting the CDAWG-grammar with a constant-time level ancestor data structure, the CDAWG can be stored in  $O(e)$  space while keeping ability of optimal  $O(m + occ)$ -time pattern matching, where  $m$  is the pattern length and  $occ$  is the number of occurrences to report [4, 3]. While the CDAWG-grammar can easily be obtained via the graph topology of

the corresponding CDAWG, it is also possible to build the CDAWG-grammar *directly* from suffix array based structures [6] without the need of explicitly building the CDAWG.

The focus of this paper is to analyze the advantage of CDAWG-grammar in terms of *sensitivity*: The sensitivity of a repetitiveness measure  $c$  asks how much the measure size increases when a single-character edit operation is performed on the input string [1], and thus the sensitivity allows one to evaluate the robustness of the measure/compressor against errors/edits.

Akagi et al. [1] studied the multiplicative sensitivity and the additive sensitivity of the aforementioned  $e$ , the smallest *string attractor* size  $\gamma$  [11], the *substring complexity*  $\delta$  [12], and the Lempel-Ziv 77 parse size  $z$  [18]. Recent works have revealed the sensitivity of CDAWG size  $e$  in the case of left-end edit operations [8] as well as in the general case [9]. However, the sensitivity of CDAWG-grammars has not been explored. We emphasize that the sensitivity of CDAWG-grammars is not immediate from the sensitivity of CDAWGs, since some CDAWG nodes do not contribute to the CDAWG-grammar size  $g$  [4, 3].

In this work, we study the additive sensitivity of the CDAWG-grammar, and present interesting upper bounds. By using the equation  $g = e - v^{(1)}$  such that  $v^{(1)}$  denotes the number of CDAWG nodes of in-degree 1, we prove that the CDAWG grammar size  $g$  can additively increase by at most  $4e + 4$ , where  $e$  is the number of edges in the corresponding CDAWG before the edit.

## 2 Preliminaries

### 2.1 Strings and maximal substrings

Let  $\Sigma$  be an *alphabet* of size  $\sigma$ . An element of  $\Sigma^*$  is called a *string*. For a string  $T \in \Sigma^*$ , the length of  $T$  is denoted by  $|T|$ . The *empty string*, denoted by  $\varepsilon$ , is the string of length 0. Let  $\Sigma^+ = \Sigma^* \setminus \{\varepsilon\}$ . If  $T = uvw$ , then  $u$ ,  $v$ , and  $w$  are called a *prefix*, *substring*, and *suffix* of  $T$ , respectively. The sets of prefixes, substrings, and suffixes of string  $T$  are denoted by  $\text{Prefix}(T)$ ,  $\text{Substr}(T)$ , and  $\text{Suffix}(T)$ , respectively. For a string  $T$  of length  $n$ ,  $T[i]$  denotes the  $i$ th character of  $T$  for  $1 \leq i \leq n$ , and  $T[i..j] = T[i] \cdots T[j]$  denotes the substring of  $T$  that begins at position  $i$  and ends at position  $j$  on  $T$  for  $1 \leq i \leq j \leq n$ .

For two strings  $u$  and  $T$ , let  $\text{BegPos}(u, T) = \{i \mid T[i..i + |u| - 1] = u\}$  and  $\text{EndPos}(u, T) = \{i \mid T[i - |u| + 1..i] = u\}$  denote the sets of beginning positions and the set of ending positions of  $u$  in  $T$ , respectively. For any substrings  $u, v \in \text{Substr}(T)$  of a string  $T$ , define  $u \equiv_T^L v \Leftrightarrow \text{EndPos}(u, T) = \text{EndPos}(v, T)$ , and  $u \equiv_T^R v \Leftrightarrow \text{BegPos}(u, T) = \text{BegPos}(v, T)$ .

A substring  $x \in \text{Substr}(T)$  of  $T$  is said to be *left-maximal* in  $T$  if (1)  $ax, bx \in \text{Substr}(T)$  for some two distinct characters  $a, b \in \Sigma$ , or (2)  $x \in \text{Prefix}(T)$ . Similarly,  $x$  is said to be *right-maximal* in  $T$  if (1)  $xa, xb \in \text{Substr}(T)$  for some two distinct characters  $a, b \in \Sigma$ , or (2)  $x \in \text{Suffix}(T)$ .

Let  $\text{LeftM}(T)$  and  $\text{RightM}(T)$  denote the set of left-maximal and right-maximal substrings in  $T$ , respectively. It is known that  $x \in \text{LeftM}(T)$  (resp.  $x \in \text{RightM}(T)$ ) iff  $x$  is the longest member of the equivalence class under  $\equiv_T^L$  (resp.  $\equiv_T^R$ ). Let  $\text{M}(T) = \text{LeftM}(T) \cap \text{RightM}(T)$ . Any element of  $\text{M}(T)$  is said to be *maximal* in  $T$ .

A string  $x$  is said to be a *repeat* in a string  $T$  if  $|\text{BegPos}(x, T)| = |\text{EndPos}(x, T)| \geq 2$ . Let  $\text{MR}(T) = \text{M}(T) \setminus \{T\}$  denote the set of *maximal repeats* in  $T$ .

For any substring  $S$  of a string  $T$ , we define its *right-representative* as  $\text{rexp}_T(S) = S\beta$ , where  $\beta \in \Sigma^*$  is the shortest string such that  $S\beta$  is right-maximal in  $T$ .

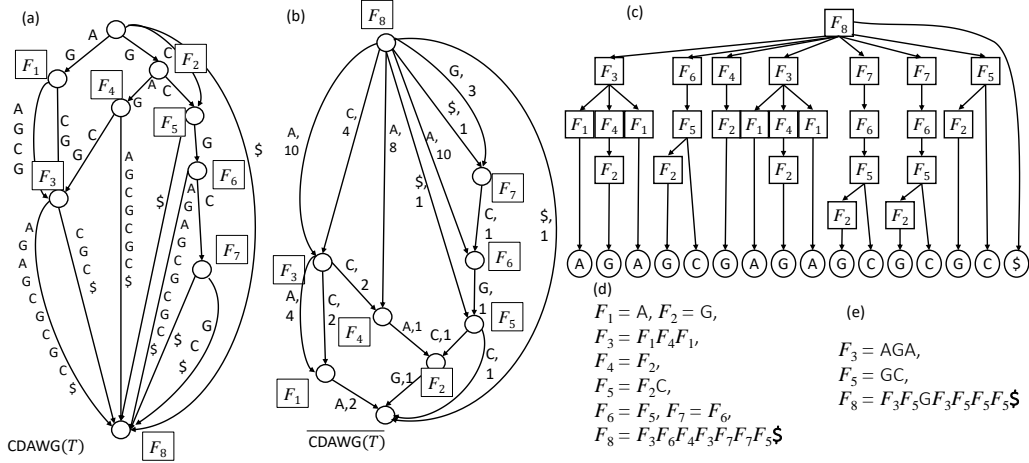

Figure 1: (a)  $\text{CDAWG}(T)$  of string  $T = \text{AGAGCGAGCGCGC}\$$  for which  $M(T) = \{\varepsilon, G, GC, AG, GAG, GCG, GCGC, AGAGCG, T\}$ . The number of right-extensions of  $\text{CDAWG}(T)$  is the number  $e(T)$  of edges, which is 18 in this example. (b) The reversed DAG  $\text{CDAWG}(T)$ , where each edge is labeled by the initial character and the length of the edge's original label. (c) The derivation tree  $\mathcal{T}(T)$  obtained by unfolding  $\text{CDAWG}(T)$ . (d) The grammar rules obtained from  $\mathcal{T}(T)$ . (e) The resulting grammar  $G_{\text{CDAWG}(T)}$  without redundant rules. This grammar size is 13.

## 2.2 CDAWGs

The *suffix tree* [17] of a string  $T$  is a rooted tree such that each edge is labeled by non-empty substring of  $T$  and the path from the root to each node  $v$  represents a right-maximal substring in  $\text{RightM}(T)$ . By assuming a unique end-marker  $\$$  at the right-end of  $T$ , every internal node of the suffix tree of  $T$  has at least two children, and there is a one-to-one correspondence between the leaves and the suffixes of  $T$ .

The *compact directed acyclic word graph* (CDAWG) [5] of a string  $T$ , denoted  $\text{CDAWG}(T) = (V_T, E_T)$ , is a edge-labeled smallest DAG that is obtained by merging isomorphic subtrees of the suffix tree for  $T$ . See the left diagram of Figure 1 for a concrete example of CDAWGs.

It is known that there is a one-to-one correspondence between the nodes of  $\text{CDAWG}(T)$  and the maximal substrings in  $M(T)$ , such that the longest string represented by each node of  $\text{CDAWG}(T)$  is a maximal substring. In what follows, we identify the nodes of  $\text{CDAWG}(T)$  with the maximal substrings in  $M(T)$ . In particular, we identify the non-source nodes of  $\text{CDAWG}(T)$  with the maximal repeats in  $\text{MR}(T)$ . For any  $x \in \text{MR}(T)$ ,  $d_T(x)$  denotes the out-degree of the node  $x$  in  $\text{CDAWG}(T)$ . Similar to suffix trees, every internal node  $x$  of the  $\text{CDAWG}(T)$  has at least two children if  $T$  terminates with  $\$$ . Hence, the following fact holds.

**Fact 1.** If  $T$  terminates with a unique end-marker  $\$$ ,  $d_T(x) \geq 2$  for any  $x \in \text{MR}(T)$ .

The *size* of  $\text{CDAWG}(T) = (V_T, E_T)$  for a string  $T$  of length  $n$  is the number  $e(T) = |E_T|$  of edges in  $\text{CDAWG}(T)$ , which is also referred to as the number of right-extensions of maximal repeats in  $T$ .

### 2.3 CDAWG-grammars

Suppose that our input string  $T$  terminates with a unique end-marker  $\$$ . A *context-free grammar* (CFG)  $\mathcal{G}$  which generates only a string  $T$  is called a grammar compression for  $T$ . The size of  $\mathcal{G}$  is the total length of the right-hand sides of all the production rules in  $\mathcal{G}$ .

Suppose that the input string  $T$  terminates with a unique end-marker  $\$$ . The *CDAWG grammar* [4, 3] of  $T$ , denoted  $G_{\text{CDAWG}}(T)$ , is a grammar compression for  $T$  that is built on  $\text{CDAWG}(T)$  as follows (see also Figure 1): Let  $\overline{\text{CDAWG}(T)}$  denote the DAG obtained by reversing all edges of  $\text{CDAWG}(T)$ . A critical observation is that, since  $\text{CDAWG}(T)$  is a DAG obtained by merging subtrees of the suffix tree for  $T$ , the paths in  $\text{CDAWG}(T)$  have a one-to-one correspondence between the suffixes of  $T$ , and so do the paths in  $\overline{\text{CDAWG}(T)}$ . We label each non-source node  $v$  in  $\text{CDAWG}(T)$  by a terminal  $F_i$  for  $1 \leq i \leq |V_T|$  in a depth-first manner, and let  $p_k$  denote the path of  $\text{CDAWG}(T)$  that represents the suffix  $T[k..|T|]$  starting at position  $k$  in  $T$ . Then, we build a tree  $\mathcal{T}(T)$  by inserting, for each  $1 \leq k \leq |T|$ , the reversed path  $\overline{p_k}$  of  $\overline{\text{CDAWG}(T)}$  as the path of  $\mathcal{T}(T)$  from the root to the  $k$ th leaf that corresponds to the  $k$ th character  $T[k]$ . In other words,  $\mathcal{T}(T)$  is the tree obtained by unfolding  $\overline{\text{CDAWG}(T)}$  into a tree. Observe that  $\mathcal{T}(T)$  is the derivation tree of a grammar that generates (only)  $T$ , and its DAG representation is  $\overline{\text{CDAWG}(T)}$ . This initial grammar may contain some redundant rules of form  $F_i \rightarrow F_j$  (e.g.,  $F_6 \rightarrow F_5$  in Diagram (c) of Figure 1). We remove all such redundant rules, and the resulting grammar is the CDAWG grammar  $G_{\text{CDAWG}}(T)$  for  $T$ .

Let  $g(T)$  denote the size of  $G_{\text{CDAWG}}(T)$ . Let  $F_i \rightarrow w \in (\Sigma \cup \{F_1, \dots, F_{i-1}\})^+$  be a production in  $G_{\text{CDAWG}}(T)$ . The length of the right-hand side of the production in  $G_{\text{CDAWG}}(T)$  is equal to the number of outgoing edges of the node of  $\overline{\text{CDAWG}(T)}$  that corresponds to  $F_i$ . This is equal to the number of in-edges of the node of  $\text{CDAWG}(T)$ . Thus, we have  $g(T) \leq e(T)$ . Recalling that the redundant rules have been removed in  $G_{\text{CDAWG}}(T)$ , we obtain the following equation with the number  $v^{(1)}(T)$  of nodes of in-degree 1 in  $\text{CDAWG}(T)$ .

**Fact 2.**  $g(T) = e(T) - v^{(1)}(T)$ .

### 2.4 Sensitivity of CDAWG-grammar $g$

Here, we consider the worst-case *additive sensitivity* of the CDAWG-grammar for any string of length  $n$  that terminates with  $\$$ , which is defined as follows:

$$\begin{aligned} \text{AS}(g, n) &= \max_{T \in \Sigma^n, T' \in \mathcal{K}(T, 1)} \{g(T') - g(T) \mid T[|T|] = T'[|T'|] = \$\} \\ &= \max_{T \in \Sigma^n, T' \in \mathcal{K}(T, 1)} \{(e(T') - e(T)) + (v^{(1)}(T) - v^{(1)}(T')) \mid T[|T|] = T'[|T'|] = \$\} \end{aligned} \tag{1}$$

where the second equation is due to Fact 2. We will evaluate the additive sensitivity of CDAWG-grammars by a function of the CDAWG size  $e$ .

We note that the differences of size of CDAWG and CDAWG-grammar with edits can vary (see also Example 1).

**Example 1.** Let  $T = \text{abcabab}\$$  and  $T' = \mathbf{b}\text{abcabab}\$$ , where  $\mathbf{b}$  is prepended to  $T$ . The CDAWG and CDAWG-grammar of  $T$  and  $T'$  are shown in Figure 2. The size difference of the CDAWG is  $e(T') - e(T) = 5$ , while that of the CDAWG-grammar is  $g(T') - g(T) = 2$ .

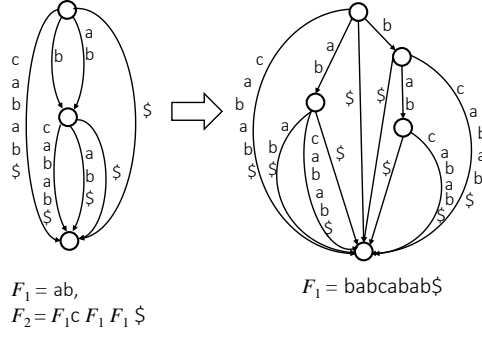

Figure 2: The CDAWG and CDAWG-grammar for the strings  $T$  and  $T'$  in Example 1.

### 3 Difference in the number of the edges in CDAWG

In this section, we consider the value of the first half  $(e(T') - e(T))$  in Equation (1). Note that this half is equal to the sensitivity of the size of the CDAWG. In light of this, we review the results in the recent work by Hamai et al. [9] on the sensitivity of CDAWGs, and make further discussions to be used in our analysis on the sensitivity of CDAWG-grammars.

**Definition 1.** Let  $x = T'[j..k]$  be a non-empty substring of  $T'$  that *touches or contains* the edited position  $i$ . That is, if the edit operation is insertion and substitution, (1)  $k = i - 1$  (touching  $i$  from left), (2)  $j \leq i \leq k$  (containing  $i$ ), or (3)  $j = i + 1$  (touching  $i$  from right). If the edit operation is deletion, (1)  $k = i - 1$  (touching  $i$  from left), (2)  $j \leq i - 1 \wedge i \leq k$  (containing  $i$ ), or (3)  $j = i$  (touching  $i$  from right). These occurrences of a substring  $x$  in  $T'$  are said to be *crossing occurrences* for the edited position  $i$ . We will call these occurrences simply as crossing occurrences of  $x$ .

We denote the left most crossing occurrence  $T'[j'..k']$  of  $x$  as  $x_L$ . For  $x_L$ , we consider the following substrings  $P_{x_L}$  and  $S_{x_L}$  of  $T'$  (see Figure 3 for illustration):

In the case that the edit operation is insertion or substitution, let

$$P_{x_L} = \begin{cases} T'[j'..i] & \text{if } x_L \text{ touches } i \text{ from left or contains } i, \\ \varepsilon & \text{if } x_L \text{ touches } i \text{ from right,} \end{cases}$$

$$S_{x_L} = \begin{cases} \varepsilon & \text{if } x_L \text{ touches } i \text{ from left,} \\ T'[i..k'] & \text{if } x_L \text{ contains } i \text{ or touches } i \text{ from right.} \end{cases}$$

In the case that the edit operation is deletion, let

$$P_{x_L} = \begin{cases} T'[j'..i - 1] & \text{if } x_L \text{ touches } i \text{ from left or contains } i, \\ \varepsilon & \text{if } x_L \text{ touches } i \text{ from right,} \end{cases}$$

$$S_{x_L} = \begin{cases} \varepsilon & \text{if } x_L \text{ touches } i \text{ from left,} \\ T'[i..k'] & \text{if } x_L \text{ contains } i \text{ or touches } i \text{ from right.} \end{cases}$$

We define the rightmost crossing occurrence  $x_R$ , together with  $P_{x_R}$  and  $S_{x_R}$ , analogously.

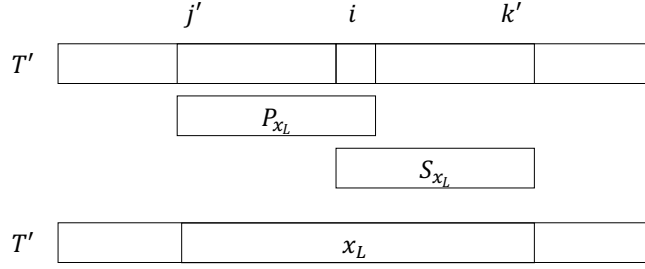

Figure 3: Illustration of  $x_L$  in  $T'$  for the case where  $x_L$  contains  $i$ , with insertion and substitution.

Additionally, this research divides  $\text{MR}(T')$  into four subset.

**Definition 2.** Let  $\mathbf{N} = (\text{M}(T') \setminus \text{M}(T)) \setminus \{T'\}$  and  $\mathbf{Q} = \text{MR}(T') \setminus \mathbf{N}$  (or equivalently  $\mathbf{Q} = \text{MR}(T') \cap \text{MR}(T)$ ). We define the subsets  $\mathbf{N}_1, \mathbf{N}_2$  and  $\mathbf{N}_3$  with  $\mathbf{N}$  as follows:

- $x \in \mathbf{N}_1 \Leftrightarrow x \in \mathbf{N} \cap \text{RightM}(T)$
- $x \in \mathbf{N}_2 \Leftrightarrow x \in \mathbf{N} \cap \text{LeftM}(T)$
- $x \in \mathbf{N}_3 \Leftrightarrow x \in \mathbf{N} \setminus \{\mathbf{N}_1 \cup \mathbf{N}_2\}$

Further, let  $\mathbf{N}_{3B}$  denote a set of  $x \in \mathbf{N}_3$  satisfying the two following conditions: (1) If all occurrences of  $x$  in  $T'$  are crossing occurrences of  $x$  in  $T'$ , then  $x \in \text{MR}(T')$ , and (2) There is no distinct right-extension of  $x$  in  $T'$  other than the right-extension(s) of the crossing occurrence(s) of  $x$ . Let  $\mathbf{N}_{3A} = \mathbf{N}_3 \setminus \mathbf{N}_{3B}$ .

### 3.1 Upper bound for total out-degrees of nodes w.r.t. $\mathbf{N}_1 \cup \mathbf{N}_{3A}$

In this subsection, we show an upper bound for the total out-degrees of nodes corresponding to the strings that are elements of  $\mathbf{N}_1 \cup \mathbf{N}_{3A}$ .

**Lemma 1** (Lemma 2 and 3 for [9]). *If  $x \in \mathbf{N}_1 \cup \mathbf{N}_{3A}$ , there is no pair  $(y, z) \subseteq \mathbf{N}_1 \cup \mathbf{N}_{3A}$  of distinct strings ( $y \neq z$ ) with  $|x| < |y|$  and  $|x| < |y|$  such that both  $S_{x_L} = S_{y_F}$  and  $S_{x_R} = S_{z_G}$  hold at the same time, where  $F, G \in \{L, R\}$ .*

From now on we consider the correspondence  $\mathbf{N}_1 \cup \mathbf{N}_{3A}$  and  $\text{MR}(T)$ . For any  $x \in \mathbf{N}_1 \cup \mathbf{N}_{3A}$ , if there does not exist  $y \in \mathbf{N}_1 \cup \mathbf{N}_{3A} (|y| > |x|, G \in \{L, R\})$  such that  $S_{x_L} = S_{y_G}$ , then we associate  $x$  with  $S_{x_L}$ , and otherwise we associate  $x$  with  $S_{x_R}$ .

Also, let  $U(x)$  denote the string that is obtained by extending  $S_{x_G}$ , to which  $x$  corresponds, to the left in  $T$  until becoming left-maximal in  $T$ . The following property holds:

**Lemma 2** (Lemma 4 and 5 for [9]). *If  $x, y \in \mathbf{N}_1 \cup \mathbf{N}_{3A}$ , then  $U(x), U(y) \in \text{M}(T)$  and  $U(x) \neq U(y)$ . Also,  $d_{T'}(x) \leq d_T(U(x)) + 2$ .*

Also, let  $\mathbf{N}_{(+2)}, \mathbf{N}_{(+1)}, \mathbf{N}_{(\leq+0)}$  denote the subsets of  $\mathbf{N}_1 \cup \mathbf{N}_{3A}$  such that:

$$\begin{aligned} \mathbf{N}_{(+2)} &= \{x \in \mathbf{N}_1 \cup \mathbf{N}_{3A} \mid d_{T'}(x) = d_T(U(x)) + 2\}, \\ \mathbf{N}_{(+1)} &= \{x \in \mathbf{N}_1 \cup \mathbf{N}_{3A} \mid d_{T'}(x) = d_T(U(x)) + 1\}, \\ \mathbf{N}_{(\leq+0)} &= \{x \in \mathbf{N}_1 \cup \mathbf{N}_{3A} \mid d_{T'}(x) \leq d_T(U(x))\}. \end{aligned}$$

Since any  $x \in \mathbf{N}_1 \cup \mathbf{N}_{3A}$  satisfies  $d_{T'}(x) \leq d_T(U(x))$  due to Lemma 2,  $\mathbf{N}_1 \cup \mathbf{N}_{3A} = \mathbf{N}_{(+2)} \cup \mathbf{N}_{(+1)} \cup \mathbf{N}_{(\leq+0)}$  holds.

Overall, we have that

$$\begin{aligned}
\sum_{x \in \mathbf{N}_1 \cup \mathbf{N}_{3A}} d_{T'}(x) &= \sum_{x \in \mathbf{N}_{(+2)}} d_{T'}(x) + \sum_{x \in \mathbf{N}_{(+1)}} d_{T'}(x) + \sum_{x \in \mathbf{N}_{(\leq+0)}} d_{T'}(x) \\
&\leq \sum_{x \in \mathbf{N}_{(+2)}} (d_T(U(x)) + 2) + \sum_{x \in \mathbf{N}_{(+1)}} (d_T(U(x)) + 1) + \sum_{x \in \mathbf{N}_{(\leq+0)}} d_T(U(x)) \\
&= \sum_{x \in \mathbf{N}_1 \cup \mathbf{N}_{3A}} d_T(U(x)) + 2|\mathbf{N}_{(+2)}| + |\mathbf{N}_{(+1)}| \\
&\leq e(T) + 2(|\mathbf{N}_{(+2)}| + |\mathbf{N}_{(+1)}| + |\mathbf{N}_{(\leq+0)}|) - |\mathbf{N}_{(+1)}| - 2|\mathbf{N}_{(\leq+0)}|
\end{aligned}$$

Noting that  $|\mathbf{N}_{(+2)}| + |\mathbf{N}_{(+1)}| + |\mathbf{N}_{(\leq+0)}| \leq |\mathbf{M}(T)|$  due to Lemma 2, we have the following:

**Lemma 3.**  $\sum_{x \in \mathbf{N}_1 \cup \mathbf{N}_{3A}} d_{T'}(x) \leq e(T) + 2|\mathbf{M}(T)| - |\mathbf{N}_{(+1)}| - 2|\mathbf{N}_{(\leq+0)}|.$

### 3.2 Upper bound for total out-degrees of nodes w.r.t. $\mathbf{N}_2 \cup \mathbf{Q}$

In this subsection, we consider an upper bound for the total out-degrees of nodes corresponding to the strings that are elements of  $\mathbf{N}_2 \cup \mathbf{Q}$ . We divide the total out-edges of the nodes into two: the number  $\mathcal{J}(T)$  of the right-extensions of the non-crossing occurrences and the number  $\mathcal{L}(T)$  of the right-extensions only in the crossing occurrences, such that  $\sum_{x \in \mathbf{N}_2 \cup \mathbf{Q}_1} d_{T'}(x) = \mathcal{J}(T) + \mathcal{L}(T)$ .

For the first half  $\mathcal{J}(T)$ , the right-extensions of  $x$  with non-crossing occurrences in  $T'$  does not exceed the right-extensions of  $x$  in  $T$  because the non-crossing occurrences are not affected by the edit. If  $x \in \mathbf{N}_2$ , then  $x$  is not right-maximal in  $T$ . Thus, each node has at most one right-extension with non-crossing occurrences. On the other hand, if  $x \in \mathbf{Q}$ , then each nodes' right-extension with non-crossing occurrences does not exceed  $d_T(x)$ . By summing up these, we have the following lemma:

**Lemma 4.**  $\mathcal{J}(T) \leq |\mathbf{N}_2| + e(T).$

From now on we consider the second half  $\mathcal{L}(T)$ . A right-extension  $a \in \Sigma$  of  $x \in \mathbf{N}_2 \cup \mathbf{Q}$  is said to be a *new* right-extension of  $x$  in  $T'$ , if  $xa$  does not occur in  $T$  and  $x$  has a crossing occurrence that immediately precedes  $a$  in  $T'$ . The following lemma holds:

**Lemma 5** (Adapted from [9]). *There is an injection from the new right-extensions of all strings in  $\mathbf{N}_2 \cup \mathbf{Q}$  to the maximal repeats in  $\mathbf{M}(T)$  (namely to the existing nodes in  $\text{CDAWG}(T)$ ), implying  $\mathcal{L}(T) \leq |\mathbf{M}(T)|.$*

From now on, we put these results together. Let  $\mathbf{Q}_1$  be the set of the node  $x \in \mathbf{Q}$  which obtains new right-extension(s) after the edit. Since  $x \in \mathbf{N}_2$  is not right-maximal in  $T$ ,  $x$  also has new right-extensions(s). Then, each node  $x \in \mathbf{N}_2 \cup \mathbf{Q}_1$  has new right-extension(s), which leads  $|\mathbf{N}_2| + |\mathbf{Q}_1| \leq |\mathbf{M}(T)|$ . As a result the following lemma holds:

**Lemma 6.**  $\sum_{x \in \mathbf{N}_2 \cup \mathbf{Q}_1} d_{T'}(x) \leq e(T) + |\mathbf{M}(T)| + |\mathbf{N}_2|.$

### 3.3 Upper bound for total out-degrees of nodes w.r.t. $N_{3B}$

In this subsection, we consider an upper bound for the total out-degrees of nodes corresponding to the strings that are elements of  $N_{3B}$ . The following is known:

**Lemma 7** (Reformulation of Lemma 15 of [9]).  $\sum_{x \in N_{3B}} d_{T'}(x) \leq 2|\text{MR}(T)|$ .

### 3.4 Putting all together

By Lemma 3, Lemma 6, and Lemma 7 (noting that  $|\text{MR}(T)| = |\text{M}(T)| - |\{T\}| = |\text{M}(T)| - 1$ ), the following theorem holds:

**Theorem 1.** *For any edit operation,  $e(T') \leq e(T) + 5|\text{MR}(T)| - |\text{N}_{(+1)}| - 2|\text{N}_{(\leq+0)}| + |\text{N}_2| + 3$ .*

## 4 Sensitivity of CDAWG-grammar

We here analyze the perturbation of the second half  $v^{(1)}(T) - v^{(1)}(T')$  of Equation 1 between the original string  $T$  and the edited string  $T'$ .

### 4.1 Difference in the number of nodes of in-degree one

We especially show the value of  $C(T)$ : the number of *existing nodes whose in-degree are changed from one after the edit*. Clearly  $v^{(1)}(T) - v^{(1)}(T') \leq C(T)$  holds.

Let  $I_T(x) = \{y \mid (y, x) \in E_T\}$ , where  $E_T$  is the set of edges of  $\text{CDAWG}(T)$ . Let  $x \in \text{MR}(T)$  be a node of in-degree one in the CDAWG for the original string  $T$  before the edit. We consider the following two cases:

1.  $x$  is not a maximal repeat in  $T'$  after edit (the node corresponding to  $x$  is deleted in  $\text{CDAWG}(T')$ ).
2.  $x$  has two or more in-edges in  $\text{CDAWG}(T')$  after the edit.

Let  $V_1(T)$  and  $V_2(T)$  denote the sets of strings  $x$  in Case 1 and in Case 2, respectively.

#### Case 1.

If  $x \in V_1(T)$ , then the node  $x$  itself and its out-edges are deleted. Since we have assumed that  $T$  terminates with a unique end-marker  $\$, d_T(x) \geq 2$ . Hence at least two edges are removed per node  $x \in V_1(T)$ . Thus, for the  $|V_1(T)|$  nodes of in-degree one in  $\text{CDAWG}(T)$  before the edit, at least  $2|V_1(T)|$  edges are removed in  $\text{CDAWG}(T')$  after the edit.

#### Case 2.

Let  $y$  be the (only) parent of a node  $x \in V_2(T)$  in the CDAWG of the original string  $T$ . Let  $q$  be the longest proper suffix of  $x$  that is a maximal repeat in  $T$ . See Figure 4. We categorize strings  $x \in V_2(T)$  using the unique parent  $y$  and its suffix  $q$ , as follows:

- (a)  $y \notin \text{MR}(T')$  (the node for  $y$  is deleted in  $\text{CDAWG}(T')$ ).
- (b)  $y \in \text{MR}(T')$  and  $q \notin \text{MR}(T')$  (the node for  $q$  is deleted in  $\text{CDAWG}(T')$ ).



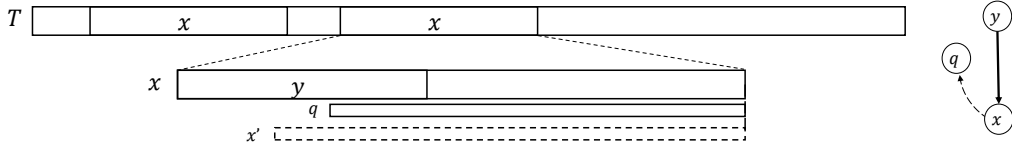

Figure 4: Illustration for the strings  $y$  and  $q$  for a string  $x \in V_2(T)$  and the relation of their nodes, where the dashed arc represents the suffix link. Any proper suffix  $x'$  of  $x$  that is longer than  $q$  is not a maximal repeat of  $T$ .

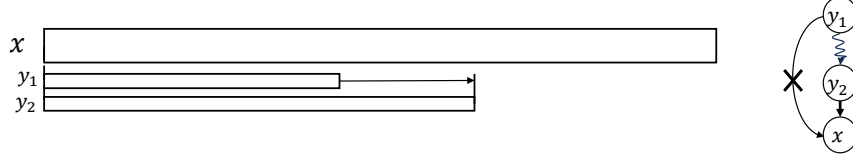

Figure 5: Illustration for the proof of Lemma 8. The case does not occur.

(c)  $y, q \in \text{MR}(T')$  (both of the nodes for  $y$  and  $q$  exist in  $\text{CDAWG}(T')$ ).

Let  $V_{2a}(T)$ ,  $V_{2b}(T)$ , and  $V_{2c}(T)$  be the sets of strings  $x \in \text{MR}(T)$  which are in Case 2(a), Case 2(b), and Case 2(c), respectively.

### Case 2(a)

For each  $x \in V_{2a}(T)$ , its parent node  $y$  and the edge  $(y, x)$  are removed. Thus, for the  $|V_{2a}(T)|$  nodes of in-degree one in  $\text{CDAWG}(T)$  before the edit, at least  $|V_{2a}(T)|$  edges are removed in  $\text{CDAWG}(T')$  after the edit.

### Case 2(b)

For each  $x \in V_{2b}(T)$ , similarly to Case 1, the node for  $x$ , the node for  $q$  and the out-edges of  $q$  are deleted in  $\text{CDAWG}(T')$ . Since  $d_T(q) \geq 2$ , at least two edges are removed per node  $x \in V_{2b}(T)$ . Thus, for the  $|V_{2b}(T)|$  nodes of in-degree one in  $\text{CDAWG}(T)$  before the edit, at least  $2|V_{2b}(T)|$  edges are removed in  $\text{CDAWG}(T')$  after the edit.

### Case 2(c)

From now on we consider the case  $x \in V_{2c}(T)$ . If the in-degree of  $x$  is at least 2 in  $\text{CDAWG}(T')$ , the following lemma holds:

**Lemma 8.** *If  $y_1, y_2 \in l_{T'}(x)$ , at least one of  $y_1, y_2$  has a non-prefix occurrence in  $x$ .*

*Proof.* Assume for a contrary that each of  $y_1$  and  $y_2$  occurs exactly once in  $x$ , as a prefix of  $x$ . Without loss of generality, let  $|y_1| < |y_2|$ . Let  $a$  be the character such that  $y_1a$  is a prefix of  $x$ . Since  $y_1$  and  $y_2$  are prefixes of  $x$ , the right-representative  $\text{rexp}_T(y_1a)$  of  $y_1a$  is not longer than  $y_2$  and thus it is not  $x$ . If there is no other occurrence of  $y_1$  in  $x$ , then  $(y_1, x) \notin E_T$ , but this is a contradiction. Thus, at least one of  $y_1, y_2$  has a non-prefix occurrence in  $x$ .  $\square$

By Lemma 8,  $T$  has two maximal repeat as a prefix and non-prefix substring of  $x$ .

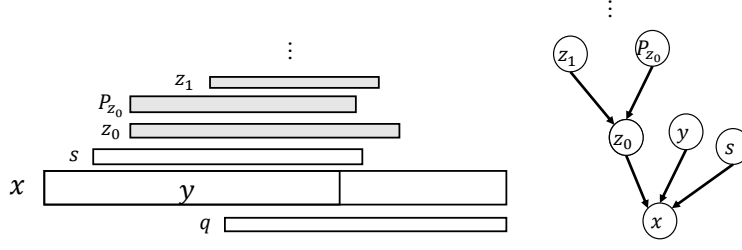

Figure 6: Illustration for  $z_i$  and  $P_{z_i}$  in  $x$  and  $\text{CDAWG}(T')$ . Both  $s$  and  $z_0$  are element of  $I_{T'}(x)$ , then  $z_0$  is defined which maximal repeats ends at the rightmost position.

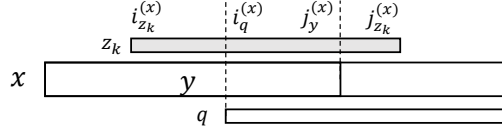

Figure 7: Illustration for Lemma 9.

**Definition 3.** For  $i \geq 0$ , we define  $z_i$  and  $P_i$  such that:

- $z_0$  is the maximal repeat in  $I_{T'}(x)$  whose ending position within  $x$  is the rightmost among those in  $I_{T'}(x)$ .
- $P_{z_i}$  is the maximal repeat which is the longest prefix of  $z_i$  where  $P_{z_i} \in I_{T'}(z_i)$ .
- $z_{i+1}$  is the maximal repeat in  $I_{T'}(z_i)$  whose ending position within  $z_i$  is the rightmost among those in  $I_{T'}(z_i)$ .

If there exist more than maximal repeats with a rightmost ending position, then the shortest one is selected as  $z_i$ .  $P_{z_i}$  and  $z_{i+1}$  are undefined when  $z_i$  is a suffix of  $y$  or  $z_i$  is in-degree 1.

This definition implies that  $x$  has in-edges from  $y$  and  $z_0$ , and  $z_i$  has in-edges from  $z_{i+1}$  and  $P_{z_i}$  in  $\text{CDAWG}(T')$ . Since  $(z_{i+1}, z_i) \in E_{T'}$ ,  $|z_i| > |z_{i+1}|$  holds. Then, there exists  $i$  satisfying that  $z_i$  is a suffix of  $y$  or  $z_i$  has only 1 in-edge (i.e. the generations of  $P_{z_i}$  and  $z_{i+1}$  are stopped at some  $z_i$ ).

Let us denote the occurrence of  $q$  and  $z_i$  in  $x$  as  $q = x[i_q^{(x)} .. j_q^{(x)}]$ ,  $z_i = x[i_{z_i}^{(x)} .. j_{z_i}^{(x)}]$  respectively. For  $q$  and  $z_i$ , we have the following lemma:

**Lemma 9.** For  $i \geq 0$ ,  $i_{z_i}^{(x)} < i_q^{(x)} < j_y^{(x)} \leq j_{z_i}^{(x)}$  holds.

*Proof.* We prove the lemma by induction.

1. Let  $z'_0 = x[z_0^{(x)} + 1 .. |x|]$ . Then  $z_0 z'_0$  is a suffix of  $x$ , and  $z'_0$  is the label of the edge  $(z_0, x)$  in  $\text{CDAWG}(T')$ . Assume for a contrary that  $i_{z'_0}^{(x)} \geq i_q^{(x)}$ . Then  $z_0 z'_0$  is also a suffix of  $q$  and  $z'_0$  is the label of the edge  $(z_0, q)$ , which is a contradiction. Assume for a contrary that  $j_y^{(x)} > j_{z'_0}^{(x)}$ . Then  $z_0$  is a substring of  $y$ . Since  $y \in \text{MR}(T')$ , every path from  $z_0$  to  $x$  goes through the node  $y$ . This implies that  $z_0$  does not have an out-edge to  $x$ , which is a contradiction. Thus,  $i_{z_0}^{(x)} < i_q^{(x)} < j_y^{(x)} \leq j_{z_0}^{(x)}$ .

2. If  $i_{z_i}^{(x)} < i_q^{(x)} \leq j_{z_i}^{(x)}$  holds and  $z_{i+1}$  is generated, then  $i_q^{(x)} < j_{z_i}^{(x)}$  holds by definition. Assume for a contrary that  $i_{z_{i+1}}^{(x)} \geq i_q^{(x)}$ . Let  $s_{z_i}$  denote the overlap between  $z_i$  and  $q$ . Then  $z_{i+1}$  is a substring of  $s_{z_i}$ . Since  $z_i, q \in \text{MR}(T')$ ,  $s_{z_i} \in \text{MR}(T')$ . Thus, every path from  $z_{i+1}$  to  $z_i$  goes through the node  $s_{z_i}$  (and thus  $z_{i+1}$  does not have an out-edge to  $z_i$ ), which is a contradiction. Assume for a contrary that  $j_y^{(x)} > j_{z_{i+1}}^{(x)}$ . Then  $z_{i+1}$  is substring of  $y$ . Since  $y \in \text{MR}(T')$ , every path from  $z_{i+1}$  to  $x$  goes through the node  $y$ . This implies that  $z_{i+1}$  does not have an out-edge to  $z_i$ , which is a contradiction. Thus,  $i_{z_{i+1}}^{(x)} < i_q^{(x)} < j_y^{(x)} \leq j_{z_{i+1}}^{(x)}$ .

□

From now on, consider the string  $z_i$  such that  $z_{i+1}$  is not generated. Let  $z_l(x) = z_i$ . We must consider the following two situations:

- (I)  $z_l(x)$  has only a single in-edge and it is not a suffix of  $y$ .
- (II)  $z_l(x)$  is a suffix of  $y$ .

For Case (I), let  $V_{2c(I)}(T)$  denote the set of strings  $x$  in Case (I). We remark that  $z_l(x)$  has only a single in-edge, and  $z_l(x)$  is a new node whose in-degree is one in  $\text{CDAWG}(T')$ , instead of  $x$ . Also, we have the following lemma:

**Lemma 10.** *If  $x_1 \neq x_2$  and both  $z_l(x_1)$  and  $z_l(x_2)$  are in Case (I), then  $z_l(x_1) \neq z_l(x_2)$ .*

*Proof.* Suppose that  $z_l(x_1) = z_l(x_2)$ . Then  $x_1$  and  $x_2$  have a common substring that contains  $z_l(x_1)$  as substring. Let  $x'$  is their maximal common substring which covers  $z_l(x_1)$  such that  $x' \in \text{MR}(T)$ . Since  $i_{z_i}^{(x)} < i_q^{(x)} < j_y^{(x)} \leq j_{z_i}^{(x)}$  from Lemma 9,  $i_{x'}^{(x)} < i_q^{(x)} < j_y^{(x)} \leq j_{x'}^{(x)}$  also holds.  $y$  is the only node that has an out-edge to  $x$  in  $\text{CDAWG}(T)$ , and  $q$  is the longest maximal repeat of  $T$  that is a proper suffix of  $x$ , then  $\text{rexp}_T(x')$  is a suffix of  $x$  that is longer than  $q$ . Thus,  $x'$  also has outgoing edge to  $x$  in  $\text{CDAWG}(T)$ , which is a contradiction. □

By Lemma 10, there is an injective mapping from a new node  $z_l(x)$  in  $\text{CDAWG}(T')$  to an existing node  $x$  in  $\text{CDAWG}(T)$ , and these nodes have only a single in-edge. Thus, the number of nodes whose in-degree is one does not change in Case (I).

For Case (II), let  $V_{2c(II)}(T)$  denote the set of strings  $x$  satisfying in Case (II), and  $V_{2c(II)}^{(y)}(T)$  denote the set of strings  $y$  corresponding to  $x \in V_{2c(II)}(T)$ . If  $x \in V_{2a}(T)$ ,  $z_l(x)$  is right-maximal and is not left-maximal in  $T$  since  $z_l(x)$  is a suffix of  $y$  and  $z_l(x) \notin \text{MR}(T)$ . Then,  $z_l(x) \in N_1$ . Let  $P_q$  denote the overlap of  $y$  and  $q$ . Since  $y, q \in \text{MR}(T)$ ,  $P_q \in \text{MR}(T)$ . For  $P_q$ , we have following lemma:

**Lemma 11.**  *$P_q$  has also a cross-occurrence by edits. Also,  $U(z_l(x))$  (corresponding existing maximal repeat to  $x$ ) is a suffix of  $P_q$ .*

*Proof.* Suppose that  $P_q$  has only non-crossing occurrence(s) in  $T'$ .  $z_l(x)$  has a crossing occurrence in  $T'$  since  $z_l(x) \in N_1$ . Since  $P_q$  has only non crossing occurrence(s) in  $T'$ ,  $U(z_l(x))$  is a maximal repeat in  $T$  which has  $P_q$  as its proper suffix. Let  $S_q$  be the string such that  $q = P_q S_q$ . Since  $U(z_l(x)) S_q$  is a suffix of  $x$  longer than  $q$ ,  $U(z_l(x)) S_q \equiv_T^L x$  holds. Noting that  $U(z_l(x))$  is also a suffix of  $y$ , there exists a path from  $U(z_l(x))$  to  $x$  which does not contain



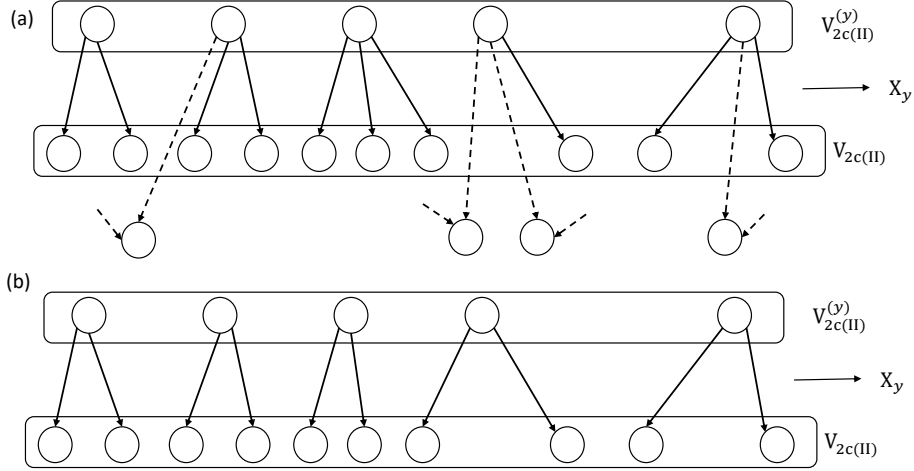

Figure 9: (a) Illustration for the definitions of  $V_{2c(II)}^{(y)}(T)$ ,  $X_y$  and  $SUM_y$ .  $SUM_y$  counts all of the out-edges from  $y \in V_{2c(II)}^{(y)}(T)$ , although  $X_y$  only counts the edges going to  $x \in V_{2c(II)}(T)$  (only solid-line edges are counted). (b) The situation of (a) in which  $g(T') - g(T)$  is maximized.

Also, the following lemma holds:

**Lemma 14.**  $|\mathbf{N}_2| \leq |\mathbf{M}(T)| - (|V_{(+1)}^{(z)}| + 2|V_{(+2)}^{(z)}|)$ .

*Proof.* Suppose that  $z_l(x) \in V_{(+2)}^{(z)}$ . Since  $U(z_l(x))$  is a suffix of  $z_l(x)$ ,  $d_{T'}(U(z_l(x))) \geq d_{T'}(z_l(x)) = d_T(U(z_l(x))) + 2$  holds. This implies that each  $z_l(x) \in V_{(+2)}^{(z)}$ ,  $U(z_l(x))$  associates with two distinct maximal repeats in  $T$  due to Lemma 5. Similarly, for each  $z_l(x) \in V_{(+1)}^{(z)}$ ,  $d_{T'}(U(z_l(x))) \geq d_T(U(z_l(x))) + 1$  holds, and  $U(z_l(x))$  associates with a single distinct maximal repeat in  $T$ . Then, at least  $|V_{(+1)}^{(z)}| + 2|V_{(+2)}^{(z)}|$  maximal repeats associate with  $U(z_l(x)) \in \mathbf{Q}_1$ , which means that at most  $|\mathbf{M}(T)| - \{|V_{(+1)}^{(z)}| + 2|V_{(+2)}^{(z)}|\}$  maximal repeats associate with  $s \in \mathbf{N}_2$  due to Lemma 5. Since  $s \in \mathbf{N}_2$  has at least one corresponding maximal repeat in  $T$ ,  $|\mathbf{N}_2| \leq |\mathbf{M}(T)| - (|V_{(+1)}^{(z)}| + 2|V_{(+2)}^{(z)}|)$  holds.  $\square$

To consider the size of  $|V_{2c(II)}(T)|$ , let  $SUM_y = \sum_{y \in V_{2c(II)}^{(y)}(T)} (d_T(y))$ , and  $X_y$  be the total number of in-edges of  $x \in V_{2c(II)}(T)$ . Since  $x \in V_{2c(II)}(T)$  has only one in-edge  $(y, x)$  where  $y \in V_{2c(II)}^{(y)}(T)$ ,  $|V_{2c(II)}(T)| = X_y \leq SUM_y$  holds.

### Putting all together

From now on we put all these results (Case 1, 2.a, 2.b, 2.c.(I), 2.c.(II)) together. Since  $C(T) = |V_1(T)| + |V_{2a}(T)| + |V_{2b}(T)| + |V_{2c(I)}(T)| + |V_{2c(II)}(T)|$  and we have that at least  $|V_{2c(I)}(T)|$  new nodes have only one in-edge by Case 2.c.(I), we have the following lemma:

**Lemma 15.** *For the existing edges and  $v^{(1)}$ , we have the following properties:*

- $v^{(1)}(T) - v^{(1)}(T') \leq |V_1(T)| + |V_{2a}(T)| + |V_{2b}(T)| + X_y$  holds.
- At least  $|V_1(T)| + |V_{2a}(T)| + |V_{2b}(T)|$  existing edges are removed.

## 4.2 Combine the results

In this section, we combine the results of Lemmas 1, 13, 14 and 15. Noting that the terms  $|V_1(T)| + |V_{2a}(T)| + |V_{2b}(T)|$  appearing in  $e(T') - e(T)$  and  $v^{(1)}(T') - v^{(1)}(T)$  (see Lemma 15) cancel each other, the following inequality holds:

$$\begin{aligned}
g(T') - g(T) &= (e(T') - e(T)) - (v^{(1)}(T') - v^{(1)}(T)) \\
&\leq e(T) + 5|\text{MR}(T)| - |\mathbf{N}_{(+1)}| - 2|\mathbf{N}_{(\leq+0)}| + |\mathbf{N}_2| + 3 + \mathbf{X}_y \\
&\leq e(T) + 6|\text{MR}(T)| - |\mathbf{V}_{(+1)}^{(z)}| - 2|\mathbf{V}_{(\leq+0)}^{(z)}| - (|\mathbf{V}_{(+1)}^{(z)}| + 2|\mathbf{V}_{(+2)}^{(z)}|) + \mathbf{X}_y + 4 \\
&= e(T) + 6|\text{MR}(T)| + \mathbf{X}_y - 2|\mathbf{V}_{2c(\text{II})}^{(y)}(T)| + 4
\end{aligned} \tag{2}$$

Now we consider the value of  $\mathbf{X}_y$ . Let  $\text{SUM}_{\bar{y}} = \sum_{y \in \text{MR}(T) \setminus \mathbf{V}_{2c(\text{II})}^{(y)}(T)} (\mathbf{d}_T(y))$ .

For the relation between  $\text{SUM}_y$ ,  $|\text{MR}(T)|$  and  $e(T)$ , we have the following lemma:

**Lemma 16.** *Let  $\omega = \mathbf{X}_y - 2|\mathbf{V}_{2c(\text{II})}^{(y)}(T)|$ , then  $|\text{MR}(T)| \leq 1/2 \min(e(T), e(T) - \omega)$ .*

*Proof.* If  $\omega \leq 0$ , then  $e(T) \geq 2|\text{MR}(T)|$  due to Fact 1. If  $\omega > 0$ , then  $\text{SUM}_y \geq \mathbf{X}_y = 2|\mathbf{V}_{2c(\text{II})}^{(y)}(T)| + \omega$  holds. Since  $\text{SUM}_y + \text{SUM}_{\bar{y}} = e(T)$  and  $\text{SUM}_{\bar{y}} \geq |\text{MR}(T) \setminus \mathbf{V}_{2c(\text{II})}^{(y)}(T)|$ ,  $e(T) \geq 2|\text{MR}(T)| + \omega$ . Then  $|\text{MR}(T)| \leq 1/2(e(T) - \omega)$ .  $\square$

Substituting the value of Lemma 16 to inequality (2),  $g(T') - g(T) \leq 4e(T) + \omega + 4$  if  $\omega \leq 0$ , or  $g(T') - g(T) \leq 4e(T) - 2\omega + 4$  if  $\omega > 0$ . To maximize it, we must satisfy  $\text{SUM}_y = \mathbf{X}_y$  and  $\omega = 0$  (i.e.  $\mathbf{X}_y = 2|\mathbf{V}_{2c(\text{II})}^{(y)}(T)|$ ). In the case, all  $y \in \mathbf{V}_{2c(\text{II})}^{(y)}(T)$  have two outgoing edges to distinct  $x \in \mathbf{V}_{2c(\text{II})}(T)$  (see Figure 9). As a result, we have a following theorem:

**Theorem 2.** *For any string  $T$ , the additive sensitivity of the CDAWG-grammar is at most  $4e(T) + 4$ .*

## Acknowledgements

This work was supported by JSPS KAKENHI Grant Numbers JP23K24808 and JP23K18466 (SI).

## References

- [1] T. Akagi, M. Funakoshi, and S. Inenaga. Sensitivity of string compressors and repetitiveness measures. *Information and Computation*, 291:104999, 2023.
- [2] P. Baturó, M. Piatkowski, and W. Rytter. Usefulness of directed acyclic subword graphs in problems related to Standard Sturmian Words. *Int. J. Found. Comput. Sci.*, 20(6):1005–1023, 2009.
- [3] D. Belazzougui and F. Cunial. Fast label extraction in the CDAWG. In *SPIRE 2017*, pages 161–175, 2017.
- [4] D. Belazzougui and F. Cunial. Representing the Suffix Tree with the CDAWG. In *28th Annual Symposium on Combinatorial Pattern Matching (CPM 2017)*, volume 78, pages 7:1–7:13, 2017.

- [5] A. Blumer, J. Blumer, D. Haussler, R. McConnell, and A. Ehrenfeucht. Complete inverted files for efficient text retrieval and analysis. *Journal of the ACM*, 34(3):578–595, 1987.
- [6] A. Cleary and J. Dood. Constructing the CDAWG CFG using LCP-intervals. In *2023 Data Compression Conference (DCC)*, pages 178–187, 2023.
- [7] M. Crochemore and R. V erin. On compact directed acyclic word graphs. In *Structures in Logic and Computer Science: A Selection of Essays in Honor of A. Ehrenfeucht*, pages 192–211. Springer, 1997.
- [8] H. Fujimaru, Y. Nakashima, and S. Inenaga. Tight bounds for the sensitivity of CDAWGs with left-end edits. *Acta Informatica*, 62(12), 2025.
- [9] R. Hamai, H. Fujimaru, and S. Inenaga. Constant sensitivity on the CDAWGs. *CoRR*, abs/2502.05915, 2025.
- [10] S. Inenaga, H. Hoshino, A. Shinohara, M. Takeda, S. Arikawa, G. Mauri, and G. Pavese. On-line construction of compact directed acyclic word graphs. *Discrete Applied Mathematics*, 146(2):156–179, 2005.
- [11] D. Kempa and N. Prezza. At the roots of dictionary compression: string attractors. In *STOC 2018*, pages 827–840, 2018.
- [12] T. Kociumaka, G. Navarro, and N. Prezza. Toward a definitive compressibility measure for repetitive sequences. *IEEE Transactions on Information Theory*, 69(4):2074–2092, 2023.
- [13] J. Radoszewski and W. Rytter. On the structure of compacted subword graphs of Thue-Morse words and their applications. *J. Discrete Algorithms*, 11:15–24, 2012.
- [14] W. Rytter. The structure of subword graphs and suffix trees of Fibonacci words. *Theor. Comput. Sci.*, 363(2):211–223, 2006.
- [15] T. Takagi, K. Goto, Y. Fujishige, S. Inenaga, and H. Arimura. Linear-size CDAWG: New repetition-aware indexing and grammar compression. In *SPIRE 2017*, pages 304–316, 2017.
- [16] M. Takeda, T. Matsumoto, T. Fukuda, and I. Nanri. Discovering characteristic expressions from literary works: a new text analysis method beyond n-gram statistics and KWIC. In *Discovery Science 2000*, pages 112–126, 2000.
- [17] P. Weiner. Linear pattern matching algorithms. In *Proceedings of the 14th Annual Symposium on Switching and Automata Theory*, pages 1–11, 1973.
- [18] J. Ziv and A. Lempel. A universal algorithm for sequential data compression. *IEEE Transactions on Information Theory*, 23(3):337–343, 1977.