

DISCONTINUOUS TRANSITION IN 2D POTTS: I. ORDER-DISORDER INTERFACE CONVERGENCE

MORITZ DOBER, ALEXANDER GLAZMAN, AND SÉBASTIEN OTT

ABSTRACT. It is known that the planar q -state Potts model undergoes a discontinuous phase transition when $q > 4$ and there are exactly $q + 1$ extremal Gibbs measures at the transition point: q ordered (monochromatic) measures and one disordered (free). We focus on the Potts model under the Dobrushin order–disorder boundary conditions on a finite $N \times N$ part of the square grid. Our main result is that this interface is a well defined object, has \sqrt{N} fluctuations, and converges to a Brownian bridge under diffusive scaling. The same holds also for the corresponding FK-percolation model for all $q > 4$.

Our proofs rely on a coupling between FK-percolation, the six-vertex model, and the random-cluster representation of an Ashkin–Teller model (ATRC), and on a detailed study of the latter. The coupling relates the interface in FK-percolation to a long subcritical cluster in the ATRC model. For this cluster we develop a “renewal picture” *à la* Ornstein-Zernike. This is based on fine mixing properties of the ATRC model that we establish using the link to the six-vertex model and its height function. Along the way, we derive various properties of the Ashkin-Teller model, such as Ornstein-Zernike asymptotics for its two-point function.

In a companion work, we provide a detailed study of the Potts model under order-order Dobrushin conditions. We show emergence of a free layer of width \sqrt{N} between the two ordered phases (*wetting*) and establish convergence of its boundaries to two Brownian bridges conditioned not to intersect.

CONTENTS

1. Introduction and results	1
2. Notations and conventions	10
3. Ashkin–Teller random-cluster model	12
4. Couplings and interfaces	15
5. Weak mixing in the ATRC	24
6. Strong mixing	32
7. Random Walk picture in the ATRC	35
8. Invariance principle for the modified ATRC cluster	49
9. Proofs of Theorems 1, 2, 3 and 6	65
Appendix A. Mixing to ratio mixing	69
References	72

1. INTRODUCTION AND RESULTS

The Potts model is a classical model of statistical mechanics introduced in 1952 [Pot52]. Each vertex of a graph is assigned one of q states (colours), with states of adjacent vertices interacting with a strength depending on the temperature $T > 0$ of the system. At $q = 2$, this corresponds to the seminal Ising model. The Potts model becomes

Date: February 7, 2025.

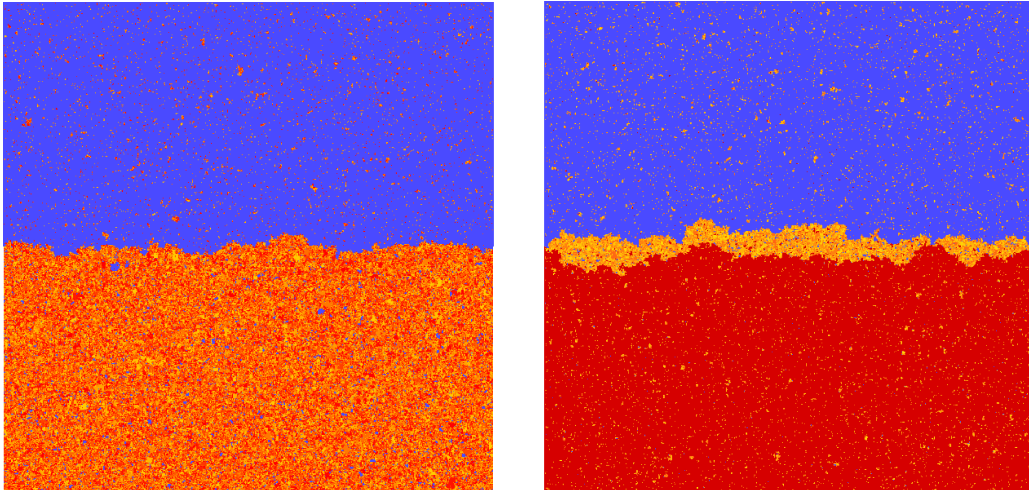

FIGURE 1. Sample of a 600x600 Potts model with 25 colours at $T_c(25)$ with Dobrushin boundary conditions. Left: order-disorder interface; upper part has blue b.c., bottom has white b.c. (no colour favoured), colours are: blue for the first and interpolate between yellow and red for colours 2 to 25. Right: colours are: blue for the first, red for the second, and interpolate between yellow and orange for colours 3 to 25.

increasingly ordered as the temperature decreases, and a phase transition occurs on lattices \mathbb{Z}^d with $d \geq 2$ at some transition temperature $T_c(q, d) > 0$. Depending on q and d , the transition is either discontinuous (first-order) or continuous (higher-order). Such a rich behaviour has brought a lot of attention to the Potts model.

Interface in the planar Potts model. Our work is restricted to dimension $d = 2$. In this case, planar duality and a correlation inequality (available when $q \geq 1$) have allowed to a watershed of progress in the phase diagram of the Potts model in the last two decades:

- the transition occurs at the self-dual point $T_c(q) := [\ln(1 + \sqrt{q})]^{-1}$ [BD12];
- the transition is continuous when $q = 2, 3, 4$, in a sense that, at $T_c(q)$, there is a unique Gibbs measure [DST17] (see also [GL23] for another argument);
- the transition is discontinuous when $q > 4$ [DGH⁺21] (see also [RS20] for a short proof), and any Gibbs measure can be written as a linear combination of $q + 1$ extremal Gibbs measures (q monochromatic and one free) [GM23].

We focus on discontinuous transitions ($q > 4$) and study interfaces at $T_c(q)$ separating different states. The structure of extremal Gibbs measures (described above) leads to two natural definitions of Dobrushin boundary conditions:

- *order-disorder*: one half of the boundary is of a fixed colour and the other one is free (no colour assigned);
- *order-order*: both halves of the boundary are assigned different fixed colours.

The phenomenology is quite different in the two cases, see Fig. 1.

The main result of the current paper is convergence of the interface under order-disorder conditions to the Brownian bridge in the diffusive limit. Results of such precision were previously proven for $T < T_c(q)$ and the order-order interface. Indeed, planar duality transfers this problem to the study of the typical geometry of long clusters at $T > T_c$, for which a quasi-renewal structure was developed in [CIV08]. We do use similar ideas, but the situation is more involved: duality does not help directly

as we work at the transition point with order-disorder boundary conditions, where duality only maps the problem to itself. Instead, we build on [BKW76] and [GP23] to construct a sequence of combinatorial mappings relating the interface in the FK-percolation to a suitable long subcritical cluster in the Ashkin-Teller model. We extend the study of [ADG24] to establish mixing properties in the latter model. This opens a way to obtain a renewal picture and invariance principle for long subcritical clusters in the ATRC model using the methods developed in [CIV03, CIV08, AOV24]. Finally, we transport back the convergence result to the FK and Potts models.

Let us also mention the work [MMSRS91] that showed \sqrt{N} fluctuations when q is taken to be large enough. Our results imply this for all $q > 4$. In this generality, the only progress was a recent complete characterisation of Gibbs measures in the planar Potts model [GM23]. This work proves that all Gibbs measures are invariant to translations, and this implies that the interface (if defined at all) exhibits diverging fluctuations.

The case of the order-order conditions is addressed in our companion paper: we show emergence of a free layer of width \sqrt{N} between the two ordered phases (*wetting*) and establish convergence of its boundaries to two Brownian bridges conditioned not to intersect.

In particular, we prove that, when $q > 4$, in both cases of Dobrushin conditions, as the mesh of the lattice tends to zero, the scaling limit of the interface in the Potts model is a straight line. To compare with what happens in the case of continuous phase transition, let us describe the expected behaviour for $q = 2, 3, 4$. The mesmerizing physics conjecture from 1980s postulates conformal invariance. Schramm’s [Sch00] geometric interpretation of this conjecture asserts that as one takes the scaling limit of the Potts model, the interface converges to a random fractal curve called the Schramm–Loewner Evolution. This has been proven rigorously only at $q = 2$ (Ising model) by Smirnov et al [Smi10, CS11, CDH⁺14].

The “Ornstein-Zernike” (OZ) theory is a (non-rigorous) picture introduced in [OZ14, Zer16] of how correlation functions in various models behave. Their main idea was to postulate a suitable *renewal structure* satisfied by correlation functions, which leads to very precise expressions for the asymptotics of the said correlations. The first rigorous implementation of this renewal picture was done by Abraham and Kunz [AK77] using perturbative expansions. The modern approach, which started with the work of Chayes, and Chayes [CC86] on the self-avoiding walk (SAW) and of Campanino, Chayes, and Chayes [CCC91] on Bernoulli percolation, is based on creating a renewal structure *à la* OZ for elongated subcritical objects (SAW or percolation clusters containing a distant point). Both these works rely on heavy combinatorial study, and the renewal steps are “irreducible crossings of slabs”.

This idea was further developed by Ioffe [Iof98] for the ballistic phase of the self-avoiding walk, introducing key measure-tilting ideas coming from large deviation theory. His strategy was then extended to Bernoulli percolation in [CI02], to the high-temperature Ising model [CIV03] and to the FK-percolation [CIV08]. Compared to the cases of SAW and Bernoulli percolation where the measure factorizes nicely, the structure obtained in the case of Ising and FK, while still geometrically being a concatenation of “irreducible blocs”, is not a real renewal structure. Indeed, it is only a sequence of “fast mixing kernels”, which study is heavier and performed in [CIV03]. The last step to finally obtain a true renewal structure from the fast mixing kernel picture was done in [OV18].

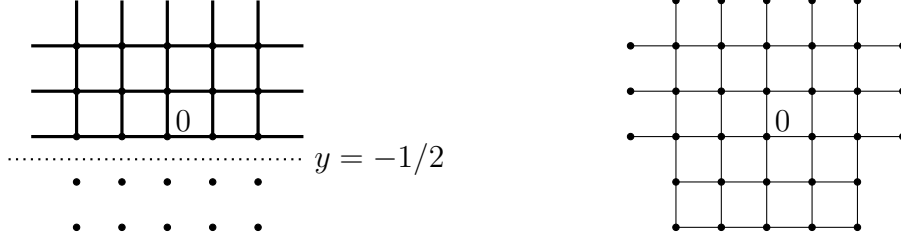

FIGURE 2. Left: wired-free Dobrushin boundary condition. Right: the graph G_2 .

These works on subcritical clusters of the FK-percolation all take place in any dimensions. On \mathbb{Z}^2 , planar duality allows to rewrite the interface of the Potts model at $T < T_c(q)$ as a subcritical FK-percolation cluster conditioned to contain $(0, 0)$ and $(N, 0)$.

Our contribution to this line of works is to derive a “renewal picture” for the long clusters of the planar random-cluster representation of the Ashkin–Teller model, for values of the parameters lying on the self-dual line. This model is then related to the Potts interface using a suitable adaptation of a coupling introduced in [GP23].

We now formally state our main results for the Potts model, the FK percolation and the Ashkin–Teller model.

1.1. Potts model. We view \mathbb{Z}^2 both as a set of points on the plane having integer coordinates and as a graph (square grid) with edges linking points at distance one. Denote by \mathbb{E} the set of edges in \mathbb{Z}^2 and write $i \sim j$ if $\{i, j\} \in \mathbb{E}$. Let $G = (V, E)$ be a subgraph of \mathbb{Z}^2 . Take parameters $T > 0$, $q \in \{2, 3, 4, \dots\}$, and boundary conditions $\eta \in \{0, 1, \dots, q\}^V$. The Potts model on G with boundary conditions η is the probability measure on $\{1, \dots, q\}^V$ given by

$$\text{Potts}_{G,T,q}^\eta(\sigma) := \frac{1}{Z_{\text{Potts}}} \cdot \exp \left[\frac{1}{T} \cdot \left(\sum_{\{i,j\} \in E} \delta(\sigma_i, \sigma_j) + \sum_{i \in V, j \in V^c: i \sim j} \delta(\sigma_i, \eta_j) \right) \right],$$

where $Z_{\text{Potts}} = Z_{\text{Potts}}(G, T, q, \eta)$ is the unique normalising constant (called *partition function*) that renders the above a probability measure, and $\delta(x, y) = 1$ if $x = y$ and $\delta(x, y) = 0$ otherwise. Value 0 for η corresponds to free boundary conditions favoring none of the q possible states of the spins.

We say that η defines the order-disorder (1-free) Dobrushin boundary conditions (and denote it by 1/f) if $\eta((x, y)) = \mathbb{1}_{\geq 0}(y)$. Identify $\Lambda_n := \{-n, \dots, n\}^2$ with the induced subgraph of \mathbb{Z}^2 on this set of vertices. The Dobrushin boundary conditions on Λ_n impose existence of an interface between color one and the rest. This can be made explicit, but for brevity we choose to define directly the upper and lower discrete envelopes of this interface: Γ_{Potts}^+ and Γ_{Potts}^- respectively. Given $\sigma \in \{1, \dots, q\}^{\Lambda_n}$, define $\bar{\sigma} \in \{0, 1, \dots, q\}^{\mathbb{Z}^2}$ to be its extension outside of Λ_n by the Dobrushin boundary conditions: one on $\mathbb{Z} \times \mathbb{Z}_{\geq 0}$ and zero on $\mathbb{Z} \times \mathbb{Z}_{< 0}$. For $k = -n, \dots, n$, define

$$\begin{aligned} \Gamma_{\text{Potts}}^{+,n}(k) &:= \max\{y \in \mathbb{Z} : (k, y-1) \xrightarrow{\bar{\sigma} \neq 1} (\mathbb{Z} \times \mathbb{Z}_{< 0}) \setminus \Lambda_n\}, \\ \Gamma_{\text{Potts}}^{-,n}(k) &:= \min\{y \in \mathbb{Z} : (k, y+1) \xrightarrow{\bar{\sigma} = 1, \text{diag}} (\mathbb{Z} \times \mathbb{Z}_{\geq 0}) \setminus \Lambda_n\}, \end{aligned}$$

where $(k, y-1) \xrightarrow{\bar{\sigma} \neq 1} (\mathbb{Z} \times \mathbb{Z}_{< 0}) \setminus \Lambda_n$ states the existence of a path in \mathbb{Z}^2 in going from $(k, y-1)$ to $(\mathbb{Z} \times \mathbb{Z}_{< 0}) \setminus \Lambda_n$ and consisting of vertices where $\bar{\sigma} \neq 1$ and $(k, y) \xrightarrow{\bar{\sigma} = 1, \text{diag}}$

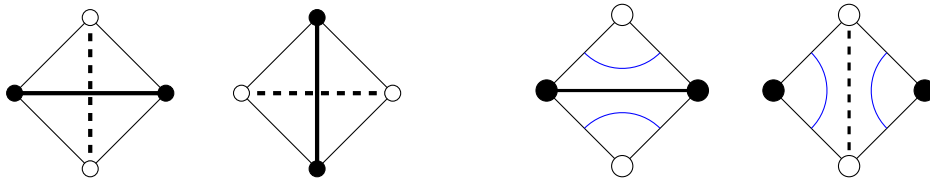

FIGURE 3. Left: Tile associated to a mid-edge. Right: Tile centred at the middle of a horizontal primal edge (solid black) or its associated vertical dual edge (dashed black), with its two possible local loop configurations.

$(\mathbb{Z} \times \mathbb{Z}_{\geq 0}) \setminus \Lambda_n$ states the existence of a path in \mathbb{Z}^2 with diagonal connectivity going from (k, y) to $(\mathbb{Z} \times \mathbb{Z}_{\geq 0}) \setminus \Lambda_n$ and consisting of vertices where $\bar{\sigma} = 1$. By \mathbb{Z}^2 with diagonal connectivity we mean a graph with the vertex-set \mathbb{Z}^2 with edges linking vertices at distance at most $\sqrt{2}$. Define the rescaled linear interpolation of $\Gamma_{\text{Potts}}^{+,n}$ and $\Gamma_{\text{Potts}}^{-,n}$ by

$$\tilde{\Gamma}_{\text{Potts}}^{\pm,n}(t) := \frac{1}{\sqrt{n}} \left((1 - \{2tn - n\}) \Gamma_{\text{Potts}}^{\pm}(\lfloor 2tn - n \rfloor) + \{2tn - n\} \Gamma_{\text{Potts}}^{\pm}(\lceil 2tn - n \rceil) \right),$$

where $\lfloor \cdot \rfloor$, $\lceil \cdot \rceil$, $\{ \cdot \}$ denote respectively lower and upper roundings and fractional part.

Theorem 1. *Let $q > 4$ be integer and take $T = T_c(q)$. For $n \in \mathbb{N}$, sample $\Gamma_{\text{Potts}}^{\pm,n}$ and $\tilde{\Gamma}_{\text{Potts}}^{\pm,n}$ from $\text{Potts}_{\Lambda_n; T_c(q), q}^{1/f}$ as described above. Then, as n tends to infinity,*

- (1) both $(\tilde{\Gamma}_{\text{Potts}}^{+,n}(t))_{t \in [0,1]}$ and $(\tilde{\Gamma}_{\text{Potts}}^{-,n}(t))_{t \in [0,1]}$ converge in law to $(c_q \mathfrak{b}_t)_{t \in [0,1]}$, where \mathfrak{b}_t is a standard Brownian bridge and $c_q > 0$ is some constant;
- (2) the probability that $\max_k |\Gamma_{\text{Potts}}^{+,n}(k) - \Gamma_{\text{Potts}}^{-,n}(k)| \geq C \ln(n)^2$ tends to zero.

The constant c_q has an explicit characterization, see Remark 8.12.

1.2. FK percolation. The main tool in analyzing the Potts model is the Fortuin–Kasteleyn (FK) percolation (or random-cluster) model [FK72] that allows to express the spin-spin correlation function via connection probabilities. We first define it and then state the relation between the two models. Take a finite subgraph $G = (V, E)$ of \mathbb{Z}^2 , parameters $p \in (0, 1)$, $q > 0$ and boundary conditions $\xi \in \{0, 1\}^{\mathbb{E}}$. We identify any $\omega \in \{0, 1\}^{\mathbb{E}}$ with the set of edges $e \in \mathbb{E}$ for which $\omega_e = 1$ (open edges) and with the spanning subgraph of \mathbb{Z}^2 defined by the open edges. The FK-percolation model on G with boundary conditions ξ is the probability measure on $\{0, 1\}^{\mathbb{E}}$ given by

$$\text{FK}_{G;p,q}^{\xi}(\eta) := \frac{1}{Z_{\text{FK}}} \cdot p^{|\eta \cap E|} (1-p)^{|E \setminus \eta|} q^{\kappa_V(\eta)} \mathbf{1}_{\eta = \xi \text{ on } \mathbb{E} \setminus E},$$

where $Z_{\text{FK}} = Z_{\text{FK}}(G, p, q, \xi)$ is the partition function and $\kappa_V(\eta)$ is the number of connected components (clusters) of (\mathbb{Z}^2, η) that intersect V .

The free and wired measures correspond to the choices $\xi \equiv 0$ and $\xi \equiv 1$, respectively, and we simply write f and w instead of ξ , respectively. We will be interested in the Dobrushin wired/free boundary conditions: $\xi_e = 1$ if and only if $e \subset \mathbb{Z} \times \mathbb{Z}_{\geq 0}$ (see Fig. 2). We denote these boundary conditions by 1/0.

For $n \geq 1$, define the graph $G_n = (V_n, E_n)$ by

$$E_n := \{e \in \mathbb{E} : e \subset \Lambda_n\} \cup \{e \in \mathbb{E} : e \subset \mathbb{Z} \times \mathbb{Z}_{\geq 0} \text{ and } e \cap \Lambda_n \neq \emptyset\}, \quad V_n := \bigcup_{e \in E_n} e.$$

The seminal Edwards–Sokal coupling [ES88] states that, when $q \geq 2$ is integer and $p = 1 - \exp[-\frac{1}{T}]$, coloring clusters of $\omega \sim \text{FK}_{G_n;p,q}^{1/0}$ independently in colors $1, 2, \dots, q$

gives a spin configuration $\sigma \sim \text{Potts}_{\Lambda_n; T, q}^{1/f}$. We will denote this coupling between the Potts model and the FK percolation by $\text{ES}_{\Lambda_n, T, q}^{1/0}$.

We define an interface in the FK percolation forced by the Dobrushin boundary conditions using planar duality. Note that the lattice dual to \mathbb{Z}^2 is again a square lattice and we denote it by $(\mathbb{Z}^2)^*$. For each edge e of \mathbb{Z}^2 , denote by e^* the edge of $(\mathbb{Z}^2)^*$ that is dual to e , i.e. the unique edge of $(\mathbb{Z}^2)^*$ that intersects e ; see Fig. 3. Given $\omega \in \{0, 1\}^{\mathbb{E}}$, define its dual by

$$\omega_{e^*}^* := 1 - \omega_e.$$

The FK percolation at $p_c(q)$, given by

$$p_c(q) := 1 - \exp\left[-\frac{1}{T_c(q)}\right] = \frac{\sqrt{q}}{\sqrt{q+1}},$$

is known to enjoy the self-duality: if $\omega \sim \text{FK}_{G_n; T_c(q), q}^{1/0}$, then its dual ω^* is also distributed as an FK-percolation with parameters q and $p_c(q)$, but on a dual graph and under dual Dobrushin boundary conditions. This self-dual nature is also revealed when looking at the loop representation of the FK percolation model. Specifically, we draw two arcs next to every primal or dual edge of ω , as shown on Fig. 3. These arcs link together into loops separating primal and dual clusters and one interface tracing the boundary of the union of primal clusters attached to the upper boundary of Λ_n . Denote this interface by Γ_{FK} . Remarkably, a standard application of the Euler's formula (see eg. [DGH⁺21, Lemma 3.9]), allows to rewrite the distribution of ω via loops which are symmetric with respect primal and dual configurations:

$$\text{FK}_{G_n; p_c(q), q}^{1/0}(\omega) = \frac{1}{Z_{\text{loop}}} \cdot \sqrt{q}^{\#\text{loops}}, \quad (1)$$

where $\#\text{loops}$ stands for the number of loops in the loop representation of ω . This is a part of the classical Baxter–Kelland–Wu [BKW76] coupling between the FK percolation and the six-vertex model; see Sections 4 and 5.1.4.

As for the Potts model, we define the upper and the lower discrete envelopes of Γ_{FK} :

$$\begin{aligned} \Gamma_{\text{FK}}^{+,n}(k) &:= \max\{y \in \mathbb{Z} : (k \pm \frac{1}{2}, y - \frac{1}{2}) \overset{\omega^*}{\longleftrightarrow} (\{\mathbb{Z} + \frac{1}{2}\} \times \{\mathbb{Z}_{<0} + \frac{1}{2}\}) \setminus \Lambda_n^*\}, \\ \Gamma_{\text{FK}}^{-,n}(k) &:= \min\{y \in \mathbb{Z} : (k, y + 1) \overset{\omega}{\longleftrightarrow} (\mathbb{Z} \times \mathbb{Z}_{\geq 0}) \setminus \Lambda_n\}, \end{aligned}$$

where $\Lambda_n^* := [-n, n]^2 \cap (\mathbb{Z}^2)^*$. The rescaled linear interpolations $\tilde{\Gamma}_{\text{FK}}^{\pm, n}$ of $\Gamma_{\text{FK}}^{\pm, n}$ are defined in the same way as in the Potts model. Our main result for the FK percolation is an invariance principle for $\tilde{\Gamma}_{\text{FK}}^{\pm, n}$:

Theorem 2. *Let $q > 4$ be a real number and take $p = p_c(q)$. For $n \in \mathbb{N}$, sample $\Gamma_{\text{FK}}^{\pm, n}$ and $\tilde{\Gamma}_{\text{FK}}^{\pm, n}$ from $\text{FK}_{G_n; p_c(q), q}^{1/0}$ as described above. Then, as n tends to infinity, the convergence results from Theorem 1 hold for $\Gamma_{\text{FK}}^{\pm, n}$ and $\tilde{\Gamma}_{\text{FK}}^{\pm, n}$ in place of $\Gamma_{\text{Potts}}^{\pm, n}$ and $\tilde{\Gamma}_{\text{Potts}}^{\pm, n}$.*

We draw attention to the precision of our control of the interface. Previously, at $p_c(q)$ when $q > 4$ (discontinuous transition), it remained open that Γ_{FK}^n does not exhibit linear fluctuations. Our results imply that this is indeed the case and, moreover, the probability that Γ_{FK}^n exhibits linear fluctuations is in fact exponentially small. This should be compared to the behavior of Γ_{FK}^n at $p_c(q)$ when $q \in [1, 4]$ (continuous transition): there it does exhibit linear fluctuations [DST17].

Our proof goes via developing a random walk representation for long clusters in the Ashkin–Teller model. We proceed by introducing the latter model and stating our results for it.

1.3. Ashkin–Teller model. Introduced in 1943 [AT43] as a generalization of the Ising model to a four-component system, the Ashkin–Teller (AT) model can be viewed as a pair of interacting Ising models. Take a finite subgraph $G = (V, E)$ of \mathbb{Z}^2 , parameters $J, U > 0$ and boundary conditions $\sigma, \sigma' \in \{0, \pm 1\}^{\mathbb{Z}^2}$. The AT model on G with parameters $J, U \in \mathbb{R}$ and boundary conditions (σ, σ') is a probability measures on pairs $\tau, \tau' \in \{\pm 1\}^V$ given by

$$\begin{aligned} \text{AT}_{G,J,U}^{\sigma,\sigma'}(\tau, \tau') = \frac{1}{Z_{\text{AT}}} \cdot \exp \left[\sum_{\{i,j\} \in E} J(\tau_i \tau_j + \tau'_i \tau'_j) + U \tau_i \tau_j \tau'_i \tau'_j \right. \\ \left. + \sum_{i \in V, j \in V^c: i \sim j} J(\tau_i \sigma_j + \tau'_i \sigma'_j) + U \tau_i \sigma_j \tau'_i \sigma'_j \right] \end{aligned}$$

where $Z_{\text{AT}} = Z_{\text{AT}}(G, J, U, \sigma, \sigma')$ is the partition function. Taking $\sigma = \sigma' \equiv 1$ we obtain plus-plus boundary conditions and taking $\sigma = \sigma' \equiv 0$ we obtain free-free boundary conditions; we denote the corresponding measures by $\text{AT}_{G,J,U}^{+,+}$ and $\text{AT}_{G,J,U}^{\text{f,f}}$ respectively.

We consider only $J > 0$, since flipping the sign of J corresponds to flipping the sign of τ' and τ at one of the two partite classes of \mathbb{Z}^2 . Using the Ising-duality for τ' and then for τ , the *self-dual curve* of the parameters was identified [MS71]:

$$\sinh 2J = e^{-2U}. \quad (2)$$

A classical GKS inequality [KS68] implies that the correlations are monotone along the lines of a constant ratio J/U . The case $U = 0$ gives two independent Ising models and the line $J = U$ is in direct correspondence with the four-state Potts model and the FK percolation with the cluster-weight $q = 4$. In addition, the three models are related on the self-dual line (2), with $q > 4$ corresponding to $U > J$. A precise coupling was constructed in [GP23] via the six-vertex (square ice) model based on the works of Fan [Fan72a] and Wegner [Weg72] and on the seminal Baxter–Kelland–Wu (BKW) correspondence [BKW76]; see also [HDJS13]. This coupling is crucial to the current work and is described in detail in Sections 4.2 and 5.1.4.

When $U > J > 0$, correlation inequalities [KS68] guarantee the existence of the infinite-volume limits $\text{AT}_{J,U}^{\text{f,f}}$ and $\text{AT}_{J,U}^{+,+}$ of the free and monochromatic AT measures $\text{AT}_{G_n,J,U}^{\text{f,f}}$ and $\text{AT}_{G_n,J,U}^{+,+}$, respectively, as $G_n \nearrow \mathbb{Z}^2$. Our first result states that their marginals on the single spin τ coincide.

Proposition 1.1. *Let $0 < J < U$ satisfy $\sinh 2J = e^{-2U}$. Then, the measures $\text{AT}_{J,U}^{\text{f,f}}$ and $\text{AT}_{J,U}^{+,+}$ have the same marginal distribution on τ .*

Denote the expectation operators with respect to $\text{AT}_{J,U}^{\text{f,f}}$ and $\text{AT}_{J,U}^{+,+}$ by $\langle \cdot \rangle_{J,U}^{\text{f,f}}$ and $\langle \cdot \rangle_{J,U}^{+,+}$, respectively, and define the inverse correlation length $\nu_{J,U}$ by setting, for $x \in \mathbb{R}^2$,

$$\nu_{J,U}(x) := - \lim_{n \rightarrow \infty} \frac{1}{n} \ln \langle \tau_0 \tau_{\lfloor nx \rfloor} \rangle_{J,U}^{\text{f,f}} = - \lim_{n \rightarrow \infty} \frac{1}{n} \ln \langle \tau_0 \tau_{\lfloor nx \rfloor} \rangle_{J,U}^{+,+},$$

where $\lfloor \cdot \rfloor$ is the componentwise integer part. The existence of the limit is derived in a standard manner from correlation inequalities and a subadditive argument (see Section 7 for more details and references). In [ADG24], it was shown that $\text{AT}_{\Lambda_n}^{+,+}$ admits exponential decay of correlations in τ , which implies that $\nu > 0$. The following theorem establishes sharp Ornstein–Zernike-type asymptotics for the 2-point function.

Theorem 3. *Let $0 < J < U$ satisfy $\sinh 2J = e^{-2U}$. The inverse correlation length $\nu_{J,U}$ is a norm on \mathbb{R}^2 . Furthermore, uniformly in $|x| \rightarrow \infty$,*

$$\langle \tau_0 \tau_x \rangle_{J,U}^{\text{f,f}} = \langle \tau_0 \tau_x \rangle_{J,U}^{+,+} = \frac{g(x/|x|)}{\sqrt{|x|}} e^{-\nu(x)} (1 + o(1)),$$

where $\nu = \nu_{J,U}$, and $g = g_{J,U}$ is a strictly positive analytic function on \mathbb{S}^1 .

1.4. Six-vertex model. The six-vertex model [Pau35, Rys63] is a model of *edge orientations* on a square lattice, which in the setting of this article is taken to be the medial graph of \mathbb{Z}^2 . While it serves merely as an intermediate step and a tool in the derivation of our main results, Theorems 1-3, we also obtain some results on the six-vertex model along the way, which we will *informally* describe in this subsection. We refer to Sections 4.1 and 5.1 for precise definitions.

The six-vertex model admits a representation in terms of *height functions*. In the above setting, these are assignments of integers to the vertices of both \mathbb{Z}^2 and $(\mathbb{Z}^2)^*$, satisfying the following property. A six-vertex height function $h : \mathbb{Z}^2 \cup (\mathbb{Z}^2)^* \rightarrow \mathbb{Z}$ takes even values on \mathbb{Z}^2 and, for all $i \in \mathbb{Z}^2$ and $u \in (\mathbb{Z}^2)^*$ at a Euclidean distance of $1/\sqrt{2}$, it holds that $|h(i) - h(u)| = 1$. An edge $e = \{i, j\} \in \mathbb{E}$ (or its associated tile) with dual $e^* = \{u, v\}$ is said to be of type 5-6 if both $h(i) = h(j)$ and $h(u) = h(v)$, and otherwise of type 1-4. Given a finite set $E \subset \mathbb{E}$ and a parameter $\mathbf{c} > 0$, each height function is assigned a weight given by

$$w_{E;\mathbf{c}}(h) := \mathbf{c}^{|\{e \in E \text{ of type 5-6}\}|}.$$

Through the introduction of boundary conditions, measures on the set of height functions are defined by a proportionality relation to the above weight. When $1 \leq \mathbf{c} \leq 2$, the height function under constant boundary condition is known to *delocalise* [DCKMO24] (see also [Lis21, GL23]) as the system exhausts the whole lattice, whereas it was shown to *localise* [DGH⁺21, GP23] when $\mathbf{c} > 2$.

In relation to the Potts and FK measures under Dobrushin boundary conditions, we consider six-vertex height function measures with parameter $\mathbf{c} > 2$ on square domains and with the following Dobrushin boundary condition (see Fig. 4): $+1$ on $(\mathbb{Z}^2)^*$ in the upper half-plane, -1 on $(\mathbb{Z}^2)^*$ in the lower half-plane, and constant 0 on \mathbb{Z}^2 . In analogy to Theorems 1-2, we derive the convergence under these height function measures of the Peierls contour between $+1$ and -1 in the odd heights under diffusive scaling. We prove this statement for measures with a modified parameter \mathbf{c}_b on the boundary, as they can be coupled with the FK and Potts measures, which allows us to transfer the result to the latter and derive Theorems 1-2. However, it should be noted that this boundary weight in fact complicates the analysis in the related AT model. The derivation of the statement for the measures without the modified boundary weight is simpler and can be undertaken using the same method.

It is also noteworthy that we establish exponential relaxation results for the height function measures with constant boundary conditions and potentially inhomogeneous weights \mathbf{c} and \mathbf{c}_b at the boundary (see Section 5.2).

1.5. Summary of the paper: what is new? The main novelty of our work is to study the FK percolation and the Potts models via the graphical (or random-cluster) representation of the Ashkin–Teller model (ATRC model) introduced in [PV97]. At a first glance, the FK percolation model has been by now much better understood, see the classical book [Gri06] and more recent lecture notes [DC17]. Moreover, the FK model has been used to establish some basic properties for the ATRC model [GP23, ADG24]. However, compared to the FK percolation at its transition point when $q > 4$,

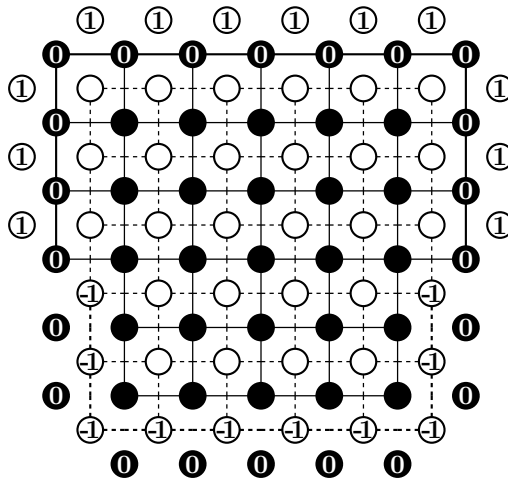

FIGURE 4. Dobrushin boundary condition for the six-vertex height function.

the ATRC model at its self-dual line when $U > J$ remarkably exhibits a unique Gibbs measure. This brings more symmetries that play a key role in the study of interfaces.

This comes at some cost: the ATRC model is supported on *pairs* of edge configurations. Thus, the domain Markov property is significantly weaker than in the FK percolation defined on a single edge configuration. In particular, it is highly non-trivial to prove mixing properties of the ATRC model. For this we use a coupling of the ATRC model to the six-vertex model, whose height function enjoys additional monotonicity properties. Using the classical work of Alexander [Ale98] and a new general mixing result [Ott25], we prove, for the regime of parameters considered in the rest of the work, that the ATRC model satisfies

- the exponential ratio weak mixing property (Theorem 4),
- a restricted version of the exponential strong mixing property (Theorem 8).

These mixing properties allow us to extend the arguments of [CIV03, CIV08, OV18, AOV24] to the ATRC model and provide a renewal picture for the long subcritical ATRC clusters in infinite volume (Theorem 9).

Regarding the link with interfaces in FK/Potts, we point out a technical issue that the FK percolation model under standard Dobrushin boundary conditions is directly coupled only to the ATRC with rather involved “boundary conditions” (modified cluster weight on the boundary, we call it a modified ATRC model). Fortunately, this model still satisfies the FKG lattice condition which allows for comparison with normal ATRC measures. Using this, we are able to transfer the results derived for the infinite volume ATRC to the modified, finite volume, measures. This is the content of Section 8.

Organisation of the article. We now provide the structure of the paper.

Section 2: notation and conventions that will be used throughout the article.

Section 3: definition of the ATRC model, its basic properties and statement of the results that we establish for this model, including the uniqueness of the ATRC Gibbs measure and mixing properties.

Section 4: coupling between the FK percolation and modified ATRC models. The coupling is very sensitive to boundary conditions, eg. note appearance of a different boundary-cluster weight in [GP23]. We extend this coupling to standard Dobrushin boundary conditions in the FK percolation at a price of rather inconvenient conditions

in the ATRC model. In particular, we obtain a coupling between the FK interface and a crossing cluster under a modified version of a finite volume ATRC measure.

Section 5: proof of new weak mixing properties (Theorem 4) for the ATRC model and, in particular, uniqueness of the ATRC Gibbs measure. We adapt the classical works of Alexander [Ale92, Ale98, Ale04] and use the recent works on the ATRC model [GP23, ADG24].

Section 6: derivation of a restricted version of strong mixing (Theorem 8) from the weak mixing of Section 5, using a general argument from [Ott25].

Section 7: development of the ‘‘OZ theory’’ (renewal picture) for long subcritical cluster in the ATRC model, in infinite volume, following [CIV08, AOV24], and using the mixing established in Sections 5 and 6. More precisely, we show that the typical geometry of clusters conditioned on containing two distant points is the same as the one of a directed random walk bridge between these points (Theorem 9).

Section 8: using stochastic comparison and mixing properties, we couple the ‘‘crossing cluster’’ under the finite volume measures of Section 4.2 with an infinite volume long cluster as studied in Section 7 (Theorem 11). From there, an invariance principle follows by importing the results of [Kov04].

Section 9: wrap up of the proofs of Theorems 1, 2, 3, and 6.

Acknowledgements We want to say big thanks to Ioan Manolescu for frequent discussions that started already in 2019-20 and for pointing out that it is enough to work with tall rectangles. Parts of the work were accomplished during the visits of some of us to the Universities of Fribourg, Geneva, Innsbruck and Vienna and at the NCCR SwissMAP research station in Les Diablerets. We want to thank these institutions and all people involved for their hospitality and creating excellent working conditions. This research was partially funded by the Austrian Science Fund (FWF) 10.55776/P34713.

2. NOTATIONS AND CONVENTIONS

General graphs. Let $\mathbb{G} = (\mathbb{V}, \mathbb{E})$ be a graph. We simply write $xy = \{x, y\}$ for an edge $\{x, y\} \in \mathbb{E}$. Given finite subsets $\Lambda \subset \mathbb{V}$ and $E \subset \mathbb{E}$, define

$$\begin{aligned} \mathbb{E}_\Lambda &:= \{e \in \mathbb{E} : e \subset \Lambda\}, & \mathbb{V}_E &:= \bigcup_{e \in E} e, \\ \partial^{\text{in}} \Lambda &:= \{x \in \Lambda : \exists y \in \mathbb{V} \setminus \Lambda, xy \in \mathbb{E}\}, & \partial^{\text{ex}} \Lambda &:= \{y \in \mathbb{V} \setminus \Lambda : \exists x \in \Lambda, xy \in \mathbb{E}\}, \\ \partial^{\text{in}} E &:= \{e \in E : \exists f \in \mathbb{E} \setminus E, e \cap f \neq \emptyset\}, & \partial^{\text{ex}} E &:= \{e \in \mathbb{E} \setminus E : \exists f \in E, e \cap f \neq \emptyset\}, \\ \partial^{\text{edge}} \Lambda &:= \{xy \in \mathbb{E} : x \in \Lambda, y \in \mathbb{V} \setminus \Lambda\}. \end{aligned}$$

In case of ambiguity, we add \mathbb{G} as a subscript (and write, for example, $\partial_{\mathbb{G}}^{\text{in}} \Lambda$) to emphasise that the boundary is taken in \mathbb{G} . The *interior* of Λ (in \mathbb{G}) is given by $\Lambda \setminus \partial^{\text{in}} \Lambda$. The subgraph *induced* by $\Lambda \subset \mathbb{V}$ is given by $(\Lambda, \mathbb{E}_\Lambda)$, and the subgraph induced by $E \subset \mathbb{E}$ is given by (\mathbb{V}_E, E) .

Lattices. We will mainly work on \mathbb{Z}^2 with nearest-neighbour edges, and on its dual. We will denote the *primal lattice* by $\mathbb{L}_\bullet = \mathbb{Z}^2$ and its *dual* by $\mathbb{L}_\circ = (1/2, 1/2) + \mathbb{Z}^2$. Denote by \mathbb{E}^\bullet the nearest-neighbour edges between sites in \mathbb{L}_\bullet (primal edges), by \mathbb{E}° the nearest-neighbour edges between sites in \mathbb{L}_\circ (dual edges).

Duality. Each edge $e \in \mathbb{E}^\bullet$ intersects a unique edge of \mathbb{E}° , we denote it by e^* . For a set of primal (or dual) edges E , define $*E = \{e^* : e \in E\}$. We say that $E \subset \mathbb{E}^\bullet$ is *simply lattice-connected* if both the subgraphs induced by E and by $*(\mathbb{E}^\bullet \setminus E)$ are

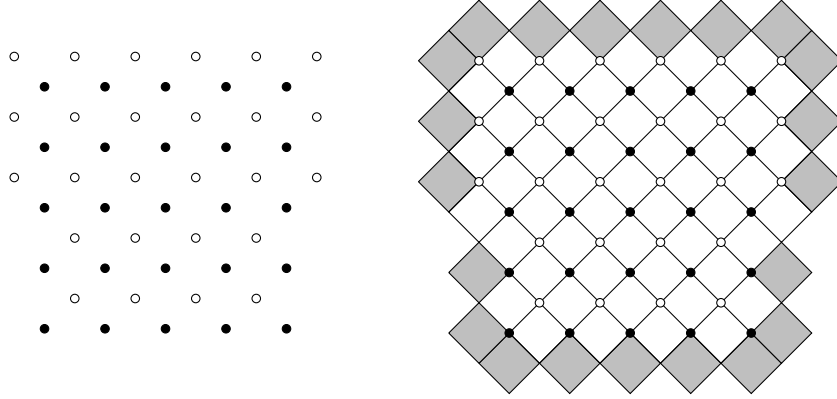

FIGURE 5. Left: the sets $\Lambda_{2,2}$ (solid) and $\Lambda'_{2,2}$ (hollow). Right: the inner tiles $A_{2,2}^i$ (white) and the boundary tiles $\partial A_{2,2}$ (grey).

connected. As a convention, sets of edges or of dual edges will be identified with the corresponding sets of mid-points whenever the meaning is clear from the context.

Tiles. To each primal-dual pair of edges e, e^* , associate a *tile* t given by the convex hull of their endpoints and define $e_t := e$; see Fig. 3. Define \mathbb{L}_\diamond as the set of all tiles, and let \mathbb{E}^\diamond be the set of all pairs of adjacent tiles. Note that $(\mathbb{L}_\diamond, \mathbb{E}^\diamond)$ is the medial graph of $(\mathbb{L}_\bullet, \mathbb{E}^\bullet)$, since tiles can be identified with midpoints of edges in \mathbb{E}^\bullet .

Standard rectangular domains. Define the upper and lower half planes by

$$\mathbb{H}^+ := \mathbb{R} \times \mathbb{R}_{\geq 0}, \quad \mathbb{H}^- := \mathbb{R} \times \mathbb{R}_{< 0},$$

and, for $n, m \geq 0$, set (see Fig. 5)

$$\begin{aligned} \Lambda_{n,m} &:= \{-n, \dots, n\} \times \{-m, \dots, m\}, \\ \Lambda'_{n,m} &:= \left(([-n-1, n+1] \times [0, m+1]) \cup ([-n, n] \times [-m, 0]) \right) \cap \mathbb{L}_\diamond. \end{aligned}$$

Define $\mathcal{D}_{n,m} := \Lambda_{n,m} \cup \Lambda'_{n,m}$ and the graph $G_{n,m} = (V_{n,m}, E_{n,m})$ by (see Fig. 2)

$$V_{n,m} = \Lambda_{n,m} \cup (\partial^{\text{ex}} \Lambda_{n,m} \cap \mathbb{H}^+), \quad E_{n,m} = \mathbb{E}_{V_{n,m}} \setminus \mathbb{E}_{\mathbb{L}_\bullet \setminus \Lambda_{n,m}}.$$

Let $A_{n,m} \subset \mathbb{L}_\diamond$ be the set of tiles with at least one corner in $\mathcal{D}_{n,m}$ and $\partial A_{n,m} \subset A_{n,m}$ (boundary tiles) be the set of tiles with precisely one corner in \mathcal{D} ; see Fig. 5. Define also $\partial^+ A = \{t \in \partial A : t \subseteq \mathbb{H}^+\}$, $\partial^- A = \partial A \setminus \partial^+ A$ and $A_{n,m}^i := A_{n,m} \setminus \partial A_{n,m}$.

Define also (see Fig. 6 and 9)

$$v_L(n) := (-n-1, 0), \quad v_R(n) := (n+1, 0).$$

Augmented rectangular domains. We also introduce $E_{n,m}$ augmented by some *upper* boundary edges. First, define the set of boundary edges and its upper and lower parts by

$$E_{b,n,m} := \{e_t : t \in \partial A_{n,m}\} \quad \text{and} \quad E_{b,n,m}^\pm = \{e_t : t \in \partial^\pm A_{n,m}\}.$$

Then define the augmented sets of edges and vertices by

$$\bar{E}_{n,m} = E_{n,m} \cup E_{b,n,m}^+ \quad \text{and} \quad \bar{V}_{n,m} = \mathbb{V}_{\bar{E}_{n,m}}.$$

We now define the augmented domain and its dual (see Fig. 6):

- Set $K_{n,m} := (\bar{V}_{n,m}, \bar{E}_{n,m})$,

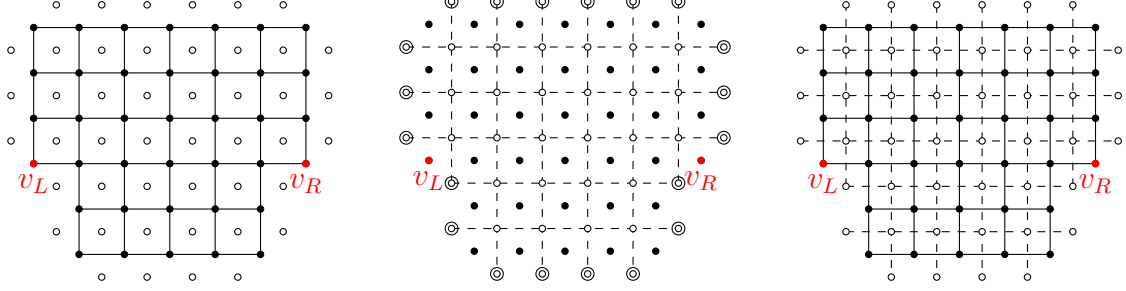

FIGURE 6. Left: the graph $K_{2,2}$. Center: the graph $K_{2,2}^*$ (vertices surrounded by a circle are identified). Right: planar duality relation between their edges.

- and let $K_{n,m}^*$ be the graph obtained from $(\mathbb{V}_{*\bar{E}_{n,m}}, *\bar{E}_{n,m})$ by identifying the vertices in $\partial_{\mathbb{L}_\circ}^{\text{in}} \mathbb{V}_{*\bar{E}_{n,m}}$.

Connectivity events. Given $\Lambda, \Delta \subset \mathbb{L}_\bullet$ and a percolation configuration $\omega \in \{0, 1\}^{\mathbb{E}^\bullet}$, we write $\Lambda \xleftrightarrow{\omega} \Delta$ for the event that Λ and Δ are connected by a path in the graph $(\mathbb{L}_\bullet, \omega)$. If $\Lambda = \{i\}$ and $\Delta = \{j\}$, we simply write $i \xleftrightarrow{\omega} j$. We omit ω from the notation when it cannot lead to any confusion.

Agreements of spins along edges. For an edge $e = ij \in \mathbb{E}^\bullet$ and a spin configuration $\sigma_\bullet \in \{+1, -1\}^{\mathbb{L}^\bullet}$, we write $\sigma_\bullet \sim e$ if $\sigma_\bullet(i) = \sigma_\bullet(j)$; for $\xi \subset \mathbb{E}^\bullet$, we write $\sigma_\bullet \sim \xi$ if $\sigma_\bullet \sim e$ for every $e \in \xi$ (in other words, σ_\bullet is constant on clusters of ξ). We use similar notation for edges in \mathbb{E}° and $\sigma_\circ \in \{+1, -1\}^{\mathbb{L}^\circ}$.

Parameters. The couplings go through standard “expansion–resummation” of Boltzmann weights combined with extensive use of planarity. As for each step one will write the weight associated with a given model as a sum of weights for a “more expanded” model, several parameters will come into play. Below we list the parameters, as well as the algebraic relations linking them:

$$\begin{aligned} q > 4, \quad \beta = \beta_c(q) = \ln(1 + \sqrt{q}), \quad \lambda > 0, \quad \mathbf{c} > 2, \quad U > J > 0, \\ \sqrt{q} = e^\lambda + e^{-\lambda}, \quad \mathbf{c} = e^{\lambda/2} + e^{-\lambda/2} = \coth(2J), \\ \sinh(2J) = e^{-2U}. \end{aligned} \tag{3}$$

The parameter \mathbf{c} also has a “boundary version”:

$$\mathbf{c}_b = e^{\lambda/2} > 1. \tag{4}$$

For the remainder of the article, we fix $q > 4$, along with the corresponding parameters above (which are uniquely determined by q).

Constants. Constants like $c, c_1, C, C_1, C', \dots$ are constants which can change from line to line and which can depend on the parameters unless explicitly stated. They are independent of the system size, n , which will be our main “variable” quantity.

3. ASHKIN–TELLER RANDOM-CLUSTER MODEL

Like the Potts models, the AT model has a random-cluster (RC) representation, called the *ATRC model*, and introduced in [CM97, PV97]. We will first introduce the model and state some of its basic properties. This will be followed by the statement of our results.

3.1. Definition and basic properties. Let $\mathbb{G} = (\mathbb{V}, \mathbb{E})$ be a graph, and let $G = (V, E)$ be a finite subgraph of \mathbb{G} . Let $\eta_\tau, \eta_{\tau'} \in \{0, 1\}^{\mathbb{E}}$ with $\eta_\tau \subseteq \eta_{\tau'}$. The ATRC model on G with parameters $U > J > 0$ under boundary conditions $(\eta_\tau, \eta_{\tau'})$ is the probability measure on $\{0, 1\}^{\mathbb{E}} \times \{0, 1\}^{\mathbb{E}}$ given by

$$\text{ATRC}_{G;J,U}^{\eta_\tau, \eta_{\tau'}}(\omega_\tau, \omega_{\tau'}) = \frac{1}{Z} \cdot \mathbb{1}_{\omega_\tau \subseteq \omega_{\tau'}} \cdot w_\tau^{|\omega_\tau \cap E|} w_{\tau'}^{|(\omega_{\tau'} \setminus \omega_\tau) \cap E|} 2^{\kappa_V(\omega_\tau) + \kappa_V(\omega_{\tau'})} \cdot \prod_{e \in \mathbb{E} \setminus E} \mathbb{1}_{\omega_\tau(e) = \eta_\tau(e)} \mathbb{1}_{\omega_{\tau'}(e) = \eta_{\tau'}(e)}, \quad (5)$$

where $Z = Z_{\text{ATRC}}^{\eta_\tau, \eta_{\tau'}}(G, J, U)$ is the partition function, $\kappa_V(\cdot)$ is the number of clusters that intersect V , and the weights are given by

$$w_\tau = e^{2U}(e^{2J} - e^{-2J}) \quad \text{and} \quad w_{\tau'} = e^{2(U-J)} - 1. \quad (6)$$

When $\eta_\tau \equiv 0$ (resp. $\eta_\tau \equiv 1$), we write 0 (resp. 1) instead of η_τ in the superscript, and analogously for $\eta_{\tau'}$. Given finite subsets $\Lambda \subset \mathbb{V}$ and $E \subset \mathbb{E}$, we write $\text{ATRC}_{\Lambda;J,U}^{\eta_\tau, \eta_{\tau'}}$ and $\text{ATRC}_{E;J,U}^{\eta_\tau, \eta_{\tau'}}$ for the measures on the graphs $(\Lambda, \mathbb{E}_\Lambda)$ and (\mathbb{V}_E, E) , respectively.

Finite energy. There exists a constant $c = c(J, U) > 0$ such that the following holds. For any finite subgraph $G = (V, E)$, any $e \in E$ and any $a, b \in \{0, 1\}^E$ with $a \subseteq b$

$$\text{ATRC}_{G;J,U}^{\eta_\tau, \eta_{\tau'}}((\omega_\tau(e), \omega_{\tau'}(e)) = (a_e, b_e) \mid (\omega_\tau, \omega_{\tau'}) = (a, b) \text{ on } E \setminus \{e\}) > c. \quad (\text{FE})$$

“DLR” property. Given a subgraph $G' = (V', E')$ of G and boundary conditions $\eta_\tau, \eta_{\tau'}, \eta'_\tau, \eta'_{\tau'}$ with $\eta_\tau = \eta'_\tau$ on $\mathbb{E} \setminus E'$ and $\eta_{\tau'} = \eta'_{\tau'}$ on $\mathbb{E} \setminus E'$,

$$\text{ATRC}_{G;J,U}^{\eta_\tau, \eta_{\tau'}}(\cdot \mid (\omega_\tau, \omega_{\tau'}) = (\eta'_\tau, \eta'_{\tau'}) \text{ on } \mathbb{E} \setminus E') = \text{ATRC}_{G';J,U}^{\eta'_\tau, \eta'_{\tau'}}(\cdot). \quad (\text{DLR})$$

Stochastic domination and positive association. We first introduce these notions in a general setting. Given a partially ordered set \mathcal{S} (states) and some index set I (eg. a set of edges or vertices), consider \mathcal{S}^I : the set of functions from I to \mathcal{S} , i.e. configurations on I with values in \mathcal{S} . A subset $A \subseteq \mathcal{S}^I$ is called *increasing* if $\mathbb{1}_A$ is increasing with respect to the pointwise order. Given a σ -algebra \mathcal{A} on \mathcal{S}^I and two probability measures μ and ν on \mathcal{A} , we say that ν stochastically dominates μ , and write $\mu \leq_{\text{st}} \nu$ (or $\nu \geq_{\text{st}} \mu$) if $\mu(A) \leq \nu(A)$ for any increasing event $A \in \mathcal{A}$. We say that μ is *positively associated* or satisfies the *FKG property* (named after the seminal work of Fortuin, Kasteleyn and Ginibre [FKG71]) if, for all increasing events $A, B \in \mathcal{A}$, we have

$$\mu(A \cap B) \geq \mu(A)\mu(B). \quad (\text{FKG})$$

If I is finite and $\mu(\omega) > 0$ for any $\omega \in \mathcal{S}^I$, we say that μ satisfies the *strong FKG property* if

$$\forall J \subset I \forall \omega_1 \leq \omega_2: \quad \mu(\cdot \mid \omega = \omega_1 \text{ on } J) \leq_{\text{st}} \mu(\cdot \mid \omega = \omega_2 \text{ on } J), \quad (\text{strong-FKG})$$

where we wrote $\omega = \omega_i$ on J for the event that $\omega(j) = \omega_i(j)$ for all $j \in J$. We note that this is equivalent to the *FKG lattice condition*; see [Gri06, Section 2] and [GHM01, Section 4] for the background.

In order to incorporate $\text{ATRC}_{G;J,U}^{\eta_\tau, \eta_{\tau'}}$ into this general framework, note that this is a positive measure on $\{(0, 0), (0, 1), (1, 1)\}^E$. Indeed, ω_τ and $\omega_{\tau'}$ that coincide respectively with η_τ and $\eta_{\tau'}$ on $\mathbb{E} \setminus E$ can be viewed as elements of $\{0, 1\}^E$, and moreover $\omega_\tau(e) \leq \omega_{\tau'}(e)$ for every $e \in E$ by (5).

Lemma 3.1 ([PV97]). *For any $U > J > 0$, any subgraph $G = (V, E)$ of \mathbb{G} and all boundary conditions $\eta_\tau, \eta_{\tau'}$, the measure $\text{ATRC}_{G;J,U}^{\eta_\tau, \eta_{\tau'}}$ satisfies the strong FKG property.*

This is an easy consequence of [PV97, Proposition 4.1] and its proof.

By Lemma 3.1 and (DLR), for any increasing sequence of subgraphs $G_k \nearrow \mathbb{G}$, the measures $\text{ATRC}_{G_k;J,U}^{1,1}$ form a decreasing sequence in the sense of stochastic domination. Consequently, the weak limit exists and is independent of (G_k) . We denote it by $\text{ATRC}_{J,U}^{1,1}$. Analogously, we define $\text{ATRC}_{J,U}^{0,0}$ as the (increasing) limit of $\text{ATRC}_{G_k;J,U}^{0,0}$.

Furthermore, Lemma 3.1 and (DLR) can be used to compare different boundary conditions: if $U > J > 0$, $\eta_\tau \leq \eta'_\tau$ and $\eta_{\tau\tau'} \leq \eta'_{\tau\tau'}$, then

$$\text{ATRC}_{G;J,U}^{\eta_\tau, \eta_{\tau\tau'}} \leq_{\text{st}} \text{ATRC}_{G;J,U}^{\eta'_\tau, \eta'_{\tau\tau'}}. \quad (\text{CBC})$$

FK-type relations on the square lattice. Recall the infinite-volume AT expectation operators $\langle \cdot \rangle^{\text{f},\text{f}}$ and $\langle \cdot \rangle^{+,+}$ defined in Section 1.3 and the notation $\overset{\omega}{\longleftrightarrow}$ for a connectivity event introduced in Section 2. The essential feature of the ATRC is that its connection probabilities are related to the correlations in the AT model [PV97, Proposition 3.1]: for $U > J > 0$ and any $i, j \in \mathbb{L}_\bullet$,

$$\langle \tau_i \tau_j \rangle^{+,+} = \text{ATRC}_{J,U}^{1,1}(i \overset{\omega_\tau}{\longleftrightarrow} j), \quad \langle \tau_i \tau'_i \tau_j \tau'_j \rangle^{+,+} = \text{ATRC}_{J,U}^{1,1}(i \overset{\omega_{\tau\tau'}}{\longleftrightarrow} j). \quad (7)$$

The analogous relations for $\langle \cdot \rangle^{\text{f},\text{f}}$ and $\text{ATRC}_{J,U}^{0,0}$ are also valid.

Duality on the square lattice. Recall the primal and dual square lattices $(\mathbb{L}_\bullet, \mathbb{E}^\bullet)$ and $(\mathbb{L}_\circ, \mathbb{E}^\circ)$ (Section 2) and the notion of a dual percolation configuration $\eta^* \in \{0, 1\}^{\mathbb{E}^\circ}$ for each $\eta \in \{0, 1\}^{\mathbb{E}^\bullet}$ (Section 1). Choose J, U as in (3). Then, for any finite $E \subset \mathbb{E}^\bullet$ and any $\eta_\tau, \eta_{\tau\tau'} \in \{0, 1\}^{\mathbb{E}^\bullet}$, by [PV97, Proposition 3.2],

$$(\omega_\tau, \omega_{\tau\tau'}) \sim \text{ATRC}_{E;J,U}^{\eta_\tau, \eta_{\tau\tau'}} \quad \text{implies} \quad (\omega_{\tau\tau'}^*, \omega_\tau^*) \sim \text{ATRC}_{*E;J,U}^{\eta_{\tau\tau'}^*, \eta_\tau^*}. \quad (8)$$

Notice the different order in the dual pair.

3.2. Results on the ATRC. In this section, we present our main results concerning the self-dual ATRC model on the square lattice \mathbb{L}_\bullet .

Mixing properties. We establish exponential relaxation for the single edges, which together with (strong-FKG) implies *exponential weak mixing* (see Section 5).

Proposition 3.2. *Let $0 < J < U$ satisfy $\sinh 2J = e^{-2U}$. There exists $c > 0$ such that, for any edge $e \in \mathbb{E}^\bullet$ with $0 \in e$, and any $n \geq 1$,*

$$\max_{\sigma \in \{\tau, \tau\tau'\}} \left| \text{ATRC}_{\Lambda_n;J,U}^{1,1}(\omega_\sigma(e) = 1) - \text{ATRC}_{\Lambda_n;J,U}^{0,0}(\omega_\sigma(e) = 1) \right| \leq e^{-cn}.$$

As a consequence, the measures $\text{ATRC}_{G;J,U}^{\eta_\tau, \eta_{\tau\tau'}}$ converge (as $G \nearrow \mathbb{L}_\bullet$) to a limit measure $\text{ATRC}_{J,U}$, which is independent of the choice of boundary conditions $\eta_\tau, \eta_{\tau\tau'}$. Furthermore, the limit $\text{ATRC}_{J,U}$ is the unique ATRC Gibbs measure. Moreover, applying the classical work of Alexander [Ale98], we derive *ratio weak mixing*.

Theorem 4. *Let $0 < J < U$ satisfy $\sinh 2J = e^{-2U}$. There exist $C \geq 0, c > 0$ such that, for any finite subgraph $G = (V, E)$ of \mathbb{L}_\bullet , any $F \subset E$, and any F -measurable event A having positive probability,*

$$\sup_{\eta_\tau, \eta_{\tau\tau'}, \eta'_\tau, \eta'_{\tau\tau'}} \left| \frac{\text{ATRC}_{G;J,U}^{\eta_\tau, \eta_{\tau\tau'}}(A)}{\text{ATRC}_{G;J,U}^{\eta'_\tau, \eta'_{\tau\tau'}}(A)} - 1 \right| \leq C \sum_{f \in F} \sum_{e \in E^c} e^{-c d_\infty(e, f)},$$

whenever the right side is strictly less than 1.

The notion of ATRC Gibbs measures can be defined in an analogous way to the FK model; see [Gri06, Chapter 4.4]. The following is a direct consequence of Theorem 4.

Corollary 3.3. *Let $0 < J < U$ satisfy $\sinh 2J = e^{-2U}$. It holds that*

$$\text{ATRC}_{J,U}^{0,0} = \text{ATRC}_{J,U}^{1,1} =: \text{ATRC}_{J,U}.$$

In particular, $\text{ATRC}_{J,U}$ is the unique ATRC Gibbs measure, and for any choice of boundary conditions $\eta_\tau, \eta_{\tau'}$, the measures $\text{ATRC}_{G;J,U}^{\eta_\tau, \eta_{\tau'}}$ converge to $\text{ATRC}_{J,U}$ as $G \nearrow \mathbb{L}_\bullet$.

We refer to Section 6, for our results on *strong* mixing properties of the ATRC.

Uniform exponential decay. In Section 5, we prove exponential weak mixing (Theorem 7). It allows to apply the work of Alexander [Ale04] to derive the following uniform decay of connection probabilities:

Theorem 5. *Let $0 < J < U$ satisfy $\sinh 2J = e^{-2U}$. There exists a constant $c > 0$ such that, for any finite simply lattice-connected $E \subset \mathbb{E}^\bullet$, and any $i, j \in \mathbb{V}_E$,*

$$\text{ATRC}_{E;J,U}^{1,1}(i \xleftrightarrow{\omega_\tau \cap E} j) \leq e^{-c d_\infty(i,j)},$$

where d_∞ is the distance induced by the L^∞ norm.

Proof. It is enough to check the conditions stated in [Ale04, Theorem 1.1]: the push-forward of $\text{ATRC}_{J,U}$ by ω_τ is translation invariant, has finite-energy for closing edges, exponential decay of connectivity probabilities [ADG24, Proposition 1.1], and is exponentially weak mixing by Theorem 7. Finally, for n with $E \subseteq \mathbb{E}_{\Lambda_{n-1}}$, we have by (DLR) that

$$\text{ATRC}_{J,U}(\omega_\tau \in \cdot \mid \omega_\tau(e) = 1 \text{ for } e \in \mathbb{E}_{\Lambda_n} \setminus E) = \text{ATRC}_{E;J,U}^{1,1}. \quad \square$$

Ornstein–Zernike asymptotics. Recall the definition of the inverse correlation length $\nu_{J,U}$ in the AT model in Section 1.3. By the FK-type relations (7) and by Corollary 3.3,

$$\nu_{J,U}(x) = - \lim_{n \rightarrow \infty} \frac{1}{n} \ln \text{ATRC}_{J,U}(0 \xleftrightarrow{\omega_\tau} \lfloor nx \rfloor).$$

The following theorem is the analogue of Theorem 3 for the ATRC model.

Theorem 6. *Let $0 < J < U$ satisfy $\sinh 2J = e^{-2U}$. The inverse correlation length $\nu_{J,U}$ is a norm on \mathbb{R}^2 . Furthermore, uniformly in $|x| \rightarrow \infty$,*

$$\text{ATRC}_{J,U}(0 \xleftrightarrow{\omega_\tau} x) = \frac{g(|x|)}{\sqrt{|x|}} e^{-\nu(x)} (1 + o(1)),$$

where $\nu = \nu_{J,U}$, and $g = g_{J,U}$ is a strictly positive analytic function on \mathbb{S}^1 .

4. COUPLINGS AND INTERFACES

This section is concerned with the construction of a coupling of the FK-percolation and the Ashkin–Teller models, via the six-vertex model, and the derivation of its basic properties. The coupling of the FK and six-vertex measures is an adaptation of the Baxter–Kelland–Wu (BKW) coupling to the Dobrushin boundary conditions [BKW76]. The relation of the six-vertex and AT measures has first been noticed in [Fan72a] comparing their critical properties, and it was made explicit in [Fan72b, Weg72] on a level of partition functions. We build on [GP23], where a coupling of the six-vertex model and a graphical representation of the AT model (a marginal of ATRC) was constructed.

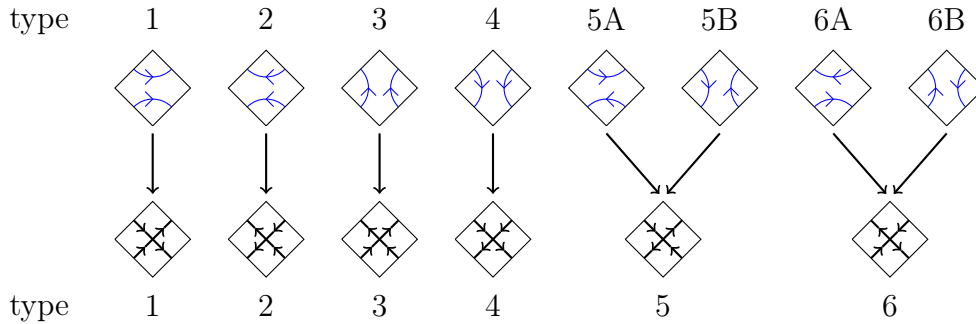

FIGURE 7. Tiles of the oriented loop model and their types and weights, and the mapping from oriented loop arcs to six-vertex edge orientations.

4.1. Different models and combinatorial mappings. This section provides an overview of the combinatorial objects that will be encountered, as well as a description of their relations. We first discuss oriented loop configurations, which serve as an intermediate step in the BKW coupling of the FK-percolation and the six-vertex models. This is followed by a description of two of the representations of the six-vertex model: edge orientations and spin configurations. The height function representation appears only in Section 5, where its monotonicity properties are crucial to derive mixing and relaxation properties of the ATRC measures.

In Section 1, we saw that percolation configurations are in bijection with (unoriented) loop configurations. To make the correspondence $\omega \leftrightarrow \omega^* \leftrightarrow \ell = \text{loop}(\omega)$ explicit, we can regard each of these models as an assignment of a local piece of drawing of an edge and two *arcs* to lozenge tiles centred at the mid-edges as depicted in Fig. 3. Clearly, retaining only either the primal or dual edges, or the arcs, provides complete information about all three.

Oriented loop configurations are obtained from unoriented ones by assigning an orientation to each loop; formally, this is done by means of a sequence of independent uniform random variables on $[0, 1]$ indexed by the set \mathcal{L} of all loops. Alternatively, one can assign orientations to the loop arcs on each tile, subject to the constraint that the orientations of neighbouring arcs match. The eight local configurations that can occur at a tile are referred to as *types*, see Fig. 7.

The edge orientations of the six-vertex model [Pau35, Rys63] are assignments of orientations to the edges in \mathbb{E}^\diamond , obtained from oriented loop configurations via the natural surjection; see Fig. 7. These edge orientations satisfy the *ice rule*: at every vertex, there are two incoming and two outgoing edges of \mathbb{E}^\diamond . This constraint permits six possible local configurations at a tile, which are also called *types*; see Fig. 7. The local inverse operation can be considered as *splitting* the oriented edges into two oriented loop arcs. While tiles of types 1-4 permit a unique reconstruction of the loop arcs based on the edge orientations, there are two possibilities for tiles of types 5-6, giving the latter a special role.

The six-vertex spin representation. The six-vertex model may be represented by pairs of spin-configurations $(\sigma_\bullet, \sigma_\circ) \in \{\pm 1\}^{\mathbb{L}_\bullet} \times \{\pm 1\}^{\mathbb{L}_\circ}$ [Wu71, KW71, Lis22, GP23], obtained from the edge orientations via the following two-valued mapping. Fix the value of σ_\bullet or σ_\circ at some arbitrary fixed vertex and proceed iteratively: given an edge $e \in \mathbb{E}^\diamond$, denote the vertices that it separates by $i \in \mathbb{L}_\bullet$ from a vertex $u \in \mathbb{L}_\circ$; we impose $\sigma_\bullet(i) = \sigma_\circ(u)$ if i is to the left side of e (with respect to its assigned orientation)

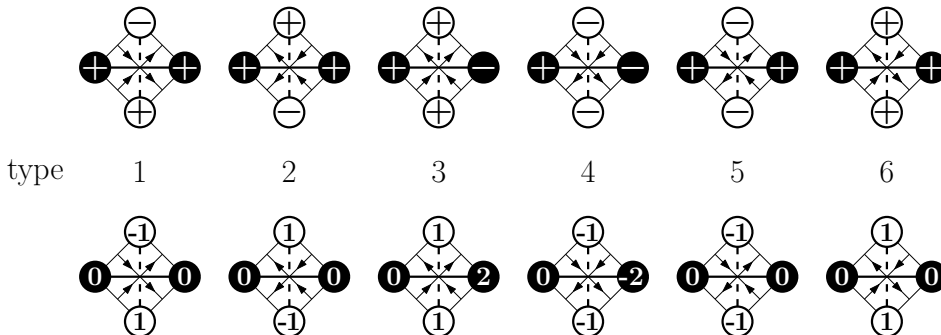

FIGURE 8. The six-vertex types for all representations at a tile corresponding to a horizontal primal edge e . Top: the spin at the left endpoint of e is fixed to be $+$. Bottom: the height at the left endpoint of e is fixed to be 0.

and we impose $\sigma_{\bullet}(i) = -\sigma_{\circ}(u)$ otherwise; see Fig. 8. The ice rule ensures that this mapping is well-defined.

This mapping is two-valued due to the liberty to choose the value of σ_{\bullet} or σ_{\circ} at one vertex, and the two images are related to each other by a global spin flip. Furthermore, it is injective, meaning that the edge orientations can be reconstructed from the spins. The type of a tile with respect to $(\sigma_{\bullet}, \sigma_{\circ})$ is given by the type of the corresponding edge orientations; see Fig. 8. It should also be noted that the ice rule can be translated as follows: for any tile $t \in \mathbb{L}_{\diamond}$, either σ_{\bullet} is constant on the endpoints of e_t or σ_{\circ} is constant on the endpoints of e_t^* . Formally,

$$(\sigma_{\bullet}(i) - \sigma_{\bullet}(j))(\sigma_{\circ}(u) - \sigma_{\circ}(v)) = 0 \quad \text{for any } t \in \mathbb{L}_{\diamond} \text{ with } e_t = ij, e_t^* = uv. \quad (9)$$

In the context of spins, this property will henceforth be referred to as the ice rule.

Baxter–Kelland–Wu correspondence [BKW76]. Given a measure on oriented loops, taking its pushforwards with respect to the above mappings, one obtains measures on the six-vertex edge orientations and spin configurations.

4.2. Coupling under Dobrushin conditions. The idea is to take the FK measure with Dobrushin boundary conditions and construct from it first a measure on pairs of spin configurations on \mathbb{L}_{\bullet} and \mathbb{L}_{\circ} that satisfy the ice rule and then a measure on ATRC configurations. We will then identify these two measures as the six-vertex and the ATRC measures, respectively, under suitable versions of Dobrushin boundary conditions. This gives a coupling between the FK and a modified ATRC, which will allow us to transfer the study of the former to the study of the latter. See also Section 5.1.4 for the BKW coupling [BKW76] without Dobrushin boundary conditions and in the context of height functions.

Recall the subgraphs $G_{n,m} = (V_{n,m}, E_{n,m})$ of $(\mathbb{L}_{\bullet}, \mathbb{E}^{\bullet})$ given in Section 2. As n, m will be fixed in this section, we will omit them in the notation and simply write $G = (V, E)$. Consider $\text{FK}_G^{1/0}$: the FK measure on G under Dobrushin boundary conditions defined in Section 1; see Fig. 2).

Coupling measure. To couple $\text{FK}_G^{1/0}$ with both a six-vertex spin measure and a modified version of the ATRC measure, we augment our probability space to incorporate independent uniform $[0, 1]$ random variables assigned to every loop and every tile. Formally, let \mathcal{L} be the set of all unoriented loops drawn on the tiles of \mathbb{L}_{\diamond} (see the right of Fig. 3). Define $\Omega^{1/0} := \{0, 1\}^{\mathbb{E}^{\bullet}} \times [0, 1]^{\mathcal{L}} \times [0, 1]^{\mathbb{L}_{\diamond}}$ equipped with the product of

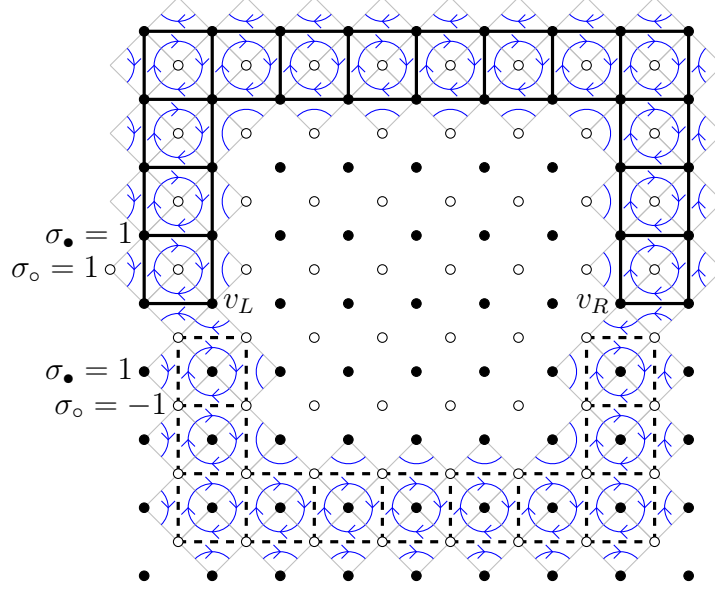

FIGURE 9. Boundary conditions on oriented loops and on six-vertex spins. The edges drawn are those induced by the oriented loop boundary conditions.

Borel sigma algebras. Define Q and Q' respectively as the product measures on $[0, 1]^{\mathcal{L}}$ and $[0, 1]^{\mathbb{L}_o}$. Finally, the coupling measure is defined by

$$\Psi_G^{1/0} := \text{FK}_G^{1/0} \otimes Q \otimes Q'.$$

In Lemmata 4.1 and 4.2 below, we describe how to obtain the following two measures as marginals of $\Psi_G^{1/0}$: the six-vertex spin measure and the modified ATRC measure, both under suitable Dobrushin boundary conditions (Definitions 1 and 2).

From FK to six-vertex. Recall the parameters \mathbf{c} , \mathbf{c}_b , and λ from (3) and the standard rectangular domains from Section 2. Below we omit n, m everywhere.

Definition 1. The six-vertex spin model under Dobrushin conditions is a probability measure on $\sigma = (\sigma_\bullet, \sigma_o) \in \{\pm 1\}^{\mathbb{L}_\bullet} \times \{\pm 1\}^{\mathbb{L}_o}$ defined by

$$\text{Spin}_D^{+,+-}(\sigma) \propto \mathbf{c}^{|T_{5,6}^i(\sigma)|} \mathbf{c}_b^{|T_{5,6}^b(\sigma)|} \mathbf{1}_{\Sigma_\Lambda^+ \times \Sigma_{\Lambda'}^{+-}}(\sigma) \mathbf{1}_{\text{ice}}(\sigma), \quad (10)$$

where \mathbf{c}, \mathbf{c}_b are defined by (3)-(4), $T_{5,6}^i$ and $T_{5,6}^b$ are the sets of tiles of types 5-6 in A^i and ∂A , respectively (see Fig. 8), $\mathbf{1}_{\text{ice}}$ is the indicator imposing the ice rule (9), and Σ_Λ^+ and $\Sigma_{\Lambda'}^{+-}$ are the boundary conditions defined by

$$\begin{aligned} \Sigma_\Lambda^+ &:= \{\sigma_\bullet \in \{\pm 1\}^{\mathbb{L}_\bullet} : \sigma_\bullet(i) = 1 \forall i \in \mathbb{L}_\bullet \setminus \Lambda\}, \\ \Sigma_{\Lambda'}^{+-} &:= \{\sigma_o \in \{\pm 1\}^{\mathbb{L}_o} : \sigma_o(u) = \mathbf{1}_{\mathbb{H}^+}(u) - \mathbf{1}_{\mathbb{H}^-}(u) \forall u \in \mathbb{L}_o \setminus \Lambda'\}. \end{aligned}$$

We now describe how to obtain $\text{Spin}_D^{+,+-}$ as a marginal of the coupling measure $\Psi_G^{1/0}$.

Lemma 4.1. Let (ω, U, U') be distributed according to $\Psi_G^{1/0}$ and let ℓ be the unoriented loop configuration associated to ω . Orient the loops of ℓ as follows (see Fig. 9):

- each loop $l \in \ell$ outside of G (i.e. surrounding a vertex $(\mathbb{L}_o \cap \mathbb{H}^+) \setminus \Lambda'$ or in $(\mathbb{L}_\bullet \cap \mathbb{H}^-) \setminus \Lambda$) is oriented clockwise;
- the unique bi-infinite path is oriented from right to left;
- each loop $l \in \ell$ inside of G (i.e. surrounding a vertex in $\Lambda \cup \Lambda'$) is oriented clockwise if $U_l < e^\lambda / \mathbf{c}$ and counter-clockwise otherwise.

Denote by ℓ_{\rightarrow} the obtained oriented loop configuration. Recall the combinatorial mappings introduced above and let $(\sigma_{\bullet}, \sigma_{\circ})$ be the associated six-vertex spin configurations with $\sigma_{\bullet}((n+1, 0)) = +1$. Then, the law of $(\sigma_{\bullet}, \sigma_{\circ})$ is given by $\text{Spin}_{\mathcal{D}}^{+,+-}$.

Proof. We follow the ideas of [BKW76]. One has to examine which values of (ω, U) result in a given $(\sigma_{\bullet}, \sigma_{\circ}) \in \{\pm 1\}^{\mathbb{L}_{\bullet}} \times \{\pm 1\}^{\mathbb{L}_{\circ}}$. The probability to obtain $(\sigma_{\bullet}, \sigma_{\circ}) \in \Sigma_{\Lambda}^{+} \times \Sigma_{\Lambda'}^{+-}$ is the sum of the probabilities of all oriented loop configurations ℓ_{\rightarrow} that induce the edge orientations corresponding to $(\sigma_{\bullet}, \sigma_{\circ})$. The probability of a given oriented loop configuration ℓ_{\rightarrow} satisfying the boundary conditions in Fig. 9 is proportional to

$$\sqrt{q}^{|\text{loop}(\ell_{\rightarrow})|} \cdot \left(\frac{e^{\lambda}}{e^{\lambda} + e^{-\lambda}} \right)^{|\text{loop}_{\circlearrowleft}(\ell_{\rightarrow})| - |\text{loop}_{\circlearrowright}(\ell_{\rightarrow})|} = e^{\lambda(|\text{loop}_{\circlearrowleft}(\ell_{\rightarrow})| - |\text{loop}_{\circlearrowright}(\ell_{\rightarrow})|)}, \quad (11)$$

where $\text{loop}_{\circlearrowleft}(\ell_{\rightarrow})$ and $\text{loop}_{\circlearrowright}(\ell_{\rightarrow})$ are respectively the sets of clockwise and counter-clockwise oriented loops in ℓ_{\rightarrow} not imposed by boundary conditions, and $\text{loop}(\ell_{\rightarrow})$ is their union. Indeed, by 1, the first factor on the left side is proportional to $\text{FK}_G^{1/0}(\omega(\ell))$, where $\omega(\ell) \in \{0, 1\}^{\mathbb{E}_{\bullet}}$ is the percolation configuration associated to the unoriented loop configuration ℓ corresponding to ℓ_{\rightarrow} . The second factor comes from the values of the uniforms necessary to obtain correct orientations of loops in $\text{loop}(\ell_{\rightarrow})$. The equality holds since $\sqrt{q} = e^{\lambda} + e^{-\lambda}$ due to the choice of λ .

Notice that each loop which is oriented clockwise does 4 more right quarter-turns than left quarter-turns, that the converse holds for counter-clockwise oriented loops, and that the number of left and right quarter-turns in the left-right interface differ by a universal constant. Thus, the expression on the right side of (11) is proportional to

$$\exp(\lambda(\#\curvearrowright(\ell_{\rightarrow}) - \#\curvearrowleft(\ell_{\rightarrow}))/4),$$

where $\#\curvearrowright(\ell_{\rightarrow})$ and $\#\curvearrowleft(\ell_{\rightarrow})$ are respectively the number of right and left quarter-turns in ℓ_{\rightarrow} . The key idea is to count these oriented loop arcs locally at each tile in $A = A^i \cup A^b$. Observe that, for tiles in A^i , types 5B, 6A correspond to a pair of right-oriented loop arcs and types 5A, 6B to a pair of left-oriented loop arcs, whereas types 1-4 correspond to one right-oriented and one left-oriented loop arc each. Moreover, due to the boundary conditions (see Fig. 9), a tile in A^b contains a right turn precisely if it is of type 5, 6, and it contains a left turn otherwise. We deduce that the probability of ℓ_{\rightarrow} is proportional to

$$\prod_{t \in T_{5,6}(\ell_{\rightarrow}) \cap A^i} (e^{\lambda/2} \mathbb{1}_{T_{5B,6A}(\ell_{\rightarrow})}(t) + e^{-\lambda/2} \mathbb{1}_{T_{5A,6B}(\ell_{\rightarrow})}(t)) \cdot (e^{\lambda/2})^{|T_{5,6}(\ell_{\rightarrow}) \cap \partial A^i|}, \quad (12)$$

where $T_{5B,6A}(\ell_{\rightarrow})$ and $T_{5A,6B}(\ell_{\rightarrow})$ are respectively the sets of tiles of types 5B and 6A and the set of tiles of types 5A and 6B in ℓ_{\rightarrow} , and $T_{5,6}(\ell_{\rightarrow})$ is their union.

Finally, fix a pair $(\sigma_{\bullet}, \sigma_{\circ}) \in \Sigma_{\Lambda}^{+} \times \Sigma_{\Lambda'}^{+-}$ that satisfies the ice-rule, and consider its associated edge orientations. It remains to identify all oriented loop configurations ℓ_{\rightarrow} that satisfy the boundary conditions in Fig. 9 and that induce these edge orientations. Observe that the boundary conditions and the spins $(\sigma_{\bullet}, \sigma_{\circ})$ uniquely determine the oriented loop arcs at tiles in $(\mathbb{L}_{\circ} \setminus A) \cup A^b$ and at tiles in $A^i \setminus T_{5,6}^i(\sigma_{\bullet}, \sigma_{\circ})$. For a tile in $T_{5,6}^i(\sigma_{\bullet}, \sigma_{\circ})$, one can split the oriented edges either into a pair of right-oriented loops arcs (types 5B, 6A) or into a pair of left-oriented loop arcs (types 5A, 6B). Summing the probabilities (12) of all oriented loop configurations obtained in that way, we obtain that the probability of $(\sigma_{\bullet}, \sigma_{\circ})$ is proportional to

$$(e^{\lambda/2} + e^{-\lambda/2})^{|T_{5,6}^i(\sigma_{\bullet}, \sigma_{\circ})|} \cdot (e^{\lambda/2})^{|T_{5,6}^b(\sigma_{\bullet}, \sigma_{\circ})|}.$$

Recalling that $\mathbf{c} = e^{\lambda/2} + e^{-\lambda/2}$ and $\mathbf{c}_b = e^{\lambda/2}$ finishes the proof. \square

From six-vertex to modified ATRC. We now adapt the coupling described in [GP23] to the Dobrushin boundary conditions. In particular, we need to define modified the ATRC measure. Recall the parameters from (3) and the (augmented) rectangular domains from Section 2. Again, we omit n, m from the notation.

Definition 2. The modified ATRC model $\mathbf{mATRC}_{n,m} \equiv \mathbf{mATRC}_K$ is a probability measure on $\{0, 1\}^{\bar{E}} \times \{0, 1\}^{\bar{E}}$ defined by

$$\begin{aligned} \mathbf{mATRC}_K(\omega_\tau, \omega_{\tau'}) \propto & \mathbb{1}_{\omega_\tau \subseteq \omega_{\tau'}} \mathbb{1}_{\omega_{\tau'} \setminus \omega_\tau \subseteq E} 2^{|\omega_\tau \cap E|} \left(\frac{2}{\mathbf{c}_b - 1}\right)^{|\omega_\tau \cap E_b^+|} (\mathbf{c} - 2)^{|\omega_{\tau'} \setminus \omega_\tau|} \\ & \cdot 2^{\kappa_K(\omega_\tau)} \prod_{\mathcal{C} \in \text{cl}_\Lambda(\omega_{\tau'})} (\mathbb{1}_{\mathcal{C} \subseteq \Lambda} + \mathbf{c}_b^{I(\mathcal{C})}), \end{aligned}$$

where $\kappa_K(\omega_\tau)$ is the number of clusters of ω_τ , $\text{cl}_\Lambda(\omega_{\tau'})$ is the set of clusters of $\omega_{\tau'}$ that intersect Λ (both ω_τ and $\omega_{\tau'}$ are viewed as spanning subgraph of K), and $I(\mathcal{C}) := |E_b^- \cap \partial_{\bullet}^{\text{edge}} \mathcal{C}|$. We say that a cluster of ω_τ or $\omega_{\tau'}$ is an *inner cluster* if it is entirely contained in Λ and a *boundary cluster* otherwise.

We now describe how to obtain \mathbf{mATRC}_K as a marginal of the coupling measure $\Psi_G^{1/0}$.

Lemma 4.2. *Let (ω, U, U') be distributed according to $\Psi^{1/0}$. Define $(\sigma_\bullet, \sigma_\circ)$ as described in Lemma 4.1. Now define $\omega_\tau, \omega_{\tau'} \in \{0, 1\}^{\bar{E}}$ as follows using the notation $e_t = ij \in \bar{E}$ and $e_t^* = uv$ for each tile $t \in A^i \cup \partial^+ A$:*

- if $\sigma_\circ(u) \neq \sigma_\circ(v)$, set $\omega_\tau(e_t) = \omega_{\tau'}(e_t) = 1$;
- if $\sigma_\bullet(i) \neq \sigma_\bullet(j)$, set $\omega_\tau(e_t) = \omega_{\tau'}(e_t) = 0$ (never happens for $t \in \partial^+ A$);
- if both $\sigma_\circ(u) = \sigma_\circ(v)$ and $\sigma_\bullet(i) = \sigma_\bullet(j)$ hold (types 5-6), let

$$(\omega_\tau(e_t), \omega_{\tau'}(e_t)) = \begin{cases} \mathbb{1}_{[0, \frac{1}{\mathbf{c}}]}(U'_t) \cdot (1, 1) + \mathbb{1}_{[\frac{1}{\mathbf{c}}, \frac{2}{\mathbf{c}}]}(U'_t) \cdot (0, 0) + \mathbb{1}_{[\frac{2}{\mathbf{c}}, 1]}(U'_t) \cdot (0, 1) & \text{if } t \in A^i, \\ \mathbb{1}_{[0, \frac{1}{\mathbf{c}_b}]}(U'_t) \cdot (1, 1) + \mathbb{1}_{[\frac{1}{\mathbf{c}_b}, 1]}(U'_t) \cdot (0, 0) & \text{if } t \in \partial^+ A. \end{cases}$$

Then, the law of $(\omega_\tau, \omega_{\tau'})$ is $\mathbf{mATRC}_K(\cdot | v_L \xleftrightarrow{\omega_\tau} v_R)$. In particular, we have $\omega_\tau \subseteq \omega_{\tau'}$ and $\omega_{\tau'} \setminus \omega_\tau \subseteq \{e_t : t \in A^i\} = E$; also $\sigma_\bullet \sim \omega_{\tau'}$ and $\sigma_\circ \sim \omega_\tau^*$.

Remark 4.3. *The above sampling rule for $t \in A^i$ applied to a six-vertex spin or height measure without modified boundary weight \mathbf{c}_b yields an ATRC measure, as defined in Section 3. See Section 5.1.3 for details.*

Proof. We build on [GP23, Proof of Lemma 7.1]. One has to examine which values of $(\sigma_\bullet, \sigma_\circ, U)$ result in a given pair $\omega_\tau, \omega_{\tau'} \in \{0, 1\}^{\bar{E}}$. Recall that $\sigma_\bullet \sim \omega_{\tau'}$ and $\sigma_\circ \sim \omega_\tau^*$. By (10), the probability of a quadruplet $(\sigma_\bullet, \sigma_\circ, \omega_\tau, \omega_{\tau'})$ is

$$\begin{aligned} & \text{Spin}_D^{+,+}(\sigma_\bullet, \sigma_\circ) \mathbb{1}_{\sigma_\bullet \sim \omega_{\tau'}} \mathbb{1}_{\sigma_\circ \sim \omega_\tau^*} \mathbb{1}_{\omega_\tau \subseteq \omega_{\tau'}} \mathbb{1}_{\omega_{\tau'} \setminus \omega_\tau \subseteq E} \\ & \cdot \prod_{t \in T_{5,6}^i} \left(\frac{1}{\mathbf{c}} (\mathbb{1}_{t \in \omega_\tau} + \mathbb{1}_{t \in \omega_{\tau'}^*}) + \frac{\mathbf{c}-2}{\mathbf{c}} \mathbb{1}_{t \in \omega_{\tau'} \setminus \omega_\tau} \right) \prod_{t \in T_{5,6}^{b,+}} \left(\frac{1}{\mathbf{c}_b} \mathbb{1}_{t \in \omega_\tau} + \frac{\mathbf{c}_b-1}{\mathbf{c}_b} \mathbb{1}_{t \in \omega_\tau^*} \right) \\ & \propto \mathbb{1}_{\Sigma_\Lambda^+}(\sigma_\bullet) \mathbb{1}_{\Sigma_\Lambda^{+-}}(\sigma_\circ) \mathbb{1}_{\sigma_\bullet \sim \omega_{\tau'}} \mathbb{1}_{\sigma_\circ \sim \omega_\tau^*} \mathbb{1}_{\omega_\tau \subseteq \omega_{\tau'}} \mathbb{1}_{\omega_{\tau'} \setminus \omega_\tau \subseteq E} \mathbf{c}_b^{|\mathcal{T}_{5,6}^{b,-}|} \\ & \cdot \prod_{t \in T_{5,6}^i} (\mathbb{1}_{t \in \omega_\tau} + \mathbb{1}_{t \in \omega_{\tau'}^*} + (\mathbf{c} - 2) \mathbb{1}_{t \in \omega_{\tau'} \setminus \omega_\tau}) \prod_{t \in T_{5,6}^{b,+}} (\mathbb{1}_{t \in \omega_\tau} + (\mathbf{c}_b - 1) \mathbb{1}_{t \in \omega_\tau^*}), \quad (13) \end{aligned}$$

where $T_{5,6}^{b,\pm}(\sigma_\bullet, \sigma_\circ)$ is the set of tiles of types 5-6 in $\partial^\pm A$, and where we used the shorthand $T_{5,6}^\# \equiv T_{5,6}^\#(\sigma_\bullet, \sigma_\circ)$ and the fact that, for $\sigma_\bullet \in \Sigma_\Lambda^+$ and $\sigma_\circ \in \Sigma_\Lambda^{+-}$,

$$\mathbb{1}_{\text{ice}}(\sigma_\bullet, \sigma_\circ) \mathbb{1}_{\sigma_\bullet \sim \omega_{\tau'}} \mathbb{1}_{\sigma_\circ \sim \omega_\tau^*} \mathbb{1}_{\omega_\tau \subseteq \omega_{\tau'}} = \mathbb{1}_{\sigma_\bullet \sim \omega_{\tau'}} \mathbb{1}_{\sigma_\circ \sim \omega_\tau^*} \mathbb{1}_{\omega_\tau \subseteq \omega_{\tau'}}.$$

Observe that, on the event $\{\sigma_\bullet \sim \omega_{\tau\tau'}, \sigma_\circ \sim \omega_\tau^*, \omega_\tau \subseteq \omega_{\tau\tau'}\}$,

$$\mathbb{1}_{T_{5,6}^i}(t) = \mathbb{1}_{\omega_\tau}(t) \mathbb{1}_{\sigma_\circ \sim e_t^*} + \mathbb{1}_{\omega_{\tau\tau'}^*}(t) \mathbb{1}_{\sigma_\bullet \sim e_t} + \mathbb{1}_{\omega_{\tau\tau'} \setminus \omega_\tau}(t).$$

Moreover, on the same event intersected with $\{\sigma_\bullet \in \Sigma_\Lambda^+, \sigma_\circ \in \Sigma_{\Lambda'}^{+-}, \omega_{\tau\tau'} \setminus \omega_\tau \subseteq E\}$,

$$\mathbb{1}_{T_{5,6}^{b,-}}(t) = \mathbb{1}_{\sigma_\bullet \sim e_t} \quad \text{and} \quad \mathbb{1}_{T_{5,6}^{b,+}}(t) = \mathbb{1}_{\omega_\tau}(t) \mathbb{1}_{\sigma_\circ \sim e_t^*} + \mathbb{1}_{\omega_\tau^*}(t).$$

Using this, (13) becomes

$$\begin{aligned} & \mathbb{1}_{\Sigma_\Lambda^+}(\sigma_\bullet) \mathbb{1}_{\Sigma_{\Lambda'}^{+-}}(\sigma_\circ) \mathbb{1}_{\sigma_\bullet \sim \omega_{\tau\tau'}} \mathbb{1}_{\sigma_\circ \sim \omega_\tau^*} \mathbb{1}_{\omega_\tau \subseteq \omega_{\tau\tau'}} \mathbb{1}_{\omega_{\tau\tau'} \setminus \omega_\tau \subseteq E} \prod_{t \in \partial^- A} \mathbf{c}_b^{\mathbb{1}_{T_{5,6}^{b,-}}(t)} \\ & \cdot \prod_{t \in A^i} (\mathbb{1}_{t \in \omega_\tau} + \mathbb{1}_{t \in \omega_{\tau\tau'}^*} + (\mathbf{c} - 2) \mathbb{1}_{t \in \omega_{\tau\tau'} \setminus \omega_\tau}) \mathbb{1}_{T_{5,6}^i}(t) \prod_{t \in \partial^+ A} (\mathbb{1}_{t \in \omega_\tau} + (\mathbf{c}_b - 1) \mathbb{1}_{t \in \omega_\tau^*}) \mathbb{1}_{T_{5,6}^{b,+}}(t) \\ = & \mathbb{1}_{\Sigma_\Lambda^+}(\sigma_\bullet) \mathbb{1}_{\Sigma_{\Lambda'}^{+-}}(\sigma_\circ) \mathbb{1}_{\sigma_\bullet \sim \omega_{\tau\tau'}} \mathbb{1}_{\sigma_\circ \sim \omega_\tau^*} \mathbb{1}_{\omega_\tau \subseteq \omega_{\tau\tau'}} \mathbb{1}_{\omega_{\tau\tau'} \setminus \omega_\tau \subseteq E} \prod_{e \in E_b^-} \mathbf{c}_b^{\mathbb{1}_{\sigma_\bullet \sim e}} \\ & \cdot (\mathbf{c} - 2)^{|\omega_{\tau\tau'} \setminus \omega_\tau|} (\mathbf{c}_b - 1)^{|E_b^+ \setminus \omega_\tau|}. \end{aligned}$$

Observe that $\sigma_\circ \in \Sigma_{\Lambda'}^{+-}$ and $\sigma_\circ \sim \omega_\tau^*$ imply that v_L and v_R are connected in ω_τ (see Fig. 9). To obtain the probability of a pair $(\omega_\tau, \omega_{\tau\tau'})$ satisfying $v_L \xleftrightarrow{\omega_\tau} v_R$, we need to sum the last expression over $(\sigma_\bullet, \sigma_\circ)$.

The configurations $\sigma_\circ \in \Sigma_{\Lambda'}^{+-}$ with $\sigma_\circ \sim \omega_\tau^*$ are in bijective correspondence with assignments of ± 1 to the clusters of ω_τ^* in K^* that are contained in Λ' , whence there exist $2^{\kappa_{K^*}(\omega_\tau^*) - 1}$ of them. By Euler's formula,

$$\kappa_{K^*}(\omega_\tau^*) - 1 = \kappa_K(\omega_\tau) + |\omega_\tau| - |\mathbb{V}_{\bar{E}}|.$$

In particular, the probability of a triplet $(\omega_\tau, \omega_{\tau\tau'}, \sigma_\bullet)$ with $v_L \xleftrightarrow{\omega_\tau} v_R$ is proportional to

$$\mathbb{1}_{\Sigma_\Lambda^+}(\sigma_\bullet) \mathbb{1}_{\sigma_\bullet \sim \omega_{\tau\tau'}} \mathbb{1}_{\omega_\tau \subseteq \omega_{\tau\tau'}} \mathbb{1}_{\omega_{\tau\tau'} \setminus \omega_\tau \subseteq E} 2^{\kappa_K(\omega_\tau)} 2^{|\omega_\tau|} (\mathbf{c} - 2)^{|\omega_{\tau\tau'} \setminus \omega_\tau|} (\mathbf{c}_b - 1)^{|E_b^+ \setminus \omega_\tau|} \prod_{e \in E_b^-} \mathbf{c}_b^{\mathbb{1}_{\sigma_\bullet \sim e}}. \quad (14)$$

We now sum this expression over σ_\bullet : since $\sigma_\bullet \sim \omega_{\tau\tau'}$, the value of σ_\bullet is constant at each cluster of $\omega_{\tau\tau'}$; since $\sigma_\bullet \in \Sigma_\Lambda^+$, this value is fixed to be $+1$ on boundary clusters. Denote the sets of inner and boundary clusters of $\omega_{\tau\tau'}$ by $\text{cl}^i(\omega_{\tau\tau'})$ and $\text{cl}^b(\omega_{\tau\tau'})$, respectively. If $e \in E_b^- \setminus \omega_{\tau\tau'}$, then $\sigma_\bullet \sim e$ in precisely two cases: (i) if $e \in \partial_{\mathbb{L}_\bullet}^{\text{edge}} \mathcal{C}$ for some $\mathcal{C} \in \text{cl}^b(\omega_{\tau\tau'})$; (ii) if $e \in \partial_{\mathbb{L}_\bullet}^{\text{edge}} \mathcal{C}$ for some $\mathcal{C} \in \text{cl}^i(\omega_{\tau\tau'})$ on which $\sigma_\bullet = +1$. Therefore,

$$\sum_{\substack{\sigma_\bullet \in \Sigma_\Lambda^+ \\ \sigma_\bullet \sim \omega_{\tau\tau'}}} \prod_{e \in E_b^-} \mathbf{c}_b^{\mathbb{1}_{\sigma_\bullet \sim e}} = \prod_{\mathcal{C} \in \text{cl}^b(\omega_{\tau\tau'})} \mathbf{c}_b^{|\mathbb{L}_\bullet \cap \partial_{\mathbb{L}_\bullet}^{\text{edge}} \mathcal{C}|} \cdot \prod_{\mathcal{C} \in \text{cl}^i(\omega_{\tau\tau'})} (1 + \mathbf{c}_b^{|\mathbb{L}_\bullet \cap \partial_{\mathbb{L}_\bullet}^{\text{edge}} \mathcal{C}|}).$$

Substituting the last display in the sum of (14) over σ_\bullet , we get \mathbf{mATRC}_K . \square

4.3. Properties of the modified ATRC. In this section, we will derive basic properties of the modified ATRC measure that will be instrumental in its analysis in Section 8 and in the proof of Theorem 2. We continue in the setting of the previous section.

Positive association. The motivation for sampling the modified ATRC only on $\bar{E} = E \cup E_b^+$ (rather than on $E \cup E_b$) is that this (marginal) distribution satisfies (**strong-FKG**). This allows to “sandwich” the associated modified ATRC measure between unmodified

ATRC measures and deduce convergence to the unique infinite-volume *Gibbs measure*; see Sections 3 and 5.

Lemma 4.4. *The measure \mathbf{mATRC}_K satisfies (strong-FKG).*

Proof. Recall that $\mathbf{c}_b = e^\lambda$ with $\lambda > 0$. We verify the Holley criterion [Hol74], see also [GHM01, Section 4]. To shorten notation, given $a, b \in \{0, 1\}^{\bar{E}}$ with $a \subseteq b$ and $a = b$ on E_b^+ , we write $\mathbf{mATRC}_K(a_e, b_e \mid a_{e^c}, b_{e^c})$ for the conditional probability

$$\mathbf{mATRC}_K((\omega_\tau(e), \omega_{\tau'}(e)) = (a_e, b_e) \mid (\omega_\tau, \omega_{\tau'}) = (a, b) \text{ on } (\bar{E} \setminus \{e\})).$$

Case 1: $e = ij \in E$. Denote by C_i^a, C_j^a respectively the clusters of a_{e^c} containing i, j , and by $\tilde{C}_i^b, \tilde{C}_j^b$ the clusters of $b_{e^c} \cup E_b^+$ containing i, j . Observe that $\tilde{C}_i^b \neq \tilde{C}_j^b$ implies that $\tilde{C}_i^b \subseteq \Lambda$ or $\tilde{C}_j^b \subseteq \Lambda$. Then, for any $a, b \in \{0, 1\}^{E \cup E_b^+}$ with $a \subseteq b$ and $a = b$ on E_b^+ ,

$$\mathbf{mATRC}_K(a_e, b_e \mid a_{e^c}, b_{e^c}) = \left(2^{a_e} \frac{\mathbf{c}}{\mathbf{c}+1}\right)^{\mathbb{1}_{C_i^a=C_j^a}} (\mathbf{c} - 2)^{b_e - a_e} \frac{f(b)^{b_e}}{1 + (\mathbf{c}-1)f(b)}, \quad (15)$$

where

$$f(b) = \mathbb{1}_{\tilde{C}_i^b = \tilde{C}_j^b} + \alpha (\mathbb{1}_{\tilde{C}_i^b \neq \tilde{C}_j^b \not\subseteq \Lambda} + \mathbb{1}_{\Lambda \not\supseteq \tilde{C}_i^b \neq \tilde{C}_j^b}) + \beta \mathbb{1}_{\Lambda \supseteq \tilde{C}_i^b \neq \tilde{C}_j^b \subseteq \Lambda}$$

and

$$\alpha = \frac{e^{\lambda I(\tilde{C}_i^b)}}{1 + e^{\lambda I(\tilde{C}_i^b)}}, \quad \beta = \frac{1 + e^{\lambda I(\tilde{C}_i^b) + \lambda I(\tilde{C}_j^b)}}{(1 + e^{\lambda I(\tilde{C}_i^b)})(1 + e^{\lambda I(\tilde{C}_j^b)})}.$$

Note first that $\mathbf{c} \geq 1$ (in fact $\mathbf{c} > 2$) and $\mathbb{1}_{C_i^a=C_j^a}$ is increasing in a . Moreover, $\beta \leq \alpha \leq 1$ and both α and β are increasing in $I(\tilde{C}_i^b)$ and $I(\tilde{C}_j^b)$ and hence in b . Therefore $f \geq 1$ is increasing in b . This implies that $\mathbf{mATRC}_K(1, 1 \mid a_{e^c}, b_{e^c})$ is increasing in a, b and $\mathbf{mATRC}_K(0, 0 \mid a_{e^c}, b_{e^c})$ is decreasing in a, b .

Case 2: $e = \{i, j\} \in E_b^+$. If $a_e = b_e$, one has

$$\mathbf{mATRC}_K(a_e, b_e \mid a_{e^c}, b_{e^c}) = \left(2^{a_e} \frac{\mathbf{c}_b}{\mathbf{c}_b+1}\right)^{\mathbb{1}_{C_i^a=C_j^a}} \left(\frac{f(b)}{\mathbf{c}_b-1}\right)^{a_e} \frac{\mathbf{c}_b-1}{\mathbf{c}_b-1+f(b)}, \quad (16)$$

where $f(b)$ is as above. Recall that $\mathbf{c}_b = e^\lambda > 1$ and that $\mathbb{1}_{C_i^a=C_j^a}$ and f are increasing in a and b , respectively. This implies that $\mathbf{mATRC}_K(1, 1 \mid a_{e^c}, b_{e^c})$ is increasing in a, b , and hence $\mathbf{mATRC}_K(0, 0 \mid a_{e^c}, b_{e^c})$ is decreasing in a, b , and the proof is complete. \square

Finite energy. The explicit expressions (15)-(16) of the conditional probabilities readily imply that \mathbf{mATRC}_K satisfies the finite-energy property:

Lemma 4.5. *There exists a constant $c > 0$ such that, for any $e \in E$ and any $a, b \in \{0, 1\}^{E \cup E_b^+}$ with $a \subseteq b$ and $b \setminus a \subseteq E$,*

$$\mathbf{mATRC}_K((\omega_\tau(e), \omega_{\tau'}(e)) = (a_e, b_e) \mid (\omega_\tau, \omega_{\tau'}) = (a, b) \text{ on } \bar{E} \setminus \{e\}) > c.$$

The statement also holds for $e \in E_b^+$, provided that $a_e = b_e$.

Decoupling property. The following decoupling property (and analogues of it), which also holds for the standard ATRC measures, will be crucial in the derivation of mixing properties in Sections 5-6 and the invariance principle in Section 8.

Let us first introduce some terminology.

Definition 3. We identify circuits in \mathbb{L}_\bullet and \mathbb{L}_\circ with their sets of edges as well as with their planar embedding given by the union of line-segments between consecutive vertices. Given a simple circuit γ in \mathbb{L}_\bullet or \mathbb{L}_\circ , we say that a subset $R \subset \mathbb{R}^2$ is *within* γ if it is contained in the topological closure of the bounded connected component of $\mathbb{R}^2 \setminus \gamma$. In this case, γ is said to *surround* R , or R is surrounded by γ .

Lemma 4.6. *Let $(\omega_\tau, \omega_{\tau'})$ be distributed according to \mathbf{mATRC}_K . Let $F_1 \subset F_2 \subset \bar{E}$, and let $a, b \in \{0, 1\}^{F_2 \setminus F_1}$ with $a \subseteq b$ and $b \setminus a \subseteq E$ be such that there exist circuits in a^* and in b that both surround the edges in F_1 . Then, conditionally on $(\omega_\tau|_{F_2 \setminus F_1}, \omega_{\tau'}|_{F_2 \setminus F_1}) = (a, b)$, the restrictions*

$$(\omega_\tau|_{F_1}, \omega_{\tau'}|_{F_1}) \quad \text{and} \quad (\omega_\tau|_{\bar{E} \setminus F_2}, \omega_{\tau'}|_{\bar{E} \setminus F_2})$$

are independent.

Proof. Take any $a_1, b_1 \in \{0, 1\}^{F_1}$ and $a_2, b_2 \in \{0, 1\}^{\bar{E} \setminus F_2}$, and write

$$\bar{a} = a_1 \sqcup a \sqcup a_2 \quad \text{and} \quad \bar{b} = b_1 \sqcup b \sqcup b_2.$$

By Definition 2,

$$\begin{aligned} & \mathbf{mATRC}_K((\bar{a}, \bar{b}) \mid (\omega_\tau|_{F_2 \setminus F_1}, \omega_{\tau'}|_{F_2 \setminus F_1}) = (a, b)) \\ & \propto \left(\prod_{i=1}^2 \mathbb{1}_{a_i \subseteq b_i} \mathbb{1}_{b_i \setminus a_i \subseteq E} 2^{|a_i \cap E|} \left(\frac{2}{c_b - 1}\right)^{|a_i \cap E_b^+|} (c - 2)^{|b_i \setminus a_i|} \right) 2^{\kappa_K(\bar{a})} \prod_{\mathcal{C} \in \text{cl}_\Lambda(\bar{b})} (\mathbb{1}_{\mathcal{C} \subseteq \Lambda} + \mathbf{c}_b^{I(\mathcal{C})}), \end{aligned} \quad (17)$$

where the constant of proportionality depends on a, b .

Let $\gamma' \subset a^* \subset \mathbb{E}^\circ$ be a circuit that surrounds F_1 . Let $E_{\gamma'}^{\text{in}} \subset \bar{E}$ be the set of edges within γ' , and set $E_{\gamma'}^{\text{ex}} = \bar{E} \setminus (E_{\gamma'}^{\text{in}} \cup * \gamma')$. For $\# \in \{\text{in}, \text{ex}\}$, let $K_a^\#$ be the graph obtained from $(\mathbb{V}_{E_{\gamma'}^\#}, E_{\gamma'}^\#)$ by identifying endpoints of edges in a . As the circuit γ' is open in a^* and separates K_a^{in} from K_a^{ex} , we clearly have

$$\kappa_K(\bar{a}) = \kappa_{K_a^{\text{in}}}(a_1) + \kappa_{K_a^{\text{ex}}}(a_2).$$

Similarly, let $\gamma \subset b \subset \mathbb{E}^\bullet$ be a circuit that surrounds F_1 . Let $E_\gamma^{\text{in}} \subset \bar{E}$ be the set of edges within γ , and set $E_\gamma^{\text{ex}} = \bar{E} \setminus E_\gamma^{\text{in}}$. For $\# \in \{\text{in}, \text{ex}\}$, define $K_b^\#$ as the graph obtained from $(\mathbb{V}_{E_\gamma^\#}, E_\gamma^\#)$ by identifying endpoints of edges in b . Let $\text{cl}_{K_b^{\text{in}}}(b_1)$ and $\text{cl}_{K_b^{\text{ex}}}(b_2)$ be the sets of clusters of b_1 in K_b^{in} and b_2 in K_b^{ex} , respectively. Then, every cluster in $\text{cl}_\Lambda(\bar{b})$ that does not contain \mathbb{V}_γ belongs to either $\text{cl}_{K_b^{\text{in}}}(b_1)$ or $\text{cl}_{K_b^{\text{ex}}}(b_2)$. Moreover, every cluster $\mathcal{C} \in \text{cl}_{K_b^{\text{in}}}(b_1)$ except that of the vertex corresponding to γ satisfies $\mathcal{C} \subseteq \Lambda$ and $I(\mathcal{C}) = 0$. Therefore,

$$\prod_{\mathcal{C} \in \text{cl}_\Lambda(\bar{b})} (\mathbb{1}_{\mathcal{C} \subseteq \Lambda} + \mathbf{c}_b^{I(\mathcal{C})}) = 2^{|\text{cl}_{K_b^{\text{in}}}(b_1)| - 1} \prod_{\mathcal{C} \in \text{cl}_{K_b^{\text{ex}}}(b_2)} (\mathbb{1}_{\mathcal{C} \subseteq \Lambda} + \mathbf{c}_b^{I(\mathcal{C})}).$$

Therefore, the expression in (17) factorises, and the proof is complete. \square

4.4. Interface in the modified ATRC. Recall the coupling measure $\Psi^{1/0}$ of the six-vertex spin random variable $(\sigma_\bullet, \sigma_\circ) \sim \text{Spin}_D^{+, +}$ and the modified ATRC pair $(\omega_\tau, \omega_{\tau'}) \sim \mathbf{mATRC}_K(\cdot \mid v_L \xleftrightarrow{\omega_\tau} v_R)$ (Lemmata 4.1 and 4.2).

Interface. Since σ_\circ is constant on edges in ω_τ^* , the Dobrushin boundary conditions $(\sigma_\circ \in \Sigma_{\Lambda'}^{+, -})$ impose the existence of a path in ω_τ that connects v_L and v_R .

Definition 4. Denote by $\mathcal{C} = \mathcal{C}_{v_L} \subseteq \bar{V}$ the cluster of v_L in ω_τ ; see Fig. 10. Let $\gamma \subset \mathbb{R}^2$ be the unique closed curve formed by the line-segments between endpoints of edges in $*\partial_{\mathbb{L}_\bullet}^{\text{edge}} \mathcal{C} \subset \mathbb{E}^\circ$ such that \mathcal{C} is contained in the bounded connected component of $\mathbb{R}^2 \setminus \gamma$. Denote the closure of this component by \mathcal{P} , and define the *interface* $\Gamma = \Gamma_{\text{ATRC}}^{n, m}$ by

$$\Gamma := \mathcal{P} \cap \mathbb{L}_\bullet \subseteq \bar{V}.$$

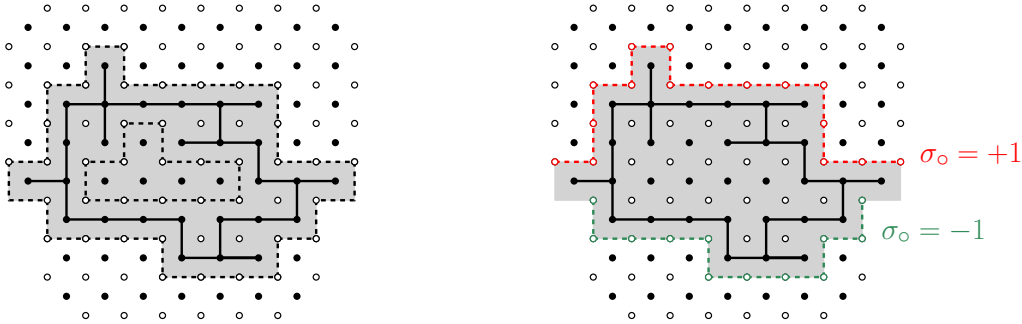

FIGURE 10. Left: A realisation of $\mathcal{C} = \mathcal{C}_{v_L}$ (endpoints of solid edges) in K for $n = m = 3$, the dual $*\partial_{\mathbb{L}_\bullet}^{\text{edge}}\mathcal{C}$ of its edge-boundary in \mathbb{L}_\bullet (dashed edges), and the surrounding polygon \mathcal{P} (grey). Right: a path in $*\partial_K^{\text{edge}}\mathcal{C}$ connecting $(-n - \frac{3}{2}, \frac{1}{2})$ and $(n + \frac{3}{2}, \frac{1}{2})$ on which $\sigma_o = +1$ (red dashed edges), and a path in $*\partial_K^{\text{edge}}\mathcal{C}$ connecting $(-n - \frac{1}{2}, -\frac{1}{2})$ and $(n + \frac{1}{2}, -\frac{1}{2})$ on which $\sigma_o = -1$ (green dashed edges).

5. WEAK MIXING IN THE ATRC

The main results proved in this section are the single-edge relaxation of the ATRC, Proposition 3.2, and the *ratio* weak mixing property for the ATRC, Theorem 4.

In Subsections 5.1 and 5.2 we define the height function of the six-vertex model and use [GP23] to show that it relaxes exponentially to its infinite-volume limit. In Subsection 5.3, we show that this implies exponential relaxation for the ATRC measure with “0, 1” boundary conditions, stated in Proposition 5.9. In Subsection 5.4, we derive Proposition 3.2 from Proposition 5.9 and an input from [ADG24], stated in Proposition 5.11. In Subsection 5.5, we show how to derive from Proposition 3.2 the *exponential* weak mixing property of the ATRC, stated in Theorem 7. Finally, we prove Theorem 4 using the classical work of Alexander [Ale98], Theorem 7 and the input, Proposition 5.11, from [ADG24].

5.1. The six-vertex height function. The proof of Proposition 3.2 relies on exponential relaxation of the ATRC measures with “0, 1” boundary conditions. The latter will be established via the height function representation of the six-vertex model and the BKW coupling [BKW76] with FK-percolation, while it also requires some input from [GP23]. We first introduce the six-vertex height function and provide the necessary graph definitions.

5.1.1. Six-vertex height function. Recall the edge orientations and spin representation of the six-vertex model introduced in Section 4.1. A six-vertex *height function* is an assignment of integers, called *heights*, to the vertices in both \mathbb{L}_\bullet and \mathbb{L}_\circ . Given edge orientations that satisfy the ice rule, define h on $\mathbb{L}_\bullet \cup \mathbb{L}_\circ$ as follows. Fix an integer height at some arbitrary fixed vertex. Then iteratively define the heights at other vertices by increasing the height by 1 when traversing an edge $e \in \mathbb{E}^\circ$ from its left to its right (with respect to its assigned orientation) and decreasing the height by 1 when traversing an arrow from its right to its left; see Fig. 8. As with the spins, the procedure is self-consistent due to the ice rule. Note that the heights on \mathbb{L}_\bullet and on \mathbb{L}_\circ automatically have different parity. By convention, we set the parity on \mathbb{L}_\bullet to be even. The gradient of h is in bijective correspondence with the edge orientations and hence with the spin representation, up to a global spin flip, as demonstrated by the

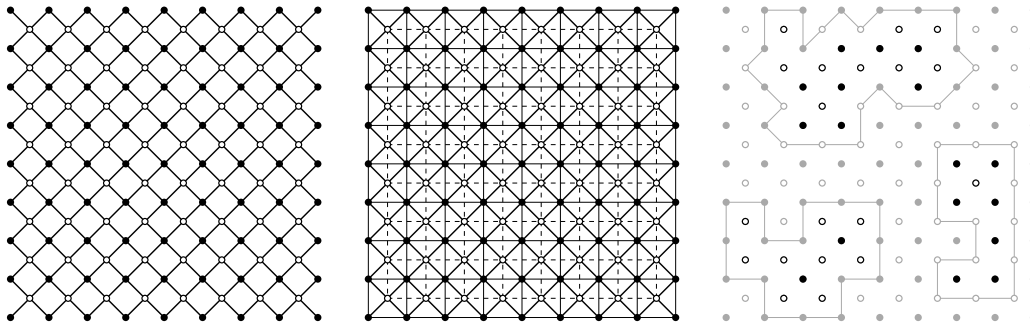

FIGURE 11. Left: part of the rotated square lattice \mathbb{L} . Its faces are the tiles in \mathbb{L}_\circ . Center: part of the augmented lattice $\bar{\mathbb{L}}$. Right: \mathbb{L} -domains given by the vertices strictly within simple circuits in $\bar{\mathbb{L}}$, \mathbb{L}_\bullet , \mathbb{L}_\circ , respectively. The lower left and right \mathbb{L} -domains are even and odd, respectively.

following relation (see Fig. 8):

$$h(u) - h(i) = \sigma_\bullet(i) \sigma_\circ(u) \quad \text{for any } t \in \mathbb{L}_\circ \text{ with } i \in e_t, u \in e_t^*.$$

On the other hand, up to a global spin flip, the spins are obtained from the height function by setting, for all $i \in \mathbb{L}_\bullet$ and $u \in \mathbb{L}_\circ$,

$$\sigma_\bullet(i) = \begin{cases} +1 & \text{if } h(i) = 0 \pmod{4} \\ -1 & \text{if } h(i) = 2 \pmod{4} \end{cases}, \quad \sigma_\circ(u) = \begin{cases} +1 & \text{if } h(u) = 1 \pmod{4} \\ -1 & \text{if } h(u) = 3 \pmod{4} \end{cases}. \quad (18)$$

This motivates the following definition.

Definition 5. A function $h : \mathbb{L}_\bullet \cup \mathbb{L}_\circ \rightarrow \mathbb{Z}$ is called a (six-vertex) height function if it satisfies the following:

- for any $t \in \mathbb{L}_\circ$, $i \in t \cap \mathbb{L}_\bullet$, and $u \in t \cap \mathbb{L}_\circ$, one has $|h(i) - h(u)| = 1$,
- for any $i \in \mathbb{L}_\bullet$, one has $h(i) \in 2\mathbb{Z}$.

Denote the set of all height functions by Ω_{hf} . The type of a tile $t \in \mathbb{L}_\circ$ in a height function h is given by the type of its gradient function; see Fig. 8. Fix $g \in \Omega_{\text{hf}}$, parameters $\mathbf{c}, \mathbf{c}_b > 0$ and a finite subset $\Delta \subset \mathbb{L}_\bullet \cup \mathbb{L}_\circ$. The set $A := A_\Delta \subset \mathbb{L}_\circ$ of tiles of Δ is given by the tiles with at least one corner in Δ . The set $\partial A \subseteq A$ of boundary tiles of Δ is given by the tiles with precisely one corner in Δ . Let $\delta \subseteq \partial A$. The corresponding height function measure on $\mathbb{Z}^{\mathbb{L}_\bullet \cup \mathbb{L}_\circ}$ is defined by

$$\text{HF}_{\Delta, \delta; \mathbf{c}, \mathbf{c}_b}^g(h) \propto \mathbf{c}^{|T_{5,6}^{A \setminus \delta}(h)|} \mathbf{c}_b^{|T_{5,6}^\delta(h)|} \mathbb{1}_{\Omega_{\text{hf}}}(h) \mathbb{1}_{h(x)=g(x) \forall x \in (\mathbb{L}_\bullet \cup \mathbb{L}_\circ) \setminus \Delta}, \quad (19)$$

where $T_{5,6}^{A \setminus \delta}(h)$ (resp. $T_{5,6}^\delta(h)$) is the set of tiles $t \in A \setminus \delta$ (resp. $t \in \delta$) of type 5-6 in h .

If g is constant n on \mathbb{L}_\bullet and constant m on \mathbb{L}_\circ (n even and $m = n \pm 1$), we simply write $\text{HF}_{\Delta, \delta; \mathbf{c}, \mathbf{c}_b}^{n,m}$. When $\delta = \partial A$, we omit δ from the subscript. When $\delta = \emptyset$, we omit δ and \mathbf{c}_b from the subscript.

5.1.2. Rotated lattice and domains. Consider the rotated square lattice \mathbb{L} with vertex-set $\mathbb{L}_\bullet \cup \mathbb{L}_\circ$ and edges between nearest neighbours, that is, between vertices of Euclidean distance $1/\sqrt{2}$. Given $\Delta \subseteq \mathbb{L}$, we write $\Delta_\bullet = \Delta \cap \mathbb{L}_\bullet$ and $\Delta_\circ = \Delta \cap \mathbb{L}_\circ$. The augmented graph $\bar{\mathbb{L}}$ has the same vertex-set as \mathbb{L} and all edges of \mathbb{L} , \mathbb{L}_\bullet and \mathbb{L}_\circ , see Fig. 11. We restrict the notion of simple circuits in $\bar{\mathbb{L}}$ to those that do not traverse both e and e^* for any $e \in \mathbb{E}^\bullet$, so that they can be embedded in \mathbb{R}^2 . We identify such circuits with their planar embedding.

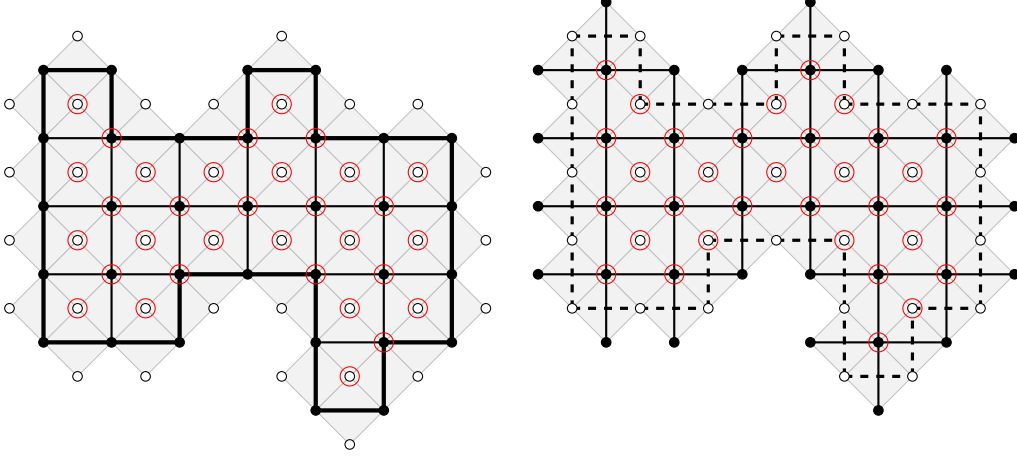

FIGURE 12. Left: a circuit in \mathbb{L}_\bullet (thick black edges) and the corresponding \mathbb{L}_\bullet -domain of the first kind (thin and thick black edges). Right: a circuit in \mathbb{L}_\circ (dashed edges) obtained by shifting the left one by $(1/2, 1/2)$ and the corresponding \mathbb{L}_\bullet -domain of the second kind (black edges). The tiles corresponding to the edges of the domains are shaded grey, and the vertices of the corresponding \mathbb{L} -domains are surrounded by red circles.

Definition 6 (\mathbb{L} -domains). A finite subset $\mathcal{D} \subset \mathbb{L}$ is called an \mathbb{L} -domain if there exists a simple circuit C in $\bar{\mathbb{L}}$ such that \mathcal{D} is given by the vertices of \mathbb{L} strictly within C , that is, in the bounded connected component of $\mathbb{R}^2 \setminus C$. It is called *even* (respectively, *odd*) if $\partial_{\mathbb{L}}^{\text{ex}} \mathcal{D} \subset \mathbb{L}_\bullet$ (respectively, $\partial_{\mathbb{L}}^{\text{ex}} \mathcal{D} \subset \mathbb{L}_\circ$); see Fig. 11.

Definition 7 (\mathbb{L}_\bullet - and \mathbb{L}_\circ -domains). A subgraph $G = (V, E)$ of \mathbb{L}_\bullet is called an \mathbb{L}_\bullet -domain of the *first kind* if $E = \mathbb{E}_V$ and V is given by the vertices within (see Definition 3) a simple circuit in \mathbb{L}_\bullet . We define \mathbb{L}_\circ -domains of the first kind in the same manner. We say that a subgraph $G = (V, E)$ of \mathbb{L}_\bullet is a domain of the *second kind* if its dual $(\mathbb{V}_{*E}, *E)$ is an \mathbb{L}_\circ -domain of the first kind. It is called an \mathbb{L}_\bullet -domain if it is an \mathbb{L}_\bullet -domain of the first or second kind. We define \mathbb{L}_\circ -domains (of the second kind) analogously; see Fig. 12.

Given a subgraph $G = (V, E)$ of \mathbb{L}_\bullet with dual $G^* = (\mathbb{V}_{*E}, *E)$, define Δ_G as the set of vertices of degree 4 in G and G^* , that is,

$$\Delta_G := \{i \in V : |\partial_G^{\text{edge}} \{i\}| = 4\} \cup \{u \in \mathbb{V}_{*E} : |\partial_{G^*}^{\text{edge}} \{u\}| = 4\}.$$

Observe that, if G is an \mathbb{L}_\bullet -domain, then $\mathcal{D}_G := \Delta_G$ is an \mathbb{L} -domain. In this case, any tile $t \in \mathbb{L}_\circ$ intersects \mathcal{D}_G precisely if its associated edge $e_t \in \mathbb{E}^\bullet$ belongs to E , that is, $\{e_t : t \in A_{\mathcal{D}_G}\} = E$; see Section 5.1.1 and Fig. 12.

5.1.3. *Duality coupling with the AT model.* The ATRC measures can be sampled locally from the HF measures, which is the content of the following lemma. We build on [GP23], where a marginal of the ATRC measure was sampled. Given $\mathbf{c} > 2$, a height function $h \in \mathbb{Z}^{\mathbb{L}}$, an edge $e = ij \in \mathbb{E}^\bullet$ with $e^* = uv$, and $x \in [0, 1]$, define $\mathcal{X}_{\mathbf{c}}(h, e, x) \in \{(0, 0), (0, 1), (1, 1)\}$ as follows:

- if $h(u) \neq h(v)$, set $\mathcal{X}_{\mathbf{c}}(h, e, x) = (1, 1)$,
- if $h(i) \neq h(j)$, set $\mathcal{X}_{\mathbf{c}}(h, e, x) = (0, 0)$,
- if $h(u) = h(v)$ and $h(i) = h(j)$, set

$$\mathcal{X}_{\mathbf{c}}(h, e, x) = \mathbb{1}_{[0, \frac{1}{\mathbf{c}})}(x) \cdot (1, 1) + \mathbb{1}_{[\frac{1}{\mathbf{c}}, \frac{2}{\mathbf{c}})}(x) \cdot (0, 0) + \mathbb{1}_{[\frac{2}{\mathbf{c}}, 1]}(x) \cdot (0, 1). \quad (20)$$

Observe that, in order to define $\mathcal{X}_{\mathbf{c}}(h, e, x)$, it suffices to know the values of the corresponding six-vertex spins $\sigma_{\bullet}(i), \sigma_{\bullet}(j), \sigma_{\circ}(u), \sigma_{\circ}(v)$, defined in (18).

Lemma 5.1. *Let $0 < J < U$ satisfy $\sinh 2J = e^{-2U}$ and take $\mathbf{c} := \coth 2J$. Let $G = (V, E)$ be an \mathbb{L}_{\bullet} -domain, and let $\mathcal{D} := \mathcal{D}_G$ be its associated \mathbb{L} -domain. Let h be distributed according to $\mathbf{HF}_{\mathcal{D}; \mathbf{c}}^{0,1}$, and let $(U_e)_{e \in E}$ be a sequence of i.i.d. uniform random variables on $[0, 1]$, independent of h . Define $\omega_{\tau}, \omega_{\tau\tau'} \in \{0, 1\}^{\mathbb{E}^{\bullet}}$ by setting, for $e \in \mathbb{E}^{\bullet}$,*

$$(\omega_{\tau}(e), \omega_{\tau\tau'}(e)) := \begin{cases} (0, 1) & \text{if } e \in \mathbb{E}^{\bullet} \setminus E, \\ \mathcal{X}_{\mathbf{c}}(h, e, U_e) & \text{if } e \in E. \end{cases} \quad (21)$$

Then, the law of $(\omega_{\tau}, \omega_{\tau\tau'})$ is given by $\text{ATRC}_{G; J, U}^{0,1}$.

Proof. Denote the underlying probability measure by \mathbf{P} . Recall that a tile $t \in \mathbb{L}_{\circ}$ intersects \mathcal{D} precisely if its associated edge $e_t \in \mathbb{E}^{\bullet}$ belongs to E , see Fig. 12. Let $(\sigma_{\bullet}, \sigma_{\circ})$ with values in $\{\pm 1\}^{\mathbb{L}_{\bullet}} \times \{\pm 1\}^{\mathbb{L}_{\circ}}$ be the spin configurations obtained from h by (18). For ease of notation, we use the same symbols for the random variables and their realisations. For $\sigma_{\bullet} \in \{\pm 1\}^{\mathbb{L}_{\bullet}}$, $\sigma_{\circ} \in \{\pm 1\}^{\mathbb{L}_{\circ}}$, $\omega \in \{0, 1\}^{\mathbb{E}^{\bullet}}$ and $\# \in \{0, 1\}$, define

$$\Sigma_{\mathcal{D}_{\bullet}}^{+}(\sigma_{\bullet}) := \mathbb{1}_{\sigma_{\bullet} \equiv 1 \text{ on } \mathbb{L}_{\bullet} \setminus \mathcal{D}_{\bullet}}, \quad \Sigma_{\mathcal{D}_{\circ}}^{+}(\sigma_{\circ}) := \mathbb{1}_{\sigma_{\circ} \equiv 1 \text{ on } \mathbb{L}_{\circ} \setminus \mathcal{D}_{\circ}}, \quad \Omega_E^{\#}(\omega) = \mathbb{1}_{\omega \equiv \# \text{ on } \mathbb{E}^{\bullet} \setminus E}.$$

Then, the law of the quadruple $(\sigma_{\bullet}, \sigma_{\circ}, \omega_{\tau}, \omega_{\tau\tau'})$ can be written as follows:

$$\begin{aligned} \mathbf{P}(\sigma_{\bullet}, \sigma_{\circ}, \omega_{\tau}, \omega_{\tau\tau'}) &\propto \mathbb{1}_{\text{ice}}(\sigma_{\bullet}, \sigma_{\circ}) \Sigma_{\mathcal{D}_{\bullet}}^{+}(\sigma_{\bullet}) \Sigma_{\mathcal{D}_{\circ}}^{+}(\sigma_{\circ}) \mathbb{1}_{\sigma_{\bullet} \sim \omega_{\tau\tau'}} \mathbb{1}_{\sigma_{\circ} \sim \omega_{\tau}^*} \\ &\quad \cdot (\mathbf{c} - 2)^{|\omega_{\tau\tau'} \setminus \omega_{\tau} \cap E|} \mathbb{1}_{\omega_{\tau} \subseteq \omega_{\tau\tau'}} \Omega_E^0(\omega_{\tau}) \Omega_E^1(\omega_{\tau\tau'}). \end{aligned}$$

Observe that $\sigma_{\bullet} \sim \omega_{\tau\tau'}$, $\sigma_{\circ} \sim \omega_{\tau}^*$ and $\omega_{\tau} \subseteq \omega_{\tau\tau'}$ imply that $(\sigma_{\bullet}, \sigma_{\circ})$ satisfies the ice rule. Summing over σ_{\bullet} and σ_{\circ} , we obtain the law of $(\omega_{\tau}, \omega_{\tau\tau'})$:

$$\mathbf{P}(\omega_{\tau}, \omega_{\tau\tau'}) \propto 2^{\kappa_V(\omega_{\tau\tau'}) + \kappa_{V'}(\omega_{\tau}^*)} \Omega_E^0(\omega_{\tau}) \Omega_E^1(\omega_{\tau\tau'}) \mathbb{1}_{\omega_{\tau} \subseteq \omega_{\tau\tau'}} (\mathbf{c} - 2)^{|\omega_{\tau\tau'} \setminus \omega_{\tau} \cap E|},$$

where $V' := \mathbb{V}_{*E}$, and where we used that there exist $2^{\kappa_V(\omega_{\tau\tau'}) - 1}$ spin configurations $\sigma_{\bullet} \sim \omega_{\tau\tau'}$ with $\Sigma_{\mathcal{D}_{\bullet}}^{+}(\sigma_{\bullet}) = 1$, and similarly for $\sigma_{\circ} \sim \omega_{\tau}^*$. By planar duality, $\kappa_{V'}(\omega_{\tau}^*) = \kappa_V(\omega_{\tau}) + |\omega_{\tau} \cap E| + \text{const}(G)$. Since $\omega_{\tau}, \omega_{\tau\tau'}$ from (6) satisfy $w_{\tau} = 2$ and $w_{\tau\tau'} = \mathbf{c} - 2$, the proof is complete. \square

5.1.4. *Baxter–Kelland–Wu coupling.* In Section 4.2, we described the BKW coupling by sampling the FK-percolation from the six-vertex model. We now focus on the reverse direction of the BKW. Fix $q > 4$ and $\beta = \beta_c(q) = \ln(1 + \sqrt{q})$, and let $\lambda, \mathbf{c}, \mathbf{c}_b$ be as in (3) and (4). Recall the loop representation of FK-percolation and the representations of the six-vertex model introduced in Section 4.1.

Let \mathcal{D} be an even \mathbb{L} -domain, and set

$$E := *E_{\mathcal{D}_{\circ}} \subset \mathbb{E}^{\bullet}, \quad \Lambda := \mathbb{V}_E \subset \mathbb{L}_{\bullet}, \quad \text{and} \quad G := (\Lambda, E). \quad (22)$$

The following result [BKW76] is classical. It may be proved through the arguments presented in the proof of Lemma 4.1; see [GP23, Theorem 7] for a proof in a similar setting. We will construct a height function from a loop configuration by increasing or decreasing the height whenever we cross a loop, which is the same as orienting the loops as in Section 4.2. We chose the first option for the sake of brevity.

Proposition 5.2. *Let ω be a random element of $\{0, 1\}^{\mathbb{E}^{\bullet}}$ distributed according to $\text{FK}_{G; \beta, q}^w$. Consider the corresponding loop configuration $\text{loop}(\omega)$, and define a height function h as follows:*

H1 *Set $h(i) = 0$ for $i \in \mathbb{L}_{\bullet} \setminus \mathcal{D}$, and $h(u) = 1$ for $u \in \mathbb{L}_{\circ} \setminus \mathcal{D}$.*

H2 Assign constant values to clusters of ω and ω^* in \mathcal{D} by **decreasing** the height by 1 with probability e^λ/\sqrt{q} and **increasing** the height by 1 with probability $e^{-\lambda}/\sqrt{q}$ when crossing a loop from outside, independently for every loop.

The height function h is distributed according to $\text{HF}_{\mathcal{D};\mathbf{c},\mathbf{c}_b}^{0,1}$.

The above procedure also works for odd \mathbb{L} -domains with the difference that one has to take $\omega \sim \text{FK}_{\mathcal{D};\cdot,p,q}^f$, and **H2** must be replaced by

H2' Assign constant values to clusters of ω and ω^* in \mathcal{D} by **decreasing** the height by 1 with probability e^λ/\sqrt{q} and **increasing** the height by 1 with probability $e^{-\lambda}/\sqrt{q}$ when crossing a loop from outside, independently for every loop.

5.1.5. *Input from [GP23]*. For the whole section, fix $q > 4$ and $\beta = \beta_c(q) = \ln(1 + \sqrt{q})$, and let $\lambda, \mathbf{c}, \mathbf{c}_b$ be as in (3) and (4). The following proposition is a consequence of [GP23, Proposition 6.1 and Lemma 6.2] and their proofs.

Proposition 5.3. *For any sequence of even or odd \mathbb{L} -domains $\mathcal{D}_k \nearrow \mathbb{L}$, the measures $\text{HF}_{\mathcal{D}_k;\mathbf{c},\mathbf{c}_b}^{0,1}$ converge to some $\text{HF}_{\mathbf{c}}^{0,1}$ which is independent of the sequence (\mathcal{D}_k) . Moreover, the limiting measure $\text{HF}_{\mathbf{c}}^{0,1}$ can be constructed in either of the following two ways:*

- (i) *Sample $\omega \in \{0, 1\}^{\mathbb{E}^\bullet}$ according to $\text{FK}_{\beta,q}^w$. Set $h = 0$ on the unique infinite cluster of ω , and sample h elsewhere according to **H2** in Section 5.1.4.*
- (ii) *Sample $\omega \in \{0, 1\}^{\mathbb{E}^\bullet}$ according to $\text{FK}_{\beta,q}^f$. Set $h = 1$ on the unique infinite cluster of ω^* , and sample h elsewhere according to **H2'** in Section 5.1.4.*

The following lemma is a slight generalisation of [GP23, Eq. (28)] and can be proved in exactly the same manner.

Lemma 5.4. *Let \mathcal{D} be an \mathbb{L} -domain, and let δ be a set of boundary tiles of \mathcal{D} . Define $\mathcal{D}^{\text{even}} = \mathcal{D} \setminus (\partial^{\text{in}}\mathcal{D})_\bullet$ and $\mathcal{D}^{\text{odd}} = \mathcal{D} \setminus (\partial^{\text{in}}\mathcal{D})_\circ$, where the boundaries are taken in \mathbb{L} . Then, $\mathcal{D}^{\text{even}}$ and \mathcal{D}^{odd} are disjoint unions of even and odd domains in \mathbb{L} , respectively. Moreover, the following stochastic ordering of measures holds:*

$$\text{HF}_{\mathcal{D}^{\text{even}};\mathbf{c},\mathbf{c}_b}^{0,1} \leq_{\text{st}} \text{HF}_{\mathcal{D},\delta;\mathbf{c},\mathbf{c}_b}^{0,1} \leq_{\text{st}} \text{HF}_{\mathcal{D}^{\text{odd}};\mathbf{c},\mathbf{c}_b}^{0,1}.$$

This lemma readily implies that $\text{HF}_{\mathcal{D}_k,\delta_k;\mathbf{c},\mathbf{c}_b}^{0,1}$ (in particular $\text{HF}_{\mathcal{D}_k;\mathbf{c}}^{0,1}$) converges to the same limit, no matter which sequences of \mathcal{D}_k and δ_k we chose.

5.2. Relaxation of height function measures. The aim of this section is to prove a relaxation statement for the six-vertex height function measures with modified weight \mathbf{c}_b on arbitrary boundary tiles, in particular for the measure with unmodified weight \mathbf{c} on all tiles. For the whole section, fix $q > 4$ and $\beta = \beta_c(q) = \ln(1 + \sqrt{q})$, and let $\lambda, \mathbf{c}, \mathbf{c}_b$ be as in (3) and (4).

Given a measure HF on $\mathbb{Z}^{\mathbb{L}}$ and $\Delta \subset \mathbb{L}$, define $\text{HF}|_\Delta$ as its marginal on \mathbb{Z}^Δ .

Proposition 5.5. *There exist constants $c, \alpha > 0$ such that, for every finite $\Delta \subset \mathbb{L}$, every \mathbb{L} -domain \mathcal{D} that contains Δ , and every set $\delta \subset \mathbb{L}_\diamond$ of boundary tiles of \mathcal{D} ,*

$$d_{\text{TV}}(\text{HF}_{\mathcal{D},\delta;\mathbf{c},\mathbf{c}_b}^{0,1}|_\Delta, \text{HF}_{\mathbf{c}}^{0,1}|_\Delta) < c|\Delta|(\text{diam}(\Delta) + d_\infty(\Delta, \mathcal{D}^c))^2 e^{-\alpha d_\infty(\Delta, \mathcal{D}^c)}.$$

The statement on even or odd \mathbb{L} -domains and with modified weight \mathbf{c}_b on all boundary tiles can be proven in the same way as [ADG24, Proposition 4.2], which is slightly less general. We provide only the statement.

Lemma 5.6. *There exist constants $c, \alpha > 0$ such that, for every finite $\Delta \subset \mathbb{L}$ and every even or odd \mathbb{L} -domain \mathcal{D} that contains Δ ,*

$$d_{\text{TV}}(\text{HF}_{\mathcal{D};c,c_b}^{0,1}|_{\Delta}, \text{HF}_{\mathcal{C}}^{0,1}|_{\Delta}) < c(\text{diam}(\Delta) + d_{\infty}(\Delta, \mathcal{D}^c)) e^{-\alpha d_{\infty}(\Delta, \mathcal{D}^c)}.$$

Before deducing Proposition 5.5 from the above and the stochastic ordering of height function measures, Lemma 5.4, we need a general lemma.

Lemma 5.7. [HS22, Lemma 2.16] *Let μ and ν be two probability measures on a finite totally ordered set S with $\mu \leq_{\text{st}} \nu$. Let \mathbf{P} be a monotone coupling of $X \sim \mu$ and $Y \sim \nu$. Then,*

$$\mathbf{P}(X \neq Y) \leq (|S| - 1) d_{\text{TV}}(\mu, \nu).$$

Proof. Identify S with $\{0, \dots, |S| - 1\}$. Let \mathbf{P}_{op} be an optimal coupling of X and Y , that is, $\mathbf{P}_{\text{op}}(X \neq Y) = d_{\text{TV}}(\mu, \nu)$. Since $\mathbf{P}(X \leq Y) = 1$, we have

$$\begin{aligned} \mathbf{P}(X \neq Y) &= \mathbf{P}(Y - X \geq 1) \leq \mathbf{E}[Y - X] \\ &= \mathbf{E}_{\text{op}}[Y - X] \leq (|S| - 1) \mathbf{P}_{\text{op}}(X \neq Y), \end{aligned}$$

where we applied Markov's inequality. \square

Proof of Proposition 5.5. Let $\Delta \subset \mathbb{L}$ be finite, let \mathcal{D} be an \mathbb{L} -domain, and let $\delta \subset \mathbb{L}_{\diamond}$ be a set of boundary tiles of \mathcal{D} . Assume without loss of generality that $\Delta \subseteq \mathcal{D} \setminus \partial^{\text{in}} \mathcal{D}$. Let $\mathcal{D}^{\text{even}}$ and \mathcal{D}^{odd} be as in Lemma 5.4, and recall the stochastic domination statement therein. Consider a monotone coupling \mathbf{P} of $h^- \sim \text{HF}_{\mathcal{D}^{\text{even}};c,c_b}^{0,1}$, $h \sim \text{HF}_{\mathcal{D};\delta;c,c_b}^{0,1}$ and $h^+ \sim \text{HF}_{\mathcal{D}^{\text{odd}};c,c_b}^{0,1}$, that is,

$$\mathbf{P}(h^- \leq h \leq h^+) = 1.$$

Take any vertex $v \in \Delta$ and note that, deterministically, the height functions at v take values in $[-m, m]$, where $m := 2(\text{diam}(\Delta) + d_{\infty}(\Delta, \mathcal{D}^c))$. By Lemma 5.7, we have

$$\begin{aligned} \mathbf{P}(h^-(v) \neq h(v)) &\leq \mathbf{P}(h^-(v) \neq h^+(v)) \leq 2m d_{\text{TV}}(\text{HF}_{\mathcal{D}^{\text{even}};c,c_b}^{0,1}|_{\Delta}, \text{HF}_{\mathcal{D}^{\text{odd}};c,c_b}^{0,1}|_{\Delta}) \quad (23) \\ &\leq 2m (d_{\text{TV}}(\text{HF}_{\mathcal{D}^{\text{even}};c,c_b}^{0,1}|_{\Delta}, \text{HF}_{\mathcal{C}}^{0,1}|_{\Delta}) + d_{\text{TV}}(\text{HF}_{\mathcal{C}}^{0,1}|_{\Delta}, \text{HF}_{\mathcal{D}^{\text{odd}};c,c_b}^{0,1}|_{\Delta})). \end{aligned}$$

Now, $\mathcal{D}^{\text{even}}$ is a disjoint union of even \mathbb{L} -domains $\mathcal{D}_1, \dots, \mathcal{D}_n$ with $\partial^{\text{ex}} \mathcal{D}_i \cap \mathcal{D}_j = \emptyset$ for any $i \neq j$. There exists an i with $\Delta \subseteq \mathcal{D}_i$ and $d_{\infty}(\Delta, \mathcal{D}_i^c) \geq d_{\infty}(\Delta, \mathcal{D}^c) - 1$. Moreover, the definition of the height function measures (19) readily implies that, for any event $A \subset \mathbb{Z}^{\mathbb{L}}$ depending only on values in Δ , we have $\text{HF}_{\mathcal{D}^{\text{even}};c,c_b}^{0,1}(A) = \text{HF}_{\mathcal{D}_i;c,c_b}^{0,1}(A)$. Similar reasoning applies to \mathcal{D}^{odd} . By Lemma 5.6, there exist $c, \alpha > 0$, such that the right-hand side of (23) is bounded by $c m^2 e^{-\alpha d_{\infty}(\Delta, \mathcal{D}^c)}$. The union bound gives

$$d_{\text{TV}}(\text{HF}_{\mathcal{D}^{\text{even}};c,c_b}^{0,1}|_{\Delta}, \text{HF}_{\mathcal{D};\delta;c,c_b}^{0,1}|_{\Delta}) \leq \mathbf{P}(h^-|_{\Delta} \neq h|_{\Delta}) \leq \sum_{v \in \Delta} \mathbf{P}(h^-(v) \neq h(v)).$$

Another application of the triangle inequality and of Lemma 5.6 finishes the proof. \square

Remark 5.8. *Using that h^-, h^+ have uniformly bounded second moment (localisation) and adapting Lemma 5.7 allow to remove the square of $(\text{diam}(\Delta) + d_{\infty}(\Delta, \mathcal{D}^c))^2$ in the bound in Proposition 5.5.*

5.3. Relaxation of ATRC measures. The proof of Proposition 3.2 is based on Proposition 5.11 and another one below, which is a consequence of Proposition 5.5.

The following proposition establishes exponential relaxation of the ATRC measures on domains and with “0, 1” boundary conditions. Once Proposition 3.2 is proven, it can be concluded that the limit coincides with the unique ATRC Gibbs measure. Recall the definition (20) of $\mathcal{X}_{\mathcal{C}}$.

Proposition 5.9. *Let $0 < J < U$ satisfy $\sinh 2J = e^{-2U}$. There exists a measure $\text{ATRC}_{J,U}$ on $\{0, 1\}^{\mathbb{E}^\bullet} \times \{0, 1\}^{\mathbb{E}^\bullet}$ and constants $c, \alpha > 0$ such that, for any \mathbb{L}_\bullet -domain $G = (V, E)$ and any $F \subseteq E$,*

$$\begin{aligned} d_{\text{TV}} \left(\text{ATRC}_{G;J,U}^{0,1}[(\omega_\tau|_F, \omega_{\tau\tau'}|_F) \in \cdot], \text{ATRC}_{J,U}[(\omega_\tau|_F, \omega_{\tau\tau'}|_F) \in \cdot] \right) \\ < c |\mathbb{V}_F| (\text{diam}(\mathbb{V}_F) + d_\infty(\mathbb{V}_F, V^c))^2 e^{-\alpha d_\infty(\mathbb{V}_F, V^c)}, \end{aligned}$$

where diam denotes the diameter with respect to d_∞ . Furthermore, the measure $\text{ATRC}_{J,U}$ is constructed as follows. Let $\mathbf{c} = \coth 2J$, let h be distributed according to $\text{HF}_{\mathbf{c}}^{0,1}$, and let $(U_e)_{e \in \mathbb{E}^\bullet}$ be a sequence of i.i.d. uniform random variables on $[0, 1]$, independent of h . The measure $\text{ATRC}_{J,U}$ is given by the law of $(\omega_\tau, \omega_{\tau\tau'}) \in \{0, 1\}^{\mathbb{E}^\bullet} \times \{0, 1\}^{\mathbb{E}^\bullet}$ defined by

$$(\omega_\tau(e), \omega_{\tau\tau'}(e)) := \mathcal{X}_{\mathbf{c}}(h, e, U_e), \quad e \in \mathbb{E}^\bullet.$$

Remark 5.10. *It is possible to improve the bound in Proposition 5.9 and remove the square in $(\text{diam}(\mathbb{V}_F) + d_\infty(\mathbb{V}_F, V^c))^2$, see Remark 5.8.*

The above proposition follows from the analogous statement for the height function measures, Proposition 5.5, and the fact that the ATRC measures can be sampled locally from these measures, which is the content of Lemma 5.1.

Proof of Proposition 5.9. Let $0 < J < U$ satisfy $\sinh 2J = e^{-2U}$ and $\mathbf{c} = \coth 2J$. Let $G = (V, E)$ be an \mathbb{L}_\bullet -domain and $\mathcal{D} := \mathcal{D}_G$ be its associated \mathbb{L} -domain. Recall that a tile $t \in \mathbb{L}_\diamond$ intersects \mathcal{D} precisely if its associated primal edge $e_t \in \mathbb{E}^\bullet$ belongs to E , see Fig. 12. Let $F \subset E$, and set $\Delta := \mathbb{V}_F \cup \mathbb{V}_{*F}$.

Take $h \sim \text{HF}_{\mathcal{D};\mathbf{c}}^{0,1}$ and $h' \sim \text{HF}_{\mathbf{c}}^{0,1}$, and consider an optimal coupling of $h|_\Delta$ and $h'|_\Delta$. Let $(U_e)_{e \in \mathbb{E}^\bullet}$ be a sequence of i.i.d. uniform random variables on $[0, 1]$, independent of (h, h') . Denote the corresponding probability measure by \mathbf{P} . Define $\omega_\tau, \omega_{\tau\tau'} \in \{0, 1\}^{\mathbb{E}^\bullet}$ from h and (U_e) as in (21). Define $\omega'_\tau, \omega'_{\tau\tau'}$ from h' and (U_e) by setting $(\omega'_\tau(e), \omega'_{\tau\tau'}(e)) = \mathcal{X}_{\mathbf{c}}(h', e, U_e)$ for $e \in \mathbb{E}^\bullet$. Then, clearly

$$(\omega_\tau|_F, \omega_{\tau\tau'}|_F) \neq (\omega'_\tau|_F, \omega'_{\tau\tau'}|_F) \quad \text{implies} \quad h|_\Delta \neq h'|_\Delta.$$

Therefore, by the definition of an optimal coupling and by Proposition 5.5,

$$\begin{aligned} \mathbf{P}((\omega_\tau|_F, \omega_{\tau\tau'}|_F) \neq (\omega'_\tau|_F, \omega'_{\tau\tau'}|_F)) &< c |\Delta| (\text{diam}(\Delta) + d_\infty(\Delta, \mathcal{D}^c))^2 e^{-\alpha d_\infty(\Delta, \mathcal{D}^c)} \\ &< c' |F| (\text{diam}(\mathbb{V}_F) + d_\infty(\mathbb{V}_F, V^c))^2 e^{-\alpha d_\infty(\mathbb{V}_F, V^c)}, \end{aligned}$$

for some $c, c', \alpha > 0$. By Lemma 5.1, the law of $(\omega_\tau, \omega_{\tau\tau'})$ is given by $\text{ATRC}_{G;J,U}^{0,1}$. Finally, denote the law of $(\omega'_\tau, \omega'_{\tau\tau'})$ by $\text{ATRC}_{J,U}$, and the proof is complete. \square

5.4. Proof of Proposition 3.2. Finally, we derive Proposition 3.2 from Proposition 5.9 and the following one that we import from [ADG24].

Proposition 5.11. [ADG24, Proposition 1.1] *Let $0 < J < U$ satisfy $\sinh 2J = e^{-2U}$. There exists $c > 0$ such that, for every $n \geq 1$,*

$$\text{ATRC}_{\Lambda_n;J,U}^{1,1}(0 \xleftrightarrow{\omega_\tau} \partial^{\text{ex}} \Lambda_n) < e^{-cn}.$$

Proof of Proposition 3.2. Let $\sigma \in \{\tau, \tau\tau'\}$. Assume without loss of generality that $n = 2k$ is even (the other case is treated similarly). We proceed in two steps.

Claim 1. There exists $\alpha > 0$ such that

$$\text{ATRC}_{\Lambda_n;J,U}^{1,1}[\omega_\sigma(e)] - \text{ATRC}_{\Lambda_n;J,U}^{0,1}[\omega_\sigma(e)] \leq e^{-\alpha n}.$$

Let $(\omega_\tau, \omega_{\tau\tau'})$ be distributed according to $\text{ATRC}_{\Lambda_n; J, U}^{1,1}$. Define \mathcal{C} to be the outermost (dual) circuit in ω_τ^* that surrounds Λ_k and is contained in Λ_{2k} if it exists, otherwise set $\mathcal{C} = \emptyset$. By exponential decay of connection probabilities in ω_τ , Proposition 5.11, there exist $c, \alpha > 0$ such that

$$\begin{aligned} \text{ATRC}_{\Lambda_n; J, U}^{1,1}[\omega_\sigma(e)] &\leq \text{ATRC}_{\Lambda_n; J, U}^{1,1}[\omega_\sigma(e) \mid \mathcal{C} \neq \emptyset] + \text{ATRC}_{\Lambda_n; J, U}^{1,1}[\Lambda_k \xleftrightarrow{\omega_\tau} \partial^{\text{in}} \Lambda_{2k}] \\ &\leq \text{ATRC}_{\Lambda_n; J, U}^{1,1}[\omega_\sigma(e) \mid \mathcal{C} \neq \emptyset] + ck e^{-\alpha k}, \end{aligned}$$

where we also used the strong FKG and DLR properties of the ATRC measures (Lemma 3.1 and (DLR) in Section 3). Now, again by the strong FKG and (DLR) and by exponential relaxation, Proposition 5.9, there exist $c', \alpha' > 0$ such that

$$\begin{aligned} \text{ATRC}_{\Lambda_n; J, U}^{1,1}[\omega_\sigma(e) \mid \mathcal{C} \neq \emptyset] &= \sum_C \text{ATRC}_{\Lambda_n; J, U}^{1,1}[\omega_\sigma(e) \mid \mathcal{C} = C] \text{ATRC}_{\Lambda_n; J, U}^{1,1}[\mathcal{C} = C \mid \mathcal{C} \neq \emptyset] \\ &\leq \sum_C \text{ATRC}_{G_C; J, U}^{0,1}[\omega_\sigma(e)] \text{ATRC}_{\Lambda_n; J, U}^{1,1}[\mathcal{C} = C \mid \mathcal{C} \neq \emptyset] \\ &\leq \text{ATRC}_{\Lambda_n; J, U}^{0,1}[\omega_\sigma(e)] + c' k^2 e^{-\alpha' k}, \end{aligned}$$

where the summation is over all realisations C of \mathcal{C} , and where G_C is the largest \mathbb{L}_\bullet -domain of the first kind within C that contains Λ_k . This proves Claim 1.

Claim 2. There exists $\alpha > 0$ such that

$$\text{ATRC}_{\Lambda_n; J, U}^{0,1}[\omega_\sigma(e)] - \text{ATRC}_{\Lambda_n; J, U}^{0,0}[\omega_\sigma(e)] \leq e^{-\alpha n}.$$

We use the same strategy as in Claim 1. Indeed, let $(\tilde{\omega}_\tau, \tilde{\omega}_{\tau\tau'})$ be distributed according to $\text{ATRC}_{\Lambda_n; J, U}^{0,0}$. Since, by self-duality (8), $\tilde{\omega}_{\tau\tau'}^*$ has the same law as ω_τ (but on the dual graph of Λ_n) from Claim 1, Proposition 5.11 allows to find a circuit in $\tilde{\omega}_{\tau\tau'}$ that surrounds Λ_k and is contained in Λ_{2k} . For a realisation C of an outermost such circuit, consider the largest \mathbb{L}_\bullet -domain of the second kind within C that contains Λ_k . The remainder of the argument is analogous to Claim 1. \square

5.5. Ratio weak mixing: proof of Theorem 4. We first derive the *exponential* weak mixing property from the single edge relaxation, Proposition 3.2. Given $F \subset \mathbb{E}^\bullet$ and a measure ATRC on $\{0, 1\}^{\mathbb{E}^\bullet} \times \{0, 1\}^{\mathbb{E}^\bullet}$, we write $\text{ATRC}|_F$ for its marginal on $\{0, 1\}^F \times \{0, 1\}^F$.

Theorem 7. *Let $0 < J < U$ satisfy $\sinh 2J = e^{-2U}$. There exists $c > 0$ such that, for any finite subgraph $G = (V, E)$ of \mathbb{L}_\bullet and any $F \subset E$,*

$$\sup_{\eta_\tau, \eta_{\tau\tau'}, \eta'_\tau, \eta'_{\tau\tau'}} d_{\text{TV}} \left(\text{ATRC}_{G; J, U}^{\eta_\tau, \eta_{\tau\tau'}}|_F, \text{ATRC}_{G; J, U}^{\eta'_\tau, \eta'_{\tau\tau'}}|_F \right) \leq 2 \sum_{e \in F} e^{-c d_\infty(e, V^c)},$$

where d_∞ is the distance induced by the L^∞ norm.

As a consequence, the measures $\text{ATRC}_{G; J, U}^{\eta_\tau, \eta_{\tau\tau'}}$ converge (as $G \nearrow \mathbb{L}_\bullet$) to a limit measure $\text{ATRC}_{J, U}$, which is independent of the choice of boundary conditions $\eta_\tau, \eta_{\tau\tau'}$. Furthermore, the limit $\text{ATRC}_{J, U}$ is the unique ATRC Gibbs measure.

Proof. By the strong FKG property, Lemma 3.1, the supremum is attained for $\eta_\tau = \eta_{\tau\tau'} = 1$ and $\eta'_\tau = \eta'_{\tau\tau'} = 0$. Let Ψ be a monotone coupling of $\text{ATRC}_{G; J, U}^{1,1}$ and $\text{ATRC}_{G; J, U}^{0,0}$,

and let $(X, Y) = ((X_\tau, X_{\tau\tau'}), (Y_\tau, Y_{\tau\tau'})) \sim \Psi$. Then,

$$\begin{aligned} d_{\text{TV}}\left(\text{ATRC}_{G;J,U}^{1,1}|_F, \text{ATRC}_{G;J,U}^{0,0}|_F\right) &\leq \Psi(X|_F \neq Y|_F) \\ &\leq \Psi(X_\tau|_F \neq Y_\tau|_F) + \Psi(X_{\tau\tau'}|_F \neq Y_{\tau\tau'}|_F). \end{aligned}$$

Now, for $\sigma \in \{\tau, \tau\tau'\}$,

$$\begin{aligned} \Psi(X_\sigma|_F \neq Y_\sigma|_F) &\leq \sum_{e \in F} \Psi(X_\sigma(e) \neq Y_\sigma(e)) = \sum_{e \in F} \Psi(X_\sigma(e) > Y_\sigma(e)) \\ &= \sum_{e \in F} (\Psi(X_\sigma(e) = 1) - \Psi(Y_\sigma(e) = 1)) \leq \sum_{e \in F} e^{-c d_\infty(e, V^c)} \end{aligned}$$

for some $c > 0$ by Proposition 3.2, where we also used strong positive association and the DLR property of the ATRC measures. \square

A less trivial consequence is the *ratio* weak mixing property, Theorem 4. This follows from the study performed in [Ale98], relying on Theorem 7 and Proposition 5.11.

Proof of Theorem 4. This is a direct application of [Ale98, Section 5]. The reasoning there requires two properties of the measure. The first is exponential weak mixing, which is the content of Theorem 7. The second is the admittance of exponentially bounded controlling regions in the sense of [Ale98], and we argue its validity as follows.

Let $(\omega_\tau, \omega_{\tau\tau'}) \sim \text{ATRC}_{G;J,U}^{\eta_\tau, \eta_{\tau\tau'}}$, fix $F \subset E$, and define

$$H(F) = \{e \in E \setminus F : e \xleftrightarrow{\omega_\tau} \mathbb{V}_F \text{ or } e^* \xleftrightarrow{\omega_{\tau\tau'}^*} \mathbb{V}_{*F}\}.$$

Conditionally on the states of the edges in $H(F)$, the values of the field in F and $E \setminus (F \cup H(F))$ are independent. Moreover, the probability that $e \in E \setminus F$ belongs to $H(F)$ decays exponentially in $d_\infty(e, \mathbb{V}_F)$ by uniform exponential decay in ω_τ and in the dual of $\omega_{\tau\tau'}$. The former is the content of Proposition 5.11 and the latter follows from self-duality. One can then apply [Ale98, Section 5] to obtain the desired claim. \square

6. STRONG MIXING

In this section, we use [Ott25] to push the mixing properties derived in the previous section to strong mixing properties for finite volume ATRC measures.

6.1. Setup. For $k \geq 1$, let $\Gamma_k = ((2k+1)\mathbb{Z})^2$. Given $x \in \mathbb{Z}^2$ or $V \subset \mathbb{Z}^2$, denote $[x]_k := x + \{-k, \dots, k\}^2$ or $[V]_k := \cup_{x \in V} (x + \{-k, \dots, k\}^2)$ respectively.

Path decoupling property. Let $k \geq 1$. For a simple closed nearest-neighbour path γ on Γ_k , denote by $F_{\text{in}}(\gamma)$, $F_{\text{out}}(\gamma)$ the sets of edges in \mathbb{E}^\bullet that are, respectively, in the finite connected component of $\mathbb{E}^\bullet \setminus \mathbb{E}_{[\gamma]_k}$, in the infinite connected component of $\mathbb{E}^\bullet \setminus \mathbb{E}_{[\gamma]_k}$.

Let $(a, b) \in \{(0, 0), (0, 1), (1, 1)\}^{\mathbb{E}^\bullet}$, and $F \subset \mathbb{E}^\bullet$ finite. Say that $\text{ATRC}_F^{a,b}$ has the *k-decoupling path property* if for any simple closed nearest-neighbour path γ in Γ_k , and any configuration $(\xi, \xi') \in \{(0, 0), (0, 1), (1, 1)\}^{F \cap \mathbb{E}_{[\gamma]_k}}$ such that

- the dual of the configuration $\xi_F 0_{F^c}$ (ξ on F and constant 0 on F^c) contains a simple closed path of open dual edges surrounding $[\hat{\gamma}]_k$, where $\hat{\gamma}$ is the set of sites in Γ_k surrounded by γ ,
- the configuration $\xi'_F 1_{F^c}$ (ξ' on F and constant 1 on F^c) contains a simple closed path of open edges surrounding $[\hat{\gamma}]_k$,

one has that if

$$(\omega_\tau, \omega_{\tau'}) \sim \text{ATRC}_F^{a,b} \left(\mid \omega_\tau(e) = \xi(e), \omega_{\tau'}(e) = \xi'(e) \forall e \in \mathbb{E}_{[\gamma]_k} \right),$$

then the restriction of $(\omega_\tau, \omega_{\tau'})$ to $F \cap F_{\text{in}}(\gamma)$ is independent from the restriction of $(\omega_\tau, \omega_{\tau'})$ to $F \cap F_{\text{out}}(\gamma)$. A configuration (ξ, ξ') as above is said to contain *a pair of decoupling paths for γ in F* .

One has this property in, for example, the case of constant boundary conditions $(0, 1)$, or in the case of F simply connected and constant $(0, 0)$ or constant $(1, 1)$ boundary conditions. More generally, to check if the property holds, it suffices to check that cluster count is factorized by the presence of the required paths in $\mathbb{E}_{[\gamma]_k}$, as in Lemma 4.6.

ATRC as a model on sites. The setup of [Ott25] is a collection of site models indexed by finite volumes and some index set T . Cast ATRC as a model on sites by taking the spin space at site x to be

$$\Omega_x = \{(0, 0), (0, 1), (1, 1)\}^{\{\{x, x+e_1\}, \{x, x+e_2\}\}}.$$

I.e. store the value of the field at a given edge in its left/bottom endpoint. Let

$$\psi : \{(0, 0), (0, 1), (1, 1)\}^{\mathbb{E}^\bullet} \rightarrow \prod_{x \in \mathbb{Z}^2} \Omega_x$$

be the natural bijection induced by the above. Let

$$\mathbb{E}_{BL}(\Lambda) = \{\{x, x+e_1\}, \{x, x+e_2\} : x \in \Lambda\}.$$

Bloc Percolation. For $p, q \in [0, 1]$, let $X_i, Y_i, i \in \mathbb{Z}^2$ be an independent family of Bernoulli random variables with parameters

$$P(X_i = 1) = p, \quad P(Y_i = 1) = q \quad \forall i \in \mathbb{Z}^2.$$

For $k \geq 1, F \subset \mathbb{E}^\bullet, x \in \mathbb{Z}^2$, define $i_x \in \Gamma_k$ to be the unique point with $x \in [i_x]_k$, and

$$\eta_x = \begin{cases} X_{i_x} & \text{if } \mathbb{E}_{BL}([i_x]_{3k+1}) \subset F, \\ Y_{i_x} & \text{if } x \in \mathbb{V}_F, \text{ and } \mathbb{E}_{BL}([i_x]_{3k+1}) \cap F^c \neq \emptyset, \\ 0 & \text{else.} \end{cases}$$

Let $P_{F;k,p,q}$ be the law of $(\eta_x)_{x \in \mathbb{Z}^2}$.

6.2. Strong mixing: main Theorem. Then, the main result of the section is the next Theorem. To get it, we will apply the main theorem of [Ott25] (see Section 6.3). For $F_-, F_+ \subset F \subset \mathbb{E}^\bullet, (a, b) \in \{(0, 0), (0, 1), (1, 1)\}^{\mathbb{E}^\bullet}$, define

$$\nu_{F, F_-, F_+}^{a,b}(\cdot) = \text{ATRC}_F^{a,b}(\cdot \mid \omega_\tau(e) = 0 \forall e \in F_-, \omega_{\tau'}(e) = 1 \forall e \in F_+). \quad (24)$$

Theorem 8. *Let $0 \leq J < U$ be such that $\sinh(2J) = e^{-2U}$. There is $l \geq 1$ such that: for any $p > 0$, there are $L < \infty$ and $q < 1$ such that for any $F \subset \mathbb{E}^\bullet$, any $(a, b) \in \{(0, 0), (0, 1), (1, 1)\}^{\mathbb{E}^\bullet}$ such that $\text{ATRC}_F^{a,b}$ has the l -decoupling path property, any $F_-, F_+ \subset \partial^{\text{in}} F$, any $F_1, F_2 \subset F$ disjoint, and any $(f, g), (f', g') \in \{(0, 0), (0, 1), (1, 1)\}^{F_1}$ having positive probability under $\nu_{F, F_-, F_+}^{a,b}$ (defined in (24))*

$$\begin{aligned} d_{\text{TV}}(\nu_{F, F_-, F_+}^{a,b}(W|_{F_2} \in \cdot \mid W|_{F_1} = (f, g)), \nu_{F, F_-, F_+}^{a,b}(W|_{F_2} \in \cdot \mid W|_{F_1} = (f', g'))) \\ \leq P_{F \setminus (F_+ \cup F_-); L, p, q}([\mathbb{V}_{F_1}]_L \leftrightarrow_* [\mathbb{V}_{F_2}]_L), \end{aligned}$$

where $W = (\omega_\tau, \omega_{\tau'})$, and \leftrightarrow_* means $*$ -connections (connections with $\|\cdot\|_\infty$ nearest-neighbours).

Remark 6.1. *We will systematically apply this result in cases where $\{x \in \mathbb{V}_F : \mathbb{E}_{BL}([i_x]_{3L+1}) \cap F^c \neq \emptyset\}$ is a very elongated one dimensional object, so exponential decay of the connection probability can be obtained by a coarse-graining argument as in [OV18, Lemma 3.2].*

6.3. Verifications of the mixing and decoupling hypotheses. In this section, we apply [Ott25] to obtain Theorem 8. The setup of [Ott25] is a family of site models satisfying a collection of hypotheses, denoted Mix1, Mix2, Mar1, Mar2, Mar3. We cast our model in that setup, and check that these hypotheses hold. Theorem 8 then follows from [Ott25, Theorem 1.1]

Family of site measures Let $l \geq 1$ be some number to be fixed large later (it will depend only on J, U). In [Ott25], a family $(\nu_\Lambda^t)_{\Lambda \subset \mathbb{Z}^2, t \in T}$ is considered, with T some index set. We take T to be the set of quintuplets (F, a, b, F_-, F_+) such that $(a, b) \in \{(0, 0), (0, 1), (1, 1)\}^{\mathbb{E}^\bullet}$, $F \subset \mathbb{E}^\bullet$ finite such that $\text{ATRC}_F^{a,b}$ has the l -decoupling path property, and $F_-, F_+ \subset \partial^{\text{in}} F$.

The family $(\nu_\Lambda^t)_{\Lambda \subset \mathbb{Z}^2, t \in T}$ is then given by

$$\nu_\Lambda^{a,b,F,F_+,F_-}(\cdot) := \begin{cases} \text{ATRC}_F^{a,b}(\psi^{-1}(\cdot) \mid \omega_\tau(e) = 0 \forall e \in F_-, \omega_{\tau\tau'}(e) = 1 \forall e \in F_+) & \text{if } \Lambda = \mathbb{V}_F, \\ \text{ATRC}_{\mathbb{E}_\Lambda}^{0,1}(\psi^{-1}(\cdot)) & \text{else.} \end{cases} \quad (25)$$

Note the small abuse of notation: we used the same notation as in (24) for the measure on sites rather than on edges. We are only interested in the first case, the second is only there to fit the setup of [Ott25].

Mixing hypotheses. The hypotheses Mix1 and Mix2 are exponential mixing hypotheses which are weak versions of the ratio weak mixing property (Theorem 4).

Markov-type hypotheses. To avoid lengthy displays, introduce the shorthand

$$F' = \begin{cases} F & \text{if } \mathbb{V}_F = \Lambda, \\ \mathbb{E}_\Lambda & \text{else.} \end{cases}$$

Hypotheses Mar1, Mar2, Mar3 ask for

- a family of local events, Ma_i , $i \in \Gamma_l$, supported on $\mathbb{E}_{BL}([i]_{3l+1})$;
- a family of local events, $\text{Ma}_{i,\Lambda}^t$, $i \in \Gamma_l$, $t = (F, a, b, F_-, F_+) \in T$, $\Lambda \subset \mathbb{Z}^2$, supported on $\mathbb{E}_{BL}([i]_{3l+1}) \cap F'$;
- configurations $\mathbf{a}_i \in \{(0, 0), (0, 1), (1, 1)\}^{\mathbb{E}_{BL}([i]_l)}$, $i \in \Gamma_l$;
- configurations $\mathbf{a}_{i,\Lambda}^t \in \{(0, 0), (0, 1), (1, 1)\}^{\mathbb{E}_{BL}([i]_l) \cap F'}$, $i \in \Gamma_l$.

These should satisfy:

- (1) if γ is a simple closed nearest-neighbour path in Γ_l , and (ξ, ξ') is a configuration on $F' \cap \mathbb{E}_{[\gamma]_{3l+1}}$ such that for any $i \in \gamma$ with $\mathbb{E}_{[i]_{5l+2}} \subset F'$ one has

$$(\xi, \xi')|_{\mathbb{E}_{[i]_{3l+1}}} \in \text{Ma}_i,$$

and for any $i \in \gamma$ with $\mathbb{E}_{[i]_{5l+2}} \not\subset F'$, $\mathbb{E}_{[i]_{3l+1}} \cap F' \neq \emptyset$, one has

$$(\xi, \xi')|_{\mathbb{E}_{[i]_{3l+1}} \cap F'} \in \text{Ma}_{i,\Lambda}^t,$$

then (ξ, ξ') contains a pair of decoupling paths for γ in F' . This is Mar1.

- (2) The probability of Ma_i conditionally on the configuration outside of $\mathbb{E}_{[i]_{3l+1}}$ is lower bounded by $p_0 < 1$ fixed universal, uniformly over the configuration outside of $\mathbb{E}_{[i]_{3l+1}}$. This is Mar2.

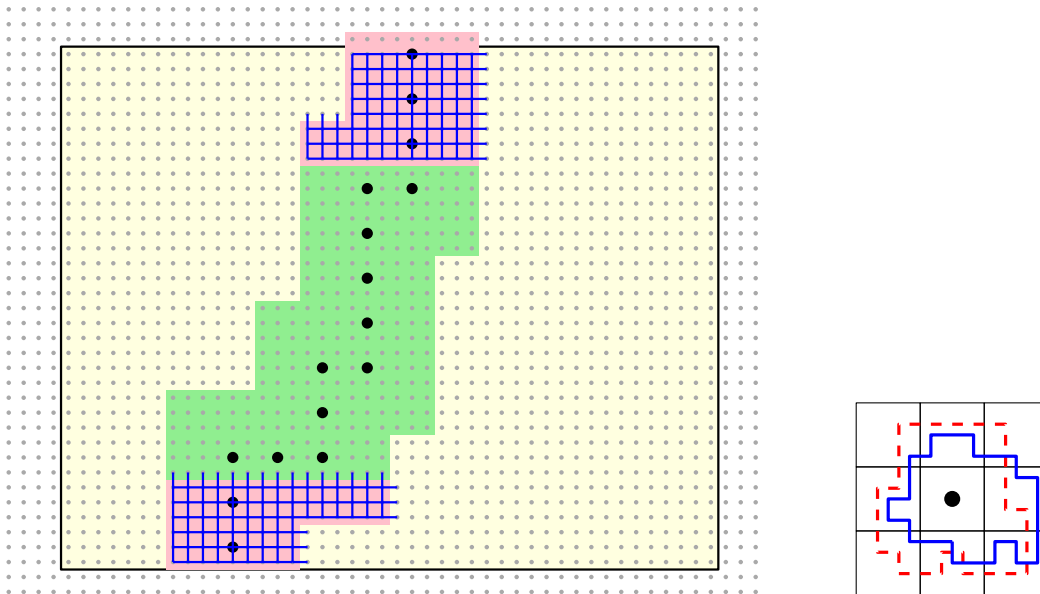

FIGURE 13. Left: a path in Γ_1 (black disks), the blue edges have their state forced to be $(0, 1)$, the black disks in a green square imply the realization of Ma_i at that place. Right: a realization of Ma_i (blue edges are open in $\omega_{\tau\tau'}$, while the dashed red path represent the dual of edges closed in ω_τ).

- (3) If $w \in \text{Ma}_i$, and $j \in \Gamma_l$ with $\|i - j\|_\infty \leq 2l + 1$, then the configuration obtained by swapping the value of $w|_{\mathbb{E}_{BL}([j]_l)}$ to a_j is still in Ma_i , and similarly for $a_{i,\Lambda}^t$. Moreover, the probability of $a_i, a_{i,\Lambda}^t$ conditionally on the configuration outside of their respective supports is greater than $\theta > 0$ for some $\theta > 0$ uniform over the the configuration outside of the support. This is Mar3.

Take the events/configurations (l is taken large enough):

- Ma_i is the event that $\mathbb{E}_{[i]_{3l/2}} \setminus \mathbb{E}_{[i]_{l+1}}$ contains both a simple closed path of edges open in $\omega_{\tau\tau'}$ surrounding $[i]_{l+1}$, and a simple closed path of dual edges open in ω_τ^* surrounding $[i]_{l+1}$.
- $a_{i,\Lambda}^t$, and a_i are the constant $(0, 1)$ configurations.
- $\text{Ma}_{i,\Lambda}^t$ contains only the constant $(0, 1)$ configuration.

See Fig. 13. Mar1 follows by Jordan's curve Theorem. Mar2 follows (once l is fixed large enough) from exponential mixing (Theorem 7) and uniform exponential decay of connectivities in ω_τ , and $\omega_{\tau\tau'}^*$ (Theorem 5). Finally, Mar3 follows from finite energy (FE).

7. RANDOM WALK PICTURE IN THE ATRC

We start this section by introducing the objects necessary to the development of the ‘‘Ornstein-Zernike theory’’ (renewal picture of connection probabilities). We follow the general strategy used in [CI02, CIV03, CIV08, OV18, AOV24], most results will be imported when their proof is a repetition of existing arguments. To keep notations readable, we will use the following short-hand throughout this section:

$$\Phi \equiv \text{ATRC}_{J,U}, \quad \Phi_\Lambda^{a,b} \equiv \text{ATRC}_{\Lambda;J,U}^{a,b}$$

where $\text{ATRC}_{J,U}$ is the unique infinite-volume measure for the ATRC model (recall Proposition 5.9). The theorems that will be used in other sections will be stated with the

notation matching the rest of the paper. Moreover, again to lighten notations, connections are in ω_τ unless explicitly stated otherwise.

We will denote \mathcal{C}_0 the cluster of 0 in ω_τ .

7.1. Decay rate, Cones, and Diamonds. Start by introducing some objects.

Norm induced by the decay rates and associated sets. For $s \in \mathbb{S}^1$, define

$$\nu(s) = - \lim_{n \rightarrow \infty} \frac{1}{n} \ln \Phi(0 \leftrightarrow ns). \quad (26)$$

Existence of the limit follows in the standard fashion by Fekete's Lemma, using sub-additivity which follows from FKG inequality. We now extend ν to \mathbb{R}^2 by positive homogeneity of order one: for any $s \in \mathbb{S}^1$ and $r \geq 0$, define

$$\nu(rs) := r\nu(s).$$

Using existence of the limit and the FKG inequality, one can show that ν is a non-degenerate norm as soon as it is non-zero: ν is positive homogeneous by definition; exponential decay of connection probabilities in Φ (the ATRC model) implies positivity; the FKG inequality for Φ implies the triangular inequality for ν . See [Ale01, Section 2] for details. Clearly, ν inherits the symmetries of the lattice, that is axial and diagonal reflections and rotations by $\pi/2$. From these symmetry considerations, one has that for any $s \in \mathbb{S}^1$,

$$\frac{1}{\sqrt{2}}\nu(e_1) \leq \nu(s) \leq \sqrt{2}\nu(e_1),$$

with $e_1 = (1, 0)$. Moreover, one has

$$\Phi(0 \leftrightarrow x) = e^{-\nu(x)(1+o(1))}. \quad (27)$$

As ν is a norm, there are two convex sets naturally associated to it: the equi-decay set \mathcal{U} , and the convex set of which ν is the support function, \mathcal{W} .

$$\mathcal{U} = \{x \in \mathbb{R}^d : \nu(x) \leq 1\}, \quad \mathcal{W} = \bigcap_{s \in \mathbb{S}^1} \{x \in \mathbb{R}^d : x \cdot s \leq \nu(s)\}. \quad (28)$$

It is easy to see that \mathcal{U} and \mathcal{W} are dual to each other, that is: \mathcal{W} is the equi-decay set of the norm dual to ν , and the norm dual to ν is the support function of \mathcal{U} . We say that $(s, t) \in \mathbb{S}^1 \times \partial\mathcal{W}$ is a *dual pair* if $\nu(s) = t \cdot s$. From the definitions, one has, for any $x \in \mathbb{R}^d$,

$$\nu(x) = \max_{t \in \partial\mathcal{W}} t \cdot x. \quad (29)$$

We refer to [Roc70] for details on convex duality. From the last display, it is also easy to see that \mathcal{W} is the closure of the convergence domain of

$$\mathbb{G}(t) = \sum_{x \in \mathbb{Z}^2} \Phi(0 \leftrightarrow x) e^{t \cdot x}. \quad (30)$$

Cones and Diamonds. Let $t \in \partial\mathcal{W}$, $\delta \in (0, 1)$. Let us introduce the geometric objects used in the interface study. We first define the cones and the associated diamonds (see Fig. 14):

$$\mathcal{Y}_{t,\delta}^\blacktriangleleft := \{x \in \mathbb{R}^2 : x \cdot t \geq (1 - \delta)\nu(x)\}, \quad \mathcal{Y}_{t,\delta}^\blacktriangleright := -\mathcal{Y}_{t,\delta}^\blacktriangleleft,$$

$$\text{Diamond}_{t,\delta}(u, v) := (u + \mathcal{Y}_{t,\delta}^\blacktriangleleft) \cap (v + \mathcal{Y}_{t,\delta}^\blacktriangleright).$$

As δ goes to 1, the cone $\mathcal{Y}_{t,\delta}^\blacktriangleleft$ converges to the half-plane that contains t and whose boundary is orthogonal to t . As δ goes to 0, the cone $\mathcal{Y}_{t,\delta}^\blacktriangleleft$ converges to the convex

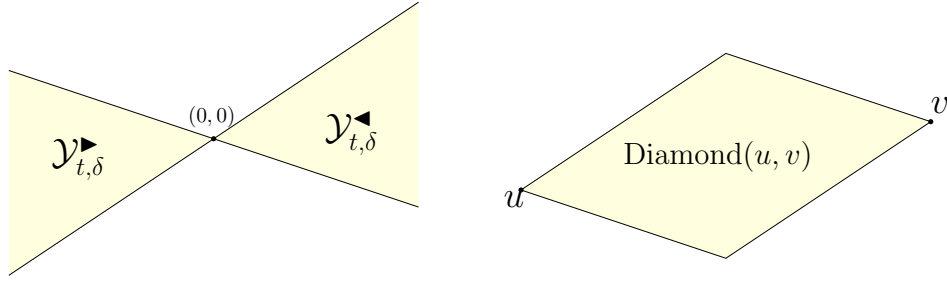

FIGURE 14. Forward and backward cones, and the associated diamond.

cone generated by the directions dual to t . The latter set is a line when ν is strictly convex.

Let $V \subset \mathbb{Z}^2$. We will say that V is:

- (t, δ) -*forward-confined* if there exists $u \in V$ such that $V \subset u + \mathcal{Y}_{t,\delta}^{\blacktriangleleft}$. When it exists, such a u is unique; we denote it by $\mathbf{f}(V)$.
- (t, δ) -*backward-confined* if there exists $v \in V$ such that $V \subset v + \mathcal{Y}_{t,\delta}^{\blacktriangleright}$. When it exists, such a v is unique; we denote it by $\mathbf{b}(V)$.
- (t, δ) -*diamond-confined* if it is both forward- and backward-confined.

We will say that $v \in V$ is a (t, δ) -*cone-point* of V if

$$V \subset v + (\mathcal{Y}_{t,\delta}^{\blacktriangleright} \cup \mathcal{Y}_{t,\delta}^{\blacktriangleleft}).$$

We denote $\text{CPTs}_{t,\delta}(V)$ the set of cone-points of V . When speaking about cone-points of graphs, we mean cone-points of their vertex set.

We call a graph with a distinguished vertex a *marked graph*. The distinguished vertex is denoted v^* . Define (see Fig. 15)

- The sets of confined pieces (all are sets of finite connected sub-graphs of $(\mathbb{Z}^2, \mathbb{E})$):

$$\mathfrak{B}_L(t, \delta) = \{\gamma \text{ marked backward-confined with } v^* = 0\},$$

$$\mathfrak{B}_R(t, \delta) = \{\gamma \text{ marked forward-confined with } \mathbf{f}(\gamma) = 0\},$$

$$\mathfrak{A}(t, \delta) = \{\gamma \text{ diamond-confined with } \mathbf{f}(\gamma) = 0\}.$$

To fix ideas we shall, unless stated otherwise, think of \mathfrak{A} as of a subset of \mathfrak{B}_L , that is, by default the vertex $\mathbf{f}(\gamma) = 0$ is marked for any $\gamma \in \mathfrak{A}$. Note that \mathfrak{A} can alternatively be viewed as subset of \mathfrak{B}_R by marking $\mathbf{b}(\gamma)$.

- The displacement along a piece:

$$X(\gamma) := \begin{cases} \mathbf{b}(\gamma) & \text{if } \gamma \in \mathfrak{B}_L, \text{ in particular, if } \gamma \in \mathfrak{A}, \\ v^* & \text{if } \gamma \in \mathfrak{B}_R. \end{cases} \quad (31)$$

- The *concatenation* operation (see Fig. 16): for $\gamma_1 \in \mathfrak{B}_L$ and $\gamma_2 \in \mathfrak{B}_R$ define the concatenation of γ_2 to γ_1 as

$$\gamma_1 \circ \gamma_2 = \gamma_1 \cup (X(\gamma_1) + \gamma_2).$$

The concatenation of two graphs in \mathfrak{A} is an element of \mathfrak{A} , the concatenation of a graph in \mathfrak{A} to an element of \mathfrak{B}_L is an element of \mathfrak{B}_L , and the concatenation of a element in \mathfrak{B}_R to an graph in \mathfrak{A} is an element of \mathfrak{B}_R . The displacement along a concatenation is the sum of the displacements along the pieces.

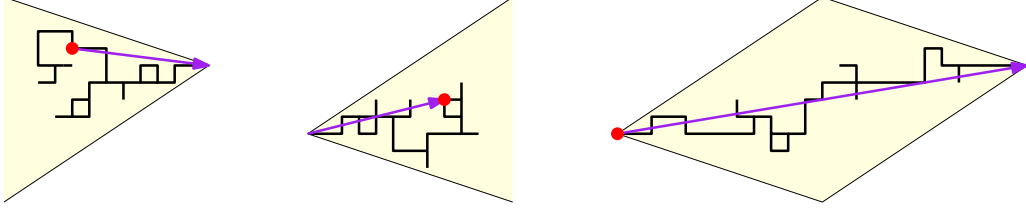

FIGURE 15. Backward, forward, and diamond confined marked graphs, with their displacement.

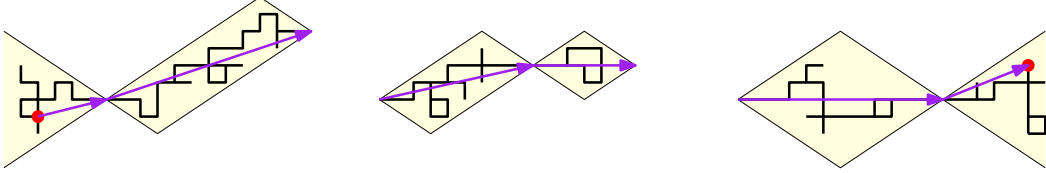

FIGURE 16. Concatenation of confined graphs. Red dots are the marked vertices of the marked graphs.

These sets can be seen as equivalence classes of general marked forward/backward/diamond confined graphs modulo translations. A general such graph, $\gamma'_L, \gamma'_R, \gamma'$, can then be recovered uniquely from an element $\gamma_L, \gamma_R, \gamma$ of $\mathfrak{B}_L, \mathfrak{B}_R, \mathfrak{A}$ by specifying the translation vector.

7.2. Main result of the section. Our main goal is to prove the following ‘‘coupling with random walk’’ in infinite volume for long connections in the ATRC model. Recall that $e_1 = (1, 0), e_2 = (0, 1)$ are the canonical basis vectors.

Theorem 9. *Let $0 \leq J < U$ be such that $\sinh(2J) = e^{-2U}$. Let $s_0 \in \mathbb{S}^1, t \in \partial\mathcal{W}$ dual to s_0 and $\delta \in (0, 1)$ be such that the interior of $\mathcal{Y}_{t,\delta}^\blacktriangleleft$ contains an element of $\{\pm e_1, \pm e_2\}$. Then, there exist constants $C, C_1, C_2 \geq 0, c_1, c_2 > 0, \epsilon > 0$ and probability measures p_L, p, p_R on $\mathfrak{B}_L(t, \delta), \mathfrak{B}_R(t, \delta), \mathfrak{A}(t, \delta)$ respectively such that*

- (1) renewal structure: for any $x \in \mathbb{Z}^2$ such that $x \cdot s_0 \geq (1 - \epsilon)|x|$, and any f real valued function of the cluster of 0,

$$\left| C \sum_{\gamma_L, \gamma_R} p_L(\gamma_L) p_R(\gamma_R) \sum_{k \geq 0} \sum_{\gamma_1, \dots, \gamma_k} f(\bar{\gamma}) \mathbb{1}_{X(\bar{\gamma})=x} \prod_{i=1}^k p(\gamma_k) - e^{t \cdot x} \text{ATRC}_{J,U}(f(C_0) \mathbb{1}_{0 \stackrel{\omega_{\bar{\gamma}}}{\leftarrow} x}}) \right| \leq C_1 \|f\|_\infty e^{-c_1|x|}, \quad (32)$$

where $\bar{\gamma} = \gamma_L \circ \gamma_1 \circ \dots \circ \gamma_k \circ \gamma_R$, and the sums are over $\gamma_L \in \mathfrak{B}_L(t, \delta), \gamma_R \in \mathfrak{B}_R(t, \delta)$, and $\gamma_1, \dots, \gamma_k \in \mathfrak{A}(t, \delta)$;

- (2) exponential tails and ‘‘finite energy’’ for the steps: for $(p_*, D_*) \in \{(p_L, \mathfrak{B}_L(t, \delta)), (p_R, \mathfrak{B}_R(t, \delta)), (p, \mathfrak{A}(t, \delta))\}$,

$$\sum_{\gamma \in D_*} p_*(\gamma) \mathbb{1}_{\|X(\gamma)\| \geq \ell} \leq C_2 e^{-c_2 \ell} \quad \forall \ell \geq 0, \quad (33)$$

$$p_*(\gamma) \geq \alpha^{|\gamma|+1} \quad \forall \gamma \in D_*, \quad (34)$$

for some $\alpha > 0$ depending on J, U only,

(3) mean value of a step is proportional to s_0 : there is a $a > 0$ such that

$$\sum_{\gamma \in \mathfrak{A}(t, \delta)} p(\gamma) X(\gamma) = a s_0. \quad (35)$$

Moreover, $\partial \mathcal{U}$, $\partial \mathcal{W}$ are analytic manifolds and the norm ν is uniformly strictly convex, that is \mathcal{U} is strictly convex and $\partial \mathcal{U}$ has uniformly lower bounded curvature. In particular, each direction $s \in \mathbb{S}^1$ has a unique dual vector $t_s \in \partial \mathcal{W}$ and there exist $\kappa > 0$ such that the following sharp triangle inequality holds:

$$\nu(x) + \nu(y) - \nu(x + y) \geq \kappa(|x| + |y| - |x + y|).$$

The rest of the section is devoted to the proof of Theorem 9. Subsections 7.3, 7.4, and 7.5 are preparations for the core of the proof. The proof itself is then divided in two main steps, presented respectively in Subsections 7.6, and 7.7.

Remark 7.1. We use the value of J, U through only two inputs: the exponential decay in ω_τ and $\omega_{\tau\tau'}$, and the mixing of Theorems 4 and 8 (which follows from edge relaxation, Proposition 3.2, and exponential decay in ω_τ and $\omega_{\tau\tau'}$). In particular, if one can extend these properties beyond the self-dual line (part of which is done in [ADG24]), Theorem 9 extends directly.

7.3. The coarse-graining procedure. The first step is to analyse the typical geometry of long connections. The analysis of [CIV08, AOV24] is based on a coarse-graining of the cluster of 0. Introduce the cells: for $K, k \geq 1$ and $A \subset \mathbb{Z}^2$,

$$[A]_k = \bigcup_{x \in A} (x + \{-k, \dots, k\}^2),$$

$$\Delta_K = K\mathcal{U} \cap \mathbb{Z}^2, \quad \Delta'_K = [\Delta_K]_{\ln(K)^2}.$$

The scale parameter K will be picked large enough in the course of the proof.

We then coarse-grain the cluster of 0 using the same algorithm as in [CIV08]. Denote $\Delta \equiv \Delta_K$ and $\Delta' \equiv \Delta'_K$. For C a realization of \mathcal{C}_0 define $\text{Sk}(C)$ via the next algorithm (see also Fig. 17).

Set $v_0 = 0$, $\text{Sk}_V = \{v_0\}$, $\text{Sk}_E = \emptyset$, $V = \Delta'$, $i = 1$;

while $A = \{z \in \partial^{\text{ex}} V : z \xrightarrow{(z+\Delta) \setminus V} \partial^{\text{in}}(z + \Delta)\} \neq \emptyset$ **do**

 Set $v_i = \min A$;

 Let v^* be the smallest $v \in \text{Sk}_V$ such that $v_i \in \partial^{\text{in}}(\Delta + v^*)$;

 Update $\text{Sk}_V = \text{Sk}_V \cup \{v_i\}$, $\text{Sk}_E = \text{Sk}_E \cup \{\{v^*, v_i\}\}$, $V = V \cup (v_i + \Delta')$,

$i = i + 1$;

end

return $(\text{Sk}_V, \text{Sk}_E)$;

Algorithm 1: Coarse graining of a cluster containing 0.

The output $\text{Sk}(C) = (\text{Sk}_V(C), \text{Sk}_E(C))$ of Algorithm 1 is a tree with $\text{Sk}_V(C) \subset \mathbb{Z}^2$. use the shorthand $|\text{Sk}(C)| := |\text{Sk}_V(C)|$ for its size.

7.4. Energy-Entropy estimates. The next step is to establish energy bounds which control the probability to see a given tree as the skeleton of the cluster.

Lemma 7.2. For any $0 \in A \subset \mathbb{Z}^2$, and $K \geq 1$,

$$\Phi_{[\Delta_K \cap A]_{\ln(K)^2}}^{1,1} (0 \xrightarrow{\Delta_K \cap A} \partial^{\text{in}} \Delta_K) \leq e^{-K(1+o_K(1))}, \quad (36)$$

where $o_K(1)$ is a quantity that goes to 0 as K goes to ∞ .

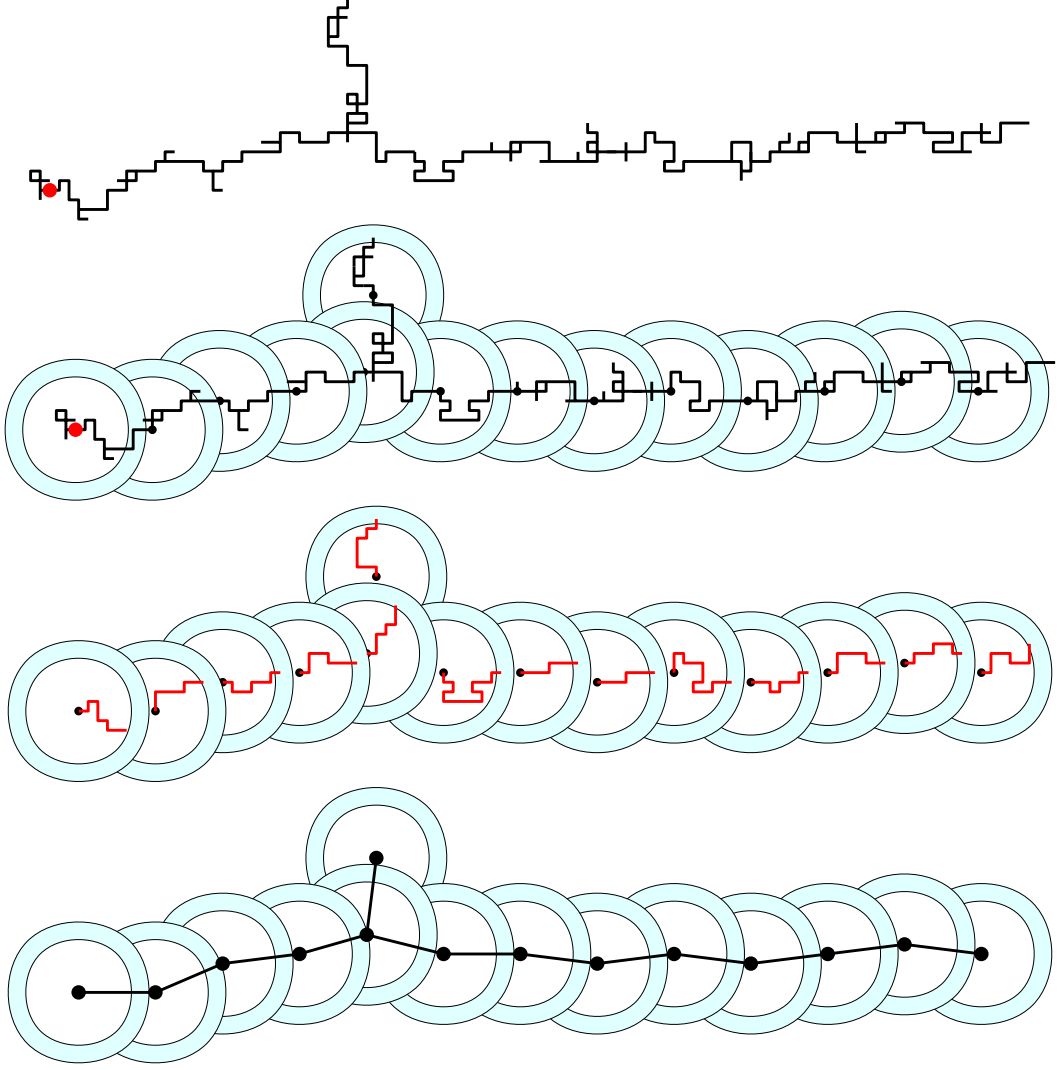

FIGURE 17. From top to bottom: a realization of \mathcal{C}_0 (0 is in red); the cells of the associated coarse-graining; the connections implied by the presence of the cells; the skeleton (in black).

Note that the wanted probabilities are zero whenever $A \cap \Delta_K$ does not contain a path going from 0 to $\partial^{\text{in}} \Delta_K$.

Proof. By the definition of \mathcal{U} , the ratio weak mixing property (Theorem 4) and monotonicity:

$$\begin{aligned}
 \Phi_{[\Delta_K \cap A]_{\ln(K)^2}}^{1,1} (0 \xleftrightarrow{\Delta_K \cap A} \partial^{\text{in}} \Delta_K) &\leq (1 + CK^2 e^{-c' \ln(K)^2}) \Phi_{[\Delta_K \cap A]_{\ln(K)^2}}^{0,0} (0 \xleftrightarrow{\Delta_K \cap A} \partial^{\text{in}} \Delta_K) \\
 &\leq 2\Phi(0 \xleftrightarrow{\Delta_K} \partial^{\text{in}} \Delta_K) \\
 &\leq C \sum_{x \in \partial^{\text{in}} \Delta_K} e^{-\nu(x)(1+o_K(1))} = C |\partial^{\text{in}} \Delta_K| e^{-K(1+o_K(1))}
 \end{aligned}$$

as soon as K is large enough. \square

As a direct consequence of Lemma 7.2 and of the definition of the coarse-graining procedure, one gets the following:

Lemma 7.3 (Energy bound). *There exists $K_0 \geq 0$ such that, for any $K \geq K_0$, and any $\mathcal{T} \subset \mathbb{Z}^2$,*

$$\Phi(\text{Sk}_V(\mathcal{C}_0) = \mathcal{T}) \leq e^{-K|\mathcal{T}|(1+o_K(1))},$$

where the o_K is uniform over \mathcal{T}

Indeed, every new vertex of the tree away from the boundary induces a connection of the form (36) in the complement of the neighbourhood of the previously explored vertices (See Fig. 17). We do not provide further details, see for example [CIV08, Display (2.2)] for the implementation of the bound.

Recall that $\text{Sk}(C)$ is a tree rooted at 0. Denote by Tree_N the set of all possible values of $\text{Sk}(C)$ if $|\text{Sk}(C)| = N$. We now state a general combinatorial lemma that bounds the size of Tree_N .

Lemma 7.4 (Entropy bound). *There exists a universal $c > 0$ such that*

$$|\text{Tree}_N| \leq e^{c \ln(K)N} = K^{cN}.$$

This Lemma follows from the fact that, for some $C \geq 0$, the size of Tree_N is smaller or equal to the number of N -vertex connected sub-trees of the CK^2 -regular tree containing 0. The latter is bounded by $e^{c \ln(K)N}$ for some $c > 0$ by Kesten's argument [Kes82, page 85].

7.5. Input from [CIV08, CIV03]: skeleton and cluster cone-points. The main result that we import from [CIV08, CIV03] is [CIV08, Theorem 2.1] that describes a typical geometry of skeletons ([CIV08] builds on [CIV03]). The result in [CIV08] is stated for the FK-percolation, but the proof is general and relies only on Lemmata 7.3 and 7.4.

Lemma 7.5 (Skeleton Cone-points). *Let (Ω, \mathcal{F}, P) be a probability space, $v \in \mathbb{Z}^2$, and let \mathcal{C} be a random finite connected subset of \mathbb{Z}^2 containing v defined on (Ω, \mathcal{F}, P) . Suppose that for any tree \mathcal{T} in the image of Sk , $K \geq 0$,*

$$P(\text{Sk}(\mathcal{C} - v) = \mathcal{T}) \leq e^{-K|\mathcal{T}|(1+o_K(1))}.$$

Then, for any $\delta > 0$, there are $c_1, c_2 > 0$, $K_0 \geq 0$ such that, for any $K \geq K_0$, $t \in \partial\mathcal{W}$, $w \in \mathbb{Z}^2$,

$$e^{t \cdot (w-v)} P(w \in \mathcal{C}, |\text{CPts}_{t,\delta}(\text{Sk}(\mathcal{C} - v))| \leq c_1|w-v|/K) \leq e^{-c_2|w-v|}.$$

Moreover, by monotonicity, c_1, c_2, K_0 can be taken uniform over $\delta \geq \delta_0 > 0$.

Remark 7.6. *Note that the Lemma holds directly when w is not in $v + \mathcal{Y}_{t,\delta}^\blacktriangleleft$: then $P(w \in \mathcal{C}) \leq e^{-\nu(w-v)(1+o(1))}$ (as the event $w \in \mathcal{C}$ implies that $|\text{Sk}(\mathcal{C})| \geq \nu(w-v)/K$) but $t \cdot (w-v) - \nu(w-v) \leq -\delta\nu(w-v)$ by definition of $\mathcal{Y}_{t,\delta}^\blacktriangleleft$.*

The second result we import is a simple but notationally heavy use of finite energy. One can find two different implementations of this argument in [CIV08, Section 2.9], and [AOV24, Section 6.1]. Introduce a small variation on the notion of cone-points which will be convenient later (one could work directly with cone-points, but the equations become a bit heavier).

Recall $e_1 = (1, 0)$, $e_2 = (0, 1)$.

Definition 8 (Regular Cone-points). Let $C = (V, E)$ be a connected sub-graph of $(\mathbb{Z}^2, \mathbb{E})$. Say that $v \in V$ is a *regular (t, δ) -cone-point* of C (see Fig. 18) if it is a (t, δ) -cone-point of V and, if $\{\pm e_1\} \cap \mathcal{Y}_{t,\delta}^\blacktriangleleft \neq \emptyset$, $\{v, v + e_1\}, \{v, v - e_1\} \in E$ and $\{v, v + e_2\}, \{v, v - e_2\} \notin E$. Denote $\text{rCPts}_{t,\delta}(C)$ the set of (t, δ) -regular cone-points of C .

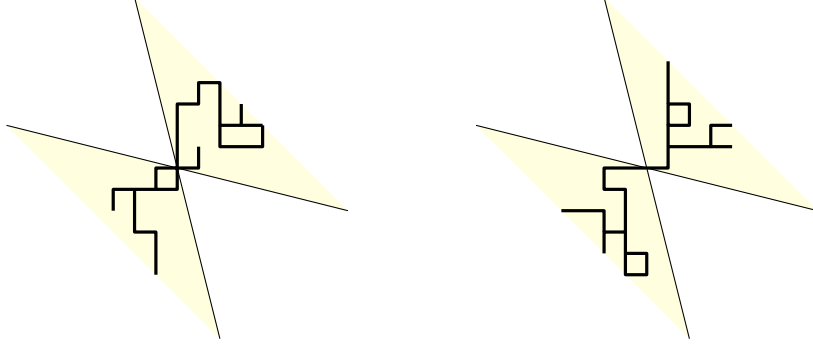

FIGURE 18. Left: a cone-point that is *not* regular. Right: a regular cone-point.

Note that when $\mathcal{Y}_{t,\delta}^\blacktriangleleft$ contains exactly one element of $\{\pm e_1, \pm e_2\}$, all cone-points are necessarily regular.

The idea for going from Lemma 7.5 to the next lemma is simple: when $v \leftrightarrow w$, up to an exponentially small error, there must be at least $c|v - w|/K$ cone-points of the skeleton by Lemma 7.5. Up to another exponentially small error, a positive fraction of these cone-points must then be regular cone-points of \mathcal{C} by uniform finite energy.

Lemma 7.7 (Cluster Cone-points). *Let (Ω, \mathcal{F}, P) be probability space, $v \in \mathbb{Z}^2$, and $\omega : \Omega \rightarrow \{0, 1\}^\mathbb{E}$ be a bond percolation random variable. The cluster of v in ω is denoted by $\mathcal{C} = \mathcal{C}(\omega)$. Suppose that*

- ω has uniform finite energy (for opening and closing edges): for $e \in \mathbb{E}$, let \mathcal{F}_{e^c} be the sigma-algebra generated by $(\omega_f)_{f \neq e}$. Then, there is $\epsilon \in (0, 1)$ such that for every $e \in \mathbb{E}$,

$$\epsilon < E(\omega_e | \mathcal{F}_{e^c}) < 1 - \epsilon,$$

P -almost surely.

- the conclusion of Lemma 7.5 holds for \mathcal{C} .

Then, for any $\delta > 0$, there are $c'_1, c'_2 > 0$, $L_0 \geq 1$ such that, for any $t \in \partial\mathcal{W}$ such that the interior of $\mathcal{Y}_{t,\delta}^\blacktriangleleft$ contains an element of $\{\pm e_1, \pm e_2\}$, and any $w \in \mathbb{Z}^2 \cap \mathcal{Y}_{t,\delta}^\blacktriangleleft$ with $|w - v| \geq L_0$,

$$e^{t \cdot (w-v)} P(w \in \mathcal{C}, |\text{rCPts}_{t,\delta}(\mathcal{C})| \leq c'_1 |w - v|) \leq e^{-c'_2 |w-v|}.$$

By monotonicity, c'_1, c'_2, L_0 can be taken uniform over $\delta \geq \delta_0 > 0$.

See [CIV08, Section 2.9] or [AOV24, Section 6.1] for two different proofs of Lemma 7.7 via local surgery arguments.

For these two lemmas we can deduce our main cone-point estimate.

Theorem 10. *Let $\delta \in (0, 1)$. There exist $C \geq 0, c_1, c_2 > 0$ such that for any $t \in \partial\mathcal{W}$ such that the interior of $\mathcal{Y}_{t,\delta}^\blacktriangleleft$ contains an element of $\{\pm e_1, \pm e_2\}$, and any $x \in \mathbb{Z}^2$,*

$$e^{t \cdot x} \Phi(0 \leftrightarrow x, |\text{rCPts}_{t,\delta}(\mathcal{C}_0)| \leq c_1 |x|) \leq C e^{-c_2 |x|}.$$

Proof. When $x \notin \mathcal{Y}_{t,\delta}^\blacktriangleleft$, the claim is trivial, see Remark 7.6. For $x \in \mathcal{Y}_{t,\delta}^\blacktriangleleft$, the result follows from Lemmata 7.5, and 7.7: Lemma 7.3 provides the required bound on the probability of a given skeleton, and the model has finite energy, which are the needed hypotheses for Lemmata 7.5, and 7.7. \square

This concludes our preparations. We are now ready to attack the proof of Theorem 9.

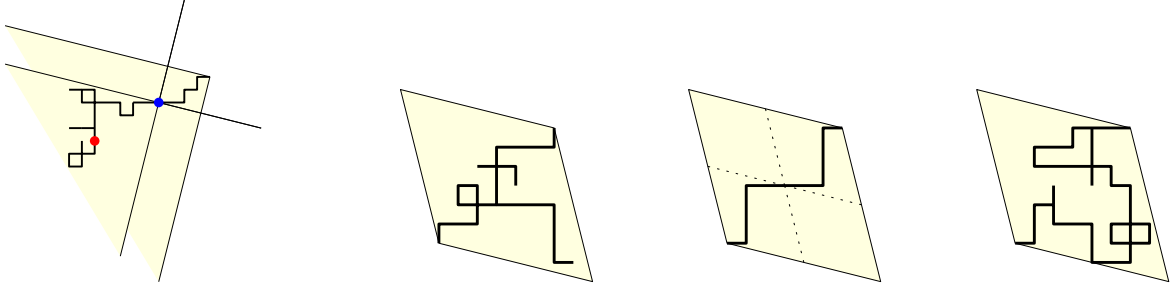

FIGURE 19. From left to right. 1) Backward confined graph which is not irreducible: the graph can be written as the concatenation of two graphs so that the concatenation point is a regular cone-point. 2) The graph is not irreducible as its endpoints will not generate regular cone-points when concatenated. 3) The graph is not irreducible as it contains a regular cone-point. 4) An irreducible graph.

7.6. Proof of Theorem 9 part I: Cone-points and pre-renewal structure. We now fix $s_0 \in \mathbb{S}^1$, $t_0 \in \partial\mathcal{W}$ dual to s_0 , $\delta \in (0, 1)$ such that the interior of $\mathcal{Y}_{t_0, \delta}^\blacktriangleleft$ contains and element of $\{\pm e_1, \pm e_2\}$, and we set

$$\begin{aligned} \text{rCpts} &\equiv \text{rCpts}_{t_0, \delta}, & \mathcal{Y}^\blacktriangleleft &\equiv \mathcal{Y}_{t_0, \delta}^\blacktriangleleft, & \mathcal{Y}^\blacktriangleright &\equiv \mathcal{Y}_{t_0, \delta}^\blacktriangleright, \\ \mathfrak{B}_L &\equiv \mathfrak{B}_L(t_0, \delta), & \mathfrak{B}_R &\equiv \mathfrak{B}_R(t_0, \delta), & \mathfrak{A} &\equiv \mathfrak{A}(t_0, \delta). \end{aligned} \quad (37)$$

From Theorem 10, typical long clusters have many cone-points: having a non-linear (in $|x|$), number of cone-points is exponentially more unlikely than $\{x \in \mathcal{C}_0\}$. The idea is now to write a realization of \mathcal{C}_0 containing many cone-points as a concatenation of “irreducible graphs” by splitting it at its regular cone-points. This will lead to a structure that, graphically, looks like a renewal structure. This is what we will do in this subsection. The last step will then be to extract a *real* renewal structure (at the level of the measure) from this graphical one. This will be Subsection 7.7. To this end, introduce the notion of *irreducible graphs*. Let $e = \{\pm e_1\} \cap \mathcal{Y}^\blacktriangleleft$ if the intersection is not empty, and $e = \{\pm e_2\} \cap \mathcal{Y}^\blacktriangleleft$ else. Say that

- A marked backward-confined graph (γ_L, v^*) is *irreducible* if the diamond $\text{Diamond}(v^*, \mathbf{b}(\gamma_L))$ does not contains a regular cone-point of γ_L , and $\mathbf{b}(\gamma_L)$ is a regular cone-point of the graph $\gamma_L \cup \{\mathbf{b}(\gamma_L), \mathbf{b}(\gamma_L) + e\}$ (see Fig. 19).
- A marked forward-confined graph (γ_R, v^*) is *irreducible* if the diamond $\text{Diamond}(\mathbf{f}(\gamma_R), v^*)$ does not contains a regular cone-point of γ_R , and $\mathbf{f}(\gamma_R)$ is a regular cone-point of the graph $\gamma_R \cup \{\mathbf{f}(\gamma_R), \mathbf{f}(\gamma_R) - e\}$.
- A diamond-confined graph γ is *irreducible* if it does not contains a regular cone-point, and if $\mathbf{f}(\gamma), \mathbf{b}(\gamma)$ are regular cone-points of $\gamma \cup \{\{\mathbf{f}(\gamma), \mathbf{f}(\gamma) - e\}, \{\mathbf{b}(\gamma), \mathbf{b}(\gamma) + e\}\}$ (see Fig. 19).

In words: irreducible graphs are those that cannot be written as the concatenation of two non-trivial graphs, with the concatenation point being a regular cone-point, and so that the concatenation of two irreducible graphs leads to a regular cone-point. We will denote the sets of irreducible marked graphs in, respectively, $\mathfrak{B}_L, \mathfrak{B}_R, \mathfrak{A}$ by

$$\mathfrak{B}_L^{\text{ir}}, \quad \mathfrak{B}_R^{\text{ir}}, \quad \mathfrak{A}^{\text{ir}}.$$

For $x \in \mathcal{Y}^\blacktriangleleft \cap \mathbb{Z}^2$, and $C_0 \ni x$ a realization of \mathcal{C}_0 containing at least two regular cone points v_1, v_2 with $0 \in v_i + \mathcal{Y}^\blacktriangleright$, $x \in v_i + \mathcal{Y}^\blacktriangleleft$, we can introduce the splitting into

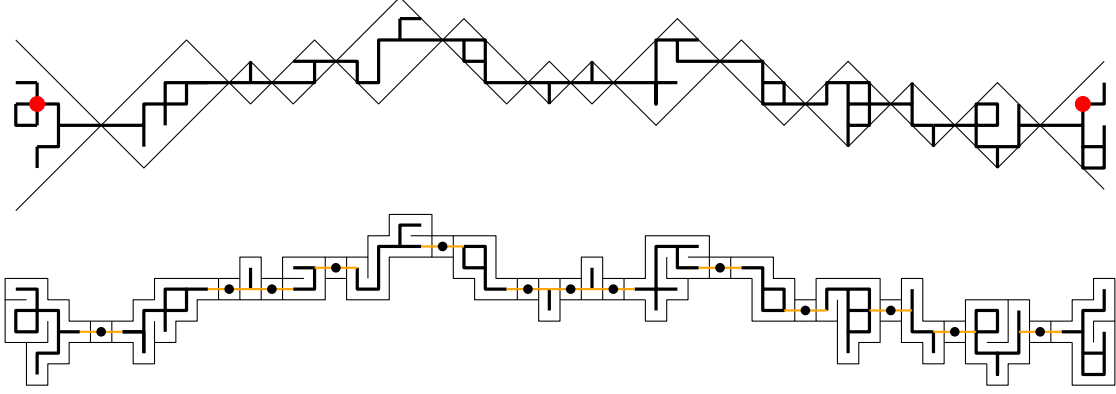

FIGURE 20. Top: A cluster with its irreducible decomposition. Bottom: the corresponding percolation events. Bold black edges are open in ω_τ (hence also in $\omega_{\tau\tau'}$); golden edges are closed in ω_τ but open in $\omega_{\tau\tau'}$; thin lines are the dual of edges that are closed in ω_τ , but for which the state of $\omega_{\tau\tau'}$ is not prescribed.

irreducible components:

$$C_0 = \eta_L \sqcup \eta_1 \sqcup \cdots \sqcup \eta_M \sqcup \eta_R,$$

where $M \geq 1$, $(\eta_L, 0)$, (η_R, x) , η_1, \dots, η_M are all irreducible, confined, (marked) graphs, and \sqcup means disjoint union of edges (there are sites overlap at cone-points). Now, as mentioned in the end of Section 7.1, there is a bijection between pairs $(\tilde{\gamma}, v) \in \mathfrak{A} \times \mathbb{Z}^2$ and diamond-confined connected graphs (translate $\tilde{\gamma}$ by v to obtain the graph $\gamma = v + \tilde{\gamma}$). Similar considerations hold for marked forward/backward confined connected graphs. In particular, for η_i in the above decomposition, there is a unique $w_i \in \mathbb{Z}^2$ and a unique $\tilde{\eta}_i \in \mathfrak{A}^{\text{ir}}$ such that $\eta_i = w_i + \tilde{\eta}_i$. Similarly for η_L, η_R . As the marked point of η_L is 0, one has directly

$$w_L = 0, \quad w_1 = X(\tilde{\eta}_L), \quad w_2 = X(\tilde{\eta}_L \circ \tilde{\eta}_1), \dots \quad w_R = X(\tilde{\eta}_L \circ \tilde{\eta}_1 \circ \dots \circ \tilde{\eta}_M),$$

and the equivalent writing of C_0 :

$$\eta_L \sqcup \eta_1 \sqcup \cdots \sqcup \eta_M \sqcup \eta_R = \tilde{\eta}_L \circ \tilde{\eta}_1 \circ \dots \circ \tilde{\eta}_M \circ \tilde{\eta}_R, \quad X(\tilde{\eta}_L \circ \tilde{\eta}_1 \circ \dots \circ \tilde{\eta}_R) = x,$$

with $\tilde{\eta}_1, \dots, \tilde{\eta}_M \in \mathfrak{A}^{\text{ir}}$, $\tilde{\eta}_L \in \mathfrak{B}_L^{\text{ir}}$, and $\tilde{\eta}_R \in \mathfrak{B}_R^{\text{ir}}$.

By our definition of “regular cone points”, each $\tilde{\eta} \in \mathfrak{A}^{\text{ir}}$ contains a unique edge incident to $\mathbf{f}(\tilde{\eta})$, and the same for $\mathbf{b}(\tilde{\eta})$. Denote these edges $\mathbf{f}_e(\tilde{\eta})$, $\mathbf{b}_e(\tilde{\eta})$.

For $\tilde{\eta}, \tilde{\eta}_L, \tilde{\eta}_R$ as above, and $v \in \mathbb{Z}^2$, introduce the percolation events $A_v(\tilde{\eta})$ to be the event that

- the edges in $(v + \tilde{\eta} \setminus \{\mathbf{f}_e(\tilde{\eta}), \mathbf{b}_e(\tilde{\eta})\})$ are open in ω_τ ,
- $v + \mathbf{f}_e(\tilde{\eta})$, and $v + \mathbf{b}_e(\tilde{\eta})$ are open in $\omega_{\tau\tau'}$ and closed in ω_τ ,
- $\partial^{\text{ex}}(v + \tilde{\eta})$ are closed in ω_τ .

Define the edges $\mathbf{b}_e(\tilde{\eta}_L)$, $\mathbf{f}_e(\tilde{\eta}_R)$, and the events $A_v(\tilde{\eta}_L)$, $A_v(\tilde{\eta}_R)$ similarly. See Fig. 20.

Claim 1. *One has*

$$\Phi(C_0 = \eta_L \sqcup \eta_1 \sqcup \cdots \sqcup \eta_M \sqcup \eta_R) = \left(\frac{\sinh(2J)}{e^{-2J} - e^{-2U}} \right)^{2(M+1)} \Phi(A_{w_L}(\tilde{\eta}_L), A_{w_1}(\tilde{\eta}_1), \dots, A_{w_R}(\tilde{\eta}_R)).$$

Proof. Under $C_0 = \eta_L \sqcup \eta_1 \sqcup \cdots \sqcup \eta_M \sqcup \eta_R$, every edge of the form $\mathbf{b}_e, \mathbf{f}_e$ always separates two distinct clusters of ω_τ . Swapping the state of such an edge from open to close in

ω_τ (while keeping $\omega_{\tau\tau'}$ open) brings a factor

$$\frac{w_\tau}{2w_{\tau\tau'}} = \frac{2e^{2U} \sinh(2J)}{2(e^{2(U-J)} - 1)},$$

by definition of the measure: closing e in ω_τ creates a cluster in ω_τ , hence the factor 2 in the denominator, and swaps the value of $(\omega_\tau(e), \omega'_{\tau\tau}(e))$ from $(1, 1)$, which has weight w_τ , to $(0, 1)$, which has weight $w_{\tau\tau'}$. The claim follows from the definition of $w_\tau, w_{\tau\tau'}$, see (6), the fact that there are $2(M+1)$ edges of the form $\mathbf{b}_e, \mathbf{f}_e$ (2 per regular cone-point, $M+1$ regular cone-points), and that the event obtained from $\{\mathcal{C}_0 = \eta_L \sqcup \eta_1 \sqcup \dots \sqcup \eta_M \sqcup \eta_R\}$ by closing the edges of the form $\mathbf{b}_e, \mathbf{f}_e$ is precisely $A_{w_L}(\tilde{\eta}_L) \cap A_{w_1}(\tilde{\eta}_1) \cap \dots \cap A_{w_R}(\tilde{\eta}_R)$. \square

For $\tilde{\eta}_L \in \mathfrak{B}_L^{\text{ir}}$, and $\tilde{\eta} \in \mathfrak{A}^{\text{ir}} \cup \mathfrak{B}_R^{\text{ir}}$, introduce the conditional weights

$$\begin{aligned} q_L(\tilde{\eta}_L) &:= \Phi(A_{w_L}(\tilde{\eta}_L)), \\ q(\tilde{\eta} \mid \tilde{\eta}_L, \tilde{\eta}_1, \dots, \tilde{\eta}_k) &:= c_{J,U} \Phi(A_{X(\tilde{\eta})}(\tilde{\eta}) \mid A_{w_L}(\tilde{\eta}_L), A_{w_1}(\tilde{\eta}_1), \dots, A_{w_k}(\tilde{\eta}_k)), \end{aligned} \quad (38)$$

where $\tilde{\eta} = \tilde{\eta}_L \circ \tilde{\eta}_1 \circ \dots \circ \tilde{\eta}_k$, and $c_{J,U} = \left(\frac{\sinh(2J)}{e^{-2J} - e^{-2U}}\right)^2$.

Using Claim 1, this leads to the following conditional weight decomposition:

$$\begin{aligned} \Phi(\mathcal{C}_0 = \tilde{\eta}_L \circ \tilde{\eta}_1 \circ \dots \circ \tilde{\eta}_M \circ \tilde{\eta}_R) \\ = q_L(\tilde{\eta}_L) q(\tilde{\eta}_1 \mid \tilde{\eta}_L) q(\tilde{\eta}_2 \mid \tilde{\eta}_L, \tilde{\eta}_1) \dots q(\tilde{\eta}_M \mid \tilde{\eta}_L, \dots, \tilde{\eta}_{M-1}). \end{aligned} \quad (39)$$

Let us describe informally the second part of the proof: one has represented the probability of a given cluster participating to the event $0 \leftrightarrow x$ as a product of *dependent* weights, which one can see as a product of conditional kernels (which are *not* probability kernels). The idea is now to represent this product of dependent kernels as a mixture of *independent* (factorized) kernels defined on diamond-confined graphs, which will then be suitably normalize by a factor $e^{t_0 \cdot X(\gamma)}$ to obtain probability kernels.

7.7. Proof of Theorem 9 part II: Mixing of weights and renewal structure.

We will use the same procedure as [AOV24, Section 7] with the tricks from [OV18, Appendix C] to compensate for the lack of monotonicity in the conditional kernels. We only describe the needed inputs, and will refer to [AOV24, Section 7] once we arrive at a stage where the remaining arguments is a copy-pasting of [AOV24, Section 7].

The first step is to prove that the conditional kernels of (39) have good mixing properties. This is the content of the next lemma.

Lemma 7.8. *With the notations and definitions of Subsection 7.6, there exist $\rho > 0, C \geq 0, c > 0$, such that*

- for every $\tilde{\eta} \in \mathfrak{B}_R^{\text{ir}} \cup \mathfrak{B}_L^{\text{ir}}$, one has that

$$\inf_{n \geq 0} \inf_{\tilde{\eta}_0 \in \mathfrak{B}_L^{\text{ir}}} \inf_{\tilde{\eta}_1, \dots, \tilde{\eta}_n \in \mathfrak{A}^{\text{ir}}} q(\tilde{\eta} \mid \tilde{\eta}_0, \dots, \tilde{\eta}_n) \geq \rho^{|\tilde{\eta}|}; \quad (40)$$

- for any $n, k, k' \geq 0$, any $\tilde{\eta}_0, \tilde{\eta}'_0 \in \mathfrak{B}_L^{\text{ir}}$, any $\tilde{\eta} \in \mathfrak{B}_R^{\text{ir}} \cup \mathfrak{A}^{\text{ir}}$, and any $\tilde{\eta}_1, \dots, \tilde{\eta}_{k+n}, \tilde{\eta}'_1, \dots, \tilde{\eta}'_{k'} \in \mathfrak{A}^{\text{ir}}$

$$\left| \frac{q(\tilde{\eta} \mid \tilde{\eta}_0, \tilde{\eta}_1, \dots, \tilde{\eta}_k, \tilde{\eta}_{k+1}, \dots, \tilde{\eta}_{k+n})}{q(\tilde{\eta} \mid \tilde{\eta}'_0, \tilde{\eta}'_1, \dots, \tilde{\eta}'_{k'}, \tilde{\eta}_{k+1}, \dots, \tilde{\eta}_{k+n})} - 1 \right| \leq C e^{-cn}. \quad (41)$$

Proof. The first point is by definition of q , see (38), and finite energy for Φ : the support of the event $A_{X(\tilde{\eta})}(\tilde{\eta})$ in (38) is of size at most $4|\tilde{\eta}|$. Focus on the second point. We implicitly always work in a large finite volume, $\Lambda_N = \{-N, \dots, N\}^2$, with $0, 1$

boundary conditions and take limits (everything being uniform over the large enough volume). Let $\tilde{\eta}'_{k'+i} \equiv \tilde{\eta}_{k+i}$ for $i = 1, \dots, n$. For $l \geq 0$, let

$$v_l = X(\tilde{\eta}_l), \quad v'_l = X(\tilde{\eta}'_l), \quad w_l = X(\tilde{\eta}_0 \circ \tilde{\eta}_1 \dots \circ \tilde{\eta}_l), \quad w'_l = X(\tilde{\eta}'_0 \circ \tilde{\eta}'_1 \dots \circ \tilde{\eta}'_l).$$

Let also

$$u_l = w_{k+l} - w_k = X(\tilde{\eta}_{k+1} \circ \dots \circ \tilde{\eta}_{k+l}) = w'_{k'+l} - w'_{k'}.$$

For $v \in \mathbb{Z}^2$, introduce the (translations of) the events corresponding to a given chain of irreducible graphs:

$$B_{L,v} = A_v(\tilde{\eta}_0) \cap \bigcap_{i=1}^k A_{v+w_{i-1}}(\tilde{\eta}_i), \quad B'_{L,v} = A_v(\tilde{\eta}'_0) \cap \bigcap_{i=1}^{k'} A_{v+w'_{i-1}}(\tilde{\eta}'_i),$$

$$B_v = \bigcap_{l=1}^n A_{v+u_l}(\tilde{\eta}_{k+l}), \quad B_{R,v} = A_{v+u_n}(\tilde{\eta}).$$

Now, that by definition of q (see (38)),

$$\frac{q(\tilde{\eta} \mid \tilde{\eta}_0, \tilde{\eta}_1, \dots, \tilde{\eta}_k, \tilde{\eta}_{k+1}, \dots, \tilde{\eta}_{k+n})}{q(\tilde{\eta} \mid \tilde{\eta}'_0, \tilde{\eta}'_1, \dots, \tilde{\eta}'_{k'}, \tilde{\eta}_{k+1}, \dots, \tilde{\eta}_{k+n})}$$

$$= \frac{\Phi(A_{w_{k+n}}(\tilde{\eta}) \mid A_0(\tilde{\eta}_0), A_{w_0}(\tilde{\eta}_1), \dots, A_{w_{k-1}}(\tilde{\eta}_k))}{\Phi(A_{w'_{k'+n}}(\tilde{\eta}) \mid A_0(\tilde{\eta}_0), A_{w'_0}(\tilde{\eta}_1), \dots, A_{w'_{n+k'-1}}(\tilde{\eta}'_{n+k'}))} = \frac{\Phi(B_{R,w_k} \mid B_{L,0} \cap B_{w_k})}{\Phi(B_{R,w'_k} \mid B'_{L,0} \cap B_{w'_k})}.$$

Then, using translation invariance of Φ ,

$$\frac{\Phi(B_{R,w_k} \mid B_{L,0} \cap B_{w_k})}{\Phi(B_{R,w'_k} \mid B'_{L,0} \cap B_{w'_k})} = \frac{\Phi(B_{R,0} \mid B_{L,-w_k} \cap B_0)}{\Phi(B_{R,0} \mid B'_{L,-w'_k} \cap B_0)}$$

$$= \frac{\Phi(B_{R,0} \cap B_{L,-w_k} \mid B_0)}{\Phi(B_{R,0} \mid B_0) \Phi(B_{L,-w_k} \mid B_0)} \frac{\Phi(B_{R,0} \mid B_0) \Phi(B'_{L,-w'_k} \mid B_0)}{\Phi(B'_{L,-w'_k} \cap B_{R,0} \mid B_0)}. \quad (42)$$

Now, $B_{R,0}$ is supported on the edges with at least one endpoint in $u_n + \mathcal{Y}^\blacktriangleleft$, denoted $E_{\blacktriangleleft}(u_n)$, whilst $B_{L,-w_k}, B'_{L,-w'_k}$ are supported on the edges with at least one endpoint in $-\mathcal{Y}^\blacktriangleleft$, denoted E_{\blacktriangleright} . Looking at (42), (41) will follow from

- (1) uniform upper and lower bounds on (42) (which deals with the small n case),
- (2) a suitable form of ratio mixing for $P(\cdot) := \Phi(\cdot \mid B_0)$ (which deals with the case n large enough).

Start with the uniform bound on the ratios.

Claim 2. *There exists $c \in [1, \infty)$ such that for any $n \geq 0$, any $v \in \mathbb{Z}^2$, any $\tilde{\eta}_1, \dots, \tilde{\eta}_n \in \mathfrak{A}^{\text{ir}}$ with $X(\tilde{\eta}_1 \circ \dots \circ \tilde{\eta}_n) = v$, any $F_{\blacktriangleright} \subset E_{\blacktriangleright}$, $F_{\blacktriangleleft} \subset E_{\blacktriangleleft}(v)$ finite, and any $\alpha \in \{(0,0), (0,1), (1,1)\}^{F_{\blacktriangleleft}}$,*

$$\frac{1}{c} \leq \inf_{\xi, \xi'} \frac{P(Y_{F_{\blacktriangleleft}} = \alpha \mid Y_{F_{\blacktriangleright}} = \xi)}{P(Y_{F_{\blacktriangleleft}} = \alpha \mid Y_{F_{\blacktriangleright}} = \xi')} \leq \sup_{\xi, \xi'} \frac{P(Y_{F_{\blacktriangleleft}} = \alpha \mid Y_{F_{\blacktriangleright}} = \xi)}{P(Y_{F_{\blacktriangleleft}} = \alpha \mid Y_{F_{\blacktriangleright}} = \xi')} \leq c,$$

where the sup/inf are over ξ, ξ' having positive probability, $P = \Phi(\cdot \mid B_0)$, and $Y_F = (\omega_\tau|_F, \omega_{\tau\tau'}|_F)$.

Proof. By symmetry of the expression, it is sufficient to prove the upper bound. Let $M \geq 1$ be a large enough integer and $\Lambda_M = \{-M, \dots, M\}^2$, $E_M = \mathbb{E}_{\Lambda_M}$. Let ξ, ξ' have positive P -probability. Then, there are non-empty events $D_L, D_{L0}, D'_L, D'_{L0}$,

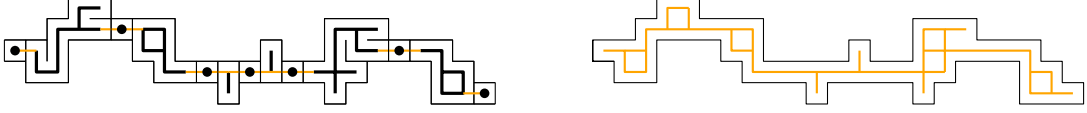

FIGURE 21. Black edges have state $(1, 1)$, gold ones have state $(0, 1)$, thin lines are dual to edges where ω_τ is 0. Left: the percolation event one conditions on. Right: the boundary conditions it effectively imposes.

$D_{B_0}, D_{BR}, D_{R_0}, D_R$ with D_L, D'_L supported on $E_{\triangleright} \setminus \mathbb{E}_{\Lambda_M}$, D_{RB}, D_R supported on $E_{\triangleleft} \setminus \mathbb{E}_{\Lambda_M}$, and $D_{L_0}, D'_{L_0}, D_{B_0}, D_{R_0}$ supported on \mathbb{E}_{Λ_M} , such that

$$\begin{aligned} B_0 &= D_{B_0} \cap D_{BR}, & \{Y_{F_{\triangleleft}} = \alpha\} &= D_{R_0} \cap D_R, \\ \{Y_{F_{\triangleright}} = \xi\} &= D_L \cap D_{L_0}, & \{Y_{F_{\triangleright}} = \xi'\} &= D'_L \cap D'_{L_0}. \end{aligned}$$

Now, by finite energy applied to lower bound the probability of the events with supported in \mathbb{E}_{Λ_M} conditionally on the others, one has that for some $c \in (0, \infty)$,

$$\begin{aligned} &\frac{P(Y_{F_{\triangleleft}} = \alpha \mid Y_{F_{\triangleright}} = \xi)}{P(Y_{F_{\triangleleft}} = \alpha \mid Y_{F_{\triangleright}} = \xi')} \\ &= \frac{\Phi(D_{R_0} \cap D_R \cap D_{L_0} \cap D_L \cap D_{B_0} \cap D_{BR}) \Phi(D'_{L_0} \cap D'_L \cap D_{B_0} \cap D_{BR})}{\Phi(D_{L_0} \cap D_L \cap D_{B_0} \cap D_{BR}) \Phi(D_{R_0} \cap D_R \cap D'_{L_0} \cap D'_L \cap D_{B_0} \cap D_{BR})} \\ &\leq \frac{\Phi(D_R \cap D_L \cap D_{BR}) \Phi(D'_L \cap D_{BR})}{\Phi(D_L \cap D_{BR}) \Phi(D_R \cap D'_L \cap D_{BR})} e^{cM^2}. \end{aligned}$$

But, by exponential ratio weak mixing (Theorem 4), for M large enough (depending only on the angular aperture of $\mathcal{Y}^\blacktriangleleft$),

$$\frac{\Phi(D_L \cap D_R \cap D_{BR})}{\Phi(D'_L \cap D_R \cap D_{BR})} \leq \frac{\Phi(D_L) \Phi(D_R \cap D_{BR})}{\Phi(D'_L) \Phi(D_R \cap D_{BR})} \frac{1 + e^{-cM}}{1 - e^{-cM}} \leq 2 \frac{\Phi(D_L)}{\Phi(D'_L)},$$

and

$$\frac{\Phi(D'_L \cap D_{BR})}{\Phi(D_L \cap D_{BR})} \leq \frac{\Phi(D'_L) \Phi(D_{BR})}{\Phi(D_L) \Phi(D_{BR})} \frac{1 + e^{-cM}}{1 - e^{-cM}} \leq 2 \frac{\Phi(D'_L)}{\Phi(D_L)}.$$

This concludes the proof of the claim. \square

Divide the proof of ratio mixing into two claims. We start by proving a mixing bound for P . We will use the following observation: let γ be the simple closed dual path surrounding the connected graph $\tilde{\eta}_1 \circ \dots \circ \tilde{\eta}_n$. Let $*\gamma$ be the set of primal edges that are crossed by γ , and denote V_γ the set of sites surrounded by γ . Then,

$$P|_{\mathbb{E} \setminus \mathbb{E}_{V_\gamma}} = \text{ATRC}_{\mathbb{E} \setminus \mathbb{E}_{V_\gamma}}^{1,1} (|\omega_\tau|_{*\gamma} = 0) = \text{ATRC}_{\mathbb{E} \setminus \mathbb{E}_{V_\gamma}}^{0,1} (|\omega_\tau|_{*\gamma} = 0), \quad (43)$$

where $\omega_\tau|_{*\gamma}$ is the restriction of ω_τ to $*\gamma$, see Fig. 21.

For $\tilde{\eta}_1, \dots, \tilde{\eta}_n, u_1, \dots, u_n$ as before, let $E_{\epsilon, \times}(\tilde{\eta}_1, \dots, \tilde{\eta}_n)$ be the edges with both endpoints in $\mathbb{R}^2 \setminus ((u_{\lceil n/3 \rceil} + \mathcal{Y}_{t_0, \delta + \epsilon}^\blacktriangleright) \cup (u_{\lfloor 2n/3 \rfloor} + \mathcal{Y}_{t_0, \delta + \epsilon}^\blacktriangleleft))$ (t_0, δ are fixed in (37)).

Claim 3. *For any $\epsilon > 0$, there exist $n_0 \geq 1, C \geq 0, c > 0$ such that, for any $n \geq n_0$, any $\tilde{\eta}_1, \dots, \tilde{\eta}_n \in \mathfrak{A}^{\text{tr}}$, any finite sets of edges $F_{\triangleright} \subset E_{\triangleright}, F_{\triangleleft} \subset E_{\triangleleft}, F_{\times} \subset E_{\epsilon, \times}(\tilde{\eta}_1, \dots, \tilde{\eta}_n)$, any $F_1 \in \{F_{\triangleright}, F_{\triangleleft}, F_{\times}\}$, and any $\xi, \xi' \in \{(0, 0), (0, 1), (1, 1)\}^{F_2}$, where $F_2 = (F_{\triangleright} \cup F_{\triangleleft} \cup F_{\times}) \setminus F$,*

$$d_{\text{TV}}(P(X_{F_1} \in \cdot \mid X_{F_2} = \xi), P(X_{F_1} \in \cdot \mid X_{F_2} = \xi')) \leq C e^{-cn},$$

where P, X are defined as in Claim 2.

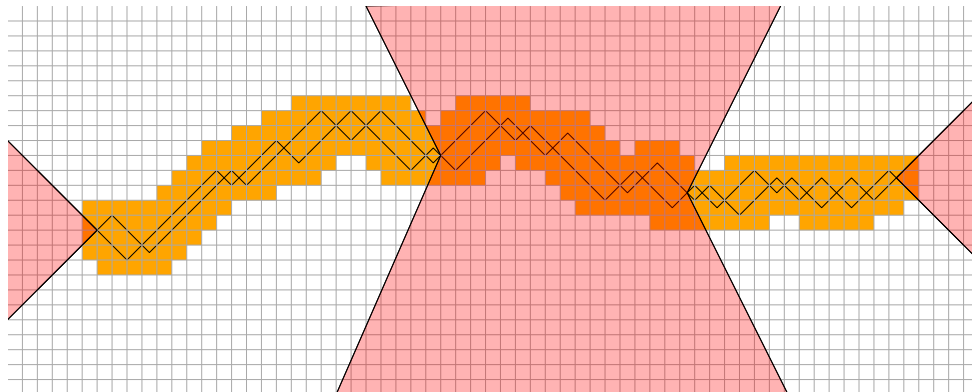

FIGURE 22. The grey grid represent the blocks of the block-percolation of Theorem 8. The orange squares have a strictly smaller than one probability to be open. The white squares have a probability as small as wanted to be open. The red regions represent $E_{\triangleright}, E_{\epsilon, \times}, E_{\triangleleft}$.

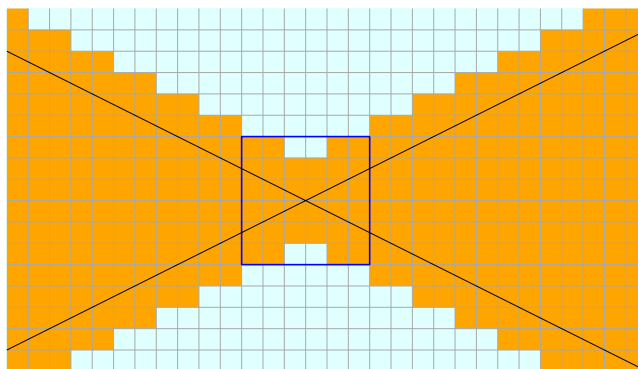

FIGURE 23. The grey grid represent the blocks of the block-percolation of Theorem 8. The orange squares have a strictly smaller than one probability to be open. The light blue squares have a probability as small as wanted to be open. By exponential decay in the blue blocks, a positive density of bottleneck have the property that the two orange sides of the blue square are not connected in the blue blocks. Then, with positive probability, the blocks in the square are closed, cutting the orange chain at that bottleneck.

Proof. The idea is simple but the details of the percolation estimate are a bit tedious to write down, so we only sketch the percolation argument. Looking at (43), $P|_{\mathbb{E} \setminus \mathbb{E}_{V_\gamma}}$ has the l -path decoupling property of Section 6.1 (it falls in the family of ATRC measure for which Theorem 8 applies). One can therefore use Theorem 8 to obtain the claim. Indeed, one can bound the wanted total variation distance with a connection probability in a Bernoulli block percolation model. The model one compares with is at worse of the type depicted on Fig. 22. The $n/3$ cone-points between the different regions each provide an opportunity to disconnect F_1 from F_2 : each induce a bottleneck in the orange chain illustrated on Fig. 23, and each bottleneck gives a positive probability to disconnect F_1 from F_2 . \square

We then turn this into ratio mixing using Appendix A.1.

Claim 4. *There exists $C \geq 0, c > 0, n_0 \geq 1$ such that for any $n \geq n_0$, any $v \in \mathbb{Z}^2$, any $\tilde{\eta}_1, \dots, \tilde{\eta}_n \in \mathfrak{A}^{\text{ir}}$ with $X(\tilde{\eta}_1 \circ \dots \circ \tilde{\eta}_n) = v$, any $F_{\triangleright} \subset E_{\triangleright}, F_{\triangleleft} \subset E_{\triangleleft}(v)$ finite, and any*

$$\alpha \in \{(0, 0), (0, 1), (1, 1)\}^{F_{\triangleleft}},$$

$$\sup_{\xi, \xi'} \left| \frac{P(X_{F_{\triangleleft}} = \alpha \mid X_{F_{\triangleright}} = \xi)}{P(X_{F_{\triangleleft}} = \alpha \mid X_{F_{\triangleright}} = \xi')} - 1 \right| \leq C e^{-cn},$$

where the sup is over ξ, ξ' having positive probability, P, X are defined as in Claims 2, and 3.

Proof. The proof will be an application of Lemma A.1. Recall (43).

Let $1 - \delta > \epsilon > 0$, and let $E_{\times} = E_{\epsilon, \times}(\tilde{\eta}_1, \dots, \tilde{\eta}_n)$. We apply Lemma A.1 with

- $\Omega_1 = \{(0, 0), (0, 1), (1, 1)\}^{F_{\triangleleft}}, \Omega_2 = \{(0, 0), (0, 1), (1, 1)\}^{E_{\times}},$
- $\mu = P(\cdot \mid X_{F_{\triangleright}} = \xi)_{F_{\triangleleft} \sqcup E_{\times}}, \nu = P(\cdot \mid X_{F_{\triangleright}} = \xi')_{F_{\triangleleft} \sqcup E_{\times}},$
- $D \subset \Omega_2$ is the event that there is an open path in $\omega_{\tau\tau'}$ from the top boundary of Λ_N (the implicit finite volume we work in) to its bottom boundary staying in E_{\times} , and that there is a dual path of open edges in ω_{τ}^* from the top boundary of Λ_N to its bottom boundary using only edges dual to edges in E_{\times} .

The hypotheses of Lemma A.1 hold with $\epsilon = e^{-cn}$ (when n is large enough) by Claim 3, and the uniform exponential decay of $\omega_{\tau\tau'}, \omega_{\tau}$ (Theorem 5). \square

This concludes the proof of (41). \square

This Lemma is the needed input to put ourself in the framework of [AOV24, Section 7]. Let us describe the needed modifications (which all take place in the beginning of the argument). The main difference is that our conditional weights q are not monotonic, we thus need to define the p_k 's used there in a slightly different way.

For $k > l \geq 1$, $\tilde{\eta}_0 \in \mathfrak{B}_L^{\text{ir}}, \tilde{\eta}_1, \dots, \tilde{\eta}_{k-1} \in \mathfrak{A}^{\text{ir}}$, and $\tilde{\eta} \in \mathfrak{A}^{\text{ir}} \cup \mathfrak{B}_R^{\text{ir}}$, set

$$a_0(\tilde{\eta} \mid \tilde{\eta}_0, \dots, \tilde{\eta}_{k-1}) \equiv a_0(\tilde{\eta}) = \inf_{n \geq 0} \inf_{\zeta_0 \in \mathfrak{B}_L^{\text{ir}}} \inf_{\zeta_1, \dots, \zeta_n \in \mathfrak{A}^{\text{ir}}} q(\tilde{\eta} \mid \zeta_0, \zeta_1, \dots, \zeta_n),$$

$$a_k(\tilde{\eta} \mid \tilde{\eta}_0, \dots, \tilde{\eta}_{k-1}) = q(\tilde{\eta} \mid \tilde{\eta}_0, \dots, \tilde{\eta}_{k-1}),$$

and

$$\begin{aligned} a_l(\tilde{\eta} \mid \tilde{\eta}_0, \dots, \tilde{\eta}_{k-1}) &\equiv a_l(\tilde{\eta} \mid \tilde{\eta}_{k-l}, \dots, \tilde{\eta}_{k-1}) \\ &= \inf_{n \geq 0} \inf_{\zeta_0 \in \mathfrak{B}_L^{\text{ir}}} \inf_{\zeta_1, \dots, \zeta_n \in \mathfrak{A}^{\text{ir}}} q(\tilde{\eta} \mid \zeta_0, \dots, \zeta_n, \tilde{\eta}_{k-l}, \dots, \tilde{\eta}_{k-1}) \end{aligned}$$

In words: a_k records the minimal mass given by a conditional probability to an irreducible graph for a fixed frozen ‘‘recent’’ past, and any ‘‘less recent’’ possible past. Introduce then the mass increments (p_k has the same definition domain as a_k)

$$p_0 = a_0, \quad p_k = a_k - a_{k-1}.$$

Note that by definition of the a_k 's, the p_k 's are always non-negative. This property is what compensates the lack of monotonicity of $q(\tilde{\eta} \mid \tilde{\eta}_0, \dots, \tilde{\eta}_{k-1})$ (monotonicity is property P6 there). One can now duplicate [AOV24, Section 7] to conclude the proof of Theorem 9 with the following adaptations: use the p_k 's defined above in place of the ones defined in [AOV24], and use Lemma 7.8 as a replacement for [AOV24, properties P5, P7] (these are the only properties used in the argument).

8. INVARIANCE PRINCIPLE FOR THE MODIFIED ATRC CLUSTER

8.1. Notations and main result of the section. As in Section 7, we will describe the geometry of the cluster of v_L under $\text{mATRC}_{n,m}(\cdot \mid v_L \leftrightarrow v_R)$ (defined in Section 4) using a coupling with a random walk bridge in such a way that the cluster is included in diamonds with endpoints at the random walk steps. We will focus on direction e_1

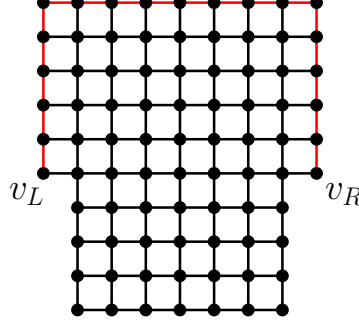

FIGURE 24. $\bar{V}_{n,m}$ (black circles), $E_{n,m}$ (black lines), and E_b^+ (red lines).

for simplicity, but the analysis can easily be adapted to other directions at the cost of slightly heavier notations. For notational convenience, we define the relevant objects with explicit n, m dependency, but will only stress the m dependence, as the n one is obvious (n will therefore usually be omitted from the notation).

Recall the setup of Section 4: let $\Lambda_{n,m} = \{-n, \dots, n\} \times \{-m, \dots, m\}$,

$$\begin{aligned} E_{n,m} &= \mathbb{E}_\Lambda \cup \{e \in \partial^{\text{edge}} \mathbb{E}_\Lambda : e \subset \mathbb{H}_+\}, \\ \bar{V}_{n,m} &= \mathbb{V}_{E_{n,m}} \cup \{(-n-1, m+1), (n+1, m+1)\}, \\ E_b^+ &= \{\{i, j\} \in \mathbb{E} : i, j \notin \Lambda, i, j \in \bar{V}_{n,m}\}, \end{aligned}$$

see Fig. 24.

Recall also

$$\partial_- \Lambda = \{i \in \partial^{\text{in}} \Lambda : i \in \mathbb{H}_-\}.$$

As in the previous section, $\Phi \equiv \text{ATRC}$. We will denote

$$\Phi_m \equiv \Phi_{n,m} = \text{mATRC}_{n,m}.$$

Φ_m is supported on $\Omega_m \equiv \Omega_{n,m} = \{(0,0), (0,1), (1,1)\}^{E_m} \times \{(0,0), (1,1)\}^{E_b^+}$. Denote also for $F \subset E_m \cup E_b^+$, and $(a, b) \in \Omega_m$,

$$\Phi_{m;F}^{a,b} := \Phi_m \left(\mid \omega_\tau(e) = a_e, \omega_{\tau\tau'}(e) = b_e \forall e \in F^c \right) \Big|_F \quad (44)$$

its conditional version. Recall its main properties (we will use them without referring to a precise statement each time):

- (1) The probability of a given pair $(a, b) \in \Omega_m$ is given by

$$\Phi_m(a, b) \propto \prod_{e \in E} 2^{a_e} (\mathbf{c} - 2)^{b_e - a_e} \prod_{e \in E_b^+} \left(\frac{2}{\mathbf{c}_b - 1} \right)^{a_e} \cdot 2^{\kappa_+(a)} \prod_{C \in \text{cl}(b)} (\mathbb{1}_{C \subset \Lambda_m} + \mathbf{c}_b^{\sum_{i \in \partial_- \Lambda_m \cap C} d_i})$$

where:

- $d_i = 1$ for all i in $\partial_- \Lambda_m$ but the lower corners, and equals 2 at the corners;
 - $\kappa_+(a)$ is the number of connected components in the graph (\bar{V}_m, a) ;
 - $\text{cl}(b)$ is the set of connected components in the graph (\bar{V}_m, b) .
- (2) Φ_m is strong-FKG (satisfies the FKG-lattice condition).
- (3) $\Phi_{m;E_m}^{a,b} \preceq \text{ATRC}_{E_m}^{1,1}$.

In particular, for any $F \subset \mathbb{E}_{\Lambda_{n-1, m-1}}$, $F' \subset E$, and any $(a, b) \in \Omega_m$ one has

$$\text{ATRC}_F^{0,0} \preceq \Phi_{m;F}^{a,b}, \quad \Phi_{m;F'}^{a,b} \preceq \text{ATRC}_{F'}^{1,1}. \quad (45)$$

For the lower comparison: use the monotonicity for Φ_m to closed edges in F^c and note that when all edges of F^c are closed, the measure on F is $\text{ATRC}_F^{0,0}$. The upper comparison follows from strong-FKG and $\Phi_m \preceq \text{ATRC}_E^{1,1}$.

Recall that $v_L = (-n - 1, 0)$ and $v_R = (n + 1, 0)$, and that we wish to study the cluster of v_L under $\Phi_m(\cdot | v_L \xleftrightarrow{\omega_\tau} v_R)$. For the sake of readability, all connections will be understood to take place in ω_τ if not specified otherwise. We denote $(\omega_\tau, \omega_{\tau'})$ a sample from Φ_m , and \mathcal{C} the cluster of v_L in the ω_τ marginal (see Section 4.4).

We will use the probabilistic description of long clusters from Theorem 9 with a suitable choice of cones. First, note that by symmetry the (unique by Theorem 9) $t \in \partial\mathcal{W}$ dual to e_1 is $t = \nu_1 e_1$. Then, by strict convexity and symmetry, the cones $\mathcal{Y}_{\nu_1 e_1, \delta}^\blacktriangleleft$ are invariant under reflection through $\{x : x_2 = 0\}$, and have an angular aperture continuous in δ , strictly increasing, which converges to 0 as $\delta \rightarrow 0$ and to π as $\delta \rightarrow 1$. In particular, for any $\theta \in (0, \pi/2)$ there is a unique $\delta \in (0, 1)$ such that $\mathcal{Y}_\theta^\blacktriangleleft = \mathcal{Y}_{\nu_1 e_1, \delta}^\blacktriangleleft$ where

$$\mathcal{Y}_\theta^\blacktriangleleft = \{x \in \mathbb{R}^2 : \tan(\theta)x_1 \geq |x_2|\}$$

is the symmetric cone with angular aperture 2θ . Similarly to Section 7, say that x is a θ -cone-point of A if $A \subset x + (\mathcal{Y}_\theta^\blacktriangleleft \cup \mathcal{Y}_\theta^\blacktriangleright)$. We (re-)introduce

$$\begin{aligned} \mathcal{Y}_\theta^\blacktriangleright &= -\mathcal{Y}_\theta^\blacktriangleleft, \quad \text{Diamond}_\theta(u, v) = (u + \mathcal{Y}_\theta^\blacktriangleleft) \cap (v + \mathcal{Y}_\theta^\blacktriangleright), \\ \text{CPts}_\theta(A) &= \{x \in A : x \text{ is a } \theta\text{-cone-point of } A\}. \end{aligned}$$

When omitted from the notation, θ is set to be $\pi/4$. Denote $\mathfrak{B}_L, \mathfrak{B}_R, \mathfrak{A}$ the sets of backward-confined, forward-confined, diamond-confined graphs (see Section 7.1) for $\theta = \pi/4$. Let then p_L, p_R, p be the measures given by Theorem 9 for $(\delta, \nu_1 e_1)$ with $\mathcal{Y}^\blacktriangleleft = \mathcal{Y}_{\nu_1 e_1, \delta}^\blacktriangleleft$. Denote \mathcal{Q} the positive measure (not probability measure) on pairs length + sequences of graphs given by

$$\mathcal{Q}(M; \gamma_L, \gamma_1, \dots, \gamma_M, \gamma_R) = C_{p_L}(\gamma_L) p_R(\gamma_R) \prod_{i=1}^M p(\gamma_i)$$

where C is the constant given by Theorem 9. It is worth stressing that whenever f vanishes when the displacement of $\gamma_L \circ \gamma_1 \circ \dots \circ \gamma_M \circ \gamma_R$ becomes larger than some constant, integrating f against \mathcal{Q} is just a finite sum. We will write

$$\begin{aligned} &\int d\mathcal{Q}f(M; \gamma_L, \gamma_1, \dots, \gamma_M, \gamma_R) \\ &= C \sum_{M \geq 0} \sum_{\gamma_L \in \mathfrak{B}_L} \sum_{\gamma_R \in \mathfrak{B}_R} \sum_{\gamma_1, \dots, \gamma_M \in \mathfrak{A}} f(M; \gamma_L, \dots, \gamma_R) p_L(\gamma_L) p_R(\gamma_R) \prod_{i=1}^M p(\gamma_i). \end{aligned} \quad (46)$$

Let $\gamma_1, \gamma_2, \dots$ be an i.i.d. sequence of random diamond-confined graphs with law p , and define

$$T_v = \inf\{k \geq 1 : X(\gamma_1 \circ \dots \circ \gamma_k) = v\},$$

where the inf of an empty set is set to be $+\infty$ by convention. Let Q_v be the law of $(\gamma_1, \gamma_2, \dots, \gamma_{T_v})$ conditioned on $\{T_v < \infty\}$.

The main Theorem of this section is the following ‘‘representation as a mixture of random walk bridges’’. From this result, it is mostly an exercise to prove the invariance principle, and it will be done in Section 8.6.

Theorem 11. *There are $c > 0, C_0 \geq 0, c_0 \geq 0, n_0 \geq 1$ such that for any $n \geq n_0, m \geq C_0 n$, there is a probability measure $\overline{\text{Me}}_{n,m}$ on $\mathfrak{B}_L \times \mathfrak{B}_R$ such that*

- (1) $\overline{\text{Me}}_{n,m}$ is supported on pairs of graphs with displacement sup-norm at most $c_0 \ln^2(n)$;
(2) for any f function of \mathcal{C} ,

$$\left| \sum_{\zeta_L, \zeta_R} \overline{\text{Me}}_{n,m}(\zeta_L, \zeta_R) E_{Q_{v(\zeta_L, \zeta_R)}}(f(v_L + \zeta_L \circ \gamma_1 \circ \dots \circ \gamma_M \circ \zeta_R)) - \Phi_m(f(\mathcal{C}) \mid v_L \leftrightarrow v_R) \right| \leq \|f\|_\infty e^{-c \ln(n)}$$

where $(\gamma_1, \gamma_2, \dots, \gamma_M) \sim Q_{v(\zeta_L, \zeta_R)}$, E_{Q_v} denotes expectation with respect to Q_v , and $v(\zeta_L, \zeta_R) = v_R - \mathbf{X}(\zeta_R) - v_L - \mathbf{X}(\zeta_L)$.

Remark 8.1. This theorem gives the existence of a coupling between the law of \mathcal{C} under $\Phi_m(\mid v_L \leftrightarrow v_R)$ and a product law on chains of diamond confined graphs, such that the chain and \mathcal{C} are equal with a probability going to 1 as $n \rightarrow \infty$. The law of the sequence of cone-points of this chain is then a random walk bridge, and the distance (e.g. Hausdorff) between the linear interpolation of this bridge and the actual cluster is at most a constant times the norm of the largest step. In Subsection 8.6 (Lemma 8.11), we prove that this linear interpolation converges to a Brownian Bridge under diffusive scaling and that the maximal step size is $C \ln^2(n)$ with probability going to 1 as $n \rightarrow \infty$. This therefore implies an invariance principle for the upper/lower envelopes of \mathcal{C} .

8.2. Basic properties of the measure. We start with some general observations on Φ_m before going to the heart of the argument. In the course of the proof, we will introduce several constants, denoted

$$c_0, c_1, \dots$$

They depend only on J, U . As this quantity appear several times, it is worthwhile to define it in advance

$$\bar{n}_1 = n - \lfloor c_1 \ln(n) \rfloor. \quad (47)$$

First, from Theorem 5, we can deduce the exponential decay for Φ_m .

Lemma 8.2. *There is $c > 0$ such that for any $n, m \geq 1$, any simply connected $F \subset E \cup E_b^+$, and any $x, y \in \mathbb{V}_F$,*

$$\sup_{\eta} \Phi_m(x \xleftrightarrow{F} y \mid \omega_\tau(e) = \eta(e) \forall e \in F^c) \leq e^{-c|x-y|}.$$

In particular, there is an integer $c_0 \geq 0$ such that for any $m \geq c_0 n$,

$$\Phi_m(\exists x \in \mathcal{C} : |x_2| \geq c_0 n) \leq e^{-3\nu_1 n}.$$

Proof. The second point follows from the first and a union bound. We focus on the first. The claim with $\Phi = \text{ATRC}$ replacing Φ_m is Theorem 5. In particular, by the stochastic domination (45), for any $F \subset E$,

$$\Phi_m(\cdot \mid \omega_\tau(e) = \eta(e) \forall e \in F^c) \preceq \text{ATRC}_F^{1,1} = \Phi(\mid \omega_\tau(e) = 1 \forall e \in F^c),$$

so the first equation holds for Φ_m when $F \cap E_b^+ = \emptyset$. The case where $F \cap E_b^+ \neq \emptyset$ is a simplification of the arguments of [Ale04, Section 2] ($F \cap E_b^+$ having a simpler geometry than what is treated in [Ale04, Section 2]). \square

Then, from 4, we obtain fast relaxation of Φ_m towards Φ .

Lemma 8.3. *There are $c > 0, C \geq 0$ such that for every $n, m \geq 2$, any $F \subset \mathbb{E}_{\Lambda_{n-1, m-1}}$, and any event A supported on F with $\Phi(A) > 0$,*

$$\left| \frac{\Phi_m(A)}{\Phi(A)} - 1 \right| \leq C \sum_{e \in F} e^{-cd_\infty(e, \Lambda_{n-1, m-1}^c)}.$$

In particular, there is $c_1 \geq 0, n_0 \geq 1$ such that for any $n \geq n_0, m \geq c_0 n + \ln^2(n)$, and any event B supported in $\mathbb{E}_{\Lambda_{\bar{n}_1, c_0 n}}$, one has

$$\frac{1}{2} \leq \frac{\Phi_m(B)}{\Phi(B)} \leq 2.$$

Proof. This follows from the stochastic domination (45) and from the exponential ratio weak mixing of ATRC (Theorem 4). \square

Recall that $\Lambda_{k,l} = \{-k, \dots, k\} \times \{-l, \dots, l\}$. Define

- $\text{Cross}_{k,l}^{\geq 2}$ the event that there is at least two disjoint clusters in $(\Lambda_{l,k}, \omega_\tau \cap \mathbb{E}_{\Lambda_{l,k}})$ crossing $\Lambda_{k,l}$ from left to right;
- $\text{Cross}_{k,l}^1$ the event that there is exactly one cluster in $(\Lambda_{l,k}, \omega_\tau \cap \mathbb{E}_{\Lambda_{l,k}})$ crossing $\Lambda_{k,l}$ from left to right.

Lemma 8.4. *There are $c > 0, n_0 \geq 1$, such that for any $n \geq n_0, m \geq \ln^2(n)$, $k \leq \min(m - \ln^2(n), n^2)$, one has*

$$\begin{aligned} \Phi_m(\text{Cross}_{\bar{n}_1, k}^{\geq 2}) &\leq 2(2k+1)^2 e^{-\nu_1 2n - cn}, \\ \Phi_m(\text{Cross}_{\bar{n}_1, k}^1) &\leq 2(2k+1)^2 e^{-\nu_1 2\bar{n}_1}, \end{aligned}$$

where \bar{n}_1 is defined in (47) (and c_1 is given by Lemma 8.3).

Proof. Note that the events $\text{Cross}_{\bar{n}_1, k}^{\geq 2}, \text{Cross}_{\bar{n}_1, k}^1$ are supported on $F_k \equiv \mathbb{E}_{\Lambda_{\bar{n}_1, k}}$. Given the constraints on k , one can apply Lemma 8.3 to reduce the problem to proving the same bound for Φ instead of Φ_m , (the cost for passing from Φ_m to Φ is the factor 2 in the claim). Now, by a union bound,

$$\Phi(\text{Cross}_{\bar{n}_1, k}^{\geq 2}) \leq \sum_{-k \leq x_2 < u_2 \leq k} \sum_{-k \leq y_2 < v_2 \leq k} \Phi(x \overset{F_k}{\longleftrightarrow} y \overset{F_k}{\leftrightarrow} u \overset{F_k}{\longleftrightarrow} v)$$

where connections are understood in ω_τ , and $x = (-\bar{n}_1, x_2), u = (-\bar{n}_1, u_2), y = (\bar{n}_1, y_2)$, and $v = (\bar{n}_1, v_2)$. Denote then $\mathcal{C}_{k,x}$ the cluster of x in the restriction of ω_τ to F_k , and, for C a realisation of $\mathcal{C}_{k,x}$ with $y \in C$, $\mathcal{F}_k^+(C)$ the set of edges in F_k above the union of C and its boundary. $\mathcal{F}_k^+(C)$ is then a simply connected set, so by Theorem 5,

$$\begin{aligned} \Phi(x \overset{F_k}{\longleftrightarrow} y \overset{F_k}{\leftrightarrow} u \overset{F_k}{\longleftrightarrow} v) &\leq \sum_{\substack{C \subset R_{\bar{n}_1, k} \\ x, y \in C}} \Phi(\mathcal{C}_{k,x} = C) \text{ATRC}_{\mathcal{F}_k^+(C)}^{1,1}(u \leftrightarrow v) \\ &\leq e^{-c|u-v|} \Phi(x \leftrightarrow y) \leq e^{-cn} e^{-\nu(y-x)}. \end{aligned}$$

Now, by convexity and symmetry, $\nu(y-x) \geq 2\bar{n}_1 \nu((y-x)/|y-x|) \geq 2\bar{n}_1 \nu_1$, so for n large enough,

$$\Phi(\text{Cross}_{\bar{n}_1, k}^{\geq 2}) \leq (2k+1)^2 e^{-cn} e^{-2n\nu_1},$$

which is the first half of the claim. The second follows from the same argument:

$$\Phi(\text{Cross}_{\bar{n}_1, k}^1) \leq 2 \sum_{-k \leq x_2, y_2 \leq k} \Phi(x \overset{F_k}{\longleftrightarrow} y) \leq 2(2k+1)^2 \Phi(x \leftrightarrow y) \leq 2(2k+1)^2 e^{-2\bar{n}_1 \nu_1}.$$

\square

Lemma 8.5. *There is $c \geq 0$ such that for any $\epsilon > 0$ there is $n_0 \geq 1$ such that for any $n \geq n_0$, $m \geq \epsilon n + \ln^2(n)$,*

$$\Phi_m(v_L \leftrightarrow v_R) \geq e^{-c \ln(n)} e^{-2n\nu_1}.$$

Proof. Let $N = n - \lceil C \ln(n) \rceil$ with C large enough. Let $w_L = (-N, 0)$, $w_R = (N, 0)$. Then, by inclusion of events and FKG inequality,

$$\begin{aligned} \Phi_m(v_L \leftrightarrow v_R) &\geq \Phi_m(w_L \leftrightarrow v_L) \Phi_m(w_R \leftrightarrow v_R) \Phi_m(w_L \xleftrightarrow{R_{N, \lfloor \epsilon n \rfloor}} w_R) \\ &\geq 2\Phi(w_L \xleftrightarrow{R_{N, \lfloor \epsilon n \rfloor}} w_R) \Phi_m(w_L \leftrightarrow v_L) \Phi_m(w_R \leftrightarrow v_R) \end{aligned}$$

where we used Lemma 8.3, C and n large enough in the second line.

We can then use Theorem 9 to lower bound the first probability: $\Phi(w_L \xleftrightarrow{R_{N, \lfloor \epsilon n \rfloor}} w_R)$ is equal to $e^{-2\nu_1 N}$ times the probability for a random walk with step distribution supported on the whole of $\mathcal{Y}^\blacktriangleleft \cap \mathbb{Z}^2$, exponential tails, and mean proportional to e_1 to hit $w_R - w_L$ while having second component less (in modulus) than ϵn . The probability of hitting $w_R - w_L$ is greater than C/\sqrt{n} by the Local Limit Theorem in dimension 2 (see for example [AOV24, Section 8.1]). The probability that the second component less than ϵn is greater than $1 - e^{-c\epsilon n}$ by standard large deviation bounds.

Finally, we use finite energy to bound the last two probabilities: let $F_L = \{x, x + e_1\} : x_1 = -n - 1, \dots, -N - 1\}$. Opening the edges of F_L has probability at least $e^{-c|F_L|} = e^{-c \ln(n)}$ for some $c > 0$. So $\Phi_m(w_L \leftrightarrow v_L) \geq e^{-c \ln(n)}$. Same with $w_R \leftrightarrow v_R$. \square

This leads us to a first notion of “good configurations”:

$$\text{Good}_n^1 = \{v_L \leftrightarrow v_R\} \cap \text{Cross}_{\bar{n}_1, c_0 n}^1 \cap \{\forall x \in \mathcal{C} : |x_2| < c_0 n\}, \quad (48)$$

where c_0 is given by Lemma 8.2. Then, by Lemmas 8.5, 8.4, and 8.2, there are $c > 0, n_0 \geq 1$ such that for any $n \geq n_0$, $m \geq c_0 n + \ln^2(n)$,

$$\Phi_m(\text{Good}_n^1 | v_L \leftrightarrow v_R) \geq 1 - e^{-cn}. \quad (49)$$

Define \mathcal{C}_{cr} to be the unique crossing cluster of $\Lambda_{\bar{n}_1, c_0 n}$ when there is a unique cluster, and $\mathcal{C}_{\text{cr}} = \Lambda_{\bar{n}_1, c_0 n}$ else. Under Good_n^1 , one has $\mathcal{C}_{\text{cr}} \subset \mathcal{C}$. The general plan for the next subsection will be to study \mathcal{C} by first proving that it is close (in Hausdorff distance) to \mathcal{C}_{cr} , and then by studying \mathcal{C}_{cr} using the infinite volume study of Section 7.

8.3. Geometry of crossing cluster. We start with the proximity between \mathcal{C}_{cr} and \mathcal{C} . Introduce

$$\mathcal{L}_L(C) = C \cap \{-\bar{n}_1\} \times \mathbb{Z}, \quad \mathcal{L}_R(C) = C \cap \{\bar{n}_1\} \times \mathbb{Z}, \quad \mathcal{L}(C) = \mathcal{L}_L(C) \cup \mathcal{L}_R(C).$$

Lemma 8.6. *Let c_0 be given by Lemma 8.2. There are $c_2 \geq 0, c > 0, n_0 \geq 1$, such that for any $n \geq n_0$, $m \geq c_0 n + \ln^2(n)$, one has that for any $K \geq c_2 \ln(n)$,*

$$\Phi_m(\exists x \in \mathcal{C} \setminus \mathcal{C}_{\text{cr}} : d_\infty(x, \mathcal{L}(\mathcal{C}_{\text{cr}})) \geq K | \text{Good}_n^1) \leq e^{-cK}.$$

Proof. Let c_2 be large enough and $K \geq c_2 \ln(n)$. Let $C \neq \emptyset$ be a realisation of \mathcal{C}_{cr} . Now, under the event $\mathcal{C}_{\text{cr}} = C$, $x \notin C$ is connected to C only if x is connected to $\mathcal{L}_L(C) \cup \mathcal{L}_R(C)$ (see Fig. 25). So, by Lemma 8.2,

$$\Phi_m(x \leftrightarrow C | \mathcal{C}_{\text{cr}} = C) \leq \sum_{y \in \mathcal{L}(C)} e^{-c|d_\infty(x, y)|}.$$

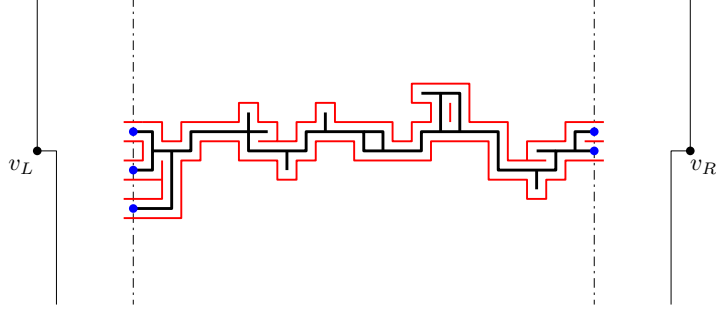

FIGURE 25. The open cluster \mathcal{C}_{cr} (in black) and the edge forced to be closed by its presence (dual of the red). The blue points are where connections to \mathcal{C}_{cr} have to arrive.

In particular, for C a realisation of \mathcal{C}_{cr} such that $C \subset \Lambda_{\bar{n}_1, c_0 n}$, and n large enough,

$$\begin{aligned} \Phi_m(\exists x : d(x, C) \geq K, x \leftrightarrow C \mid \mathcal{C}_{\text{cr}} = C) \\ \leq \sum_{y \in \mathcal{L}(C)} \sum_{x \in \mathbb{Z}^2 : d_\infty(x, y) \geq K} e^{-c|d_\infty(x, y)|} \leq e^{-cK/2}, \end{aligned}$$

as $|\mathcal{L}(C)| \leq 2c_0 n$, and c_2 is large enough. In particular,

$$\begin{aligned} \Phi_m(\exists x : d(x, C) \geq K, x \leftrightarrow C \mid \text{Cross}_{\bar{n}_1, c_0 n}^1 \cap \{\forall x \in \mathcal{C}_{\text{cr}} : |x_2| < c_0 n\}) \\ \leq \sum_C^* \Phi_m(\mathcal{C}_{\text{cr}} = C \mid \text{Cross}_{\bar{n}_1, c_0 n}^1 \cap \{\forall x \in \mathcal{C}_{\text{cr}} : |x_2| < c_0 n\}) e^{-cK/2} = e^{-cK/2}. \end{aligned}$$

where \sum_C^* is over realisation of \mathcal{C}_{cr} such that $C \subset \Lambda_{\bar{n}_1, c_0 n}$. To conclude,

$$\begin{aligned} \frac{\Phi_m(\exists x \in \mathcal{C} \setminus \mathcal{C}_{\text{cr}} : d_\infty(x, \mathcal{L}(\mathcal{C}_{\text{cr}})) \geq K, \text{Good}_n^1)}{\Phi_m(\text{Good}_n^1)} \\ \leq \frac{e^{-cK} \Phi_m(\text{Cross}_{\bar{n}_1, c_0 n}^1 \cap \{\forall x \in \mathcal{C}_{\text{cr}} : |x_2| < c_0 n\})}{\Phi_m(\text{Good}_n^1)} \leq e^{-cK} e^{c' \ln(n)} \leq e^{-cK/2} \end{aligned}$$

as c_2 is taken large enough, where the numerator is bounded using the bound we just derived, inclusion of events, and Lemma 8.4, and the denominator is bounded using Lemma 8.5, and (49). \square

We then turn to the geometry of \mathcal{C}_{cr} . Introduce, with c_2 given by Lemma 8.6,

$$\text{Good}_n^2 = \{\forall x \in \mathcal{C} \setminus \mathcal{C}_{\text{cr}} : d_\infty(x, \mathcal{L}(\mathcal{C}_{\text{cr}})) \leq c_2 \ln(n)\} \cap \text{Good}_n^1.$$

By Lemma 8.6, and (49),

$$\Phi_m(\text{Good}_n^2 \mid v_L \leftrightarrow v_R) \geq 1 - e^{-c \ln(n)}, \quad (50)$$

for some $c > 0$ and n large enough.

Introduce the slabs: for $l \in \mathbb{Z}, k \geq 0$,

$$\mathcal{S}_{l, k} = \{l, l+1, \dots, l+k\} \times \mathbb{Z}.$$

Lemma 8.7. *There are $c_3 \geq 0, c > 0, n_0 \geq 1, \rho' > 0$ such that for any $n \geq n_0, m \geq c_0 n + \ln^2(n), K \geq c_3 \ln(n), l \in \{-\bar{n}_1, \dots, \bar{n}_1 - K\}$*

$$\Phi_m(|\mathcal{S}_{l, K} \cap \text{Cpts}_{\pi/8}(\mathcal{C}_{\text{cr}})| \leq \rho' K, \text{Good}_n^2) \leq e^{-cK} e^{-2\nu_1 n}.$$

Proof. Under Good_n^2 , \mathcal{C}_{cr} contains both a point in $\Lambda_{\bar{n}_1, c_0 n} \cap (v_L + \{-\lceil c_2 \ln(n) \rceil, \lceil c_2 \ln(n) \rceil\})$ and a point in $\Lambda_{\bar{n}_1, c_0 n} \cap (v_R + \{-\lceil c_2 \ln(n) \rceil, \lceil c_2 \ln(n) \rceil\})$. So, by a union bound and Lemma 8.3, we have the following upper bound on the target probability

$$2 \sum_x \sum_y \Phi(x \leftrightarrow y, |\mathcal{S}_{l,K} \cap \text{CPts}_{\pi/8}(\mathcal{C}_x)| \leq \rho' K)$$

where the sum is over $x \in \Lambda_{\bar{n}_1, c_0 n} \cap (v_L + \{-\lceil c_2 \ln(n) \rceil, \lceil c_2 \ln(n) \rceil\})$, $y \in \Lambda_{\bar{n}_1, c_0 n} \cap (v_R + \{-\lceil c_2 \ln(n) \rceil, \lceil c_2 \ln(n) \rceil\})$, and \mathcal{C}_x is the connected component of x . By Theorem 9, the probability inside the sum multiplied by $e^{\nu(x-y)}$ is less than e^{-cK} as the distances between cone-points have exponential tails. In particular, by symmetry of ν , for c_3 fixed large enough,

$$\Phi(x \leftrightarrow y, |\mathcal{S}_{l,K} \cap \text{CPts}_{\pi/8}(\mathcal{C}_x)| \leq \rho' K) \leq e^{-2\nu_1 n} e^{-cK},$$

which gives the claim. \square

The next Lemma combines Lemma 8.7 and a deterministic observation to control the cone-points of \mathcal{C} .

Lemma 8.8. *There are $c_4 \geq 0, \rho > 0, c > 0, n_0 \geq 1$ such that for any $n \geq n_0$, $m \geq c_0 n + \ln^2(n)$, $K \geq c_4 \ln(n)$, $l \in \{-\bar{n}_1, \dots, \bar{n}_1 - K\}$*

$$\Phi_m(|\mathcal{S}_{l,K} \cap \text{CPts}(\mathcal{C})| \leq \rho K, \text{Good}_n^2) \leq e^{-cK} e^{-2\nu_1 n}.$$

Proof. First note that under Good_n^2 , one has that

$$\mathcal{C} \subset \left(\mathcal{C}_{\text{cr}} \cup \bigcup_{x \in \mathcal{L}(\mathcal{C}_{\text{cr}})} (x + [-c_2 \ln(n), c_2 \ln(n)]^2) \right).$$

In particular, there is $C \geq 0$ large enough such that if there are $x, y, z \in \text{CPts}_{\pi/8}(\mathcal{C}_{\text{cr}})$, and

$$x \cdot e_1 + C \ln(n) \leq y \cdot e_1 \leq z \cdot e_1 - C \ln(n),$$

then $y \in \text{CPts}(\mathcal{C})$ (see Fig. 26). In particular, if $K \geq 5C \ln(n)$, then by the above observation and Lemma 8.7, one has, with $\rho = \rho'/5$,

$$\begin{aligned} & \Phi_m(|\mathcal{S}_{l,K} \cap \text{CPts}(\mathcal{C})| \leq \rho K, \text{Good}_n^2) \\ & \leq \Phi_m(\mathcal{S}_{l,K/5} \cap \text{CPts}_{\pi/8}(\mathcal{C}_{\text{cr}}) = \emptyset, \text{Good}_n^2) \\ & \quad + \Phi_m(\mathcal{S}_{l+4K/5, K/5} \cap \text{CPts}_{\pi/8}(\mathcal{C}_{\text{cr}}) = \emptyset, \text{Good}_n^2) \\ & \quad + \Phi_m(\mathcal{S}_{l,K/5} \cap \text{CPts}_{\pi/8}(\mathcal{C}_{\text{cr}}) \neq \emptyset, \mathcal{S}_{l+4K/5, K/5} \cap \text{CPts}_{\pi/8}(\mathcal{C}_{\text{cr}}) \neq \emptyset, \\ & \quad \quad |\mathcal{S}_{l+2K/5, K/5} \cap \text{CPts}_{\pi/8}(\mathcal{C}_{\text{cr}})| \leq \rho' K/5, \text{Good}_n^2) \\ & \leq 3e^{-cK} e^{-2\nu_1 n} \end{aligned}$$

when n is large enough. \square

Let $\ell_n \equiv \ell_n(r) = \lceil r \ln(n) \rceil$. We are now in position to introduce the set of good clusters: let $\text{GCl}(r) = \text{GCl}_{n,m}(r)$ be the set of realizations C of \mathcal{C} such that (see Fig. 27)

- $\mathcal{S}_{-n+\ell_n+1, \ell_n} \cap \text{CPts}(C) \neq \emptyset$, $\mathcal{S}_{n-2\ell_n+1, \ell_n} \cap \text{CPts}(C) \neq \emptyset$;
- $|\mathcal{S}_{-n+2\ell_n+1, \ell_n} \cap \text{CPts}(C)| \geq \ln(n)$, $|\mathcal{S}_{n-3\ell_n+1, \ell_n} \cap \text{CPts}(C)| \geq \ln(n)$;
- $|\mathcal{S}_{-n+4\ell_n+1, \ell_n} \cap \text{CPts}(C)| \geq \ln(n)$, $|\mathcal{S}_{n-5\ell_n+1, \ell_n} \cap \text{CPts}(C)| \geq \ln(n)$;
- $\mathcal{S}_{-n+5\ell_n+1, \ell_n} \cap \text{CPts}(C) \neq \emptyset$, $\mathcal{S}_{n-6\ell_n+1, \ell_n} \cap \text{CPts}(C) \neq \emptyset$;
- $\mathcal{S}_{-n+6\ell_n+1, \ell_n} \cap \text{CPts}(C) \neq \emptyset$, $\mathcal{S}_{n-7\ell_n+1, \ell_n} \cap \text{CPts}(C) \neq \emptyset$.

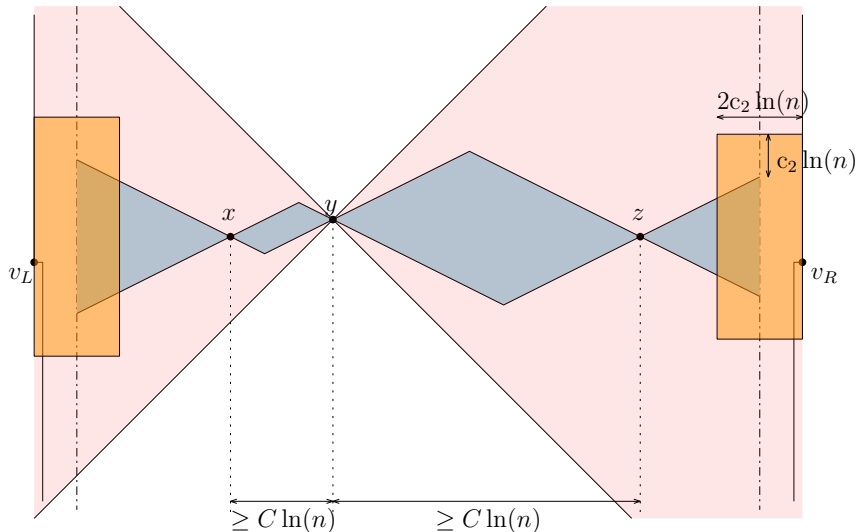

FIGURE 26. The presence of x, y, z in $\text{Cpts}_{\pi/8}(\mathcal{C}_{\text{cr}})$ forces \mathcal{C} to be included in the union of the blue diamonds/cones and of the orange rectangles. Enlarging the aperture of the cones at y allows to ensure that the orange rectangles are included in the cones started from y .

Lemma 8.9. *There are $c_5 > 0, c > 0$ such that for any $r \geq c_5$, there is $n_0 \geq 0$ such that for any $n \geq n_0, m \geq c_0 n + \ln^2(n)$,*

$$\Phi_m(\mathcal{C} \in \text{GCl}(r) \mid v_L \leftrightarrow v_R) \geq 1 - e^{-c \ln(n)}.$$

Proof. By Lemma 8.8 and a union bound, for r large enough (and n large enough),

$$\Phi_m(\mathcal{C} \notin \text{GCl}(r), \text{Good}_n^2) \leq 8e^{-cl_n(r)} e^{-2\nu_1 n}.$$

Then, fixing r large enough, for n large enough,

$$\begin{aligned} \Phi_m(\mathcal{C} \notin \text{GCl}(r) \mid v_L \leftrightarrow v_R) &= \frac{\Phi_m(\mathcal{C} \notin \text{GCl}(r), \text{Good}_n^2)}{\Phi_m(v_L \leftrightarrow v_R)} + \Phi_m((\text{Good}_n^2)^c \mid v_L \leftrightarrow v_R) \\ &\leq e^{-c \ln(n)} + e^{-c' \ln(n)}, \end{aligned}$$

by the previous display, Lemma 8.5, and (50). \square

Lemma 8.9 gives that for any fixed $r \geq c_5$,

$$\Phi_m(\mathcal{C} \in \text{GCl}(r) \mid v_L \leftrightarrow v_R) \geq 1 - e^{-c \ln(n)}, \quad (51)$$

for some $c > 0$ and any n large enough, $m \geq c_0 n + \ln^2(n)$.

8.4. Cluster decomposition and density swapping. Now that we have a good control over the typical geometry of \mathcal{C} , we can turn to the precise study of its law. Recall $\text{GCl} = \text{GCl}(r)$, $\ell_n = \ell_n(r)$ where r is some parameter than we can adjust. For any $C \in \text{GCl}$, the slabs $\mathcal{S}_{-n+6\ell_n+1, \ell_n}$, $\mathcal{S}_{n-7\ell_n+1, \ell_n}$ both contain a cone point of C . Let

- $W_L = W_L(\mathcal{C})$ be the leftmost cone-point of \mathcal{C} in the slab $\mathcal{S}_{-n+6\ell_n+1, \ell_n}$,
- $W_R = W_R(\mathcal{C})$ be the rightmost cone-point of \mathcal{C} in the slab $\mathcal{S}_{n-7\ell_n+1, \ell_n}$.

Let $\mathfrak{B}_L^1, \mathfrak{B}_R^1$ be the subsets (depending on r) of $\mathfrak{B}_L, \mathfrak{B}_R$ respectively such that for every $\eta_L \in \mathfrak{B}_L^1, \eta_R \in \mathfrak{B}_R^1$, there is $\eta \in \mathfrak{A}$ such that

$$\begin{aligned} C &= (v_L + \eta_L \circ \eta \circ \eta_R) \in \text{GCl}, \\ W_L(C) &= v_L + X(\eta_L), \quad W_R(C) = v_R - X(\eta_R). \end{aligned}$$

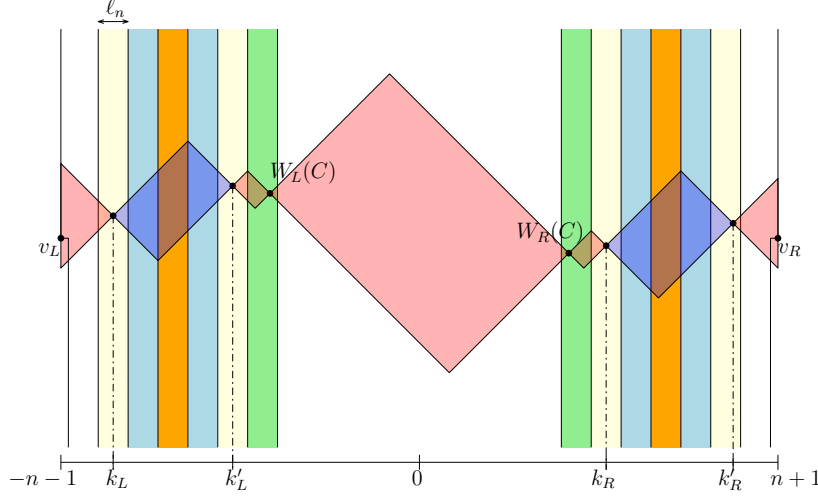

FIGURE 27. For $C \in \text{GCl}$, the blue stripes contain both $\ln(n)$ cone-points, the yellow stripes each contain at least one cone-point, $W_L(C), W_R(C)$ are in the green stripes. The decoupling event D lives in the orange part.

One can then uniquely decompose a cluster $C \in \text{GCl}$ as

$$C = v_L + \eta_L \circ \eta \circ \eta_R$$

with $\eta_L \in \mathfrak{B}_L^1$, $\eta_R \in \mathfrak{B}_R^1$, $\eta \in \mathfrak{A}$, $X(\eta_L) = W_L(C) - v_L$, $X(\eta_R) = v_R - W_R(C)$. Now, notice that by the cone constraint, $\mathbf{b}(\eta_L)$ has degree one in η_L , $\mathbf{b}(\eta_R)$ has degree one in η_R , and $\mathbf{f}(\eta), \mathbf{b}(\eta)$ both have degree 1 in η . Let

$$\begin{aligned} \mathbf{f}_e(\eta) &= \{\mathbf{f}(\eta), \mathbf{f}(\eta) + \mathbf{e}_1\}, & \mathbf{b}_e(\eta) &= \{\mathbf{b}(\eta), \mathbf{b}(\eta) - \mathbf{e}_1\}, \\ \mathbf{f}_e(\eta_R) &= \{\mathbf{f}(\eta_R), \mathbf{f}(\eta_R) + \mathbf{e}_1\}, & \mathbf{b}_e(\eta_L) &= \{\mathbf{b}(\eta_L), \mathbf{b}(\eta_L) - \mathbf{e}_1\}. \end{aligned}$$

Introduce percolation events associated with $\eta_L \in \mathfrak{B}_L^1, \eta_R \in \mathfrak{B}_R^1, \eta \in \mathfrak{A}$: let $u_R = v_R - X(\eta_R)$ and define (these are the finite volume versions of the events defined in Section 7.6)

- $A_L(\eta_L)$ is the event that edges of $v_L + \eta_L$ are open in $\omega_{\tau\tau'}$, edges of $(v_L + \eta_L) \setminus \mathbf{b}_e(v_L + \eta_L)$ are open in ω_τ , edges of $(v_L + \partial^{\text{ex}}\eta_L) \cap (E \cup E_b^+)$ are closed in ω_τ , $\mathbf{b}_e(v_L + \eta_L)$ is closed in ω_τ ;
- $A_R(\eta_R)$ is the event that edges of $u_R + \eta_R$ are open in $\omega_{\tau\tau'}$, edges of $(u_R + \eta_R) \setminus \mathbf{f}_e(u_R + \eta_R)$ are open in ω_τ , edges of $(u_R + \partial^{\text{ex}}\eta_R) \cap (E \cup E_b^+)$ are closed in ω_τ , $\mathbf{f}_e(u_R + \eta_R)$ is closed in ω_τ ;
- $A_v(\eta)$ is the event that edges of $v + \eta$ are open in $\omega_{\tau\tau'}$, edges of $(v + \eta) \setminus \{\mathbf{b}_e(v + \eta), \mathbf{f}_e(v + \eta)\}$ are open in ω_τ , edges of $\partial^{\text{ex}}(v + \eta)$ are closed in ω_τ , $\mathbf{b}_e(v + \eta), \mathbf{f}_e(v + \eta)$ are closed in ω_τ .

Using the same trick as in Section 7.6: swapping the state of $\mathbf{f}_e(\eta), \mathbf{b}_e(\eta), \mathbf{f}_e(\eta_R), \mathbf{b}_e(\eta_L)$ from open to close in ω_τ brings a weight $C_{J,U} = \left(\frac{\sinh(2J)}{e^{-2J} - e^{-2U}}\right)^4$ (see Claim 1), one gets

$$\Phi_m(C = v_L + \eta_L \circ \eta \circ \eta_R) = C_{J,U} \Phi_m(A_L(\eta_L) \cap A_{v_L + X(\eta_L)}(\eta) \cap A_R(\eta_R)). \quad (52)$$

Now, define the infinite volume events corresponding to the pieces η_L, η_R :

- $\tilde{A}_L(\eta_L)$ is the event that edges of $v_L + \eta_L$ are open in $\omega_{\tau\tau'}$, edges of $(v_L + \eta_L) \setminus \mathbf{b}_e(v_L + \eta_L)$ are open in ω_τ , edges of $v_L + \partial^{\text{ex}}\eta_L$ are closed in ω_τ , $\mathbf{b}_e(v_L + \eta_L)$ is closed in ω_τ ;

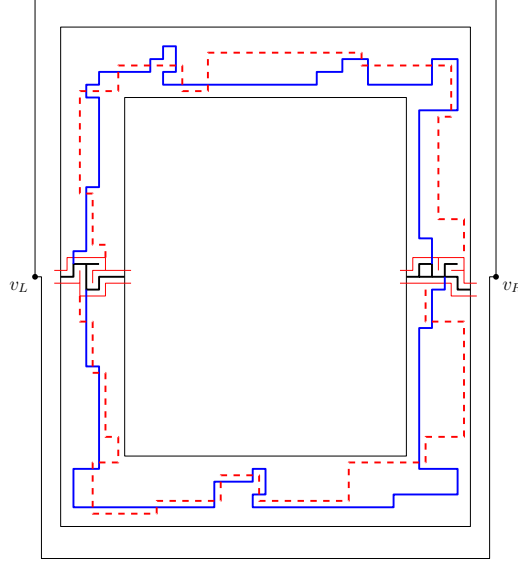
FIGURE 28. Decoupling paths imposed by the event D .

- $\tilde{A}_R(\eta_R)$ is the event that edges of $u_R + \eta_R$ are open in $\omega_{\tau\tau'}$, edges of $(u_R + \eta_R) \setminus \mathbf{f}_e(u_R + \eta_R)$ are open in ω_τ , edges of $u_R + \partial^{\text{ex}}\eta_R$ are closed in ω_τ , $\mathbf{f}_e(u_R + \eta_R)$ is closed in ω_τ .

As for Φ_m (see (52)),

$$\Phi(\mathcal{C}_{v_L} = v_L + \eta_L \circ \eta \circ \eta_R) = C_{J,U} \Phi(\tilde{A}_L(\eta_L) \cap A_{v_L + X(\eta_L)}(\eta) \cap \tilde{A}_R(\eta_R)). \quad (53)$$

Define, for $i = 1, \dots, 7$ (the volumes corresponding to the slabs of Fig. 27)

$$\Delta_n^i = \{-n + i\ell_n + 1, \dots, n - i\ell_n - 1\} \times \{-c_0n + i[\ln^2(n)], \dots, c_0n - i[\ln^2(n)]\}.$$

In particular, for any $C = v_L + \eta_L \circ \eta \circ \eta_R \in \text{GCl}$, $W_L(C), W_R(C) \in \Delta_n^6 \setminus \Delta_n^7$, and $W_L(C) + \eta$ is a subset of the edges in $\mathbb{E}_{\Delta_n^6}$.

Lemma 8.10 (Density swapping). *There are $c > 0, c_6 \geq 0$ such that for any $r \geq c_6$, there is $n_0 \geq 1$ such that for any $n \geq n_0$, $m \geq c_0n + \ln^2(n)$, any $\eta_L \in \mathfrak{B}_L^1$, $\eta_R \in \mathfrak{B}_R^1$, and any event B with support in $\mathbb{E}_{\Delta_n^6}$, one has*

$$\left| \frac{\Phi_m(B \mid A_L(\eta_L) \cap A_R(\eta_R))}{\Phi(B \mid \tilde{A}_L(\eta_L) \cap \tilde{A}_R(\eta_R))} - 1 \right| \leq e^{-c \ln(n)}. \quad (54)$$

Proof. We will use Lemma A.1 with the following inputs:

- Ω_1 is the set of elements in $\{(0, 0), (0, 1), (1, 1)\}^{\mathbb{E}_{\Delta_n^6}}$ having positive probability under $\Phi_m(\mid A_L(\eta_L) \cap A_R(\eta_R))$ restricted to $\mathbb{E}_{\Delta_n^6}$, Ω_2 is the set of elements in $\{(0, 0), (0, 1), (1, 1)\}^{\mathbb{E}_{\Delta_n^3 \setminus \Delta_n^4}}$ having positive probability under $\Phi_m(\mid A_L(\eta_L) \cap A_R(\eta_R))$ restricted to $\mathbb{E}_{\Delta_n^3 \setminus \Delta_n^4}$;
- μ is the restriction of $\Phi_m(\mid A_L(\eta_L) \cap A_R(\eta_R))$ to $\mathbb{E}_{\Delta_n^6} \cup \mathbb{E}_{\Delta_n^3 \setminus \Delta_n^4}$;
- ν is the restriction of $\Phi(\mid \tilde{A}_L(\eta_L) \cap \tilde{A}_R(\eta_R))$ to $\mathbb{E}_{\Delta_n^6} \cup \mathbb{E}_{\Delta_n^3 \setminus \Delta_n^4}$;
- D is the event that there is a path of open edges in $\omega_{\tau\tau'}$ in $\mathbb{E}_{\Delta_n^3 \setminus \Delta_n^4}$ surrounding Δ_n^3 , and two paths of edges dual to edges in $\mathbb{E}_{\Delta_n^3 \setminus \Delta_n^4}$, open in ω_τ^* , one joining the upper boundary of η_L in $\mathbb{E}_{\Delta_n^3 \setminus \Delta_n^4}$ to the upper boundary of η_R in $\mathbb{E}_{\Delta_n^3 \setminus \Delta_n^4}$, and one joining the lower boundary of η_L to the lower boundary of η_R (in $\mathbb{E}_{\Delta_n^3 \setminus \Delta_n^4}$). See Fig. 28.

We check the required bounds. First, note that the paths imposed by D split the cluster weights (as in Lemma 4.6) and therefore the third condition of Lemma A.1 is fulfilled with $\epsilon_3 = e^{-c \ln(n)}$ by uniform exponential decay in $\omega_\tau, \omega_{\tau\tau'}$ (Theorem 5), once r is taken large enough (c being uniform over η_L, η_R).

Let then $\gamma_{L/R}$ be the closest dual path surrounding $\eta_{L/R}$, and let $F_{L/R}$ be the sets of edges that are surrounded by $\gamma_{L/R}$. Let $k_L \equiv k_L(\eta_L)$ be the first coordinate of the leftmost cone-point of η_L in Δ_n^1 , and $k_R \equiv k_R(\eta_R)$ be the first coordinate of the leftmost cone-point of η_R in Δ_n^5 . Let $k'_L \equiv k'_L(\eta_L)$ be the first coordinate of the rightmost cone-point of η_L in Δ_n^5 , and $k'_R \equiv k'_R(\eta_R)$ be the first coordinate of the rightmost cone-point of η_R in Δ_n^1 , see Fig. 27. Let

$$\begin{aligned} \mathcal{R}_1 &= \{k_L, \dots, k'_R\} \times \{-c_0 n + \lceil \ln^2(n) \rceil, \dots, c_0 n - \lceil \ln^2(n) \rceil\}, \\ \mathcal{R}_2 &= \{k'_L, \dots, k_R\} \times \{-c_0 n + 5 \lceil \ln^2(n) \rceil, \dots, c_0 n - 5 \lceil \ln^2(n) \rceil\}, \\ \mathcal{E} &= \mathbb{E}_{\mathcal{R}_1 \setminus \mathcal{R}_2} \setminus (F_L \cup F_R), \quad F = (*\gamma_L \cup *\gamma_R) \cap \mathcal{E}. \end{aligned}$$

Let then $(a_-, b_-), (a_+, b_+) \in \{(0, 0), (0, 1), (1, 1)\}^{\mathbb{E}}$ be given by

$$(a_-, b_-)_e = \begin{cases} (0, 1) & \text{if } e \in (F_L \cup F_R) \cap \mathbb{E}_{\mathcal{R}_1}, \\ (0, 0) & \text{else,} \end{cases}$$

and

$$(a_+, b_+)_e = \begin{cases} (0, 1) & \text{if } e \in (F_L \cup F_R) \cap \mathbb{E}_{\mathcal{R}_1}, \\ (1, 1) & \text{else.} \end{cases}$$

By the lattice-FKG property of Φ_m, Φ , the first point of Lemma A.1 is true with $\epsilon_1 = e^{-c \ln(n)}$ if one has

$$\begin{aligned} d_{\text{TV}} \left(\text{ATRC}_{\mathcal{E}}^{a_+, b_+} (\mid \omega_\tau(e) = 0 \forall e \in F) \Big|_{\mathbb{E}_{\Delta_n^3 \setminus \Delta_n^4}}, \right. \\ \left. \text{ATRC}_{\mathcal{E}}^{a_-, b_-} (\mid \omega_\tau(e) = 0 \forall e \in F) \Big|_{\mathbb{E}_{\Delta_n^3 \setminus \Delta_n^4}} \right) \leq e^{-c \ln(n)}, \quad (55) \end{aligned}$$

which follows from the strong mixing property of ATRC (Theorem 8) once r is fixed large enough as in the proof of Lemma 7.8 (recall that η_L, η_R are forced to have at least $\ln(n)$ cone-points in the slabs $\mathcal{S}_{-n+2\ell_n+1, \ell_n}$, $\mathcal{S}_{-n+4\ell_n+1, \ell_n}$, and $\mathcal{S}_{n-3\ell_n+1, \ell_n}$, $\mathcal{S}_{n-5\ell_n+1, \ell_n}$ respectively).

The second point follows in a similar fashion with $\epsilon_2 = \epsilon_1$: by monotonicity (FKG-lattice) the distance between μ_2 and ν_2 (notations of Lemma A.1) is again bounded by (55).

For r fixed large enough, and n large enough, one can therefore apply Lemma A.1 with $\epsilon = e^{-c \ln(n)}$, $c > 0$ to obtain the result. \square

8.5. Proof of Theorem 11. From now on, let

$$r = c_6, \quad \ell_n = \lceil c_6 \ln(n) \rceil,$$

where c_6 is the one given by Lemma 8.10. In particular, one has that for any $\eta_L \in \mathfrak{B}_L^1$, $\eta_R \in \mathfrak{B}_R^1$,

$$\|X(\eta_L)\|_\infty \leq 8 \lceil c_6 \ln(n) \rceil, \quad \|X(\eta_R)\|_\infty \leq 8 \lceil c_6 \ln(n) \rceil. \quad (56)$$

For $\eta_L \in \mathfrak{B}_L^1$, $\eta_R \in \mathfrak{B}_R^1$, and C a realization of \mathcal{C} containing v_R , define $\mathbb{1}_{C \sim \eta_L, \eta_R}$ to be 1 if $C = v_L + \eta_L \circ \eta \circ \eta_R$ for some diamond-confined η , and 0 else. Also, introduce

$$r_m(\eta_L, \eta_R) = \frac{\Phi_m(A_L(\eta_L) \cap A_R(\eta_R))}{\Phi(\tilde{A}_L(\eta_L) \cap \tilde{A}_R(\eta_R))}.$$

From Lemma 8.10 (and using (52) and (53)), we get that for any f function of \mathcal{C} with $\|f\|_\infty \leq 1$, we have

$$\left| \Phi_m(f(\mathcal{C})\mathbb{1}_{\text{GCI}}(\mathcal{C})) - \sum_{\eta_L, \eta_R} r_m(\eta_L, \eta_R) \Phi(f(\mathcal{C})\mathbb{1}_{\text{GCI}}(\mathcal{C})\mathbb{1}_{\mathcal{C} \sim \eta_L, \eta_R}) \right| \leq e^{-c \ln(n)} \Phi_m(\mathcal{C} \in \text{GCI}), \quad (57)$$

where the computation goes by 1) partitioning over the realisation of $\mathcal{C} = \eta_L \circ \eta \circ \eta_R$ in both expectations of the L.H.S., 2) using (52) and (53) on each of the obtained summand, 3) apply Lemma 8.10 and

$$\Phi(f(\mathcal{C})\mathbb{1}_{\text{GCI}}(\mathcal{C})\mathbb{1}_{\mathcal{C} \sim \eta_L, \eta_R} | \tilde{A}_L(\eta_L) \cap \tilde{A}_R(\eta_R)) = \frac{\Phi(f(\mathcal{C})\mathbb{1}_{\mathcal{C} \sim \eta_L, \eta_R})}{\Phi(\tilde{A}_L(\eta_L) \cap \tilde{A}_R(\eta_R))},$$

to each summand, 4) re-sum to obtain the R.H.S..

Now, by Theorem 9 and translation invariance of Φ , there is $c > 0$ independent of n such that (recall (46)) for any $\eta_L \in \mathfrak{B}_L^1$, $\eta_R \in \mathfrak{B}_R^1$, and f with $\|f\|_\infty \leq 1$,

$$\left| \int d\mathcal{Q} f(v_L + \bar{\gamma}) \mathbb{1}_{(v_L + \bar{\gamma}) \sim \eta_L, \eta_R} - e^{2\nu_1 n} \Phi(f(\mathcal{C})\mathbb{1}_{\mathcal{C} \sim \eta_L, \eta_R}) \right| \leq e^{-cn}, \quad (58)$$

where $\bar{\gamma} = \gamma_L \circ \gamma_1 \circ \dots \circ \gamma_M \circ \gamma_R$ (we used that if $\mathbb{1}_{(v_L + \bar{\gamma}) \sim \eta_L, \eta_R} = 1$, then $X(\bar{\gamma}) = v_R - v_L$).

For $s \geq 0$, introduce

$$T_L(s) = \min \{k \geq 0 : \|X(\gamma_L \circ \gamma_1 \circ \dots \circ \gamma_k)\|_\infty \geq s \ln^2(n)\},$$

and

$$T_R(s) = \min \{k \geq 0 : \|X(\gamma_{M-k+1} \circ \dots \circ \gamma_R)\|_\infty \geq s \ln^2(n)\},$$

where $\gamma_0 \equiv \gamma_L$, $\gamma_{M+1} \equiv \gamma_R$, and we put $+\infty$ for the min of an empty set by convention.

From the exponential tails of p_L, p_R, p , one obtains that ($\bar{\gamma} = \gamma_L \circ \dots \circ \gamma_R$)

$$\int d\mathcal{Q} \mathbb{1}_{T_L = +\infty} \mathbb{1}_{X(\bar{\gamma}) = v_R - v_L} \leq e^{-cn}, \quad (59)$$

and the same for T_R , and that, for c_7 fixed large enough, any $K \geq c_7 \ln(n)$, and any $\square \in \{L, R\} \cup \{1, \dots, M\}$,

$$\begin{aligned} \int d\mathcal{Q} \mathbb{1}_{\|X(\gamma_L \circ \dots \circ \gamma_{T_L})\|_\infty \geq K} \mathbb{1}_{X(\bar{\gamma}) = v_R - v_L} &\leq e^{-cK}, \\ \int d\mathcal{Q} \mathbb{1}_{\|X(\gamma_\square)\|_\infty \geq K} \mathbb{1}_{X(\bar{\gamma}) = v_R - v_L} &\leq e^{-cK}. \end{aligned} \quad (60)$$

The first bound also holds for $\gamma_{M-T_R+1} \circ \dots \circ \gamma_R$.

Let then $B_n(s)$ be the set of sequences $(\gamma_L, \gamma_1, \dots, \gamma_M, \gamma_R)$ such that

- $0 < T_R(s) < \infty$, $0 < T_L(s) < \infty$,
- $X(\gamma_L \circ \dots \circ \gamma_R) = v_R - v_L$,
- $\max_{\square \in \{L, R\} \cup \{1, \dots, M\}} \|X(\gamma_\square)\|_\infty \leq s \ln^2(n)$,
- $\|X(\gamma_L \circ \dots \circ \gamma_{T_L})\|_\infty \leq 2s \ln^2(n)$, and $\|X(\gamma_{M-T_R+1} \circ \dots \circ \gamma_R)\|_\infty \leq 2s \ln^2(n)$.

From (59), (60), and the definition of $B_n(s)$, one directly obtains the next claim.

Claim 5. *There is $c_8 \geq 0, c > 0, n_0 \geq 1$ such that for any $s \geq c_8, n \geq n_0$,*

- (1) *for any $(\gamma_L, \gamma_1, \dots, \gamma_M, \gamma_R) \in B_n(s)$, $\|X(\gamma_L \circ \dots \circ \gamma_{T_L})\|_\infty \geq 8 \lceil c_6 \ln(n) \rceil$, and $\|X(\gamma_{M-T_R+1} \circ \dots \circ \gamma_R)\|_\infty \geq 8 \lceil c_6 \ln(n) \rceil$;*
- (2) *$\int d\mathcal{Q} \mathbb{1}_{\bar{\gamma} \notin B_n(s)} \leq e^{-cs \ln^2(n)}$.*

Let then

$$\begin{aligned}\mathfrak{B}_L^2(s) &= \{\zeta_L \in \mathfrak{B}_L : s \ln^2(n) \leq \|X(\zeta_L)\|_\infty \leq 2s \ln^2(n) \text{ and } \exists \eta_L \in \mathfrak{B}_L^1, \eta \in \mathfrak{A}, \zeta_L = \eta_L \circ \eta\}, \\ \mathfrak{B}_R^2(s) &= \{\zeta_R \in \mathfrak{B}_R : s \ln^2(n) \leq \|X(\zeta_R)\|_\infty \leq 2s \ln^2(n) \text{ and } \exists \eta_R \in \mathfrak{B}_R^1, \eta \in \mathfrak{A}, \zeta_R = \eta \circ \eta_R\}.\end{aligned}$$

Introduce two weights that will be our new boundary weights: for $\eta_L \in \mathfrak{B}_L^1$, $\eta_R \in \mathfrak{B}_R^1$, $\zeta_L \in \mathfrak{B}_L^2(s)$, and $\zeta_R \in \mathfrak{B}_R^2(s)$, define (where C is the normalization constant in the definition of \mathcal{Q})

$$\begin{aligned}b_L(\zeta_L; \eta_L) &= \sqrt{C} \sum_{\gamma_L} \sum_{k \geq 1} \sum_{\gamma_1, \dots, \gamma_k} \mathbf{1}_{\gamma_L \circ \dots \circ \gamma_k = \zeta_L} \mathbf{1}_{\exists l: \gamma_L \circ \dots \circ \gamma_l = \eta_L} \\ &\quad \cdot \mathbf{1}_{\|X(\gamma_L \circ \dots \circ \gamma_{k-1})\|_\infty < s \ln^2(n)} \cdot p_L(\gamma_L) \prod_{i=1}^k p(\gamma_i), \quad (61)\end{aligned}$$

and

$$\begin{aligned}b_R(\zeta_R; \eta_R) &= \sqrt{C} \sum_{\gamma_R} \sum_{k \geq 1} \sum_{\gamma_k, \dots, \gamma_1} \mathbf{1}_{\exists l: \gamma_l \circ \dots \circ \gamma_1 \circ \gamma_R = \eta_R} \mathbf{1}_{\gamma_k \circ \dots \circ \gamma_1 \circ \gamma_R = \zeta_R} \\ &\quad \cdot \mathbf{1}_{\|X(\gamma_{k-1} \circ \dots \circ \gamma_R)\|_\infty < s \ln^2(n)} \cdot p_L(\gamma_L) \prod_{i=1}^k p(\gamma_i), \quad (62)\end{aligned}$$

where the sums are over $\gamma_L \in \mathfrak{B}_L$, $\gamma_1, \dots \in \mathfrak{A}$, $\gamma_R \in \mathfrak{B}_R$.

Also introduce one measure (the normalized version of it is our Random Walk bridge measure): for $v \in \mathbb{Z}^2 \setminus 0$, $M \geq 1$,

$$\tilde{Q}_v(M; \gamma_1, \dots, \gamma_M) = \mathbf{1}_{X(\gamma_1 \circ \dots \circ \gamma_M) = v} \prod_{i=1}^M p(\gamma_i), \quad Z_v = \int \tilde{Q}_v, \quad Q_v = \tilde{Q}_v / Z_v. \quad (63)$$

From the above considerations, partitioning over the realizations ζ_L, ζ_R of, respectively, $\gamma_L \circ \dots \circ \gamma_{T_L}$, and $\gamma_{M-T_R+1} \circ \dots \circ \gamma_R$, one has that for any $s \geq c_8$, and function f ,

$$\begin{aligned}\sum_{\zeta_L \in \mathfrak{B}_L^2(s)} \sum_{\zeta_R \in \mathfrak{B}_R^2(s)} b_L(\zeta_L; \eta_L) b_R(\zeta_R; \eta_R) \int d\tilde{Q}_{v(\zeta_L, \zeta_R)} f(v_L + \zeta_L \circ \gamma_1 \circ \dots \circ \gamma_M \circ \zeta_R) \\ = \int d\mathcal{Q} f(v_L + \bar{\gamma}) \mathbf{1}_{(v_L + \bar{\gamma}) \sim \eta_L, \eta_R} \mathbf{1}_{B_n(s)}(\gamma_L, \dots, \gamma_R), \quad (64)\end{aligned}$$

where $v(\zeta_L, \zeta_R) = v_R - X(\zeta_R) - v_L - X(\zeta_L)$.

Claim 6. *With the notations above, there are $c > 0, c_9 \geq 0, n_0 \geq 1$ such that for any $n \geq n_0$, and any f with $\|f\|_\infty \leq 1$,*

$$\begin{aligned}\left| \sum_{\eta_L, \eta_R} \sum_{\zeta_L, \zeta_R} r_m(\eta_L, \eta_R) e^{-2\nu_1 n} b_L(\zeta_L; \eta_L) b_R(\zeta_R; \eta_R) \int d\tilde{Q}_{v(\zeta_L, \zeta_R)} f(v_L + \zeta_L \circ \gamma_1 \circ \dots \circ \gamma_M \circ \zeta_R) \right. \\ \left. - \Phi_m(f(\mathcal{C}) \mathbf{1}_{\text{GCl}}(\mathcal{C})) \right| \leq \Phi_m(\mathcal{C} \in \text{GCl}) e^{-c \ln(n)} \quad (65)\end{aligned}$$

where the sums are over $\eta_L \in \mathfrak{B}_L^1$, $\eta_R \in \mathfrak{B}_R^1$, and $\zeta_L \in \mathfrak{B}_L^2(c_9)$, $\zeta_R \in \mathfrak{B}_R^2(c_9)$.

Proof. Start by observing that by (51), and Lemma 8.5, one has

$$\Phi_m(\mathcal{C} \in \text{GCl}) \geq e^{-2\nu_1 n} e^{-c \ln(n)},$$

for some $c > 0$. First, from (57), one has, for some $c > 0$,

$$\left| \Phi_m(f(\mathcal{C})\mathbb{1}_{\text{GCl}}(\mathcal{C})) - \sum_{\eta_L, \eta_R} r_m(\eta_L, \eta_R) \Phi(f(\mathcal{C})\mathbb{1}_{\mathcal{C} \sim \eta_L, \eta_R}) \right| \leq e^{-c \ln(n)} \Phi_m(\mathcal{C} \in \text{GCl}),$$

where the summation over $\eta_L \in \mathfrak{B}_L^1$, $\eta_R \in \mathfrak{B}_R^1$. Then, using (58), and

$$\sum_{\eta_L, \eta_R} r_m(\eta_L, \eta_R) = \sum_{\eta_L, \eta_R} \frac{\Phi_m(A_L(\eta_L) \cap A_R(\eta_R))}{\Phi(\tilde{A}_L(\eta_L) \cap \tilde{A}_R(\eta_R))} \leq e^{c \ln^2(n)},$$

for some $c > 0$, as $\Phi(\tilde{A}_L(\eta_L) \cap \tilde{A}_R(\eta_R)) \geq e^{-c \ln^2(n)}$ by finite energy (and control over the maximal size of η_L, η_R : they contain at most $c \ln^2(n)$ edges each), one has

$$\begin{aligned} & \left| \sum_{\eta_L, \eta_R} r_m(\eta_L, \eta_R) \Phi(f(\mathcal{C})\mathbb{1}_{\mathcal{C} \sim \eta_L, \eta_R}) \right. \\ & \quad \left. - \sum_{\eta_L, \eta_R} r_m(\eta_L, \eta_R) e^{-2\nu_1 n} \int d\mathcal{Q} f(v_L + \bar{\gamma}) \mathbb{1}_{v_L + \bar{\gamma} \sim \eta_L, \eta_R} \right| \\ & \leq e^{-2\nu_1 n - cn} \sum_{\eta_L, \eta_R} r_m(\eta_L, \eta_R) \leq e^{-cn/2} \Phi_m(\mathcal{C} \in \text{GCl}), \end{aligned}$$

for n large enough. Then, using Claim 5, one obtains that for s large enough,

$$\begin{aligned} & \left| \sum_{\eta_L, \eta_R} r_m(\eta_L, \eta_R) e^{-2\nu_1 n} \int d\mathcal{Q} f(v_L + \bar{\gamma}) \mathbb{1}_{(v_L + \bar{\gamma}) \sim \eta_L, \eta_R} \mathbb{1}_{B_n}(\gamma_L, \dots, \gamma_R) \right. \\ & \quad \left. - \sum_{\eta_L, \eta_R} r_m(\eta_L, \eta_R) e^{-2\nu_1 n} \int d\mathcal{Q} f(v_L + \bar{\gamma}) \mathbb{1}_{(v_L + \bar{\gamma}) \sim \eta_L, \eta_R} \right| \\ & \leq e^{-2\nu_1 n} \sum_{\eta_L, \eta_R} r_m(\eta_L, \eta_R) e^{-cs \ln^2(n)} \leq e^{-cs \ln(n)} \Phi_m(\mathcal{C} \in \text{GCl}), \end{aligned}$$

for n large enough, once s has been fixed large enough. A look at (64) and triangular inequality finishes the proof. \square

We are now in position to conclude the proof of Theorem 11. Define a measure $\text{Me}_{n,m}$ on $\mathfrak{B}_L \times \mathfrak{B}_R$ via

$$\begin{aligned} \text{Me}_{n,m}(\zeta_L, \zeta_R) &= \mathbb{1}_{\mathfrak{B}_L^2(c_9)}(\zeta_L) \mathbb{1}_{\mathfrak{B}_R^2(c_9)}(\zeta_R) \\ & \quad \cdot \frac{e^{-2\nu_1 n}}{\Phi_m(\mathcal{C} \in \text{GCl})} \sum_{\eta_L, \eta_R} r_m(\eta_L, \eta_R) b_L(\zeta_L; \eta_L) b_R(\zeta_R; \eta_R) Z_{v(\zeta_L, \zeta_R)} \end{aligned} \quad (66)$$

where the sum is over $\eta_L \in \mathfrak{B}_L^1$, $\eta_R \in \mathfrak{B}_R^1$, and $v(\zeta_L, \zeta_R) = v_R - X(\zeta_R) - v_L - X(\zeta_L)$ (Z_v is defined in (63)). From (65) with $f = 1$, one obtains

$$\left| \sum_{\zeta_L, \zeta_R} \text{Me}_{n,m}(\zeta_L, \zeta_R) - 1 \right| \leq e^{-c \ln(n)}. \quad (67)$$

Letting

$$\overline{\text{Me}}_{n,m}(\zeta_L, \zeta_R) = \frac{1}{\sum_{\zeta_L, \zeta_R} \text{Me}_{n,m}(\zeta_L, \zeta_R)} \text{Me}_{n,m}(\zeta_L, \zeta_R), \quad (68)$$

one has the final “mixture of random walk bridges” representation: for f a function of the cluster of 0,

$$\left| \sum_{\zeta_L, \zeta_R} \overline{\text{Me}}_{n,m}(\zeta_L, \zeta_R) \int dQ_{v(\zeta_L, \zeta_R)} f(v_L + \zeta_L \circ \gamma_1 \circ \dots \circ \gamma_M \circ \zeta_R) - \Phi_m(f(\mathcal{C}) \mid \mathcal{C} \in \text{GCl}) \right| \leq \|f\|_\infty e^{-c \ln(n)}.$$

In particular, as $\Phi_m(\mathcal{C} \in \text{GCl} \mid v_L \leftrightarrow v_R) \geq 1 - e^{-c \ln(n)}$ (see (51)), for any f ,

$$\left| \sum_{\zeta_L, \zeta_R} \overline{\text{Me}}_{n,m}(\zeta_L, \zeta_R) \int dQ_{v(\zeta_L, \zeta_R)} f(v_L + \zeta_L \circ \gamma_1 \circ \dots \circ \gamma_M \circ \zeta_R) - \Phi_m(f(\mathcal{C}) \mid v_L \leftrightarrow v_R) \right| \leq \|f\|_\infty e^{-c \ln(n)}, \quad (69)$$

which is the statement of Theorem 11.

8.6. Convergence to the Brownian Bridge. From Theorem 11, one can use the result of [Kov04] to obtain the wanted invariance principle. We introduce the notations and state the result which one obtains from [Kov04].

Let m_n be any sequence with $m_n \geq C_0 n$, C_0 given by Theorem 11. Recall the laws p , $\overline{\text{Me}}_{n,m_n}$ of Theorem 11. Let p_* be the push-forward of p by X (it is a probability measure on $\mathbb{Z}^2 \cap \mathcal{Y}^\blacktriangleleft$). Let q_*^n be the push-forward of $\overline{\text{Me}}_{n,m_n}$ by X (it is a probability measure on $(\{-[c_0 \ln^2(n)], \dots, [c_0 \ln^2(n)]\}^2 \cap \mathcal{Y}^\blacktriangleleft)^2$).

Define all random variables on a common probability space $(\Omega, \mathcal{F}, \mathbb{P})$. Let X_1, X_2, \dots be an i.i.d. sequence of random variables with law p_* . Let

$$\alpha = E(X_1 \cdot e_1), \quad \sigma_x^2 = E((X_1 \cdot e_1)^2) - \alpha^2, \quad \sigma_y^2 = E((Y_1 \cdot e_2)^2), \quad \chi = \frac{\sigma_y^2}{\alpha}.$$

By reflection symmetry of Φ (and thus of p and p_*), the mean vector and covariance matrix of p_* are given by

$$\bar{\mu} = \begin{pmatrix} \alpha \\ 0 \end{pmatrix}, \quad D = \begin{pmatrix} \sigma_x^2 & 0 \\ 0 & \sigma_y^2 \end{pmatrix}. \quad (70)$$

Define

$$S_0 = (0, 0), \quad S_k = S_{k-1} + X_k. \quad (71)$$

Let $(V, W) \sim q_*^n$ be independent of the X_i 's. Define

$$T_n = \min \{k \geq 1 : S_k = v_R - v_L - V - W\}$$

with $T_n = \infty$ when the set is empty. When $T_n < \infty$, let

$$Z_0 = (0, 0), \quad Z_1 = V, \quad Z_k = V + S_{k-1}, \quad k = 2, \dots, T_n + 1, \\ Z_{T_n+2} = Z_{T_n+1} + W = v_R - v_L.$$

For $s \in [0, 2n + 2]$, let

$$\tau_-(s) = \max\{k \geq 0 : Z_k \cdot e_1 \leq s\}, \quad \tau_+(s) = \min\{k \geq 0 : Z_k \cdot e_1 \geq s\}.$$

Define the linear interpolation for $s \in [0, 2n + 2]$

$$\text{LI}_s(Z) = \frac{Z_{\tau_+(s)} \cdot e_1 - s}{(Z_{\tau_+(s)} - Z_{\tau_-(s)}) \cdot e_1} Z_{\tau_-(s)} \cdot e_2 + \frac{s - Z_{\tau_-(s)} \cdot e_1}{(Z_{\tau_+(s)} - Z_{\tau_-(s)}) \cdot e_1} Z_{\tau_+(s)} \cdot e_2$$

when $T_n < \infty$, and $\text{LI}_s(Z) = 0$ else. Define then the properly re-scaled version of $(\text{LI}_s(Z))_{s \in [0, 2n+2]}$:

$$\Gamma_t^n = \Gamma_t^n(Z) = \frac{1}{\sqrt{2n\chi}} \text{LI}_{t(2n+2)}(Z), \quad t \in [0, 1].$$

Define

$$\mathbb{P}_n = \mathbb{P}(\cdot \mid T_n < \infty).$$

The next Lemma concludes our study of the invariance principle for the (modified) ATRC cluster.

Lemma 8.11. *The sequence of random functions $(\Gamma_t^n)_{t \in [0, 1]}$ under \mathbb{P}_n , $n \geq 1$, converges weakly to a standard Brownian Bridge. Moreover, with probability going to 1 as $n \rightarrow \infty$, the maximal step of Z has norm less than $C \ln^2(n)$ for some $C \geq 0$.*

Proof. This is the main result of [Kov04] with a slightly simpler setup: the mean of our steps is proportional to a coordinate axis, which is a particular case of the setup of [Kov04]. The estimate on the maximal step size is a simple large deviation estimate combined with the Local Limit Theorem. \square

Remark 8.12. *Note that the value of the diffusivity constant χ can be identified with the curvature of $\partial\mathcal{W}$ at $\nu(e_1)e_1$, exactly as in [IOSV22, Appendix B].*

9. PROOFS OF THEOREMS 1, 2, 3 AND 6

Previous sections establish coupling between the FK-percolation and the (modified) ATRC models and several results for the latter: mixing properties, Ornstein–Zernike theory, invariance principle for the interface under suitable Dobrushin boundary conditions. In order to transfer the invariance principle to the FK-percolation, we need to show proximity of interfaces in the two models.

Consider the coupling measure $\Psi^{1/0}$ constructed in Section 4. A crucial feature of this coupling is that the respective interfaces stay close to each other with high probability. To measure the distance between interfaces, we will work with the *one-sided Hausdorff distance* defined by

$$d_H(R, S) := \sup_{x \in R} \inf_{y \in S} d_\infty(x, y), \quad R, S \subset \mathbb{R}^2.$$

Given a bi-infinite connected set $C \subset \mathbb{L}_\bullet \cap (\mathbb{R} \times [-c, c])$, we say that a subset $R \subset \mathbb{R}^2$ is (weakly) *above* C if it is contained in (the closure of) the connected component of the point $(0, c+1)$ in $\mathbb{R}^2 \setminus C$, where we identify C with the union of line segments between the endpoints of the edges in \mathbb{E}_C . We say that R is (weakly) *below* C if it is contained in (the closure of) the connected component of the point $(0, -c-1)$ in $\mathbb{R}^2 \setminus C$. We make the analogous definitions for finite connected sets by extending them to bi-finite connected sets by attaching left-infinite horizontal lines to all the leftmost points of the finite set and right-infinite horizontal lines to all the rightmost points; and, analogously, for connected subsets $C \subset \mathbb{L}_\circ$. Recall the upper and lower envelopes $\Gamma_{\text{FK}}^{\pm, n}$ in G_n defined in Section 1. Define $\Gamma_{\text{FK}}^{\pm, n, m}$ in $G = G_{n, m}$ analogously. Recall also the definition of $\Gamma_{\text{ATRC}}^{n, m}$ in Section 4.4.

Lemma 9.1. *There exist constants $C, c > 0$ such that, for any $n, m, k \geq 1$,*

$$\Psi^{1/0}(d_H(\Gamma_{\text{FK}}^{\pm, n, m}, \Gamma_{\text{ATRC}}^{n, m}) > k) \leq Cnme^{-ck}.$$

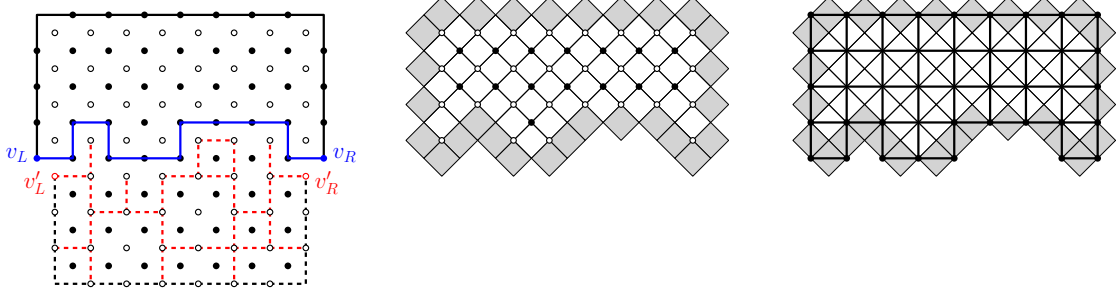

FIGURE 29. For $n = m = 3$. Left: vertices of G (solid) and its dual (hollow) with “1/0” boundary conditions (black solid and dashed edges), the dual cluster $\mathcal{C}' = \mathcal{C}'$ (endpoints of dashed edges), and the lowermost path $p_{\mathcal{C}'}^\uparrow$ (blue solid edges). Center: the set $\mathcal{D}_{\mathcal{C}'}$ (solid and hollow vertices), the tiles in $A_{\mathcal{C}'}$ that intersect them, with boundary tiles in $A_{\mathcal{C}'}^b$, in grey. Right: The associated edges in $\bar{E}^{\mathcal{C}'}$, with those in $E_b^{\mathcal{C}'}$ contained in grey tiles.

Proof. Let us fix $n, m \geq 1$ and omit them from the notation. We present the argument for Γ_{FK}^+ . The statement for Γ_{FK}^- is proved in an analogous fashion. Consider the coupling $\Psi^{1/0}$ of $\omega \sim \text{FK}_G^{1/0}$, $(\sigma_\bullet, \sigma_\circ) \sim \text{Spin}_D^{+,+}$ and $(\omega_\tau, \omega_{\tau'}) \sim \text{mATRC}_K$ described in Section 4.2. Let $\mathcal{C}' = \mathcal{C}'_{v'_L}$ be the cluster of $v'_L := (-n - \frac{1}{2}, -\frac{1}{2})$ in ω^* ; see Fig. 29. Note that

$$d_H(\Gamma_{\text{FK}}^+, \Gamma_{\text{ATRC}}) \leq d_H(\Gamma_{\text{FK}}^+, \mathcal{C}') + d_H(\mathcal{C}', \Gamma_{\text{ATRC}}) \leq \frac{1}{2} + d_H(\mathcal{C}', \Gamma_{\text{ATRC}}). \quad (72)$$

Let $p_- \subset \mathbb{V}_{*E}$ be the uppermost path connecting v'_L to $v'_R := (n + \frac{1}{2}, -\frac{1}{2})$ on which $\sigma_\circ \equiv -1$. Recall the definition of $\mathcal{C} = \mathcal{C}_{v_L}$ in Section 4.4. Since $*\partial^{\text{edge}}\mathcal{C}$ contains such a path, as well as a path connecting $(-n - \frac{3}{2}, \frac{1}{2})$ to $(n + \frac{3}{2}, \frac{1}{2})$ on which $\sigma_\circ \equiv 1$ (see Fig. 9 and 10), we have

$$d_H(\mathcal{C}', \Gamma_{\text{ATRC}}) \leq d_H(\mathcal{C}', p_-) + d_H(p_-, \Gamma_{\text{ATRC}}) \leq d_H(\mathcal{C}', p_-) + \frac{1}{2}. \quad (73)$$

Fix a realisation \mathcal{C}' of \mathcal{C}' . By the coupling, $\sigma_\circ \equiv -1$ on $\mathcal{C}' = \mathcal{C}'$ (see Fig. 9). Thus, the path p_- cannot contain vertices below \mathcal{C}' . Hence, the random variable $d_H(\mathcal{C}', p_-)$ is measurable with respect to σ_\circ restricted to the vertices in $\mathcal{D} \cap \mathbb{L}_\circ$ above \mathcal{C}' . Let us determine the conditional law of $(\sigma_\bullet, \sigma_\circ)$ restricted to the vertices in \mathcal{D} above \mathcal{C}' .

Let $p_{\mathcal{C}'}^\uparrow$ be the lowermost path in ω connecting v_L to v_R above \mathcal{C}' and $\mathcal{D}_{\mathcal{C}'}$ be the subset of vertices in \mathcal{D} above $p_{\mathcal{C}'}^\uparrow$. Denote by $A_{\mathcal{C}'}$ the set of tiles with at least one corner in $\mathcal{D}_{\mathcal{C}'}$, and by $A_{\mathcal{C}'}^b$ the set of tiles with precisely one corner in $\mathcal{D}_{\mathcal{C}'}$; see Fig. 29. Define the associated sets of edges

$$\bar{E}^{\mathcal{C}'} = \{e_t : t \in A_{\mathcal{C}'}\}, \quad E_b^{\mathcal{C}'} = \{e_t : t \in A_{\mathcal{C}'}^b\} \quad \text{and} \quad E^{\mathcal{C}'} = \bar{E}^{\mathcal{C}'} \setminus E_b^{\mathcal{C}'}$$

Set $G_{\mathcal{C}'} = (\mathbb{V}_{E^{\mathcal{C}'}}^{\mathcal{C}'}, E^{\mathcal{C}'})$, $K_{\mathcal{C}'} = (\mathbb{V}_{\bar{E}^{\mathcal{C}'}}^{\mathcal{C}'}, \bar{E}^{\mathcal{C}'})$, and let $K_{\mathcal{C}'}^1$ be the graph obtained from $K_{\mathcal{C}'}$ by identifying vertices in $\partial_{\mathbb{L}_\bullet}^{\text{in}} \mathbb{V}_{\bar{E}^{\mathcal{C}'}}^{\mathcal{C}'}$ and those connected by $p_{\mathcal{C}'}^\uparrow$.

By Lemma 4.1 and the domain Markov property of FK-percolation,

$$\Psi^{1/0}(\omega|_{E^{\mathcal{C}'}} = \omega_0 | \mathcal{C}' = \mathcal{C}') = \text{FK}_G^{1/0}(\omega|_{E^{\mathcal{C}'}} = \omega_0 | \mathcal{C}' = \mathcal{C}') = \text{FK}_{G_{\mathcal{C}'}}^1(\omega|_{E^{\mathcal{C}'}} = \omega_0)$$

for any $\omega_0 \in \{0, 1\}^{E^{\mathcal{C}'}}$. The FK-percolation measure with wired boundary conditions can be coupled to the six-vertex spin measure with $(+, +)$ boundary conditions. This version of the BKW coupling was presented in [GP23, Lis21] and is very closely related to our Lemma 4.1 that deals with the Dobrushin boundary conditions. We provide only the statement.

We first define the six-vertex spin measure on $\mathcal{D}_{C'}$ under $(+, +)$ boundary conditions (compare to (10)): for $\sigma = (\sigma_\bullet, \sigma_\circ) \in \{\pm 1\}^{\mathbb{L}_\bullet} \times \{\pm 1\}^{\mathbb{L}_\circ}$, it is defined by

$$\mathbf{Spin}_{\mathcal{D}_{C'}}^{+,+}(\sigma) \propto \mathbf{c}^{|T_{5,6}^i(\sigma)|} \mathbf{c}_b^{|T_{5,6}^b(\sigma)|} \mathbb{1}_{\sigma=+1 \text{ on } (\mathbb{L}_\bullet \cup \mathbb{L}_\circ) \setminus \mathcal{D}_{C'}} \mathbb{1}_{\text{ice}}(\sigma),$$

where $T_{5,6}^i(\sigma)$ and $T_{5,6}^b(\sigma)$ are respectively the sets of tiles in $A_{C'} \setminus A_{C'}^b$ and $A_{C'}^b$ that are of types 5,6 in σ . Then, as in Lemma 4.1,

$$\Psi^{1/0}((\sigma_\bullet |_{\mathcal{D}_{C'} \cap \mathbb{L}_\bullet}, \sigma_\circ |_{\mathcal{D}_{C'} \cap \mathbb{L}_\circ}) \in \cdot | \mathcal{C}' = C') = \mathbf{Spin}_{\mathcal{D}_{C'}}^{+,+} |_{\mathcal{D}_{C'}}.$$

In the same vein, we determine the conditional law of $(\omega_\tau, \omega_{\tau\tau'})$ on $\bar{E}^{C'}$ by adapting Lemma 4.2 to $+, +$ boundary conditions. We now define a modified ATRC measure on $K_{C'}$ by taking Definition 2 and replacing (E, E_b^+, E_b^-) with $(E^{C'}, E_b^{C'}, \emptyset)$ (in particular, $I(\mathcal{C}) \equiv 0$ for all clusters): for any $(a, b) \in \{0, 1\}^{\bar{E}^{C'}} \times \{0, 1\}^{\bar{E}^{C'}}$, define

$$\mathbf{mATRC}_{K_{C'}}^\emptyset(a, b) \propto \mathbb{1}_{a \subseteq b} \mathbb{1}_{b \setminus a \subseteq E^{C'}} 2^{\kappa_{K_{C'}}(a) + \kappa_{K_{C'}}(b)} 2^{|a|} (\mathbf{c} - 2)^{|b \setminus a|} (\mathbf{c}_b - 1)^{|E_b^{C'} \setminus b|}.$$

Since $\mathcal{C}' = C'$, we have $\sigma_\bullet \equiv 1$ at all endpoints of edges in $E_b^{C'}$. Then, as in Lemma 4.2,

$$\Psi^{1/0}((\omega_\tau, \omega_{\tau\tau'}) |_{\bar{E}^{C'}} \in \cdot | \mathcal{C}' = C') = \mathbf{mATRC}_{K_{C'}}^\emptyset.$$

We claim that this measure satisfies (**strong-FKG**). Indeed, all local terms in the right side of the display trivially satisfy the property and the non-local terms assign weight two to the clusters in a and b . It is standard that such terms satisfy (**strong-FKG**): see the classical [Gri06, Theorem 3.8] for the case of the random-cluster model; alternatively, the proof of Lemma 4.4 applies by setting $\alpha \equiv \beta \equiv \frac{1}{2}$. Thus,

$$\mathbf{mATRC}_{K_{C'}}^\emptyset \leq_{\text{st}} \mathbf{mATRC}_{K_{C'}}^\emptyset(\cdot | \omega_\tau(e) = 1 \text{ for all } e \in E_b^{C'}) = \mathbf{ATRC}_{G_{C'}}^{1,1}.$$

As in the proof of Lemma 8.2, uniform exponential decay of connection probabilities in $\mathbf{ATRC}_{G_{C'}}^{1,1}$ (Theorem 5) and the arguments of [Ale04, Section 2] imply that connection probabilities in $\mathbf{mATRC}_{K_{C'}}^\emptyset$ decay exponentially as well.

Finally, since $\sigma_\circ \sim \omega_\tau^*$ and $\sigma_\circ = 1$ on $\mathbb{L}_\circ \setminus \mathcal{D}_{C'}$, any connected component of $\{\sigma_\circ = -1\}$ must be surrounded by a circuit in ω_τ , whence

$$\Psi^{1/0}(d_H(\mathcal{C}', p_-) > k | \mathcal{C}' = C') \leq \mathbf{mATRC}_{K_{C'}}^\emptyset(\exists i \in p_{C'}^\uparrow : i \xleftrightarrow{\omega_\tau} i + \partial^{\text{in}} \Lambda_k) \leq Cnmke^{-ck}.$$

Averaging over C' and inserting this in (72) and (73) completes the proof. \square

9.1. Proof of Theorem 2. We will derive Theorem 2 from the analogous statement for the cluster $\mathcal{C} = \mathcal{C}_{v_L}$ of v_L in ω_τ with law the first marginal of $\mathbf{mATRC}_{K_{n,m}}(\cdot | v_L \xleftrightarrow{\omega_\tau} v_R)$ (Theorem 11 and Lemma 8.11) and the proximity statement (Lemma 9.1).

Proof of Theorem 2. To lighten the notation, we omit $p_c(q), q$ from the subscripts. Recall the definition of the upper and lower envelopes $\Gamma_{\text{FK}}^{\pm, n}$ in G_n defined in Section 1, and of $\Gamma_{\text{FK}}^{\pm, n, m}$ in $G = G_{n,m}$ defined analogously. We will first show the statement for the FK measure $\text{FK}_{G_{n,Cn}}^{1/0}$ for C sufficiently large, and then from it derive the statement for $\text{FK}_{G_n}^{1/0}$.

By Theorem 11 and Lemmata 8.11 and 9.1, there exists $C > 1$ such that the statement holds for $\Gamma_{\text{FK}}^{\pm, n, Cn}$ under the measure $\text{FK}_{G_{n,Cn}}^{1/0}$. The derivation for $\Gamma_{\text{FK}}^{\pm, n}$ under

$\text{FK}_{G_n}^{1/0}$ follows from the FKG and DLR properties of FK percolation, and we only sketch the argument. Define the graphs $G_{n,Cn}^\pm = (V_{n,Cn}^\pm, E_{n,Cn}^\pm)$ by

$$\begin{aligned} \Lambda_{n,Cn}^- &:= \{-n, \dots, n\} \times \{-Cn, \dots, n\}, & \Lambda_{n,Cn}^+ &:= \{-n, \dots, n\} \times \{-n, \dots, Cn\}, \\ V_{n,Cn}^\pm &= \Lambda_{n,Cn}^\pm \cup (\partial^{\text{ex}} \Lambda_{n,Cn}^\pm \cap \mathbb{H}^+), & E_{n,Cn}^\pm &= \mathbb{E}_{V_{n,Cn}^\pm} \setminus \mathbb{E}_{(\Lambda_{n,Cn}^\pm)^c}. \end{aligned}$$

Then, by the FKG and DLR properties of the FK measures, it holds that

$$\text{FK}_{G_{n,Cn}}^{1/0} \geq_{\text{st}} \text{FK}_{G_{n,Cn}^+}^{1/0} \leq_{\text{st}} \text{FK}_{G_n}^{1/0} \leq_{\text{st}} \text{FK}_{G_{n,Cn}^-}^{1/0} \geq_{\text{st}} \text{FK}_{G_{n,Cn}}^{1/0}.$$

If ω is distributed according to $\text{FK}_{G_{n,Cn}}^{1/0}$, by the statement for $\Gamma_{\text{FK}}^{\pm, n, Cn}$ under this measure, there exists a left-right crossing above $[-n, n] \times \{0\}$ in ω and one in ω^* below it at arbitrary small linear distance from $[-n, n] \times \{0\}$. A chain of classical monotone coupling arguments finishes the proof. \square

9.2. Proof of Theorem 1. We will derive Theorem 1 from Theorem 2. Recall the definition of the one-sided Hausdorff distance d_{H} , and the notion of a subset of \mathbb{R}^2 being above or below a connected set in \mathbb{L}_\bullet or \mathbb{L}_\circ , introduced above Lemma 9.1.

Proof of Theorem 1. To simplify the notation, we omit $n, q, T_c(q), p_c(q)$ from sub and superscripts. Consider the Edwards–Sokal coupling $\text{ES}_\Lambda^{1/0}$ of $\sigma \sim \text{Potts}_\Lambda^{1/f}$ and $\omega \sim \text{FK}_{G_n}^{1/0}$ described in the introduction; see [Gri06, Section 1.4] for details. Observe that the FK and Potts envelopes deterministically satisfy

$$\Gamma_{\text{FK}}^-(k) \leq \Gamma_{\text{FK}}^+(k), \quad \Gamma_{\text{Potts}}^-(k) \leq \Gamma_{\text{Potts}}^+(k), \quad \Gamma_{\text{Potts}}^\pm(k) \leq \Gamma_{\text{FK}}^\pm(k) \quad \forall k \in \{-n, \dots, n\}.$$

In particular, Γ_{Potts}^+ is “sandwiched” between Γ_{Potts}^- and Γ_{FK}^+ . By Theorem 2, it suffices to show the existence of $c, C > 0$ for which, for any $k \geq 1$,

$$\text{ES}_\Lambda^{1/0}(d_{\text{H}}(\Gamma_{\text{Potts}}^-, \Gamma_{\text{FK}}^-) > k) < Cn^2 e^{-ck}.$$

Let \mathcal{C} be the cluster of the lower boundary in $\{\sigma \neq 1\}$, that is, the set of $i \in \Lambda$ for which there exists a path (i_0, \dots, i_ℓ) in Λ with $i_0 = i$, $i_\ell \in \partial^{\text{in}} \Lambda \cap \mathbb{H}^-$ and $\sigma(i_k) \neq 1$ for $0 \leq k \leq \ell$. By definition, each point in the lower envelope Γ_{Potts}^- is weakly above \mathcal{C} . Therefore, it suffices to show that Γ_{FK}^- is not far above \mathcal{C} . Fix a realisation C of \mathcal{C} , and define $\Lambda_C = \Lambda \setminus (C \cup \partial^{\text{ex}} C)$. By the coupling and the spatial Markov property of the Potts model, it holds that

$$\text{ES}_\Lambda^{1/0}(\sigma|_{\Lambda_C} \in \cdot \mid \mathcal{C} = C) = \text{Potts}_\Lambda^{1/f}(\sigma|_{\Lambda_C} \in \cdot \mid \mathcal{C} = C) = \text{Potts}_{\Lambda_C}^1.$$

Let $G_C = (V_C, E_C)$ be defined by $E_C = \mathbb{E}_{\Lambda_C} \cup \partial^{\text{edge}} \Lambda_C$ and $V_C = \mathbb{V}_{E_C}$. Then, by the above and by the coupling,

$$\text{ES}_\Lambda^{1/0}(\omega|_{E_C} \in \cdot \mid \mathcal{C} = C) = \text{FK}_{G_C}^1(\omega|_{E_C} \in \cdot).$$

Now, conditional on $\mathcal{C} = C$, if $d_{\text{H}}(C, \Gamma_{\text{FK}}^-) > k$, then there exists a dual path of length k in $\omega^*|_{*E_C}$. Since $\text{FK}_{G_C}^1$ stochastically dominates the infinite-volume measure FK^1 , which admits exponential decay of connection probabilities in its dual [DGH⁺21, Theorem 1.2], the proof is complete. \square

9.3. Proof of Theorems 3 and 6. Finally, the Ornstein-Zernike asymptotics for the two-point function of the AT and ATRC models (Theorems 3 and 6) are direct consequences of Theorem 9.

Proof of Theorems 3 and 6. Theorem 9 gives, in particular, that for $s \in \mathbb{S}^1$, one can find $t \in \partial\mathcal{W}$, $\delta \in (0, 1)$ such that (sums are over pieces confined in the cones/diamonds obtained using $\mathcal{Y}_{t,\delta}^\blacktriangleleft$)

$$\left| C \sum_{\gamma_L, \gamma_R} p_L(\gamma_L) p_R(\gamma_R) \sum_{k \geq 0} \sum_{\gamma_1, \dots, \gamma_k} \mathbb{1}_{X(\bar{\gamma})=ns} \prod_{i=1}^k p(\gamma_i) - e^{\nu(s)} \text{ATRC}_{J,U}(0 \overset{\omega_\tau}{\leftrightarrow} ns) \right| \leq C_1 e^{-c_1 n},$$

which is a comparison between $e^{\nu(s)} \text{ATRC}_{J,U}(0 \leftrightarrow ns)$ and the Green functions of a directed random walk on \mathbb{Z}^2 (the push-forward of p_L, p_R, p by X). One can then use the local limit theorem in dimension 2 as in [AOV24, Section 8.1] to obtain

$$e^{\nu(s)} \text{ATRC}_{J,U}(0 \leftrightarrow ns) = \frac{c(s)}{\sqrt{n}} (1 + o_n(1)), \quad (74)$$

which is the wanted asymptotics for the ATRC model. The claim for the AT model follows from the coupling (7) between AT and ATRC, . \square

APPENDIX A. MIXING TO RATIO MIXING

We prove here a technical Lemma whose use is recurrent in the proof that mixing implies ratio mixing under suitable conditions. It is a simplified version of the argument in [Ale98, Section 5].

Lemma A.1. *Let Ω_i , $i = 1, 2$ be finite sets. Let $\Omega = \Omega_1 \times \Omega_2$ and $\mathcal{F}_i = \{A \subset \Omega_i\}$, $\mathcal{F} = \{A \subset \Omega\}$. Let μ, ν be positive probability measures on (Ω, \mathcal{F}) . Let*

$$\pi_i : \Omega \rightarrow \Omega_i, \quad \pi_i((\omega_1, \omega_2)) = \omega_i, \quad \mu_i = \mu \circ \pi_i^{-1}.$$

Let $\epsilon_1, \epsilon_2, \epsilon_3 \in [0, 1)$. Suppose that all of the following hold:

(1) *Mixing of μ, ν : for every $\xi, \xi' \in \Omega_1$, $A \subset \Omega_2$, $\rho \in \{\mu, \nu\}$*

$$|\rho(\Omega_1 \times A \mid \{\xi\} \times \Omega_2) - \rho(\Omega_1 \times A \mid \{\xi'\} \times \Omega_2)| \leq \epsilon_1$$

(2) *Proximity between second marginals: $d_{\text{TV}}(\mu_2, \nu_2) \leq \epsilon_2$;*

(3) *Conditional equality: there exists an event $D \subset \Omega_2$ such that for $\rho \in \{\mu_2, \nu_2\}$, $\rho(D) \geq 1 - \epsilon_3$, and for any $y \in D$,*

$$\frac{\mu(x, y)}{\mu_2(y)} = \frac{\nu(x, y)}{\nu_2(y)}, \quad \forall x \in \Omega_1.$$

Then, if $\epsilon = \max(\epsilon_1, \sqrt{\epsilon_2}, \epsilon_3) \leq 0.1$, then, for any $x \in \Omega_1$,

$$1 - 9\epsilon \leq \frac{\mu_1(x)}{\nu_1(x)} \leq \frac{1}{1 - 9\epsilon}.$$

Proof. The proof goes by constructing a suitable coupling of μ, ν . Let Q be a maximal coupling of μ_2 and ν_2 . Then, sample a random vector $(X, Y) = ((X_1, X_2), (Y_1, Y_2))$ as follows:

- (1) sample (X_2, Y_2) using Q ;
- (2) sample X_1 using $\mu(\cdot \mid \Omega_1 \times \{X_2\}) \circ \pi_1^{-1}$;

- (3) if $X_2 = Y_2 \in D$, set $Y_1 = X_1$. Else, sample $Y_1 \sim \nu(\cdot | \Omega_1 \times \{Y_2\}) \circ \pi_1^{-1}$ independently of X_1 .

Denote Ψ the law of (X, Y) .

Claim 7. *All the following points hold.*

- (1) Ψ is a coupling of μ and ν .
- (2) $(X_2 = Y_2 \in D) \implies (X_1 = Y_1)$.
- (3) X_1 and Y_2 are independent conditionally on X_2 , and Y_1 and X_2 are independent conditionally on Y_2 .

Proof. The second point is by construction. We check the first point. For $x = (x_1, x_2) \in \Omega$,

$$\begin{aligned} \Psi(X = x) &= \sum_{y_2 \in \Omega_2} Q(x_2, y_2) \Psi(X_1 = x_1 | X_2 = x_2, Y_2 = y_2) \\ &= \sum_{y_2 \in \Omega_2} Q(x_2, y_2) \frac{\mu(x_1, x_2)}{\mu_2(x_2)} = \mu(x_1, x_2). \end{aligned}$$

Also, for $y = (y_1, y_2) \in \Omega$,

$$\begin{aligned} \Psi(Y = y) &= \sum_{x_2 \in \Omega_2} Q(x_2, y_2) \Psi(Y_1 = y_1 | X_2 = x_2, Y_2 = y_2) \\ &= \sum_{x_2 \in \Omega_2} Q(x_2, y_2) \left(\mathbb{1}_{y_2 = x_2 \in D} \frac{\mu(y_1, x_2)}{\mu_2(x_2)} + (1 - \mathbb{1}_{y_2 = x_2 \in D}) \frac{\nu(y_1, y_2)}{\nu_2(y_2)} \right) \\ &= \sum_{x_2 \in \Omega_2} Q(x_2, y_2) \frac{\nu(y_1, y_2)}{\nu_2(y_2)} = \nu(y_1, y_2), \end{aligned}$$

as, by hypotheses on D , $\mathbb{1}_{y_2 = x_2 \in D} \frac{\mu(y_1, x_2)}{\mu_2(x_2)} = \mathbb{1}_{y_2 = x_2 \in D} \frac{\mu(y_1, y_2)}{\mu_2(y_2)} = \mathbb{1}_{y_2 = x_2 \in D} \frac{\nu(y_1, y_2)}{\nu_2(y_2)}$.

Let us finally check the third point. First, for any $x_1 \in \Omega_1, x_2, y_2 \in \Omega_2$,

$$\Psi(X_1 = x_1 | X_2 = x_2, Y_2 = y_2) = \frac{\mu(x_1, x_2)}{\mu_2(x_2)} = \Psi(X_1 = x_1 | X_2 = x_2).$$

Then, for any $y_1 \in \Omega_1, x_2, y_2 \in \Omega_2$,

$$\begin{aligned} \Psi(Y_1 = y_1 | X_2 = x_2, Y_2 = y_2) &= \mathbb{1}_{y_2 = x_2 \in D} \frac{\mu(y_1, x_2)}{\mu_2(x_2)} + (1 - \mathbb{1}_{y_2 = x_2 \in D}) \frac{\nu(y_1, y_2)}{\nu_2(y_2)} \\ &= \frac{\nu(y_1, y_2)}{\nu_2(y_2)} = \Psi(Y_1 = y_1 | Y_2 = y_2), \end{aligned}$$

by hypotheses on D , as before. \square

Introduce then $g, h : \Omega_2 \rightarrow \mathbb{R}_+$ defined by

$$\begin{aligned} g(\xi) &= \Psi(X_2 \neq Y_2 | X_2 = \xi), \\ h(\xi) &= \Psi(X_2 \neq Y_2 | Y_2 = \xi). \end{aligned}$$

Define the event H by

$$H = \{X_2 = Y_2\} \cap \{X_2 \in D\} \cap \{Y_2 \in D\} \cap \{g(X_2) \leq \sqrt{\epsilon_2}\} \cap \{h(Y_2) \leq \sqrt{\epsilon_2}\}.$$

Claim 8. *One has*

$$\begin{aligned}\max_{x_1 \in \Omega_2} \Psi(H^c | X_1 = x_1) &\leq 9\epsilon, \\ \max_{y_1 \in \Omega_2} \Psi(H^c | Y_1 = y_1) &\leq 9\epsilon.\end{aligned}$$

Proof. Let $a = \sqrt{\epsilon_2}$. First, let $\{g > a\} = \{x_2 \in \Omega_2 : g(x_2) > a\}$, one has

$$\begin{aligned}\mu(\Omega_1 \times \{g > a\}) &= \Psi(g(X_2) > a) \leq a^{-1} \Psi(g(X_2)) = a^{-1} \Psi(\Psi(X_2 \neq Y_2 | X_2)) \\ &= a^{-1} \Psi(X_2 \neq Y_2) \leq \frac{\epsilon_2}{a},\end{aligned}$$

as $\Psi(X_2 \neq Y_2) = Q(X_2 \neq Y_2) = d_{\text{TV}}(\mu_2, \nu_2) \leq \epsilon_2$, and the same for $\nu(\Omega_1 \times \{h > a\})$. Now, by our first hypotheses,

$$\begin{aligned}\Psi(g(X_2) > a | X_1 = x_1) &= \mu(\Omega_1 \times \{g > a\} | \{x_1\} \times \Omega_2) \\ &\leq \mu(\Omega_1 \times \{g > a\}) + \epsilon_1 = \frac{\epsilon_2}{a} + \epsilon_1,\end{aligned}$$

and the same for $\Psi(h(Y_2) > a | Y_1 = y_1)$. Also,

$$\Psi(X_2 \in D^c | X_1 = x_1) = \mu(\Omega_1 \times D^c | \{x_1\} \times \Omega_2) \leq \mu(\Omega_1 \times D^c) + \epsilon_1 = \epsilon_3 + \epsilon_1,$$

and the same for $\Psi(Y_2 \in D^c | Y_1 = y_1)$.

Then, as X_1 and Y_2 are independent conditionally on X_2 (by Claim 7),

$$\begin{aligned}\Psi(X_2 \neq Y_2, g(X_2) \leq a | X_1 = x_1) &= \sum_{x_2: g(x_2) \leq a} \Psi(X_2 = x_2 | X_1 = x_1) \Psi(Y_2 \neq x_2 | X_2 = x_2) \\ &= \sum_{x_2: g(x_2) \leq a} \Psi(X_2 = x_2 | X_1 = x_1) g(x_2) \leq a.\end{aligned}$$

In the same fashion, $\Psi(X_2 \neq Y_2, h(Y_2) \leq a | Y_1 = y_1) \leq a$. Finally,

$$\begin{aligned}\Psi(X_2 = Y_2 \in D, h(Y_2) > a | X_1 = x_1) &= \Psi(X_2 = Y_2 \in D | X_1 = x_1) \Psi(h(Y_2) > a | X_1 = x_1, X_2 = Y_2 \in D) \\ &= \Psi(X_2 = Y_2 \in D | X_1 = x_1) \Psi(h(Y_2) > a | Y_1 = x_1, X_2 = Y_2 \in D) \\ &= \frac{\Psi(X_2 = Y_2 \in D | X_1 = x_1)}{\Psi(X_2 = Y_2 \in D | Y_1 = x_1)} \Psi(X_2 = Y_2 \in D, h(Y_2) > a | Y_1 = x_1) \\ &\leq \frac{\epsilon_2/a + \epsilon_1}{1 - 2\epsilon_1 - \epsilon_3 - \epsilon_2/a - a},\end{aligned}$$

where the second equality is because $X_2 = Y_2 \in D \implies X_1 = Y_1$, and the inequality is the previous bounds, and a union bound on $\Psi(\{X_2 = Y_2 \in D\}^c | Y_1 = x_1)$. Putting things together,

$$\begin{aligned}\Psi(H^c | X_1 = x_1) &\leq \Psi(X_2 \in D^c | X_1 = x_1) + \Psi(g(X_2) > a | X_1 = x_1) \\ &\quad + \Psi(X_2 \neq Y_2, g(X_2) \leq a | X_1 = x_1) \\ &\quad + \Psi(X_2 = Y_2 \in D, h(Y_2) > a | X_1 = x_1) \\ &\leq \epsilon_3 + \epsilon_1 + \frac{\epsilon_2}{a} + \epsilon_1 + a + \frac{\epsilon_2/a + \epsilon_1}{1 - 2\epsilon_1 - \epsilon_3 - \epsilon_2/a - a}.\end{aligned}$$

One obtains the same bound on $\Psi(H^c | Y_1 = y_1)$ in the same way (with $h \leftrightarrow g$ and $Y_2 \leftrightarrow X_2$). Plugging in $a = \sqrt{\epsilon_2}$ and using the definition of ϵ gives that the last display is upper bounded by

$$5\epsilon + \frac{2\epsilon}{1 - 5\epsilon} \leq 9\epsilon,$$

as $\epsilon \leq 0.1$ by hypotheses. \square

Let us now see how Claims 7 and 8 imply the wanted result. As Ψ is a coupling,

$$\frac{\mu_1(\xi)}{\nu_1(\xi)} = \frac{\Psi(X_1 = \xi)}{\Psi(Y_1 = \xi)} = \frac{\Psi(X_1 = \xi)\Psi(Y_1 = \xi, H)}{\Psi(Y_1 = \xi)\Psi(X_1 = \xi, H)} = \frac{\Psi(H | Y_1 = \xi)}{\Psi(H | X_1 = \xi)},$$

where the second equality is because $\{X_1 = Y_1\}$ under H (as $\{X_2 = Y_2 \in D\} \subset H$). But now,

$$1 - 9\epsilon \leq 1 - \Psi(H^c | Y_1 = \xi) \leq \frac{\Psi(H | Y_1 = \xi)}{\Psi(H | X_1 = \xi)} \leq \frac{1}{1 - \Psi(H^c | X_1 = \xi)} \leq \frac{1}{1 - 9\epsilon}.$$

\square

REFERENCES

- [ADG24] Yacine Aoun, Moritz Dober, and Alexander Glazman, *Phase diagram of the Ashkin–Teller model*, Communications in Mathematical Physics **405** (2024), no. 2, 37.
- [AK77] D. B. Abraham and H. Kunz, *Ornstein–Zernike theory of classical fluids at low density*, Phys. Rev. Lett. **39** (1977), no. 16, 1011–1014. MR 452115
- [Ale92] Kenneth S. Alexander, *Stability of the Wulff minimum and fluctuations in shape for large finite clusters in two-dimensional percolation*, Probab. Theory Related Fields **91** (1992), no. 3-4, 507–532. MR 1151807 (93e:60191)
- [Ale98] ———, *On weak mixing in lattice models*, Probab. Theory Related Fields **110** (1998), no. 4, 441–471. MR 1626951 (99e:60211)
- [Ale01] Kenneth S Alexander, *Power-law corrections to exponential decay of connectivities and correlations in lattice models*, Annals of probability (2001), 92–122.
- [Ale04] Kenneth S. Alexander, *Mixing properties and exponential decay for lattice systems in finite volumes*, Ann. Probab. **32** (2004), no. 1A, 441–487. MR 2040789 (2004m:60217)
- [AOV24] Y. Aoun, S. Ott, and Y. Velenik, *Ornstein–Zernike behavior for Ising models with infinite-range interactions*, Annales de l’Institut Henri Poincaré (B) Probabilités et statistiques **60** (2024), no. 1, 167–207.
- [AT43] J. Ashkin and E. Teller, *Statistics of two-dimensional lattices with four components*, Physical Review **64** (1943), no. 5-6, 178–184.
- [BD12] V. Beffara and H. Duminil-Copin, *Smirnov’s fermionic observable away from criticality*, Ann. Probab. **40** (2012), no. 6, 2667–2689. MR 3050513
- [BKW76] R J Baxter, S B Kelland, and F Y Wu, *Equivalence of the Potts model or Whitney polynomial with an ice-type model*, Journal of Physics A: Mathematical and General **9** (1976), no. 3, 397–406.
- [CC86] J. T. Chayes and L. Chayes, *Ornstein–Zernike behavior for self-avoiding walks at all noncritical temperatures*, Comm. Math. Phys. **105** (1986), no. 2, 221–238. MR 849206
- [CCC91] Massimo Campanino, JT Chayes, and L Chayes, *Gaussian fluctuations of connectivities in the subcritical regime of percolation*, Probability theory and related fields **88** (1991), no. 3, 269–341.
- [CDH⁺14] Dmitry Chelkak, Hugo Duminil-Copin, Clément Hongler, Antti Kemppainen, and Stanislav Smirnov, *Convergence of Ising interfaces to Schramm’s SLE curves*, C. R. Math. Acad. Sci. Paris **352** (2014), no. 2, 157–161. MR 3151886
- [CI02] Massimo Campanino and Dmitry Ioffe, *Ornstein–Zernike theory for the Bernoulli bond percolation on \mathbb{Z}^d* , Ann. Probab. **30** (2002), no. 2, 652–682. MR 1905854 (2003e:60216)
- [CIV03] Massimo Campanino, Dmitry Ioffe, and Yvan Velenik, *Ornstein–Zernike theory for finite range Ising models above T_c* , Probab. Theory Related Fields **125** (2003), no. 3, 305–349. MR 1964456 (2005b:82016)

- [CIV08] ———, *Fluctuation theory of connectivities for subcritical random cluster models*, Ann. Probab. **36** (2008), no. 4, 1287–1321. MR 2435850 (2009m:60228)
- [CM97] L. Chayes and J. Machta, *Graphical representations and cluster algorithms i. discrete spin systems*, Physica A: Statistical Mechanics and its Applications **239** (1997), no. 4, 542–601.
- [CS11] Dmitry Chelkak and Stanislav Smirnov, *Discrete complex analysis on isoradial graphs*, Adv. Math. **228** (2011), no. 3, 1590–1630.
- [DC17] Hugo Duminil-Copin, *Lectures on the Ising and Potts models on the hypercubic lattice*, PIMS-CRM Summer School in Probability, Springer, 2017, pp. 35–161.
- [DCKMO24] Hugo Duminil-Copin, Alex M Karrila, Ioan Manolescu, and Mendes Oulamara, *Delocalization of the height function of the six-vertex model*, Journal of the European Mathematical Society (2024).
- [DGH⁺21] Hugo Duminil-Copin, Maxime Gagnebin, Matan Harel, Ioan Manolescu, and Vincent Tassion, *Discontinuity of the phase transition for the planar random-cluster and Potts models with $q > 4$* , Annales Scientifiques de l’Ecole Normale Supérieure, vol. 54, SOC Mathématique France, 2021, pp. 1363–1413.
- [DST17] Hugo Duminil-Copin, Vladas Sidoravicius, and Vincent Tassion, *Continuity of the phase transition for planar random-cluster and Potts models with $1 \leq q \leq 4$* , Comm. Math. Phys. **349** (2017), no. 1, 47–107.
- [ES88] Robert G. Edwards and Alan D. Sokal, *Generalization of the Fortuin-Kasteleyn-Swendsen-Wang representation and Monte Carlo algorithm*, Phys. Rev. D (3) **38** (1988), no. 6, 2009–2012. MR 965465
- [Fan72a] C. Fan, *On critical properties of the Ashkin-Teller model*, Physics Letters A **39** (1972), no. 2, 136.
- [Fan72b] Chungpeng Fan, *Remarks on the eight-vertex model and the ashkin-teller model of lattice statistics*, Phys. Rev. Lett. **29** (1972), 158–160.
- [FK72] C. M. Fortuin and P. W. Kasteleyn, *On the random-cluster model. I. Introduction and relation to other models*, Physica **57** (1972), 536–564.
- [FKG71] C. M. Fortuin, P. W. Kasteleyn, and J. Ginibre, *Correlation inequalities on some partially ordered sets*, Comm. Math. Phys. **22** (1971), 89–103.
- [GHM01] Hans-Otto Georgii, Olle Häggström, and Christian Maes, *The random geometry of equilibrium phases*, Phase transitions and critical phenomena, Vol. 18, Phase Transit. Crit. Phenom., vol. 18, Academic Press, San Diego, CA, 2001, pp. 1–142. MR 2014387 (2004h:82022)
- [GL23] Alexander Glazman and Piet Lammers, *Delocalisation and continuity in 2D: loop $O(2)$, six-vertex, and random-cluster models*, arXiv preprint arXiv:2306.01527 (2023).
- [GM23] Alexander Glazman and Ioan Manolescu, *Structure of Gibbs measures for planar FK-percolation and Potts models*, Probability and Mathematical Physics **4** (2023), no. 2, 209–256.
- [GP23] Alexander Glazman and Ron Peled, *On the transition between the disordered and anti-ferroelectric phases of the 6-vertex model*, Electronic Journal of Probability **28** (2023), 1–53.
- [Gri06] G. Grimmett, *The random-cluster model*, Grundlehren der Mathematischen Wissenschaften [Fundamental Principles of Mathematical Sciences], vol. 333, Springer-Verlag, Berlin, 2006.
- [HDJS13] Yuan Huang, Youjin Deng, Jesper Lykke Jacobsen, and Jesús Salas, *The Hintermann-Merlini-Baxter-Wu and the infinite-coupling-limit Ashkin-Teller models*, Nuclear Phys. B **868** (2013), no. 2, 492–538. MR 3006181
- [Hol74] Richard Holley, *Remarks on the FKG inequalities*, Comm. Math. Phys. **36** (1974), 227–231. MR 0341552 (49 #6300)
- [HS22] Matan Harel and Yinon Spinka, *Finitary codings for the random-cluster model and other infinite-range monotone models*, Electronic Journal of Probability **27** (2022), no. none, 1 – 32.
- [Iof98] D. Ioffe, *Ornstein-Zernike behaviour and analyticity of shapes for self-avoiding walks on \mathbf{Z}^d* , Markov Process. Related Fields **4** (1998), no. 3, 323–350. MR 1670027 (2000d:60162)

- [IOSV22] D. Ioffe, S. Ott, S. Shlosman, and Y. Velenik, *Critical prewetting in the 2d Ising model*, Ann. of Prob. **50** (2022), no. 3, 1127–1172.
- [Kes82] H. Kesten, *Percolation theory for mathematicians*, Progress in Probability and Statistics, vol. 2, Birkhäuser Boston, Mass., 1982. MR 692943 (84i:60145)
- [Kov04] Yevgeniy Kovchegov, *The Brownian bridge asymptotics in the subcritical phase of Bernoulli bond percolation model*, Markov Process. Related Fields **10** (2004), no. 2, 327–344.
- [KS68] D.G. Kelly and S. Sherman, *General Griffiths’s inequality on correlation in Ising ferromagnets*, J. Math. Phys. **9** (1968), 466–484.
- [KW71] Leo P. Kadanoff and Franz J. Wegner, *Some critical properties of the eight-vertex model*, Phys. Rev. B **4** (1971), 3989–3993, [10.1103/PhysRevB.4.3989](https://doi.org/10.1103/PhysRevB.4.3989).
- [Lis21] Marcin Lis, *On delocalization in the six-vertex model*, Communications in Mathematical Physics **383** (2021), no. 2, 1181–1205.
- [Lis22] ———, *Spins, percolation and height functions*, Electronic Journal of Probability **27** (2022), 1–21.
- [MMSRS91] Alain Messenger, Salvador Miracle-Sole, Jean Ruiz, and Senya Shlosman, *Interfaces in the potts model ii: Antonov’s rule and rigidity of the order disorder interface*, Communications in mathematical physics **140** (1991), 275–290.
- [MS71] L. Mittag and M. J. Stephen, *Dual transformations in many-component Ising models*, Journal of Mathematical Physics **12** (1971), no. 3, 441–450, [doi:10.1063/1.1665606](https://doi.org/10.1063/1.1665606).
- [Ott25] Sebastien Ott, *A new perspective on the equivalence between Weak and Strong Spatial Mixing in two dimensions*, 2025.
- [OV18] Sébastien Ott and Yvan Velenik, *Potts models with a defect line*, Comm. Math. Phys. **362** (2018), no. 1, 55–106. MR 3833604
- [OZ14] Leonard S Ornstein and F Zernike, *Accidental deviations of density and opalescence at the critical point of a single substance*, Proc. Akad. Sci. **17** (1914), 793.
- [Pau35] Linus Pauling, *The structure and entropy of ice and of other crystals with some randomness of atomic arrangement*, Journal of the American Chemical Society **57** (1935), no. 12, 2680–2684.
- [Pot52] Renfrey Burnard Potts, *Some generalized order-disorder transformations*, Proceedings of the Cambridge Philosophical Society, vol. 48(2), Cambridge Univ Press, 1952, pp. 106–109.
- [PV97] C.-E. Pfister and Y. Velenik, *Random-cluster representation of the Ashkin-Teller model*, J. Statist. Phys. **88** (1997), no. 5-6, 1295–1331. MR 1478070
- [Roc70] Ralph Tyrell Rockafellar, *Convex analysis*, Princeton University Press, Princeton, 1970.
- [RS20] Gourab Ray and Yinon Spinka, *A short proof of the discontinuity of phase transition in the planar random-cluster model with $q > 4$* , Communications in Mathematical Physics **378** (2020), no. 3, 1977–1988.
- [Rys63] Franz Rys, *Über ein zweidimensionales klassisches Konfigurationsmodell*, Helvetica Physica Acta, vol. 36, Birkhauser Verlag AG Viadukstrasse 40-44, PO Box 133, CH-4010 Basel, Switzerland, 1963, p. 537.
- [Sch00] Oded Schramm, *Scaling limits of loop-erased random walks and uniform spanning trees*, Israel J. Math. **118** (2000), 221–288.
- [Smi10] Stanislav Smirnov, *Conformal invariance in random cluster models. I. Holomorphic fermions in the Ising model*, Ann. of Math. (2) **172** (2010), no. 2, 1435–1467.
- [Weg72] F. Wegner, *Duality relation between the Ashkin-Teller and the eight-vertex model*, Journal of physics. C, Solid state physics **5** (1972), no. 11, L131–L132.
- [Wu71] F.W. Wu, *Ising model with four-spin interactions*, Phys. Rev. B **4** (1971), 2312–2314.
- [Zer16] F Zernike, *The clustering-tendency of the molecules in the critical state and the extinction of light caused thereby*, Koninklijke Nederlandse Akademie van Wetenschappen Proceedings Series B Physical Sciences **18** (1916), 1520–1527.

FAKULTÄT FÜR MATHEMATIK, UNIVERSITÄT WIEN, VIENNA, AUSTRIA
Email address: `moritz.dober@univie.ac.at`

UNIVERSITÄT INNSBRUCK, INNSBRUCK, AUSTRIA
Email address: `alexander.glazman@uibk.ac.at`

INSTITUTE OF MATHEMATICS, EPFL, 1015 LAUSANNE, SWITZERLAND
Email address: `ott.sebast@gmail.com`