



Search for charged Higgs bosons produced in top-quark decays or in association with top quarks and decaying via $H^\pm \rightarrow \tau^\pm \nu_\tau$ in 13 TeV pp collisions with the ATLAS detector

The ATLAS Collaboration

Charged Higgs bosons produced either in top-quark decays or in association with a top-quark, subsequently decaying via $H^\pm \rightarrow \tau^\pm \nu_\tau$, are searched for in 140 fb^{-1} of proton–proton collision data at $\sqrt{s} = 13 \text{ TeV}$ recorded with the ATLAS detector. Depending on whether the top-quark produced together with the H^\pm decays hadronically or semi-leptonically, the search targets τ +jets or τ +lepton final states, in both cases with a τ -lepton decaying into a neutrino and hadrons. No significant excess over the Standard Model background expectation is observed. For the mass range of $80 \leq m_{H^\pm} \leq 3000 \text{ GeV}$, upper limits at 95% confidence level are set on the production cross-section of the charged Higgs boson times the branching fraction $\mathcal{B}(H^\pm \rightarrow \tau^\pm \nu_\tau)$ in the range 4.5 pb–0.4 fb. In the mass range 80–160 GeV, assuming the Standard Model cross-section for $t\bar{t}$ production, this corresponds to upper limits between 0.27% and 0.02% on $\mathcal{B}(t \rightarrow bH^\pm) \times \mathcal{B}(H^\pm \rightarrow \tau^\pm \nu_\tau)$.

1 Introduction

The discovery of a new boson at the Large Hadron Collider (LHC) [1] in 2012 [2, 3], with a measured mass close to 125 GeV [4–6], opens the question of whether this particle could be part of an extended scalar sector. Charged Higgs bosons¹ are predicted in several extensions of the Standard Model (SM) that add a second doublet [7, 8] or triplets [9–12] to its scalar sector. For H^+ masses below the top-quark mass ($m_{H^+} < m_{\text{top}}$), the main production mechanism is through the decay of a top-quark, $t \rightarrow bH^+$, in a double-resonant top-quark production ($t\bar{t}$). In this mass range, the decay $H^+ \rightarrow \tau\nu$ usually dominates in a two-Higgs-doublet model (2HDM) type-II, although $H^+ \rightarrow cs$ and cb may also become sizable at low ratio of the vacuum expectation values of the two Higgs doublets, $\tan\beta$. For H^+ masses above the top-quark mass ($m_{H^+} > m_{\text{top}}$), the leading production mode is $gg \rightarrow tbH^+$ (single-resonant top-quark production) [13]. For the heavy H^+ , the $H^+ \rightarrow tb$ channel is dominant, but since the coupling of H^+ to leptons is proportional to $\tan\beta$, the branching fraction $H^+ \rightarrow \tau\nu$ remains sizable for large values of $\tan\beta$. In the intermediate-mass region ($m_{H^+} \simeq m_{\text{top}}$) the H^+ production occurs via the double-resonant, single-resonant and top-quark exchange production processes, along with their interference [14]. Figure 1 illustrates the main production modes for charged Higgs bosons in proton-proton (pp) collisions.

There are many earlier searches for charged Higgs bosons at colliders. The LEP experiments excluded the H^+ mass below 80 GeV at 95% confidence level (CL), considering only the decays $H^+ \rightarrow cs$ and $H^+ \rightarrow \tau\nu$ under the assumption $\mathcal{B}(H^+ \rightarrow cs) + \mathcal{B}(H^+ \rightarrow \tau\nu) = 1$ [15]. The ATLAS and CMS collaborations searched for charged Higgs bosons in Run 1 with pp collisions at $\sqrt{s} = 7\text{--}8$ TeV probing the mass range below the top-quark mass with the $\tau\nu$ [16–20], cb [21] and cs [22, 23] decay modes, as well as the mass range above the top-quark mass with the $\tau\nu$, tb , WZ decay modes [18, 20, 24, 25]. Both experiments also performed searches with Run 2 pp collisions at $\sqrt{s} = 13$ TeV in the $\tau\nu$ [26, 27], tb [28, 29], WZ [30, 31], HW [32, 33], cb [34] and cs [35, 36] decay channels. The intermediate mass region was probed for the first time in the search for $H^+ \rightarrow \tau\nu$ [26, 27].

No evidence of charged Higgs bosons was found in any of these searches. The ATLAS and CMS experiments also searched for neutral scalar resonances decaying to a τ -lepton pair [37, 38], sensitive to the

¹ In the following, charged Higgs bosons are denoted H^+ , with the charge-conjugate H^- always implied. Generic symbols are also used for particles produced in association with charged Higgs bosons and in their decays.

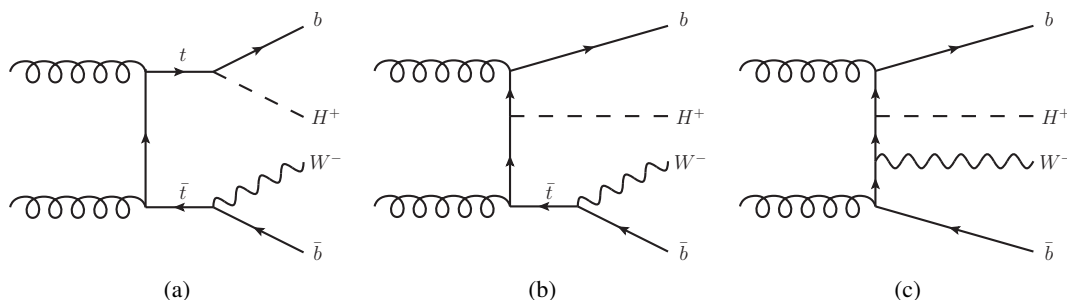

Figure 1: Examples of leading-order Feynman diagrams contributing to the production of charged Higgs bosons in pp collisions: (a) double-resonant top-quark production that dominates at low H^+ masses, (b) single-resonant top-quark production that dominates at large H^+ masses, (c) top-quark exchange production. The interference between these three main diagrams becomes most relevant in the intermediate-mass region.

hMSSM [39, 40] in some regions of its parameter space. A recent Run 2 $H^+ \rightarrow cb$ analysis by the ATLAS Collaboration [34] observed an excess above the SM background with a global significance of 2.5σ at the 130 GeV H^+ mass hypothesis. This result, coupled with the tension in semileptonic B -meson decays from the combination of measurements at several flavor experiments [41], support the viability of the 2HDM which can accommodate flavor changing neutral currents [42, 43]. Therefore, further investigation into the decays of the charged Higgs boson is well motivated [44].

This publication describes a search for charged Higgs bosons in the mass range 80–3000 GeV, produced either in top-quark decays or in association with a top-quark, decaying via $H^+ \rightarrow \tau\nu$, with a subsequent decay of the τ -lepton into a neutrino and hadrons (referred to as τ_{had}). Depending on the decay mode of the W boson originating from the top-quark produced together with the H^+ , two channels are targeted: $\tau_{\text{had}}+\text{jets}$ if the W boson decays into a $q\bar{q}'$ pair, or $\tau_{\text{had}}+\text{lepton}$ if the W boson decays into an electron or muon and at least one neutrino (directly or via a leptonically decaying τ -lepton). The search is optimized for a generic 2HDM type-II scenario [8] and results are presented as 95% CL upper limits on cross-section times branching fraction for the H^+ production and decay to the $\tau\nu$ final state. Interpretations are performed in the context of the hMSSM and the M_h^{125} scenario of the MSSM where all superpartners are chosen to be heavy [45].

This analysis uses the full Run 2 dataset of pp collisions at $\sqrt{s} = 13$ TeV collected with the ATLAS experiment at the LHC, corresponding to 140 fb^{-1} , and thus it supersedes the result of an earlier search based on the partial Run 2 dataset [26]. With respect to the previous analysis, the mass range of the search is expanded (previously 90–2500 GeV), the identification of τ_{had} candidates benefits from a new approach based on recurrent neural networks providing better signal purity, and the data-driven estimation of background from misidentified τ_{had} candidates is upgraded. Additionally, the modeling of the efficiency of the missing transverse energy trigger in simulation, as well as the modeling of $t\bar{t}$ and $W+\text{jets}$ backgrounds is improved. The final signal-to-background discriminating variable is changed from a boosted decision tree [46] to a mass parameterized neural network (PNN) [47], similar to e.g. the H^+ search in the tb channel presented in Ref. [28]. These improvements result in an increased sensitivity to a hypothetical H^+ signal by up to a factor of two (four) in the low (high) mass region compared to the previous ATLAS search [26].

2 ATLAS detector

The ATLAS experiment [48] at the LHC is a multipurpose particle detector with a forward–backward symmetric cylindrical geometry and a near 4π coverage in solid angle.² It consists of an inner tracking detector surrounded by a thin superconducting solenoid providing a 2 T axial magnetic field, electromagnetic and hadronic calorimeters, and a muon spectrometer. The inner tracking detector covers the pseudorapidity range $|\eta| < 2.5$. It consists of silicon pixel, silicon microstrip, and transition radiation tracking detectors. Lead/liquid-argon (LAr) sampling calorimeters provide electromagnetic (EM) energy measurements with high granularity within the region $|\eta| < 3.2$. A steel/scintillator-tile hadronic calorimeter covers the central pseudorapidity range ($|\eta| < 1.7$). The endcap and forward regions are instrumented with LAr calorimeters for EM and hadronic energy measurements up to $|\eta| = 4.9$. The muon spectrometer surrounds

² ATLAS uses a right-handed coordinate system with its origin at the nominal interaction point (IP) in the centre of the detector and the z -axis along the beam pipe. The x -axis points from the IP to the centre of the LHC ring, and the y -axis points upwards. Polar coordinates (r, ϕ) are used in the transverse plane, ϕ being the azimuthal angle around the z -axis. The pseudorapidity is defined in terms of the polar angle θ as $\eta = -\ln \tan(\theta/2)$ and is equal to the rapidity $y = \frac{1}{2} \ln \left(\frac{E+p_z}{E-p_z} \right)$ in the relativistic limit. Angular distance is measured in units of $\Delta R \equiv \sqrt{(\Delta y)^2 + (\Delta\phi)^2}$.

the calorimeters and is based on three large superconducting air-core toroidal magnets with eight coils each. The field integral of the toroids ranges between 2.0 and 6.0 T m across most of the detector. The muon spectrometer includes a system of precision tracking chambers up to $|\eta| = 2.7$ and fast detectors for triggering up to $|\eta| = 2.4$. The luminosity is measured mainly by the LUCID-2 [49] detector, which is located close to the beampipe. A two-level trigger system is used to select events [50]. The first-level trigger is implemented in hardware and uses a subset of the detector information to accept events at a rate below 100 kHz. This is followed by a software-based trigger that reduces the accepted event rate to 1 kHz on average depending on the data-taking conditions. A software suite [51] is used in data simulation, in the reconstruction and analysis of real and simulated data, in detector operations, and in the trigger and data acquisition systems of the experiment.

3 Data and simulated event samples

The dataset used in this analysis, collected during stable beam conditions and with all ATLAS subsystems fully operational, corresponds to an integrated luminosity of 140 fb^{-1} of pp collisions at $\sqrt{s} = 13 \text{ TeV}$ collected during 2015–2018 [52].

The simulated Monte Carlo (MC) samples used are based on the ATLAS full GEANT4 simulation [53, 54] and are reconstructed using the same analysis chain as the data. SM background samples include $t\bar{t}$ and single-top-quark production, W and Z plus jets with leptonic vector boson decays and diboson production. All samples are scaled by k -factors so that the estimated background yields correspond to the recent theoretical predictions on the cross-sections at next-to-next-to-leading order (NNLO) or next-to-leading order (NLO). Finally, all MC events are overlaid with additional minimum-bias events generated with PYTHIA v8.186 [55] using the A3 set of tuned parameters [56] and the NNPDF2.3LO [57] set of parton distribution functions (PDF) to simulate the effect of multiple pp collisions per bunch crossing (pile-up), at a variable rate. The simulated events are then weighted to match the pile-up distribution observed in data. The full list of simulated SM backgrounds is presented in Table 1.

Simulated events of H^+ signal are generated in three distinct mass regions using the narrow-width approximation with MADGRAPH5_AMC@NLO [63] at either LO or NLO in QCD using the respective NNPDF3.0 set. The choice of renormalization and factorization scale settings is motivated by Refs. [13, 14].

1. In the low mass region ($m_{H^+} < 140 \text{ GeV}$), $t\bar{t}$ events with a subsequent decay of one top-quark to a H^+ and a bottom-quark are generated using LO calculations only. The type-II 2HDM model is used and dynamic renormalization and factorization QCD scales are chosen ($\mu_R = \mu_F = H_T/2 = 1/2 \sum_i \sqrt{m_i^2 + p_{Ti}^2}$, where the sum goes over all final state partons from the hard scatter). The contribution from $t\bar{t}$ events with both top quarks decaying to bH^+ and single-top-quark events with a subsequent $t \rightarrow bH^+$ decay is negligible.
2. In the intermediate mass region ($140 \text{ GeV} \leq m_{H^+} < 200 \text{ GeV}$), non-resonant, single- and double-resonant top-quark processes with a W boson, a H^+ and two bottom-quarks in the final state are generated in the four-flavor scheme (4FS)³ at LO. The type-II 2HDM model with static QCD scales ($\mu_R = \mu_F = 125 \text{ GeV}$) is used.

³ In the matrix-element calculation, only gluons and first- and second-generation quarks are considered when defining the proton parton distribution functions.

Table 1: List of SM background processes, generators utilized for matrix-element (ME) calculations, parton shower and hadronization, the PDF sets used, the cross-section to which the total expected event yield is normalized, and the order to which the background processes were calculated. All background cross-sections are normalized to NNLO predictions, except for diboson events, where the NLO prediction is used.

Background process	Generator & parton shower	PDF	Cross-section [pb]	ME Order
$t\bar{t}$	POWHEG-BOX v2 [58] & PYTHIA 8 [59]	NNPDF3.0 _{NLO} [60]	832	NLO
Single top quark t -channel	POWHEG-BOX v2 & PYTHIA 8	NNPDF3.0 _{NLO}	217	NLO
Single top quark s -channel			10.3	NLO
Single top quark Wt -channel			72	NLO
$W(\ell\nu) + \text{jets}$	SHERPA 2.2.1 [61]	NNPDF3.0 _{NNLO}	2.0×10^4	NNLO
$Z/\gamma^*(\ell\ell, \nu\nu) + \text{jets}$	SHERPA 2.2.1	NNPDF3.0 _{NNLO}	2.1×10^3	NNLO
WW	POWHEG-BOX v2 & PYTHIA 8	CT10 _{NLO} [62]	55	NLO
WZ			26	NLO
ZZ			8.4	NLO

- In the high mass region ($m_{H^+} \geq 200$ GeV), H^+ production in association with a single top-quark is generated in the 4FS at NLO. The type-II 2HDM model is used and the dynamic QCD scales are chosen ($\mu_R = \mu_F = H_T/3 = 1/3 \sum_i \sqrt{m_i^2 + p_{Ti}^2}$).

For all signal samples, the parton-level generator is interfaced to PYTHIA 8 [59] with the NNPDF2.3_{LO} PDF set and the A14 [64] set of tuned parameters.

4 Analysis

The general analysis strategy, objects definition, event selection as well as background and signal modeling follow those of Ref. [26].

4.1 Event reconstruction and selection

Recorded events are filtered by requiring at least one primary vertex [65] with two or more associated tracks with $p_T > 400$ MeV, that they pass a good-quality requirement, and that all relevant detector components were in good operating condition [66].

Hadronic τ -lepton [67, 68] decays are identified using a Recurrent Neural Network (RNN) designed to discriminate against quark- and gluon-initiated jets [69]. In the following, reconstructed τ candidates, corresponding to the visible part of a hadronic τ -lepton decay (hereafter called $\tau_{\text{had-vis}}$), are required to have $p_T > 20$ GeV, $|\eta| < 2.5$, excluding $1.37 < |\eta| < 1.52$, an electric charge of +1 or -1, and one or three associated tracks, also referred to as 1- or 3-prong, respectively. A separate BDT is used to reject electrons that are misidentified as 1-prong $\tau_{\text{had-vis}}$ candidates. Electrons and muons are reconstructed and identified

as reported in Refs. [70] and [71], respectively. Jets are reconstructed using the particle flow approach [72] and clustered with the anti- k_r algorithm [73, 74] with a radius parameter $R = 0.4$. Additionally, jets originating from the hadronization of bottom quarks are identified (b -tagged) using advanced algorithms combined into the DL1r tagger as described in Ref. [75]. A working point corresponding to an average efficiency of 70% for b -jets in simulated $t\bar{t}$ events is chosen. When several objects defined above overlap geometrically, an overlap removal procedure is applied as described in Ref. [26]. The missing transverse momentum in the event, with magnitude E_T^{miss} , is determined from the reconstructed objects according to Ref. [76]. Simulated events are corrected for differences between data and MC simulation seen in b -tagging efficiencies and mis-tag rates as well as minor differences in electron (e), muon (μ) and $\tau_{\text{had-vis}}$ reconstruction, identification, and isolation efficiencies.

The analysis of the $\tau_{\text{had}}+\text{jets}$ channel is based on events accepted by E_T^{miss} triggers [77] with a threshold at 70, 80, 90 or 110 GeV, depending on the data-taking period.⁴ Because the E_T^{miss} trigger is not accurately modeled in simulation, the efficiency of the trigger decision as a function of reconstructed E_T^{miss} is fitted using a Gaussian error function (*erf*) in both data and simulation, following a method similar to that in Ref. [78]. The ratio of the *erf* fit in data to that in simulation is then used to reweight the simulated events.

The $\tau_{\text{had}}+\text{jets}$ channel signal region (SR) further requires at least one *medium* $\tau_{\text{had-vis}}$ candidate, corresponding to 75% (60%) efficiency for 1-prong (3-prong) $\tau_{\text{had-vis}}$ candidates [68], with $p_T > 40$ GeV and $|\eta| < 2.3$, no *loose* leptons (electron [70] or muon [71]) with $p_T > 20$ GeV, at least three jets with $p_T > 25$ GeV, of which at least one is b -tagged, $E_T^{\text{miss}} > 150$ GeV and $m_T > 50$ GeV.⁵ A signal-depleted control region (CR) is defined for the $\tau_{\text{had}}+\text{jets}$ channel ($\tau_{\text{had}}+\text{jets } t\bar{t}$ CR), to probe the modeling of the $t\bar{t}$ background. The $t\bar{t}$ -enriched $\tau_{\text{had}}+\text{jets } t\bar{t}$ CR has the same event selection as described above, except $m_T > 50$ GeV is replaced with $m_T < 100$ GeV and at least two b -jets are required. The purity of this region in top-quark backgrounds, i.e. $t\bar{t}$ and single-top-quark events is around 90%. To ensure full orthogonality, events satisfying the $\tau_{\text{had}}+\text{jets } t\bar{t}$ CR selection criteria are excluded from the $\tau_{\text{had}}+\text{jets}$ SR.

The $\tau_{\text{had}}+\text{lepton}$ channel, made of the $\tau_{\text{had}}+\text{electron}$ and $\tau_{\text{had}}+\text{muon}$ sub-channels, is based on events accepted by single-lepton triggers. Triggers for electrons or muons [79–81] with low E_T or p_T thresholds respectively (20–26 GeV depending on the data-taking period) and isolation requirements are combined in a logical OR with triggers having higher p_T thresholds (60–120 GeV for electrons, 50 GeV for muons) and looser isolation or identification requirements to maximize the efficiency.

The $\tau_{\text{had}}+\text{lepton}$ channel SR events are selected requiring exactly one *tight* lepton (electron [70] or muon [71]) with $p_T > 30$ GeV and $|\eta| < 2.5$ ($|\eta| < 2.47$, excluding $1.37 < |\eta| < 1.52$) for muons (electrons) matched to the single-lepton trigger object, exactly one *medium* $\tau_{\text{had-vis}}$ candidate with $p_T > 30$ GeV, $|\eta| < 2.3$ and an electric charge opposite to that of the lepton, at least one b -tagged jet with $p_T > 25$ GeV and $E_T^{\text{miss}} > 50$ GeV. Additionally, a $t\bar{t}$ -enriched CR is defined for the $\tau_{\text{had}}+\text{lepton}$ channel ($\tau_{\text{had}}+\text{lepton } t\bar{t}$ CR), to derive $t\bar{t}$ modeling corrections in this channel. This CR has the same event selection as described above, with the addition of $E_T^{\text{miss}} > 80$ GeV, $m_T < 70$ GeV and at least two b -tagged jets. This CR selection is a subset of $\tau_{\text{had}}+\text{lepton}$ selection described above. To maintain orthogonality of the regions, events satisfying the $\tau_{\text{had}}+\text{lepton } t\bar{t}$ selection are rejected from the $\tau_{\text{had}}+\text{lepton}$ SR.

⁴ Due to differing pile-up conditions which impact the trigger rates.

⁵ m_T , the transverse mass of the highest- p_T $\tau_{\text{had-vis}}$ candidate and E_T^{miss} is defined as $m_T(\tau_{\text{had-vis}}, E_T^{\text{miss}}) = \sqrt{2p_T^\tau E_T^{\text{miss}}(1 - \cos \Delta\phi_{\tau, \text{miss}})}$, where $\Delta\phi_{\tau, \text{miss}}$ is the azimuthal angle between the $\tau_{\text{had-vis}}$ candidate and the direction of the missing transverse momentum.

Table 2: Summary of requirements for the regions used in the analysis. When applicable, units are in GeV, τ refers to $\tau_{\text{had-vis}}$ in the cut definitions, and j refers to jets in the region names. FF MJ and FF $W+j$ denote multi-jet and W +jets CRs, respectively, defined to determine $\tau_{\text{had-vis}}$ fake factors as described in Section 4.2.

Cut	SR $\tau+j$	$t\bar{t}(\tau j)$	$W+j$	FF MJ	FF $W+j$	SR $\tau + \ell$	$t\bar{t}(\tau\ell)$	b -veto	$e + \mu$
$p_T(\tau)$	> 40	> 40	> 40	> 30	> 30	> 30	> 30	> 30	–
N_ℓ	0	0	0	0	1	1	1	1	2
$p_T(\ell)$	–	–	–	–	> 30	> 30	> 30	> 30	> 30
$q(\tau) \times q(\ell)$	–	–	–	–	–	-1	-1	-1	–
N_{jet}	≥ 3	≥ 3	≥ 3	≥ 3	–	≥ 1	≥ 2	≥ 1	≥ 1
$p_T(\text{lead-jet})$	> 25	–	> 25	> 25	–	> 25	> 25	> 25	> 25
$N_{b\text{-jet}}$	≥ 1	≥ 2	0	0	0	≥ 1	≥ 2	0	≥ 1
E_T^{miss}	> 150	> 150	> 150	< 80	–	> 50	> 80	> 50	> 50
$m_T(\tau, E_T^{\text{miss}})$	> 50	< 100	< 100	> 50	–	–	< 70	–	–
Other	*				**	*			***

* Note that the SRs reject events in the overlap with the corresponding $t\bar{t}$ regions.

** There is an additional requirement that $60 \text{ GeV} < m_T(e, E_T^{\text{miss}}) < 160 \text{ GeV}$.

*** The two ℓ must be an oppositely charged $e + \mu$ pair.

Two further signal-depleted CRs are defined for the $\tau_{\text{had}}+\text{lepton}$ channel. The $\tau_{\text{had}} + e/\mu$ b -veto CR relies on the same event selection as the SR, vetoing any b -tagged jets. This region is enriched in W +jets events with true e/μ and a jet misidentified as $\tau_{\text{had-vis}}$ and Z +jets events with Z boson decaying to a pair of τ leptons. The $t\bar{t}$ enriched CR ($e + \mu$ b -tag CR) uses SR event selection, except that a *tight* (and oppositely charged) $e + \mu$ pair is required instead of a $\tau_{\text{had-vis}} + \text{lepton}$ pair. This CR has a very high purity (> 99.8%) of top-quark background events.

Control regions are used to validate the agreement between data and background simulation or derive necessary corrections, but are not included in the final likelihood fit. A summary of the selection applied to the regions used in this analysis is shown in Table 2.

4.2 Background modeling

Background modeling relies on simulated MC events for SM backgrounds containing the $\tau_{\text{had-vis}}$ object matched to a true hadronic τ -lepton decay at the generator level or containing electrons or muons reconstructed and identified as $\tau_{\text{had-vis}}$ objects ($\ell \rightarrow \tau_{\text{had}}^{\text{fake}}$).

Events that contain quark- or gluon-initiated jets and no true τ_{had} can enter the SR when one of these jets is reconstructed and misidentified as a $\tau_{\text{had-vis}}$ candidate (fake $\tau_{\text{had-vis}}$). A data-driven fake-factor (FF) method is used to estimate this background. The ratios of the number of events with fake $\tau_{\text{had-vis}}$ objects satisfying the $\tau_{\text{had-vis}}$ identification criteria ($N_{\text{CR fake}}^{\tau\text{-ID}}$) to the number of events with fake anti- $\tau_{\text{had-vis}}$ objects satisfying the very loose requirement on the $\tau_{\text{had-vis}}$ identification but failing to meet the loose identification requirement ($N_{\text{CR fake}}^{\text{anti-}\tau\text{-ID}}$) [68] are measured in the dedicated CRs. The fake factors ($\text{FF} = N_{\text{CR fake}}^{\tau\text{-ID}} / N_{\text{CR fake}}^{\text{anti-}\tau\text{-ID}}$) are determined in bins of $\tau_{\text{had-vis}}$ p_T , separately for 1-prong and 3-prong candidates. To estimate the number of background events with fake $\tau_{\text{had-vis}}$ in the SR, the measured FFs are applied to the number of events with fake anti- $\tau_{\text{had-vis}}$ objects obtained by requiring the SR selection, but replacing the $\tau_{\text{had-vis}}$ with the

anti- $\tau_{\text{had-vis}}$ selection criteria ($N_{\text{SR fake}}^\tau = N_{\text{SR fake}}^{\text{anti-}\tau\text{-ID}} \times \text{FF}$). The number of events with a fake $\tau_{\text{had-vis}}$ candidate in each region is obtained by subtracting the number of simulated events containing a true τ_{had} or $\ell \rightarrow \tau_{\text{had}}^{\text{fakes}}$ from the number of data events ($N_{\text{fake}}^\tau = N_{\text{data}}^\tau - N_{\text{MC true}}^\tau - N_{\text{MC}}^{\ell \rightarrow \tau}$).

Two CRs with different fractions of quark- and gluon-initiated jets are used to determine the FFs. The FF multi-jet CR relies on multi-jet event triggers [82] and is defined by selecting events satisfying an offline selection similar to that of the $\tau_{\text{had+jets}}$ SR, but requiring $p_{\text{T}}(\tau) > 30$ GeV, $E_{\text{T}}^{\text{miss}} < 80$ GeV and vetoing any b -tagged jets. The FF W +jets CR is defined by selecting events passing an offline selection similar to that of the $\tau_{\text{had+lepton}}$ SR, but requiring $60 \text{ GeV} < m_{\text{T}}(\ell, E_{\text{T}}^{\text{miss}}) < 160$ GeV and vetoing b -tagged jets. In the FF multi-jet CR, the contamination arising from correctly reconstructed and identified $\tau_{\text{had-vis}}$ objects is small (8%), while in the FF W +jets CR, this contamination is about 20%. In the corresponding anti- τ -ID regions, the fraction of events with a true τ_{had} is negligible in the FF multi-jet CR and is around 6% in the FF W +jets CR. The contribution from true τ_{had} events in the above mentioned categories is estimated using simulation and is subtracted from the number of observed events in each region. The FF multi-jet CR contains similar fractions of quark- and gluon-initiated jets, while the FF W +jets CR is dominated by quark-initiated jets. The SR is expected to have contributions from both types, but with different fractions. In order to estimate the fraction of gluon-initiated jets in the signal region, a template-fit method in the anti- τ -ID region is used, based on a discriminating variable that is sensitive to the source of the jet. This fraction is used to estimate combined fake factors, which are linear combinations of the fake factors measured in the multi-jet and W +jets CRs. The variable chosen for the templates is the $\tau_{\text{had-vis}}$ width defined as $w_\tau = \frac{\sum [p_{\text{T}}^{\text{track}} \times \Delta R(\tau_{\text{had-vis}}, \text{track})]}{\sum p_{\text{T}}^{\text{track}}}$ for tracks satisfying $\Delta R(\tau_{\text{had-vis}}, \text{track}) < 0.4$.

Due to inaccurate data modeling at high jet multiplicities arising in the $t\bar{t}$ and W +jets simulations, data-based corrections are applied to the MC prediction, following the example of Refs. [28, 34]. Reweighting factors, $R(x)$, are derived by comparing the MC prediction to the data in dedicated CRs, separately for $t\bar{t}$ and W +jets MC samples. For the $\tau_{\text{had+lepton}}$ channel, $R(x)$ is determined in the $\tau_{\text{had+lepton}}$ $t\bar{t}$ CR as a function of $m_{\text{eff}} = \sum_{\text{jets}} p_{\text{T}}^{\text{jets}} + p_{\text{T}}^\tau + p_{\text{T}}^{\text{lepton}} + E_{\text{T}}^{\text{miss}}$ and for the $\tau_{\text{had+jets}}$ channel in the $\tau_{\text{had+jets}}$ $t\bar{t}$ CR as a function of $m_{\text{eff}} = \sum_{\text{jets}} p_{\text{T}}^{\text{jets}} + p_{\text{T}}^\tau + E_{\text{T}}^{\text{miss}}$. Reweighting factors for the W +jets sample are derived as a function of jet multiplicity in the W +jets CR of the $\tau_{\text{had+jets}}$ channel and are applied to the simulated W +jets events in both $\tau_{\text{had+jets}}$ and $\tau_{\text{had+lepton}}$ channels. The overall event normalization factor from applying the reweighting factors ranges from 0.86 to 0.95.

4.3 Multivariate discriminant

Following the event selections described in Section 4.1, kinematic variables that differentiate between the signal and backgrounds are combined into a multivariate signal-to-background discriminant using PNNs. The PNN response is parameterized with the generator-level H^+ mass, $m_{\text{truth}}^{H^+}$, and defines classifiers for all probed H^+ mass hypotheses, with continuous sensitivity to masses between them. The PNN output score for a given H^+ mass hypothesis discriminates between that signal and the SM backgrounds, and is used as the final discriminating variable for the statistical analysis. The training of the PNNs is performed using the KERAS [83] library with the TENSORFLOW [84] library as a backend. Two separate PNNs are defined and trained for the $\tau_{\text{had+jets}}$ and $\tau_{\text{had+lepton}}$ channels using all signal samples at the same time, taking the value of the H^+ mass as a parameter.⁶ The k-fold training method [85] is used with $k = 5$ in order to increase the effective statistics of the training sample and to prevent overtraining.

⁶ In the training process, samples for all H^+ mass hypotheses are normalized to the weighted number of background events. Background events enter the training multiple times, such that each event is assigned to every H^+ mass hypothesis once.

Table 3: List of kinematic variables used as input to the PNN in the $\tau_{\text{had}}+\text{jets}$ and $\tau_{\text{had}}+\text{lepton}$ channels. Here, ℓ refers to the selected lepton (electron or muon), while jet-1, jet-2 and jet-3 refer to the leading, second-leading and third-leading jet ordered in p_{T} . The list of jets includes b -jets. The Y variable is sensitive to the polarization of the τ -lepton and is only defined for 1-prong $\tau_{\text{had-vis}}$ candidates. Hence, the PNN training is performed separately for events with a selected 1- or 3-prong $\tau_{\text{had-vis}}$ candidate.

PNN input variable	$\tau_{\text{had}}+\text{jets}$	$\tau_{\text{had}}+\text{lepton}$
$p_{\text{T}}^{\tau}, \eta^{\tau}, \phi^{\tau}, E^{\tau}$	✓	✓
$p_{\text{T}}^{\ell}, \eta^{\ell}, \phi^{\ell}, E^{\ell}$		✓
$p_{\text{T}}^{b\text{-jet}}, \eta^{b\text{-jet}}, \phi^{b\text{-jet}}, E^{b\text{-jet}}$	✓	✓
$p_{\text{T}}^{\text{jet-1}}, \eta^{\text{jet-1}}, \phi^{\text{jet-1}}, E^{\text{jet-1}}$	✓	✓
$p_{\text{T}}^{\text{jet-2}}, \eta^{\text{jet-2}}, \phi^{\text{jet-2}}$	✓	
$p_{\text{T}}^{\text{jet-3}}, \eta^{\text{jet-3}}, \phi^{\text{jet-3}}$	✓	
$p_{\text{T}}^{\text{jet-2}}$		✓
$E_{\text{T}}^{\text{miss}}, \phi_{\text{T}}^{E^{\text{miss}}}$	✓	✓
Y (1-prong $\tau_{\text{had-vis}}$ only)	✓	✓
$m_{\text{truth}}^{H^+}$	✓	✓

The input variables used to train the PNNs for the $\tau_{\text{had}}+\text{jets}$ and $\tau_{\text{had}}+\text{lepton}$ channels are mostly the four-momentum components of the reconstructed final state objects and are listed in Table 3. For events with more than one $\tau_{\text{had-vis}}$ candidate or more than one b -tagged jet, the highest- p_{T} object is passed as input to the PNN. When comparing the PNN response for data and for the background model in regions that do not contain a $\tau_{\text{had-vis}}$ or b -jets, a default value of zero is used for the corresponding input variables. The $Y = 2(p_{\text{T}}^{\tau\text{-track}}/p_{\text{T}}^{\tau_{\text{had-vis}}}) - 1$ variable [86], where $p_{\text{T}}^{\tau\text{-track}}$ refers to the track associated with the $\tau_{\text{had-vis}}$, is sensitive to τ -lepton polarization and helps discriminate between the SM background processes, where the $\tau_{\text{had-vis}}$ object stems from a vector-boson decay and signal, where τ_{had} is a decay product of a scalar particle. This variable is defined only for 1-prong tau decays, hence included uniquely in the PNN variable for events with a selected 1-prong $\tau_{\text{had-vis}}$ object. Due to correlations with some input variables entering the RNN $\tau_{\text{had-vis}}$ identification, the Y distribution significantly differs between $\tau_{\text{had-vis}}$ and anti- $\tau_{\text{had-vis}}$ candidates. In order to ensure proper modeling of this distribution, an inverse transform sampling (Smirnov transform) is performed on the Y variable of anti- $\tau_{\text{had-vis}}$ candidates entering the fake-factor background estimation [26].

The modeling of the PNN input variables as well as the output score is validated in the CRs. The PNN score in the $t\bar{t}$ enriched $\tau_{\text{had}}+\text{jets}$ $t\bar{t}$ CR, and the $W/Z+\text{jets}$ enriched b -veto CR of the $\tau_{\text{had}} + \mu$ channel are shown in Figure 2 for an example H^+ mass of 170 GeV. The PNN score distributions for two example signal masses (170 GeV and 1000 GeV) are shown in Figure 3 for the $\tau_{\text{had}}+\text{jets}$ SR and in Figure 4 for the $\tau_{\text{had}}+\text{lepton}$ SRs.

4.4 Systematic uncertainties

Detector-related systematic uncertainties arise from the simulation of the electron and muon triggers, from electron and muon isolation criteria, from the reconstruction and identification of leptons, $\tau_{\text{had-vis}}$ objects and b -jets, from the energy/momentum scale and resolution of all detector objects, as well as from the reconstruction of the event $E_{\text{T}}^{\text{miss}}$. To assess the impact of most detector-related systematic

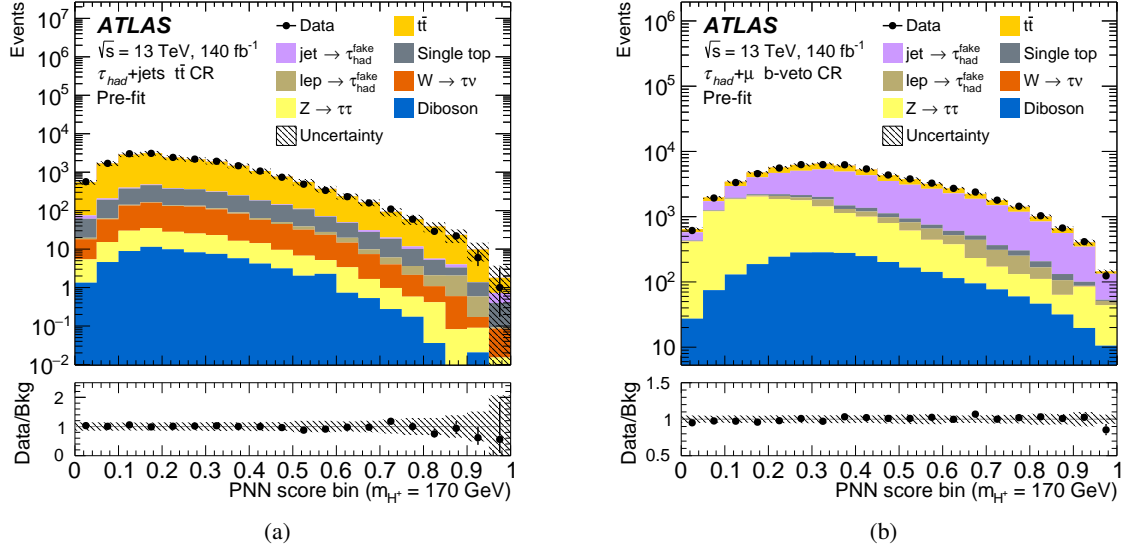

Figure 2: Predicted and measured PNN score distributions before the fit to data (“Pre-fit”) in (a) the $t\bar{t}$ enriched CR of the $\tau_{\text{had}}+\text{jets}$ channel and (b) the b -veto CR of the $\tau_{\text{had}}+\mu$ channel enriched in the $W/Z+\text{jets}$ events with jets faking $\tau_{\text{had-vis}}$, for the 170 GeV m_{H^+} hypothesis. The lower panel of each plot shows the ratio of data to the SM background prediction. The uncertainty bands include all statistical and systematic uncertainties. The bin boundaries of these distributions are spaced equally at intervals of 0.05 and do not represent the binning scheme used in the final fits.

uncertainties on the four-momenta of the analysis objects, the selection criteria are re-applied after varying a particular parameter by its ± 1 standard deviation value. These are complemented by variations of the scale factors related to efficiencies of physics objects reconstruction and identification. All detector-related systematic uncertainties are also propagated to the analysis objects used in the E_T^{miss} calculation, and an additional uncertainty on its soft term is considered [76]. The effect of each systematic uncertainty, with the exception of those that demonstrate less than 0.5% deviation from the nominal value in all bins of the final discriminating variable as defined in Section 5, is parameterized and included in the definition of the likelihood function used to statistically infer the final results.

In the $\tau_{\text{had}}+\text{jets}$ channel, additional uncertainties are attributed to the evaluation of the trigger efficiency scale factors. These include a) the effect of varying the selection criteria used for measuring the trigger efficiency, such as changing the number of required jets and b -jets and applying different working points for the $\tau_{\text{had-vis}}$ and electron identification algorithms; b) the impact of the fake $\tau_{\text{had-vis}}$ background modeling, which is assessed by measuring the trigger scale factors after subtracting the data-driven fake $\tau_{\text{had-vis}}$ estimate from the observed data and keeping only events with true $\tau_{\text{had-vis}}$ in simulation; and c) statistical uncertainties in the values of the erf function parameters derived from the fit. The covariance matrix of the fitted parameters of the erf function is diagonalized and then propagated to the final fit as uncorrelated uncertainties.

Uncertainties in the estimation of background from quark- and gluon-initiated jets misidentified $\tau_{\text{had-vis}}$ objects arise from extraction of the FFs in the designated CRs as well as the determination of the combined FFs and application of those in the SRs. Uncertainties in the FFs include statistical uncertainty in the FF value estimated in each p_T bin of the CRs, a 5% uncertainty in the number of true τ_{had} objects in MC simulation which satisfy the $\tau_{\text{had-vis}}$ selection ($N_{\text{MCtrue}}^{\tau-\text{ID}}$) and a conservative 50% uncertainty in the

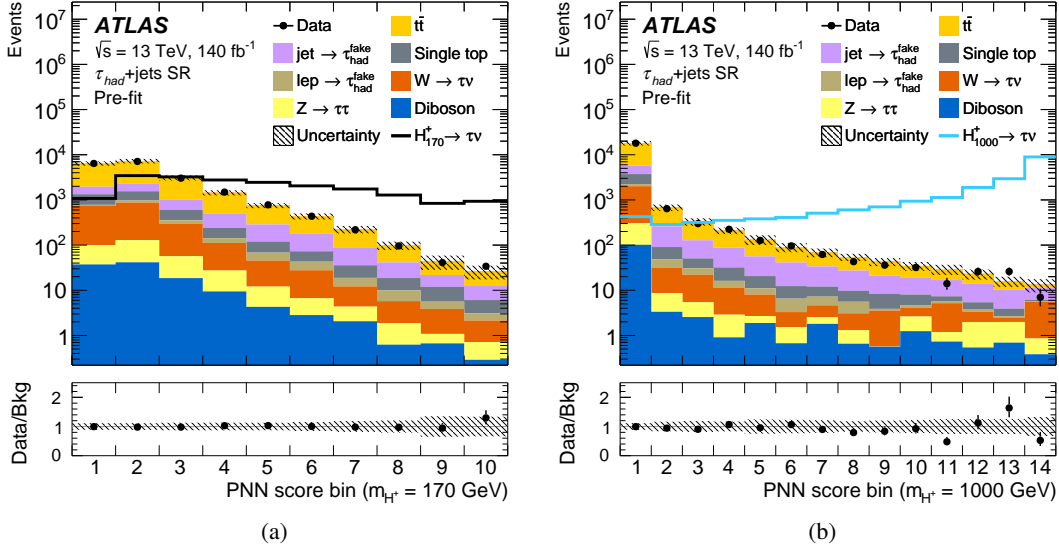

Figure 3: PNN score distributions before the fit to data (“Pre-fit”) in the SR of the $\tau_{\text{had}}+\text{jets}$ for the (a) 170 GeV and (b) 1000 GeV m_{H^+} hypotheses. The lower panel of each plot shows the ratio of data to the SM background prediction. The uncertainty bands include all statistical and systematic uncertainties. Bin boundaries are optimized for the best sensitivity of the final fit (see Section 5) but are displayed as equidistant for better readability. Also shown are the expected signal distributions normalized to the total background yield.

number of these objects passing the anti- $\tau_{\text{had-vis}}$ selection ($N_{\text{MCtrue}}^{\text{anti-}\tau\text{-ID}}$). The earlier corresponds to the uncertainty in the $\tau_{\text{had-vis}}$ identification efficiency. There are no rigorous estimates of the latter, but the fractional contributions are small, as detailed in Section 4.2. The Y variable transform derived from the FF $W+\text{jets}$ CR is used as nominal while the one derived from the FF multi-jet CR is taken as a systematic uncertainty. The uncertainties in determining the combined FFs include the statistical uncertainty in the template fit to the $\tau_{\text{had-vis}}$ jet width as well as an uncertainty due to the p_T binning used for the template fit, which is estimated by varying the binning criteria. Furthermore, the CRs used to measure FFs are mostly dominated by light-quark (u, d, s) and gluon initiated jets reconstructed as $\tau_{\text{had-vis}}$, while in the SR with inverted $\tau_{\text{had-vis}}$ identification criteria, around 30-40% of the reconstructed $\tau_{\text{had-vis}}$ candidates originate from heavy-flavor (HF) initiated jets. The larger width of HF jets compared to light jets leads to a bias in the template fit and consequently in the composition of the jets misidentified as $\tau_{\text{had-vis}}$ objects in the SRs. The bias is estimated in $t\bar{t}$ simulation by comparing the true yield of fake $\tau_{\text{had-vis}}$ to the one estimated using FFs and jet width templates from light jets alone obtained from simulation. The difference is used as an uncertainty on the fake $\tau_{\text{had-vis}}$ yield from the $t\bar{t}$ background. The largest single uncertainty on the fake $\tau_{\text{had-vis}}$ estimation comes from the HF jet contribution in the SR.

Systematic uncertainties associated with reweighting of $t\bar{t}$ and $W+\text{jets}$ MC samples include statistical uncertainties in the fitted values of the reweighting function parameters and the potential impact of signal contamination in CRs where reweighting factors are calculated. To estimate the number of signal events, the $m_{H^+} = 90$ GeV cross-section limit from Ref. [26] extrapolated⁷ to $m_{H^+} = 80$ GeV is used. The fractional contribution of the hypothetical signal amounts to 3.6% (3.8%) in the $\tau_{\text{had}}+\text{jets}$ ($\tau_{\text{had}}+\text{lepton}$) $t\bar{t}$ CRs and 0.5% in the $W+\text{jets}$ CR. An additional uncertainty associated with the extrapolation of the $t\bar{t}$ reweighting into the $\tau_{\text{had}}+\text{jets}$ ($\tau_{\text{had}}+\text{lepton}$) SR is estimated by using the reweighting functions obtained for the $\tau_{\text{had}}+\text{lepton}$

⁷ Scaling by the ratio of the expected limits at 80 and 90 GeV.

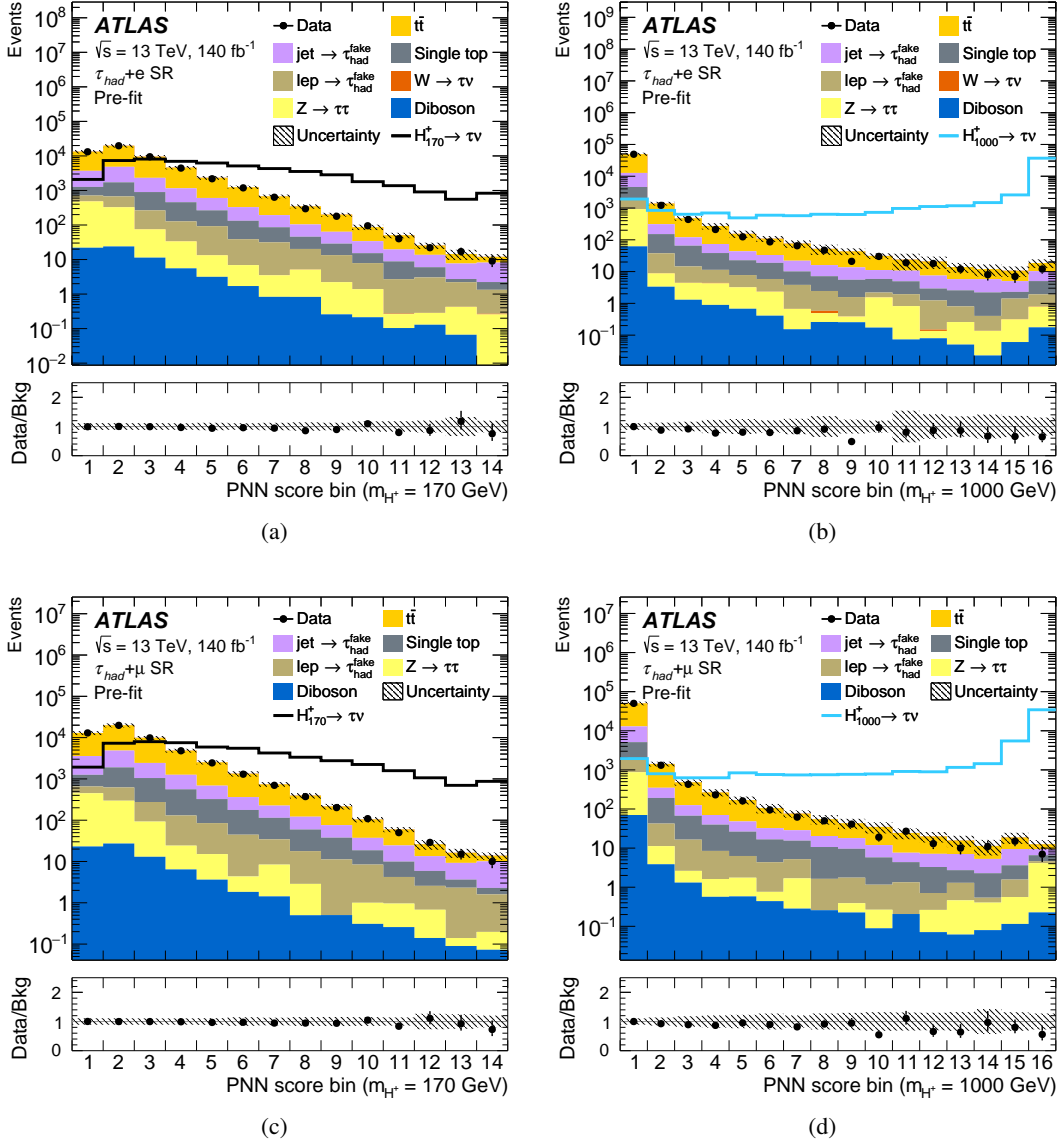

Figure 4: PNN score distributions before the fit to data (“Pre-fit”) in the SR of the $\tau_{\text{had}}+\text{electron}$ sub-channel for the (a) 170 GeV and (b) 1000 GeV m_{H^+} hypotheses and $\tau_{\text{had}}+\text{muon}$ sub-channel for the (c) 170 GeV and (d) 1000 GeV m_{H^+} hypotheses. The lower panel of each plot shows the ratio of data to the SM background prediction. The uncertainty bands include all statistical and systematic uncertainties. Bin boundaries are optimized for the best sensitivity of the final fit (see Section 5) but are displayed as equidistant for better readability. Also shown are the expected signal distributions normalized to the total background yield.

($\tau_{\text{had}}+\text{jets}$) channel. In the case of the $W+\text{jets}$ background, a conservative 50% normalization uncertainty is considered.

Theoretical uncertainties on the main MC simulated backgrounds ($t\bar{t}$, single top quarks, $W+\text{jets}$) include contributions from renormalization and factorization scale variations, initial state radiation (ISR) and final state radiation (FSR), parton distribution functions, as well as parton shower and hadronization model. The latter is estimated using the difference between PYTHIA 8 (default) and HERWIG 7 [87] predictions, which

Table 4: Pre-fit event yields for the backgrounds, hypothetical signal for two H^+ mass hypotheses, and the observed number of data events in each of the three SRs. The values shown for the signal assume $m_{H^+} = 170$ GeV and 1000 GeV, with a cross-section times branching fraction $\sigma(pp \rightarrow tbH^+) \times \mathcal{B}(H^+ \rightarrow \tau\nu)$ corresponding to 1 pb. Combined statistical and systematic uncertainties are quoted.

Sample	Event yields and uncertainties		
	$\tau_{\text{had}}+\text{jets}$	$\tau_{\text{had}} + e$	$\tau_{\text{had}} + \mu$
True τ_{had}			
$t\bar{t}$	13400 \pm 2000	39000 \pm 6000	39000 \pm 5000
Single top quark	1600 \pm 400	2900 \pm 400	3630 \pm 330
$Z \rightarrow \tau\tau$	220 \pm 110	900 \pm 500	800 \pm 400
$W \rightarrow \tau\nu$	1770 \pm 270	2.4 \pm 2.0	0.07 \pm 0.21
Diboson (WW, WZ, ZZ)	120 \pm 60	70 \pm 35	80 \pm 40
Misidentified jet $\rightarrow \tau_{\text{had-vis}}$	2430 \pm 200	8500 \pm 700	8200 \pm 700
Misidentified $e, \mu \rightarrow \tau_{\text{had-vis}}$	280 \pm 170	1000 \pm 500	1000 \pm 500
All backgrounds	19800 \pm 2100	52000 \pm 6000	53000 \pm 6000
H^+ (170 GeV), $\sigma \times \mathcal{B} = 1$ pb	980 \pm 150	580 \pm 70	690 \pm 80
H^+ (1000 GeV), $\sigma \times \mathcal{B} = 1$ pb	13000 \pm 800	940 \pm 60	1040 \pm 70
Data	19650 \pm 140	51500 \pm 230	52730 \pm 230

is then symmetrized. The prescriptions used for ISR/FSR and scale variations are generator dependent, but typically involve varying the resummation damping factor up or down by a factor of two. For each variation, a dedicated reweighting of the $t\bar{t}$ and W +jets MC samples is derived to avoid double counting of uncertainties.

Theoretical uncertainties on signal modeling include renormalization and factorization scale variations, PDF variations, as well as potential small acceptance loss due to the generator-level event selection used. The PDF and scale variations are additionally rescaled to maintain the nominal cross-section.

The uncertainty in the integrated luminosity is 0.83% [88], obtained using the LUCID-2 detector [49] for the primary luminosity measurements, complemented by measurements using the inner detector and calorimeters. This uncertainty affects the normalization of all simulated samples.

5 Results

The expected pre-fit number of events for all SM processes and the measured event yields in all three SRs are shown in Table 4. The contributions from hypothetical H^+ bosons are also listed, assuming a m_{H^+} hypothesis of 170 GeV or 1000 GeV, and with $\sigma(pp \rightarrow tbH^+) \times \mathcal{B}(H^+ \rightarrow \tau\nu)$ set to 1 pb. The signal selection acceptance times efficiency for a m_{H^+} hypothesis of 170 GeV, as evaluated in an inclusive sample of simulated events where all possible τ -lepton and top-quark decays are considered, is 0.78%, 0.43% and 0.51% in the $\tau_{\text{had}}+\text{jets}$, $\tau_{\text{had}}+\text{electron}$ and $\tau_{\text{had}}+\text{muon}$ SR, respectively. These become 9.35%, 0.68% and 0.74% for $m_{H^+} = 1000$ GeV. The large increase in the $\tau_{\text{had}}+\text{jets}$ SR comes from the $E_{\text{T}}^{\text{miss}}$ requirement, which becomes almost fully efficient for large m_{H^+} . The event yields measured in data are consistent with the SM background expectations in the three SRs.

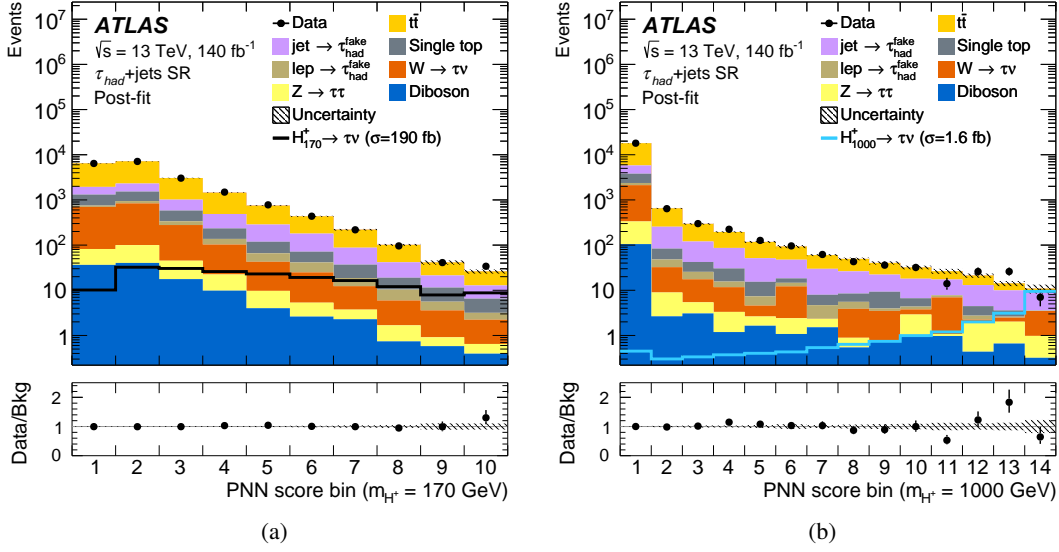

Figure 5: PNN score distributions after the fit to data (“Post-fit”) under the background-only hypothesis in the SR of the $\tau_{\text{had}}+\text{jets}$ channel for the (a) 170 GeV and (b) 1000 GeV m_{H^+} hypotheses. The signal distribution of the 170 GeV (1000 GeV) H^+ mass hypothesis is shown by the solid black (teal) line, where the signal distribution is scaled to its expected 95% CL limit. The lower panel of each plot shows the ratio of data to the SM background prediction. The uncertainty bands include all statistical and systematic uncertainties. Bin boundaries are optimized for the best sensitivity of the final fit (see Section 5) but are displayed as equidistant for better readability.

The statistical interpretation is based on a simultaneous fit of the parameter of interest, i.e. $\mu \equiv \sigma(pp \rightarrow tbH^+) \times \mathcal{B}(H^+ \rightarrow \tau\nu)$, and the nuisance parameters θ that encode statistical and systematic uncertainties, by means of a negative log-likelihood minimization. The combined binned likelihood function $\mathcal{L}(\mu, \theta)$ for the PNN score distributions is constructed as a product of Poisson probability terms over all bins in the three SRs ($\tau_{\text{had}}+\text{jets}$, $\tau_{\text{had}}+\text{electron}$ and $\tau_{\text{had}}+\text{muon}$). The binning of the discriminating variable is optimized to maximize the sensitivity of the analysis prior to looking at the data in the SRs.

The test statistic \tilde{q}_μ [89] used to test the compatibility of the data with the background-only and signal+background hypotheses is computed from the profile likelihood ratio. Upper limits on the signal production cross-section times branching fraction are derived using a binned likelihood fit with the CL_S method [90]: for a given signal hypothesis, values of the production cross-section times branching fraction $\sigma(pp \rightarrow tbH^+) \times \mathcal{B}(H^+ \rightarrow \tau\nu)$ yielding $\text{CL}_S < 0.05$ are excluded at 95% CL. The asymptotic approximation [89] is used throughout the statistical analysis.

Figures 5 and 6 show the PNN score distributions corresponding to two example m_{H^+} hypotheses for the SRs of the $\tau_{\text{had}}+\text{jets}$ and $\tau_{\text{had}}+\text{lepton}$ channels, respectively. All plots are obtained after the statistical fitting procedure with the background-only hypothesis.

The data are found to be consistent under the background-only hypothesis. Exclusion upper limits are set at 95% CL on $\sigma(pp \rightarrow tbH^+) \times \mathcal{B}(H^+ \rightarrow \tau\nu)$ for the full mass range investigated, as well as on $\mathcal{B}(t \rightarrow bH^+) \times \mathcal{B}(H^+ \rightarrow \tau\nu)$ in the low H^+ mass range. Figure 7 shows the expected and observed combined exclusion limits as a function of m_{H^+} . The observed limits range from 4.5 pb to 0.4 fb. At low mass, the sensitivity of the analysis is driven by the $\tau_{\text{had}}+\text{lepton}$ channel, while at high mass the $\tau_{\text{had}}+\text{jets}$ channel dominates. For the mass range between 80 and 160 GeV, the limits on $\sigma(pp \rightarrow tbH^+) \times \mathcal{B}(H^+ \rightarrow \tau\nu)$

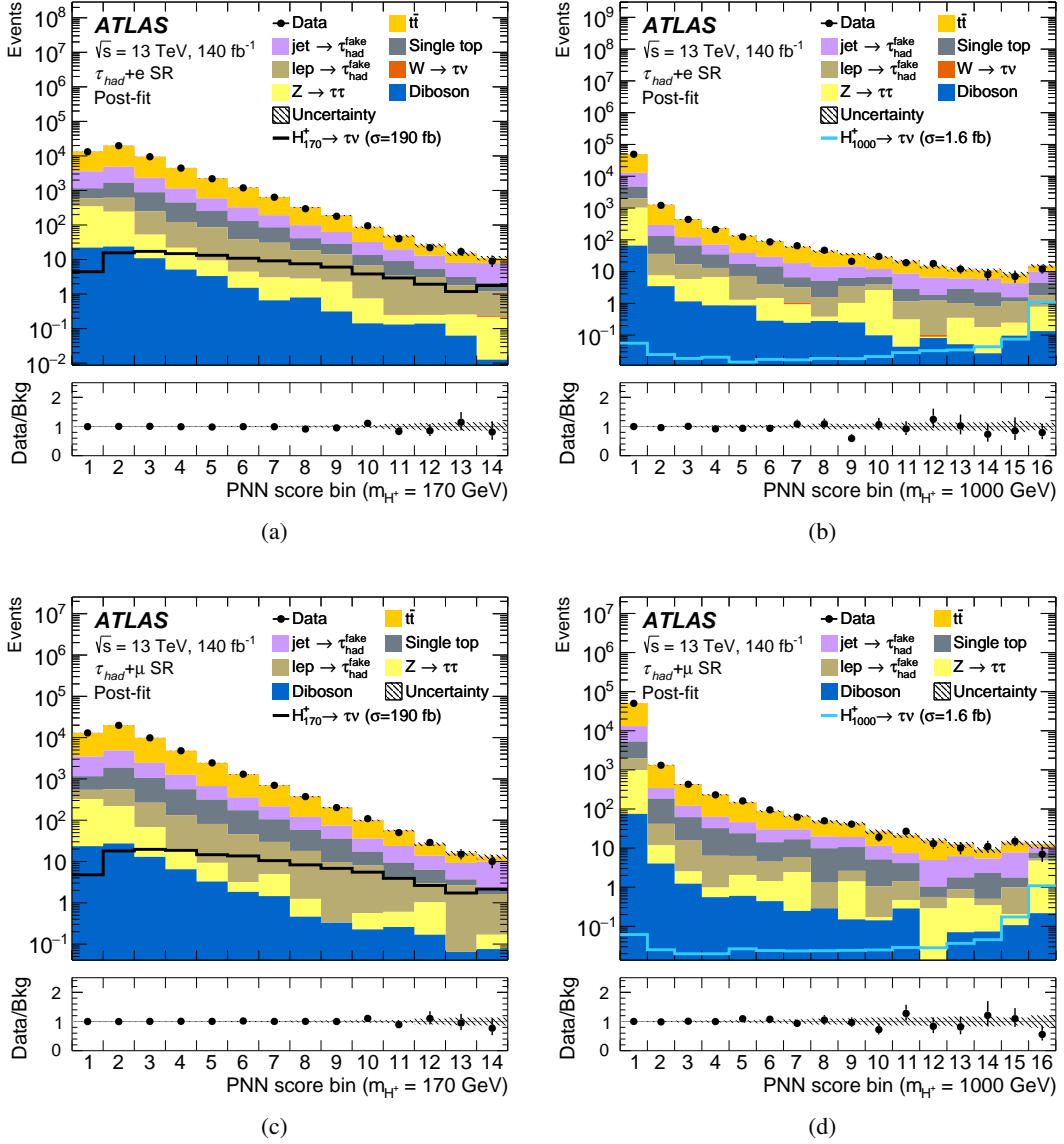

Figure 6: PNN score distributions after the fit to data (“Post-fit”) under the background-only hypothesis in the SR of the $\tau_{\text{had}}+\text{electron}$ sub-channel for the (a) 170 GeV and (b) 1000 GeV m_{H^+} hypotheses and $\tau_{\text{had}}+\text{muon}$ sub-channel for the (c) 170 GeV and (d) 1000 GeV m_{H^+} hypotheses. The signal distribution of the 170 GeV (1000 GeV) H^+ mass hypothesis is shown by the solid black (teal) line, where the signal distribution is scaled to its expected 95% CL limit. The lower panel of each plot shows the ratio of data to the SM background prediction. The uncertainty bands include all statistical and systematic uncertainties. Bin boundaries are optimized for the best sensitivity of the final fit (see Section 5) but are displayed as equidistant for better readability.

translate into observed limits between 0.27% and 0.02% on $\mathcal{B}(t \rightarrow bH^+) \times \mathcal{B}(H^+ \rightarrow \tau\nu)$ assuming the SM $t\bar{t}$ production cross-section.

The impact from the various sources of systematic uncertainty is estimated by taking the difference in quadrature of the observed 1 sigma uncertainty ($\sigma(\hat{\mu})$) on the best fit μ value ($\hat{\mu}$) obtained when performing an unconditional signal-plus-background fit to observed data while considering all systematic uncertainties,

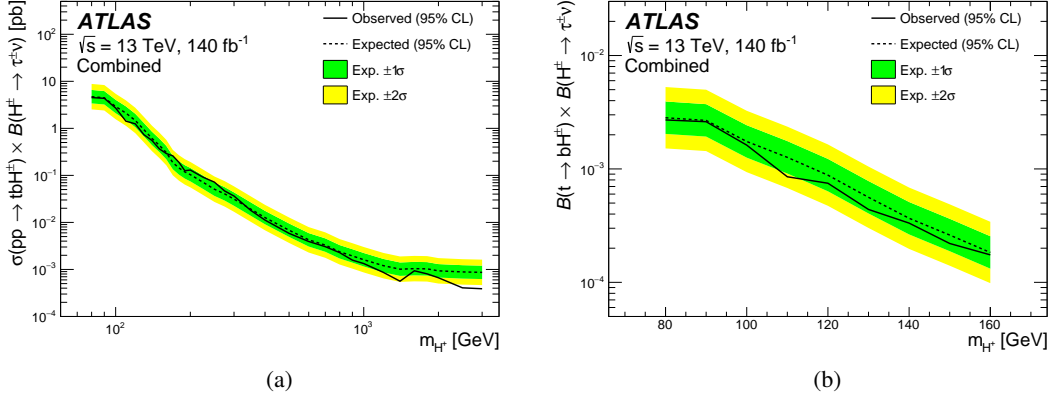

Figure 7: Observed and expected 95% CL exclusion limits on (a) $\sigma(pp \rightarrow tbH^+) \times \mathcal{B}(H^+ \rightarrow \tau\nu)$ and (b) $\mathcal{B}(t \rightarrow bH^+) \times \mathcal{B}(H^+ \rightarrow \tau\nu)$ as a function of m_{H^+} , from a combined fit in the $\tau_{\text{had-vis}} + \text{jets}$ and $\tau_{\text{had-vis}} + \text{lepton}$ channels. The surrounding shaded bands correspond to the 1σ and 2σ confidence intervals around the expected limit.

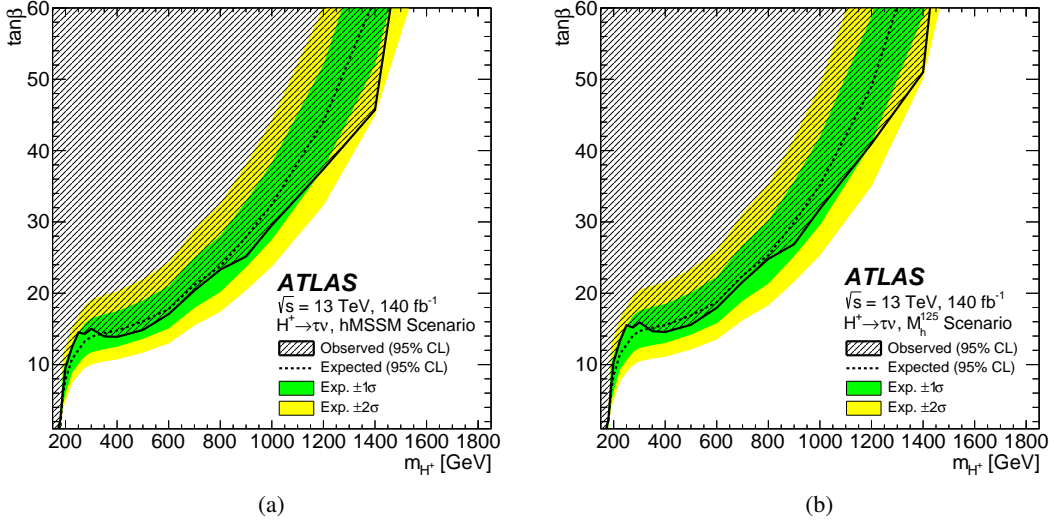

Figure 8: Observed and expected 95% CL exclusion limits on $\tan\beta$ as a function of m_{H^+} , shown in the context of (a) the hMSSM and the (b) the M_h^{125} scenario of the MSSM, for $m_{H^+} > 150$ GeV and $(1 \leq \tan\beta \leq 60)$. The surrounding shaded bands correspond to the 1σ and 2σ confidence intervals around the expected limit.

to the $\sigma(\hat{\mu})$ obtained when performing a conditional fit with a certain set of systematic uncertainties fixed to their best fit values from the unconditional fit. The results for example m_{H^+} mass hypotheses 170 GeV and 1000 GeV are summarized in Table 5.

Figure 8 shows the 95% CL exclusion limits on $\tan\beta$ as a function of m_{H^+} in the context of the hMSSM [91] and the M_h^{125} scenario of the MSSM [45]. The boundaries chosen correspond to regions in which theoretical predictions are available and in which this analysis has coverage. Exclusion limits for $m_{H^+} \leq 140$ GeV are not shown, as the hMSSM scenario is not valid in this range [40]. At $\tan\beta = 60$, above which no reliable theoretical calculations exist, H^+ bosons with masses up to 1400 GeV are excluded, significantly

Table 5: Impact from various sources of systematic uncertainty on $\sigma(\hat{\mu})$ (the observed 1σ uncertainty on $\hat{\mu}$) from the combined fit for two H^+ mass hypotheses: 170 GeV and 1000 GeV. The impact is obtained by taking the difference in quadrature of the uncertainty on $\hat{\mu}$ obtained when performing an unconditional signal+background fit to observed data ($\sigma(\hat{\mu}_{ALL})$), to the uncertainty on $\hat{\mu}$ obtained when performing a conditional fit with a certain set of systematic uncertainties fixed to their best fit values from the unconditional fit $\sigma(\hat{\mu}_{group})$. The impact is defined as, Impact = $\frac{\sqrt{|\sigma(\hat{\mu}_{ALL})|^2 - \sigma(\hat{\mu}_{group})^2} \times 100}{\sigma(\hat{\mu}_{ALL})}$. The row ‘‘Total’’ is obtained by computing the normalized difference in quadrature of the observed uncertainty from the unconditional fit, to a conditional fit where only statistical uncertainties are considered. In the absence of correlations and assuming Gaussian uncertainties, the row ‘‘Total’’ would be obtained by summing in quadrature the individual contributions of the systematic uncertainties.

Source of systematic uncertainty	Impact on $\sigma(\hat{\mu})$ [%]	
	$m_{H^+} = 170$ GeV	$m_{H^+} = 1000$ GeV
Experimental		
Luminosity	1.0	1.0
Trigger	12	4.1
$\tau_{had-vis}$	12	8.3
Jet	27	17
Electron	1.9	4.0
Muon	9.3	2.2
E_T^{miss}	35	3.3
Fake-factor method	21	16
Signal and background models		
$t\bar{t}$ modeling	20	14
Single-top-quark modeling	46	2.6
W/Z+jets modeling	13	51
Cross-sections (W/Z/VV/t)	2.3	15
H^+ signal modeling	8.5	1.0
Total	84	70

improving on the limits reported in Ref. [26]. The hypothetical contribution from the H^+ decaying to tb with the subsequent tauonic top decay ($t \rightarrow b\tau^+\nu_\tau$) contributing to the low $\tan\beta$ region is small due to a low branching fraction of the leptonic top-quark decay and has a lower reconstruction efficiency due to softer kinematics of the $\tau\nu$ system. Consequently, it is not considered in the derived exclusion, yielding a conservative result.

6 Conclusions

A search for H^+ bosons produced either in top-quark decays or in association with top quarks, subsequently decaying via $H^+ \rightarrow \tau\nu$ is performed in the H^+ mass range 80–3000 GeV. Depending on whether the top-quark produced together with the H^+ decays hadronically or semi-leptonically, the search targets τ +jets or τ +lepton final states, in both cases with a τ -lepton decaying into a neutrino and hadrons. The dataset used for this analysis is from pp collisions at $\sqrt{s} = 13$ TeV, collected with the ATLAS detector at the LHC, and corresponds to an integrated luminosity of 140 fb^{-1} . The discrimination between signal and background is based on a neural network parameterized as a function of the H^+ mass.

The data are found to be in agreement with the Standard Model background expectation. Upper limits at 95% CL are set on the H^+ production cross-section times branching fraction, $\sigma(pp \rightarrow tbH^+) \times \mathcal{B}(H^+ \rightarrow \tau\nu)$, ranging from 4.5 pb to 0.4 fb for H^+ masses in the range 80–3000 GeV. In the mass range 80–160 GeV, assuming the SM cross-section for $t\bar{t}$ production, this corresponds to upper limits between 0.27% and 0.02% for the branching fraction $\mathcal{B}(t \rightarrow bH^+) \times \mathcal{B}(H^+ \rightarrow \tau\nu)$. The upper limits are interpreted in the hMSSM and, for the first time in the $\tau\nu$ final state, the M_h^{125} scenarios of the MSSM. This search contributes to the broad program of H^+ searches at the LHC and provides the most restrictive limits to date in this production and decay mode.

Acknowledgments

We thank CERN for the very successful operation of the LHC and its injectors, as well as the support staff at CERN and at our institutions worldwide without whom ATLAS could not be operated efficiently.

The crucial computing support from all WLCG partners is acknowledged gratefully, in particular from CERN, the ATLAS Tier-1 facilities at TRIUMF/SFU (Canada), NDGF (Denmark, Norway, Sweden), CC-IN2P3 (France), KIT/GridKA (Germany), INFN-CNAF (Italy), NL-T1 (Netherlands), PIC (Spain), RAL (UK) and BNL (USA), the Tier-2 facilities worldwide and large non-WLCG resource providers. Major contributors of computing resources are listed in Ref. [92].

We gratefully acknowledge the support of ANPCyT, Argentina; YerPhI, Armenia; ARC, Australia; BMWFW and FWF, Austria; ANAS, Azerbaijan; CNPq and FAPESP, Brazil; NSERC, NRC and CFI, Canada; CERN; ANID, Chile; CAS, MOST and NSFC, China; Minciencias, Colombia; MEYS CR, Czech Republic; DNRF and DNSRC, Denmark; IN2P3-CNRS and CEA-DRF/IRFU, France; SRNSFG, Georgia; BMBF, HGF and MPG, Germany; GSRI, Greece; RGC and Hong Kong SAR, China; ICHEP and Academy of Sciences and Humanities, Israel; INFN, Italy; MEXT and JSPS, Japan; CNRST, Morocco; NWO, Netherlands; RCN, Norway; MNiSW, Poland; FCT, Portugal; MNE/IFA, Romania; MSTDI, Serbia; MSSR, Slovakia; ARIS and MVZI, Slovenia; DSI/NRF, South Africa; MICIU/AEI, Spain; SRC and Wallenberg Foundation, Sweden; SERI, SNSF and Cantons of Bern and Geneva, Switzerland; NSTC, Taipei; TENMAK, Türkiye; STFC/UKRI, United Kingdom; DOE and NSF, United States of America.

Individual groups and members have received support from BCKDF, CANARIE, CRC and DRAC, Canada; CERN-CZ, FORTE and PRIMUS, Czech Republic; COST, ERC, ERDF, Horizon 2020, ICSC-NextGenerationEU and Marie Skłodowska-Curie Actions, European Union; Investissements d’Avenir Labex, Investissements d’Avenir Idex and ANR, France; DFG and AvH Foundation, Germany; Herakleitos, Thales and Aristeia programmes co-financed by EU-ESF and the Greek NSRF, Greece; BSF-NSF and MINERVA, Israel; NCN and NAWA, Poland; La Caixa Banking Foundation, CERCA Programme Generalitat de Catalunya and PROMETEO and GenT Programmes Generalitat Valenciana, Spain; Göran Gustafssons Stiftelse, Sweden; The Royal Society and Leverhulme Trust, United Kingdom.

In addition, individual members wish to acknowledge support from Armenia: Yerevan Physics Institute (FAPERJ); CERN: European Organization for Nuclear Research (CERN DOCT); Chile: Agencia Nacional de Investigación y Desarrollo (FONDECYT 1230812, FONDECYT 1230987, FONDECYT 1240864); China: Chinese Ministry of Science and Technology (MOST-2023YFA1605700, MOST-2023YFA1609300), National Natural Science Foundation of China (NSFC - 12175119, NSFC 12275265, NSFC-12075060); Czech Republic: Czech Science Foundation (GACR - 24-11373S), Ministry of Education Youth and Sports (FORTE CZ.02.01.01/00/22_008/0004632), PRIMUS Research Programme

(PRIMUS/21/SCI/017); EU: H2020 European Research Council (ERC - 101002463); European Union: European Research Council (ERC - 948254, ERC 101089007, ERC, BARD, 101116429), European Union, Future Artificial Intelligence Research (FAIR-NextGenerationEU PE00000013), Italian Center for High Performance Computing, Big Data and Quantum Computing (ICSC, NextGenerationEU); France: Agence Nationale de la Recherche (ANR-20-CE31-0013, ANR-21-CE31-0013, ANR-21-CE31-0022, ANR-22-EDIR-0002); Germany: Baden-Württemberg Stiftung (BW Stiftung-Postdoc Eliteprogramme), Deutsche Forschungsgemeinschaft (DFG - 469666862, DFG - CR 312/5-2); Italy: Istituto Nazionale di Fisica Nucleare (ICSC, NextGenerationEU), Ministero dell'Università e della Ricerca (PRIN - 20223N7F8K - PNRR M4.C2.1.1); Japan: Japan Society for the Promotion of Science (JSPS KAKENHI JP22H01227, JSPS KAKENHI JP22H04944, JSPS KAKENHI JP22KK0227, JSPS KAKENHI JP23KK0245); Netherlands: Netherlands Organisation for Scientific Research (NWO Veni 2020 - VI.Veni.202.179); Norway: Research Council of Norway (RCN-314472); Poland: Ministry of Science and Higher Education (IDUB AGH, POB8, D4 no 9722), Polish National Agency for Academic Exchange (PPN/PPO/2020/1/00002/U/00001), Polish National Science Centre (NCN 2021/42/E/ST2/00350, NCN OPUS 2023/51/B/ST2/02507, NCN OPUS nr 2022/47/B/ST2/03059, NCN UMO-2019/34/E/ST2/00393, NCN & H2020 MSCA 945339, UMO-2020/37/B/ST2/01043, UMO-2021/40/C/ST2/00187, UMO-2022/47/O/ST2/00148, UMO-2023/49/B/ST2/04085, UMO-2023/51/B/ST2/00920); Slovenia: Slovenian Research Agency (ARIS grant J1-3010); Spain: Generalitat Valenciana (Artemisa, FEDER, ID-IFEDER/2018/048), Ministry of Science and Innovation (MCIN & NextGenEU PCI2022-135018-2, MICIN & FEDER PID2021-125273NB, RYC2019-028510-I, RYC2020-030254-I, RYC2021-031273-I, RYC2022-038164-I); Sweden: Carl Trygger Foundation (Carl Trygger Foundation CTS 22:2312), Swedish Research Council (Swedish Research Council 2023-04654, VR 2018-00482, VR 2022-03845, VR 2022-04683, VR 2023-03403, VR grant 2021-03651), Knut and Alice Wallenberg Foundation (KAW 2018.0458, KAW 2019.0447, KAW 2022.0358); Switzerland: Swiss National Science Foundation (SNSF - PCEFP2_194658); United Kingdom: Leverhulme Trust (Leverhulme Trust RPG-2020-004), Royal Society (NIF-R1-231091); United States of America: U.S. Department of Energy (ECA DE-AC02-76SF00515), Neubauer Family Foundation.

References

- [1] L. Evans and P. Bryant, *LHC Machine*, [JINST 3 \(2008\) S08001](#).
- [2] ATLAS Collaboration, *Observation of a new particle in the search for the Standard Model Higgs boson with the ATLAS detector at the LHC*, [Phys. Lett. B 716 \(2012\) 1](#), arXiv: [1207.7214 \[hep-ex\]](#).
- [3] CMS Collaboration, *Observation of a new boson at a mass of 125 GeV with the CMS experiment at the LHC*, [Phys. Lett. B 716 \(2012\) 30](#), arXiv: [1207.7235 \[hep-ex\]](#).
- [4] CMS Collaboration, *A measurement of the Higgs boson mass in the diphoton decay channel*, [Phys. Lett. B 805 \(2020\) 135425](#), arXiv: [2002.06398 \[hep-ex\]](#).
- [5] ATLAS Collaboration, *Combined Measurement of the Higgs Boson Mass from the $H \rightarrow \gamma\gamma$ and $H \rightarrow ZZ^* \rightarrow 4\ell$ Decay Channels with the ATLAS Detector Using $\sqrt{s} = 7, 8$, and 13 TeV pp Collision Data*, [Phys. Rev. Lett. 131 \(2023\) 251802](#), arXiv: [2308.04775 \[hep-ex\]](#).
- [6] CMS Collaboration, *Measurement of the Higgs boson mass and width using the four-lepton final state in proton-proton collisions at $\sqrt{s} = 13$ TeV*, (2024), arXiv: [2409.13663 \[hep-ex\]](#).
- [7] A. Djouadi, *The anatomy of electroweak symmetry breaking Tome II: The Higgs bosons in the Minimal Supersymmetric Model*, [Phys. Rept. 459 \(2008\) 1](#), arXiv: [hep-ph/0503173 \[hep-ph\]](#).
- [8] G. C. Branco et al., *Theory and phenomenology of two-Higgs-doublet models*, [Phys. Rept. 516 \(2012\) 1](#), arXiv: [1106.0034 \[hep-ph\]](#).
- [9] G. Senjanovic and R. N. Mohapatra, *Exact left-right symmetry and spontaneous violation of parity*, [Phys. Rev. D 12 \(1975\) 1502](#).
- [10] J. E. Cieza Montalvo, N. V. Cortez, J. Sa Borges, and M. D. Tonasse, *Searching for doubly charged Higgs bosons at the LHC in a 3-3-1 model*, [Nucl. Phys. B 756 \(2006\) 1](#), arXiv: [hep-ph/0606243](#), Erratum: [Nucl. Phys. B 796 \(2008\) 422](#).
- [11] J. F. Gunion, R. Vega, and J. Wudka, *Higgs triplets in the standard model*, [Phys. Rev. D 42 \(1990\) 1673](#).
- [12] H. Georgi and M. Machacek, *Doubly Charged Higgs Bosons*, [Nucl. Phys. B 262 \(1985\) 463](#).
- [13] C. Degrande, M. Ubiali, M. Wiesemann, and M. Zaro, *Heavy charged Higgs boson production at the LHC*, [JHEP 10 \(2015\) 145](#), arXiv: [1507.02549 \[hep-ph\]](#).
- [14] C. Degrande et al., *Accurate predictions for charged Higgs production: Closing the $m_{H^\pm} \sim m_t$ window*, [Phys. Lett. B 772 \(2017\) 87](#), arXiv: [1607.05291 \[hep-ph\]](#).
- [15] ALEPH, DELPHI, L3, OPAL and LEP Collaborations, *Search for charged Higgs bosons: combined results using LEP data*, [Eur. Phys. J. C 73 \(2013\) 2463](#), arXiv: [hep-ex/1301.6065](#).
- [16] ATLAS Collaboration, *Search for charged Higgs bosons decaying via $H^\pm \rightarrow \tau\nu$ in $t\bar{t}$ events using pp collision data at $\sqrt{s} = 7$ TeV with the ATLAS detector*, [JHEP 06 \(2012\) 039](#), arXiv: [1204.2760 \[hep-ex\]](#).
- [17] ATLAS Collaboration, *Search for charged Higgs bosons through the violation of lepton universality in $t\bar{t}$ events using pp collision data at $\sqrt{s} = 7$ TeV with the ATLAS experiment*, [JHEP 03 \(2013\) 076](#), arXiv: [1212.3572 \[hep-ex\]](#).
- [18] ATLAS Collaboration, *Search for charged Higgs bosons decaying via $H^\pm \rightarrow \tau^\pm\nu$ in fully hadronic final states using pp collision data at $\sqrt{s} = 8$ TeV with the ATLAS detector*, [JHEP 03 \(2015\) 088](#), arXiv: [1412.6663 \[hep-ex\]](#).

- [19] CMS Collaboration, *Search for a light charged Higgs boson in top quark decays in pp collisions at $\sqrt{s} = 7$ TeV*, *JHEP* **07** (2012) 143, arXiv: [1205.5736 \[hep-ex\]](#).
- [20] CMS Collaboration, *Search for a charged Higgs boson in pp collisions at $\sqrt{s} = 8$ TeV*, *JHEP* **11** (2015) 018, arXiv: [1508.07774 \[hep-ex\]](#).
- [21] CMS Collaboration, *Search for a charged Higgs boson decaying to charm and bottom quarks in proton–proton collisions at $\sqrt{s} = 8$ TeV*, *JHEP* **11** (2018) 115, arXiv: [1808.06575 \[hep-ex\]](#).
- [22] ATLAS Collaboration, *Search for a light charged Higgs boson in the decay channel $H^+ \rightarrow c\bar{s}$ in $t\bar{t}$ events using pp collisions at $\sqrt{s} = 7$ TeV with the ATLAS detector*, *Eur. Phys. J. C* **73** (2013) 2465, arXiv: [1302.3694 \[hep-ex\]](#).
- [23] CMS Collaboration, *Search for a light charged Higgs boson decaying to $c\bar{s}$ in pp collisions at $\sqrt{s} = 8$ TeV*, *JHEP* **12** (2015) 178, arXiv: [1510.04252 \[hep-ex\]](#).
- [24] ATLAS Collaboration, *Search for charged Higgs bosons in the $H^\pm \rightarrow tb$ decay channel in pp collisions at $\sqrt{s} = 8$ TeV using the ATLAS detector*, *JHEP* **03** (2016) 127, arXiv: [1512.03704 \[hep-ex\]](#).
- [25] ATLAS Collaboration, *Search for a Charged Higgs Boson Produced in the Vector-Boson Fusion Mode with Decay $H^\pm \rightarrow W^\pm Z$ using pp Collisions at $\sqrt{s} = 8$ TeV with the ATLAS Experiment*, *Phys. Rev. Lett.* **114** (2015) 231801, arXiv: [1503.04233 \[hep-ex\]](#).
- [26] ATLAS Collaboration, *Search for charged Higgs bosons decaying via $H^\pm \rightarrow \tau^\pm \nu_\tau$ in the τ +jets and τ +lepton final states with 36fb^{-1} of pp collision data recorded at $\sqrt{s} = 13$ TeV with the ATLAS experiment*, *JHEP* **09** (2018) 139, arXiv: [1807.07915 \[hep-ex\]](#).
- [27] CMS Collaboration, *Search for charged Higgs bosons in the $H^\pm \rightarrow \tau^\pm \nu_\tau$ decay channel in proton–proton collisions at $\sqrt{s} = 13$ TeV*, *JHEP* **07** (2019) 142, arXiv: [1903.04560 \[hep-ex\]](#).
- [28] ATLAS Collaboration, *Search for charged Higgs bosons decaying into a top quark and a bottom quark at $\sqrt{s} = 13$ TeV with the ATLAS detector*, *JHEP* **06** (2021) 145, arXiv: [2102.10076 \[hep-ex\]](#).
- [29] CMS Collaboration, *Search for charged Higgs bosons decaying into a top and a bottom quark in the all-jet final state of pp collisions at $\sqrt{s} = 13$ TeV*, *JHEP* **07** (2020) 126, arXiv: [2001.07763 \[hep-ex\]](#).
- [30] ATLAS Collaboration, *Search for resonant WZ production in the fully leptonic final state in proton–proton collisions at $\sqrt{s} = 13$ TeV with the ATLAS detector*, *Phys. Lett. B* **787** (2018) 68, arXiv: [1806.01532 \[hep-ex\]](#).
- [31] CMS Collaboration, *Search for charged Higgs bosons produced in vector boson fusion processes and decaying into vector boson pairs in proton–proton collisions at $\sqrt{s} = 13$ TeV*, *Eur. Phys. J. C* **81** (2021) 723, arXiv: [2104.04762 \[hep-ex\]](#).
- [32] CMS Collaboration, *Search for a charged Higgs boson decaying into a heavy neutral Higgs boson and a W boson in proton–proton collisions at $\sqrt{s} = 13$ TeV*, *JHEP* **09** (2023) 032, arXiv: [2207.01046 \[hep-ex\]](#).
- [33] ATLAS Collaboration, *Search for a heavy charged Higgs boson decaying into a W boson and a Higgs boson in final states with leptons and b-jets in $\sqrt{s} = 13$ TeV pp collisions with the ATLAS detector*, (2024), arXiv: [2411.03969 \[hep-ex\]](#).
- [34] ATLAS Collaboration, *Search for a light charged Higgs boson in $t \rightarrow H^\pm b$ decays, with $H^\pm \rightarrow cb$, in the lepton+jets final state in proton–proton collisions at $\sqrt{s} = 13$ TeV with the ATLAS detector*, *JHEP* **09** (2023) 004, arXiv: [2302.11739 \[hep-ex\]](#).

- [35] CMS Collaboration, *Search for a light charged Higgs boson in the $H^\pm \rightarrow cs$ channel in proton–proton collisions at $\sqrt{s} = 13$ TeV*, *Phys. Rev. D* **102** (2020) 072001, arXiv: [2005.08900 \[hep-ex\]](#).
- [36] ATLAS Collaboration, *Search for a light charged Higgs boson in $t \rightarrow H^\pm b$ decays, with $H^\pm \rightarrow cs$, in pp collisions at $\sqrt{s} = 13$ TeV with the ATLAS detector*, (2024), arXiv: [2407.10096 \[hep-ex\]](#).
- [37] ATLAS Collaboration, *Search for Heavy Higgs Bosons Decaying into Two Tau Leptons with the ATLAS Detector Using pp Collisions at $\sqrt{s} = 13$ TeV*, *Phys. Rev. Lett.* **125** (2020) 051801, arXiv: [2002.12223 \[hep-ex\]](#).
- [38] CMS Collaboration, *Searches for additional Higgs bosons and for vector leptoquarks in $\tau\tau$ final states in proton–proton collisions at $\sqrt{s} = 13$ TeV*, *JHEP* **07** (2023) 073, arXiv: [2208.02717 \[hep-ex\]](#).
- [39] A. Djouadi et al., *The post-Higgs MSSM scenario: habemus MSSM?* *Eur. Phys. J. C* **73** (2013) 2650, arXiv: [1307.5205 \[hep-ph\]](#).
- [40] A. Djouadi, L. Maiani, A. Polosa, J. Quevillon, and V. Riquer, *Fully covering the MSSM Higgs sector at the LHC*, *JHEP* **06** (2015) 168, arXiv: [1502.05653 \[hep-ph\]](#).
- [41] Heavy Flavor Averaging Group, *HFLAV Semileptonic HF Results: $R(D)$ and $R(D^*)$ Ratios*, <https://hflav-eos.web.cern.ch/hflav-eos/semi/moriond24/html/RDsDsstar/RDRDs.html>, 2024.
- [42] J. Hernandez-Sanchez, S. Moretti, R. Noriega-Papaqui, and A. Rosado, *Off-diagonal terms in Yukawa textures of the Type-III 2-Higgs doublet model and light charged Higgs boson phenomenology*, *JHEP* **07** (2013) 044, arXiv: [1212.6818 \[hep-ph\]](#).
- [43] S. Iguro and K. Tobe, *$R(D^{(*)})$ in a general two Higgs doublet model*, *Nucl. Phys. B* **925** (2017) 560, arXiv: [1708.06176 \[hep-ph\]](#).
- [44] W. Altmannshofer, P. S. Bhupal Dev, and A. Soni, *$R_{D^{(*)}}$ anomaly: A possible hint for natural supersymmetry with R -parity violation*, *Phys. Rev. D* **96** (2017) 095010, arXiv: [1704.06659 \[hep-ph\]](#).
- [45] E. Bagnaschi et al., *MSSM Higgs boson searches at the LHC: benchmark scenarios for Run 2 and beyond*, *Eur. Phys. J. C* **79** (2019) 617, arXiv: [1808.07542 \[hep-ph\]](#).
- [46] Y. Freund and R. E. Schapire, *A Decision-Theoretic Generalization of On-Line Learning and an Application to Boosting*, *J. Comput. Syst. Sci.* **55** (1997) 119.
- [47] P. Baldi, K. Cranmer, T. Faucett, P. Sadowski, and D. Whiteson, *Parameterized neural networks for high-energy physics*, *Eur. Phys. J. C* **76** (2016) 235, arXiv: [1601.07913 \[hep-ex\]](#).
- [48] ATLAS Collaboration, *The ATLAS Experiment at the CERN Large Hadron Collider*, *JINST* **3** (2008) S08003.
- [49] G. Avoni et al., *The new LUCID-2 detector for luminosity measurement and monitoring in ATLAS*, *JINST* **13** (2018) P07017.
- [50] ATLAS Collaboration, *Performance of the ATLAS trigger system in 2015*, *Eur. Phys. J. C* **77** (2017) 317, arXiv: [1611.09661 \[hep-ex\]](#).
- [51] ATLAS Collaboration, *Software and computing for Run 3 of the ATLAS experiment at the LHC*, (2024), arXiv: [2404.06335 \[hep-ex\]](#).
- [52] ATLAS Collaboration, *Luminosity determination in pp collisions at $\sqrt{s} = 13$ TeV using the ATLAS detector at the LHC*, *Eur. Phys. J. C* **83** (2023) 982, arXiv: [2212.09379 \[hep-ex\]](#).

- [53] S. Agostinelli et al., *GEANT4 – a simulation toolkit*, *Nucl. Instrum. Meth. A* **506** (2003) 250.
- [54] ATLAS Collaboration, *The ATLAS Simulation Infrastructure*, *Eur. Phys. J. C* **70** (2010) 823, arXiv: [1005.4568](https://arxiv.org/abs/1005.4568) [[physics.ins-det](https://arxiv.org/archive/physics)].
- [55] T. Sjöstrand, S. Mrenna and P. Z. Skands, *A brief introduction to PYTHIA 8.1*, *Comput. Phys. Commun.* **178** (2008) 852, arXiv: [hep-ph/0710.3820](https://arxiv.org/abs/hep-ph/0710.3820).
- [56] ATLAS Collaboration, *The Pythia 8 A3 tune description of ATLAS minimum bias and inelastic measurements incorporating the Donnachie–Landshoff diffractive model*, tech. rep., CERN, 2016, URL: <https://cds.cern.ch/record/2206965>.
- [57] NNPDF Collaboration, R. D. Ball, et al., *Parton distributions with LHC data*, *Nucl. Phys. B* **867** (2013) 244, arXiv: [1207.1303](https://arxiv.org/abs/1207.1303) [[hep-ph](https://arxiv.org/archive/hep)].
- [58] S. Alioli, P. Nason, C. Oleari, and E. Re, *A general framework for implementing NLO calculations in shower Monte Carlo programs: the POWHEG BOX*, *JHEP* **06** (2010) 043, arXiv: [1002.2581](https://arxiv.org/abs/1002.2581) [[hep-ph](https://arxiv.org/archive/hep)].
- [59] T. Sjöstrand et al., *An introduction to PYTHIA 8.2*, *Comput. Phys. Commun.* **191** (2015) 159, arXiv: [1410.3012](https://arxiv.org/abs/1410.3012) [[hep-ph](https://arxiv.org/archive/hep)].
- [60] NNPDF Collaboration, R. D. Ball, et al., *Parton distributions for the LHC run II*, *JHEP* **04** (2015) 040, arXiv: [1410.8849](https://arxiv.org/abs/1410.8849) [[hep-ph](https://arxiv.org/archive/hep)].
- [61] E. Bothmann et al., *Event generation with Sherpa 2.2*, *SciPost Phys.* **7** (2019) 034, arXiv: [1905.09127](https://arxiv.org/abs/1905.09127) [[hep-ph](https://arxiv.org/archive/hep)].
- [62] H.-L. Lai et al., *New parton distributions for collider physics*, *Phys. Rev. D* **82** (2010) 074024, arXiv: [1007.2241](https://arxiv.org/abs/1007.2241) [[hep-ph](https://arxiv.org/archive/hep)].
- [63] J. Alwall et al., *The automated computation of tree-level and next-to-leading order differential cross sections, and their matching to parton shower simulations*, *JHEP* **07** (2014) 079, arXiv: [1405.0301](https://arxiv.org/abs/1405.0301) [[hep-ph](https://arxiv.org/archive/hep)].
- [64] ATLAS Collaboration, *ATLAS Pythia 8 tunes to 7 TeV data*, ATL-PHYS-PUB-2014-021, 2014, URL: <https://cds.cern.ch/record/1966419>.
- [65] ATLAS Collaboration, *Vertex Reconstruction Performance of the ATLAS Detector at $\sqrt{s} = 13$ TeV*, ATL-PHYS-PUB-2015-026, 2015, URL: <https://cds.cern.ch/record/2037717>.
- [66] ATLAS Collaboration, *ATLAS data quality operations and performance for 2015–2018 data-taking*, *JINST* **15** (2020) P04003, arXiv: [1911.04632](https://arxiv.org/abs/1911.04632) [[physics.ins-det](https://arxiv.org/archive/physics)].
- [67] ATLAS Collaboration, *Reconstruction, Energy Calibration, and Identification of Hadronically Decaying Tau Leptons in the ATLAS Experiment for Run-2 of the LHC*, ATL-PHYS-PUB-2015-045, 2015, URL: <https://cds.cern.ch/record/2064383>.
- [68] ATLAS Collaboration, *Identification of hadronic tau lepton decays using neural networks in the ATLAS experiment*, ATL-PHYS-PUB-2019-033, 2019, URL: <https://cds.cern.ch/record/2688062>.
- [69] ATLAS Collaboration, *Measurement of the tau lepton reconstruction and identification performance in the ATLAS experiment using pp collisions at $\sqrt{s} = 13$ TeV*, ATLAS-CONF-2017-029, 2017, URL: <https://cds.cern.ch/record/2261772>.
- [70] ATLAS Collaboration, *Electron and photon efficiencies in LHC Run 2 with the ATLAS experiment*, *JHEP* **05** (2024) 162, arXiv: [2308.13362](https://arxiv.org/abs/2308.13362) [[hep-ex](https://arxiv.org/archive/hep)].

- [71] ATLAS Collaboration, *Muon reconstruction and identification efficiency in ATLAS using the full Run 2 pp collision data set at $\sqrt{s} = 13$ TeV*, *Eur. Phys. J. C* **81** (2021) 578, arXiv: [2012.00578 \[hep-ex\]](#).
- [72] ATLAS Collaboration, *Jet reconstruction and performance using particle flow with the ATLAS Detector*, *Eur. Phys. J. C* **77** (2017) 466, arXiv: [1703.10485 \[hep-ex\]](#).
- [73] M. Cacciari, G. P. Salam, and G. Soyez, *The anti- k_t jet clustering algorithm*, *JHEP* **04** (2008) 063, arXiv: [0802.1189 \[hep-ph\]](#).
- [74] M. Cacciari, G. P. Salam, and G. Soyez, *FastJet user manual*, *Eur. Phys. J. C* **72** (2012) 1896, arXiv: [1111.6097 \[hep-ph\]](#).
- [75] ATLAS Collaboration, *ATLAS flavour-tagging algorithms for the LHC Run 2 pp collision dataset*, *Eur. Phys. J. C* **83** (2023) 681, arXiv: [2211.16345 \[physics.data-an\]](#).
- [76] ATLAS Collaboration, *The performance of missing transverse momentum reconstruction and its significance with the ATLAS detector using 140 fb^{-1} of $\sqrt{s} = 13$ TeV pp collisions*, (2024), arXiv: [2402.05858 \[hep-ex\]](#).
- [77] ATLAS Collaboration, *Performance of the missing transverse momentum triggers for the ATLAS detector during Run-2 data taking*, *JHEP* **08** (2020) 080, arXiv: [2005.09554 \[hep-ex\]](#).
- [78] ATLAS Collaboration, *Search for charged Higgs bosons produced in association with a top quark and decaying via $H^\pm \rightarrow \tau\nu$ using pp collision data recorded at $\sqrt{s} = 13$ TeV by the ATLAS detector*, *Phys. Lett. B* **759** (2016) 555, arXiv: [1603.09203 \[hep-ex\]](#).
- [79] ATLAS Collaboration, *Performance of electron and photon triggers in ATLAS during LHC Run 2*, *Eur. Phys. J. C* **80** (2020) 47, arXiv: [1909.00761 \[hep-ex\]](#).
- [80] ATLAS Collaboration, *Performance of the ATLAS muon triggers in Run 2*, *JINST* **15** (2020) P09015, arXiv: [2004.13447 \[physics.ins-det\]](#).
- [81] ATLAS Collaboration, *The ATLAS inner detector trigger performance in pp collisions at 13 TeV during LHC Run 2*, *Eur. Phys. J. C* **82** (2022) 206, arXiv: [2107.02485 \[hep-ex\]](#).
- [82] ATLAS Collaboration, *The performance of the jet trigger for the ATLAS detector during 2011 data taking*, *Eur. Phys. J. C* **76** (2016) 526, arXiv: [1606.07759 \[hep-ex\]](#).
- [83] F. Chollet et al., *Keras*, 2015, URL: <https://keras.io>.
- [84] Martín Abadi et al., *TensorFlow: Large-Scale Machine Learning on Heterogeneous Systems*, Software available from tensorflow.org, 2015, URL: <https://www.tensorflow.org>.
- [85] M. Stone, *Cross-validatory choice and assessment of statistical predictions*, *J. R. Stat. Soc. Ser. B Methodol.* **36** (1974) 111, URL: <https://www.jstor.org/stable/2984809>.
- [86] ATLAS Collaboration, *Measurement of τ polarization in $W \rightarrow \tau\nu$ decays with the ATLAS detector in pp collisions at $\sqrt{s} = 7$ TeV*, *Eur. Phys. J. C* **72** (2012) 2062, arXiv: [1204.6720 \[hep-ex\]](#).
- [87] J. Bellm et al., *Herwig 7.0/Herwig++ 3.0 release note*, *Eur. Phys. J. C* **76** (2016) 196, arXiv: [1512.01178 \[hep-ph\]](#).
- [88] ATLAS Collaboration, *Luminosity determination in pp collisions at $\sqrt{s} = 13$ TeV using the ATLAS detector at the LHC*, *Eur. Phys. J. C* **83** (2023) 982, arXiv: [2212.09379 \[hep-ex\]](#).
- [89] G. Cowan, K. Cranmer, E. Gross, and O. Vitells, *Asymptotic formulae for likelihood-based tests of new physics*, *Eur. Phys. J. C* **71** (2011) 1554, arXiv: [1007.1727 \[physics.data-an\]](#), Erratum: *Eur. Phys. J. C* **73** (2013) 2501.

- [90] A. L. Read, *Presentation of search results: the CL_S technique*, *J. Phys. G* **28** (2002) 2693.
- [91] J. R. Andersen et al., *Handbook of LHC Higgs Cross Sections: 3. Higgs Properties*, (2013), arXiv: [1307.1347](https://arxiv.org/abs/1307.1347) [[hep-ph](https://arxiv.org/abs/1307.1347)].
- [92] ATLAS Collaboration, *ATLAS Computing Acknowledgements*, ATL-SOFT-PUB-2023-001, 2023, URL: <https://cds.cern.ch/record/2869272>.

The ATLAS Collaboration

G. Aad ¹⁰⁴, E. Aakvaag ¹⁷, B. Abbott ¹²³, S. Abdelhameed ^{119a}, K. Abeling ⁵⁶, N.J. Abicht ⁵⁰, S.H. Abidi ³⁰, M. Aboeela ⁴⁶, A. Aboulhorma ^{36e}, H. Abramowicz ¹⁵⁵, Y. Abulaiti ¹²⁰, B.S. Acharya ^{70a,70b,n}, A. Ackermann ^{64a}, C. Adam Bourdarios ⁴, L. Adamczyk ^{87a}, S.V. Addepalli ¹⁴⁷, M.J. Addison ¹⁰³, J. Adelman ¹¹⁸, A. Adiguzel ^{22c}, T. Adye ¹³⁷, A.A. Affolder ¹³⁹, Y. Afik ⁴¹, M.N. Agaras ¹³, A. Aggarwal ¹⁰², C. Agheorghiesei ^{28c}, F. Ahmadov ^{40,ac}, S. Ahuja ⁹⁷, X. Ai ^{63e}, G. Aielli ^{77a,77b}, A. Aikot ¹⁶⁷, M. Ait Tamlihat ^{36e}, B. Aitbenkikh ^{36a}, M. Akbiyik ¹⁰², T.P.A. Åkesson ¹⁰⁰, A.V. Akimov ¹⁴⁹, D. Akiyama ¹⁷², N.N. Akolkar ²⁵, S. Aktas ^{22a}, G.L. Alberghi ^{24b}, J. Albert ¹⁶⁹, P. Albicocco ⁵⁴, G.L. Albouy ⁶¹, S. Alderweireldt ⁵³, Z.L. Alegria ¹²⁴, M. Aleksa ³⁷, I.N. Aleksandrov ⁴⁰, C. Alexa ^{28b}, T. Alexopoulos ¹⁰, F. Alfonsi ^{24b}, M. Algren ⁵⁷, M. Alhroob ¹⁷¹, B. Ali ¹³⁵, H.M.J. Ali ^{93,w}, S. Ali ³², S.W. Alibocus ⁹⁴, M. Aliev ^{34c}, G. Alimonti ^{72a}, W. Alkahi ⁵⁶, C. Allaire ⁶⁷, B.M.M. Allbrooke ¹⁵⁰, J.S. Allen ¹⁰³, J.F. Allen ⁵³, C.A. Allendes Flores ^{140f}, P.P. Allport ²¹, A. Aloisio ^{73a,73b}, F. Alonso ⁹², C. Alpigiani ¹⁴², Z.M.K. Alsolami ⁹³, A. Alvarez Fernandez ¹⁰², M. Alves Cardoso ⁵⁷, M.G. Alviggi ^{73a,73b}, M. Aly ¹⁰³, Y. Amaral Coutinho ^{84b}, A. Ambler ¹⁰⁶, C. Amelung ³⁷, M. Amerl ¹⁰³, C.G. Ames ¹¹¹, D. Amidei ¹⁰⁸, B. Amini ⁵⁵, K.J. Amirie ¹⁵⁸, A. Amirkhanov ³⁹, S.P. Amor Dos Santos ^{133a}, K.R. Amos ¹⁶⁷, D. Amperiadou ¹⁵⁶, S. An ⁸⁵, V. Ananiev ¹²⁸, C. Anastopoulos ¹⁴³, T. Andeen ¹¹, J.K. Anders ⁹⁴, A.C. Anderson ⁶⁰, A. Andreazza ^{72a,72b}, S. Angelidakis ⁹, A. Angerami ⁴³, A.V. Anisenkov ³⁹, A. Annovi ^{75a}, C. Antel ⁵⁷, E. Antipov ¹⁴⁹, M. Antonelli ⁵⁴, F. Anulli ^{76a}, M. Aoki ⁸⁵, T. Aoki ¹⁵⁷, M.A. Aparo ¹⁵⁰, L. Aperio Bella ⁴⁹, C. Appelt ¹⁵⁵, A. Apyan ²⁷, S.J. Arbiol Val ⁸⁸, C. Arcangeletti ⁵⁴, A.T.H. Arce ⁵², J-F. Arguin ¹¹⁰, S. Argyropoulos ¹⁵⁶, J.-H. Arling ⁴⁹, O. Arnaez ⁴, H. Arnold ¹⁴⁹, G. Artoni ^{76a,76b}, H. Asada ¹¹³, K. Asai ¹²¹, S. Asai ¹⁵⁷, N.A. Asbah ³⁷, R.A. Ashby Pickering ¹⁷¹, A.M. Aslam ⁹⁷, K. Assamagan ³⁰, R. Astalos ^{29a}, K.S.V. Astrand ¹⁰⁰, S. Atashi ¹⁶², R.J. Atkin ^{34a}, H. Atmani ^{36f}, P.A. Atlasiddha ¹³¹, K. Augsten ¹³⁵, A.D. Auriol ⁴², V.A. Austrup ¹⁰³, G. Avolio ³⁷, K. Axiotis ⁵⁷, G. Azuelos ^{110,ag}, D. Babal ^{29b}, H. Bachacou ¹³⁸, K. Bachas ^{156,r}, A. Bachi ³⁵, E. Bachmann ⁵¹, A. Badea ⁴¹, T.M. Baer ¹⁰⁸, P. Bagnaia ^{76a,76b}, M. Bahmani ¹⁹, D. Bahner ⁵⁵, K. Bai ¹²⁶, J.T. Baines ¹³⁷, L. Baines ⁹⁶, O.K. Baker ¹⁷⁶, E. Bakos ¹⁶, D. Bakshi Gupta ⁸, L.E. Balabram Filho ^{84b}, V. Balakrishnan ¹²³, R. Balasubramanian ⁴, E.M. Baldin ³⁹, P. Balek ^{87a}, E. Ballabene ^{24b,24a}, F. Balli ¹³⁸, L.M. Baltes ^{64a}, W.K. Balunas ³³, J. Balz ¹⁰², I. Bamwidhi ^{119b}, E. Banas ⁸⁸, M. Bandieramonte ¹³², A. Bandyopadhyay ²⁵, S. Bansal ²⁵, L. Barak ¹⁵⁵, M. Barakat ⁴⁹, E.L. Barberio ¹⁰⁷, D. Barberis ^{58b,58a}, M. Barbero ¹⁰⁴, M.Z. Barel ¹¹⁷, T. Barillari ¹¹², M-S. Barisits ³⁷, T. Barklow ¹⁴⁷, P. Baron ¹²⁵, D.A. Baron Moreno ¹⁰³, A. Baroncelli ^{63a}, A.J. Barr ¹²⁹, J.D. Barr ⁹⁸, F. Barreiro ¹⁰¹, J. Barreiro Guimarães da Costa ¹⁴, M.G. Barros Teixeira ^{133a}, S. Barsov ³⁹, F. Bartels ^{64a}, R. Bartoldus ¹⁴⁷, A.E. Barton ⁹³, P. Bartos ^{29a}, A. Basan ¹⁰², M. Baselga ⁵⁰, S. Bashiri ⁸⁸, A. Bassalat ^{67,b}, M.J. Basso ^{159a}, S. Bataju ⁴⁶, R. Bate ¹⁶⁸, R.L. Bates ⁶⁰, S. Batlamous ¹⁰¹, M. Battaglia ¹³⁹, D. Battulga ¹⁹, M. Bauce ^{76a,76b}, M. Bauer ⁸⁰, P. Bauer ²⁵, L.T. Bazzano Hurrell ³¹, J.B. Beacham ¹¹², T. Beau ¹³⁰, J.Y. Beaucamp ⁹², P.H. Beauchemin ¹⁶¹, P. Bechtel ²⁵, H.P. Beck ^{20,q}, K. Becker ¹⁷¹, A.J. Beddall ⁸³, V.A. Bednyakov ⁴⁰, C.P. Bee ¹⁴⁹, L.J. Beemster ¹⁶, M. Begalli ^{84d}, M. Begel ³⁰, J.K. Behr ⁴⁹, J.F. Beirer ³⁷, F. Beisiegel ²⁵, M. Belfkir ^{119b}, G. Bella ¹⁵⁵, L. Bellagamba ^{24b}, A. Bellerive ³⁵, P. Bellos ²¹, K. Beloborodov ³⁹, D. Bencheikroun ^{36a}, F. Bendebba ^{36a}, Y. Benhammou ¹⁵⁵, K.C. Benkendorfer ⁶², L. Beresford ⁴⁹, M. Beretta ⁵⁴, E. Bergeas Kuutmann ¹⁶⁵, N. Berger ⁴, B. Bergmann ¹³⁵, J. Beringer ^{18a},

G. Bernardi ^{id5}, C. Bernius ^{id147}, F.U. Bernlochner ^{id25}, F. Bernon ^{id37}, A. Berrocal Guardia ^{id13}, T. Berry ^{id97}, P. Berta ^{id136}, A. Berthold ^{id51}, S. Bethke ^{id112}, A. Betti ^{id76a,76b}, A.J. Bevan ^{id96}, N.K. Bhalla ^{id55}, S. Bharthuar ^{id112}, S. Bhatta ^{id149}, D.S. Bhattacharya ^{id170}, P. Bhattarai ^{id147}, Z.M. Bhatti ^{id120}, K.D. Bhide ^{id55}, V.S. Bhopatkar ^{id124}, R.M. Bianchi ^{id132}, G. Bianco ^{id24b,24a}, O. Biebel ^{id111}, M. Biglietti ^{id78a}, C.S. Billingsley ^{id46}, Y. Bimgdi ^{id36f}, M. Bindi ^{id56}, A. Bingham ^{id175}, A. Bingul ^{id22b}, C. Bini ^{id76a,76b}, G.A. Bird ^{id33}, M. Birman ^{id173}, M. Biroš ^{id136}, S. Biryukov ^{id150}, T. Bisanz ^{id50}, E. Bisceglie ^{id45b,45a}, J.P. Biswal ^{id137}, D. Biswas ^{id145}, I. Bloch ^{id49}, A. Blue ^{id60}, U. Blumenschein ^{id96}, J. Blumenthal ^{id102}, V.S. Bobrovnikov ^{id39}, M. Boehler ^{id55}, B. Boehm ^{id170}, D. Bogavac ^{id37}, A.G. Bogdanchikov ^{id39}, L.S. Boggia ^{id130}, V. Boisvert ^{id97}, P. Bokan ^{id37}, T. Bold ^{id87a}, M. Bomben ^{id5}, M. Bona ^{id96}, M. Boonekamp ^{id138}, A.G. Borbély ^{id60}, I.S. Bordulev ^{id39}, G. Borissov ^{id93}, D. Bortoletto ^{id129}, D. Boscherini ^{id24b}, M. Bosman ^{id13}, K. Bouaouda ^{id36a}, N. Bouchhar ^{id167}, L. Boudet ^{id4}, J. Boudreau ^{id132}, E.V. Bouhova-Thacker ^{id93}, D. Boumediene ^{id42}, R. Bouquet ^{id58b,58a}, A. Boveia ^{id122}, J. Boyd ^{id37}, D. Boye ^{id30}, I.R. Boyko ^{id40}, L. Bozianu ^{id57}, J. Bracinik ^{id21}, N. Brahim ^{id4}, G. Brandt ^{id175}, O. Brandt ^{id33}, B. Brau ^{id105}, J.E. Brau ^{id126}, R. Brenner ^{id173}, L. Brenner ^{id117}, R. Brenner ^{id165}, S. Bressler ^{id173}, G. Brianti ^{id79a,79b}, D. Britton ^{id60}, D. Britzger ^{id112}, I. Brock ^{id25}, R. Brock ^{id109}, G. Brooijmans ^{id43}, A.J. Brooks ^{id69}, E.M. Brooks ^{id159b}, E. Brost ^{id30}, L.M. Brown ^{id169}, L.E. Bruce ^{id62}, T.L. Bruckler ^{id129}, P.A. Bruckman de Renstrom ^{id88}, B. Brüers ^{id49}, A. Bruni ^{id24b}, G. Bruni ^{id24b}, D. Brunner ^{id48a,48b}, M. Bruschi ^{id24b}, N. Bruscinò ^{id76a,76b}, T. Buanes ^{id17}, Q. Buat ^{id142}, D. Buchin ^{id112}, A.G. Buckley ^{id60}, O. Bulekov ^{id39}, B.A. Bullard ^{id147}, S. Burdin ^{id94}, C.D. Burgard ^{id50}, A.M. Burger ^{id37}, B. Burghgrave ^{id8}, O. Burlayenko ^{id55}, J. Burleson ^{id166}, J.T.P. Burr ^{id33}, J.C. Burzynski ^{id146}, E.L. Busch ^{id43}, V. Büscher ^{id102}, P.J. Bussey ^{id60}, J.M. Butler ^{id26}, C.M. Buttar ^{id60}, J.M. Butterworth ^{id98}, W. Buttinger ^{id137}, C.J. Buxo Vazquez ^{id109}, A.R. Buzykaev ^{id39}, S. Cabrera Urbán ^{id167}, L. Cadamuro ^{id67}, D. Caforio ^{id59}, H. Cai ^{id132}, Y. Cai ^{id24b,114c,24a}, Y. Cai ^{id114a}, V.M.M. Cairo ^{id37}, O. Cakir ^{id3a}, N. Calace ^{id37}, P. Calafiura ^{id18a}, G. Calderini ^{id130}, P. Calfayan ^{id35}, G. Callea ^{id60}, L.P. Caloba ^{id84b}, D. Calvet ^{id42}, S. Calvet ^{id42}, R. Camacho Toro ^{id130}, S. Camarda ^{id37}, D. Camarero Munoz ^{id27}, P. Camarri ^{id77a,77b}, M.T. Camerlingo ^{id73a,73b}, D. Cameron ^{id37}, C. Camincher ^{id169}, M. Campanelli ^{id98}, A. Camplani ^{id44}, V. Canale ^{id73a,73b}, A.C. Canbay ^{id3a}, E. Canonero ^{id97}, J. Cantero ^{id167}, Y. Cao ^{id166}, F. Capocasa ^{id27}, M. Capua ^{id45b,45a}, A. Carbone ^{id72a,72b}, R. Cardarelli ^{id77a}, J.C.J. Cardenas ^{id8}, M.P. Cardiff ^{id27}, G. Carducci ^{id45b,45a}, T. Carli ^{id37}, G. Carlino ^{id73a}, J.I. Carlotto ^{id13}, B.T. Carlson ^{id132,s}, E.M. Carlson ^{id169}, J. Carmignani ^{id94}, L. Carminati ^{id72a,72b}, A. Carnelli ^{id138}, M. Carnesale ^{id37}, S. Caron ^{id116}, E. Carquin ^{id140f}, I.B. Carr ^{id107}, S. Carrá ^{id72a}, G. Carratta ^{id24b,24a}, A.M. Carroll ^{id126}, M.P. Casado ^{id13,i}, M. Caspar ^{id49}, F.L. Castillo ^{id4}, L. Castillo Garcia ^{id13}, V. Castillo Gimenez ^{id167}, N.F. Castro ^{id133a,133e}, A. Catinaccio ^{id37}, J.R. Catmore ^{id128}, T. Cavaliere ^{id4}, V. Cavaliere ^{id30}, L.J. Caviedes Betancourt ^{id23b}, Y.C. Cekmecelioglu ^{id49}, E. Celebi ^{id83}, S. Cella ^{id37}, V. Cepaitis ^{id57}, K. Cerny ^{id125}, A.S. Cerqueira ^{id84a}, A. Cerri ^{id75a,75b}, L. Cerrito ^{id77a,77b}, F. Cerutti ^{id18a}, B. Cervato ^{id145}, A. Cervelli ^{id24b}, G. Cesarini ^{id54}, S.A. Cetin ^{id83}, P.M. Chabrilat ^{id130}, J. Chan ^{id18a}, W.Y. Chan ^{id157}, J.D. Chapman ^{id33}, E. Chapon ^{id138}, B. Chargeishvili ^{id153b}, D.G. Charlton ^{id21}, C. Chauhan ^{id136}, Y. Che ^{id114a}, S. Chekanov ^{id6}, S.V. Chekulaev ^{id159a}, G.A. Chelkov ^{id40,a}, B. Chen ^{id155}, B. Chen ^{id169}, H. Chen ^{id114a}, H. Chen ^{id30}, J. Chen ^{id63c}, J. Chen ^{id146}, M. Chen ^{id129}, S. Chen ^{id89}, S.J. Chen ^{id114a}, X. Chen ^{id63c}, X. Chen ^{id15,af}, Y. Chen ^{id63a}, C.L. Cheng ^{id174}, H.C. Cheng ^{id65a}, S. Cheong ^{id147}, A. Cheplakov ^{id40}, E. Cheremushkina ^{id49}, E. Cherepanova ^{id117}, R. Cherkaoui El Moursli ^{id36e}, E. Cheu ^{id7}, K. Cheung ^{id66}, L. Chevalier ^{id138}, V. Chiarella ^{id54}, G. Chiarelli ^{id75a}, N. Chiedde ^{id104}, G. Chiodini ^{id71a}, A.S. Chisholm ^{id21}, A. Chitan ^{id28b}, M. Chitishvili ^{id167}, M.V. Chizhov ^{id40,t}, K. Choi ^{id11}, Y. Chou ^{id142}, E.Y.S. Chow ^{id116}, K.L. Chu ^{id173}, M.C. Chu ^{id65a}, X. Chu ^{id14,114c}, Z. Chubinidze ^{id54}, J. Chudoba ^{id134}, J.J. Chwastowski ^{id88}, D. Cieri ^{id112}, K.M. Ciesla ^{id87a}, V. Cindro ^{id95}, A. Ciocio ^{id18a}, F. Ciotto ^{id73a,73b}, Z.H. Citron ^{id173},

M. Citterio [id72a](#), D.A. Ciubotaru [id28b](#), A. Clark [id57](#), P.J. Clark [id53](#), N. Clarke Hall [id98](#), C. Clarry [id158](#),
S.E. Clawson [id49](#), C. Clement [id48a,48b](#), Y. Coadou [id104](#), M. Cobal [id70a,70c](#), A. Coccaro [id58b](#),
R.F. Coelho Barrue [id133a](#), R. Coelho Lopes De Sa [id105](#), S. Coelli [id72a](#), L.S. Colangeli [id158](#), B. Cole [id43](#),
J. Collot [id61](#), P. Conde Muiño [id133a,133g](#), M.P. Connell [id34c](#), S.H. Connell [id34c](#), E.I. Conroy [id129](#),
F. Conventi [id73a,ah](#), H.G. Cooke [id21](#), A.M. Cooper-Sarkar [id129](#), F.A. Corchia [id24b,24a](#),
A. Cordeiro Oudot Choi [id130](#), L.D. Corpe [id42](#), M. Corradi [id76a,76b](#), F. Corriveau [id106,ab](#),
A. Cortes-Gonzalez [id19](#), M.J. Costa [id167](#), F. Costanza [id4](#), D. Costanzo [id143](#), B.M. Cote [id122](#),
J. Couthures [id4](#), G. Cowan [id97](#), K. Cranmer [id174](#), L. Cremer [id50](#), D. Cremonini [id24b,24a](#),
S. Crépe-Renaudin [id61](#), F. Crescioli [id130](#), M. Cristinziani [id145](#), M. Cristoforetti [id79a,79b](#), V. Croft [id117](#),
J.E. Crosby [id124](#), G. Crosetti [id45b,45a](#), A. Cueto [id101](#), H. Cui [id98](#), Z. Cui [id7](#), W.R. Cunningham [id60](#),
F. Curcio [id167](#), J.R. Curran [id53](#), P. Czodrowski [id37](#), M.J. Da Cunha Sargedas De Sousa [id58b,58a](#),
J.V. Da Fonseca Pinto [id84b](#), C. Da Via [id103](#), W. Dabrowski [id87a](#), T. Dado [id37](#), S. Dahbi [id152](#),
T. Dai [id108](#), D. Dal Santo [id20](#), C. Dallapiccola [id105](#), M. Dam [id44](#), G. D'amen [id30](#), V. D'Amico [id111](#),
J. Damp [id102](#), J.R. Dandoy [id35](#), D. Dannheim [id37](#), M. Danninger [id146](#), V. Dao [id149](#), G. Darbo [id58b](#),
S.J. Das [id30](#), F. Dattola [id49](#), S. D'Auria [id72a,72b](#), A. D'Avanzo [id73a,73b](#), T. Davidek [id136](#), I. Dawson [id96](#),
H.A. Day-hall [id135](#), K. De [id8](#), C. De Almeida Rossi [id158](#), R. De Asmundis [id73a](#), N. De Biase [id49](#),
S. De Castro [id24b,24a](#), N. De Groot [id116](#), P. de Jong [id117](#), H. De la Torre [id118](#), A. De Maria [id114a](#),
A. De Salvo [id76a](#), U. De Sanctis [id77a,77b](#), F. De Santis [id71a,71b](#), A. De Santo [id150](#),
J.B. De Vivie De Regie [id61](#), J. Debevc [id95](#), D.V. Dedovich [id40](#), J. Degens [id94](#), A.M. Deiana [id46](#),
J. Del Peso [id101](#), L. Delagrangé [id130](#), F. Deliot [id138](#), C.M. Delitzsch [id50](#), M. Della Pietra [id73a,73b](#),
D. Della Volpe [id57](#), A. Dell'Acqua [id37](#), L. Dell'Asta [id72a,72b](#), M. Delmastro [id4](#), C.C. Delogu [id102](#),
P.A. Delsart [id61](#), S. Demers [id176](#), M. Demichev [id40](#), S.P. Denisov [id39](#), H. Denizli [id22a,1](#),
L. D'Eramo [id42](#), D. Derendarz [id88](#), F. Derue [id130](#), P. Dervan [id94](#), K. Desch [id25](#), C. Deutsch [id25](#),
F.A. Di Bello [id58b,58a](#), A. Di Ciaccio [id77a,77b](#), L. Di Ciaccio [id4](#), A. Di Domenico [id76a,76b](#),
C. Di Donato [id73a,73b](#), A. Di Girolamo [id37](#), G. Di Gregorio [id37](#), A. Di Luca [id79a,79b](#),
B. Di Micco [id78a,78b](#), R. Di Nardo [id78a,78b](#), K.F. Di Petrillo [id41](#), M. Diamantopoulou [id35](#), F.A. Dias [id117](#),
T. Dias Do Vale [id146](#), M.A. Diaz [id140a,140b](#), A.R. Didenko [id40](#), M. Didenko [id167](#), E.B. Diehl [id108](#),
S. Díez Cornell [id49](#), C. Díez Pardos [id145](#), C. Dimitriadi [id148](#), A. Dimitrievska [id21](#), A. Dimri [id149](#),
J. Dingfelder [id25](#), T. Dingley [id129](#), I-M. Dinu [id28b](#), S.J. Dittmeier [id64b](#), F. Dittus [id37](#), M. Divisek [id136](#),
B. Dixit [id94](#), F. Djama [id104](#), T. Djobava [id153b](#), C. Doglioni [id103,100](#), A. Dohnalova [id29a](#), Z. Dolezal [id136](#),
K. Domijan [id87a](#), K.M. Dona [id41](#), M. Donadelli [id84d](#), B. Dong [id109](#), J. Donini [id42](#),
A. D'Onofrio [id73a,73b](#), M. D'Onofrio [id94](#), J. Dopke [id137](#), A. Doria [id73a](#), N. Dos Santos Fernandes [id133a](#),
P. Dougan [id103](#), M.T. Dova [id92](#), A.T. Doyle [id60](#), M.A. Dragnet [id129](#), M.P. Drescher [id56](#), E. Dreyer [id173](#),
I. Drivas-koulouris [id10](#), M. Drnevich [id120](#), M. Drozdova [id57](#), D. Du [id63a](#), T.A. du Pree [id117](#),
F. Dubinin [id39](#), M. Dubovsky [id29a](#), E. Duchovni [id173](#), G. Duckeck [id111](#), O.A. Ducu [id28b](#), D. Duda [id53](#),
A. Dudarev [id37](#), E.R. Duden [id27](#), M. D'uffizi [id103](#), L. Duflot [id67](#), M. Dührssen [id37](#), I. Duminica [id28g](#),
A.E. Dumitriu [id28b](#), M. Dunford [id64a](#), S. Dungs [id50](#), K. Dunne [id48a,48b](#), A. Duperrin [id104](#),
H. Duran Yildiz [id3a](#), M. Düren [id59](#), A. Durglishvili [id153b](#), D. Duvnjak [id35](#), B.L. Dwyer [id118](#),
G.I. Dyckes [id18a](#), M. Dyndal [id87a](#), B.S. Dziedzic [id37](#), Z.O. Earnshaw [id150](#), G.H. Eberwein [id129](#),
B. Eckerova [id29a](#), S. Eggebrecht [id56](#), E. Egidio Purcino De Souza [id84e](#), L.F. Ehrke [id57](#), G. Eigen [id17](#),
K. Einsweiler [id18a](#), T. Ekelof [id165](#), P.A. Ekman [id100](#), S. El Farkh [id36b](#), Y. El Ghazali [id63a](#),
H. El Jarrari [id37](#), A. El Moussaouy [id36a](#), V. Ellajosyula [id165](#), M. Ellert [id165](#), F. Ellinghaus [id175](#),
N. Ellis [id37](#), J. Elmsheuser [id30](#), M. Elsayy [id119a](#), M. Elsing [id37](#), D. Emeliyanov [id137](#), Y. Enari [id85](#),
I. Ene [id18a](#), S. Epari [id13](#), P.A. Erland [id88](#), D. Ernani Martins Neto [id88](#), M. Errenst [id175](#), M. Escalier [id67](#),
C. Escobar [id167](#), E. Etzion [id155](#), G. Evans [id133a,133b](#), H. Evans [id69](#), L.S. Evans [id97](#), A. Ezhilov [id39](#),
S. Ezzarqtouni [id36a](#), F. Fabbri [id24b,24a](#), L. Fabbri [id24b,24a](#), G. Facini [id98](#), V. Fadeyev [id139](#),
R.M. Fakhrtudinov [id39](#), D. Fakoudis [id102](#), S. Falciano [id76a](#), L.F. Falda Ulhoa Coelho [id133a](#),

F. Fallavollita ¹¹², G. Falsetti ^{45b,45a}, J. Faltova ¹³⁶, C. Fan ¹⁶⁶, K.Y. Fan ^{65b}, Y. Fan ¹⁴,
 Y. Fang ^{14,114c}, M. Fanti ^{72a,72b}, M. Faraj ^{70a,70b}, Z. Farazpay ⁹⁹, A. Farbin ⁸, A. Farilla ^{78a},
 T. Farooque ¹⁰⁹, J.N. Farr ¹⁷⁶, S.M. Farrington ^{137,53}, F. Fassi ^{36e}, D. Fassouliotis ⁹,
 M. Faucci Giannelli ^{77a,77b}, W.J. Fawcett ³³, L. Fayard ⁶⁷, P. Federic ¹³⁶, P. Federicova ¹³⁴,
 O.L. Fedin ^{39,a}, M. Feickert ¹⁷⁴, L. Feligioni ¹⁰⁴, D.E. Fellers ¹²⁶, C. Feng ^{63b}, Z. Feng ¹¹⁷,
 M.J. Fenton ¹⁶², L. Ferencz ⁴⁹, R.A.M. Ferguson ⁹³, P. Fernandez Martinez ⁶⁸,
 M.J.V. Fernoux ¹⁰⁴, J. Ferrando ⁹³, A. Ferrari ¹⁶⁵, P. Ferrari ^{117,116}, R. Ferrari ^{74a}, D. Ferrere ⁵⁷,
 C. Ferretti ¹⁰⁸, M.P. Fewell ¹, D. Fiacco ^{76a,76b}, F. Fiedler ¹⁰², P. Fiedler ¹³⁵, S. Filimonov ³⁹,
 A. Filipčić ⁹⁵, E.K. Filmer ^{159a}, F. Filthaut ¹¹⁶, M.C.N. Fiolhais ^{133a,133c,c}, L. Fiorini ¹⁶⁷,
 W.C. Fisher ¹⁰⁹, T. Fitschen ¹⁰³, P.M. Fitzhugh ¹³⁸, I. Fleck ¹⁴⁵, P. Fleischmann ¹⁰⁸, T. Flick ¹⁷⁵,
 M. Flores ^{34d,ad}, L.R. Flores Castillo ^{65a}, L. Flores Sanz De Acedo ³⁷, F.M. Follega ^{79a,79b},
 N. Fomin ³³, J.H. Foo ¹⁵⁸, A. Formica ¹³⁸, A.C. Forti ¹⁰³, E. Fortin ³⁷, A.W. Fortman ^{18a},
 L. Fountas ^{9j}, D. Fournier ⁶⁷, H. Fox ⁹³, P. Francavilla ^{75a,75b}, S. Francescato ⁶²,
 S. Franchellucci ⁵⁷, M. Franchini ^{24b,24a}, S. Franchino ^{64a}, D. Francis ³⁷, L. Franco ¹¹⁶,
 V. Franco Lima ³⁷, L. Franconi ⁴⁹, M. Franklin ⁶², G. Frattari ²⁷, Y.Y. Frid ¹⁵⁵, J. Friend ⁶⁰,
 N. Fritzsche ³⁷, A. Froch ⁵⁷, D. Froidevaux ³⁷, J.A. Frost ¹²⁹, Y. Fu ¹⁰⁹,
 S. Fuenzalida Garrido ^{140f}, M. Fujimoto ¹⁰⁴, K.Y. Fung ^{65a}, E. Furtado De Simas Filho ^{84e},
 M. Furukawa ¹⁵⁷, J. Fuster ¹⁶⁷, A. Gaa ⁵⁶, A. Gabrielli ^{24b,24a}, A. Gabrielli ¹⁵⁸, P. Gadow ³⁷,
 G. Gagliardi ^{58b,58a}, L.G. Gagnon ^{18a}, S. Gaid ¹⁶⁴, S. Galantzan ¹⁵⁵, J. Gallagher ¹,
 E.J. Gallas ¹²⁹, A.L. Gallen ¹⁶⁵, B.J. Gallop ¹³⁷, K.K. Gan ¹²², S. Ganguly ¹⁵⁷, Y. Gao ⁵³,
 A. Garabaglu ¹⁴², F.M. Garay Walls ^{140a,140b}, B. Garcia ³⁰, C. García ¹⁶⁷, A. Garcia Alonso ¹¹⁷,
 A.G. Garcia Caffaro ¹⁷⁶, J.E. García Navarro ¹⁶⁷, M. Garcia-Sciveres ^{18a}, G.L. Gardner ¹³¹,
 R.W. Gardner ⁴¹, N. Garelli ¹⁶¹, R.B. Garg ¹⁴⁷, J.M. Gargan ⁵³, C.A. Garner ¹⁵⁸, C.M. Garvey ^{34a},
 V.K. Gassmann ¹⁶¹, G. Gaudio ^{74a}, V. Gautam ¹³, P. Gauzzi ^{76a,76b}, J. Gavranovic ⁹⁵,
 I.L. Gavrilenko ³⁹, A. Gavrilyuk ³⁹, C. Gay ¹⁶⁸, G. Gaycken ¹²⁶, E.N. Gazis ¹⁰, A. Gekow ¹²²,
 C. Gemme ^{58b}, M.H. Genest ⁶¹, A.D. Gentry ¹¹⁵, S. George ⁹⁷, W.F. George ²¹, T. Geralis ⁴⁷,
 A.A. Gerwin ¹²³, P. Gessinger-Befurt ³⁷, M.E. Geyik ¹⁷⁵, M. Ghani ¹⁷¹, K. Ghorbanian ⁹⁶,
 A. Ghosal ¹⁴⁵, A. Ghosh ¹⁶², A. Ghosh ⁷, B. Giacobbe ^{24b}, S. Giagu ^{76a,76b}, T. Giani ¹¹⁷,
 A. Giannini ^{63a}, S.M. Gibson ⁹⁷, M. Gignac ¹³⁹, D.T. Gil ^{87b}, A.K. Gilbert ^{87a}, B.J. Gilbert ⁴³,
 D. Gillberg ³⁵, G. Gilles ¹¹⁷, L. Ginabat ¹³⁰, D.M. Gingrich ^{2,ag}, M.P. Giordani ^{70a,70c},
 P.F. Giraud ¹³⁸, G. Giugliarelli ^{70a,70c}, D. Giugni ^{72a}, F. Giuli ^{77a,77b}, I. Gkialas ^{9j},
 L.K. Gladilin ³⁹, C. Glasman ¹⁰¹, G. Glemža ⁴⁹, M. Glisic ¹²⁶, I. Gnesi ^{45b}, Y. Go ³⁰,
 M. Goblirsch-Kolb ³⁷, B. Gocke ⁵⁰, D. Godin ¹¹⁰, B. Gokturk ^{22a}, S. Goldfarb ¹⁰⁷, T. Golling ⁵⁷,
 M.G.D. Gololo ^{34c}, D. Golubkov ³⁹, J.P. Gombas ¹⁰⁹, A. Gomes ^{133a,133b}, G. Gomes Da Silva ¹⁴⁵,
 A.J. Gomez Delegido ¹⁶⁷, R. Gonçalo ^{133a}, L. Gonella ²¹, A. Gongadze ^{153c}, F. Gonnella ²¹,
 J.L. Gonski ¹⁴⁷, R.Y. González Andana ⁵³, S. González de la Hoz ¹⁶⁷, R. Gonzalez Lopez ⁹⁴,
 C. Gonzalez Renteria ^{18a}, M.V. Gonzalez Rodrigues ⁴⁹, R. Gonzalez Suarez ¹⁶⁵,
 S. Gonzalez-Sevilla ⁵⁷, L. Goossens ³⁷, B. Gorini ³⁷, E. Gorini ^{71a,71b}, A. Gorišek ⁹⁵,
 T.C. Gosart ¹³¹, A.T. Goshaw ⁵², M.I. Gostkin ⁴⁰, S. Goswami ¹²⁴, C.A. Gottardo ³⁷,
 S.A. Gotz ¹¹¹, M. Gouighri ^{36b}, A.G. Goussiou ¹⁴², N. Govender ^{34c}, R.P. Grabarczyk ¹²⁹,
 I. Grabowska-Bold ^{87a}, K. Graham ³⁵, E. Gramstad ¹²⁸, S. Grancagnolo ^{71a,71b}, C.M. Grant ^{1,138},
 P.M. Gravila ^{28f}, F.G. Gravili ^{71a,71b}, H.M. Gray ^{18a}, M. Greco ¹¹², M.J. Green ¹, C. Grefe ²⁵,
 A.S. Grefsrud ¹⁷, I.M. Gregor ⁴⁹, K.T. Greif ¹⁶², P. Grenier ¹⁴⁷, S.G. Grewe ¹¹², A.A. Grillo ¹³⁹,
 K. Grimm ³², S. Grinstein ^{13,x}, J.-F. Grivaz ⁶⁷, E. Gross ¹⁷³, J. Grosse-Knetter ⁵⁶, L. Guan ¹⁰⁸,
 J.G.R. Guerrero Rojas ¹⁶⁷, G. Guerrieri ³⁷, R. Gugel ¹⁰², J.A.M. Guhit ¹⁰⁸, A. Guida ¹⁹,
 E. Guilloton ¹⁷¹, S. Guindon ³⁷, F. Guo ^{14,114c}, J. Guo ^{63c}, L. Guo ⁴⁹, L. Guo ^{114b,v},
 Y. Guo ¹⁰⁸, A. Gupta ⁵⁰, R. Gupta ¹³², S. Gurbuz ²⁵, S.S. Gurdasani ⁴⁹, G. Gustavino ^{76a,76b},

P. Gutierrez ^{id123}, L.F. Gutierrez Zagazeta ^{id131}, M. Gutsche ^{id51}, C. Gutschow ^{id98}, C. Gwenlan ^{id129},
 C.B. Gwilliam ^{id94}, E.S. Haaland ^{id128}, A. Haas ^{id120}, M. Habedank ^{id60}, C. Haber ^{id18a},
 H.K. Hadavand ^{id8}, A. Hadeef ^{id51}, A.I. Hagan ^{id93}, J.J. Hahn ^{id145}, E.H. Haines ^{id98}, M. Haleem ^{id170},
 J. Haley ^{id124}, G.D. Hallowell ^{id104}, L. Halser ^{id20}, K. Hamano ^{id169}, M. Hamer ^{id25}, E.J. Hampshire ^{id97},
 J. Han ^{id63b}, L. Han ^{id114a}, L. Han ^{id63a}, S. Han ^{id18a}, K. Hanagaki ^{id85}, M. Hance ^{id139}, D.A. Hangal ^{id43},
 H. Hanif ^{id146}, M.D. Hank ^{id131}, J.B. Hansen ^{id44}, P.H. Hansen ^{id44}, D. Harada ^{id57}, T. Harenberg ^{id175},
 S. Harkusha ^{id177}, M.L. Harris ^{id105}, Y.T. Harris ^{id25}, J. Harrison ^{id13}, N.M. Harrison ^{id122},
 P.F. Harrison ^{id171}, N.M. Hartman ^{id112}, N.M. Hartmann ^{id111}, R.Z. Hasan ^{id97,137}, Y. Hasegawa ^{id144},
 F. Haslbeck ^{id129}, S. Hassan ^{id17}, R. Hauser ^{id109}, C.M. Hawkes ^{id21}, R.J. Hawkings ^{id37},
 Y. Hayashi ^{id157}, D. Hayden ^{id109}, C. Hayes ^{id108}, R.L. Hayes ^{id117}, C.P. Hays ^{id129}, J.M. Hays ^{id96},
 H.S. Hayward ^{id94}, F. He ^{id63a}, M. He ^{id14,114c}, Y. He ^{id49}, Y. He ^{id98}, N.B. Heatley ^{id96}, V. Hedberg ^{id100},
 A.L. Heggelund ^{id128}, C. Heidegger ^{id55}, K.K. Heidegger ^{id55}, J. Heilman ^{id35}, S. Heim ^{id49},
 T. Heim ^{id18a}, J.G. Heinlein ^{id131}, J.J. Heinrich ^{id126}, L. Heinrich ^{id112,ae}, J. Hejbal ^{id134}, A. Held ^{id174},
 S. Hellesund ^{id17}, C.M. Helling ^{id168}, S. Hellman ^{id48a,48b}, R.C.W. Henderson ^{id93}, L. Henkelmann ^{id33},
 A.M. Henriques Correia ^{id37}, H. Herde ^{id100}, Y. Hernández Jiménez ^{id149}, L.M. Herrmann ^{id25},
 T. Herrmann ^{id51}, G. Herten ^{id55}, R. Hertenberger ^{id111}, L. Hervas ^{id37}, M.E. Hespings ^{id102},
 N.P. Hessey ^{id159a}, J. Hessler ^{id112}, M. Hidaoui ^{id36b}, N. Hidic ^{id136}, E. Hill ^{id158}, S.J. Hillier ^{id21},
 J.R. Hinds ^{id109}, F. Hinterkeuser ^{id25}, M. Hirose ^{id127}, S. Hirose ^{id160}, D. Hirschbuehl ^{id175},
 T.G. Hitchings ^{id103}, B. Hiti ^{id95}, J. Hobbs ^{id149}, R. Hobincu ^{id28e}, N. Hod ^{id173}, M.C. Hodgkinson ^{id143},
 B.H. Hodgkinson ^{id129}, A. Hoecker ^{id37}, D.D. Hofer ^{id108}, J. Hofer ^{id167}, M. Holzbock ^{id37},
 L.B.A.H. Hommels ^{id33}, B.P. Honan ^{id103}, J.J. Hong ^{id69}, J. Hong ^{id63c}, T.M. Hong ^{id132},
 B.H. Hooberman ^{id166}, W.H. Hopkins ^{id6}, M.C. Hoppesch ^{id166}, Y. Horii ^{id113}, M.E. Horstmann ^{id112},
 S. Hou ^{id152}, M.R. Housenga ^{id166}, A.S. Howard ^{id95}, J. Howarth ^{id60}, J. Hoya ^{id6}, M. Hrabovsky ^{id125},
 T. Hryn'ova ^{id4}, P.J. Hsu ^{id66}, S.-C. Hsu ^{id142}, T. Hsu ^{id67}, M. Hu ^{id18a}, Q. Hu ^{id63a}, S. Huang ^{id33},
 X. Huang ^{id14,114c}, Y. Huang ^{id136}, Y. Huang ^{id114b}, Y. Huang ^{id102}, Y. Huang ^{id14}, Z. Huang ^{id103},
 Z. Hubacek ^{id135}, M. Huebner ^{id25}, F. Huegging ^{id25}, T.B. Huffman ^{id129},
 M. Hufnagel Maranha De Faria ^{id84a}, C.A. Hugli ^{id49}, M. Huhtinen ^{id37}, S.K. Huiberts ^{id17},
 R. Hulsken ^{id106}, C.E. Hultquist ^{id18a}, N. Huseynov ^{id12,g}, J. Huston ^{id109}, J. Huth ^{id62}, R. Hyneman ^{id7},
 G. Iacobucci ^{id57}, G. Iakovidis ^{id30}, L. Iconomidou-Fayard ^{id67}, J.P. Iddon ^{id37}, P. Iengo ^{id73a,73b},
 R. Iguchi ^{id157}, Y. Iiyama ^{id157}, T. Iizawa ^{id129}, Y. Ikegami ^{id85}, D. Iliadis ^{id156}, N. Ilic ^{id158},
 H. Imam ^{id84c}, G. Inacio Goncalves ^{id84d}, S.A. Infante Cabanas ^{id140c}, T. Ingebretsen Carlson ^{id48a,48b},
 J.M. Inglis ^{id96}, G. Introzzi ^{id74a,74b}, M. Iodice ^{id78a}, V. Ippolito ^{id76a,76b}, R.K. Irwin ^{id94}, M. Ishino ^{id157},
 W. Islam ^{id174}, C. Issever ^{id19}, S. Istin ^{id22a,al}, H. Ito ^{id172}, R. Iuppa ^{id79a,79b}, A. Ivina ^{id173}, V. Izzo ^{id73a},
 P. Jacka ^{id134}, P. Jackson ^{id1}, C.S. Jagfeld ^{id111}, G. Jain ^{id159a}, P. Jain ^{id49}, K. Jakobs ^{id55},
 T. Jakoubek ^{id173}, J. Jamieson ^{id60}, W. Jang ^{id157}, M. Javurkova ^{id105}, P. Jawahar ^{id103}, L. Jeanty ^{id126},
 J. Jejelava ^{id153a}, P. Jenni ^{id55,f}, C.E. Jessiman ^{id35}, C. Jia ^{id63b}, H. Jia ^{id168}, J. Jia ^{id149}, X. Jia ^{id14,114c},
 Z. Jia ^{id114a}, C. Jiang ^{id53}, Q. Jiang ^{id65b}, S. Jiggins ^{id49}, J. Jimenez Pena ^{id13}, S. Jin ^{id114a},
 A. Jinaru ^{id28b}, O. Jinnouchi ^{id141}, P. Johansson ^{id143}, K.A. Johns ^{id7}, J.W. Johnson ^{id139}, F.A. Jolly ^{id49},
 D.M. Jones ^{id150}, E. Jones ^{id49}, K.S. Jones ^{id8}, P. Jones ^{id33}, R.W.L. Jones ^{id93}, T.J. Jones ^{id94},
 H.L. Joos ^{id56,37}, R. Joshi ^{id122}, J. Jovicevic ^{id16}, X. Ju ^{id18a}, J.J. Junggeburth ^{id37}, T. Junkermann ^{id64a},
 A. Juste Rozas ^{id13,x}, M.K. Juzek ^{id88}, S. Kabana ^{id140e}, A. Kaczmarek ^{id88}, M. Kado ^{id112},
 H. Kagan ^{id122}, M. Kagan ^{id147}, A. Kahn ^{id131}, C. Kahra ^{id102}, T. Kaji ^{id157}, E. Kajomovitz ^{id154},
 N. Kakati ^{id173}, I. Kalaitzidou ^{id55}, N.J. Kang ^{id139}, D. Kar ^{id34g}, K. Karava ^{id129}, E. Karentzos ^{id25},
 O. Karkout ^{id117}, S.N. Karpov ^{id40}, Z.M. Karpova ^{id40}, V. Kartvelishvili ^{id93}, A.N. Karyukhin ^{id39},
 E. Kasimi ^{id156}, J. Katzy ^{id49}, S. Kaur ^{id35}, K. Kawade ^{id144}, M.P. Kawale ^{id123}, C. Kawamoto ^{id89},
 T. Kawamoto ^{id63a}, E.F. Kay ^{id37}, F.I. Kaya ^{id161}, S. Kazakos ^{id109}, V.F. Kazanin ^{id39}, Y. Ke ^{id149},
 J.M. Keaveney ^{id34a}, R. Keeler ^{id169}, G.V. Kehris ^{id62}, J.S. Keller ^{id35}, J.J. Kempster ^{id150}, O. Kepka ^{id134},

J. Kerr ^{159b}, B.P. Kerridge ¹³⁷, B.P. Kerševan ⁹⁵, L. Keszeghova ^{29a}, R.A. Khan ¹³²,
 A. Khanov ¹²⁴, A.G. Kharlamov ³⁹, T. Kharlamova ³⁹, E.E. Khoda ¹⁴², M. Kholodenko ^{133a},
 T.J. Khoo ¹⁹, G. Khoriali ¹⁷⁰, J. Khubua ^{153b,*}, Y.A.R. Khwaira ¹³⁰, B. Kibirige ^{34g}, D. Kim ⁶,
 D.W. Kim ^{48a,48b}, Y.K. Kim ⁴¹, N. Kimura ⁹⁸, M.K. Kingston ⁵⁶, A. Kirchoff ⁵⁶, C. Kirfel ²⁵,
 F. Kirfel ²⁵, J. Kirk ¹³⁷, A.E. Kiryunin ¹¹², S. Kita ¹⁶⁰, C. Kitsaki ¹⁰, O. Kivernyk ²⁵,
 M. Klassen ¹⁶¹, C. Klein ³⁵, L. Klein ¹⁷⁰, M.H. Klein ⁴⁶, S.B. Klein ⁵⁷, U. Klein ⁹⁴,
 A. Klimentov ³⁰, T. Klioutchnikova ³⁷, P. Kluit ¹¹⁷, S. Kluth ¹¹², E. Kneringer ⁸⁰,
 T.M. Knight ¹⁵⁸, A. Knue ⁵⁰, D. Kobylanski ¹⁷³, S.F. Koch ¹²⁹, M. Kocian ¹⁴⁷, P. Kodyš ¹³⁶,
 D.M. Koeck ¹²⁶, P.T. Koenig ²⁵, T. Koffas ³⁵, O. Kolay ⁵¹, I. Koletsou ⁴, T. Komarek ⁸⁸,
 K. Köneke ⁵⁶, A.X.Y. Kong ¹, T. Kono ¹²¹, N. Konstantinidis ⁹⁸, P. Kontaxakis ⁵⁷,
 B. Konya ¹⁰⁰, R. Kopeliansky ⁴³, S. Koperny ^{87a}, K. Korcyl ⁸⁸, K. Kordas ^{156,e}, A. Korn ⁹⁸,
 S. Korn ⁵⁶, I. Korolkov ¹³, N. Korotkova ³⁹, B. Kortman ¹¹⁷, O. Kortner ¹¹², S. Kortner ¹¹²,
 W.H. Kostecka ¹¹⁸, V.V. Kostyukhin ¹⁴⁵, A. Kotsokechagia ³⁷, A. Kotwal ⁵², A. Koulouris ³⁷,
 A. Kourkoumeli-Charalampidi ^{74a,74b}, C. Kourkoumelis ⁹, E. Kourlitis ^{112,ae}, O. Kovanda ¹²⁶,
 R. Kowalewski ¹⁶⁹, W. Kozanecki ¹²⁶, A.S. Kozhin ³⁹, V.A. Kramarenko ³⁹, G. Kramberger ⁹⁵,
 P. Kramer ²⁵, M.W. Krasny ¹³⁰, A. Krasznahorkay ¹⁰⁵, A.C. Kraus ¹¹⁸, J.W. Kraus ¹⁷⁵,
 J.A. Kremer ⁴⁹, T. Kresse ⁵¹, L. Kretschmann ¹⁷⁵, J. Kretzschmar ⁹⁴, K. Kreul ¹⁹,
 P. Krieger ¹⁵⁸, K. Krizka ²¹, K. Kroeninger ⁵⁰, H. Kroha ¹¹², J. Kroll ¹³⁴, J. Kroll ¹³¹,
 K.S. Krowpman ¹⁰⁹, U. Kruchonak ⁴⁰, H. Krüger ²⁵, N. Krumnack ⁸², M.C. Kruse ⁵²,
 O. Kuchinskaia ³⁹, S. Kuday ^{3a}, S. Kuehn ³⁷, R. Kuesters ⁵⁵, T. Kuhl ⁴⁹, V. Kukhtin ⁴⁰,
 Y. Kulchitsky ⁴⁰, S. Kuleshov ^{140d,140b}, M. Kumar ^{34g}, N. Kumari ⁴⁹, P. Kumari ^{159b},
 A. Kupco ¹³⁴, T. Kupfer ⁵⁰, A. Kupich ³⁹, O. Kuprash ⁵⁵, H. Kurashige ⁸⁶, L.L. Kurchaninov ^{159a},
 O. Kurdysh ⁶⁷, Y.A. Kurochkin ³⁸, A. Kurova ³⁹, M. Kuze ¹⁴¹, A.K. Kvam ¹⁰⁵, J. Kvita ¹²⁵,
 N.G. Kyriacou ¹⁰⁸, L.A.O. Laatu ¹⁰⁴, C. Lacasta ¹⁶⁷, F. Lacava ^{76a,76b}, H. Lacker ¹⁹,
 D. Lacour ¹³⁰, N.N. Lad ⁹⁸, E. Ladygin ⁴⁰, A. Lafarge ⁴², B. Laforge ¹³⁰, T. Lagouri ¹⁷⁶,
 F.Z. Lahbabi ^{36a}, S. Lai ⁵⁶, J.E. Lambert ¹⁶⁹, S. Lammers ⁶⁹, W. Lampl ⁷, C. Lampoudis ^{156,e},
 G. Lamprinoudis ¹⁰², A.N. Lancaster ¹¹⁸, E. Lançon ³⁰, U. Landgraf ⁵⁵, M.P.J. Landon ⁹⁶,
 V.S. Lang ⁵⁵, O.K.B. Langrekken ¹²⁸, A.J. Lankford ¹⁶², F. Lanni ³⁷, K. Lantzsck ²⁵,
 A. Lanza ^{74a}, M. Lanzac Berrocal ¹⁶⁷, J.F. Laporte ¹³⁸, T. Lari ^{72a}, F. Lasagni Manghi ^{24b},
 M. Lassnig ³⁷, V. Latonova ¹³⁴, S.D. Lawlor ¹⁴³, Z. Lawrence ¹⁰³, R. Lazaridou ¹⁷¹,
 M. Lazzaroni ^{72a,72b}, H.D.M. Le ¹⁰⁹, E.M. Le Boulicaut ¹⁷⁶, L.T. Le Pottier ^{18a}, B. Leban ^{24b,24a},
 M. LeBlanc ¹⁰³, F. Ledroit-Guillon ⁶¹, S.C. Lee ¹⁵², T.F. Lee ⁹⁴, L.L. Leeuw ^{34c,aj},
 M. Lefebvre ¹⁶⁹, C. Leggett ^{18a}, G. Lehmann Miotto ³⁷, M. Leigh ⁵⁷, W.A. Leight ¹⁰⁵,
 W. Leinonen ¹¹⁶, A. Leisos ^{156,u}, M.A.L. Leite ^{84c}, C.E. Leitgeb ¹⁹, R. Leitner ¹³⁶,
 K.J.C. Leney ⁴⁶, T. Lenz ²⁵, S. Leone ^{75a}, C. Leonidopoulos ⁵³, A. Leopold ¹⁴⁸,
 J.H. Lepage Bourbonnais ³⁵, R. Les ¹⁰⁹, C.G. Lester ³³, M. Levchenko ³⁹, J. Levêque ⁴,
 L.J. Levinson ¹⁷³, G. Levrini ^{24b,24a}, M.P. Lewicki ⁸⁸, C. Lewis ¹⁴², D.J. Lewis ⁴, L. Lewitt ¹⁴³,
 A. Li ³⁰, B. Li ^{63b}, C. Li ¹⁰⁸, C-Q. Li ¹¹², H. Li ^{63a}, H. Li ^{63b}, H. Li ^{114a}, H. Li ¹⁵, H. Li ^{63b},
 J. Li ^{63c}, K. Li ¹⁴, L. Li ^{63c}, R. Li ¹⁷⁶, S. Li ^{14,114c}, S. Li ^{63d,63c,d}, T. Li ⁵, X. Li ¹⁰⁶,
 Z. Li ¹⁵⁷, Z. Li ^{14,114c}, Z. Li ^{63a}, S. Liang ^{14,114c}, Z. Liang ¹⁴, M. Liberatore ¹³⁸, B. Liberti ^{77a},
 K. Lie ^{65c}, J. Lieber Marin ^{84e}, H. Lien ⁶⁹, H. Lin ¹⁰⁸, L. Linden ¹¹¹, R.E. Lindley ⁷,
 J.H. Lindon ², J. Ling ⁶², E. Lipeles ¹³¹, A. Lipniacka ¹⁷, A. Lister ¹⁶⁸, J.D. Little ⁶⁹,
 B. Liu ¹⁴, B.X. Liu ^{114b}, D. Liu ^{63d,63c}, E.H.L. Liu ²¹, J.K.K. Liu ³³, K. Liu ^{63d}, K. Liu ^{63d,63c},
 M. Liu ^{63a}, M.Y. Liu ^{63a}, P. Liu ¹⁴, Q. Liu ^{63d,142,63c}, X. Liu ^{63a}, X. Liu ^{63b}, Y. Liu ^{114b,114c},
 Y.L. Liu ^{63b}, Y.W. Liu ^{63a}, S.L. Lloyd ⁹⁶, E.M. Lobodzinska ⁴⁹, P. Loch ⁷, E. Lodhi ¹⁵⁸,
 T. Lohse ¹⁹, K. Lohwasser ¹⁴³, E. Loiacono ⁴⁹, J.D. Lomas ²¹, J.D. Long ⁴³, I. Longarini ¹⁶²,
 R. Longo ¹⁶⁶, A. Lopez Solis ⁴⁹, N.A. Lopez-canelas ⁷, N. Lorenzo Martinez ⁴, A.M. Lory ¹¹¹,































































































































M. Losada [id](#)^{119a}, G. Löschcke Centeno [id](#)¹⁵⁰, O. Loseva [id](#)³⁹, X. Lou [id](#)^{48a,48b}, X. Lou [id](#)^{14,114c},
A. Lounis [id](#)⁶⁷, P.A. Love [id](#)⁹³, G. Lu [id](#)^{14,114c}, M. Lu [id](#)⁶⁷, S. Lu [id](#)¹³¹, Y.J. Lu [id](#)¹⁵², H.J. Lubatti [id](#)¹⁴²,
C. Luci [id](#)^{76a,76b}, F.L. Lucio Alves [id](#)^{114a}, F. Luehring [id](#)⁶⁹, O. Lukianchuk [id](#)⁶⁷, B.S. Lunday [id](#)¹³¹,
O. Lundberg [id](#)¹⁴⁸, B. Lund-Jensen [id](#)^{148,*}, N.A. Luongo [id](#)⁶, M.S. Lutz [id](#)³⁷, A.B. Lux [id](#)²⁶, D. Lynn [id](#)³⁰,
R. Lysak [id](#)¹³⁴, E. Lytken [id](#)¹⁰⁰, V. Lyubushkin [id](#)⁴⁰, T. Lyubushkina [id](#)⁴⁰, M.M. Lyukova [id](#)¹⁴⁹,
M.Firdaus M. Soberi [id](#)⁵³, H. Ma [id](#)³⁰, K. Ma [id](#)^{63a}, L.L. Ma [id](#)^{63b}, W. Ma [id](#)^{63a}, Y. Ma [id](#)¹²⁴,
J.C. MacDonald [id](#)¹⁰², P.C. Machado De Abreu Farias [id](#)^{84e}, R. Madar [id](#)⁴², T. Madula [id](#)⁹⁸, J. Maeda [id](#)⁸⁶,
T. Maeno [id](#)³⁰, P.T. Mafa [id](#)^{34c,k}, H. Maguire [id](#)¹⁴³, V. Maiboroda [id](#)¹³⁸, A. Maio [id](#)^{133a,133b,133d},
K. Maj [id](#)^{87a}, O. Majersky [id](#)⁴⁹, S. Majewski [id](#)¹²⁶, R. Makhmanazarov [id](#)³⁹, N. Makovec [id](#)⁶⁷,
V. Maksimovic [id](#)¹⁶, B. Malaescu [id](#)¹³⁰, Pa. Malecki [id](#)⁸⁸, V.P. Maleev [id](#)³⁹, F. Malek [id](#)^{61,p}, M. Mali [id](#)⁹⁵,
D. Malito [id](#)⁹⁷, U. Mallik [id](#)^{81,*}, S. Maltezos¹⁰, S. Malyukov⁴⁰, J. Mamuzic [id](#)¹³, G. Mancini [id](#)⁵⁴,
M.N. Mancini [id](#)²⁷, G. Manco [id](#)^{74a,74b}, J.P. Mandalia [id](#)⁹⁶, S.S. Mandarry [id](#)¹⁵⁰, I. Mandić [id](#)⁹⁵,
L. Manhaes de Andrade Filho [id](#)^{84a}, I.M. Maniatis [id](#)¹⁷³, J. Manjarres Ramos [id](#)⁹¹, D.C. Mankad [id](#)¹⁷³,
A. Mann [id](#)¹¹¹, S. Manzoni [id](#)³⁷, L. Mao [id](#)^{63c}, X. Mapekula [id](#)^{34c}, A. Marantis [id](#)^{156,u}, G. Marchiori [id](#)⁵,
M. Marcisovsky [id](#)¹³⁴, C. Marcon [id](#)^{72a}, M. Marinescu [id](#)²¹, S. Marium [id](#)⁴⁹, M. Marjanovic [id](#)¹²³,
A. Markhoos [id](#)⁵⁵, M. Markovitch [id](#)⁶⁷, M.K. Maroun [id](#)¹⁰⁵, E.J. Marshall [id](#)⁹³, Z. Marshall [id](#)^{18a},
S. Marti-Garcia [id](#)¹⁶⁷, J. Martin [id](#)⁹⁸, T.A. Martin [id](#)¹³⁷, V.J. Martin [id](#)⁵³, B. Martin dit Latour [id](#)¹⁷,
L. Martinelli [id](#)^{76a,76b}, M. Martinez [id](#)^{13,x}, P. Martinez Agullo [id](#)¹⁶⁷, V.I. Martinez Outschoorn [id](#)¹⁰⁵,
P. Martinez Suarez [id](#)¹³, S. Martin-Haugh [id](#)¹³⁷, G. Martinovicova [id](#)¹³⁶, V.S. Martoiu [id](#)^{28b},
A.C. Martyniuk [id](#)⁹⁸, A. Marzin [id](#)³⁷, D. Mascione [id](#)^{79a,79b}, L. Masetti [id](#)¹⁰², J. Masik [id](#)¹⁰³,
A.L. Maslennikov [id](#)³⁹, S.L. Mason [id](#)⁴³, P. Massarotti [id](#)^{73a,73b}, P. Mastrandrea [id](#)^{75a,75b},
A. Mastroberardino [id](#)^{45b,45a}, T. Masubuchi [id](#)¹²⁷, T.T. Mathew [id](#)¹²⁶, J. Matousek [id](#)¹³⁶, D.M. Mattern [id](#)⁵⁰,
J. Maurer [id](#)^{28b}, T. Maurin [id](#)⁶⁰, A.J. Maury [id](#)⁶⁷, B. Maček [id](#)⁹⁵, D.A. Maximov [id](#)³⁹, A.E. May [id](#)¹⁰³,
R. Mazini [id](#)^{34g}, I. Maznas [id](#)¹¹⁸, M. Mazza [id](#)¹⁰⁹, S.M. Mazza [id](#)¹³⁹, E. Mazzeo [id](#)^{72a,72b},
J.P. Mc Gowan [id](#)¹⁶⁹, S.P. Mc Kee [id](#)¹⁰⁸, C.A. Mc Lean [id](#)⁶, C.C. McCracken [id](#)¹⁶⁸, E.F. McDonald [id](#)¹⁰⁷,
A.E. McDougall [id](#)¹¹⁷, L.F. Mcelhinney [id](#)⁹³, J.A. Mcfayden [id](#)¹⁵⁰, R.P. McGovern [id](#)¹³¹,
R.P. Mckenzie [id](#)^{34g}, T.C. Mclachlan [id](#)⁴⁹, D.J. Mclaughlin [id](#)⁹⁸, S.J. McMahon [id](#)¹³⁷,
C.M. Mcpartland [id](#)⁹⁴, R.A. McPherson [id](#)^{169,ab}, S. Mehlhase [id](#)¹¹¹, A. Mehta [id](#)⁹⁴, D. Melini [id](#)¹⁶⁷,
B.R. Mellado Garcia [id](#)^{34g}, A.H. Melo [id](#)⁵⁶, F. Meloni [id](#)⁴⁹, A.M. Mendes Jacques Da Costa [id](#)¹⁰³,
H.Y. Meng [id](#)¹⁵⁸, L. Meng [id](#)⁹³, S. Menke [id](#)¹¹², M. Mentink [id](#)³⁷, E. Meoni [id](#)^{45b,45a}, G. Mercado [id](#)¹¹⁸,
S. Merianos [id](#)¹⁵⁶, C. Merlassino [id](#)^{70a,70c}, C. Meroni [id](#)^{72a,72b}, J. Metcalfe [id](#)⁶, A.S. Mete [id](#)⁶,
E. Meuser [id](#)¹⁰², C. Meyer [id](#)⁶⁹, J-P. Meyer [id](#)¹³⁸, R.P. Middleton [id](#)¹³⁷, L. Mijović [id](#)⁵³,
G. Mikenberg [id](#)¹⁷³, M. Mikestikova [id](#)¹³⁴, M. Mikuž [id](#)⁹⁵, H. Mildner [id](#)¹⁰², A. Milic [id](#)³⁷,
D.W. Miller [id](#)⁴¹, E.H. Miller [id](#)¹⁴⁷, L.S. Miller [id](#)³⁵, A. Milov [id](#)¹⁷³, D.A. Milstead^{48a,48b}, T. Min^{114a},
A.A. Minaenko [id](#)³⁹, I.A. Minashvili [id](#)^{153b}, A.I. Mincer [id](#)¹²⁰, B. Mindur [id](#)^{87a}, M. Mineev [id](#)⁴⁰,
Y. Mino [id](#)⁸⁹, L.M. Mir [id](#)¹³, M. Miralles Lopez [id](#)⁶⁰, M. Mironova [id](#)^{18a}, M.C. Missio [id](#)¹¹⁶, A. Mitra [id](#)¹⁷¹,
V.A. Mitsou [id](#)¹⁶⁷, Y. Mitsumori [id](#)¹¹³, O. Miu [id](#)¹⁵⁸, P.S. Miyagawa [id](#)⁹⁶, T. Mkrtychyan [id](#)^{64a},
M. Mlinarevic [id](#)⁹⁸, T. Mlinarevic [id](#)⁹⁸, M. Mlynarikova [id](#)³⁷, S. Mobius [id](#)²⁰, P. Mogg [id](#)¹¹¹,
M.H. Mohamed Farook [id](#)¹¹⁵, A.F. Mohammed [id](#)^{14,114c}, S. Mohapatra [id](#)⁴³, G. Mokgatitwane [id](#)^{34g},
L. Moleri [id](#)¹⁷³, B. Mondal [id](#)¹⁴⁵, S. Mondal [id](#)¹³⁵, K. Mönig [id](#)⁴⁹, E. Monnier [id](#)¹⁰⁴,
L. Monsonis Romero¹⁶⁷, J. Montejo Berlingen [id](#)¹³, A. Montella [id](#)^{48a,48b}, M. Montella [id](#)¹²²,
F. Montekali [id](#)^{78a,78b}, F. Monticelli [id](#)⁹², S. Monzani [id](#)^{70a,70c}, A. Morancho Tarda [id](#)⁴⁴, N. Morange [id](#)⁶⁷,
A.L. Moreira De Carvalho [id](#)⁴⁹, M. Moreno Llácer [id](#)¹⁶⁷, C. Moreno Martinez [id](#)⁵⁷, J.M. Moreno Perez^{23b},
P. Morettini [id](#)^{58b}, S. Morgenstern [id](#)³⁷, M. Morii [id](#)⁶², M. Morinaga [id](#)¹⁵⁷, M. Moritsu [id](#)⁹⁰,
F. Morodei [id](#)^{76a,76b}, P. Moschovakos [id](#)³⁷, B. Moser [id](#)¹²⁹, M. Mosidze [id](#)^{153b}, T. Moskalets [id](#)⁴⁶,
P. Moskvitina [id](#)¹¹⁶, J. Moss [id](#)^{32,m}, P. Moszkowicz [id](#)^{87a}, A. Moussa [id](#)^{36d}, Y. Moyal [id](#)¹⁷³,
E.J.W. Moysse [id](#)¹⁰⁵, O. Mtintsilana [id](#)^{34g}, S. Muanza [id](#)¹⁰⁴, J. Mueller [id](#)¹³², D. Muenstermann [id](#)⁹³,

R. Müller ³⁷, G.A. Mullier ¹⁶⁵, A.J. Mullin³³, J.J. Mullin¹³¹, A.E. Mulski ⁶², D.P. Mungo ¹⁵⁸, D. Munoz Perez ¹⁶⁷, F.J. Munoz Sanchez ¹⁰³, M. Murin ¹⁰³, W.J. Murray ^{171,137}, M. Muškinja ⁹⁵, C. Mwewa ³⁰, A.G. Myagkov ^{39,a}, A.J. Myers ⁸, G. Myers ¹⁰⁸, M. Myska ¹³⁵, B.P. Nachman ^{18a}, K. Nagai ¹²⁹, K. Nagano ⁸⁵, R. Nagasaka¹⁵⁷, J.L. Nagle ^{30,ai}, E. Nagy ¹⁰⁴, A.M. Nairz ³⁷, Y. Nakahama ⁸⁵, K. Nakamura ⁸⁵, K. Nakkalil ⁵, H. Nanjo ¹²⁷, E.A. Narayanan ⁴⁶, Y. Narukawa ¹⁵⁷, I. Naryshkin ³⁹, L. Nasella ^{72a,72b}, S. Nasri ^{119b}, C. Nass ²⁵, G. Navarro ^{23a}, J. Navarro-Gonzalez ¹⁶⁷, A. Nayaz ¹⁹, P.Y. Nechaeva ³⁹, S. Nechaeva ^{24b,24a}, F. Nechansky ¹³⁴, L. Nedic ¹²⁹, T.J. Neep ²¹, A. Negri ^{74a,74b}, M. Negrini ^{24b}, C. Nellist ¹¹⁷, C. Nelson ¹⁰⁶, K. Nelson ¹⁰⁸, S. Nemecek ¹³⁴, M. Nessi ^{37,h}, M.S. Neubauer ¹⁶⁶, F. Neuhaus ¹⁰², J. Newell ⁹⁴, P.R. Newman ²¹, Y.W.Y. Ng ¹⁶⁶, B. Ngair ^{119a}, H.D.N. Nguyen ¹¹⁰, R.B. Nickerson ¹²⁹, R. Nicolaidou ¹³⁸, J. Nielsen ¹³⁹, M. Niemeyer ⁵⁶, J. Niermann ³⁷, N. Nikiforou ³⁷, V. Nikolaenko ^{39,a}, I. Nikolic-Audit ¹³⁰, P. Nilsson ³⁰, I. Ninca ⁴⁹, G. Ninio ¹⁵⁵, A. Nisati ^{76a}, N. Nishu ², R. Nisius ¹¹², N. Nitika ^{70a,70c}, J-E. Nitschke ⁵¹, E.K. Nkadimeng ^{34g}, T. Nobe ¹⁵⁷, T. Nommensen ¹⁵¹, M.B. Norfolk ¹⁴³, B.J. Norman ³⁵, M. Noury ^{36a}, J. Novak ⁹⁵, T. Novak ⁹⁵, R. Novotny ¹¹⁵, L. Nozka ¹²⁵, K. Ntekas ¹⁶², N.M.J. Nunes De Moura Junior ^{84b}, J. Ocariz ¹³⁰, A. Ochi ⁸⁶, I. Ochoa ^{133a}, S. Oerdek ^{49,y}, J.T. Offermann ⁴¹, A. Ogrodnik ¹³⁶, A. Oh ¹⁰³, C.C. Ohm ¹⁴⁸, H. Oide ⁸⁵, R. Oishi ¹⁵⁷, M.L. Ojeda ³⁷, Y. Okumura ¹⁵⁷, L.F. Oleiro Seabra ^{133a}, I. Oleksiyuk ⁵⁷, S.A. Olivares Pino ^{140d}, G. Oliveira Correa ¹³, D. Oliveira Damazio ³⁰, J.L. Oliver ¹⁶², Ö.O. Öncel ⁵⁵, A.P. O'Neill ²⁰, A. Onofre ^{133a,133e}, P.U.E. Onyisi ¹¹, M.J. Oreglia ⁴¹, D. Orestano ^{78a,78b}, R.S. Orr ¹⁵⁸, L.M. Osojnak ¹³¹, Y. Osumi¹¹³, G. Otero y Garzon ³¹, H. Otono ⁹⁰, P.S. Ott ^{64a}, G.J. Ottino ^{18a}, M. Ouchrif ^{36d}, F. Ould-Saada ¹²⁸, T. Ovsianikova ¹⁴², M. Owen ⁶⁰, R.E. Owen ¹³⁷, V.E. Ozcan ^{22a}, F. Ozturk ⁸⁸, N. Ozturk ⁸, S. Ozturk ⁸³, H.A. Pacey ¹²⁹, K. Pachal ^{159a}, A. Pacheco Pages ¹³, C. Padilla Aranda ¹³, G. Padovano ^{76a,76b}, S. Pagan Griso ^{18a}, G. Palacino ⁶⁹, A. Palazzo ^{71a,71b}, J. Pampel ²⁵, J. Pan ¹⁷⁶, T. Pan ^{65a}, D.K. Panchal ¹¹, C.E. Pandini ¹¹⁷, J.G. Panduro Vazquez ¹³⁷, H.D. Pandya ¹, H. Pang ¹³⁸, P. Pani ⁴⁹, G. Panizzo ^{70a,70c}, L. Panwar ¹³⁰, L. Paolozzi ⁵⁷, S. Parajuli ¹⁶⁶, A. Paramonov ⁶, C. Paraskevopoulos ⁵⁴, D. Paredes Hernandez ^{65b}, A. Pareti ^{74a,74b}, K.R. Park ⁴³, T.H. Park ¹¹², F. Parodi ^{58b,58a}, J.A. Parsons ⁴³, U. Parzefall ⁵⁵, B. Pascual Dias ¹¹⁰, L. Pascual Dominguez ¹⁰¹, E. Pasqualucci ^{76a}, S. Passaggio ^{58b}, F. Pastore ⁹⁷, P. Patel ⁸⁸, U.M. Patel ⁵², J.R. Pater ¹⁰³, T. Pauly ³⁷, F. Pauwels ¹³⁶, C.I. Pazos ¹⁶¹, M. Pedersen ¹²⁸, R. Pedro ^{133a}, S.V. Peleganchuk ³⁹, O. Penc ³⁷, E.A. Pender ⁵³, S. Peng ¹⁵, G.D. Penn ¹⁷⁶, K.E. Pensi ¹¹¹, M. Penzin ³⁹, B.S. Peralva ^{84d}, A.P. Pereira Peixoto ¹⁴², L. Pereira Sanchez ¹⁴⁷, D.V. Perpelitsa ^{30,ai}, G. Perera ¹⁰⁵, E. Perez Codina ^{159a}, M. Perganti ¹⁰, H. Pernegger ³⁷, S. Perrella ^{76a,76b}, O. Perrin ⁴², K. Peters ⁴⁹, R.F.Y. Peters ¹⁰³, B.A. Petersen ³⁷, T.C. Petersen ⁴⁴, E. Petit ¹⁰⁴, V. Petousis ¹³⁵, C. Petridou ^{156,e}, T. Petru ¹³⁶, A. Petrukhin ¹⁴⁵, M. Pettee ^{18a}, A. Petukhov ⁸³, K. Petukhova ³⁷, R. Pezoa ^{140f}, L. Pezzotti ³⁷, G. Pezzullo ¹⁷⁶, A.J. Pflieger ³⁷, T.M. Pham ¹⁷⁴, T. Pham ¹⁰⁷, P.W. Phillips ¹³⁷, G. Piacquadio ¹⁴⁹, E. Pianori ^{18a}, F. Piazza ¹²⁶, R. Piegai ³¹, D. Pietreanu ^{28b}, A.D. Pilkington ¹⁰³, M. Pinamonti ^{70a,70c}, J.L. Pinfeld ², B.C. Pinheiro Pereira ^{133a}, J. Pinol Bel ¹³, A.E. Pinto Pinoargote ^{138,138}, L. Pintucci ^{70a,70c}, K.M. Piper ¹⁵⁰, A. Pirttikoski ⁵⁷, D.A. Pizzi ³⁵, L. Pizzimento ^{65b}, M.-A. Pleier ³⁰, V. Pleskot ¹³⁶, E. Plotnikova⁴⁰, G. Poddar ⁹⁶, R. Poettgen ¹⁰⁰, L. Poggioli ¹³⁰, S. Polacek ¹³⁶, G. Polesello ^{74a}, A. Poley ^{146,159a}, A. Polini ^{24b}, C.S. Pollard ¹⁷¹, Z.B. Pollock ¹²², E. Pompa Pacchi ¹²³, N.I. Pond ⁹⁸, D. Ponomarenko ⁶⁹, L. Pontecorvo ³⁷, S. Popa ^{28a}, G.A. Popeneciu ^{28d}, A. Poreba ³⁷, D.M. Portillo Quintero ^{159a}, S. Pospisil ¹³⁵, M.A. Postill ¹⁴³, P. Postolache ^{28c}, K. Potamianos ¹⁷¹, P.A. Potepa ^{87a}, I.N. Potrap ⁴⁰, C.J. Potter ³³, H. Potti ¹⁵¹, J. Poveda ¹⁶⁷, M.E. Pozo Astigarraga ³⁷, A. Prades Ibanez ^{77a,77b}, J. Pretel ¹⁶⁹, D. Price ¹⁰³, M. Primavera ^{71a}, L. Primomo ^{70a,70c}, M.A. Principe Martin ¹⁰¹,

R. Privara ¹²⁵, T. Procter ⁶⁰, M.L. Proffitt ¹⁴², N. Proklova ¹³¹, K. Prokofiev ^{65c}, G. Proto ¹¹²,
 J. Proudfoot ⁶, M. Przybycien ^{87a}, W.W. Przygoda ^{87b}, A. Psallidas ⁴⁷, J.E. Puddefoot ¹⁴³,
 D. Pudzha ⁵⁵, D. Pyatiiizbyantseva ¹¹⁶, J. Qian ¹⁰⁸, R. Qian ¹⁰⁹, D. Qichen ¹⁰³, Y. Qin ¹³,
 T. Qiu ⁵³, A. Quadt ⁵⁶, M. Queitsch-Maitland ¹⁰³, G. Quetant ⁵⁷, R.P. Quinn ¹⁶⁸,
 G. Rabanal Bolanos ⁶², D. Rafanoharana ⁵⁵, F. Raffaelli ^{77a,77b}, F. Ragusa ^{72a,72b}, J.L. Rainbolt ⁴¹,
 J.A. Raine ⁵⁷, S. Rajagopalan ³⁰, E. Ramakoti ³⁹, L. Rambelli ^{58b,58a}, I.A. Ramirez-Berend ³⁵,
 K. Ran ^{49,114c}, D.S. Rankin ¹³¹, N.P. Rapheeha ^{34g}, H. Rasheed ^{28b}, V. Raskina ¹³⁰,
 D.F. Rassloff ^{64a}, A. Rastogi ^{18a}, S. Rave ¹⁰², S. Ravera ^{58b,58a}, B. Ravina ³⁷, I. Ravinovich ¹⁷³,
 M. Raymond ³⁷, A.L. Read ¹²⁸, N.P. Readioff ¹⁴³, D.M. Rebuzzi ^{74a,74b}, A.S. Reed ¹¹²,
 K. Reeves ²⁷, J.A. Reidelsturz ¹⁷⁵, D. Reikher ¹²⁶, A. Rej ⁵⁰, C. Rembser ³⁷, H. Ren ^{63a},
 M. Renda ^{28b}, F. Renner ⁴⁹, A.G. Rennie ¹⁶², A.L. Rescia ⁴⁹, S. Resconi ^{72a},
 M. Ressegotti ^{58b,58a}, S. Rettie ³⁷, W.F. Rettie ³⁵, J.G. Reyes Rivera ¹⁰⁹, E. Reynolds ^{18a},
 O.L. Rezanova ³⁹, P. Reznicek ¹³⁶, H. Riani ^{36d}, N. Ribaric ⁵², E. Ricci ^{79a,79b}, R. Richter ¹¹²,
 S. Richter ^{48a,48b}, E. Richter-Was ^{87b}, M. Ridel ¹³⁰, S. Ridouani ^{36d}, P. Rieck ¹²⁰, P. Riedler ³⁷,
 E.M. Riefel ^{48a,48b}, J.O. Rieger ¹¹⁷, M. Rijssenbeek ¹⁴⁹, M. Rimoldi ³⁷, L. Rinaldi ^{24b,24a},
 P. Rincke ^{56,165}, M.P. Rinnagel ¹¹¹, G. Ripellino ¹⁶⁵, I. Riu ¹³, J.C. Rivera Vergara ¹⁶⁹,
 F. Rizatdinova ¹²⁴, E. Rizvi ⁹⁶, B.R. Roberts ^{18a}, S.S. Roberts ¹³⁹, D. Robinson ³³,
 M. Robles Manzano ¹⁰², A. Robson ⁶⁰, A. Rocchi ^{77a,77b}, C. Roda ^{75a,75b}, S. Rodriguez Bosca ³⁷,
 Y. Rodriguez Garcia ^{23a}, A.M. Rodríguez Vera ¹¹⁸, S. Roe ³⁷, J.T. Roemer ³⁷, O. Røhne ¹²⁸,
 C.P.A. Roland ¹³⁰, J. Roloff ³⁰, A. Romaniouk ⁸⁰, E. Romano ^{74a,74b}, M. Romano ^{24b},
 A.C. Romero Hernandez ¹⁶⁶, N. Rompotis ⁹⁴, L. Roos ¹³⁰, S. Rosati ^{76a}, B.J. Rosser ⁴¹,
 E. Rossi ¹²⁹, E. Rossi ^{73a,73b}, L.P. Rossi ⁶², L. Rossini ⁵⁵, R. Rosten ¹²², M. Rotaru ^{28b},
 B. Rottler ⁵⁵, C. Rougier ⁹¹, D. Rousseau ⁶⁷, D. Rousso ⁴⁹, S. Roy-Garand ¹⁵⁸, A. Rozanov ¹⁰⁴,
 Z.M.A. Rozario ⁶⁰, Y. Rozen ¹⁵⁴, A. Rubio Jimenez ¹⁶⁷, V.H. Ruelas Rivera ¹⁹, T.A. Ruggeri ¹,
 A. Ruggiero ¹²⁹, A. Ruiz-Martinez ¹⁶⁷, A. Rummler ³⁷, Z. Rurikova ⁵⁵, N.A. Rusakovich ⁴⁰,
 H.L. Russell ¹⁶⁹, G. Russo ^{76a,76b}, J.P. Rutherford ⁷, S. Rutherford Colmenares ³³, M. Rybar ¹³⁶,
 E.B. Rye ¹²⁸, A. Ryzhov ⁴⁶, J.A. Sabater Iglesias ⁵⁷, H.F.W. Sadrozinski ¹³⁹, F. Safai Tehrani ^{76a},
 S. Saha ¹, M. Sahinsoy ⁸³, A. Saibel ¹⁶⁷, M. Saimpert ¹³⁸, M. Saito ¹⁵⁷, T. Saito ¹⁵⁷,
 A. Sala ^{72a,72b}, D. Salamani ³⁷, A. Salnikov ¹⁴⁷, J. Salt ¹⁶⁷, A. Salvador Salas ¹⁵⁵,
 D. Salvatore ^{45b,45a}, F. Salvatore ¹⁵⁰, A. Salzburger ³⁷, D. Sammel ⁵⁵, E. Sampson ⁹³,
 D. Sampsonidis ^{156,e}, D. Sampsonidou ¹²⁶, J. Sánchez ¹⁶⁷, V. Sanchez Sebastian ¹⁶⁷,
 H. Sandaker ¹²⁸, C.O. Sander ⁴⁹, J.A. Sandesara ¹⁰⁵, M. Sandhoff ¹⁷⁵, C. Sandoval ^{23b},
 L. Sanfilippo ^{64a}, D.P.C. Sankey ¹³⁷, T. Sano ⁸⁹, A. Sansoni ⁵⁴, L. Santi ^{37,76b}, C. Santoni ⁴²,
 H. Santos ^{133a,133b}, A. Santra ¹⁷³, E. Sanzani ^{24b,24a}, K.A. Saoucha ¹⁶⁴, J.G. Saraiva ^{133a,133d},
 J. Sardain ⁷, O. Sasaki ⁸⁵, K. Sato ¹⁶⁰, C. Sauer ³⁷, E. Sauvan ⁴, P. Savard ^{158,ag}, R. Sawada ¹⁵⁷,
 C. Sawyer ¹³⁷, L. Sawyer ⁹⁹, C. Sbarra ^{24b}, A. Sbrizzi ^{24b,24a}, T. Scanlon ⁹⁸,
 J. Schaarschmidt ¹⁴², U. Schäfer ¹⁰², A.C. Schaffer ^{67,46}, D. Schaile ¹¹¹, R.D. Schamberger ¹⁴⁹,
 C. Scharf ¹⁹, M.M. Schefer ²⁰, V.A. Schegelsky ³⁹, D. Scheirich ¹³⁶, M. Schernau ^{140e},
 C. Scheulen ⁵⁷, C. Schiavi ^{58b,58a}, M. Schioppa ^{45b,45a}, B. Schlag ¹⁴⁷, S. Schlenker ³⁷,
 J. Schmeing ¹⁷⁵, M.A. Schmidt ¹⁷⁵, K. Schmieden ¹⁰², C. Schmitt ¹⁰², N. Schmitt ¹⁰²,
 S. Schmitt ⁴⁹, L. Schoeffel ¹³⁸, A. Schoening ^{64b}, P.G. Scholer ³⁵, E. Schopf ¹²⁹, M. Schott ²⁵,
 J. Schovancova ³⁷, S. Schramm ⁵⁷, T. Schroer ⁵⁷, H-C. Schultz-Coulon ^{64a}, M. Schumacher ⁵⁵,
 B.A. Schumm ¹³⁹, Ph. Schune ¹³⁸, H.R. Schwartz ¹³⁹, A. Schwartzman ¹⁴⁷, T.A. Schwarz ¹⁰⁸,
 Ph. Schwemling ¹³⁸, R. Schwienhorst ¹⁰⁹, F.G. Sciacca ²⁰, A. Sciandra ³⁰, G. Sciolla ²⁷,
 F. Scuri ^{75a}, C.D. Sebastiani ⁹⁴, K. Sedlaczek ¹¹⁸, S.C. Seidel ¹¹⁵, A. Seiden ¹³⁹,
 B.D. Seidlitz ⁴³, C. Seitz ⁴⁹, J.M. Seixas ^{84b}, G. Sekhniadze ^{73a}, L. Selem ⁶¹,
 N. Semprini-Cesari ^{24b,24a}, A. Semushin ^{177,39}, D. Sengupta ⁵⁷, V. Senthilkumar ¹⁶⁷, L. Serin ⁶⁷,

M. Sessa [ID 77a,77b](#), H. Severini [ID 123](#), F. Sforza [ID 58b,58a](#), A. Sfyrla [ID 57](#), Q. Sha [ID 14](#), E. Shabalina [ID 56](#),
H. Shaddix [ID 118](#), A.H. Shah [ID 33](#), R. Shaheen [ID 148](#), J.D. Shahinian [ID 131](#), D. Shaked Renous [ID 173](#),
L.Y. Shan [ID 14](#), M. Shapiro [ID 18a](#), A. Sharma [ID 37](#), A.S. Sharma [ID 168](#), P. Sharma [ID 30](#), P.B. Shatalov [ID 39](#),
K. Shaw [ID 150](#), S.M. Shaw [ID 103](#), Q. Shen [ID 63c](#), D.J. Sheppard [ID 146](#), P. Sherwood [ID 98](#), L. Shi [ID 98](#),
X. Shi [ID 14](#), S. Shimizu [ID 85](#), C.O. Shimmin [ID 176](#), I.P.J. Shipsey [ID 129,*](#), S. Shirabe [ID 90](#),
A.R. Shirazi-Nejad [ID 8](#), M. Shiyakova [ID 40,z](#), M.J. Shochet [ID 41](#), D.R. Shope [ID 128](#), B. Shrestha [ID 123](#),
S. Shrestha [ID 122,ak](#), I. Shreyber [ID 39](#), M.J. Shroff [ID 169](#), P. Sicho [ID 134](#), A.M. Sickles [ID 166](#),
E. Sideras Haddad [ID 34g,163](#), A.C. Sidley [ID 117](#), A. Sidoti [ID 24b](#), F. Siegert [ID 51](#), Dj. Sijacki [ID 16](#), F. Sili [ID 92](#),
J.M. Silva [ID 53](#), I. Silva Ferreira [ID 84b](#), M.V. Silva Oliveira [ID 30](#), S.B. Silverstein [ID 48a](#), S. Simion [ID 67](#),
R. Simoniello [ID 37](#), E.L. Simpson [ID 103](#), H. Simpson [ID 150](#), L.R. Simpson [ID 108](#), S. Simsek [ID 83](#),
S. Sindhu [ID 56](#), P. Sinervo [ID 158](#), S.N. Singh [ID 27](#), S. Singh [ID 30](#), S. Sinha [ID 49](#), S. Sinha [ID 103](#),
M. Sioli [ID 24b,24a](#), K. Sioulas [ID 9](#), I. Siral [ID 37](#), E. Sitnikova [ID 49](#), J. Sjölin [ID 48a,48b](#), A. Skaf [ID 56](#),
E. Skorda [ID 21](#), P. Skubic [ID 123](#), M. Slawinska [ID 88](#), I. Slazyk [ID 17](#), V. Smakhtin [ID 173](#), B.H. Smart [ID 137](#),
S.Yu. Smirnov [ID 39](#), Y. Smirnov [ID 39](#), L.N. Smirnova [ID 39,a](#), O. Smirnova [ID 100](#), A.C. Smith [ID 43](#),
D.R. Smith [ID 162](#), E.A. Smith [ID 41](#), J.L. Smith [ID 103](#), M.B. Smith [ID 35](#), R. Smith [ID 147](#), H. Smitmanns [ID 102](#),
M. Smizanska [ID 93](#), K. Smolek [ID 135](#), A.A. Snesarev [ID 39](#), H.L. Snoek [ID 117](#), S. Snyder [ID 30](#),
R. Sobie [ID 169,ab](#), A. Soffer [ID 155](#), C.A. Solans Sanchez [ID 37](#), E.Yu. Soldatov [ID 39](#), U. Soldevila [ID 167](#),
A.A. Solodkov [ID 39](#), S. Solomon [ID 27](#), A. Soloshenko [ID 40](#), K. Solovieva [ID 55](#), O.V. Solovyanov [ID 42](#),
P. Sommer [ID 51](#), A. Sonay [ID 13](#), W.Y. Song [ID 159b](#), A. Sopczak [ID 135](#), A.L. Sopio [ID 53](#), F. Sopkova [ID 29b](#),
J.D. Sorenson [ID 115](#), I.R. Sotarriva Alvarez [ID 141](#), V. Sothilingam [ID 64a](#), O.J. Soto Sandoval [ID 140c,140b](#),
S. Sottocornola [ID 69](#), R. Soualah [ID 164](#), Z. Soumami [ID 36e](#), D. South [ID 49](#), N. Soybelman [ID 173](#),
S. Spagnolo [ID 71a,71b](#), M. Spalla [ID 112](#), D. Sperlich [ID 55](#), B. Spisso [ID 73a,73b](#), D.P. Spiteri [ID 60](#),
M. Spousta [ID 136](#), E.J. Staats [ID 35](#), R. Stamen [ID 64a](#), E. Stanecka [ID 88](#), W. Stanek-Maslouska [ID 49](#),
M.V. Stange [ID 51](#), B. Stanislaus [ID 18a](#), M.M. Stanitzki [ID 49](#), B. Stapf [ID 49](#), E.A. Starchenko [ID 39](#),
G.H. Stark [ID 139](#), J. Stark [ID 91](#), P. Staroba [ID 134](#), P. Starovoitov [ID 164](#), R. Staszewski [ID 88](#),
G. Stavropoulos [ID 47](#), A. Stefl [ID 37](#), P. Steinberg [ID 30](#), B. Stelzer [ID 146,159a](#), H.J. Stelzer [ID 132](#),
O. Stelzer-Chilton [ID 159a](#), H. Stenzel [ID 59](#), T.J. Stevenson [ID 150](#), G.A. Stewart [ID 37](#), J.R. Stewart [ID 124](#),
M.C. Stockton [ID 37](#), G. Stoicea [ID 28b](#), M. Stolarski [ID 133a](#), S. Stonjek [ID 112](#), A. Straessner [ID 51](#),
J. Strandberg [ID 148](#), S. Strandberg [ID 48a,48b](#), M. Stratmann [ID 175](#), M. Strauss [ID 123](#), T. Strebler [ID 104](#),
P. Strizenec [ID 29b](#), R. Ströhmer [ID 170](#), D.M. Strom [ID 126](#), R. Stroynowski [ID 46](#), A. Strubig [ID 48a,48b](#),
S.A. Stucci [ID 30](#), B. Stugu [ID 17](#), J. Stupak [ID 123](#), N.A. Styles [ID 49](#), D. Su [ID 147](#), S. Su [ID 63a](#), W. Su [ID 63d](#),
X. Su [ID 63a](#), D. Suchy [ID 29a](#), K. Sugizaki [ID 131](#), V.V. Sulin [ID 39](#), M.J. Sullivan [ID 94](#), D.M.S. Sultan [ID 129](#),
L. Sultaniyeva [ID 39](#), S. Sultansoy [ID 3b](#), S. Sun [ID 174](#), W. Sun [ID 14](#), O. Sunneborn Gudnadottir [ID 165](#),
N. Sur [ID 104](#), M.R. Sutton [ID 150](#), H. Suzuki [ID 160](#), M. Svatos [ID 134](#), M. Swiatlowski [ID 159a](#), T. Swirski [ID 170](#),
I. Sykora [ID 29a](#), M. Sykora [ID 136](#), T. Sykora [ID 136](#), D. Ta [ID 102](#), K. Tackmann [ID 49,y](#), A. Taffard [ID 162](#),
R. Tafirout [ID 159a](#), J.S. Tafoya Vargas [ID 67](#), Y. Takubo [ID 85](#), M. Talby [ID 104](#), A.A. Talyshev [ID 39](#),
K.C. Tam [ID 65b](#), N.M. Tamir [ID 155](#), A. Tanaka [ID 157](#), J. Tanaka [ID 157](#), R. Tanaka [ID 67](#), M. Tanasini [ID 149](#),
Z. Tao [ID 168](#), S. Tapia Araya [ID 140f](#), S. Tapprogge [ID 102](#), A. Tarek Abouelfadl Mohamed [ID 109](#),
S. Tarem [ID 154](#), K. Tariq [ID 14](#), G. Tarna [ID 28b](#), G.F. Tartarelli [ID 72a](#), M.J. Tartarin [ID 91](#), P. Tas [ID 136](#),
M. Tasevsky [ID 134](#), E. Tassi [ID 45b,45a](#), A.C. Tate [ID 166](#), G. Tateno [ID 157](#), Y. Tayalati [ID 36e,aa](#), G.N. Taylor [ID 107](#),
W. Taylor [ID 159b](#), P. Teixeira-Dias [ID 97](#), J.J. Teoh [ID 158](#), K. Terashi [ID 157](#), J. Terron [ID 101](#), S. Terzo [ID 13](#),
M. Testa [ID 54](#), R.J. Teuscher [ID 158,ab](#), A. Thaler [ID 80](#), O. Theiner [ID 57](#), T. Thevenaux-Pelzer [ID 104](#),
O. Thielmann [ID 175](#), D.W. Thomas [ID 97](#), J.P. Thomas [ID 21](#), E.A. Thompson [ID 18a](#), P.D. Thompson [ID 21](#),
E. Thomson [ID 131](#), R.E. Thornberry [ID 46](#), C. Tian [ID 63a](#), Y. Tian [ID 57](#), V. Tikhomirov [ID 39,a](#),
Yu.A. Tikhonov [ID 39](#), S. Timoshenko [ID 39](#), D. Timoshyn [ID 136](#), E.X.L. Ting [ID 1](#), P. Tipton [ID 176](#),
A. Tishelman-Charny [ID 30](#), S.H. Tlou [ID 34g](#), K. Todome [ID 141](#), S. Todorova-Nova [ID 136](#), S. Todt [ID 51](#),
L. Toffolin [ID 70a,70c](#), M. Togawa [ID 85](#), J. Tojo [ID 90](#), S. Tokár [ID 29a](#), O. Toldaiev [ID 69](#), G. Tolkachev [ID 104](#),

M. Tomoto [ID^{85,113}](#), L. Tompkins [ID^{147,o}](#), E. Torrence [ID¹²⁶](#), H. Torres [ID⁹¹](#), E. Torró Pastor [ID¹⁶⁷](#),
M. Toscani [ID³¹](#), C. Tosciri [ID⁴¹](#), M. Tost [ID¹¹](#), D.R. Tovey [ID¹⁴³](#), T. Trefzger [ID¹⁷⁰](#), A. Tricoli [ID³⁰](#),
I.M. Trigger [ID^{159a}](#), S. Trincaz-Duvoid [ID¹³⁰](#), D.A. Trischuk [ID²⁷](#), A. Tropina [ID⁴⁰](#), L. Truong [ID^{34c}](#),
M. Trzebinski [ID⁸⁸](#), A. Trzupiek [ID⁸⁸](#), F. Tsai [ID¹⁴⁹](#), M. Tsai [ID¹⁰⁸](#), A. Tsiamis [ID¹⁵⁶](#), P.V. Tsiarehka [ID⁴⁰](#),
S. Tsigaridas [ID^{159a}](#), A. Tsirigotis [ID^{156,u}](#), V. Tsiskaridze [ID¹⁵⁸](#), E.G. Tskhadadze [ID^{153a}](#), M. Tsopoulou [ID¹⁵⁶](#),
Y. Tsujikawa [ID⁸⁹](#), I.I. Tsukerman [ID³⁹](#), V. Tsulaia [ID^{18a}](#), S. Tsuno [ID⁸⁵](#), K. Tsuru [ID¹²¹](#), D. Tsybychev [ID¹⁴⁹](#),
Y. Tu [ID^{65b}](#), A. Tudorache [ID^{28b}](#), V. Tudorache [ID^{28b}](#), S. Turchikhin [ID^{58b,58a}](#), I. Turk Cakir [ID^{3a}](#),
R. Turra [ID^{72a}](#), T. Turtuvshin [ID⁴⁰](#), P.M. Tuts [ID⁴³](#), S. Tzamarias [ID^{156,e}](#), E. Tzovara [ID¹⁰²](#), F. Ukegawa [ID¹⁶⁰](#),
P.A. Ulloa Poblete [ID^{140c,140b}](#), E.N. Umaka [ID³⁰](#), G. Unal [ID³⁷](#), A. Undrus [ID³⁰](#), G. Unel [ID¹⁶²](#), J. Urban [ID^{29b}](#),
P. Urrejola [ID^{140a}](#), G. Usai [ID⁸](#), R. Ushioda [ID¹⁴¹](#), M. Usman [ID¹¹⁰](#), F. Ustuner [ID⁵³](#), Z. Uysal [ID⁸³](#),
V. Vacek [ID¹³⁵](#), B. Vachon [ID¹⁰⁶](#), T. Vafeiadis [ID³⁷](#), A. Vaitkus [ID⁹⁸](#), C. Valderanis [ID¹¹¹](#),
E. Valdes Santurio [ID^{48a,48b}](#), M. Valente [ID^{159a}](#), S. Valentinetti [ID^{24b,24a}](#), A. Valero [ID¹⁶⁷](#),
E. Valiente Moreno [ID¹⁶⁷](#), A. Vallier [ID⁹¹](#), J.A. Valls Ferrer [ID¹⁶⁷](#), D.R. Van Arneman [ID¹¹⁷](#),
T.R. Van Daalen [ID¹⁴²](#), A. Van Der Graaf [ID⁵⁰](#), P. Van Gemmeren [ID⁶](#), M. Van Rijnbach [ID³⁷](#),
S. Van Stroud [ID⁹⁸](#), I. Van Vulpen [ID¹¹⁷](#), P. Vana [ID¹³⁶](#), M. Vanadia [ID^{77a,77b}](#), U.M. Vande Voorde [ID¹⁴⁸](#),
W. Vandelli [ID³⁷](#), E.R. Vandewall [ID¹²⁴](#), D. Vannicola [ID¹⁵⁵](#), L. Vannoli [ID⁵⁴](#), R. Vari [ID^{76a}](#), E.W. Varnes [ID⁷](#),
C. Varni [ID^{18b}](#), D. Varouchas [ID⁶⁷](#), L. Varriale [ID¹⁶⁷](#), K.E. Varvell [ID¹⁵¹](#), M.E. Vasile [ID^{28b}](#), L. Vaslin [ID⁸⁵](#),
A. Vasyukov [ID⁴⁰](#), L.M. Vaughan [ID¹²⁴](#), R. Vavricka [ID¹⁰²](#), T. Vazquez Schroeder [ID¹³](#), J. Veatch [ID³²](#),
V. Vecchio [ID¹⁰³](#), M.J. Veen [ID¹⁰⁵](#), I. Veliscek [ID³⁰](#), L.M. Veloce [ID¹⁵⁸](#), F. Veloso [ID^{133a,133c}](#),
S. Veneziano [ID^{76a}](#), A. Ventura [ID^{71a,71b}](#), S. Ventura Gonzalez [ID¹³⁸](#), A. Verbytskyi [ID¹¹²](#),
M. Verducci [ID^{75a,75b}](#), C. Vergis [ID⁹⁶](#), M. Verissimo De Araujo [ID^{84b}](#), W. Verkerke [ID¹¹⁷](#),
J.C. Vermeulen [ID¹¹⁷](#), C. Vernieri [ID¹⁴⁷](#), M. Vessella [ID¹⁶²](#), M.C. Vetterli [ID^{146,ag}](#), A. Vgenopoulos [ID¹⁰²](#),
N. Viaux Maira [ID^{140f}](#), T. Vickey [ID¹⁴³](#), O.E. Vickey Boeriu [ID¹⁴³](#), G.H.A. Viehhauser [ID¹²⁹](#), L. Vignani [ID^{64b}](#),
M. Vigl [ID¹¹²](#), M. Villa [ID^{24b,24a}](#), M. Villaplana Perez [ID¹⁶⁷](#), E.M. Villhauer [ID⁵³](#), E. Vilucchi [ID⁵⁴](#),
M.G. Vincter [ID³⁵](#), A. Visibile [ID¹¹⁷](#), C. Vittori [ID³⁷](#), I. Vivarelli [ID^{24b,24a}](#), E. Voevodina [ID¹¹²](#), F. Vogel [ID¹¹¹](#),
J.C. Voigt [ID⁵¹](#), P. Vokac [ID¹³⁵](#), Yu. Volkotrub [ID^{87b}](#), E. Von Toerne [ID²⁵](#), B. Vormwald [ID³⁷](#),
K. Vorobev [ID³⁹](#), M. Vos [ID¹⁶⁷](#), K. Voss [ID¹⁴⁵](#), M. Vozak [ID¹¹⁷](#), L. Vozdecky [ID¹²³](#), N. Vranjes [ID¹⁶](#),
M. Vranjes Milosavljevic [ID¹⁶](#), M. Vreeswijk [ID¹¹⁷](#), N.K. Vu [ID^{63d,63c}](#), R. Vuillermet [ID³⁷](#),
O. Vujinovic [ID¹⁰²](#), I. Vukotic [ID⁴¹](#), I.K. Vyas [ID³⁵](#), S. Wada [ID¹⁶⁰](#), C. Wagner [ID¹⁴⁷](#), J.M. Wagner [ID^{18a}](#),
W. Wagner [ID¹⁷⁵](#), S. Wahdan [ID¹⁷⁵](#), H. Wahlberg [ID⁹²](#), C.H. Waits [ID¹²³](#), J. Walder [ID¹³⁷](#), R. Walker [ID¹¹¹](#),
W. Walkowiak [ID¹⁴⁵](#), A. Wall [ID¹³¹](#), E.J. Wallin [ID¹⁰⁰](#), T. Wamorkar [ID^{18a}](#), A.Z. Wang [ID¹³⁹](#), C. Wang [ID¹⁰²](#),
C. Wang [ID¹¹](#), H. Wang [ID^{18a}](#), J. Wang [ID^{65c}](#), P. Wang [ID¹⁰³](#), P. Wang [ID⁹⁸](#), R. Wang [ID⁶²](#), R. Wang [ID⁶](#),
S.M. Wang [ID¹⁵²](#), S. Wang [ID¹⁴](#), T. Wang [ID^{63a}](#), W.T. Wang [ID⁸¹](#), W. Wang [ID¹⁴](#), X. Wang [ID¹⁶⁶](#),
X. Wang [ID^{63c}](#), Y. Wang [ID^{114a}](#), Y. Wang [ID^{63a}](#), Z. Wang [ID¹⁰⁸](#), Z. Wang [ID^{63d,52,63c}](#), Z. Wang [ID¹⁰⁸](#),
C. Wanotayaroj [ID⁸⁵](#), A. Warburton [ID¹⁰⁶](#), R.J. Ward [ID²¹](#), A.L. Warnerbring [ID¹⁴⁵](#), N. Warrack [ID⁶⁰](#),
S. Waterhouse [ID⁹⁷](#), A.T. Watson [ID²¹](#), H. Watson [ID⁵³](#), M.F. Watson [ID²¹](#), E. Watton [ID^{60,137}](#), G. Watts [ID¹⁴²](#),
B.M. Waugh [ID⁹⁸](#), J.M. Webb [ID⁵⁵](#), C. Weber [ID³⁰](#), H.A. Weber [ID¹⁹](#), M.S. Weber [ID²⁰](#), S.M. Weber [ID^{64a}](#),
C. Wei [ID^{63a}](#), Y. Wei [ID⁵⁵](#), A.R. Weidberg [ID¹²⁹](#), E.J. Weik [ID¹²⁰](#), J. Weingarten [ID⁵⁰](#), C. Weiser [ID⁵⁵](#),
C.J. Wells [ID⁴⁹](#), T. Wenaus [ID³⁰](#), B. Wendland [ID⁵⁰](#), T. Wengler [ID³⁷](#), N.S. Wenke [ID¹¹²](#), N. Wermes [ID²⁵](#),
M. Wessels [ID^{64a}](#), A.M. Wharton [ID⁹³](#), A.S. White [ID⁶²](#), A. White [ID⁸](#), M.J. White [ID¹](#), D. Whiteson [ID¹⁶²](#),
L. Wickremasinghe [ID¹²⁷](#), W. Wiedenmann [ID¹⁷⁴](#), M. Wielers [ID¹³⁷](#), C. Wiglesworth [ID⁴⁴](#), D.J. Wilbern [ID¹²³](#),
H.G. Wilkens [ID³⁷](#), J.J.H. Wilkinson [ID³³](#), D.M. Williams [ID⁴³](#), H.H. Williams [ID¹³¹](#), S. Williams [ID³³](#),
S. Willocq [ID¹⁰⁵](#), B.J. Wilson [ID¹⁰³](#), D.J. Wilson [ID¹⁰³](#), P.J. Windischhofer [ID⁴¹](#), F.I. Winkel [ID³¹](#),
F. Winklmeier [ID¹²⁶](#), B.T. Winter [ID⁵⁵](#), M. Wittgen [ID¹⁴⁷](#), M. Wobisch [ID⁹⁹](#), T. Wojtkowski [ID⁶¹](#), Z. Wolffs [ID¹¹⁷](#),
J. Wollrath [ID³⁷](#), M.W. Wolter [ID⁸⁸](#), H. Wolters [ID^{133a,133c}](#), M.C. Wong [ID¹³⁹](#), E.L. Woodward [ID⁴³](#),
S.D. Worm [ID⁴⁹](#), B.K. Wosiek [ID⁸⁸](#), K.W. Woźniak [ID⁸⁸](#), S. Wozniowski [ID⁵⁶](#), K. Wraight [ID⁶⁰](#), C. Wu [ID²¹](#),
M. Wu [ID^{114b}](#), M. Wu [ID¹¹⁶](#), S.L. Wu [ID¹⁷⁴](#), X. Wu [ID⁵⁷](#), X. Wu [ID^{63a}](#), Y. Wu [ID^{63a}](#), Z. Wu [ID⁴](#),

J. Wuerzinger ^{112,ae}, T.R. Wyatt ¹⁰³, B.M. Wynne ⁵³, S. Xella ⁴⁴, L. Xia ^{114a}, M. Xia ¹⁵, M. Xie ^{63a}, A. Xiong ¹²⁶, J. Xiong ^{18a}, D. Xu ¹⁴, H. Xu ^{63a}, L. Xu ^{63a}, R. Xu ¹³¹, T. Xu ¹⁰⁸, Y. Xu ¹⁴², Z. Xu ⁵³, Z. Xu ^{114a}, B. Yabsley ¹⁵¹, S. Yacoob ^{34a}, Y. Yamaguchi ⁸⁵, E. Yamashita ¹⁵⁷, H. Yamauchi ¹⁶⁰, T. Yamazaki ^{18a}, Y. Yamazaki ⁸⁶, S. Yan ⁶⁰, Z. Yan ¹⁰⁵, H.J. Yang ^{63c,63d}, H.T. Yang ^{63a}, S. Yang ^{63a}, T. Yang ^{65c}, X. Yang ³⁷, X. Yang ¹⁴, Y. Yang ⁴⁶, Y. Yang ^{63a}, W.-M. Yao ^{18a}, H. Ye ⁵⁶, J. Ye ¹⁴, S. Ye ³⁰, X. Ye ^{63a}, Y. Yeh ⁹⁸, I. Yeletsikh ⁴⁰, B. Yeo ^{18b}, M.R. Yexley ⁹⁸, T.P. Yildirim ¹²⁹, P. Yin ⁴³, K. Yorita ¹⁷², S. Younas ^{28b}, C.J.S. Young ³⁷, C. Young ¹⁴⁷, N.D. Young ¹²⁶, Y. Yu ^{63a}, J. Yuan ^{14,114c}, M. Yuan ¹⁰⁸, R. Yuan ^{63d,63c}, L. Yue ⁹⁸, M. Zaazoua ^{63a}, B. Zabinski ⁸⁸, I. Zahir ^{36a}, Z.K. Zak ⁸⁸, T. Zakareishvili ¹⁶⁷, S. Zambito ⁵⁷, J.A. Zamora Saa ^{140d,140b}, J. Zang ¹⁵⁷, D. Zanzi ⁵⁵, R. Zanzottera ^{72a,72b}, O. Zaplatilek ¹³⁵, C. Zeitnitz ¹⁷⁵, H. Zeng ¹⁴, J.C. Zeng ¹⁶⁶, D.T. Zenger Jr ²⁷, O. Zenin ³⁹, T. Ženiš ^{29a}, S. Zenz ⁹⁶, S. Zerradi ^{36a}, D. Zerwas ⁶⁷, M. Zhai ^{14,114c}, D.F. Zhang ¹⁴³, J. Zhang ^{63b}, J. Zhang ⁶, K. Zhang ^{14,114c}, L. Zhang ^{63a}, L. Zhang ^{114a}, P. Zhang ^{14,114c}, R. Zhang ¹⁷⁴, S. Zhang ⁹¹, T. Zhang ¹⁵⁷, X. Zhang ^{63c}, Y. Zhang ¹⁴², Y. Zhang ⁹⁸, Y. Zhang ^{63a}, Y. Zhang ^{114a}, Z. Zhang ^{18a}, Z. Zhang ^{63b}, Z. Zhang ⁶⁷, H. Zhao ¹⁴², T. Zhao ^{63b}, Y. Zhao ³⁵, Z. Zhao ^{63a}, Z. Zhao ^{63a}, A. Zhemchugov ⁴⁰, J. Zheng ^{114a}, K. Zheng ¹⁶⁶, X. Zheng ^{63a}, Z. Zheng ¹⁴⁷, D. Zhong ¹⁶⁶, B. Zhou ¹⁰⁸, H. Zhou ⁷, N. Zhou ^{63c}, Y. Zhou ¹⁵, Y. Zhou ^{114a}, Y. Zhou ⁷, C.G. Zhu ^{63b}, J. Zhu ¹⁰⁸, X. Zhu ^{63d}, Y. Zhu ^{63c}, Y. Zhu ^{63a}, X. Zhuang ¹⁴, K. Zhukov ⁶⁹, N.I. Zimine ⁴⁰, J. Zinsser ^{64b}, M. Ziolkowski ¹⁴⁵, L. Živković ¹⁶, A. Zoccoli ^{24b,24a}, K. Zoch ⁶², T.G. Zorbas ¹⁴³, O. Zormpa ⁴⁷, W. Zou ⁴³, L. Zwalinski ³⁷.

¹Department of Physics, University of Adelaide, Adelaide; Australia.

²Department of Physics, University of Alberta, Edmonton AB; Canada.

³(^a)Department of Physics, Ankara University, Ankara; (^b)Division of Physics, TOBB University of Economics and Technology, Ankara; Türkiye.

⁴LAPP, Université Savoie Mont Blanc, CNRS/IN2P3, Annecy; France.

⁵APC, Université Paris Cité, CNRS/IN2P3, Paris; France.

⁶High Energy Physics Division, Argonne National Laboratory, Argonne IL; United States of America.

⁷Department of Physics, University of Arizona, Tucson AZ; United States of America.

⁸Department of Physics, University of Texas at Arlington, Arlington TX; United States of America.

⁹Physics Department, National and Kapodistrian University of Athens, Athens; Greece.

¹⁰Physics Department, National Technical University of Athens, Zografou; Greece.

¹¹Department of Physics, University of Texas at Austin, Austin TX; United States of America.

¹²Institute of Physics, Azerbaijan Academy of Sciences, Baku; Azerbaijan.

¹³Institut de Física d'Altes Energies (IFAE), Barcelona Institute of Science and Technology, Barcelona; Spain.

¹⁴Institute of High Energy Physics, Chinese Academy of Sciences, Beijing; China.

¹⁵Physics Department, Tsinghua University, Beijing; China.

¹⁶Institute of Physics, University of Belgrade, Belgrade; Serbia.

¹⁷Department for Physics and Technology, University of Bergen, Bergen; Norway.

¹⁸(^a)Physics Division, Lawrence Berkeley National Laboratory, Berkeley CA; (^b)University of California, Berkeley CA; United States of America.

¹⁹Institut für Physik, Humboldt Universität zu Berlin, Berlin; Germany.

²⁰Albert Einstein Center for Fundamental Physics and Laboratory for High Energy Physics, University of Bern, Bern; Switzerland.

²¹School of Physics and Astronomy, University of Birmingham, Birmingham; United Kingdom.

- ^{22(a)}Department of Physics, Bogazici University, Istanbul;^(b)Department of Physics Engineering, Gaziantep University, Gaziantep;^(c)Department of Physics, Istanbul University, Istanbul; Türkiye.
- ^{23(a)}Facultad de Ciencias y Centro de Investigaciones, Universidad Antonio Nariño, Bogotá;^(b)Departamento de Física, Universidad Nacional de Colombia, Bogotá; Colombia.
- ^{24(a)}Dipartimento di Fisica e Astronomia A. Righi, Università di Bologna, Bologna;^(b)INFN Sezione di Bologna; Italy.
- ²⁵Physikalisches Institut, Universität Bonn, Bonn; Germany.
- ²⁶Department of Physics, Boston University, Boston MA; United States of America.
- ²⁷Department of Physics, Brandeis University, Waltham MA; United States of America.
- ^{28(a)}Transilvania University of Brasov, Brasov;^(b)Horia Hulubei National Institute of Physics and Nuclear Engineering, Bucharest;^(c)Department of Physics, Alexandru Ioan Cuza University of Iasi, Iasi;^(d)National Institute for Research and Development of Isotopic and Molecular Technologies, Physics Department, Cluj-Napoca;^(e)National University of Science and Technology Politehnica, Bucharest;^(f)West University in Timisoara, Timisoara;^(g)Faculty of Physics, University of Bucharest, Bucharest; Romania.
- ^{29(a)}Faculty of Mathematics, Physics and Informatics, Comenius University, Bratislava;^(b)Department of Subnuclear Physics, Institute of Experimental Physics of the Slovak Academy of Sciences, Kosice; Slovak Republic.
- ³⁰Physics Department, Brookhaven National Laboratory, Upton NY; United States of America.
- ³¹Universidad de Buenos Aires, Facultad de Ciencias Exactas y Naturales, Departamento de Física, y CONICET, Instituto de Física de Buenos Aires (IFIBA), Buenos Aires; Argentina.
- ³²California State University, CA; United States of America.
- ³³Cavendish Laboratory, University of Cambridge, Cambridge; United Kingdom.
- ^{34(a)}Department of Physics, University of Cape Town, Cape Town;^(b)iThemba Labs, Western Cape;^(c)Department of Mechanical Engineering Science, University of Johannesburg, Johannesburg;^(d)National Institute of Physics, University of the Philippines Diliman (Philippines);^(e)University of South Africa, Department of Physics, Pretoria;^(f)University of Zululand, KwaDlangezwa;^(g)School of Physics, University of the Witwatersrand, Johannesburg; South Africa.
- ³⁵Department of Physics, Carleton University, Ottawa ON; Canada.
- ^{36(a)}Faculté des Sciences Ain Chock, Université Hassan II de Casablanca;^(b)Faculté des Sciences, Université Ibn-Tofail, Kénitra;^(c)Faculté des Sciences Semlalia, Université Cadi Ayyad, LPHEA-Marrakech;^(d)LPMR, Faculté des Sciences, Université Mohamed Premier, Oujda;^(e)Faculté des sciences, Université Mohammed V, Rabat;^(f)Institute of Applied Physics, Mohammed VI Polytechnic University, Ben Guerir; Morocco.
- ³⁷CERN, Geneva; Switzerland.
- ³⁸Affiliated with an institute formerly covered by a cooperation agreement with CERN.
- ³⁹Affiliated with an institute covered by a cooperation agreement with CERN.
- ⁴⁰Affiliated with an international laboratory covered by a cooperation agreement with CERN.
- ⁴¹Enrico Fermi Institute, University of Chicago, Chicago IL; United States of America.
- ⁴²LPC, Université Clermont Auvergne, CNRS/IN2P3, Clermont-Ferrand; France.
- ⁴³Nevis Laboratory, Columbia University, Irvington NY; United States of America.
- ⁴⁴Niels Bohr Institute, University of Copenhagen, Copenhagen; Denmark.
- ^{45(a)}Dipartimento di Fisica, Università della Calabria, Rende;^(b)INFN Gruppo Collegato di Cosenza, Laboratori Nazionali di Frascati; Italy.
- ⁴⁶Physics Department, Southern Methodist University, Dallas TX; United States of America.
- ⁴⁷National Centre for Scientific Research "Demokritos", Agia Paraskevi; Greece.
- ^{48(a)}Department of Physics, Stockholm University;^(b)Oskar Klein Centre, Stockholm; Sweden.
- ⁴⁹Deutsches Elektronen-Synchrotron DESY, Hamburg and Zeuthen; Germany.

- ⁵⁰Fakultät Physik , Technische Universität Dortmund, Dortmund; Germany.
- ⁵¹Institut für Kern- und Teilchenphysik, Technische Universität Dresden, Dresden; Germany.
- ⁵²Department of Physics, Duke University, Durham NC; United States of America.
- ⁵³SUPA - School of Physics and Astronomy, University of Edinburgh, Edinburgh; United Kingdom.
- ⁵⁴INFN e Laboratori Nazionali di Frascati, Frascati; Italy.
- ⁵⁵Physikalisches Institut, Albert-Ludwigs-Universität Freiburg, Freiburg; Germany.
- ⁵⁶II. Physikalisches Institut, Georg-August-Universität Göttingen, Göttingen; Germany.
- ⁵⁷Département de Physique Nucléaire et Corpusculaire, Université de Genève, Genève; Switzerland.
- ⁵⁸(^a)Dipartimento di Fisica, Università di Genova, Genova;(^b) INFN Sezione di Genova; Italy.
- ⁵⁹II. Physikalisches Institut, Justus-Liebig-Universität Giessen, Giessen; Germany.
- ⁶⁰SUPA - School of Physics and Astronomy, University of Glasgow, Glasgow; United Kingdom.
- ⁶¹LPSC, Université Grenoble Alpes, CNRS/IN2P3, Grenoble INP, Grenoble; France.
- ⁶²Laboratory for Particle Physics and Cosmology, Harvard University, Cambridge MA; United States of America.
- ⁶³(^a)Department of Modern Physics and State Key Laboratory of Particle Detection and Electronics, University of Science and Technology of China, Hefei;(^b)Institute of Frontier and Interdisciplinary Science and Key Laboratory of Particle Physics and Particle Irradiation (MOE), Shandong University, Qingdao;(^c)School of Physics and Astronomy, Shanghai Jiao Tong University, Key Laboratory for Particle Astrophysics and Cosmology (MOE), SKLPPC, Shanghai;(^d)Tsung-Dao Lee Institute, Shanghai;(^e)School of Physics, Zhengzhou University; China.
- ⁶⁴(^a) Kirchhoff-Institut für Physik, Ruprecht-Karls-Universität Heidelberg, Heidelberg;(^b)Physikalisches Institut, Ruprecht-Karls-Universität Heidelberg, Heidelberg; Germany.
- ⁶⁵(^a)Department of Physics, Chinese University of Hong Kong, Shatin, N.T., Hong Kong;(^b)Department of Physics, University of Hong Kong, Hong Kong;(^c)Department of Physics and Institute for Advanced Study, Hong Kong University of Science and Technology, Clear Water Bay, Kowloon, Hong Kong; China.
- ⁶⁶Department of Physics, National Tsing Hua University, Hsinchu; Taiwan.
- ⁶⁷IJCLab, Université Paris-Saclay, CNRS/IN2P3, 91405, Orsay; France.
- ⁶⁸Centro Nacional de Microelectrónica (IMB-CNM-CSIC), Barcelona; Spain.
- ⁶⁹Department of Physics, Indiana University, Bloomington IN; United States of America.
- ⁷⁰(^a)INFN Gruppo Collegato di Udine, Sezione di Trieste, Udine;(^b)ICTP, Trieste;(^c)Dipartimento Politecnico di Ingegneria e Architettura, Università di Udine, Udine; Italy.
- ⁷¹(^a)INFN Sezione di Lecce;(^b)Dipartimento di Matematica e Fisica, Università del Salento, Lecce; Italy.
- ⁷²(^a)INFN Sezione di Milano;(^b)Dipartimento di Fisica, Università di Milano, Milano; Italy.
- ⁷³(^a)INFN Sezione di Napoli;(^b)Dipartimento di Fisica, Università di Napoli, Napoli; Italy.
- ⁷⁴(^a)INFN Sezione di Pavia;(^b)Dipartimento di Fisica, Università di Pavia, Pavia; Italy.
- ⁷⁵(^a)INFN Sezione di Pisa;(^b)Dipartimento di Fisica E. Fermi, Università di Pisa, Pisa; Italy.
- ⁷⁶(^a)INFN Sezione di Roma;(^b)Dipartimento di Fisica, Sapienza Università di Roma, Roma; Italy.
- ⁷⁷(^a)INFN Sezione di Roma Tor Vergata;(^b)Dipartimento di Fisica, Università di Roma Tor Vergata, Roma; Italy.
- ⁷⁸(^a)INFN Sezione di Roma Tre;(^b)Dipartimento di Matematica e Fisica, Università Roma Tre, Roma; Italy.
- ⁷⁹(^a)INFN-TIFPA;(^b)Università degli Studi di Trento, Trento; Italy.
- ⁸⁰Universität Innsbruck, Department of Astro and Particle Physics, Innsbruck; Austria.
- ⁸¹University of Iowa, Iowa City IA; United States of America.
- ⁸²Department of Physics and Astronomy, Iowa State University, Ames IA; United States of America.
- ⁸³Istinye University, Sariyer, Istanbul; Türkiye.
- ⁸⁴(^a)Departamento de Engenharia Elétrica, Universidade Federal de Juiz de Fora (UFJF), Juiz de

Fora;^(b)Universidade Federal do Rio De Janeiro COPPE/EE/IF, Rio de Janeiro;^(c)Instituto de Física, Universidade de São Paulo, São Paulo;^(d)Rio de Janeiro State University, Rio de Janeiro;^(e)Federal University of Bahia, Bahia; Brazil.

⁸⁵KEK, High Energy Accelerator Research Organization, Tsukuba; Japan.

⁸⁶Graduate School of Science, Kobe University, Kobe; Japan.

⁸⁷(^a) AGH University of Krakow, Faculty of Physics and Applied Computer Science, Krakow;^(b)Marian Smoluchowski Institute of Physics, Jagiellonian University, Krakow; Poland.

⁸⁸Institute of Nuclear Physics Polish Academy of Sciences, Krakow; Poland.

⁸⁹Faculty of Science, Kyoto University, Kyoto; Japan.

⁹⁰Research Center for Advanced Particle Physics and Department of Physics, Kyushu University, Fukuoka ; Japan.

⁹¹L2IT, Université de Toulouse, CNRS/IN2P3, UPS, Toulouse; France.

⁹²Instituto de Física La Plata, Universidad Nacional de La Plata and CONICET, La Plata; Argentina.

⁹³Physics Department, Lancaster University, Lancaster; United Kingdom.

⁹⁴Oliver Lodge Laboratory, University of Liverpool, Liverpool; United Kingdom.

⁹⁵Department of Experimental Particle Physics, Jožef Stefan Institute and Department of Physics, University of Ljubljana, Ljubljana; Slovenia.

⁹⁶School of Physics and Astronomy, Queen Mary University of London, London; United Kingdom.

⁹⁷Department of Physics, Royal Holloway University of London, Egham; United Kingdom.

⁹⁸Department of Physics and Astronomy, University College London, London; United Kingdom.

⁹⁹Louisiana Tech University, Ruston LA; United States of America.

¹⁰⁰Fysiska institutionen, Lunds universitet, Lund; Sweden.

¹⁰¹Departamento de Física Teórica C-15 and CIAFF, Universidad Autónoma de Madrid, Madrid; Spain.

¹⁰²Institut für Physik, Universität Mainz, Mainz; Germany.

¹⁰³School of Physics and Astronomy, University of Manchester, Manchester; United Kingdom.

¹⁰⁴CPPM, Aix-Marseille Université, CNRS/IN2P3, Marseille; France.

¹⁰⁵Department of Physics, University of Massachusetts, Amherst MA; United States of America.

¹⁰⁶Department of Physics, McGill University, Montreal QC; Canada.

¹⁰⁷School of Physics, University of Melbourne, Victoria; Australia.

¹⁰⁸Department of Physics, University of Michigan, Ann Arbor MI; United States of America.

¹⁰⁹Department of Physics and Astronomy, Michigan State University, East Lansing MI; United States of America.

¹¹⁰Group of Particle Physics, University of Montreal, Montreal QC; Canada.

¹¹¹Fakultät für Physik, Ludwig-Maximilians-Universität München, München; Germany.

¹¹²Max-Planck-Institut für Physik (Werner-Heisenberg-Institut), München; Germany.

¹¹³Graduate School of Science and Kobayashi-Maskawa Institute, Nagoya University, Nagoya; Japan.

¹¹⁴(^a)Department of Physics, Nanjing University, Nanjing;^(b)School of Science, Shenzhen Campus of Sun Yat-sen University;^(c)University of Chinese Academy of Science (UCAS), Beijing; China.

¹¹⁵Department of Physics and Astronomy, University of New Mexico, Albuquerque NM; United States of America.

¹¹⁶Institute for Mathematics, Astrophysics and Particle Physics, Radboud University/Nikhef, Nijmegen; Netherlands.

¹¹⁷Nikhef National Institute for Subatomic Physics and University of Amsterdam, Amsterdam; Netherlands.

¹¹⁸Department of Physics, Northern Illinois University, DeKalb IL; United States of America.

¹¹⁹(^a)New York University Abu Dhabi, Abu Dhabi;^(b)United Arab Emirates University, Al Ain; United Arab Emirates.

- ¹²⁰Department of Physics, New York University, New York NY; United States of America.
- ¹²¹Ochanomizu University, Otsuka, Bunkyo-ku, Tokyo; Japan.
- ¹²²Ohio State University, Columbus OH; United States of America.
- ¹²³Homer L. Dodge Department of Physics and Astronomy, University of Oklahoma, Norman OK; United States of America.
- ¹²⁴Department of Physics, Oklahoma State University, Stillwater OK; United States of America.
- ¹²⁵Palacký University, Joint Laboratory of Optics, Olomouc; Czech Republic.
- ¹²⁶Institute for Fundamental Science, University of Oregon, Eugene, OR; United States of America.
- ¹²⁷Graduate School of Science, Osaka University, Osaka; Japan.
- ¹²⁸Department of Physics, University of Oslo, Oslo; Norway.
- ¹²⁹Department of Physics, Oxford University, Oxford; United Kingdom.
- ¹³⁰LPNHE, Sorbonne Université, Université Paris Cité, CNRS/IN2P3, Paris; France.
- ¹³¹Department of Physics, University of Pennsylvania, Philadelphia PA; United States of America.
- ¹³²Department of Physics and Astronomy, University of Pittsburgh, Pittsburgh PA; United States of America.
- ¹³³(^a)Laboratório de Instrumentação e Física Experimental de Partículas - LIP, Lisboa; (^b)Departamento de Física, Faculdade de Ciências, Universidade de Lisboa, Lisboa; (^c)Departamento de Física, Universidade de Coimbra, Coimbra; (^d)Centro de Física Nuclear da Universidade de Lisboa, Lisboa; (^e)Departamento de Física, Universidade do Minho, Braga; (^f)Departamento de Física Teórica y del Cosmos, Universidad de Granada, Granada (Spain); (^g)Departamento de Física, Instituto Superior Técnico, Universidade de Lisboa, Lisboa; Portugal.
- ¹³⁴Institute of Physics of the Czech Academy of Sciences, Prague; Czech Republic.
- ¹³⁵Czech Technical University in Prague, Prague; Czech Republic.
- ¹³⁶Charles University, Faculty of Mathematics and Physics, Prague; Czech Republic.
- ¹³⁷Particle Physics Department, Rutherford Appleton Laboratory, Didcot; United Kingdom.
- ¹³⁸IRFU, CEA, Université Paris-Saclay, Gif-sur-Yvette; France.
- ¹³⁹Santa Cruz Institute for Particle Physics, University of California Santa Cruz, Santa Cruz CA; United States of America.
- ¹⁴⁰(^a)Departamento de Física, Pontificia Universidad Católica de Chile, Santiago; (^b)Millennium Institute for Subatomic physics at high energy frontier (SAPHIR), Santiago; (^c)Instituto de Investigación Multidisciplinario en Ciencia y Tecnología, y Departamento de Física, Universidad de La Serena; (^d)Universidad Andres Bello, Department of Physics, Santiago; (^e)Instituto de Alta Investigación, Universidad de Tarapacá, Arica; (^f)Departamento de Física, Universidad Técnica Federico Santa María, Valparaíso; Chile.
- ¹⁴¹Department of Physics, Institute of Science, Tokyo; Japan.
- ¹⁴²Department of Physics, University of Washington, Seattle WA; United States of America.
- ¹⁴³Department of Physics and Astronomy, University of Sheffield, Sheffield; United Kingdom.
- ¹⁴⁴Department of Physics, Shinshu University, Nagano; Japan.
- ¹⁴⁵Department Physik, Universität Siegen, Siegen; Germany.
- ¹⁴⁶Department of Physics, Simon Fraser University, Burnaby BC; Canada.
- ¹⁴⁷SLAC National Accelerator Laboratory, Stanford CA; United States of America.
- ¹⁴⁸Department of Physics, Royal Institute of Technology, Stockholm; Sweden.
- ¹⁴⁹Departments of Physics and Astronomy, Stony Brook University, Stony Brook NY; United States of America.
- ¹⁵⁰Department of Physics and Astronomy, University of Sussex, Brighton; United Kingdom.
- ¹⁵¹School of Physics, University of Sydney, Sydney; Australia.
- ¹⁵²Institute of Physics, Academia Sinica, Taipei; Taiwan.

- ¹⁵³(*a*) E. Andronikashvili Institute of Physics, Iv. Javakhishvili Tbilisi State University, Tbilisi; (*b*) High Energy Physics Institute, Tbilisi State University, Tbilisi; (*c*) University of Georgia, Tbilisi; Georgia.
- ¹⁵⁴Department of Physics, Technion, Israel Institute of Technology, Haifa; Israel.
- ¹⁵⁵Raymond and Beverly Sackler School of Physics and Astronomy, Tel Aviv University, Tel Aviv; Israel.
- ¹⁵⁶Department of Physics, Aristotle University of Thessaloniki, Thessaloniki; Greece.
- ¹⁵⁷International Center for Elementary Particle Physics and Department of Physics, University of Tokyo, Tokyo; Japan.
- ¹⁵⁸Department of Physics, University of Toronto, Toronto ON; Canada.
- ¹⁵⁹(*a*) TRIUMF, Vancouver BC; (*b*) Department of Physics and Astronomy, York University, Toronto ON; Canada.
- ¹⁶⁰Division of Physics and Tomonaga Center for the History of the Universe, Faculty of Pure and Applied Sciences, University of Tsukuba, Tsukuba; Japan.
- ¹⁶¹Department of Physics and Astronomy, Tufts University, Medford MA; United States of America.
- ¹⁶²Department of Physics and Astronomy, University of California Irvine, Irvine CA; United States of America.
- ¹⁶³University of West Attica, Athens; Greece.
- ¹⁶⁴University of Sharjah, Sharjah; United Arab Emirates.
- ¹⁶⁵Department of Physics and Astronomy, University of Uppsala, Uppsala; Sweden.
- ¹⁶⁶Department of Physics, University of Illinois, Urbana IL; United States of America.
- ¹⁶⁷Instituto de Física Corpuscular (IFIC), Centro Mixto Universidad de Valencia - CSIC, Valencia; Spain.
- ¹⁶⁸Department of Physics, University of British Columbia, Vancouver BC; Canada.
- ¹⁶⁹Department of Physics and Astronomy, University of Victoria, Victoria BC; Canada.
- ¹⁷⁰Fakultät für Physik und Astronomie, Julius-Maximilians-Universität Würzburg, Würzburg; Germany.
- ¹⁷¹Department of Physics, University of Warwick, Coventry; United Kingdom.
- ¹⁷²Waseda University, Tokyo; Japan.
- ¹⁷³Department of Particle Physics and Astrophysics, Weizmann Institute of Science, Rehovot; Israel.
- ¹⁷⁴Department of Physics, University of Wisconsin, Madison WI; United States of America.
- ¹⁷⁵Fakultät für Mathematik und Naturwissenschaften, Fachgruppe Physik, Bergische Universität Wuppertal, Wuppertal; Germany.
- ¹⁷⁶Department of Physics, Yale University, New Haven CT; United States of America.
- ¹⁷⁷Yerevan Physics Institute, Yerevan; Armenia.
- a* Also Affiliated with an institute covered by a cooperation agreement with CERN.
- b* Also at An-Najah National University, Nablus; Palestine.
- c* Also at Borough of Manhattan Community College, City University of New York, New York NY; United States of America.
- d* Also at Center for High Energy Physics, Peking University; China.
- e* Also at Center for Interdisciplinary Research and Innovation (CIRI-AUTH), Thessaloniki; Greece.
- f* Also at CERN, Geneva; Switzerland.
- g* Also at CMD-AC UNEC Research Center, Azerbaijan State University of Economics (UNEC); Azerbaijan.
- h* Also at Département de Physique Nucléaire et Corpusculaire, Université de Genève, Genève; Switzerland.
- i* Also at Departament de Física de la Universitat Autònoma de Barcelona, Barcelona; Spain.
- j* Also at Department of Financial and Management Engineering, University of the Aegean, Chios; Greece.
- k* Also at Department of Mathematical Sciences, University of South Africa, Johannesburg; South Africa.
- l* Also at Department of Physics, Bolu Abant İzzet Baysal University, Bolu; Türkiye.
- m* Also at Department of Physics, California State University, Sacramento; United States of America.

- ⁿ Also at Department of Physics, King's College London, London; United Kingdom.
- ^o Also at Department of Physics, Stanford University, Stanford CA; United States of America.
- ^p Also at Department of Physics, Stellenbosch University; South Africa.
- ^q Also at Department of Physics, University of Fribourg, Fribourg; Switzerland.
- ^r Also at Department of Physics, University of Thessaly; Greece.
- ^s Also at Department of Physics, Westmont College, Santa Barbara; United States of America.
- ^t Also at Faculty of Physics, Sofia University, 'St. Kliment Ohridski', Sofia; Bulgaria.
- ^u Also at Hellenic Open University, Patras; Greece.
- ^v Also at Henan University; China.
- ^w Also at Imam Mohammad Ibn Saud Islamic University; Saudi Arabia.
- ^x Also at Institutio Catalana de Recerca i Estudis Avancats, ICREA, Barcelona; Spain.
- ^y Also at Institut für Experimentalphysik, Universität Hamburg, Hamburg; Germany.
- ^z Also at Institute for Nuclear Research and Nuclear Energy (INRNE) of the Bulgarian Academy of Sciences, Sofia; Bulgaria.
- ^{aa} Also at Institute of Applied Physics, Mohammed VI Polytechnic University, Ben Guerir; Morocco.
- ^{ab} Also at Institute of Particle Physics (IPP); Canada.
- ^{ac} Also at Institute of Physics, Azerbaijan Academy of Sciences, Baku; Azerbaijan.
- ^{ad} Also at National Institute of Physics, University of the Philippines Diliman (Philippines); Philippines.
- ^{ae} Also at Technical University of Munich, Munich; Germany.
- ^{af} Also at The Collaborative Innovation Center of Quantum Matter (CICQM), Beijing; China.
- ^{ag} Also at TRIUMF, Vancouver BC; Canada.
- ^{ah} Also at Università di Napoli Parthenope, Napoli; Italy.
- ^{ai} Also at University of Colorado Boulder, Department of Physics, Colorado; United States of America.
- ^{aj} Also at University of the Western Cape; South Africa.
- ^{ak} Also at Washington College, Chestertown, MD; United States of America.
- ^{al} Also at Yeditepe University, Physics Department, Istanbul; Türkiye.
- * Deceased