

Minkowski sum of fractal percolation and random sets

Tianyi Bai, Xinxin Chen, Yuval Peres

December 24, 2024

Abstract

In this paper, we prove that hitting probability of Minkowski sum of fractal percolations can be characterized by capacity. Then we extend this result to Minkowski sum of general random sets in \mathbb{Z}^d , including ranges of random walks and critical branching random walks, whose hitting probabilities are described by Newtonian capacity individually.

1 Introduction

Capacity is a concept from potential theory that is useful in studying long-range hitting probability of a set. Consider a finite set $A \subset \mathbb{Z}^d$, for each $0 < \beta < d$, the (discrete) Newtonian capacity with parameter β is

$$\mathbf{Cap}_\beta(A) := \left(\inf_{\mu} \sum_{x,y \in A} \mu(x)\mu(y)(|x-y| \vee 1)^{-\beta} \right)^{-1}, \quad (1.1)$$

where the infimum is taken over all probability measures μ on A , and $|x-y|$ means Euclidean distance. Let (S_n) be a simple random walk in \mathbb{Z}^d started from the origin, it is well-known that (see Lawler and Limic [9, Proposition 6.5.1]) if $0 \in A$ and $|x| \geq 2\text{diam}(A)$,

$$\mathbb{P}_0((S_n) \text{ hits } (x+A)) \asymp |x|^{2-d} \mathbf{Cap}_{d-2}(A), \quad (1.2)$$

where $\text{diam}(A)$ is the diameter of A , and the notation $f \asymp g$ means $C_1 g \leq f \leq C_2 g$ for some $C_1, C_2 > 0$ only depending on dimension d .

Recently, it is shown in Asselah, Okada, Schapira and Sousi [1, Theorem 1.6] that hitting probability estimates for Minkowski sum of simple random walks can be given in a similar pattern: Let $d > 2k$, let $\mathcal{R}_1, \dots, \mathcal{R}_k$ be the ranges of independent simple random walks, i.e.

$$\mathcal{R}_i = \{S_0^{(i)}, S_1^{(i)}, \dots\},$$

where for each $i = 1, 2, \dots, k$, $(S_n^{(i)})$ is a simple random walk started from $0 \in \mathbb{Z}^d$, independent of each other. For every finite set $A \subset \mathbb{Z}^d$ containing the origin, when $|x| \geq 2\text{diam}(A)$,

$$\mathbb{P}((\mathcal{R}_1 + \dots + \mathcal{R}_k) \cap (x + A) \neq \emptyset) \asymp |x|^{2k-d} \mathbf{Cap}_{d-2k}(A),$$

where Minkowski sum is defined by

$$A + B := \{a + b : a \in A, b \in B\}.$$

In this paper, we prove this phenomenon for any random set with property similar to (1.2).

Theorem 1.1. *Let $d, k \geq 1$, let $\alpha_1, \beta_1, \dots, \alpha_k, \beta_k \in (0, d)$ such that*

$$\alpha_1 + \dots + \alpha_k > (k-1)d,$$

$$\beta_1 + \dots + \beta_k > (k-1)d.$$

If $\mathcal{R}_1, \dots, \mathcal{R}_k$ are independent random sets in \mathbb{Z}^d with the following property: for every finite set $A \subset \mathbb{Z}^d$ containing the origin and every $|x| \geq 2\text{diam}(A)$, we have

$$\mathbb{P}(\mathcal{R}_i \cap (x + A) \neq \emptyset) \asymp |x|^{-\beta_i} \mathbf{Cap}_{\alpha_i}(A), \quad i = 1, \dots, k.$$

Then for every $|x|$ sufficiently large,

$$\mathbb{P}((\mathcal{R}_1 + \dots + \mathcal{R}_k) \cap (x + A) \neq \emptyset) \asymp |x|^{(k-1)d - \beta_1 - \dots - \beta_k} \mathbf{Cap}_{\alpha_1 + \dots + \alpha_k - (k-1)d}(A).$$

Here \asymp may rely on $d, k, (\alpha_i), (\beta_i)$.

Remark 1.2. Take $\alpha_i = \beta_i = d - 2$, and (\mathcal{R}_i) ranges of independent simple random walks, we deduce [1, Theorem 1.6] for large enough $|x|$.

Take $\alpha_i = d - 4, \beta_i = d - 2$, by Bai, Delmas and Hu [2, Theorem 1.1], we can also apply the theorem to ranges of independent critical branching random walks (\mathcal{R}_i) .

Remark 1.3. To be more precise, we need $|x|$ large enough so that

$$|x| \geq 2\text{diam}(A) + \max_{1 \leq i \leq k} \mathbb{1}_{\alpha_i \leq \beta_i} \text{diam}(A)^{\frac{d-\alpha_i}{d-\beta_i}} \log^{\frac{1}{d-\beta_i}}(\text{diam}(A) + 1),$$

see Section 3.3. In particular, if $\alpha_i > \beta_i$, it is enough to have $|x| \geq 2\text{diam}(A)$. When the sets (\mathcal{R}_i) are ranges of Markov processes (e.g. stable random walks), one may directly adapt the method of Section 2.3 to remove this restriction on $|x|$.

The main tool we use is fractal percolation, or Mandelbrot percolation:

Definition 1.4. Let $d \geq 1$, $p \in [0, 1]$. Consider the natural tiling of $[-\frac{1}{2}, \frac{1}{2}]^d$ by 2^d cubes congruent to $[0, \frac{1}{2}]^d$, we keep or discard these cubes independently with probability p , and let Z_1 be the collection of remaining cubes. Then we iterate the process, divide each cube in Z_k into 2^d smaller ones congruent to $[0, 2^{-k-1}]^d$, and keep each of them with probability p independently to obtain Z_{k+1} . Finally, we call

$$Q_d(p; k) := \left(\bigcup_{Q \in Z_k} 2^k Q \right) \cap \mathbb{Z}^d.$$

the discrete fractal percolation, and

$$Q_d(p) := \bigcap_{n \geq 1} \bigcup_{Q \in Z_n} \bar{Q}$$

the (continuous) fractal percolation.

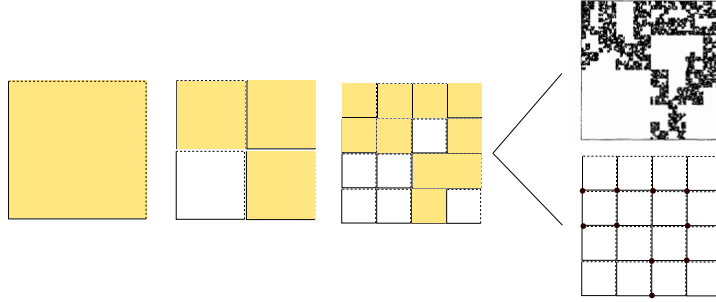

Figure 1: Demonstration for construction of fractal percolation. The continuous version is limit of (union of closure of) Z_k , and the discrete version is collection of lattice points in the rescaled $2^k Z_k$.

In particular, by Peres [13, Corollary 4.3], long-range hitting probabilities of fractal percolation are characterized by capacity in a similar way as (1.2): Let $d \geq 1$, $\beta > 0$, then for every $k \geq 1$ and $A \subset [-2^{k-1}, 2^{k-1}]^d \cap \mathbb{Z}^d$,

$$\mathbb{P}(Q_d(2^{-\beta}; k) \cap A \neq \emptyset) \asymp 2^{-\beta k} \text{Cap}_\beta(A), \quad (1.3)$$

where \asymp only depends on d, β (independent of k, A).

Our key result is the following estimate for sum of fractal percolations:

Theorem 1.5. Let $d \geq 1$. Let $p, q \in (0, 1)$ such that

$$\beta := -\log_2(2^d pq) > 0, \quad p, q > 2^{-d}, \quad (1.4)$$

let Q_d, \hat{Q}_d be two independent fractal percolations, then for every $1 \leq m \leq n$ and every nonempty set $A \subset [-2^{n-1}, 2^{n-1}]^d \cap \mathbb{Z}^d$,

$$(2^d p)^m \lesssim \frac{\mathbb{P}((Q_d(p; m) + \hat{Q}_d(q; n)) \cap A \neq \emptyset)}{q^n \text{Cap}_\beta(A)} \lesssim (2^d p)^{m \vee \log_2 \text{diam}(A)}.$$

Here \lesssim only depends on d, p, q (independent of m, n, A).

Remark 1.6. As has been observed in [13], the number of cubes in $(Q_d(p; k))_{k \geq 1}$ forms a branching process, with average offspring $2^d p$. When $2^d p > 1$, this branching process is supercritical, so each $Q_d(p; k)$, as well as the limit $Q_d(p)$, is nonempty with a positive probability bounded uniformly from below. When $2^d p \leq 1$, the branching process is subcritical or critical, and the nonempty probability of $Q_d(p; k)$ decays to 0 as $k \rightarrow \infty$, making our hitting events trivial. Therefore we need $p, q > 2^{-d}$ in (1.4). See also Section 3.4 for a brief discussion on the condition $\beta > 0$.

Except for proving Theorem 1.1, Theorem 1.5 itself has some interesting consequences. Firstly, we may take $m = n$, and consider the continuous limit when $m, n \rightarrow \infty$. Here we abuse the notation $\text{Cap}_\beta(\cdot)$ for Newtonian capacity of a compact set $\Lambda \subset \mathbb{R}^d$,

$$\text{Cap}_\beta(\Lambda) := \left(\inf_{\mu} \int_{x, y \in \Lambda} |x - y|^{-\beta} \mu(dx) \mu(dy) \right)^{-1}.$$

Corollary 1.7. *Let $d \geq 1$, let $p, q \in (0, 1)$ satisfy (1.4). For every $n \geq 1$ and every $A \subset [-2^{n-1}, 2^{n-1}]^d \cap \mathbb{Z}^d$,*

$$\mathbb{P}((Q_d(p; n) + \widehat{Q}_d(q; n)) \cap A \neq \emptyset) \asymp \mathbb{P}(Q_d(2^d pq; n) \cap A \neq \emptyset). \quad (1.5)$$

Moreover, for every closed set $\Lambda \subset [-\frac{1}{2}, \frac{1}{2}]^d$,

$$\mathbb{P}((Q_d(p) + \widehat{Q}_d(q)) \cap \Lambda \neq \emptyset) \asymp \text{Cap}_\beta(\Lambda) \asymp \mathbb{P}(Q_d(2^d pq) \cap \Lambda \neq \emptyset). \quad (1.6)$$

Here \asymp only depends on d, p, q (independent of Λ).

Corollary 1.7 means the random set $Q_d(p) + \widehat{Q}_d(q)$ is comparable to $Q_d(2^d pq)$, and a phase transition takes place when $2^d pq = 1$. This phenomenon has been noticed since Larsson [7], and has been studied in terms of fractal geometry when $d = 1$ in Dekking and Simon [4].

Secondly, we may fix m and let $n \rightarrow \infty$ in Theorem 1.5 to obtain a comparison between two capacities,

Corollary 1.8. *Let $0 < a < b < d$. For every nonempty finite set $A \subset \mathbb{Z}^d$ and every $m \geq 1$,*

$$2^{(a-b)(m \vee \log_2 \text{diam}(A))} \lesssim \frac{\text{Cap}_a(A)}{\mathbb{E}[\text{Cap}_b(A + Q_d(2^{b-a-d}, m))]} \lesssim 2^{(a-b)m}.$$

For every nonempty closed set $\Lambda \subset [0, 1]^d$,

$$\frac{\text{Cap}_a(\Lambda)}{\mathbb{E}[\text{Cap}_b(\Lambda + Q_d(2^{b-a-d}))]} \asymp 1.$$

Here \lesssim and \asymp may rely on d, a, b .

Studies of fractal percolation date back to Mandelbrot [11]. In particular, its relation to capacity in terms of hitting probability was discovered in [13]. Minkowski sum of sets is equivalent to algebraic difference,

$$A - B := \{a - b, a \in A, b \in B\},$$

and this structure for Cantor sets was first introduced in Palis [12], and adapted to random cases in [7]. The sum of fractal percolations in dimension $d = 1$ (Mandelbrot cascades) was considered in [4]. More recently, sum of simple random walks was studied in [1]. Notably, fractal percolation methods can also be used to give intersection probability estimates for random walks (Lawler [8]), branching random walks (Baran [3]), as well as in continuous regime for Brownian motions and Brownian sheets (Khoshnevisan and Shi [6]).

The paper is outlined as follows. In Section 2 we prove Theorem 1.5 in a few steps:

- We first introduce in Section 2.1 that, fractal percolation is equivalent to percolation on a tree.
- Then we show in Section 2.2 that lower bound of Theorem 1.5 follows by a standard second moment method.
- In Section 2.3, we observe that sum of fractal percolation can be described using product of two Markov chains, and one can apply a method first introduced in Fitzsimmons and Salisbury [5] and Salisbury [14], later simplified in Lyons, Peres and Schramm [10] to study product of Markov chains.
- Finally we prove the upper bound of Theorem 1.5 in Section 2.4.

In Section 3.1-3.3, we prove Corollary 1.7, Corollary 1.8 and Theorem 1.1 respectively, and we end the paper in Section 3.4 by a brief discussion on sum of fractal percolations with parameters not covered by (1.4).

2 Proof of Theorem 1.5

For each $k \geq 1$, we abbreviate the centered discrete cube with side length 2^k by

$$\Delta_k := [-2^{k-1}, 2^{k-1}]^d \cap \mathbb{Z}^d.$$

2.1 Percolation on tree

Our first observation is that (discrete) fractal percolation $Q_d(p; k)$ on Δ_k can be described by the Bernoulli bond percolation on a (finite) 2^d -ary tree defined as follows, see Figure 2 for demonstration.

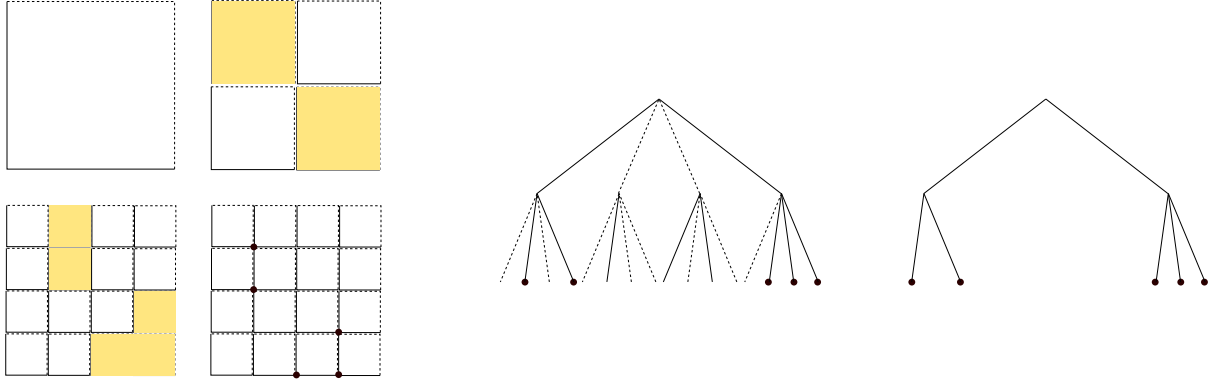

Figure 2: An illustration of $Q_k(p)$ and its corresponding percolation on $\Gamma^{(k)}$.

Definition 2.1. Let $\Xi = \{0, 1\}^d$ be our alphabet (heuristically, we use Ξ to represent the 2^d small cubes when cutting one cube into half size). For $j \geq 1$, let Ξ^j denote words $(\theta_1, \dots, \theta_j)$ with $\theta_1, \dots, \theta_j \in \Xi$. By convention, let $\Xi^0 := \{\emptyset\}$, let

$$\mathbf{0}_d = (0, \dots, 0), \mathbf{1}_d = (1, \dots, 1) \in \Xi.$$

Denote by $\Gamma^{(k)}$ a 2^d -ary tree of height k with vertices labelled by $\Xi^0 \cup \dots \cup \Xi^k$: the tree is rooted at $\emptyset \in \Xi^0$, and for each $j = 1, 2, \dots, k$, generation j of the tree is given by Ξ^j , with an edge connecting $(\theta_1, \dots, \theta_j) \in \Xi^j$ to its parent $(\theta_1, \dots, \theta_{j-1})$.

For each particle $(\theta_1, \dots, \theta_j) \in \Xi^j$, let

$$\mathcal{R}_k(\theta_1, \dots, \theta_j) := -2^{k-1} \mathbf{1}_d + \sum_{i=1}^j 2^{k-i} \theta_i + \Delta_{k-j} \subset \mathbb{Z}^d.$$

This gives a bijection between Ξ^j and the natural tiling of Δ_k by blocks of size Δ_{k-j} .

On $\Gamma^{(k)}$, we perform Bernoulli bond percolation with parameter p , that is, we independently keep each edge open with probability p , closed with probability $1 - p$, and let

$$O_j := \{\theta = (\theta_1, \dots, \theta_j) : \text{there is an open path between } \emptyset \text{ and } \theta\}.$$

Under a suitable coupling probability measure, \mathcal{R}_k gives a bijection between O_j and $2^k Z_j$, where we recall Z_j from Definition 1.4.

In other words, we may take a coupling probability measure \mathbb{P} under which

$$O_j = \mathcal{R}_k^{-1}(2^k Z_j), \quad j = 1, 2, \dots, k.$$

In particular, when $j = k$,

there is an open path between \emptyset and $(\theta_1, \dots, \theta_k) \iff \mathcal{R}_k((\theta_1, \dots, \theta_k)) \in Q_d(p; k)$.
(2.7)

As a direct application, we have the following estimates for fractal percolation:

Lemma 2.2. *For any $x, y \in \Delta_k$,*

$$\mathbb{P}(x \in Q_d(p; k)) = p^k,$$

$$\mathbb{P}(x, y \in Q_d(p; k)) \leq p^{k + \log_2 |x-y| - \frac{1}{2} \log_2 d}.$$

Proof. The first equation is clear, because $x \in Q_d(p; k)$ means all the k edges on the path from \emptyset to $\mathcal{R}_k^{-1}(x)$ are open, which happens with probability p^k .

For the second, denote by θ the common ancestor of $\mathcal{R}_k^{-1}(x)$ and $\mathcal{R}_k^{-1}(y)$, and by h the length from θ to $\mathcal{R}_k^{-1}(x)$, then it is immediate that

$$\mathbb{P}(x, y \in Q_d(p; k)) = p^{k+h}.$$

Moreover, $\mathcal{R}_k(\theta)$ is congruent to Δ_h , so the distance between $x, y \in \mathcal{R}_k(\theta)$ is bounded by

$$|x - y| \leq \sqrt{d} 2^h, \quad (2.8)$$

as shown in Figure 3. □

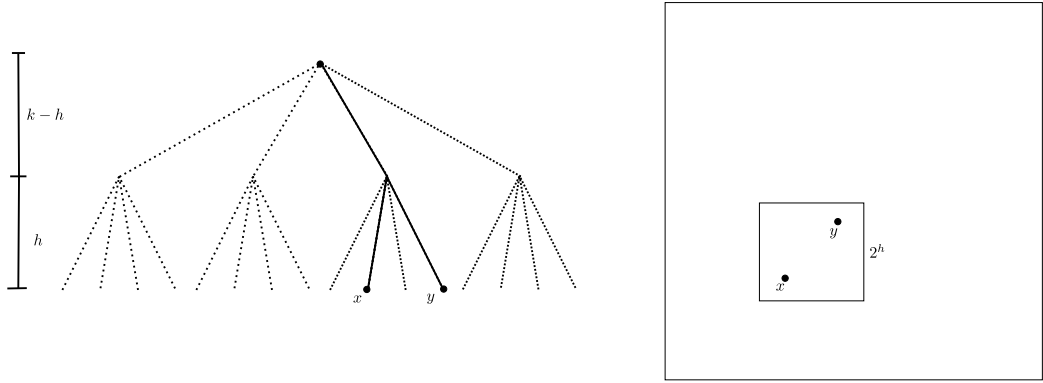

Figure 3: Illustration for Lemma 2.2. On the tree $\Gamma^{(k)}$, two points corresponding to x, y has common ancestor of height h . In \mathbb{Z}^d , x, y fall into a cube congruent to Δ_h .

2.2 Lower bound of Theorem 1.5

We are now ready to give the lower bound of Theorem 1.5 by a standard second moment method. For later usage, we slightly extend the domain where the target set stays.

Lemma 2.3. *Let $d \geq 1$, $\lambda \in [0, 1)$. Let $p, q \in (0, 1)$ with property (1.4). For every $1 \leq m \leq n$ and every finite set $A \subset [-2^{n-1} - \lambda 2^{m-1}, 2^{n-1} + \lambda 2^{m-1}]^d \cap \mathbb{Z}^d$,*

$$\mathbb{P}((Q_d(p; m) + \widehat{Q}_d(q; n)) \cap A \neq \emptyset) \gtrsim (2^d p)^m q^n \text{Cap}_\beta(A).$$

Here \gtrsim relies on d, λ, p, q .

Proof. By definition of Cap_β in (1.1), it suffices to show that for any probability measure μ supported on A ,

$$\mathbb{P}((Q_d(p; m) + \widehat{Q}_d(q; n)) \cap A \neq \emptyset) \gtrsim (2^d p)^m q^n \left(\sum_{a, b \in A} \mu(a) \mu(b) |a - b|^{-\beta} \right)^{-1}. \quad (2.9)$$

Arbitrarily fix μ , let

$$L_\mu := \sum_{a \in A} \mu(a) \sum_{x \in \mathbb{Z}^d} \mathbb{1}_{x \in Q_d(p; m), a - x \in \widehat{Q}_d(q; n)}.$$

By Paley-Zygmund inequality,

$$\mathbb{P}((Q_d(p; m) + \widehat{Q}_d(q; n)) \cap A \neq \emptyset) \geq \mathbb{P}(L_\mu > 0) \geq \frac{(\mathbb{E}[L_\mu])^2}{\mathbb{E}[L_\mu^2]}. \quad (2.10)$$

Observe that uniformly in $a \in A$, (here \asymp depends on λ , in particular it requires the condition $\lambda < 1$)

$$\#\{x \in \mathbb{Z}^d : x \in \Delta_m, a - x \in \Delta_n\} \asymp 2^{dm}. \quad (2.11)$$

Therefore by Lemma 2.2,

$$\mathbb{E}[L_\mu] = \sum_{a \in A} \mu(a) \sum_{x \in \Delta_m} \mathbb{P}(x \in Q_d(p; m)) \mathbb{P}(a - x \in \widehat{Q}_d(q; n)) \gtrsim 2^{dm} p^m q^n. \quad (2.12)$$

Moreover, apply Lemma 2.2 again, we have

$$\begin{aligned} \mathbb{E}[L_\mu^2] &= \sum_{a, b \in A} \mu(a) \mu(b) \sum_{x, y \in \mathbb{Z}^d} \mathbb{P}(x, y \in Q_d(p; m)) \mathbb{P}(a - x, b - y \in \widehat{Q}_d(q; n)) \\ &\lesssim \sum_{a, b \in A} \mu(a) \mu(b) \sum_{x, y \in \mathbb{Z}^d} p^{m + \log_2 |x - y|} q^{n + \log_2 |a - x + y - b|} \mathbb{1}_{x, y \in \Delta_m} \mathbb{1}_{a - x, b - y \in \Delta_n} \\ &\lesssim 2^{dm} p^m q^n \sum_{a, b \in A} \mu(a) \mu(b) \sum_{z \in \Delta_{m+1}} p^{\log_2 |z|} q^{\log_2 |a - b - z|}, \end{aligned}$$

where in the last step we change variable $z = x - y \in \Delta_{m+1}$.

By (1.4), we can expand the sum on z and continue the calculation above,

$$\begin{aligned}
\mathbb{E}[L_\mu^2] &\lesssim 2^{dm} p^m q^n \sum_{a,b \in A} \mu(a)\mu(b) \sum_{z \in \Delta_{m+1}} p^{\log_2 |z|} q^{\log_2 |a-b-z|} \\
&\lesssim 2^{dm} p^m q^n \sum_{a,b \in A} \mu(a)\mu(b) (2^d p)^{(m \wedge \log_2 |a-b|)} q^{\log_2 |a-b|} \mathbb{1}_{a \neq b} \quad (2.13) \\
&\lesssim 2^{dm} p^m q^n \sum_{a,b \in A} \mu(a)\mu(b) |a-b|^{-\beta} \mathbb{1}_{a \neq b}.
\end{aligned}$$

Combine (2.10), (2.12) and (2.13), and the conclusion follows. \square

2.3 Relation with Markov chain

The percolation on $\Gamma^{(k)}$ in Section 2.1 can be identified by the following sequence $(Y_i^{(k)})_{i=1,2,\dots,2^{dk}}$.

Definition 2.4. Fix a percolation on $\Gamma^{(k)}$. We list all the 2^{dk} elements of $\Xi^k \subset \Gamma^{(k)}$ of the tree in lexicographical order,

$$u_1 = (\mathbf{0}_d, \dots, \mathbf{0}_d), u_2, \dots, u_{2^{dk}} = (\mathbf{1}_d, \dots, \mathbf{1}_d) \in \Xi^k. \quad (2.14)$$

For each $1 \leq i \leq 2^{dk}$, the path from \emptyset to u_i on the tree has length k , and we define $Y_i^{(k)} = (y_{i1}, \dots, y_{ik}) \in \{0, 1\}^k$, where

$$y_{ij} := \mathbb{1}_{\{\text{The } j\text{-th step in the path from } \emptyset \text{ to } u_i \text{ is open}\}}.$$

In particular,

$$Y_i^{(k)} = (1, 1, \dots, 1) \iff \text{There is an open path between } \emptyset \text{ and } u_i. \quad (2.15)$$

By construction, it is immediate that

Lemma 2.5. Let \mathbb{P} be the law under which we have Bernoulli bound percolation on $\Gamma^{(k)}$ with parameter p . Under \mathbb{P} , $(Y_i^{(k)})_i$ is a Markov chain.

Finally, we cite the following theorem on general Markov chains from [10], which is a simplified version of the method first introduced in [5], see also [14, Theorem 2], and shall provide an important bound on hitting probability estimates of fractal percolation.

Theorem 2.6. Let $(X_n)_{n \in \mathbb{N}}$, $(Y_n)_{n \in \mathbb{N}}$ be two independent Markov chains with the same state space \mathcal{S} . For any set

$$K \subset \{(i, j; x, y) : i, j \in \mathbb{N}, x, y \in \mathcal{S}\},$$

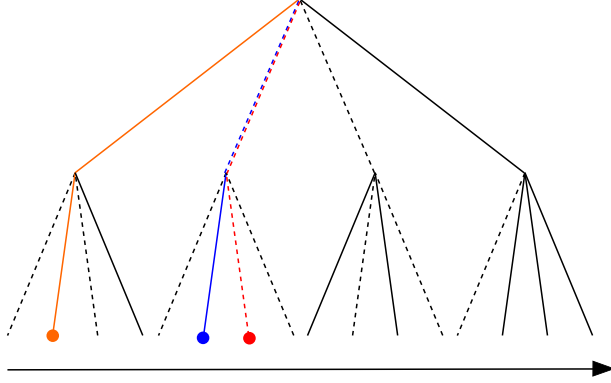

Figure 4: In this picture we list (u_i) for $\Gamma^{(2)}$ from left to right. Here the colored paths correspond to $Y_2^{(2)} = (1, 1), Y_6^{(2)} = (0, 1), Y_7^{(2)} = (0, 0)$.

if

$$\mathbb{P}(\exists i, j, (i, j; X_i, Y_j) \in K) > 0,$$

then there are explicit nonnegative coefficients (a_{ijxy}) such that

$$\frac{\mathbb{E}[S_K]^2}{\mathbb{E}[S_K^2]} \leq \mathbb{P}(\exists i, j, (i, j; X_i, Y_j) \in K) \leq 64 \frac{\mathbb{E}[S_K]^2}{\mathbb{E}[S_K^2]},$$

where

$$S_K := \sum_{(i,j;x,y) \in K} a_{ijxy} \mathbb{1}_{X_i=x, Y_j=y},$$

Proof. The theorem is [10, Theorem 3.1], and the explicit construction for S_K is given in [10, Page 7] by

$$a_{ijxy} = \mathbb{P}(\tau = i, \lambda = j \mid X_i = x, Y_j = y),$$

where

$$\tau := \min\{i : \exists j, (i, j; X_i, Y_j) \in K\},$$

$$\lambda := \min\{j : (\tau, j; X_\tau, Y_j) \in K\}.$$

□

2.4 Upper bound of Theorem 1.5

For simplicity, we shall denote

$$i \oplus j := \mathcal{R}_m(u_i) + \mathcal{R}_n(\hat{u}_j) \in \mathbb{Z}^d$$

for every $1 \leq i \leq 2^{dm}, 1 \leq j \leq 2^{dn}$, where (u_i) and (\hat{u}_j) enumerate the elements in the last generation of $\Gamma^{(m)}$ and $\Gamma^{(n)}$, as in Definition 2.4. We also denote by $h_{i' i}^m$ (similarly for $h_{j' j}^n$) the graph distance from u_i to common ancestor of u_i and $u_{i'}$ in $\Gamma^{(m)}$, as shown in Figure 5.

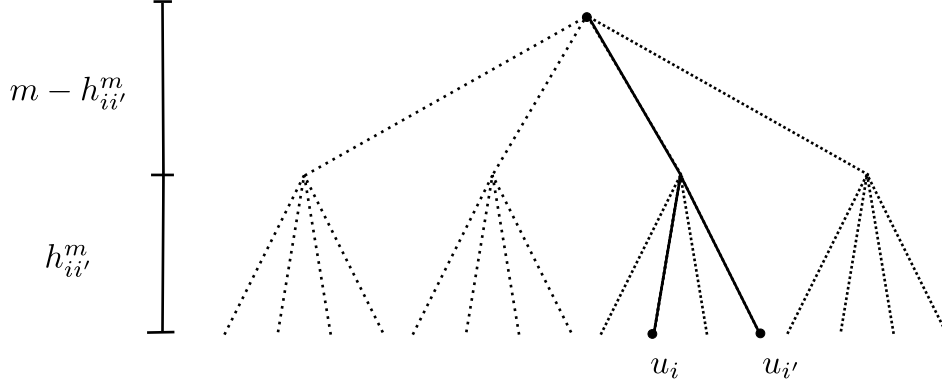

Figure 5: Illustration for $h_{ii'}^m$, u_i , and $u_{i'}$.

Lemma 2.7. *Let $d \geq 1$, let $p, q \in (0, 1)$ with property (1.4). For every $1 \leq m \leq n$ and every finite set $A \subset [-2^{n-1} - 2^{m-1}, 2^{n-1} + 2^{m-1}]^d \cap \mathbb{Z}^d$, there is a family of nonnegative coefficients $(a_{ij})_{1 \leq i \leq 2^{dm}, 1 \leq j \leq 2^{dn}}$ such that*

$$a_{ij} = 0 \text{ when } i \oplus j \notin A, \quad \sum_{i,j} a_{ij} = 1, \quad (2.16)$$

and

$$\mathbb{P}\left(\left(Q_d(p; m) + \widehat{Q}_d(q; n)\right) \cap A \neq \emptyset\right) \leq 64p^m q^n \left(\sum_{i, i', j, j'} a_{ij} a_{i'j'} p^{h_{ii'}^m} q^{h_{jj'}^n} \right)^{-1}.$$

Proof. Let Y and \widehat{Y} be the Markov chains of Lemma 2.5 associated with $Q_d(p; m)$ and $\widehat{Q}_d(q; n)$. Abbreviate $\mathbf{1}_k := (1, 1, \dots, 1)$ for k consecutive 1s.

We apply Theorem 2.6 to them together with the set

$$K := \{(i, j; \mathbf{1}_m, \mathbf{1}_n) : i \oplus j \in A\},$$

then there are nonnegative coefficients (a_{ij}) such that

$$\mathbb{P}\left(\exists i, j, Y_i = \mathbf{1}_m, \widehat{Y}_j = \mathbf{1}_n, i \oplus j \in A\right) \leq 64 \frac{\mathbb{E}[S_A]^2}{\mathbb{E}[S_A^2]},$$

where

$$S_A = \sum_{i,j} a_{ij} \mathbb{1}_{Y_i = \mathbf{1}_m, \widehat{Y}_j = \mathbf{1}_n} \mathbb{1}_{i \oplus j \in A}.$$

By (2.7) and (2.15),

$$Y_i = \mathbf{1}_m, \widehat{Y}_j = \mathbf{1}_n \iff \mathcal{R}_m(u_i) \in Q_d(p; m), \mathcal{R}_n(\widehat{u}_j) \in \widehat{Q}_d(q; n),$$

so we obtain

$$\mathbb{P}\left((Q_d(p; m) + \widehat{Q}_d(q; n)) \cap A \neq \emptyset\right) \leq 64 \frac{\mathbb{E}[S_A]^2}{\mathbb{E}[S_A^2]}. \quad (2.17)$$

Note that $\frac{\mathbb{E}[S_A]^2}{\mathbb{E}[S_A^2]}$ does not change if we replace (a_{ij}) by its multiple (ca_{ij}) , and does not change if we change a_{ij} for some index $i \oplus j \notin A$, we can modify these coefficients to fit (2.16).

Finally, we expand

$$\mathbb{E}[S_A] = \sum_{i,j} a_{ij} \mathbb{P}(Y_i = \mathbf{1}_m, \widehat{Y}_j = \mathbf{1}_n) = p^m q^n,$$

and

$$\begin{aligned} \mathbb{E}[S_A^2] &= \sum_{i,i',j,j'} a_{ij} a_{i'j'} \mathbb{P}(Y_i = Y_{i'} = \mathbf{1}_m) \mathbb{P}(\widehat{Y}_j = \widehat{Y}_{j'} = \mathbf{1}_n) \\ &= \sum_{i,i',j,j'} a_{ij} a_{i'j'} p^{m+h_{ii'}^m} q^{n+h_{jj'}^n}. \end{aligned}$$

The conclusion follows by putting these equations into (2.17). \square

Lemma 2.8. *Let $d \geq 1$, let $p, q \in (0, 1)$ with property (1.4). Let $1 \leq m \leq n$ and $A \subset [-2^{n-1} - 2^{m-1}, 2^{n-1} + 2^{m-1}]^d \subset \mathbb{Z}^d$. Let (a_{ij}) be any collection of nonnegative coefficients satisfying (2.16), then*

$$(2^d p)^{\log_2 \text{diam}(A) \vee m} \sum_{i,i',j,j'} a_{ij} a_{i'j'} p^{h_{ii'}^m} q^{h_{jj'}^n} \gtrsim p^m \sum_{i,i',j,j'} a_{ij} a_{i'j'} |i \oplus j - i' \oplus j'|^{-\beta}.$$

Here \gtrsim only depend on d, p, q (independent of m, n, A).

Proof. We claim that

$$\begin{aligned} 1. \quad & 2^{dm} \sum_{i,i',j,j'} a_{ij} a_{i'j'} p^{h_{ii'}^m} q^{h_{jj'}^n} \\ & \gtrsim \sum_{i,i',j,j': |\mathcal{R}_n(\widehat{u}_j) - \mathcal{R}_n(\widehat{u}_{j'})| \leq 2\sqrt{d}2^m} a_{ij} a_{i'j'} |i \oplus j - i' \oplus j'|^{-\beta}. \end{aligned} \quad (2.18)$$

2. If $m < \log_2 \text{diam}(A)$, then

$$\begin{aligned} & (2^d p)^{\log_2 \text{diam}(A)} \sum_{i,i',j,j'} a_{ij} a_{i'j'} p^{h_{ii'}^m} q^{h_{jj'}^n} \\ & \gtrsim p^m \sum_{i,i',j,j': |\mathcal{R}_n(\widehat{u}_j) - \mathcal{R}_n(\widehat{u}_{j'})| \geq 2\sqrt{d}2^m} a_{ij} a_{i'j'} |i \oplus j - i' \oplus j'|^{-\beta}, \end{aligned} \quad (2.19)$$

Let us first demonstrate that these claims are sufficient to give Lemma 2.8. In fact, if $m \geq \log_2 \text{diam}(A)$, then the condition $|\mathcal{R}_n(\hat{u}_j) - \mathcal{R}_n(\hat{u}_{j'})| \leq 2\sqrt{d}2^m$ trivially includes every choice of $(\hat{u}_j, \hat{u}_{j'})$ such that $i \oplus j, i' \oplus j' \in A$, because

$$\begin{aligned} |\mathcal{R}_n(\hat{u}_j) - \mathcal{R}_n(\hat{u}_{j'})| &\leq |i \oplus j - i' \oplus j'| + |\mathcal{R}_m(u_i) - \mathcal{R}_m(u_{i'})| \\ &\leq \text{diam}(A) + \sqrt{d}2^m \leq 2\sqrt{d}2^m. \end{aligned}$$

Therefore, (2.18) is already our desired result. If $m < \log_2 \text{diam}(A)$, then $(2^d p)^m < (2^d p)^{\log_2 \text{diam}(A)}$ (recall by (1.4) that $2^d p > 1$), and the conclusion follows by adding (2.18) and (2.19).

Let us begin by proving (2.19), given that $m < \log_2 \text{diam}(A)$. By the trivial bound $p^{h_{ii'}} \geq p^m$, it suffices to show that

$$\begin{aligned} &(2^d p)^{\log_2 \text{diam}(A)} \sum_{i, i', j, j'} a_{ij} a_{i'j'} q^{h_{jj'}^n} \\ &\gtrsim \sum_{i, i', j, j': |\mathcal{R}_n(\hat{u}_j) - \mathcal{R}_n(\hat{u}_{j'})| \geq 2\sqrt{d}2^m} a_{ij} a_{i'j'} |i \oplus j - i' \oplus j'|^{-\beta}, \end{aligned} \quad (2.20)$$

where we recall that $\beta = -\log_2(2^d p q) > 0$. Since (a_{ij}) is supported on those (i, j) with $i \oplus j \in A$, and $2^d p > 1$, we can simplify the right hand side by

$$\begin{aligned} &\text{RHS}_{(2.20)} \\ &= \sum_{i, i', j, j': |\mathcal{R}_n(\hat{u}_j) - \mathcal{R}_n(\hat{u}_{j'})| \geq 2\sqrt{d}2^m} a_{ij} a_{i'j'} (2^d p q)^{\log_2 |i \oplus j - i' \oplus j'|} \\ &\leq (2^d p)^{\log_2 \text{diam}(A)} \sum_{i, i', j, j': |\mathcal{R}_n(\hat{u}_j) - \mathcal{R}_n(\hat{u}_{j'})| \geq 2\sqrt{d}2^m} a_{ij} a_{i'j'} q^{\log_2 |i \oplus j - i' \oplus j'|}. \end{aligned}$$

Note that for each i, i' , $|\mathcal{R}_m(u_i) - \mathcal{R}_m(u_{i'})| \leq \sqrt{d}2^m$ because they live in Δ_m . Therefore, $|\mathcal{R}_n(\hat{u}_j) - \mathcal{R}_n(\hat{u}_{j'})| \geq 2\sqrt{d}2^m$ implies

$$|i \oplus j - i' \oplus j'| \geq \frac{1}{2} |\mathcal{R}_n(\hat{u}_j) - \mathcal{R}_n(\hat{u}_{j'})|,$$

so we further simplify

$$\begin{aligned} &\text{RHS}_{(2.20)} \\ &\lesssim (2^d p)^{\log_2 \text{diam}(A)} \sum_{i, i', j, j': |\mathcal{R}_n(\hat{u}_j) - \mathcal{R}_n(\hat{u}_{j'})| \geq 2\sqrt{d}2^m} a_{ij} a_{i'j'} q^{\log_2 |\mathcal{R}_n(\hat{u}_j) - \mathcal{R}_n(\hat{u}_{j'})|} \\ &\leq (2^d p)^{\log_2 \text{diam}(A)} \sum_{i, i', j, j'} a_{ij} a_{i'j'} |\mathcal{R}_n(\hat{u}_j) - \mathcal{R}_n(\hat{u}_{j'})|^{\log_2 q}. \end{aligned}$$

Put this into (2.20), it now suffices to show

$$\sum_{i, i', j, j'} a_{ij} a_{i'j'} q^{h_{jj'}^n} \gtrsim \sum_{i, i', j, j'} a_{ij} a_{i'j'} |\mathcal{R}_n(\hat{u}_j) - \mathcal{R}_n(\hat{u}_{j'})|^{\log_2 q},$$

and this is known by [13, Theorem 4.2]. Hence we have proved (2.19).

It remains to prove (2.18). Denote by $|v|$ the generation (distance to the root) of a vertex v in a tree, and denote

$$a_{[v][\widehat{v}]} = \sum_{i \succeq v, j \succeq \widehat{v}} a_{ij},$$

then we can bound the sum in left-hand side of (2.18) by

$$\begin{aligned} 2^{-dm} \text{LHS}_{(2.18)} &= \sum_{i, i', j, j'} a_{ij} a_{i'j'} p^{h_{ii'}} q^{h_{jj'}} \\ &\gtrsim \sum_{v \in \Gamma^{(m)}, \widehat{v} \in \Gamma^{(n)}} p^{m-|v|} q^{n-|\widehat{v}|} \sum_{i, i' \succeq v, j, j' \succeq \widehat{v}} a_{ij} a_{i'j'} \\ &\gtrsim \sum_{h=0}^m \sum_{|v|=m-h, |\widehat{v}|=n-h} p^h q^h \sum_{i, i' \succeq v, j, j' \succeq \widehat{v}} a_{ij} a_{i'j'} \\ &= \sum_{h=0}^m \sum_{|v|=m-h, |\widehat{v}|=n-h} p^h q^h a_{[v][\widehat{v}]}^2, \end{aligned} \quad (2.21)$$

where in the second line we are summing over each vertex v (and \widehat{v}) on the path from root to common ancestor of $u_i, u_{i'}$ (and $\widehat{u}_j, \widehat{u}_{j'}$).

For each $h = 0, 1, \dots, m$, we say four vertices (x, y, z, w) are h -regular, if x, y are in the $(m-h)$ -th generation of $\Gamma^{(m)}$, z, w are in the $(n-h)$ -th generation of $\Gamma^{(n)}$, and there exists a quadruple (i, i', j, j') such that (x, y, z, w) are ancestors of $(u_i, u_{i'}, u_j, u_{j'})$ respectively (denoted by $(x, y, z, w) \preceq (i, i', j, j')$), and

$$|i \oplus j - i' \oplus j'| \leq 3\sqrt{d}2^h. \quad (2.22)$$

Denote by Θ_h the collection of all h -regular quadruples, as illustrated in Figure 6.

We observe from the definition of Θ_h that,

$$\begin{aligned} &\sum_{h=0}^m \sum_{(x, y, z, w) \in \Theta_h} \sum_{(i, i', j, j') \succeq (x, y, z, w)} 2^{-\beta h} a_{ij} a_{i'j'} \\ &\geq \sum_{h=0}^m \sum_{(x, y, z, w) \in \Theta_h} \sum_{(i, i', j, j') \succeq (x, y, z, w)} 2^{-\beta h} a_{ij} a_{i'j'} \mathbb{1}_{\{|i \oplus j - i' \oplus j'| \leq 3\sqrt{d}2^h\}} \\ &= \sum_{i, i', j, j'} a_{ij} a_{i'j'} \sum_{h=0}^m 2^{-\beta h} \mathbb{1}_{\{|i \oplus j - i' \oplus j'| \leq 3\sqrt{d}2^h\}} \\ &\gtrsim \sum_{i, i', j, j': |i \oplus j - i' \oplus j'| \leq 3\sqrt{d}2^m} a_{ij} a_{i'j'} \cdot (|i \oplus j - i' \oplus j'|)^{-\beta} \gtrsim \text{RHS}_{(2.18)}. \end{aligned} \quad (2.23)$$

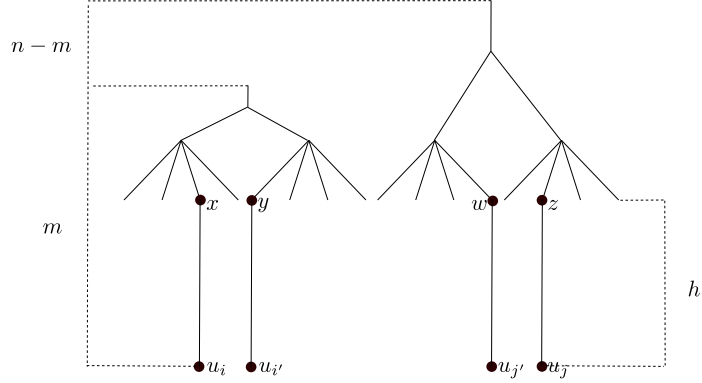

Figure 6: Illustration of $(x, y, z, w) \in \Theta_h$.

Moreover,

$$\begin{aligned}
& \sum_{h=0}^m \sum_{(x,y,z,w) \in \Theta_h} \sum_{(i,i',j,j') \succeq (x,y,z,w)} 2^{-\beta h} a_{ij} a_{i'j'} \\
&= \sum_{h=0}^m \sum_{(x,y,z,w) \in \Theta_h} 2^{-\beta h} a_{[x][z]} a_{[y][w]} \\
&\leq \sum_{h=0}^m 2^{-\beta h} \sum_{(x,y,z,w) \in \Theta_h} \frac{1}{2} (a_{[x][z]}^2 + a_{[y][w]}^2) \\
&= \sum_{h=0}^m 2^{-\beta h} \sum_{x,z} a_{[x][z]}^2 \#\{(y,w) : (x,y,z,w) \in \Theta_h\}, \tag{2.24}
\end{aligned}$$

where in the last line we use that (x, z) and (y, w) are symmetric.

For each $x \in \Gamma^{(k)}$, denote by $\mathcal{R}_k^*(x)$ the center of the cube $\mathcal{R}_k(x)$. When x is ancestor of u_i in generation h , we have

$$|\mathcal{R}_k^*(x) - \mathcal{R}_k(u_i)| \leq \sqrt{d}2^h.$$

So for every $(x, y, z, w) \in \Theta_h$,

$$|\mathcal{R}_k^*(x) - \mathcal{R}_k^*(y) + \mathcal{R}_k^*(z) - \mathcal{R}_k^*(w)| \leq 7\sqrt{d}2^h.$$

In particular, for each triple (x, y, z) , if we want to choose w so that $(x, y, z, w) \in \Theta_h$, then $\mathcal{R}_k^*(w)$ lives in a ball of side length $7\sqrt{d}2^h$. For different choices of w , $(\mathcal{R}_k(w))_w$ are disjoint cubes of side length 2^h , so we have at most a constant number $((2 + 7\sqrt{d})^d)$ of choices for it, as illustrated in Figure 7. Therefore, for each (x, z) , by choosing y arbitrarily and then using the observation above, we obtain

$$\#\{(y, w) : (x, y, z, w) \in \Theta_h\} \lesssim 2^{d(m-h)}. \tag{2.25}$$

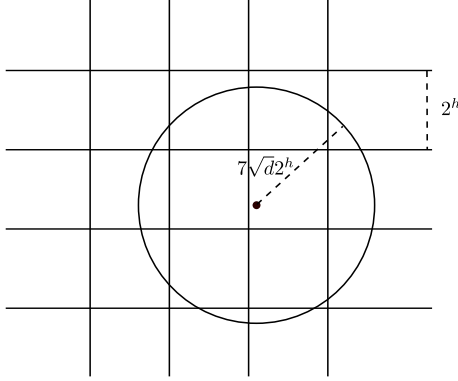

Figure 7: The ball with radius $7\sqrt{d}2^h$ intersects at most $(2 + 7\sqrt{d})^d$ tiles of size 2^h .

Put this into (2.24), note that $2^{-\beta h} = 2^{h \log_2(2^d pq)} = (2^d pq)^h$, we have

$$\begin{aligned}
& \sum_{h=0}^m \sum_{(x,y,z,w) \in \Theta_h} \sum_{i,i',j,j'} 2^{-\beta h} a_{ij} a_{i'j'} \mathbb{1}_{(i,i',j,j') \succeq (x,y,z,w)} \\
& \lesssim \sum_{h=0}^m 2^{-\beta h + d(m-h)} \sum_{|x|=m-h, |z|=n-h} a_{[x][z]}^2 = 2^{dm} \sum_{h=0}^m (pq)^h \sum_{|x|=m-h, |z|=n-h} a_{[x][z]}^2.
\end{aligned} \tag{2.26}$$

Finally, (2.18) follows by combining (2.21), (2.23), and (2.26). \square

Now we are ready to give upper bound in Theorem 1.5. For later usage, we extend the domain where the target set stays from $[-2^{n-1}, 2^{n-1}]^d \cap \mathbb{Z}^d$ to $[-2^{n-1} - 2^{m-1}, 2^{n-1} + 2^{m-1}]^d \cap \mathbb{Z}^d$.

Lemma 2.9. *Let $d \geq 1$, let $p, q \in (0, 1)$ with property (1.4). For every $1 \leq m \leq n$ and every finite set $A \subset [-2^{n-1} - 2^{m-1}, 2^{n-1} + 2^{m-1}]^d \cap \mathbb{Z}^d$,*

$$\mathbb{P}((Q_d(p; m) + \widehat{Q}_d(q; n)) \cap A \neq \emptyset) \lesssim (2^d p)^{m \vee \log_2 \text{diam}(A)} q^n \text{Cap}_\beta(A).$$

Here \lesssim only depends on d, p, q (independent of m, n, A).

Proof. By Lemma 2.7 and Lemma 2.8,

$$\mathbb{P}(Q_d(p; m) + \widehat{Q}_d(q; n) \cap A \neq \emptyset) \lesssim (2^d p)^{m \vee \log_2 \text{diam}(A)} q^n \left(\sum_{i,i',j,j'} a_{ij} a_{i'j'} |i \oplus j - i' \oplus j'|^{-\beta} \right)^{-1}.$$

Let

$$\mu(x) = \sum_{i,j} a_{ij} \mathbb{1}_{\mathcal{R}_m(i) + \mathcal{R}_n(j) = x},$$

then μ is a probability measure supported on A , and the equation above implies

$$\begin{aligned} & \mathbb{P}((Q_d(p; m) + \widehat{Q}_d(q; n)) \cap A \neq \emptyset) \\ & \lesssim (2^d p)^{m \vee \log_2 \text{diam}(A)} q^n \left(\sum \mu(x) \mu(y) |x - y|^{-\beta} \right)^{-1} \\ & \leq (2^d p)^{m \vee \log_2 \text{diam}(A)} q^n \mathbf{Cap}_\beta(A). \end{aligned}$$

□

Proof of Theorem 1.5. It is now immediate by Lemma 2.3 and Lemma 2.9.

□

3 Applications

3.1 Continuous case, proof of Corollary 1.7

Proof of Corollary 1.7. The first conclusion (1.5) follows immediately from (1.3) and Theorem 1.5 by taking $m = n$.

Below we consider the continuous case. For any closed set $\Lambda \subset [-\frac{1}{2}, \frac{1}{2}]^d$, denote

$$T_k(\Lambda) := \bigcup_{\{x : 2^k x \in \mathbb{Z}^d, x + [-2^{1-k}, 2^{1-k}]^d \cap \Lambda \neq \emptyset\}} (x + [-2^{1-k}, 2^{1-k}]^d)$$

then $T_k(\Lambda) \subset [-\frac{1}{2} - 2^{1-k}, \frac{1}{2} + 2^{1-k}]^d$, and it is not hard to check that $(T_k(\Lambda))_k$ is a decreasing sequence of sets with

$$\bigcap_{k \geq 0} T_k(\Lambda) = \Lambda.$$

We claim that

$$(Q_d(p) + \widehat{Q}_d(q)) \cap \Lambda \neq \emptyset \iff \forall k, (Q_d(p; k) + \widehat{Q}_d(q; k)) \cap 2^k T_k(\Lambda) \neq \emptyset.$$

On one hand, if $(Q_d(p) + \widehat{Q}_d(q)) \cap \Lambda \neq \emptyset$, we take $a \in Q_d(p), b \in \widehat{Q}_d(q)$ with $a + b \in \Lambda$. Then by Definition 1.4, for each k there is $a_k \in Q_d(p; k), b_k \in \widehat{Q}_d(q; k)$ such that

$$2^k a \in a_k + [-1, 1]^d, \quad 2^k b \in b_k + [-1, 1]^d.$$

This implies

$$2^k(a + b) \in (a_k + b_k) + [-2, 2]^d,$$

so $2^{-k}(a_k + b_k) \in T_k(\Lambda)$.

On the other hand, if we have $a_k \in Q_d(p; k), b_k \in \widehat{Q}_d(q; k)$ with $a_k + b_k \in 2^k T_k(\Lambda)$ for every k , by looking for a subsequence we can assume $2^{-k} a_k \rightarrow a$,

$2^{-k}b_k \rightarrow b$. Notice that $(2^{-k}\overline{Q_d(p; k)})$ is a decreasing sequence of closed set. For each fixed k , $2^{-k}\overline{Q_d(p; k)}$ contains a_k, a_{k+1}, \dots , therefore also contains their limit point a . Hence $Q_d(p)$ contains a . Similarly we have $b \in \widehat{Q}_d(q)$ and $a + b \in \Lambda$.

This allows us to conclude that

$$\mathbb{P}\left((Q_d(p) + \widehat{Q}_d(q)) \cap \Lambda \neq \emptyset\right) = \lim_{k \rightarrow \infty} \mathbb{P}\left((Q_d(p; k) + \widehat{Q}_d(q; k)) \cap 2^k T_k(\Lambda) \neq \emptyset\right).$$

Then we can apply Theorem 1.5 to $m = n = k$, $A = 2^k T_k(\Lambda)$ (use Lemma 2.3 and Lemma 2.9 directly if $2^{-k}A \not\subset [-\frac{1}{2}, \frac{1}{2}]^d$ slightly exceeds the boundary) and obtain

$$\begin{aligned} \mathbb{P}\left((Q_d(p) + \widehat{Q}_d(q)) \cap \Lambda \neq \emptyset\right) &\asymp \lim_{k \rightarrow \infty} 2^{-\beta k} \mathbf{Cap}_\beta(2^k T_k(\Lambda)) \\ &= \lim_{k \rightarrow \infty} \mathbf{Cap}_\beta(T_k(\Lambda)) = \mathbf{Cap}_\beta(\Lambda), \end{aligned}$$

where \asymp is independent of k . This proves the first part of (1.6). The second part of (1.6) is immediate by [13, Corollary 4.3]. \square

3.2 Changing parameter in capacity, proof of Corollary 1.8

Proof of Corollary 1.8. By (1.3) (and symmetry in Q and $-Q$),

$$\begin{aligned} &\mathbb{P}((Q_d(p; m) + \widehat{Q}_d(q; n)) \cap A \neq \emptyset) \\ &= \mathbb{P}(\widehat{Q}_d(q; n) \cap (A + Q_d(p; m)) \neq \emptyset) \\ &\asymp q^n \mathbb{E}[\mathbf{Cap}_{-\log_2 q}(A + Q_d(p; m))], \end{aligned}$$

as long as n is large enough such that $A + Q_d(p; m) \subset [-2^{n-1}, 2^{n-1}]^d$.

Combining this with Theorem 1.5, we have

$$(2^d p)^m \lesssim \frac{\mathbb{E}[\mathbf{Cap}_{-\log_2 q}(A + Q_d(p; m))]}{\mathbf{Cap}_\beta(A)} \lesssim (2^d p)^{m \vee \log_2 \text{diam}(A)}.$$

The first conclusion follows by taking $p = 2^{b-a-d}$, $q = 2^{-b}$.

The continuous version follows from a similar argument as proof of Corollary 1.7 with $A = 2^m T_m(\Lambda)$. \square

3.3 Consequences for sum of general random sets, proof of Theorem 1.1

Lemma 3.1. *Let $k \geq 1$, $\beta > 0$, let $A = A_1 \cup \dots \cup A_k$. Then*

$$\mathbf{Cap}_\beta(A) \asymp \mathbf{Cap}_\beta(A_1) + \dots + \mathbf{Cap}_\beta(A_k) \asymp \max\{\mathbf{Cap}_\beta(A_1), \dots, \mathbf{Cap}_\beta(A_k)\},$$

where the constant in \asymp only depends on k (independent of $\beta, A, A_1, \dots, A_k$).

Proof. Capacity is clearly monotone, so $\mathbf{Cap}_\beta(A) \geq \max\{\mathbf{Cap}_\beta(A_1), \dots, \mathbf{Cap}_\beta(A_k)\}$. Capacity is also subadditive (see for instance [9, Proposition 6.5.3]), so

$$\mathbf{Cap}_\beta(A) \leq \mathbf{Cap}_\beta(A_1) + \dots + \mathbf{Cap}_\beta(A_k) \leq k \max\{\mathbf{Cap}_\beta(A_1), \dots, \mathbf{Cap}_\beta(A_k)\}.$$

□

We are now ready to prove Theorem 1.1.

Theorem 3.2. *Let $d, k \geq 1$, let $0 < \alpha_i, \beta_i < d$, $i = 1, 2, \dots, k$ such that*

$$\gamma := \alpha_1 + \dots + \alpha_k - (k-1)d > 0, \quad (3.27)$$

$$\beta_1 + \dots + \beta_k - (k-1)d > 0.$$

Let $\mathcal{R}_1, \dots, \mathcal{R}_k$ be independent random sets in \mathbb{Z}^d with the following property: for every finite set $B \subset \mathbb{Z}^d$ containing the origin and every $|x| \geq 2\text{diam}(B)$, we have

$$\mathbb{P}(\mathcal{R}_i \cap (x+B) \neq \emptyset) \asymp |x|^{-\beta_i} \mathbf{Cap}_{\alpha_i}(B), \quad i = 1, 2, \dots, k. \quad (3.28)$$

Let $A \subset \mathbb{Z}^d$ be any finite set containing the origin. When

$$|x| \geq 2\text{diam}(A) + \max_{1 \leq i \leq k} \mathbb{1}_{\alpha_i \leq \beta_i} \text{diam}(A)^{\frac{d-\alpha_i}{d-\beta_i}} \log^{\frac{1}{d-\beta_i}}(\text{diam}(A) + 1), \quad (3.29)$$

then

$$\mathbb{P}((\mathcal{R}_1 + \dots + \mathcal{R}_k) \cap (x+A) \neq \emptyset) \asymp |x|^{(k-1)d - \beta_1 - \dots - \beta_k} \mathbf{Cap}_\gamma(A),$$

where the constant in \asymp only depends on d, k and $(\alpha_i), (\beta_i)$ (independent of A, x).

Proof. For each n , abbreviate

$$\Psi_n = [-2^{n-1}, 2^{n-1}]^d \setminus [-2^{n-2}, 2^{n-2}]^d,$$

and we assume all different instances of fractal percolations appearing in this proof to be independent.

Take $n = \lceil \log_2 |x| \rceil$. By (3.29), we know that $x+A \subset \Psi_{n+1} \cup \Psi_n \cup \Psi_{n-1}$. By Lemma 3.1, it suffices to assume $x+A \subset \Psi_n$ (otherwise cut the set into pieces in $\Psi_{n+1}, \Psi_n, \Psi_{n-1}$, and apply the argument for $n+1, n, n-1$), and it remains to show that

$$\mathbb{P}((\mathcal{R}_1 + \dots + \mathcal{R}_k) \cap (x+A) \neq \emptyset) \asymp 2^{((k-1)d - \beta_1 - \dots - \beta_k)n} \mathbf{Cap}_\gamma(A).$$

Moreover, by (3.28) and Lemma 3.1, it is not hard to observe that for every $B \subset \Psi_n$,

$$\mathbb{P}(\mathcal{R}_i \cap B \neq \emptyset) \asymp 2^{-n\beta_i} \mathbf{Cap}_{\alpha_i}(B). \quad (3.30)$$

We first prove the lower bound. Let

$$M \oplus N := (M + N) \cap \Psi_n,$$

then

$$\begin{aligned} \mathbb{P}((\mathcal{R}_1 + \cdots + \mathcal{R}_k) \cap (x + A) \neq \emptyset) &\geq \mathbb{P}((\mathcal{R}_1 \oplus \cdots \oplus \mathcal{R}_k) \cap (x + A) \neq \emptyset) \\ &= \mathbb{P}(\mathcal{R}_1 \cap (-\mathcal{R}_2 \oplus \cdots \oplus -\mathcal{R}_k \oplus (x + A)) \neq \emptyset). \end{aligned}$$

Notice that

$$-\mathcal{R}_2 \oplus \cdots \oplus -\mathcal{R}_k \oplus (x + A) \subset \Psi_n,$$

by (3.30) and (1.3),

$$\begin{aligned} &\mathbb{P}(\mathcal{R}_1 \cap (-\mathcal{R}_2 \oplus \cdots \oplus -\mathcal{R}_k \oplus (x + A)) \neq \emptyset) \\ &\asymp 2^{-\beta_1 n} \mathbf{Cap}_{\alpha_1}(-\mathcal{R}_2 \oplus \cdots \oplus -\mathcal{R}_k \oplus (x + A)) \\ &\asymp 2^{(\alpha_1 - \beta_1)n} \mathbb{P}(Q_d(2^{-\alpha_1}; n) \cap (-\mathcal{R}_2 \oplus \cdots \oplus -\mathcal{R}_k \oplus (x + A)) \neq \emptyset) \\ &= 2^{(\alpha_1 - \beta_1)n} \mathbb{P}((Q_d(2^{-\alpha_1}; n) \oplus \mathcal{R}_2 \oplus \cdots \oplus \mathcal{R}_k) \cap (x + A)) \neq \emptyset). \end{aligned} \tag{3.31}$$

Iterate the same procedure (3.31) for $\mathcal{R}_2, \dots, \mathcal{R}_k$, we have

$$\mathbb{P}((\mathcal{R}_1 \oplus \cdots \oplus \mathcal{R}_k) \cap (x + A) \neq \emptyset) \gtrsim 2^{n \sum_{i=1}^k (\alpha_i - \beta_i)} \mathbb{P}((Q_1 \oplus \cdots \oplus Q_k) \cap (x + A) \neq \emptyset),$$

where we denote $Q_i = Q_d(2^{-\alpha_i}; n)$ for simplicity.

Notice that for a set $B \subset [-2^{n-1}, 2^{n-1}]^d$,

$$\mathbb{P}((Q_1 \oplus Q_2) \cap B \neq \emptyset) = \mathbb{P}((Q_1 + Q_2) \cap B \neq \emptyset),$$

by Corollary 1.8 (the condition $\alpha_i \in (0, d)$ and (3.27) guarantees that $2^{d-\alpha_1-\alpha_2} < 1$), we have

$$\begin{aligned} &\mathbb{P}((Q_1 \oplus \cdots \oplus Q_k) \cap (x + A) \neq \emptyset) \\ &= \mathbb{P}((Q_1 \oplus Q_2) \cap ((x + A) \oplus Q_3 \oplus \cdots \oplus Q_k) \neq \emptyset) \\ &= \mathbb{P}((Q_1 + Q_2) \cap ((x + A) \oplus Q_3 \oplus \cdots \oplus Q_k) \neq \emptyset) \\ &\asymp \mathbb{P}((Q_d(2^{d-\alpha_1-\alpha_2}; n)) \cap ((x + A) \oplus Q_3 \oplus \cdots \oplus Q_k) \neq \emptyset) \\ &= \mathbb{P}((Q_d(2^{d-\alpha_1-\alpha_2}; n) \oplus Q_3 \oplus \cdots \oplus Q_k) \cap (x + A) \neq \emptyset). \end{aligned} \tag{3.32}$$

This reduces the number of fractal percolations from k to $k - 1$. The lower bound of Theorem 1.1 now follows by iteration of (3.32) and the fact $\mathbf{Cap}(A) = \mathbf{Cap}(x + A)$.

For the upper bound, by union bounds,

$$\begin{aligned} &\mathbb{P}((\mathcal{R}_1 + \cdots + \mathcal{R}_k) \cap (x + A) \neq \emptyset) \\ &= \mathbb{P}(\mathcal{R}_1 \cap (-\mathcal{R}_2 + \cdots + -\mathcal{R}_k + (x + A)) \neq \emptyset) \\ &\leq \sum_j \mathbb{P}(\Psi_j \cap \mathcal{R}_1 \cap (-\mathcal{R}_2 + \cdots + -\mathcal{R}_k + (x + A)) \neq \emptyset). \end{aligned} \tag{3.33}$$

We need this step because even though $x+A \subset \Psi_n$, $-\mathcal{R}_2 + \dots + -\mathcal{R}_k + (x+A)$ can be unbounded. By (3.30),

$$\begin{aligned} & \mathbb{P}(\Psi_j \cap \mathcal{R}_1 \cap (-\mathcal{R}_2 + \dots + -\mathcal{R}_k + (x+A)) \neq \emptyset) \\ & \asymp 2^{-\beta_1 j} \mathbf{Cap}_{\alpha_1}((-\mathcal{R}_2 + \dots + -\mathcal{R}_k + (x+A)) \cap \Psi_j). \end{aligned}$$

By (1.3), we conclude that

$$\begin{aligned} & \mathbb{P}((\mathcal{R}_1 + \dots + \mathcal{R}_k) \cap (x+A) \neq \emptyset) \\ & \lesssim \sum_j 2^{-\beta_1 j} \mathbf{Cap}_{\alpha_1}((-\mathcal{R}_2 + \dots + -\mathcal{R}_k + (x+A)) \cap \Psi_j) \\ & \lesssim \sum_j 2^{(\alpha_1 - \beta_1)j} \mathbb{P}(Q_d(2^{-\alpha_1}; j) \cap (-\mathcal{R}_2 + \dots + -\mathcal{R}_k + (x+A)) \neq \emptyset) \\ & = \sum_j 2^{(\alpha_1 - \beta_1)j} \mathbb{P}((Q_d(2^{-\alpha_1}; j) + \mathcal{R}_2 + \dots + \mathcal{R}_k) \cap (x+A) \neq \emptyset). \end{aligned}$$

Iterate for each \mathcal{R}_i , we have

$$\begin{aligned} & \mathbb{P}((\mathcal{R}_1 + \dots + \mathcal{R}_k) \cap A \neq \emptyset) \\ & \lesssim \sum_{j_1, \dots, j_k} 2^{\sum_i (\alpha_i - \beta_i) j_i} \mathbb{P}((Q_d(2^{-\alpha_1}; j_1) + \dots + Q_d(2^{-\alpha_k}; j_k)) \cap (x+A) \neq \emptyset). \end{aligned} \tag{3.34}$$

Since $\mathcal{R}_1, \dots, \mathcal{R}_k$ are exchangeable, it suffices to study the case $j_1 \geq \dots \geq j_k$, i.e.

$$\sum_{j_1, \dots, j_k} \mathbb{1}_{j_1 \geq \dots \geq j_k} 2^{\sum_i (\alpha_i - \beta_i) j_i} \mathbb{P}((Q_d(2^{-\alpha_1}; j_1) + \dots + Q_d(2^{-\alpha_k}; j_k)) \cap (x+A) \neq \emptyset)$$

Note that in order that the intersection happens, sum of the blocks $[-2^{j_i-1}, 2^{j_i-1}]^d$ must reach $x+A \subset \Psi_n$, hence

$$k2^{j_1} \geq 2^{j_1} + \dots + 2^{j_k} \geq 2^{n-2}. \tag{3.35}$$

By (1.3) (and the fact that capacity is translational invariant),

$$\begin{aligned} & \mathbb{P}((Q_d(2^{-\alpha_1}; j_1) + \dots + Q_d(2^{-\alpha_k}; j_k)) \cap (x+A) \neq \emptyset) \\ & \lesssim 2^{-\alpha_1 j_1} \mathbb{E}[\mathbf{Cap}_{\alpha_1}(Q_d(2^{-\alpha_2}; j_2) + \dots + Q_d(2^{-\alpha_k}; j_k) + A)]. \end{aligned}$$

Now j_2 becomes the largest among the remaining index, and we can use Corollary 1.8 and (3.30) to obtain

$$\begin{aligned} & \mathbb{E}[\mathbf{Cap}_{\alpha_1}(Q_d(2^{-\alpha_2}; j_2) + \dots + Q_d(2^{-\alpha_k}; j_k) + A)] \\ & \lesssim 2^{(d-\alpha_2)(j_2 \vee \log_2 \text{diam}(A))} \mathbb{E}[\mathbf{Cap}_{\alpha_1 + \alpha_2 - d}(Q_d(2^{-\alpha_3}; j_3) + \dots + Q_d(2^{-\alpha_k}; j_k) + A)]. \end{aligned}$$

Iterate this argument for j_3, \dots, j_k , given that as $j_1 \geq j_2 \geq \dots \geq j_k$, we have (recall $\gamma = \alpha_1 + \dots + \alpha_k - (k-1)d > 0$)

$$\begin{aligned} & \mathbb{P}((Q_d(2^{-\alpha_1}; j_1) + \dots + Q_d(2^{-\alpha_k}; j_k)) \cap A \neq \emptyset) \\ & \lesssim 2^{-\alpha_1 j_1} 2^{\sum_{i \geq 2} (d - \alpha_i)(j_i \vee \log_2 \text{diam}(A))} \text{Cap}_\gamma(A). \end{aligned} \quad (3.36)$$

Therefore,

$$\begin{aligned} & \sum_{j_1, \dots, j_k} \mathbb{1}_{j_1 \geq \dots \geq j_k} 2^{\sum_{i=1}^k (\alpha_i - \beta_i) j_i} 2^{-\alpha_1 j_1} 2^{\sum_{i=2}^k (d - \alpha_i)(j_i \vee \log_2 \text{diam}(A))} \text{Cap}_\gamma(A) \\ & \leq \sum_{j_1 \geq n-2-\log_2 k} 2^{-\beta_1 j_1} \text{Cap}_\gamma(A) \cdot \prod_{i=2}^k \left(\sum_{j \leq j_1} 2^{(\alpha_i - \beta_i)j + (d - \alpha_i)(j \vee \log_2 \text{diam}(A))} \right) \\ & \lesssim \sum_{j_1 \geq n-2-\log_2 k} 2^{-\beta_1 j_1} \text{Cap}_\gamma(A) \cdot \prod_{i=2}^k \left(2^{(d - \beta_i)j_1} + \log_2 \text{diam}(A) 2^{(d - \alpha_i) \log_2 \text{diam}(A)} \mathbb{1}_{\alpha_i \leq \beta_i} \right). \end{aligned}$$

By (3.29) and (3.35), the term on $\text{diam}(A)$ is negligible, hence

$$\begin{aligned} & \sum_{j_1, \dots, j_k} \mathbb{1}_{j_1 \geq \dots \geq j_k} 2^{\sum_{i=1}^k (\alpha_i - \beta_i) j_i} 2^{-\alpha_1 j_1} 2^{\sum_{i=2}^k (d - \alpha_i)(j_i \vee \log_2 \text{diam}(A))} \text{Cap}_\gamma(A) \\ & \lesssim \sum_{j_1 \geq n-2-\log_2 k} 2^{-\beta_1 j_1} \text{Cap}_\gamma(A) \cdot 2^{\sum_{i=2}^k (d - \beta_i) j_1} \asymp 2^{n((k-1)d - \beta_1 - \dots - \beta_k)} \text{Cap}_\gamma(A). \end{aligned}$$

The conclusion follows by combining this with (3.34) and (3.36). \square

Remark 3.3. The proof above relies on the intuition that hitting events are dominated by that of a typical scale Ψ_n . When $\text{diam}(A)$ is too large, this intuition may fail. Take for instance A to be a ball of radius $c|x|$, and take (\mathcal{R}_i) as ranges of simple random walks, then one single range hits A with positive probability, so (3.33) is no longer reasonable.

3.4 Remark on the case $\beta \leq 0$ in (1.4)

If $2^d p q \geq 1$, by (2.13) we have

$$\mathbb{P}((Q_d(p; m) + \widehat{Q}_d(q; n)) \cap A \neq \emptyset) \gtrsim \begin{cases} q^{n-m}, & 2^d p q > 1, \\ m^{-1} q^{n-m}, & 2^d p q = 1, \end{cases}$$

as long as A is nonempty. Moreover,

$$\begin{aligned} \mathbb{P}((Q_d(p; m) + \widehat{Q}_d(q; n)) \cap A \neq \emptyset) & = \mathbb{P}(\widehat{Q}_d(q; n) \cap (A + Q_d(p; m)) \neq \emptyset) \\ & \lesssim q^{-n} \text{Cap}_{\log_2 q}(Q_d(p; m) - A) \\ & \lesssim q^{-n} (2^m + \text{diam}(A))^{\log_2 q} \\ & \lesssim q^{n - (m \vee \log_2 \text{diam}(A))}. \end{aligned}$$

When $m \gtrsim \log_2 \text{diam}(A)$ and $2^d pq > 1$, we obtain

$$\mathbb{P}((Q_d(p; m) + \widehat{Q}_d(q; n)) \cap A \neq \emptyset) \asymp q^{n-m}.$$

When $m \ll \log_2 \text{diam}(A)$ or $m \gtrsim \log_2 \text{diam}(A)$ and $2^d pq = 1$, the upper and lower bounds do not meet, yet in fact they are both optimal (by taking $A = \{0\}$, $\{0, 2^m\}$, or $[-2^m, 2^m]^d \cap \mathbb{Z}^d$), which indicates that only knowing information on diameter of A is insufficient for a sharp estimate. In particular, we conjecture that the case $2^d pq = 1$ can be related to log-capacity of the target set A .

References

- [1] A. ASSELAH, I. OKADA, B. SCHAPIRA, AND SOUSI, P. Branching random walks and minkowski sum of random walks. (2023) arXiv:2308.12948.
- [2] T. BAI, J.-F. DELMAS, AND Y. HU Branching capacity and brownian snake capacity. (2024) arXiv:2402.13735.
- [3] Z. BARAN Intersections of branching random walks on \mathbb{Z}^8 . (2024) arXiv:2410.13834.
- [4] M. DEKKING AND K. SIMON On the size of the algebraic difference of two random Cantor sets. *Random Struct. Algorithms* **32** (2008), 205–222.
- [5] P. J. FITZSIMMONS AND T. S. SALISBURY Capacity and energy for multiparameter Markov processes. *Ann. Inst. H. Poincaré Probab. Statist.* **25** (1989), 325–350.
- [6] D.KHOSHNEVISAN AND Z. SHI Brownian sheet and capacity. *Ann. Probab.* **27** (1999), 1135–1159.
- [7] P. E. R. LARSSON 1991. *The difference set of two Cantor sets*. ProQuest LLC, Ann Arbor, MI. Thesis (Fil.Dr.)–Uppsala Universitet (Sweden).
- [8] G. F. LAWLER The probability of intersection of independent random walks in four dimensions. *Comm. Math. Phys.* **86** (1982), 539–554.
- [9] G. F.LAWLER AND V. LIMIC 2010. *Random walk: a modern introduction*. Cambridge University Press, Cambridge.
- [10] R.LYONS, Y. PERES, AND O. SCHRAMM Markov chain intersections and the loop-erased walk. *Ann. Inst. H. Poincaré Probab. Statist.* **39** (2003), 779–791.

- [11] B. B. MANDELBROT Renewal sets and random cutouts. *Z. Wahrscheinlichkeitstheorie und Verw. Gebiete* **22** (1972), 145–157.
- [12] J. PALIS Homoclinic orbits, hyperbolic dynamics and dimension of Cantor sets. In *The Lefschetz centennial conference, Part III (Mexico City, 1984)* 1987, volume 58, III of *Contemp. Math.*, pp. 203–216. Amer. Math. Soc., Providence, RI.
- [13] Y. PERES Intersection-equivalence of Brownian paths and certain branching processes. *Comm. Math. Phys.* **177** (1996), 417–434.
- [14] T. S. SALISBURY Energy, and intersections of Markov chains. In *Random discrete structures (Minneapolis, MN, 1993)* 1996, volume 76 of *IMA Vol. Math. Appl.*, pp. 213–225. Springer, New York.