

## Checking Timed Bisimilarity with Virtual Clocks (TR)

**Alexander Lieb** \*

*Technical University of Darmstadt, Germany*  
*alexander.lieb@es.tu-darmstadt.de*

**Malte Lochau**

*University of Siegen, Germany*  
*malte.lochau@uni-siegen.de*

**Andy Schürr**

*Technical University of Darmstadt, Germany*  
*andy.schuerr@es.tu-darmstadt.de*

**Hendrik Göttmann**

*Technical University of Darmstadt, Germany*  
*hendrik.goettmann@es.tu-darmstadt.de*

**Lars Luthmann**

*Accso – Accelerated Solutions GmbH*  
*Darmstadt, Germany*  
*lars.luthmann@accso.de*

---

**Abstract.** Timed automata are a widely used formalism for specifying the discrete-state/continuous-time behavior of time-critical reactive systems. For the fundamental verification problem of comparing two timed automata, it has been shown that timed trace equivalence is undecidable, while timed bisimulation is decidable. The corresponding decidability proof uses region graphs, a finite but space-consuming characterization of timed automata semantics. Most verification tools use zone graphs instead, a symbolic and, on average, more space-efficient representation of timed automata semantics. However, zone graphs provide correct results only for those verification tasks that are reducible to reachability problems, and are too imprecise for timed bisimilarity checking. To the best of our knowledge, there is currently no practical tool for automated timed bisimilarity checking. In this paper, we propose a new representation of timed automata semantics that extends zone graphs by so-called virtual clocks. Our zone-based construction is, on average, significantly smaller than the corresponding region graph representation. We also present experimental results obtained by applying our tool implementation to timed automata models, which are often used to evaluate timed automata analysis techniques.

**Keywords:** Timed Automata, Timed Bisimulation, Bisimulation Equivalence.

---

\*This work has been funded by the Deutsche Forschungsgemeinschaft (DFG, German Research Foundation) – Project-ID 210487104 - SFB 1053.

## 1. Introduction

**Background and Motivation.** Timed automata specify discrete-state/continuous-time behavior by means of labeled state-transition graphs of classical finite automata models, where states are called *locations* and transitions are denoted as *switches* [1]. Timed automata extend classical automata by a set  $C$  of *clocks* constituting constantly and synchronously increasing, yet independently resettable numerical variables. Clock values can be referenced within *clock constraints* to define boundaries for time intervals in which switches are allowed to happen in a timed run of the automaton. In this way, timed automata act as acceptors of languages over (timed) traces denoted as pairs of actions and timestamps.

A fundamental verification problem arises from the comparison of a candidate implementation against a specification of a real-time system, both specified as timed automata over the same alphabet of actions. It has been shown that timed trace inclusion (and therefore also timed trace equivalence) is undecidable, whereas timed bisimulation is decidable [2]. This makes timed bisimilarity a particularly relevant equivalence notion for verifying time-critical behaviors. The undecidability of (timed) trace inclusion is due to the limitation of timed traces to externally recognizable behavior (i.e., actions and delays) which does, however, not offer enough information about the internal structure of the respective timed automata to reason about trace inclusion. In particular, (non-visible) resets of clocks potentially caused as part of a switch in a timed run may lead to (arbitrarily deferred) semantic effects not immediately recognizable in the corresponding timed step. In contrast, the timed generalization of bisimulation equivalence is indeed rich enough to capture the discriminating effects of clock resets. However the original decidability proof of Čerāns employs region graphs, a finite, but often unnecessarily space-consuming representation of timed automata semantics (i.e., having  $\mathcal{O}(|C|! \cdot k^{|C|})$  many regions, where  $k$  is the maximum constant upper time bound of all clock constraints). Instead, most recent verification tools for timed automata are based on zone graphs which use a symbolic and, on average, more space-efficient representation of timed automata semantics than region graphs [3]. However, zone graphs only produce sound results for analysis tasks being reducible to plain location-reachability problems thus being too imprecise for checking timed bisimilarity [4]. In particular, zone graphs may not precisely reflect the possible impact of, by definition invisible, clock resets on the branching behavior in some subsequent step of a timed run as long as the reset does not affect reachability of locations.

**Contributions.** In this manuscript, we propose a new characterization of timed automata semantics. We extend zone graphs to carry additional information required for timed bisimilarity checking. To this end, our enriched notion of zones includes not only the current time intervals (zones) of the original clocks of the two automata under comparison, but additionally contains information about possible deviations due to (by definition non-visible) clock resets in the respective other automaton. We capture these deviations between clock valuations by adding so-called *virtual clocks* to zone graphs, which constitute proper, yet hidden clock variables. We define an effective criterion for cutting the extended zone graph to obtain a bounded representation and prove soundness of the criterion. Our approach works for the deterministic as well as the non-deterministic case, where the second case causes substantially more computational effort. Our constructions and correctness results are currently focused

on bisimilarity of timed (safety) automata (i.e., timed automata without acceptance states). All proofs are available in the appendix.

**Tool Support and Reproducibility.** Our tool implementation supports the TChecker file format [5] for input models and is available online <sup>1</sup>. UPPAAL [6] models can be converted into the TChecker file format [7]. This web page also contains experimental data sets and further information for reproducing the evaluation results.

**Related Work.** The notion of timed bisimulation goes back to Moller and Tofts [8] as well as Yi [9], both originally defined on real-time extensions of the process algebra CCS. Similarly, Nicollin and Sifakis [10] define timed bisimulation on ATP (Algebra of Timed Processes). However, none of these works initially incorporated a technique for effectively checking bisimilarity. The pioneering work of Čerāns [2] includes the first decidability proof of timed bisimulation on timed labeled transition systems by providing a finite characterization of bisimilarity-checking using region graphs. The improved (i.e., less space-consuming) approach of Weise and Lenzkes [4] employs a variation of zone graphs, called full backward stable graphs. Their work is most closely related to our approach. However, the approach lacks a description of how to solve essential problems such as clock resets, does not include an effective operationalisation of timed-bisimilarity checking, and, unfortunately, no tool implementation is provided. Guha et al. [11] also utilize a zone-based approach for bisimilarity-checking on timed automata as well as the weaker notion of timed prebisimilarity, by employing so-called zone-valuation graphs and the notion of spans. Again, the description of the approach lacks essential details about the construction and no tool implementation is available. Finally, Tanimoto et al. [12] use timed bisimulation to check whether a given behavioral abstraction preserves time-critical system behaviors, without, however, showing how to check for timed bisimulation. The only currently available tool for checking timed bisimilarity we are aware of is called CAAL <sup>2</sup>, which is, however, inherently incomplete as it does not guarantee a correct representation of timed automata semantics. To summarize, to the best of our knowledge, our approach is the only effective construction of timed automata semantics based on zone graphs enabling sound and complete bisimilarity checking for both deterministic and non-deterministic timed (safety) automata. In addition, we provide the only tool currently available for checking timed bisimilarity for timed automata.

**Outline.** The remainder of this manuscript is organized as follows. In Section 2, we first describe the necessary background on timed automata, timed labeled transition systems, region graphs, zone graph semantics as well as timed bisimulation. We also provide an example to illustrate potential flaws of checking timed bisimilarity on plain zone graphs. In Section 3, we describe our novel construction of zone graph semantics using virtual clocks for sound and complete timed bisimilarity checking. Section 4 shows how we can use our results of Section 3 to implement an algorithm to check for timed bisimilarity. In Section 5 we evaluate the implementation, concerning computational effort of timed bisimilarity checking. Finally, in Section 6 we conclude the manuscript and provide an outlook on potential future work.

---

<sup>1</sup><https://github.com/Echtzeitsysteme/tchecker>

<sup>2</sup><https://caal.cs.aau.dk/>

## 2. Background

In this section, we revisit basic definitions of timed automata including syntax and semantics as well as timed bisimulation. These notions build the foundation for the remainder of this manuscript.

### 2.1. Timed Automata

*Timed automata (TA)* were introduced by Alur and Dill [13]. In the following, we consider timed automata in the form of timed *safety* automata according to Henzinger et al. [3].

Similar to classical finite automata, a TA consists of a finite graph whose nodes are called *locations* and directed edges between nodes are called *switches*. Switches are labeled by symbols from a finite alphabet  $\Sigma$  of *actions*. In addition, a TA comprises a finite set  $C$  of *clocks*, representing numerical variables defined over a time domain  $\mathbb{T}$ . We limit our considerations to  $\mathbb{T} \in \{\mathbb{N}^{\geq 0}, \mathbb{R}^{\geq 0}\}$ , where  $\mathbb{T} = \mathbb{N}^{\geq 0}$  is used for *discrete* time modeling, whereas  $\mathbb{T} = \mathbb{R}^{\geq 0}$  represents *dense* time. In both cases, the valuations of all clocks *increase synchronously* over time during a TA run, but are *independently resettable* to zero. The current valuation of each clock measures the time elapsed since its last reset. By  $\mathcal{B}(C)$ , we denote the set of *clock constraints* over set  $C$ . Clock constraints are used in TA as *location invariants* as well as *switch guards* to restrict the timing behavior of TA runs.

#### Definition 2.1. (Timed Automaton)

A *timed automaton (TA)*  $A$  is a tuple  $(L, l_0, \Sigma, C, I, E)$ , where

- $L$  is a finite set of *locations*, with  $l_0 \in L$  being an *initial location*,
- $\Sigma$  is a finite set of (action) *symbols*,
- $C$  is a finite set of *clocks* such that  $C \cap \Sigma = \emptyset$ ,
- $I : L \rightarrow \mathcal{B}(C)$  is a function assigning *invariants* to locations, and
- $E \subseteq L \times \mathcal{B}(C) \times \Sigma \times 2^C \times L$  is a relation containing *switches*.

The set  $\mathcal{B}(C)$  of clock constraints  $\phi$  over  $C$  is inductively defined as

$$\phi := \text{true} \mid c \sim n \mid c - c' \sim n \mid \phi \wedge \phi, \text{ with } n \in \mathbb{N}^{\geq 0}, \sim \in \{<, \leq, >, \geq\}, \text{ and } c, c' \in C.$$

We also introduce  $c = n$  as shorthand notation for  $c \leq n \wedge c \geq n$  and  $(c - c') = n$  as shorthand notation for  $(c - c') \leq n \wedge (c - c') \geq n$ . Instead of  $(l_1, g, \sigma, R, l_2) \in E$  we often denote  $l_1 \xrightarrow[TA]{g, \sigma, R} l_2$ .

**Example 2.1.** Figure 1 shows six different TA,  $A_1$  to  $A_6$ , defined over the same alphabet  $\Sigma = \{a, b, c\}$ .  $A_1$  to  $A_4$  consist of a set  $L$  of three locations, labeled  $l_0$ ,  $l_1$ , and  $l_2$ , respectively, while  $A_5$  and  $A_6$  additionally contain the locations  $l'_1$  and  $l'_2$ . The set  $C$  of clocks of the TA  $A_1$ ,  $A_2$ , and  $A_6$  comprise only one clock  $x$ , whereas TA  $A_3$ ,  $A_4$ , and  $A_5$  comprises two clocks,  $x$  and  $y$ . Switches  $(\ell, g, \sigma, R, \ell') \in E$  are visually depicted as arrows  $\ell \xrightarrow{g, \sigma, R} \ell'$  leading from source location  $\ell \in L$  to target location  $\ell' \in L$ . The labels of transitions consist of three components: guard  $g \in \mathcal{B}(C)$ , action

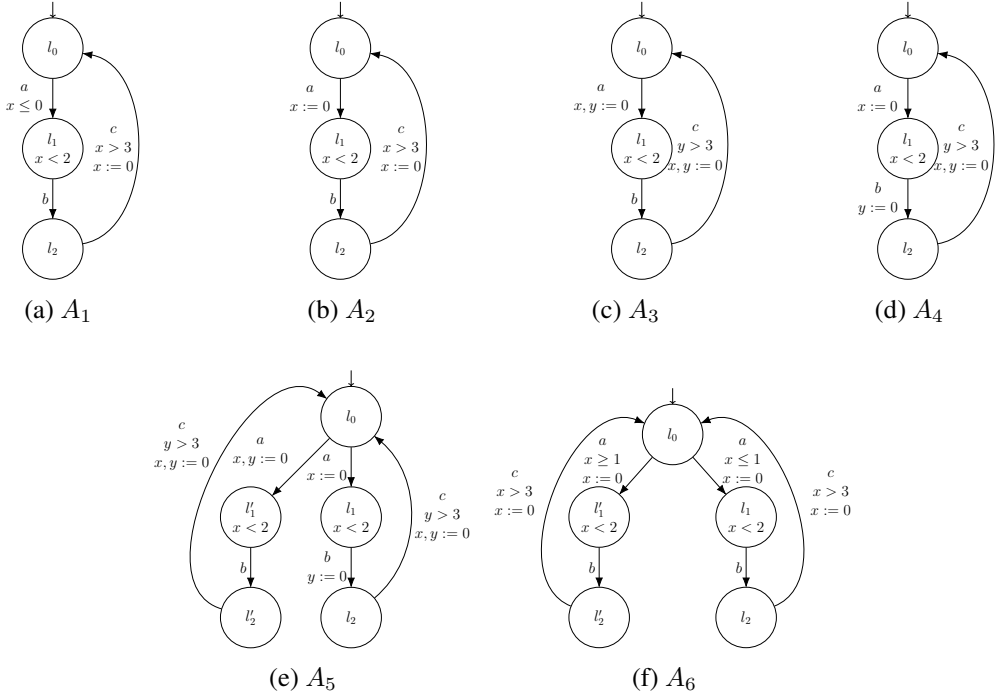

Figure 1: Examples of Timed Automata

$\sigma \in \Sigma$  and reset set  $R \subseteq C$ , denoted as assignment  $x := 0$  for each  $x \in R$ . Guard  $g$  is a clock constraint that must be satisfied for the switch to be taken in a timed step to perform action  $\sigma$  and to proceed from location  $\ell$  to location  $\ell'$ . In addition, if the switch is taken, then all clocks  $x \in R$  are set to zero. Note that the trivial guard or invariant *true* and the empty reset set  $\emptyset$  are omitted in the visual representation. Similarly, locations  $\ell$  may be also labeled by a clock constraint  $I(\ell)$  denoting a location invariant (e.g.  $I(l_1) = x < 2$  holds for any TA of Figure 1).  $A_5$  and  $A_6$  are non-deterministic TA, as the initial location is the source location of two different switches labeled with the same action  $a$ , which are enabled at the same time but lead to different locations.

In the following, we assume a TA to be *diagonal-free* thus containing only atomic clock constraints of the form  $c \sim n$ . This assumption eases many of the following proofs and does not constitute a restriction as for every non-diagonal-free TA, a language-equivalent diagonal-free TA can be constructed [14].

Clock constraints occurring in a TA are evaluated during timed runs by means of clock valuations  $u : C \rightarrow \mathbb{T}$ . Intuitively, a clock valuation assigns to each clock the time elapsed since its last reset. Given a clock constraint  $\phi \in \mathcal{B}(C)$ ,  $[\phi]$  represents the set of clock valuations satisfying that constraint.

### Definition 2.2. (Clock Valuation)

Let  $C$  be a set of clocks over time domain  $\mathbb{T}$ . A *clock valuation*  $u : C \rightarrow \mathbb{T}$  assigns a value  $u(c)$  to each clock  $c \in C$ . For a value  $d \in \mathbb{T}$ , the clock valuation  $u + d$  assigns to each clock  $c$  the value

$u(c) + d$  and for a set of clocks  $R \subseteq C$ , the clock valuation  $u' = [R \rightarrow 0]u$  assigns to each clock  $c \in R$  the value  $u'(c) = 0$  and for each clock  $c' \in C$  with  $c' \notin R$  the value  $u'(c') = u(c')$ . A clock valuation  $u$  satisfies a clock constraint  $\phi \in \mathcal{B}(C)$ , denoted  $u \models \phi$ , if one of the following conditions is satisfied (with  $\sim \in \{<, \leq, >, \geq\}$ ).

- If  $\phi = \text{true}$ , then  $u \models \phi$ ,
- if  $\phi = c \sim n$ , then  $(u \models \phi) \Leftrightarrow (u(c) \sim n)$ ,
- if  $\phi = (c - c') \sim n$ , then  $(u \models \phi) \Leftrightarrow ((u(c) - u(c')) \sim n)$ ,
- if  $\phi = \phi_1 \wedge \phi_2$ ,  $\phi_1, \phi_2 \in \mathcal{B}(C)$ , then  $u \models \phi \Leftrightarrow ((u \models \phi_1) \text{ and } (u \models \phi_2))$ .

We write  $u \not\models \phi$  to denote that  $u \models \phi$  does not hold. By  $[C \rightarrow 0]$  we denote the initial clock valuation  $u_0 : C \rightarrow \mathbb{T}$  such that  $\forall c \in C : u_0(c) = 0$ .

We call a clock constraint  $\phi$  to be *stronger* than a clock constraint  $\phi'$ , if and only if  $u \models \phi$  implies  $u \models \phi'$  and there exists a  $u'$  with  $u' \not\models \phi$  and  $u' \models \phi'$ . To rule out trivial cases, we assume the location invariant  $I(l_0)$  of a TA to be always satisfied by the initial clock valuation  $[C \rightarrow 0]$ .

## 2.2. Timed Labeled Transition Systems

*Labeled Transition Systems (LTS)* are used to model processes with finite or infinite numbers of states. To capture the operational semantics of TA, *Timed Labeled Transition Systems (TLTS)* extend LTS by the notion of time. A state of a TLTS is a pair  $(l, u)$ , with  $l \in L$  being the currently active location and  $u : C \rightarrow \mathbb{T}$  being the current valuation of clocks. The set of transition labels of a TLTS is decomposed into two disjoint subsets, one containing actions  $\sigma \in \Sigma$  as usual and the other containing values  $d \in \mathbb{T}$  denoting durations. TLTS contain two types of transitions, one corresponding to the passage of time of duration  $d \in \mathbb{T}$  without any occurrence of a switch, leading to an updated clock valuation  $u' = u + d$ , and one corresponding to the instantaneous execution of a switch  $l_1 \xrightarrow[TA]{g, \sigma, R} l_2$ , leading to the state  $(l_2, [R \rightarrow 0]u)$ .

### Definition 2.3. (TLTS)

Let  $A = (l, l_0, \Sigma, C, I, E)$  be a TA. The *TLTS*  $A_{\text{TLTS}}$  of  $A$  is a tuple  $(V_{\text{TS}}, v_{0,A}^{\text{TS}}, \Sigma \cup \mathbb{T}, \xrightarrow[TLTS]{})$ , where

- $V_{\text{TS}} = L \times (C \rightarrow \mathbb{T})$  is a set of states with  $v_{0,A}^{\text{TS}} = (l_0, [C \rightarrow 0]) \in V_{\text{TS}}$  being the initial state,
- $\Sigma \cup \mathbb{T}$  is the set of transition labels, where  $\Sigma \cap \mathbb{T} = \emptyset$ ,
- $\xrightarrow[TLTS]{} \subseteq V_{\text{TS}} \times \Sigma \cup \mathbb{T} \times V_{\text{TS}}$  is a set of transitions, which is the least relation satisfying
  - $(l, u) \xrightarrow[TLTS]{d} (l, u + d)$  if  $(u + d) \models I(l)$  for  $d \in \mathbb{T}$ , and
  - $(l_1, u_1) \xrightarrow[TLTS]{\sigma} (l_2, u_2)$  if  $l_1 \xrightarrow[TA]{g, \sigma, R} l_2$  with  $u_1 \models g$ ,  $u_2 = [R \rightarrow 0]u_1$ ,  $u_2 \models I(l_2)$ , and  $\sigma \in \Sigma$ .

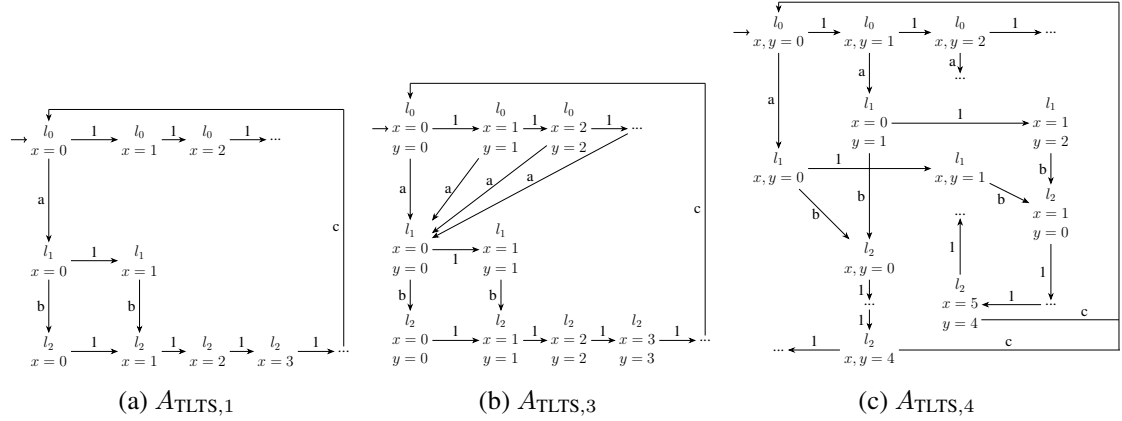

Figure 2: The TLTS of the TA of Figure 1

Since we assume  $[C \rightarrow 0] \models I(l_0)$  and we check for each TLTS transition if the clock valuation of the target state satisfies the invariant of the corresponding target location,  $u \models I(l)$  holds for all reachable states  $(l, u)$ .

**Example 2.2.** Figure 2 shows the TLTS of  $A_1$  (Figure 1a),  $A_3$  (Figure 1c), and  $A_4$  (Figure 1d). For reasons of readability, all delay transitions with the exception of  $d = 1$  have been removed. In the discrete-time model, the states can have an infinite number of outgoing transitions labeled with natural numbers. In the dense-time model the number of outgoing transitions is uncountably infinite and the transitions are labeled with real numbers.

The TLTS of  $A_2$  (Figure 1b) is identical to  $A_{TLTS,3}$ , with the exception of the absence of clock  $y$ . The TLTS of  $A_5$  (Figure 1e) is a combination of  $A_{TLTS,3}$  and  $A_{TLTS,4}$ , while the TLTS of  $A_6$  (Figure 1f) is two times the TLTS of  $A_2$  (the first part is reachable from  $l_0$  if the guard  $x \leq 1$  is satisfied and the second part is reachable from  $l_0$  if the guard  $x \geq 1$  is satisfied). Time delays are always enabled, unless a location has an invariant that is no longer satisfied after this delay. Action-based transitions are enabled if and only if there exists a corresponding switch  $\ell \xrightarrow[\text{TA}]{g, \sigma, R} \ell'$  in the TA, for which the clock valuation  $u$  of the current state fulfills  $g$  and the clock valuation  $[R \rightarrow 0]u$ , which is the clock valuation of the target state, fulfills the invariant of  $\ell'$ .

A fundamental decision problem in the context of behavioral modeling is to compare the behavior of two models against each other (e.g., one representing the specification and the other one constituting a candidate implementation). The most obvious approach is to compare the languages characterized by both models against each other. The language of automata-based models is defined as the set of possible action sequences (traces) corresponding to a path along the state-transition graph. Unfortunately, it is well-known that timed language inclusion is undecidable for timed automata [1] and this result can easily be extended to show that language equivalence is undecidable, too.

In contrast, the stronger notion of timed bisimulation of two TA models is decidable [2]. Given a TA  $A$  and a state  $v_A^{\text{TS}}$  of the corresponding TLTS  $A_{\text{TLTS}}$ ,  $v_A^{\text{TS}}$  *timed simulates* a state  $v_B^{\text{TS}}$  of the

corresponding TLTS  $B_{\text{TLTS}}$  of another TA  $B$  if every transition enabled in  $v_B^{\text{TS}}$  is also enabled in  $v_A^{\text{TS}}$  and the target states in  $A_{\text{TLTS}}$ , again, timed simulates the related target states in  $B_{\text{TLTS}}$ .  $A_{\text{TLTS}}$  timed simulates  $B_{\text{TLTS}}$  if and only if the initial state of  $A_{\text{TLTS}}$  timed simulates the initial state of  $B_{\text{TLTS}}$ .  $v_A^{\text{TS}}$  and  $v_B^{\text{TS}}$  are *timed bisimilar*, if every transition enabled in  $v_A^{\text{TS}}$  is also enabled in  $v_B^{\text{TS}}$ , every transition enabled in  $v_B^{\text{TS}}$  is also enabled in  $v_A^{\text{TS}}$ , and the related target states are also timed bisimilar.  $A_{\text{TLTS}}$  is timed bisimilar to  $B_{\text{TLTS}}$  if and only if the initial state of  $A_{\text{TLTS}}$  is timed bisimilar to the initial state of  $B_{\text{TLTS}}$ .

**Definition 2.4. (Timed Bisimulation [15, 2])**

Let  $A = (L_A, l_{0,A}, \Sigma, C_A, I_A, E_A)$  and  $B = (L_B, l_{0,B}, \Sigma, C_B, I_B, E_B)$  be TA over the same alphabet  $\Sigma$  with  $C_A \cap C_B = \emptyset$ .  $A$  has the corresponding TLTS  $A_{\text{TLTS}} = (V_{\text{TS},A}, v_{0,A}^{\text{TS}}, \Sigma \cup \mathbb{T}, \xrightarrow{\text{TLTS}})$  and  $B$  has the corresponding TLTS  $B_{\text{TLTS}} = (V_{\text{TS},B}, v_{0,B}^{\text{TS}}, \Sigma \cup \mathbb{T}, \xrightarrow{\text{TLTS}})$ . A Relation  $R \subseteq V_{\text{TS},B} \times V_{\text{TS},A}$  is called a *Timed Bisimulation*, if and only if for all pairs  $(v_{1,B}^{\text{TS}}, v_{1,A}^{\text{TS}}) \in R$  it holds that

1. if there is a transition  $v_{1,B}^{\text{TS}} \xrightarrow{\text{TLTS}, \mu} v_{2,B}^{\text{TS}}$  for  $\mu \in \Sigma \cup \mathbb{T}$ , then a transition  $v_{1,A}^{\text{TS}} \xrightarrow{\text{TLTS}, \mu} v_{2,A}^{\text{TS}}$  with  $(v_{2,B}^{\text{TS}}, v_{2,A}^{\text{TS}}) \in R$ , exists, and
2. if there is a transition  $v_{1,A}^{\text{TS}} \xrightarrow{\text{TLTS}, \mu} v_{2,A}^{\text{TS}}$  for  $\mu \in \Sigma \cup \mathbb{T}$ , then a transition  $v_{1,B}^{\text{TS}} \xrightarrow{\text{TLTS}, \mu} v_{2,B}^{\text{TS}}$  with  $(v_{2,B}^{\text{TS}}, v_{2,A}^{\text{TS}}) \in R$ , exists.

$A$  is timed bisimilar to  $B$ , denoted  $B \sim A$ , if and only if there exists a timed bisimulation  $R$  with  $(v_{0,B}^{\text{TS}}, v_{0,A}^{\text{TS}}) \in R$ .

The analog definition of timed simulation can be found in Appendix A.

In the following, we write that TA  $A$  simulates TA  $B$ , if and only if  $A$  timed simulates  $B$  and  $A$  is bisimilar to  $B$ , if and only if  $A$  is timed bisimilar to  $B$ . It is well-known that (timed) bisimulation is an equivalence relation and if two TA are bisimilar, then they simulate each other, while the opposite direction does not necessarily hold.

**Example 2.3.** We compare the previously described examples with respect to timed bisimulation.

Due to the state  $(l_0, x = 1)$ , which does not have an outgoing transition labeled with  $a$ ,  $A_{\text{TLTS},1}$  (Figure 2a) is not bisimilar to any other TLTS shown. For instance, if we compare  $A_{\text{TLTS},1}$  and  $A_{\text{TLTS},3}$  (Figure 2b), we find that if we use the transition labeled with 1, the reached states are not bisimilar since  $A_{\text{TLTS},3}$  has an outgoing transition labeled with  $a$  here and  $A_{\text{TLTS},1}$  does not.

Since  $A_{\text{TLTS},2}$  and  $A_{\text{TLTS},3}$  have an isomorphic structure, they are bisimilar (and thus simulate each other), despite the fact that the sets of clocks are not equivalent. Due to the fact that bisimulation is an equivalence relation, we know that  $A_{\text{TLTS},2}$  is bisimilar to any other TLTS if and only if that TLTS is bisimilar to  $A_{\text{TLTS},3}$ . Therefore, we proceed with  $A_{\text{TLTS},3}$ .

To compare  $A_{\text{TLTS},3}$  and  $A_{\text{TLTS},4}$  (Figure 2c), we consider the sequence  $[a, 1, b, 3]$ . In  $A_{\text{TLTS},3}$ , this sequence results into the state  $(l_2, (x = 4, y = 4))$ , which has an outgoing transition labeled with  $c$ . In  $A_{\text{TLTS},4}$ , this sequence results into the state  $(l_2, (x = 4, y = 3))$ , which does not have such an outgoing transition. Therefore, the TLTS are not bisimilar but  $A_{\text{TLTS},3}$  simulates  $A_{\text{TLTS},4}$ .



The comparison of  $A_{\text{TLTS},3}$  and  $A_{\text{TLTS},5}$  shows that two TA can simulate each other, while they are not bisimilar. Since each TLTS simulates itself,  $A_{\text{TLTS},3}$  can obviously be simulated by the branch of  $A_{\text{TLTS},5}$  that is equivalent to  $A_{\text{TLTS},3}$ . Moreover, since  $A_{\text{TLTS},3}$  simulates  $A_{\text{TLTS},4}$ ,  $A_{\text{TLTS},3}$  simulates both branches of  $A_{\text{TLTS},5}$  and, therefore, also the whole automaton.  $A_{\text{TLTS},4}$  and  $A_{\text{TLTS},5}$  are not bisimilar since  $A_{\text{TLTS},4}$  is not bisimilar to  $A_{\text{TLTS},3}$ , which implies that the corresponding branch of  $A_{\text{TLTS},5}$  is also not bisimilar to  $A_{\text{TLTS},4}$ .

The comparison of  $A_{\text{TLTS},3}$  and  $A_{\text{TLTS},6}$  shows that a non-deterministic TA can be timed bisimilar to a deterministic TA. Since  $A_{\text{TLTS},6}$  is essentially two times  $A_{\text{TLTS},2}$  we already know that both individual parts of  $A_{\text{TLTS},6}$  have an identical structure to  $A_{\text{TLTS},3}$  and we only have to check the state  $(l_0, x = 1)$ , which has two outgoing transitions labeled with a in  $A_{\text{TLTS},6}$ . The first one leads to  $(l_1, x = 0)$ . Since the following states have an identical structure to  $A_{\text{TLTS},3}$ , we conclude that the state  $(l_1, x = 0)$ , reachable in  $A_{\text{TLTS},3}$  from  $(l_0, x = 1)$  via a transition labeled with a, is bisimilar to the state of  $A_{\text{TLTS},6}$ . The same holds for the other outgoing transition in  $A_{\text{TLTS},6}$ , which leads to  $(l'_1, x = 0)$ . Since the following structure is the same as in  $A_{\text{TLTS},3}$ , we conclude that  $(l_1, x = 0)$  from  $A_{\text{TLTS},3}$  is bisimilar to  $(l'_1, x = 0)$  from  $A_{\text{TLTS},6}$  and, therefore, the states  $(l_0, x = 1)$  from both TLTS are bisimilar.

Although bisimulation of two TA is defined with respect to their TLTS models, they do not provide a feasible basis for effectively checking for bisimulation due to their infinite number of states. In the following we revisit two alternative finite representations of timed automata semantics, namely region graphs and zone graphs.

### 2.3. Region Graphs

Region graphs were introduced by Alur and Dill [16]. The main idea is based on the observation that if two clock valuations agree on the integer part of all clock values then every constraint of a diagonal-free TA is satisfied either by both of the clock valuations or none of them (remember: Clock constraints use numbers from  $\mathbb{N}^{\geq 0}$  only). Furthermore, if the order of the clocks in which the integer part changes is equal for two clock valuations (i.e., both will lead to similar behavior in the future), the states can be considered to be in the same equivalence class, called *region*.

**Example 2.4.** Consider TLTS  $A_{\text{TLTS},4}$  (Figure 2a) and the sequences  $[0.5, a, 0.6]$ ,  $[0.9, a, 0.5]$ ,  $[0.9, a, 1.3]$ , and  $[0, a, 0]$  (we assume dense-time model here). All these sequences describe a delay, followed by the input  $a$  and another delay. The sequences all lead to location  $B$ , but with different clock valuations:  $u_1$ , with  $u_1(x) = 0.6$  and  $u_1(y) = 1.1$ ,  $u_2$ , with  $u_2(x) = 0.5$  and  $u_2(y) = 1.4$ ,  $u_3$ , with  $u_3(x) = 1.3$  and  $u_3(y) = 2.2$ , and  $u_4$ , with  $u_4(x) = 0$  and  $u_4(y) = 0$ .

$u_1(x)$  and  $u_2(x)$  have the integer part zero,  $u_1(y)$  and  $u_2(y)$  have the integer part one, and the fractional part of the value of  $x$  is both times larger than the fractional part of the value of  $y$  and, therefore, clock  $x$  changes its integer part before clock  $y$ . This implies that  $u_1$  and  $u_2$  are in the same region.  $u_3$  is in a different region since the integer part of  $u_3(x)$  is one.

Since the fractional part of  $u_4(x)$  is equal to the fractional part of  $u_4(y)$ , which means that  $x$  and  $y$  will change its integer part at the same time,  $u_4$  is in a different region than the other clock valuations.

Given a diagonal-free TA  $A$  over a set of clocks  $C$ , we define  $k : C \rightarrow \mathbb{N}^{\geq 0}$  to map each clock to a natural number, such that for any clock constraint  $x \sim n$  with  $x \in C$  and  $n \in \mathbb{N}^{\geq 0}$  occurring in  $A$ , it holds that  $n < k(x)$ . We are allowed to consider all values for  $x$  which are larger than  $k(x)$  to be equivalent, since every constraint of a diagonal-free TA of the form  $x \sim n$  is either satisfied or not satisfied by all these values. By  $\lfloor z \rfloor$  we denote the integral part of a number and by  $\text{frac}(z)$  we denote the fractional part of a number. Region equivalence is defined as follows.

**Definition 2.5. (Region Equivalence [16])**

Let  $C$  be a set of clocks,  $k : C \rightarrow \mathbb{N}^{\geq 0}$  a function, and  $u_A, u_B : C \rightarrow \mathbb{T}$  two clock valuations.  $u_A$  and  $u_B$  are *region equivalent*, denoted  $u_A \simeq_k u_B$ , if and only if

1.  $\forall c \in C : ((\lfloor u_A(c) \rfloor = \lfloor u_B(c) \rfloor) \vee (u_A(c) > k(c) \wedge u_B(c) > k(c))),$
2.  $\forall c, c' \in C : (u_A(c) \leq k(c) \wedge u_A(c') \leq k(c')) \text{ implies } (\text{frac}(u_A(c)) \leq \text{frac}(u_A(c')) \Leftrightarrow \text{frac}(u_B(c)) \leq \text{frac}(u_B(c'))), \text{ and}$
3.  $\forall c \in C : (u_A(c) \leq k(c)) \text{ implies } (\text{frac}(u_A(c)) = 0 \Leftrightarrow \text{frac}(u_B(c)) = 0).$

holds. We define two states  $(l_1, u_1), (l_2, u_2)$  to be region equivalent, if and only if  $l_1 = l_2$  and  $u_1 \simeq_k u_2$  hold.

Using region equivalence, it is possible to create a finite region-graph representation of timed automata semantics. This construction has been used by Čerāns to prove that timed bisimulation is decidable [2]. However, region graphs may become unnecessarily large containing many regions, especially if large constants appear within clock constraints [17]. For the size of a region graph, it holds that  $\mathcal{O}(|C|! \cdot K^{|C|})$  is an upper bound, where  $K$  is the maximum constant upper time bound of all clock constraints.

For any clock constraint  $\phi \in \mathcal{B}(C)$  of the form  $\phi = \phi_1 \wedge \phi_2 \wedge \dots$  with  $\phi_i = c \sim n$  and  $n < k(c)$  and any two clock valuations  $u_1, u_2$  of the same region, either  $u_1, u_2 \models \phi$  or  $u_1, u_2 \not\models \phi$  holds. Nevertheless, for a particular  $\phi_i$  the distinction into two different regions might not be relevant for the analysis of the TA and, therefore, the symbolic analysis introduced by regions can be further improved by only using the *relevant* part of  $\phi$ . This is the main idea of *zones*.

## 2.4. Zone Graphs

Zone graphs define a symbolic representation of timed automata semantics. Like regions, zones also represent a set of clock valuations. While in the worst case, zone graphs can have the same number of reachable symbolic states as region graphs, zone graphs are in the average case significantly smaller.

**Definition 2.6. (Zone)**

Let  $C$  be a set of clocks. A zone  $D \in 2^{C \rightarrow \mathbb{T}}$  is a set of clock valuations corresponding to a clock constraint  $\phi \in \mathcal{B}(C)$  such that  $D = \{u \mid u \in (C \rightarrow \mathbb{T}) \wedge u \models \phi\}$ . Let zones  $D, D' \in \mathcal{D}(C)$  and clock constraint  $\phi$  be defined over the same set  $C$ , and  $R \subseteq C$ . We define the following operations on zones:

$$D \cap D' = \{u \mid u \in D \wedge u \in D'\} \text{ (}\cap\text{-operation)}$$

$$\begin{aligned}
D \wedge \phi &= \{u \mid u \in D \wedge u \models \phi\} \text{ (\wedge-operation)} \\
D^\dagger &= \{u + d \mid d \in \mathbb{T} \wedge u \in D\} \text{ (future-operation)} \\
R(D) &= \{[R \rightarrow 0]u \mid u \in D\} \text{ (reset-operation)}
\end{aligned}$$

In the symbolic semantics of TA, clock constraints  $\phi$  over clocks  $C$  are used to characterize the set of clock valuations  $u$  for  $C$  contained in a zone  $D$  in a finite way (even if  $D$  comprises an infinite number of clock valuations). By  $[\phi]$  we denote the maximum set of clock valuations for  $C$  satisfying clock constraint  $\phi$  over  $C$ . The operations on zones in Definition 2.6 can be lifted to the set  $\mathcal{B}(C)$  of clock constraints as  $\mathcal{B}(C)$  is closed under these operations and the operator  $[\cdot]$  commutes with these operations [18].

**Example 2.5.** The states of Example 2.4 all have outgoing delay transitions as long as the clock valuation of the resulting state evaluates  $x$  to a value smaller than 2. Moreover, they all have an outgoing action transition, labeled with  $b$ . Therefore, we summarize all clock valuations of Example 2.4 into a single zone, which is equivalent to the maximum set of clock valuations that satisfy the clock constraint  $x < 2$ . Therefore, we only need to analyze a single symbolic state in the zone graph, while we have three different symbolic states in the region graph.

In most practical TA analysis tools, *Difference Bound Matrices (DBM)* are used to represent zones [19, 20]. A DBM is a conjunction of  $(|C| + 1)^2$  basic constraints of the form  $c - c' \sim_{<, \leq} z$ ,  $c \sim_{<, \leq} z$ , or  $-c \sim_{<, \leq} z$ , respectively, with  $\sim_{<, \leq} \in \{<, \leq\}$  and  $z \in \mathbb{Z} \cup \{\infty\}$ . Given a set of clocks  $C$ , we refer to the set of all DBM over  $C$  by  $\mathcal{M}(C)$ . An element of a DBM, which represents a basic constraint, is called *strong*, if the corresponding clock constraint cannot be replaced by a stronger clock constraint without changing the set of clock valuations contained in the zone. For any DBM, there exists a canonical form in which all elements are strong. For more details on DBM, we refer the reader to Appendix B as well as to the comprehensive overview of Bengtsson and Yi [21].

A *zone graph* defines the operational semantics of a TA as a transition system whose set of states corresponds to the set of zones of the TA and whose transitions define possible transitions between zones in a timed run. If a symbolic state  $(l, D)$  is reachable in a zone graph, then every state  $(l, u)$  with  $u \in D$  is reachable in the corresponding TLTS. Conversely, if a state  $(l, u)$  of the TLTS is reachable, then there exists a reachable symbolic state  $(l, D)$  with  $u \in D$  in the corresponding zone graph.

The following definition of zone graphs is a slightly adapted version to the zone graphs of Yi et al. [18]. We denote  $D_0 = \{[C \rightarrow 0]\}$ .

### Definition 2.7. (Zone Graph)

Let  $A = (L, l_0, \Sigma, C, I, E)$  be a TA. A *zone graph*  $A_{ZG} = (V_{ZG}, (l_0, D_0), \Sigma \cup \{\varepsilon\}, \xrightarrow{ZG})$  of  $A$  is a transition system, where

- $V_{ZG} = L \times \mathcal{D}(C)$  is the set of symbolic states with  $(l_0, D_0) \in V_{ZG}$  being the initial symbolic state, and
- $\xrightarrow{ZG} \subseteq V_{ZG} \times \Sigma \cup \{\varepsilon\} \times V_{ZG}$  is the least relation satisfying the rules:
  - $(l, D) \xrightarrow{ZG} (l, D^\dagger \wedge I(l))$ , and

$$- (l_1, D_1) \xrightarrow{ZG} (l_2, R(D_1 \wedge g) \wedge I(l_2)), \text{ if } l_1 \xrightarrow{g, \sigma, R}_{TA} l_2 \text{ and } R(D_1 \wedge g) \wedge I(l_2) \neq \emptyset.$$

Note that there always exists a clock constraint  $\phi_0$  for which  $[\phi_0] = \{[C \rightarrow 0]\}$  holds. As all zones of a zone graph are constructed by using the previously described operations, each zone  $D$  reachable from  $D_0$  in a zone graph can be represented by a (finite) clock constraint  $\phi$  with  $[\phi] = D$ . Since  $D_0 \wedge I(l_0) = D_0$  holds for the initial symbolic state  $(l_0, D_0)$  (as we assume  $[C \rightarrow 0] \models I(l_0)$ ) and since we intersect the target zone  $D$  of a transition by the invariant of the target location  $l$ ,  $D \wedge I(l) = D$  holds for all reachable states  $(l, D)$ . Moreover, due to  $D \subseteq D^\uparrow$  and since we exclude empty symbolic states after an action-labeled transition, it follows that no reachable zone is ever empty. This last property, which will become useful later on, is the only difference of our zone graph as compared to Yi et al. [18]. For locations  $l, l'$ , clock valuation  $u$ , and zone  $D$ , we denote by  $(l, u) \in (l', D)$  that  $l = l'$  and  $u \in D$  holds.

**Proposition 2.1. (Soundness and Completeness of Zone Graphs)**

Assume a TA  $A = (L, l_0, \Sigma, C, I, E)$  with locations  $l_0, l_n \in L$ , the corresponding TLTS  $A_{TLTS} = (V_{TS,A}, v_0^{TS}, \Sigma \cup \mathbb{T}, \xrightarrow{TLTS})$ , and zone graph  $A_{ZG} = (V_{ZG,A}, (l_0, D_0), \Sigma \cup \{\varepsilon\}, \xrightarrow{ZG})$ . Let  $D_n \in \mathcal{D}(C)$  be a zone and  $u_0 = [C \rightarrow 0]$ ,  $u_n \in (C \rightarrow \mathbb{T})$  be clock valuations. It holds that

1. (soundness) whenever there is a transition sequence  $(l_0, D_0) \xrightarrow{ZG}^{\mu_{\varepsilon,1}} \dots \xrightarrow{ZG}^{\mu_{\varepsilon,n}} (l_n, D_n)$  with  $\forall x \in [1..n] : \mu_{\varepsilon,x} \in \Sigma \cup \{\varepsilon\}$ , then

$$\forall u_n \in D_n : \exists \mu_{\mathbb{T},1}, \dots, \mu_{\mathbb{T},n} \in \Sigma \cup \mathbb{T} : (l_0, u_0) \xrightarrow{TLTS}^{\mu_{\mathbb{T},1}} \dots \xrightarrow{TLTS}^{\mu_{\mathbb{T},n}} (l_n, u_n),$$

2. (completeness) whenever there is a transition sequence  $(l_0, u_0) \xrightarrow{TLTS}^{\mu_{\mathbb{T},1}} \dots \xrightarrow{TLTS}^{\mu_{\mathbb{T},n}} (l_n, u_n)$  with  $\forall x \in [1..n] : \mu_{\mathbb{T},x} \in \Sigma \cup \mathbb{T}$ , then

$$\exists D_n \in \mathcal{D}(C) : \exists \mu_{\varepsilon,1} \dots \mu_{\varepsilon,n} \in \Sigma \cup \{\varepsilon\} : u_n \in D_n \wedge (l_0, D_0) \xrightarrow{ZG}^{\mu_{\varepsilon,1}} \dots \xrightarrow{ZG}^{\mu_{\varepsilon,n}} (l_n, D_n).$$

**Proof:**

See Appendix C. □

This property of zone graphs is usually represented in a more compact way (i.e., omitting an explicit mentioning of path segments). Nevertheless, we use this representation to point out the relationship between paths in the TLTS and their counter-part in zone graphs.

The following example shows that the zone graph construction as described above does not necessarily yield a finite representation of TA semantics.

**Example 2.6.** Figure 3 shows a TA with an extract of its infinite zone graph. The reason for the infinity is the minimum value of clock  $y$ , which increases each time the transition labeled with  $b$  is used.

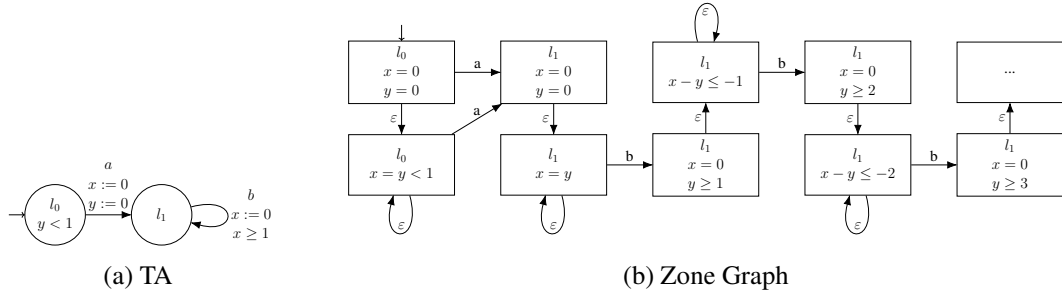

Figure 3: TA with infinite Zone Graph

To solve this issue, the same idea that we saw in Definition 2.5 is used in recent works. Fortunately, for every TA, a (sound and complete) finite zone graph representation can be obtained using *k-normalization* [21, 22]. Let  $D$  be a zone, which can be described by a clock constraint  $\phi = \phi_0 \wedge \phi_1 \wedge \dots$ . The main idea is to replace all basic constraints  $\phi_i$  of the form  $c \sim_{<, \leq} n, c - c' \sim_{<, \leq} n$  where  $n > k(c)$  with true, and to replace all  $\phi_i$  of the form  $c \sim_{>, \geq} n, c - c' \sim_{>, \geq} n$  where  $n > k(c)$  or  $c - c' > k(c)$  respectively. For more details, see Appendix D or Bengtsson and Yi [21].

We use the notation  $\text{norm}(D, k)$  to indicate that *k-normalization* is used. By  $\Pi$  we denote a finite sequence of operations  $\pi_i$  on zones. If  $\pi_i$  is a  $\wedge$ -operation, we assume that the used clock constraint has the form  $c \sim n$ , with  $c \in C, \sim \in \{<, \leq, \geq, >\}$ , and  $n \in \mathbb{N}^{\geq 0}$ . Furthermore, let  $k : C \rightarrow \mathbb{N}^{\geq 0}$  be a function, such that for any used clock constraint of the form  $c \sim n$ , the statement  $k(c) > n$  holds. By applying *k-normalization* to any zone  $D$ , which is the result of the application of operations to  $D_0$ , we add clock valuations to  $D$ . Any added clock valuation  $u_n$  has a corresponding  $u \in D$  such that  $u_n$  and  $u$  are in the same region, as the following proposition shows.

**Proposition 2.2. (k-normalization is sound [21])**

Let  $C$  be a set of clocks,  $D_0 = \{[C \rightarrow 0]\}$  be an initial zone, and  $k : C \rightarrow \mathbb{N}^{\geq 0}$  be a function. Let  $\Pi$  be a sequence of operations  $\pi_i$ .

$$\Pi(D_0) \subseteq \text{norm}(\Pi(D_0), k)$$

and

$$\forall u_n \in \text{norm}(\Pi(D_0), k) : \exists u \in \Pi(D_0) : u_n \simeq_k u.$$

hold.

**Proof:**

See Appendix D. □

The proposition further implies a new, useful notion of equivalence on zones: Two zones  $D_1, D_2$  are equivalent if and only if  $\text{norm}(D_1, k) = \text{norm}(D_2, k)$ . Using these equivalence classes, our zone graphs become finite.

**Proposition 2.3. (k-normalization is finite [22])**

Let  $C$  be a set of clocks,  $k \in (C \rightarrow \mathbb{N}^{\geq 0})$ . Moreover, let  $K \in \mathbb{N}^{\geq 0}$  such that  $\forall c \in C : k(c) \leq K$ . The image size of the norm operator has  $(4K + 3)^{(|C|+1)^2}$  as upper bound.

**Proof:**

See Appendix E. □

The actual image size is, on average, much smaller than this upper bound as many instances of DBMs cannot occur in practice.

In the worst case, zone graphs become exponentially large in the number of reachable symbolic states, as shown in the following example.

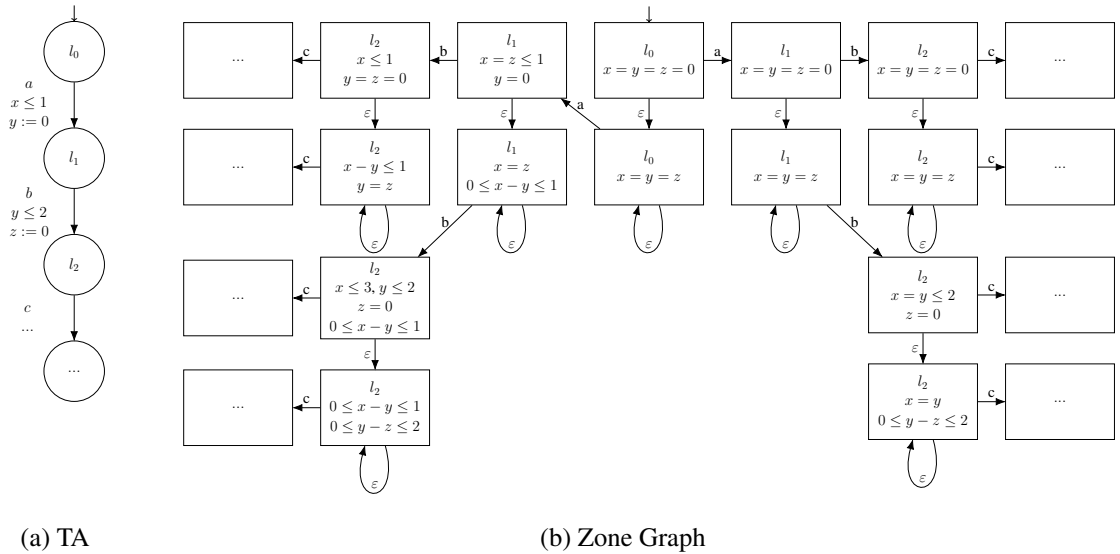

Figure 4: TA with exponentially large zone graph

**Example 2.7.** Starting from the initial symbolic state, we can see in Figure 4b that the zone graph has an exponential size. While  $l_0$  appears only twice in the zone graph,  $l_1$  appears four times and  $l_2$  eight times. The reader may notice that this problem becomes even worse when regions are used.

Yi et al. [18] address this problem by considering only sequences that alternate between transitions labeled with actions from  $\Sigma$  and transitions labeled with  $\varepsilon$ . For TLTS, this is allowed since two action

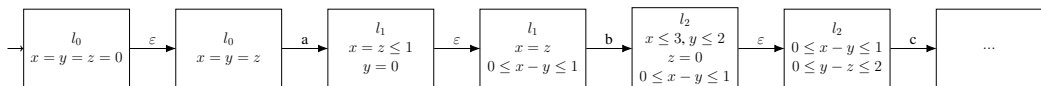

Figure 5: Zone Graph with alternating sequences

Figure 6: Zone Graph of  $A_1$  (Figure 1a) and  $A_2$  (Figure 1b)

Figure 7: Road map for chapter 3

transitions can be interleaved by a zero-delay transition and two delay transitions can be combined to the sum of them. Therefore, every reachable state in a TLTS can also be reached by an alternating sequence. This implies that it is feasible to only use alternating sequences in zone graphs (i.e., we only allow an action transition after an  $\varepsilon$ -transition and an  $\varepsilon$ -transition after an action transition). Figure 5 shows how this avoids the exponential growth of zone graphs.

Unfortunately, any notion of equivalence based on zone graphs is too course-grained to provide a sound basis for timed bisimilarity checking as we illustrate by the following example.

**Example 2.8.** The attempt to check timed bisimilarity with the help of zone graphs basically has two main problems. The first problem concerns the case in which the set of clocks are not equal. How should the elapsed time be measured and compared between both? The second problem, illustrated by this example, is the non-observability of clock resets. To illustrate the non-observability, we consider TA  $A_1$  and  $A_2$  of Figure 1. Both have exactly the same zone graph, shown in Figure 6. As we have already seen in Example 2.3,  $A_1$  and  $A_2$  are not timed bisimilar, due to the state  $(A, x = 1)$ . Therefore, there are two non-bisimilar TA with the same zone graph and no algorithm that is based solely on zone graphs is able to return true if and only if the corresponding TA are timed bisimilar.

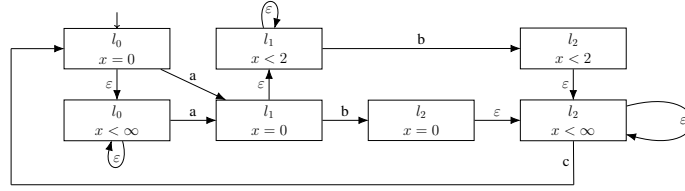
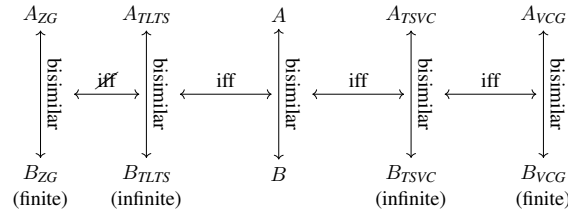
To solve these issues, we introduce virtual clocks.

### 3. Virtual Clocks

In this section, we propose an extension of zone graphs which enables sound and complete timed bisimilarity checking of TA. The road map towards this goal is shown in Figure 7. Two TA,  $A$  and  $B$ , are timed bisimilar if and only if their TLTS,  $A_{TLTS}$  and  $B_{TLTS}$ , are bisimilar (see Definition 2.4). However, as TLTS have an infinite number of states (countably many states in the discrete time model,

uncountably many states in the dense-time model), TLTS do not permit effective timed bisimilarity checking.

Although region graphs contain enough information to check for bisimulation, their unnecessarily large size makes them unusable in practice.

In contrast, the corresponding zone graphs  $A_{ZG}$  and  $B_{ZG}$  of  $A$  and  $B$  can be pruned to be finite using  $k$ -normalization and are, on average, much smaller than region graphs. Nevertheless, zone graphs do not contain enough information to ensure correctness of the bisimilarity check (see Example 2.8).

To solve this problem, we propose an extension of zone graphs. The idea is to introduce fresh clocks (one for each original clock) which do not occur in the surface syntax of the corresponding timed automata (i.e., neither in guards and resets of switches, nor in invariants of locations) and which we, therefore, call *virtual* clocks. Using virtual clocks, we solve both problems described in Example 2.8. Since both zone graphs are extended by the same number of virtual clocks, we compare the clock valuations by the virtual clocks, only. After we add virtual clocks to TLTS, resulting into the so-called TSVC, we show that the extension of zone graphs by virtual clocks, denoted  $A_{VCG}$  and  $B_{VCG}$ , preserve soundness and completeness of zone graphs and additionally contains sufficient information for correct timed bisimilarity checking. In addition, as those VCGs are proper zone graphs, we can apply  $k$ -normalization to ensure finiteness.

### 3.1. Bounded Timed Bisimulation

In this subsection, we first reconsider an alternative way to define timed bisimulation analogously to Milner in the context of CCS[23].

Two TLTS states are *bounded timed bisimilar* if both behave similar up to the next  $n$  steps. This definition eases many proof steps for the subsequent constructions as it enables inductive proof steps over timed runs with explicit mentioning of the timed step  $n$ .

#### Definition 3.1. (Bounded Timed Bisimulation for TLTS)

Let  $A_{TLTS} = (V_{TS,A}, v_{0,A}^{TS}, \Sigma \cup \mathbb{T}, \xrightarrow{TLTS})$  and  $B_{TLTS} = (V_{TS,B}, v_{0,B}^{TS}, \Sigma \cup \mathbb{T}, \xrightarrow{TLTS})$  be two TLTS.

Any state  $v_A^{TS}$  of  $A_{TLTS}$  is timed bisimilar in order zero to any state  $v_B^{TS}$  of  $B_{TLTS}$ , denoted  $v_A^{TS} \sim_0 v_B^{TS}$ .

$v_A^{TS}$  is timed bisimilar in order  $(n + 1)$  to  $v_B^{TS}$ , denoted  $v_A^{TS} \sim_{n+1} v_B^{TS}$ , if and only if it holds that

1. the existence of a transition  $v_A^{TS} \xrightarrow{TLTS} v_{1,A}^{TS}$  for  $\mu \in \Sigma \cup \mathbb{T}$  implies the existence of a transition  $v_B^{TS} \xrightarrow{TLTS} v_{1,B}^{TS}$ , with  $v_{1,A}^{TS} \sim_n v_{1,B}^{TS}$ , and
2. the existence of a transition  $v_B^{TS} \xrightarrow{TLTS} v_{1,B}^{TS}$  for  $\mu \in \Sigma \cup \mathbb{T}$  implies the existence of a transition  $v_A^{TS} \xrightarrow{TLTS} v_{1,A}^{TS}$ , with  $v_{1,A}^{TS} \sim_n v_{1,B}^{TS}$ .

$A_{TLTS}$  is *timed bisimilar in order  $n$*  to  $B_{TLTS}$ , written  $A_{TLTS} \sim_n B_{TLTS}$ , if and only if  $v_{0,A}^{TS} \sim_n v_{0,B}^{TS}$  holds.

The analog definition of bounded timed simulation of two states, denoted  $v_A^{TS} \sqsubseteq_{n+1} v_B^{TS}$ , can be found in Appendix A. A TA is *timed bisimilar in order  $n$*  to another TA, if this holds for their respective TLTS. Monotonicity states that  $v_A^{TS} \sim_{n+1} v_B^{TS}$  implies  $v_A^{TS} \sim_{n+1} v_B^{TS}$ .



**Proposition 3.1. (Monotonicity of Bounded (Bisimulation))**

Let  $A_{\text{TLTS}}$  and  $B_{\text{TLTS}}$  be two TLTS with  $v_A^{\text{TS}}$  being a state in  $A_{\text{TLTS}}$  and  $v_B^{\text{TS}}$  being a state in  $B_{\text{TLTS}}$ . For any  $n \in \mathbb{N}^{\geq 0}$ ,  $v_A^{\text{TS}} \sim_{n+1} v_B^{\text{TS}}$  implies  $v_A^{\text{TS}} \sim_n v_B^{\text{TS}}$ .

**Proof:**

See Appendix F. □

Bounded timed bisimulation converges against timed bisimulation for increasing  $n$  and ultimately gets equivalent to timed bisimulation in case of  $n \rightarrow \infty$ .

**Proposition 3.2. (Bounded Bisimulation and Bisimulation)**

Let  $A, B$  be two TA with TLTS  $A_{\text{TLTS}}, B_{\text{TLTS}}$ . Let  $v_A^{\text{TS}}$  be a state in  $A_{\text{TLTS}}$  and let  $v_B^{\text{TS}}$  be a state in  $B_{\text{TLTS}}$ . There exists a timed bisimulation  $R$  with  $(v_A^{\text{TS}}, v_B^{\text{TS}}) \in R$ , if and only if  $\forall n \in \mathbb{N}^{\geq 0} : v_A^{\text{TS}} \sim_n v_B^{\text{TS}}$  holds.

**Proof:**

See Appendix G. □

Moreover, since both propositions include the case in which  $v_A^{\text{TS}} = v_{0,A}^{\text{TS}}$ , respectively  $v_B^{\text{TS}} = v_{0,B}^{\text{TS}}$ , the proposition also holds for  $A_{\text{TLTS}}$  and  $B_{\text{TLTS}}$  itself.

**3.2. Timed Labeled Transition Systems with Virtual Clocks**

To prove correctness of the following constructions, we extend, as a purely theoretical base-line, the TLTS semantics by virtual clocks. Two TSVC are bisimilar if and only if their corresponding TLTS are bisimilar.

We supplement  $A_{\text{TLTS}}$  and  $B_{\text{TLTS}}$  by a *common* set of fresh clock variables  $\chi$ . We call these clocks virtual because they are only used for checking timed bisimilarity but never occur in any clock constraint of the TA. As we will show, it suffices to add exactly one *virtual* clock  $\chi_i$  for each original clock  $c_i \in C_A \cup C_B$ . To ensure freshness, we assume that  $\forall i \in \mathbb{N}^{\geq 0} : \chi_i \notin C$  for any set of clocks  $C$  used in a TA under consideration which is easily achievable by applying alpha conversion of the original clock names.

**Definition 3.2. (TA with Virtual Clocks)**

Given two TA  $A = (L_A, l_{0,A}, \Sigma, C_A, I_A, E_A)$  and  $B = (L_B, l_{0,B}, \Sigma, C_B, I_B, E_B)$ , we define a TA with virtual clocks as  $\text{add-virtual}(A, B) = (L_A, l_{0,A}, \Sigma, C_A \cup \{\chi_0, \dots, \chi_{|C_A|+|C_B|-1}\}, I_A, E_A)$ .

The TA  $\text{add-virtual}(A, B)$  is a proper TA according to Definition 2.1 which equals TA  $A$  except for the newly added set of virtual clocks (one for each clock in  $C_A$  and in  $C_B$ ). These newly added clocks, however, never occur in any clock constraint or clock reset of the TA  $\text{add-virtual}(A, B)$ . As the newly added clocks behave like proper clocks, the TLTS semantics of TA  $\text{add-virtual}(A, B)$  with virtual clocks (TSVC) is defined according to Definition 2.3.

**Definition 3.3. (TSVC)**

Given two TA  $A$  and  $B$  defined over  $C_A$  and  $C_B$ , respectively, we define the *TSVC of  $A$  regarding  $B$*  to be the TLTS of  $\text{add-virtual}(A, B)$ . Given a clock valuation  $u : C_A \cup \{\chi_0, \dots, \chi_{|C_A|+|C_B|-1}\} \rightarrow \mathbb{T}$ , we use the following notations:

$$\begin{aligned} \text{orig} &: (C_A \cup \{\chi_0, \dots, \chi_{|C_A|+|C_B|-1}\} \rightarrow \mathbb{T}) \rightarrow (C_A \rightarrow \mathbb{T}), \\ \text{virt} &: (C_A \cup \{\chi_0, \dots, \chi_{|C_A|+|C_B|-1}\} \rightarrow \mathbb{T}) \rightarrow (\{\chi_0, \dots, \chi_{|C_A|+|C_B|-1}\} \rightarrow \mathbb{T}), \\ \text{virt-A} &: (C_A \cup \{\chi_0, \dots, \chi_{|C_A|+|C_B|-1}\} \rightarrow \mathbb{T}) \rightarrow (\{\chi_0, \dots, \chi_{|C_A|-1}\} \rightarrow \mathbb{T}), \text{ and} \\ \text{virt-B} &: (C_A \cup \{\chi_0, \dots, \chi_{|C_A|+|C_B|-1}\} \rightarrow \mathbb{T}) \rightarrow (\{\chi_{|C_A|}, \dots, \chi_{|C_A|+|C_B|-1}\} \rightarrow \mathbb{T}), \end{aligned}$$

such that  $\forall c \in C_A : \text{orig}(u)(c) = u(c)$ ,  $\forall c \in \{\chi_0, \dots, \chi_{|C_A|+|C_B|-1}\} : \text{virt}(u)(c) = u(c)$ ,  $\forall c \in \{\chi_0, \dots, \chi_{|C_A|-1}\} : \text{virt-A}(u)(c) = u(c)$ , and  $\forall c \in \{\chi_{|C_A|}, \dots, \chi_{|C_A|+|C_B|-1}\} : \text{virt-B}(u)(c) = u(c)$  always hold.

Given a clock valuation  $u$ ,  $\text{orig}(u)$  restricts  $u$  to the valuation of the original clocks from TA  $A$ , whereas  $\text{virt}$ ,  $\text{virt-A}$ ,  $\text{virt-B}$  restricts  $u$  to all virtual clocks, to those related to clocks of  $A$  and to those related to clocks of  $B$ , respectively. We consider this asymmetric way of defining a TA with virtual clocks for a TA  $A$  regarding TA  $B$  to ensure a clear correspondence between virtual clocks to their original counter-parts in the following. We therefore presume some canonical ordering on a set of clocks  $C$  and refer to the  $j$ th clock in  $C$  by  $C[j]$ , where  $j$  ranges from 0 to  $|C| - 1$ .

While the virtual clocks will be our solution to the first main problem, namely that  $C_A$  and  $C_B$  are disjoint, we can also use them to solve the second main problem, namely that resets can be masked by clock constraints. To solve this issue, we define two main classes of TSVC states. In *synchronized* states, all virtual clock values are equal to the corresponding original clock values. *Semi-synchronized* states are former synchronized states, in which a set of original clocks (which can be empty) has been reset.

**Definition 3.4. (Classes of TSVC States)**

Let  $A_{\text{TSVC}}$  be the TSVC of TA  $A$  regarding  $B$  and  $B_{\text{TSVC}}$  be the TSVC of TA  $B$  regarding  $A$ .

- State  $(l_A, u_A)$  of  $A_{\text{TSVC}}$  is *AB-semi-synchronized*, if and only if

$$\forall i \in [0, |C_A| - 1] : (u_A(C_A[i]) = u_A(\chi_i) \vee u_A(C_A[i]) = 0).$$

- State  $(l_A, u_A)$  of  $A_{\text{TSVC}}$  is *AB-synchronized*, if and only if

$$\forall i \in [0, |C_A| - 1] : u_A(C_A[i]) = u_A(\chi_i).$$

- State  $(l_B, u_B)$  of  $B_{\text{TSVC}}$  is *AB-semi-synchronized*, if and only if

$$\forall i \in [0, |C_B| - 1] : (u_B(C_B[i]) = u_B(\chi_{i+|C_A|}) \vee u_B(C_B[i]) = 0).$$

- State  $(l_B, u_B)$  of  $B_{\text{TSVC}}$  is *AB-synchronized*, if and only if

$$\forall i \in [0, |C_B| - 1] : u_B(C_B[i]) = u_B(\chi_{i+|C_A|}).$$

Thus, if a state is AB-synchronized it is also AB-semi-synchronized but not vice-versa.

Let  $((l_A, u_A), (l_B, u_B))$  be a pair of states, where  $(l_A, u_A)$  is an AB-synchronized state of  $A_{\text{TSVC}}$  and  $(l_B, u_B)$  is an AB-synchronized state of  $B_{\text{TSVC}}$ . Then from  $\text{virt}(u_A) = \text{virt}(u_B)$  it follows that:

$$\forall i \in [0, |C_A| - 1] : u_A(C_A[i]) = u_A(\chi_i) = u_B(\chi_i)$$

and, analogously,

$$\forall i \in [0, |C_B| - 1] : u_B(C_B[i]) = u_B(\chi_{i+|C_A|}) = u_A(\chi_{i+|C_A|}).$$

In other words, given a pair of AB-synchronized states with equal virtual clock values, the first state contains the current values of the original clocks of the second state in the shared set of additional virtual clocks and vice versa. In the following proposition, we show that any transition from an AB-synchronized state in a TSVC leads to an AB-semi-synchronized state.

**Proposition 3.3. (Outgoing Transitions of AB-synchronized States)**

Let  $A_{\text{TSVC}}$  be the TSVC of TA  $A$  regarding  $B$ ,  $B_{\text{TSVC}}$  be the TSVC of TA  $B$  regarding  $A$ ,  $v_A^{\text{TV}}$  be an AB-synchronized state of  $A_{\text{TSVC}}$ , and  $v_B^{\text{TV}}$  be an AB-synchronized state of  $B_{\text{TSVC}}$ .

- If  $v_A^{\text{TV}} \xrightarrow[T_{\text{SVC}}]{d} v_{d,A}^{\text{TV}}$  with  $d \in \mathbb{T}$ , then  $v_{d,A}^{\text{TV}}$  is AB-synchronized.
- If  $v_A^{\text{TV}} \xrightarrow[T_{\text{SVC}}]{\sigma} v_{\sigma,A}^{\text{TV}}$  with  $\sigma \in \Sigma$ , then  $v_{\sigma,A}^{\text{TV}}$  is AB-semi-synchronized.
- If  $v_B^{\text{TV}} \xrightarrow[T_{\text{SVC}}]{d} v_{d,B}^{\text{TV}}$  with  $d \in \mathbb{T}$ , then  $v_{d,B}^{\text{TV}}$  is AB-synchronized.
- If  $v_B^{\text{TV}} \xrightarrow[T_{\text{SVC}}]{\sigma} v_{\sigma,B}^{\text{TV}}$  with  $\sigma \in \Sigma$ , then  $v_{\sigma,B}^{\text{TV}}$  is AB-semi-synchronized.

**Proof:**

See Appendix H. □

Given an AB-semi-synchronized state, we can obtain an AB-synchronized state by resetting the virtual clocks that correspond to the resetted original clocks. We call this procedure *synchronization*.

**Definition 3.5. (Synchronization of AB-semi-synchronized States)**

Let  $A_{\text{TSVC}}$  be the TSVC of TA  $A$  regarding  $B$ ,  $B_{\text{TSVC}}$  be the TSVC of TA  $B$  regarding  $A$ ,  $(l_A, u_A)$  be an AB-semi-synchronized state of  $A_{\text{TSVC}}$  and  $(l_B, u_B)$  be an AB-semi-synchronized state of  $B_{\text{TSVC}}$  such that  $\text{virt}(u_A) = \text{virt}(u_B)$  holds. We define the sync function for states

$$\text{sync} : V_{\text{TV},A} \times V_{\text{TV},B} \rightarrow V_{\text{TV},A} \times V_{\text{TV},B}$$

such that

$$\text{sync}((l_A, u_A), (l_B, u_B)) = ((l_A, u_{e,A}), (l_B, u_{e,B}))$$

with

$$u_{e,A} : C_A \cup \{\chi_0, \dots, \chi_{|C_A|+|C_B|-1}\} \rightarrow \mathbb{T} \quad u_{e,B} : C_B \cup \{\chi_0, \dots, \chi_{|C_A|+|C_B|-1}\} \rightarrow \mathbb{T}$$

$$\begin{aligned}
\text{orig}(u_{e,A}) &= \text{orig}(u_A), & \text{orig}(u_{e,B}) &= \text{orig}(u_B) \\
\text{virt-A}(u_{e,A})(\chi_i) &= \begin{cases} u_A(\chi_i), & \text{if } u_A(C_A[i]) \neq 0, \\ 0, & \text{else,} \end{cases} & \text{virt-A}(u_{e,B})(\chi_i) &= \begin{cases} u_B(\chi_i), & \text{if } u_A(C_A[i]) \neq 0, \\ 0, & \text{else,} \end{cases} \\
\text{virt-B}(u_{e,A})(\chi_{|C_A|+i}) &= \begin{cases} u_A(\chi_{|C_A|+i}), & \text{if } u_B(C_B[i]) \neq 0, \\ 0, & \text{else,} \end{cases} & \text{virt-B}(u_{e,B})(\chi_{|C_A|+i}) &= \begin{cases} u_B(\chi_{|C_A|+i}), & \text{if } u_B(C_B[i]) \neq 0, \\ 0, & \text{else.} \end{cases}
\end{aligned}$$

The following proposition shows that the sync function converts AB-semi-synchronized states into AB-synchronized states as expected.

**Proposition 3.4. (Properties of sync for States)**

Let  $A_{\text{TSVC}}$  be the TSVC of TA  $A$  regarding  $B$ ,  $B_{\text{TSVC}}$  be the TSVC of TA  $B$  regarding  $A$ , let  $(l_A, u_A)$  be an AB-semi-synchronized state of  $A_{\text{TSVC}}$  and  $(l_B, u_B)$  be an AB-semi-synchronized state of  $B_{\text{TSVC}}$  such that  $\text{virt}(u_A) = \text{virt}(u_B)$  holds. Then, it holds that

$$\text{sync}((l_A, u_A), (l_B, u_B)) = ((l_A, u_{e,A}), (l_B, u_{e,B}))$$

is a pair of AB-synchronized states with  $(l_A, u_{e,A})$  being a state of  $A_{\text{TSVC}}$ ,  $(l_B, u_{e,B})$  being a state of  $B_{\text{TSVC}}$ , and  $\text{virt}(u_{e,A}) = \text{virt}(u_{e,B})$ .

**Proof:**

See Appendix I. □

Synchronization of already synchronized states has no effect.

**Proposition 3.5. (sync on AB-synchronized States)**

Let  $A_{\text{TSVC}}$  be the TSVC of TA  $A$  regarding  $B$ ,  $B_{\text{TSVC}}$  be the TSVC of TA  $B$  regarding  $A$ , let  $(l_A, u_A)$  be an AB-synchronized state of  $A_{\text{TSVC}}$  and  $(l_B, u_B)$  be an AB-synchronized state of  $B_{\text{TSVC}}$  such that  $\text{virt}(u_A) = \text{virt}(u_B)$ .

$$\text{sync}(v_A^{\text{TV}}, v_B^{\text{TV}}) = (v_A^{\text{TV}}, v_B^{\text{TV}})$$

holds.

**Proof:**

See Appendix J. □

The following example shows the impact of the virtual clocks and the sync function.

**Example 3.1.** Figure 8 shows (small) extracts from the TSVC of  $A_2$  regarding  $A_4$  and the TSVC  $A_4$  regarding  $A_2$  (Figure 1). Since we require the set of clocks to be disjoint, we rename the original clocks to  $x_2$ ,  $x_4$ , and  $y_4$ . Since there are three original clocks, we add three virtual clocks,  $\chi_0$ ,  $\chi_1$ , and  $\chi_2$ . Initially, all clocks are set to zero, which implies that both initial states are  $A_2A_4$ -synchronized

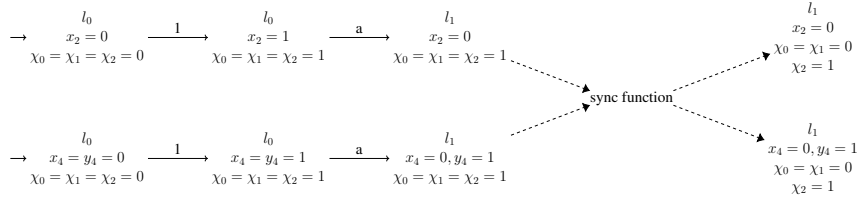

Figure 8: Extracts of the TSVC of  $A_2$  regarding  $A_4$  and  $A_4$  regarding  $A_2$

and  $\text{virt}(u_{0,A_2}) = \text{virt}(u_{0,A_4})$  holds. After a delay transition, all clock values are increased and the previously described properties still hold. After the action transition,  $x_2$  and  $x_4$  are reset. While the virtual parts of the clock valuations are still equivalent, due to  $\chi_0 = 1 \neq 0 = x_2$  and  $\chi_1 = 1 \neq 0 = x_4$  the states are not  $A_2A_4$ -synchronized but only  $A_2A_4$ -semi-synchronized. Finally, the sync function is used to reset the corresponding virtual clocks and the result is  $A_2A_4$ -synchronized, again.

Since any invariant, guard, or reset of a TA refers to an original clock, but the sync changes only virtual clocks, the sync function does not have any impact on the overall structure of the TLTS, but changes carried information only. Therefore, it is intuitively clear that we can define timed bisimulation equivalent to Definition 2.4 but using TSVC instead of TLTS.

### Definition 3.6. (Timed Bisimulation using TSVC)

Assume two TA  $A, B$  with TSVC  $A_{\text{TSVC}}$  of  $A$  regarding  $B$  and TSVC  $B_{\text{TSVC}}$  of  $B$  regarding  $A$  using the same alphabet  $\Sigma$ . Let  $v_A^{\text{TV}} = (l_A, u_A)$  be an AB-semi-synchronized state of  $A_{\text{TSVC}}$  and let  $v_B^{\text{TV}} = (l_B, u_B)$  be an AB-semi-synchronized state of  $B_{\text{TSVC}}$ .

We define  $v_A^{\text{TV}}$  to be virtually bisimilar in order  $n = 0$  to  $v_B^{\text{TV}}$ , denoted  $v_A^{\text{TV}} \sim_0 v_B^{\text{TV}}$ , if and only if  $\text{virt}(u_A) = \text{virt}(u_B)$  holds.

We define  $v_A^{\text{TV}}$  to be virtually bisimilar in order  $n+1$  to  $v_B^{\text{TV}}$ , denoted  $v_A^{\text{TV}} \sim_{n+1} v_B^{\text{TV}}$ , if and only if  $\text{virt}(u_A) = \text{virt}(u_B)$  and for the AB-synchronized states

$$(v_{e,A}^{\text{TV}}, v_{e,B}^{\text{TV}}) = \text{sync}(v_A^{\text{TV}}, v_B^{\text{TV}})$$

the existence of a transition  $v_{e,A}^{\text{TV}} \xrightarrow{\mu}_{\text{TSVC}} v_{\mu,e,A}^{\text{TV}}$  implies the existence of a transition  $v_{e,B}^{\text{TV}} \xrightarrow{\mu}_{\text{TSVC}} v_{\mu,e,B}^{\text{TV}}$  with  $v_{\mu,e,A}^{\text{TV}} \sim_n v_{\mu,e,B}^{\text{TV}}$  and the existence of a transition  $v_{e,B}^{\text{TV}} \xrightarrow{\mu}_{\text{TSVC}} v_{\mu,e,B}^{\text{TV}}$  implies the existence of a transition  $v_{e,A}^{\text{TV}} \xrightarrow{\mu}_{\text{TSVC}} v_{\mu,e,A}^{\text{TV}}$  with  $v_{\mu,e,B}^{\text{TV}} \sim_n v_{\mu,e,A}^{\text{TV}}$ .

$A_{\text{TSVC}}$  is virtually bisimilar in order  $n$  to  $B_{\text{TSVC}}$ , denoted  $A_{\text{TSVC}} \sim_n B_{\text{TSVC}}$ , if and only if  $v_{0,A}^{\text{TV}} \sim_n v_{0,B}^{\text{TV}}$  holds.  $A_{\text{TSVC}}$  is virtually bisimilar to  $B_{\text{TSVC}}$ , denoted  $A_{\text{TSVC}} \sim B_{\text{TSVC}}$ , if and only if  $\forall n \in \mathbb{N}^{\geq 0} : A_{\text{TSVC}} \sim_n B_{\text{TSVC}}$  holds.

The following theorem shows that it is sound to use Definition 3.6 instead of Definition 3.1 when checking for timed bisimilarity of two TA.

### Theorem 3.1. (Timed Bisimulation using TSVC is correct)

Let  $A_{\text{TSVC}}$  be the TSVC of TA  $A$  regarding  $B$ ,  $B_{\text{TSVC}}$  be the TSVC of TA  $B$  regarding  $A$ .  $A \sim_n B$  holds if and only if  $A_{\text{TSVC}} \sim_n B_{\text{TSVC}}$  holds.  $A \sim B$  is equivalent to  $A_{\text{TSVC}} \sim B_{\text{TSVC}}$ .

**Proof:**

See Appendix K. □

Analogously to TLTS, TSVC are also infinite and cannot be used to effectively check for timed bisimulation. However, the following example shows how checking for timed bisimulation using TSVC works in theory.

**Example 3.2.** We reuse the extracts of the TSVCs shown in Figure 8. Some states that appear in the figure actually have an infinite number of outgoing transitions. However, we only consider the transitions shown to illustrate the construction.

To check for bisimulation of the initial states, we first have to show that the used clock valuations have the same virtual part. This is the case since all virtual clocks are set to zero. Since both initial states are  $A_2A_4$ -synchronized, applying the sync function does not change the states. Therefore, we only have to check, whether for each of their outgoing transitions there exists an outgoing transition at the other state using the same label such that the target states are bisimilar. Since we only consider the transitions shown in the extract, we proceed by using the transitions labeled with 1 in both TSVC.

Once again, the virtual parts of the clock valuations are the same and since both states are  $A_2A_4$ -synchronized, we proceed by using the transition labeled with  $a$ .

We first recognize that the virtual parts of the clock valuations are equal. However, the states are  $A_2A_4$ -semi-synchronized but not  $A_2A_4$ -synchronized. Therefore, we have to check the outgoing transitions of the output of the sync function. Since the extract shows none of them, and we only consider those transitions shown in the extract, we are done.

Of course, if we would consider all transitions of the TSVC, we would recognize that some of them would violate Definition 3.6 due to the same reasons we have already discussed in Example 2.3.

Now that we have seen how virtual clocks affect the TLTS, we next analyze the effect of virtual clocks on zone graphs.

### 3.3. Zone Graphs with Virtual Clocks

This section shows how virtual clocks are integrated into zone graphs.

**Definition 3.7. (Virtual Clock Graph (VCG))**

Let  $A$  and  $B$  be two TA. We define the *Virtual Clock Graph (VCG)* of  $A$  regarding  $B$  to be the zone graph of  $\text{add-virtual}(A, B)$ .

Since VCGs are zone graphs,  $D \wedge I(l) = D$  holds for all reachable symbolic states  $(l, D)$ . The following propositions show that a VCG has the following two crucial properties:

- *Backward stability:* Each state included in a symbolic state has a predecessor state included in the predecessor symbolic state.
- *Forward stability:* If a state, that is included in a symbolic state, has an outgoing transition to a successor state, then the symbolic state also has such an outgoing transition, and the successor state is included in the successor symbolic state.

We adapt the formal definition of backward stability by Weise and Lenzen [4] to VCG.

**Proposition 3.6. (Backward Stability of Virtual Clock Graphs)**

Assume a TA  $A$  with set of clocks  $C_A$  and locations  $l_1, l_2$ , a TA  $B$  with set of clocks  $C_B$ , the TSVC  $A_{\text{TSVC}}$  of  $A$  regarding  $B$ , and the VCG  $A_{\text{VCG}}$  of  $A$  regarding  $B$ . Let  $D_1, D_2 \in \mathcal{D}(C_A \cup \{\chi_0, \dots, \chi_{|C_A|+|C_B|-1}\})$  be zones.

It holds that whenever there exists a transition  $(l_1, D_1) \xrightarrow[VCG]{\varepsilon} (l_1, D_2)$ , then

$$\forall u_2 \in D_2 : \exists u_1 \in D_1 : \exists d \in \mathbb{T} : (l_1, u_1) \xrightarrow[TSVC]{d} (l_1, u_2)$$

and whenever there exists a transition  $(l_1, D_1) \xrightarrow[VCG]{\sigma} (l_2, D_2)$  with  $\sigma \in \Sigma$  then

$$\forall u_2 \in D_2 : \exists u_1 \in D_1 : (l_1, u_1) \xrightarrow[TSVC]{\sigma} (l_2, u_2).$$

holds.

**Proof:**

See Appendix L. □

Forward Stability is defined in a similar way. We remind the reader of the fact that any symbolic state has exactly one outgoing  $\varepsilon$ -transition.

**Proposition 3.7. (Forward Stability of Virtual Clock Graphs)**

Assume a TA  $A$  with set of clocks  $C_A$  and locations  $l_1, l_2$ , a TA  $B$  with set of clocks  $C_B$ , the TSVC  $A_{\text{TSVC}}$  of  $A$  regarding  $B$ , and the VCG  $A_{\text{VCG}}$  of  $A$  regarding  $B$ . Let  $u_1, u_2 \in (C_A \cup \{\chi_0, \dots, \chi_{|C_A|+|C_B|-1}\} \rightarrow \mathbb{T})$ .

Whenever there is a transition  $(l_1, u_1) \xrightarrow[TSVC]{d} (l_1, u_2)$  with  $d \in \mathbb{T}$ , then

$$\begin{aligned} &\forall D_1 \in \mathcal{D}(C_A \cup \{\chi_0, \dots, \chi_{|C_A|+|C_B|-1}\}) \text{ with } u_1 \in D_1 : \\ &\exists D_2 \in \mathcal{D}(C_A \cup \{\chi_0, \dots, \chi_{|C_A|+|C_B|-1}\}) : (l_1, D_1) \xrightarrow[VCG]{\varepsilon} (l_1, D_2) \wedge u_2 \in D_2 \end{aligned}$$

and whenever there is a transition  $(l_1, u_1) \xrightarrow[TSVC]{\sigma} (l_2, u_2)$  with  $\sigma \in \Sigma$ , then

$$\begin{aligned} &\forall D_1 \in \mathcal{D}(C_A \cup \{\chi_0, \dots, \chi_{|C_A|+|C_B|-1}\}) \text{ with } u_1 \in D_1 : \\ &\exists D_2 \in \mathcal{D}(C_A \cup \{\chi_0, \dots, \chi_{|C_A|+|C_B|-1}\}) : (l_1, D_1) \xrightarrow[VCG]{\sigma} (l_2, D_2) \wedge u_2 \in D_2 \end{aligned}$$

holds.

**Proof:**

See Appendix M. □

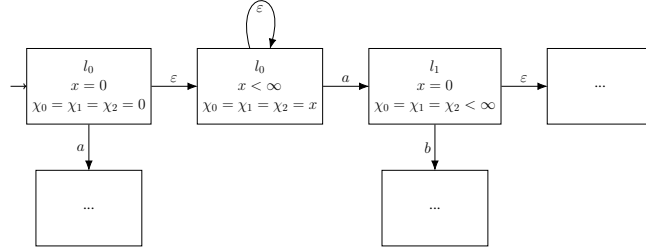
Figure 9: Extract of the VCG of  $A_2$  regarding  $A_4$ 

The following example illustrates forward and backward stability.

**Example 3.3.** Figure 9 shows an extract of the VCG of  $A_2$  regarding  $A_4$  (Figure 1). We remind the reader of Figure 8, which shows an extract of the corresponding TSVC. We denote the initial symbolic state by  $(l_0, D_0)$ , the second symbolic state by  $(l_0, D_\varepsilon)$ , and the third symbolic state by  $(l_1, D_1)$ . With  $(l_0, u_0)$ , we denote the initial state of the TSVC of  $A_2$  regarding  $A_4$ , the second state by  $(l_0, u_{0,1})$ , and the third by  $(l_1, u_1)$ .

Since  $u_{0,1} \in D_\varepsilon$  holds,  $(l_0, u_{0,1}) \in (l_0, D_\varepsilon)$  is implied. Backward stability means that due to the  $\varepsilon$ -transition from  $(l_0, D_0)$  to  $(l_0, D_\varepsilon)$ , there exists a state in  $(l_0, D_0)$  such that there exists a delay transition to  $(l_0, u_{0,1})$ . This is the case, since  $(l_0, u_0) \in (l_0, D_0)$  holds and Figure 8 shows the transition  $(l_0, u_0) \xrightarrow{1}_{TSVC} (l_0, u_{0,1})$ .

Forward stability means that the transition  $(l_0, u_{0,1}) \xrightarrow{a}_{TSVC} (l_1, u_1)$  implies the existence of the transition  $(l_0, D_\varepsilon) \xrightarrow{a}_{VCG} (l_1, D_1)$ , which is shown in Figure 9, such that  $(l_1, u_1) \in (l_1, D_1)$ , which is the case since  $u_1 \in D_1$ .

Analogous to the definition in Section 3.2, we define two classes of symbolic states. AB-synchronized symbolic states represent symbolic states where all included states are AB-synchronized, (i.e. the virtual clock values are equivalent to the corresponding original clock values). AB-semi-synchronized symbolic states represent former AB-synchronized symbolic states where a set of original clocks has been reset.

### Definition 3.8. (Classes of Symbolic States)

Let  $A_{VCG}$  be the VCG of TA  $A$  regarding  $B$  and  $B_{VCG}$  be the VCG of TA  $B$  regarding  $A$ . We assume a symbolic state  $(l_A, D_A)$  of  $A_{VCG}$  with  $D_A \neq \emptyset$  of  $A_{VCG}$  and a symbolic state  $(l_B, D_B)$  of  $B_{VCG}$  with  $D_B \neq \emptyset$ .

- $(l_A, D_A)$  is *AB-semi-synchronized*, if and only if

$$\forall i \in [0, |C_A| - 1] : ((\forall u_A \in D_A : u_A(C_A[i]) = u_A(\chi_i)) \vee (\forall u_A \in D_A : u_A(C_A[i]) = 0)).$$

- $(l_A, D_A)$  is *AB-synchronized*, if and only if

$$\forall i \in [0, |C_A| - 1] : \forall u_A \in D_A : u_A(C_A[i]) = u_A(\chi_i).$$



- $(l_B, D_B)$  is *AB-semi-synchronized*, if and only if

$$\forall i \in [0, |C_B| - 1] : ((\forall u_B \in D_B : u_B(C_B[i]) = u_B(\chi_{i+|C_A|})) \vee (\forall u_B \in D_B : u_B(C_B[i]) = 0)).$$

- $(l_B, D_B)$  is *AB-synchronized*, if and only if

$$\forall i \in [0, |C_B| - 1] : \forall u_B \in D_B : u_B(C_B[i]) = u_B(\chi_{i+|C_A|}).$$

If a symbolic state is AB-synchronized then it is also AB-semi-synchronized. Moreover, for any AB-semi-synchronized symbolic state  $v^{\text{VC}}$ , any state  $v^{\text{TV}}$  with  $v^{\text{TV}} \in v^{\text{VC}}$  is AB-semi-synchronized and the same holds for any AB-synchronized symbolic state. For the outgoing transitions of an AB-synchronized symbolic state, the analog to Proposition 3.3 holds.

**Proposition 3.8. (Outgoing Transitions of AB-synchronized Symbolic States)**

Let  $A_{\text{VCG}}$  be the VCG of  $A$  regarding  $B$ ,  $B_{\text{VCG}}$  be the VCG of  $B$  regarding  $A$ ,  $v_A^{\text{VC}}$  be an AB-synchronized symbolic state of  $A_{\text{VCG}}$  and  $v_B^{\text{VC}}$  be an AB-synchronized symbolic state of  $B_{\text{VCG}}$ .

- If  $v_A^{\text{VC}} \xrightarrow[VCG]{\varepsilon} v_{\varepsilon,A}^{\text{VC}}$ , then  $v_{\varepsilon,A}^{\text{VC}}$  is AB-synchronized.
- If  $v_A^{\text{VC}} \xrightarrow[VCG]{\sigma} v_{\sigma,A}^{\text{VC}}$  with  $\sigma \in \Sigma$ , then  $v_{\sigma,A}^{\text{VC}}$  is AB-semi-synchronized.
- If  $v_B^{\text{VC}} \xrightarrow[VCG]{\varepsilon} v_{\varepsilon,B}^{\text{VC}}$ , then  $v_{\varepsilon,B}^{\text{VC}}$  is AB-synchronized.
- If  $v_B^{\text{VC}} \xrightarrow[VCG]{\sigma} v_{\sigma,B}^{\text{VC}}$  with  $\sigma \in \Sigma$ , then  $v_{\sigma,B}^{\text{VC}}$  is AB-semi-synchronized.

**Proof:**

See Appendix N. □

When defining the sync function for states (Definition 3.5), we assume that the virtual clock values of the two states to be synchronized are equivalent. Thus, before we can apply any sync function to symbolic states, we have to check that each state included in these symbolic states has a corresponding state with equivalent virtual clock values in the other symbolic state. Therefore, the following definition is concerned with comparing two zones, based on the virtual clock values.

**Definition 3.9. (Virtual Inclusion)**

Let  $C_A, C_B$  be two sets of clocks,  $n \in \mathbb{N}^{\geq 0}$ ,  $D_A \in \mathcal{D}(C_A \cup \{\chi_0, \dots, \chi_n\})$ , and  $D_B \in \mathcal{D}(C_B \cup \{\chi_0, \dots, \chi_n\})$  be two zones.

- Virtual inclusion of zones, denoted  $D_A \leq_{\text{virtual}} D_B$ , holds if and only if

$$\forall u_A \in D_A : \exists u_B \in D_B : \text{virt}(u_A) = \text{virt}(u_B).$$

- Virtual equivalence of zones, denoted  $D_A \equiv_{\text{virtual}} D_B$ , holds if and only if  $D_A \leq_{\text{virtual}} D_B$  and  $D_B \leq_{\text{virtual}} D_A$ .

For AB-semi-synchronized symbolic states, DBM provide an natural way to implement virtual inclusion checks (see Appendix O). To understand the following sync function definition for symbolic states, it is crucial that for an AB-semi-synchronized symbolic state  $v^{\text{VC}}$  the statement

$$\forall (l, u_1), (l, u_2) \in v^{\text{VC}} : \text{virt}(u_1) = \text{virt}(u_2) \text{ implies } u_1 = u_2$$

holds. In other words, in an AB-semi-synchronized symbolic state, the virtual clock values uniquely identify a particular state (see Appendix P). We define the sync function for symbolic states such that the result contains the results of each individual application of the sync for states. Using virtual equivalence, we ensure that for each included state there exists exactly a single corresponding state in the other symbolic state.

**Definition 3.10. (sync Function for Symbolic States)**

Let  $A_{\text{VCG}}$  be the VCG of TA  $A$  regarding  $B$ ,  $B_{\text{VCG}}$  be the VCG of TA  $B$  regarding  $A$ ,  $(l_A, D_A)$  be an AB-semi-synchronized symbolic state of  $A_{\text{VCG}}$ ,  $(l_B, D_B)$  be an AB-semi-synchronized symbolic state of  $B_{\text{VCG}}$  with  $D_A \equiv_{\text{virtual}} D_B$ . We define the sync function

$$\text{sync} : V_{\text{VC},A} \times V_{\text{VC},B} \rightarrow V_{\text{VC},A} \times V_{\text{VC},B}$$

such that

$$\text{sync}(v_A^{\text{VC}}, v_B^{\text{VC}}) = ((l_A, D_{e,A}), (l_B, D_{e,B}))$$

with

$$\begin{aligned} D_{e,A} = \{ & u_{e,A} \in (C_A \cup \{\chi_0, \dots, \chi_{|C_A|+|C_B|-1}\}) \rightarrow \mathbb{T} \mid \\ & \exists v_A^{\text{TV}} \in v_A^{\text{VC}} : \exists v_B^{\text{TV}} \in v_B^{\text{VC}} : \exists u_{e,B} \in (C_B \cup \{\chi_0, \dots, \chi_{|C_A|+|C_B|-1}\}) \rightarrow \mathbb{T} : \\ & ((l_A, u_{e,A}), (l_B, u_{e,B})) = \text{sync}(v_A^{\text{TV}}, v_B^{\text{TV}}) \} \end{aligned}$$

and

$$\begin{aligned} D_{e,B} = \{ & u_{e,B} \in (C_B \cup \{\chi_0, \dots, \chi_{|C_A|+|C_B|-1}\}) \rightarrow \mathbb{T} \mid \\ & \exists v_A^{\text{TV}} \in v_A^{\text{VC}} : \exists v_B^{\text{TV}} \in v_B^{\text{VC}} : \exists u_{e,A} \in (C_A \cup \{\chi_0, \dots, \chi_{|C_A|+|C_B|-1}\}) \rightarrow \mathbb{T} : \\ & ((l_A, u_{e,A}), (l_B, u_{e,B})) = \text{sync}(v_A^{\text{TV}}, v_B^{\text{TV}}) \}. \end{aligned}$$

The sync function for states is calculated by checking whether an original clock has been set to zero and to reset the corresponding virtual clock. Therefore, an analogue procedure is possible to compute the sync function for symbolic states.

**Proposition 3.9. (Properties of sync for Symbolic States)**

Let  $A_{\text{VCG}}$  be the VCG of TA  $A$  regarding  $B$ ,  $B_{\text{VCG}}$  be the VCG of TA  $B$  regarding  $A$ ,  $(l_A, D_A)$  be an AB-semi-synchronized symbolic state of  $A_{\text{VCG}}$ ,  $(l_B, D_B)$  be an AB-semi-synchronized symbolic state of  $B_{\text{VCG}}$  with  $D_A \equiv_{\text{virtual}} D_B$ . We define  $R = R_A \cup R_B$  with

- $R_A = \{\chi_i \mid i \in [0, |C_A| - 1] \wedge \forall u_A \in D_A : u_A(C_A[i]) = 0\}$ , and

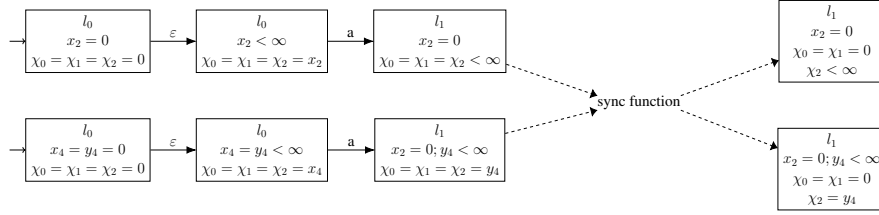
Figure 10: Extracts of the VCG of  $A_2$  regarding  $A_4$  and  $A_4$  regarding  $A_2$ 

- $R_B = \{\chi_{i+|C_A|} \mid i \in [0, |C_B| - 1] \wedge \forall u_B \in D_B : u_B(C_B[i]) = 0\}$ , respectively.

The statements

$$\text{sync}(v_A^{\text{VC}}, v_B^{\text{VC}}) = ((l_A, R(D_A)), (l_B, R(D_B)))$$

and  $R(D_A) \equiv_{\text{virtual}} R(D_B)$  hold. The resulting symbolic states are AB-synchronized.

**Proof:**

See Appendix Q. □

Again, DBMs provide an effective formalism to check whether  $\forall u_A \in D_A : u_A(C_A[i]) = 0$  or  $\forall u_B \in D_B : u_B(C_B[i]) = 0$  hold. Therefore, the sync function for symbolic states can be implemented by finding and applying the corresponding reset sets. Analogously to AB-synchronized states, also AB-synchronized symbolic states are not affected if the sync function is applied to them.

**Proposition 3.10. (sync on Synchronized Symbolic States)**

Let  $A_{\text{VCG}}$  be the VCG of  $A$  regarding  $B$ ,  $B_{\text{VCG}}$  be the VCG of  $B$  regarding  $A$ ,  $(l_A, D_A)$  be an AB-synchronized symbolic state of  $A_{\text{VCG}}$ ,  $(l_B, D_B)$  be an AB-synchronized symbolic state of  $B_{\text{VCG}}$  with  $D_A \equiv_{\text{virtual}} D_B$ . Then, it holds that:

$$\text{sync}((l_A, D_A), (l_B, D_B)) = ((l_A, D_A), (l_B, D_B)).$$

**Proof:**

See Appendix R. □

The following example shows the impact of the sync function, analogously to Example 3.1.

**Example 3.4.** Figure 10 shows (small) extracts from the VCG of  $A_2$  regarding  $A_4$  and the VCG of  $A_4$  regarding  $A_2$ . We renamed the clocks analogously to Example 3.1. Once again, we add three virtual clocks (since  $A_2$  has a single original clock, while  $A_4$  has two). Initially, all clocks are set to zero, which implies that both initial symbolic states are  $A_2A_4$ -synchronized and  $D_{0,A_2} \equiv_{\text{virtual}} D_{0,A_4}$  holds. Both properties also hold after the  $\varepsilon$ -transition. After the action transition,  $x_2$  and  $x_4$  are reset. While the virtual clock values of both symbolic states are still the same, the symbolic states are not  $A_2A_4$ -synchronized anymore. We use the sync function to reset the corresponding virtual clocks and the result is  $A_2A_4$ -synchronized again.

We are now able to define a bisimulation equivalence for VCG. Analogously to Definition 3.6 we only show the definition of virtual bisimulation here and refer the reader to Appendix U for the similar definition of virtual simulation, denoted  $A_{\text{VCG}} \sqsubseteq_n B_{\text{VCG}}$ .

**Definition 3.11. (Virtual Bisimulation for VCGs)**

Assume two TA  $A, B$  with VCG  $A_{\text{VCG}}$  of  $A$  regarding  $B$  and VCG  $B_{\text{VCG}}$  of  $B$  regarding  $A$ , using the same alphabet  $\Sigma$ . Let  $(l_A, D_A)$  be an AB-semi-synchronized symbolic state of  $A_{\text{VCG}}$  and let  $(l_B, D_B)$  be an AB-semi-synchronized symbolic state of  $B_{\text{VCG}}$ .

We define  $(l_A, D_A)$  to be virtually bisimilar in order  $n = 0$  to  $(l_B, D_B)$ , denoted  $(l_A, D_A) \sim_0 (l_B, D_B)$ , if and only if  $D_A \equiv_{\text{virtual}} D_B$  holds.

We define  $(l_A, D_A)$  to be virtually bisimilar in order  $n + 1$  to  $(l_B, D_B)$ , denoted  $(l_A, D_A) \sim_{n+1} (l_B, D_B)$ , if and only if  $D_A \equiv_{\text{virtual}} D_B$  and for the AB-synchronized symbolic states

$$((l_A, D_{e,A}), (l_B, D_{e,B})) = \text{sync}((l_A, D_A), (l_B, D_B))$$

the existence of an outgoing transition  $(l_A, D_{e,A}) \xrightarrow[VCG]{\mu} (l_{\mu,A}, D_{\mu,A})$  implies the existence of a finite set of symbolic states  $\{(l_{\mu,A}, D_{\mu,0,A}), (l_{\mu,A}, D_{\mu,1,A}), \dots\}$  with  $(\bigcup D_{\mu,i,A}) = D_{\mu,A}$  and for any  $(l_{\mu,A}, D_{\mu,i,A})$  exists an outgoing transition  $(l_B, D_{e,B}) \xrightarrow[VCG]{\mu} (l_{\mu,B}, D_{\mu,B})$  such that there exists a zone  $D_{\mu,i,B} \subseteq D_{\mu,B}$  with  $(l_{\mu,A}, D_{\mu,i,A}) \sim_n (l_{\mu,B}, D_{\mu,i,B})$  and the existence of an outgoing transition  $(l_B, D_{e,B}) \xrightarrow[VCG]{\mu} (l_{\mu,B}, D_{\mu,B})$  implies the existence of a finite set of symbolic states  $\{(l_{\mu,B}, D_{\mu,0,B}), (l_{\mu,B}, D_{\mu,1,B}), \dots\}$  with  $(\bigcup D_{\mu,i,B}) = D_{\mu,B}$  and for any  $(l_{\mu,B}, D_{\mu,i,B})$  exists an outgoing transition  $(l_A, D_{e,A}) \xrightarrow[VCG]{\mu} (l_{\mu,A}, D_{\mu,A})$  such that there exists a zone  $D_{\mu,i,A} \subseteq D_{\mu,A}$  with  $(l_{\mu,B}, D_{\mu,i,B}) \sim_n (l_{\mu,A}, D_{\mu,i,A})$ .

$A_{\text{VCG}}$  is virtual bisimilar in order  $n$  to  $B_{\text{VCG}}$ , denoted  $A_{\text{VCG}} \sim_n B_{\text{VCG}}$ , if and only if  $v_{0,A}^{\text{VC}} \sim_n v_{0,B}^{\text{VC}}$  holds.  $A_{\text{VCG}}$  is virtual bisimilar to  $B_{\text{VCG}}$ , denoted  $A_{\text{VCG}} \sim B_{\text{VCG}}$ , if and only if  $\forall n \in \mathbb{N}^{\geq 0} : A_{\text{VCG}} \sim_n B_{\text{VCG}}$  holds.

Virtual bisimulation holds for two VCG, if and only if the corresponding TA are timed bisimilar.

**Theorem 3.2. (Virtual Bisimulation of VCGs is correct)**

Assume two TA  $A, B$ , the VCG  $A_{\text{VCG}}$  of  $A$  regarding  $B$ , and the VCG  $B_{\text{VCG}}$  of  $B$  regarding  $A$ .  $A \sim_n B$  holds if and only if  $A_{\text{VCG}} \sim_n B_{\text{VCG}}$  holds.  $A \sim B$  is equivalent to  $A_{\text{VCG}} \sim B_{\text{VCG}}$ .

**Proof:**

See Appendix U. □

We remind the reader of the two main challenges, described in Example 2.8. Using virtual equivalence, we can compare the timing behavior of two TA even if the set of original clocks differ. The following example shows how the second main challenge, non-observability of clock resets, is solved by using virtual clocks.

**Example 3.5.** In Example 2.8, we have seen that the zone graphs of  $A_1$  and  $A_2$  are the same despite the fact that  $A_1$  and  $A_2$  are not timed bisimilar. In Figure 11 (small) extracts of the VCG  $A_{1,\text{VCG}}$  of

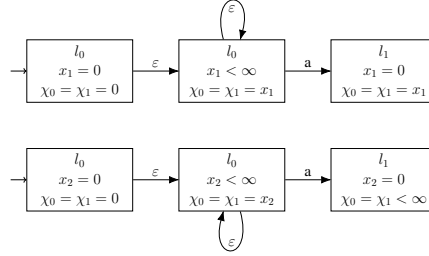
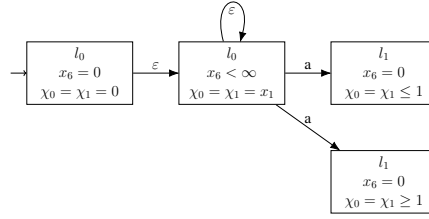
Figure 11: Extracts of the VCG  $A_{1,\text{VCG}}$  of  $A_1$  regarding  $A_2$  and the VCG  $A_{2,\text{VCG}}$  of  $A_2$  regarding  $A_1$ Figure 12: Extract of the VCG  $A_{6,\text{VCG}}$  of  $A_6$  regarding  $A_2$ 

$A_1$  regarding  $A_2$  and the VCG  $A_{2,\text{VCG}}$  of  $A_2$  regarding  $A_1$  are shown. Obviously, the VCGs differ. In  $A_{1,\text{VCG}}$ , the original clock is not reset during the action labeled transition. Therefore, the virtual clock values are the same as the value of  $x_1$ , which is equal to zero. In contrast, the virtual clock values in  $A_{2,\text{VCG}}$  can be greater than zero and the VCGs of  $A_1$  and  $A_2$  are not the same.

Using Theorem 3.2, we can also check for timed bisimilarity of non-deterministic TA.

**Example 3.6.** From Example 2.3, we know that  $A_2$  and  $A_6$  are timed bisimilar. Figure 12 shows an extract of the VCG of  $A_6$  regarding  $A_2$ . The VCG of  $A_2$  regarding  $A_6$  is equivalent to the VCG of  $A_2$  regarding  $A_1$  and, therefore, we do not redraw the extract but refer to Figure 11. The crucial part is the comparison of the symbolic states reached after the  $\varepsilon$ -transition. Since the symbolic states are virtually equivalent and  $A_2A_6$ -synchronized, we know that applying the sync function does not change the symbolic states (Proposition 3.10). The outgoing  $\varepsilon$ -transitions of those symbolic states are self-loops and, obviously, we cannot find a contradiction using the  $\varepsilon$ -transitions if we cannot find a contradiction without using them (actually, we will use this fact in the next chapter). Therefore, we only have to check the outgoing action transitions. The symbolic state of  $A_{2,\text{VCG}}$  has a single outgoing transition  $(l_0, D_\varepsilon) \xrightarrow[VCG]{a} (l_1, D_2)$ , while the symbolic state of  $A_{6,\text{VCG}}$  has two outgoing transitions  $(l_0, D_\varepsilon) \xrightarrow[VCG]{a} (l_1, D_{6,\leq 1})$  and  $(l_0, D_\varepsilon) \xrightarrow[VCG]{a} (l_1, D_{6,\geq 1})$ . We focus on the outgoing transition of  $A_{2,\text{VCG}}$ .

According to Definition 3.11, we have to find a finite set of symbolic states with  $\{(l_1, D_{0,2}), (l_1, D_{1,2}), \dots\}$  with  $(\bigcup D_{i,2}) = D_2$  and for any  $(l_1, D_{i,2})$  exists an outgoing transition  $(l_0, D_\varepsilon) \xrightarrow[VCG]{a} (l_1, D_{i,2})$ .

$D_6$ ) such that there exists a zone  $D_{i,6} \subseteq D_6$  with  $(l_1, D_{i,2}) \sim (l, D_{i,6})$ .

To do so, we split the zone  $D_2$  into the subzones  $D_{1,2} = D_2 \wedge \chi_0 \leq 1$  and  $D_{2,2} = D_2 \wedge \chi_0 > 1$ . We define  $D_{1,6} = D_{6,\leq 1}$  and  $D_{2,6} = (D_{6,\geq 1} \wedge \chi_0 > 1) \subseteq D_{6,\geq 1}$ , such that the needed properties are satisfied (under the assumptions  $(l_1, D_{i,2}) \sim (l_1, D_{i,6})$ , which actually hold).

We remind the reader of Example 2.6, which shows that zone graphs can be infinite. This can also happen to VCGs. Given two TA  $A$  and  $B$  using the sets of clocks  $C_A$  and  $C_B$ , we use the normalization function  $k : C_A \cup C_B \cup \{\chi_0, \dots, \chi_{|C_A|+|C_B|-1}\} \rightarrow \mathbb{N}^{\geq 0}$ , such that for any clock constraint  $c \sim m$ , which occurs in  $A$  or  $B$ ,  $m < k(c)$ , for any  $i \in [0, |C_A| - 1] : k(C_A[i]) = k(\chi_i)$ , and for any  $i \in [0, |C_B| - 1] : k(C_B[i]) = k(\chi_{i+|C_A|})$  hold.

**Proposition 3.11. (k-normalization preserves Virtual Bisimulation of VCGs)**

Assume two diagonal-free TA  $A, B$  using the sets of clocks  $C_A, C_B$ , with VCG  $A_{\text{VCG}}$  of  $A$  regarding  $B$  and VCG  $B_{\text{VCG}}$  of  $B$  regarding  $A$ , the AB-synchronized symbolic states  $(l_A, D_A)$  of  $A_{\text{VCG}}$  and  $(l_B, D_B)$  of  $B_{\text{VCG}}$ , and a normalization function  $k$ . Moreover, we require  $D_A \equiv_{\text{virtual}} D_B$ .

$(l_A, D_A) \sim_n (l_B, D_B)$  holds if and only if  $(l_A, \text{norm}(D_A, k)) \sim_n (l_B, \text{norm}(D_B, k))$  holds.

**Proof:**

See Appendix V. □

Therefore, we can use k-normalization during the check for virtual bisimulation and the VCGs become finite. Until now, we have described a construction, which enables us to check for timed bisimilarity. Now we describe an algorithm to effectively perform this check on two input models.

## 4. Checking for Timed Bisimulation

In this section, we present an algorithm that checks for virtual bisimulation. The function takes as input two symbolic states,  $(l_A, D_A)$  and  $(l_B, D_B)$ , one from each of the VCGs being examined, and returns a set of so-called contradictions. Each contradiction describes a symbolic substate of either  $(l_A, D_A)$  or  $(l_B, D_B)$ , which is not bisimilar to any substate of the other symbolic state. If the set of contradictions is empty, the symbolic states are virtually bisimilar. During the implementation of the construction described in Definition 3.11, two open questions remain to be solved. The first of these can be observed in Example 3.6. While for small TA, it is straightforward to see how to split the target zone, we have to solve this problem in general. As demonstrated in Example 2.7, the use of alternating sequences is necessary. The second problem we solve is to provide evidence that such sequences are indeed permissible when checking for timed bisimulation using VCGs.

First, we show how to represent contradictions. According to Theorem 3.2, we only need to check for virtual bisimulation of the initial symbolic states of the corresponding VCGs to check for bisimulation of two TA  $A$  and  $B$ . Therefore, having shown how to represent contradictions, we implement a function that, given two symbolic states, searches for such a contradiction. If no contradiction is found, the symbolic states are virtually bisimilar in a given order  $n$ . We then show that we can use alternating sequences, present our final algorithm, and compare it with the region-based approach of Čerāns [2].

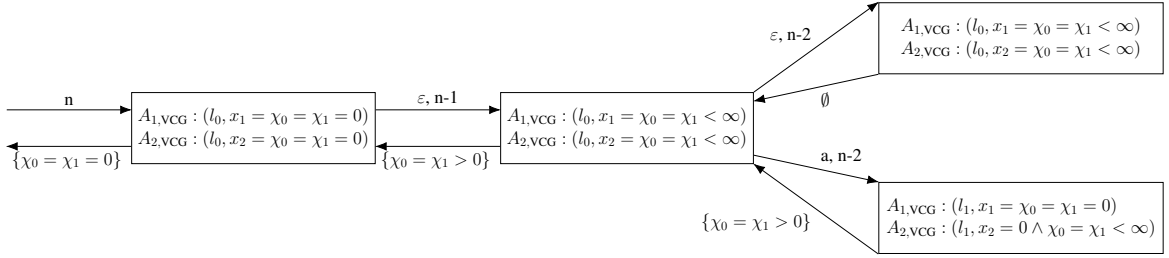

Figure 13: Illustration of Example 4.1

#### 4.1. Virtual Constraints

The main idea of the algorithm is to define a function that takes the symbolic states  $(l_A, D_A)$  and  $(l_B, D_B)$  and returns a set of so-called *virtual constraints*. The virtual constraints describe the contradictions to virtual bisimulation of the given pair of symbolic states. The following example demonstrates the input/output behavior of our algorithm.

**Example 4.1.** We reuse the extracts of the VCGs from Example 3.5 and apply our algorithm to the initial symbolic states to determine whether they are virtually bisimilar in order  $n > 1$ . This is illustrated on the left-hand side of Figure 13, where the value  $n$  is provided to the rectangle with the initial symbolic states. In accordance with Definition 3.11, we have to check whether the zones of the initial symbolic states are virtually equivalent (which is indeed the case) and we have to check all outgoing transitions. As we are only considering transitions depicted in Figure 11, we are focusing on the targets of the  $\varepsilon$ -transitions and check them for virtual bisimulation in order  $n - 1$ , as illustrated by the rectangle in the centre of Figure 13. Since the zones of the symbolic states are virtually equivalent, we have to check two pairs of outgoing transitions.

The outgoing  $\varepsilon$ -transitions (illustrated by the upper rectangle of Figure 13) of the symbolic states are both self-loops. Consequently, to check whether virtual bisimulation in order  $n - 1$  holds for this pair of symbolic states, we have to check whether virtual bisimulation in order  $n - 2$  holds for the same pair of symbolic states. Should a contradiction arise within the subsequent  $n - 2$  transitions, it will inevitably be found when we check the symbolic states for virtual bisimulation in order  $n - 1$ . Therefore, the application of the algorithm may be terminated at this point.

The transitions labeled with  $a$  (illustrated by the lower rectangle of Figure 13) lead into a pair of symbolic states that are not virtually bisimilar in order  $n - 2$ , as they are not virtually equivalent. The virtual constraint  $(\chi_0 = \chi_1 > 0)$  represents the non-overlapping part of the zones. Consequently, we expect the algorithm to return a set that contains exactly this constraint when these symbolic states are provided.

Since our checks for virtual bisimulation in order  $n - 2$  returned a contradiction, it is necessary to analyze which parts of the symbolic states in the centre of Figure 13 have a path leading to that contradiction. In  $A_{2,\text{VCG}}$ , any symbolic substate of

$$(l_0, (\chi_0 = \chi_1 = x_2) \wedge (\chi_0 = \chi_1 > 0))$$

has an outgoing action transition to the contradiction we have already found. Consequently,  $\{(\chi_0 = \chi_1 > 0)\}$  should be returned when our algorithm is applied to the symbolic states depicted in the centre of Figure 13. Since the initial symbolic states have an outgoing transition to this contradiction, the set  $\{(\chi_0 = \chi_1 = 0)\}$  is returned when the VCGs are checked for virtual bisimulation.

If the algorithm has found a contradiction, it stops. It should be noted that the algorithm returns a contradiction if one exists, but it does not guarantee the identification of all contradictions. The termination criterion described in Example 4.1 is analogous to the well-known termination criterion when checking for untimed bisimulation [24]. When we check for virtual bisimulation in order  $n$ , we assume that virtual bisimulation in order  $n - 1$  holds for this pair of symbolic states. If there is no contradiction, this assumption is validated by Proposition 3.1. Conversely, the discovery of a contradiction indicates that the assumption was an overfit and, thus, the identified contradiction remains valid.

The following definition defines virtual constraints and an operator to extract the virtual constraint from a zone.

**Definition 4.1. (extract-virtual-constraint Operator)**

Assume a set of clocks  $C$ . A constraint  $\phi \in \mathcal{B}(\{\chi_0, \chi_1, \dots, \chi_{i-1}\})$  is called the virtual constraint of a zone  $D \in \mathcal{D}(C \cup \{\chi_0, \dots, \chi_{i-1}\})$ , if and only if the following conditions hold:

1. (Soundness) For any  $u_{\text{virtual}} : \{\chi_0, \dots, \chi_{i-1}\} \rightarrow \mathbb{T}$  with  $u_{\text{virtual}} \models \phi$  exists a  $u \in D$  such that  $\text{virt}(u) = \text{virt}(u_{\text{virtual}})$  holds,
2. (Completeness) if  $u \in D$ , then  $u \models \phi$ ,
3. (Simple Structure)  $\phi$  consists of up to  $(i + 1)^2$  conjugated atomic constraints of the form  $\phi_{j,k} = (\chi_{j-1} - \chi_{k-1} \preceq_{j,k} n_{j,k})$ , with  $i, j \in [1, i]$ , and  $\phi_{j,0} = \chi_{j-1} \preceq_{j,0} n_{j,0}$  respectively  $\phi_{0,j} = -\chi_{j-1} \preceq_{0,j} n_{0,j}$  with  $\forall j, k \in [0, i] : \preceq_{j,k} \in \{<, \leq\} \wedge n_{j,k} \in \mathbb{N}^{\geq 0}$  such that  $\phi = \bigwedge_{j,k \in [0, i]} \phi_{j,k}$ , and
4. (Canonical) none of the atomic constraints of a virtual constraint can be strengthened without changing the solution set.

The operator  $\text{extract-virtual-constraint} : \mathcal{D}(C \cup \{\chi_0, \dots, \chi_{i-1}\}) \rightarrow \mathcal{B}(\{\chi_0, \chi_1, \dots, \chi_{i-1}\})$  takes a zone  $D \in \mathcal{D}(C \cup \{\chi_0, \dots, \chi_{i-1}\})$  and returns the virtual constraint of  $D$ .

Virtual constraints are stored using DBM. The  $\text{extract-virtual-constraint}$  operator is implementable as shown in Appendix W.  $D_A \equiv_{\text{virtual}} D_B$  holds if and only if

$$\text{extract-virtual-constraint}(D_A) = \text{extract-virtual-constraint}(D_B).$$

We may use the shorthand notation  $\text{extract-virtual-constraint}(\{D_0, \dots, D_m\})$  instead of

$$\{\text{extract-virtual-constraint}(D_0), \dots, \text{extract-virtual-constraint}(D_m)\}.$$

We apply this convention for any operator that we introduce from now on. It should be noted that an AB-synchronized symbolic state is uniquely identified by its location and its virtual constraint.



No logical disjunction is defined for virtual constraints. This has practical reasons as they are stored using DBMs, which are unable to handle such operations. To solve this issue, sets of virtual constraints are used, where a set of virtual constraints represents a disjunction of all included virtual constraints.

Furthermore, we introduce the shorthand notation  $\phi_A \wedge \neg\phi_B$ , which describes a set of virtual constraints such that a clock valuation  $u$  satisfies exactly one of the resulting virtual constraints if and only if  $u \models \phi_A$  and  $u \not\models \phi_B$  holds. In Appendix X, we provide a detailed account of the implementation of this operator.

**Example 4.2.** Given the virtual constraints  $\phi_1 = (\chi_0 < 3)$ ,  $\phi_2 = (\chi_0 \leq 2) \wedge (\chi_1 > 3)$ , and  $\phi_3 = (\chi_0 \leq 3)$ , we can calculate

$$\begin{aligned} \phi_1 \wedge \neg\phi_2 &= (\chi_0 < 3) \wedge \neg((\chi_0 \leq 2) \wedge (\chi_1 > 3)) \\ &= \{(\chi_0 < 3) \wedge \neg(\chi_0 \leq 2), (\chi_0 < 3) \wedge \neg(\chi_1 > 3)\} \\ &= \{(2 < \chi_0 < 3), (\chi_0 < 3) \wedge (\chi_1 \leq 3)\} \end{aligned}$$

and

$$\phi_1 \wedge \neg\phi_3 = (\chi_0 < 3) \wedge \neg(\chi_0 \leq 3) = \emptyset.$$

## 4.2. Virtual Bisimulation in Order $n$

Using virtual constraints, we can present the CHECK-FOR-VIRT-BISIM-IN-ORDER-IMPL function in Algorithm 4.1. We remind the reader of the termination criterion described in Example 4.1. In order to apply this termination criterion, a set of assumptions is required. These are pairs of symbolic states that we assume to be virtual bisimilar in order  $n$ . This set is referred to as *visited*.

The first if-statement addresses the scenarios where either  $n = 0$  holds or where the symbolic states are not virtually equivalent. In both cases, the non-overlapping parts of the zones are returned. If  $n = 0$  and the zones are virtually equivalent, this is the empty set.

If  $n > 0$  and the symbolic states are virtually equivalent, we proceed with the application of the sync function according to Definition 3.11. Afterwards, we check whether the given symbolic states are part of the assumptions. For this, we remind the reader of Proposition 3.11, which states that the normalized symbolic states (using  $k$ -normalization) are virtually bisimilar if and only if the original symbolic states are virtually bisimilar. Since we know by Proposition 2.3 that there is only a finite number of normalized symbolic states, we utilize normalized symbolic states to fill the visited set. If the normalized symbolic states are part of the assumptions, we know that we assume the given symbolic states to be virtually bisimilar in order  $n$  and return no contradiction. In the absence of such an assumption, the normalized symbolic states are added to visited for the reasons we have previously discussed in Example 4.1.

For enhanced readability, we introduce the shorthand notation FUNC for the recursive call with the extended visited set and order  $n - 1$ . We first check the outgoing  $\varepsilon$ -transitions by applying FUNC to the targets of the  $\varepsilon$ -transitions. FUNC returns the contradictions for  $(l_A, D_{\varepsilon,A})$  and  $(l_B, D_{\varepsilon,B})$ . Since we are interested in the resulting contradictions for  $(l_A, D_{e,A})$  and  $(l_B, D_{e,B})$ , we have to find those parts of  $(l_A, D_{e,A})$  and  $(l_B, D_{e,B})$  that have an outgoing transition leading to the contradictions. We

do this by utilizing the so-called revert- $\varepsilon$ -transition operator, which uses the established past operator [21]. Further details may be found in Appendix Z. If we have found a contradiction for  $(l_A, D_{e,A})$  and  $(l_B, D_{e,B})$ , we need to revert the sync operation and return the resulting contradictions. Since Proposition 3.9 shows that sync is essentially a reset operation, we can revert it with the well-known free operation [21]. For more information see Appendix AB. If we have not found a contradiction, we go on with the outgoing action transitions.

---

**Algorithm 4.1** CHECK-FOR-VIRT-BISIM-IN-ORDER-IMPL function
 

---

▷ Let  $(l_A, D_A), (l_B, D_B)$  be AB-semi-synchronized symbolic states,  
 ▷  $k : C_A \cup C_B \cup \{\chi_0, \dots, \chi_{|C_A|+|C_B|-1}\} \rightarrow \mathbb{N}^{\geq 0}$ , visited be a set, and  $n \in \mathbb{N}^{\geq 0}$ .  
 ▷ The return value of CHECK-FOR-VIRT-BISIM-IN-ORDER-IMPL is a set of virtual constraints.

```

1: function CHECK-FOR-VIRT-BISIM-IN-ORDER-IMPLAVCG, BVCG, k, visited, n((lA, DA), (lB, DB))
2:   if  $n = 0 \vee \neg(D_A \equiv_{\text{virtual}} D_B)$  then
3:     return extract-virtual-constraint(DA)  $\wedge$   $\neg$  extract-virtual-constraint(DB)  $\cup$ 
4:       extract-virtual-constraint(DB)  $\wedge$   $\neg$  extract-virtual-constraint(DA)
5:   end if
6:   ((lA, De,A), (lB, De,B))  $\leftarrow$  sync((lA, DA), (lB, DB))
7:
8:   (lA, Dnorm,A)  $\leftarrow$  (lA, norm(De,A, k)), (lB, Dnorm,B)  $\leftarrow$  (lB, norm(De,B, k))
9:   if (((lA, Dnorm,A), (lB, Dnorm,B))  $\in$  visited) then return  $\emptyset$ 
10:  new-visited  $\leftarrow$  visited  $\cup$  {((lA, Dnorm,A), (lB, Dnorm,B))}
11:  FUNC = CHECK-FOR-VIRT-BISIM-IN-ORDER-IMPLAVCG, BVCG, k, new-visited, n-1
12:
13:  ▷ Assume (lA, De,A)  $\xrightarrow[VCG]{\varepsilon}$  (lA, Dε,A) and (lB, De,B)  $\xrightarrow[VCG]{\varepsilon}$  (lB, Dε,B).
14:  ε-result  $\leftarrow$  FUNC((lA, Dε,A), (lB, Dε,B))
15:  sync-cond  $\leftarrow$  revert-ε-trans(De,A, Dε,A, ε-result  $\wedge$  extract-virtual-constraint(Dε,A))
16:     $\cup$  revert-ε-trans(De,B, Dε,B, ε-result  $\wedge$  extract-virtual-constraint(Dε,B))
17:  if (sync-cond  $\neq$   $\emptyset$ ) then return revert-sync((lA, DA), (lB, DB), sync-cond)
18:
19:  for all  $\sigma \in \Sigma$  do
20:    ▷ out-trans( $\sigma$ , (l, D)) is the set of all outgoing transitions of (l, D) labeled with  $\sigma$ .
21:    sync-cond  $\leftarrow$  CHECK-OUTGOING-TRANSITIONS-IMPLAVCG, BVCG, FUNC(De,A, De,B,
22:      out-trans( $\sigma$ , (lA, De,A)), out-trans( $\sigma$ , (lB, De,B)))
23:    if (sync-cond  $\neq$   $\emptyset$ ) then return revert-sync((lA, DA), (lB, DB), sync-cond)
24:  end for
25:  return  $\emptyset$ 
26: end function
  
```

---

To check the action transitions, we iterate through all available actions and provide all outgoing transitions of a certain action to the CHECK-OUTGOING-TRANSITIONS-IMPL operator. This operator will be explained in the subsequent section. It returns the contradictions of the outgoing action transitions. If we find a contradiction, we revert the sync and return the result. Otherwise, we proceed with

the next action. If all actions are checked without finding a contradiction, no contradiction exists and the empty set is returned.

To check for virtual bisimulation of a certain pair of symbolic states, we use the CHECK-FOR-VIRT-BISIM-IN-ORDER-IMPL function with an empty visited set. The following proposition shows the correctness of our algorithm.

**Proposition 4.1. (CHECK-FOR-VIRT-BISIM-IN-ORDER-IMPL is correct)**

Assume two TA  $A, B$ , using the sets of clocks  $C_A, C_B$ , the initial symbolic states  $(l_{0,A}, D_{0,A})$  of the VCG  $A_{\text{VCG}}$  of  $A$  regarding  $B$  and  $(l_{0,B}, D_{0,B})$  of the VCG  $B_{\text{VCG}}$  of  $B$  regarding  $A$ . Let  $n \in \mathbb{N}^{\geq 0}$  and  $k$  be a normalization function. The statement

$$\text{CHECK-FOR-VIRT-BISIM-IN-ORDER-IMPL}_{A_{\text{VCG}}, B_{\text{VCG}}, k, \emptyset, n}((l_{0,A}, D_{0,A}), (l_{0,B}, D_{0,B})) = \emptyset$$

holds if and only if  $A \sim_n B$  holds.

**Proof:**

See Appendix AH. □

Moreover, the returned virtual constraints are meaningful.

**Proposition 4.2. (Return Values of CHECK-FOR-VIRT-BISIM-IN-ORDER-IMPL)**

Assume two TA  $A, B$ , using the sets of clocks  $C_A, C_B$ , the AB-semi-synchronized symbolic states  $(l_A, D_A)$  of the VCG  $A_{\text{VCG}}$  of  $A$  regarding  $B$  and  $(l_B, D_B)$  of the VCG  $B_{\text{VCG}}$  of  $B$  regarding  $A$ . Let  $n \in \mathbb{N}^{\geq 0}$ ,  $visited$  be a set of pairs of symbolic states, and  $k$  be a normalization function. Given the virtual constraints

$$\text{CHECK-FOR-VIRT-BISIM-IN-ORDER-IMPL}_{A_{\text{VCG}}, B_{\text{VCG}}, k, visited, n}((l_A, D_A), (l_B, D_B)) = \{\phi_0, \dots, \phi_m\}$$

for any non-empty symbolic state  $(l_A, D_{\text{sub},A})$  with  $\exists \phi \in \{\phi_0, \dots, \phi_m\} : D_{\text{sub},A} \subseteq D_A \wedge \phi$  there exists no symbolic state  $(l_B, D_{\text{sub},B})$  with  $D_{\text{sub},B} \subseteq D_B$  and  $(l_A, D_{\text{sub},A}) \sim_n (l_B, D_{\text{sub},B})$  and vice versa.

**Proof:**

See Appendix AH. □

The following example illustrates the algorithm in practice.

**Example 4.3.** We extend Example 4.1 here. First, we calculate

$$\text{CHECK-FOR-VIRT-BISIM-IN-ORDER-IMPL}_{A_1, \text{VCG}, A_2, \text{VCG}, k, \emptyset, n}((l_0, x_1 = \chi_0 = \chi_1 = 0), (l_0, x_2 = \chi_0 = \chi_1 = 0)).$$

Since we assumed  $n > 1$  and since the symbolic states are virtually equivalent, we omit the first if-statement. The symbolic states are already AB-synchronized and the sync function does not affect them. All values are equal to zero and  $k$ -normalization does not change them. Due to the fact that visited is empty, the second if-statement is also omitted and the initial symbolic states are added

to new-visited. Since we only consider the transitions depicted in Figure 13, the outgoing action transitions at the initial symbolic states are ignored and we only check the outgoing  $\varepsilon$ -transitions.

Therefore, we now apply recursive call with parameters  $n - 1$  and the new visited set to the targets of the  $\varepsilon$ -transitions. Since we assumed  $n > 1$ , we can conclude  $(n - 1) > 0$ . Furthermore, since the zones are virtually equivalent, we can omit the first if-statement. Since the symbolic states are already AB-synchronized, the sync function does not change the symbolic states. Once again, k-normalization has no impact here, and the symbolic states included in new-visited are not equal to the symbolic states under test. Consequently, the second if-statement can be ignored. The algorithm now generates another visited set. For reasons of uniqueness, we call this set "last-visited". last-visited contains the pair of initial symbolic states and the current pair of symbolic states. We first check the outgoing  $\varepsilon$ -transitions.

We consider two scenarios for the function

$$\text{CHECK-FOR-VIRT-BISIM-IN-ORDER-IMPL}_{A_1, \text{VCG}, A_2, \text{VCG}, k, \text{last-visited}, n-2} \left( (l_0, x_1 = \chi_0 = \chi_1 < \infty), (l_0, x_2 = \chi_0 = \chi_1 < \infty) \right).$$

If the statement  $n - 2 = 0$  is true,

$$\begin{aligned} & (\text{extract-virtual-constraint}(x_1 = \chi_0 = \chi_1 < \infty) \wedge \neg \text{extract-virtual-constraint}(x_2 = \chi_0 = \chi_1 < \infty)) \\ \cup & (\text{extract-virtual-constraint}(x_2 = \chi_0 = \chi_1 < \infty) \wedge \neg \text{extract-virtual-constraint}(x_1 = \chi_0 = \chi_1 < \infty)) \\ = & ((\chi_0 = \chi_1 < \infty) \wedge \neg (\chi_0 = \chi_1 < \infty)) \cup ((\chi_0 = \chi_1 < \infty) \wedge \neg (\chi_0 = \chi_1 < \infty)) \\ = & \emptyset \cup \emptyset = \emptyset \end{aligned}$$

is returned. If the statement  $n - 2 > 0$  is true, the first if-statement is bypassed and since the given pair is an element of last-visited, the empty set is returned by the second if-statement. Therefore, in both cases, the expected value as described in Example 4.1 is returned.

We now check the outgoing action transition by calculating

$$\text{CHECK-FOR-VIRT-BISIM-IN-ORDER-IMPL}_{A_1, \text{VCG}, A_2, \text{VCG}, k, \text{last-visited}, n-2} \left( (l_1, x_1 = \chi_0 = \chi_1 = 0), (l_1, x_2 = 0 \wedge \chi_0 = \chi_1 < \infty) \right).$$

Since the zones are not virtually equivalent, the statement

$$\begin{aligned} & (\text{extract-virtual-constraint}(x_1 = \chi_0 = \chi_1 = 0) \wedge \\ & \quad \neg \text{extract-virtual-constraint}(x_2 = 0 \wedge \chi_0 = \chi_1 < \infty)) \\ \cup & (\text{extract-virtual-constraint}(x_2 = 0 \wedge \chi_0 = \chi_1 < \infty) \wedge \\ & \quad \neg \text{extract-virtual-constraint}(x_1 = \chi_0 = \chi_1 = 0)) \\ = & ((\chi_0 = \chi_1 = 0) \wedge \neg (\chi_0 = \chi_1 < \infty)) \cup ((\chi_0 = \chi_1 < \infty) \wedge \neg (\chi_0 = \chi_1 = 0)) \\ = & \emptyset \cup \{\chi_0 = \chi_1 > 0\} = \{\chi_0 = \chi_1 > 0\} \end{aligned}$$

is returned, which is the return value we expected in Example 4.1. Consequently, the second function call finds a contradiction returned by CHECK-OUTGOING-TRANSITIONS-IMPL and returns it to the

initial function call. The revert- $\varepsilon$ -transition operator is then applied, resulting into the contradiction  $\chi_0 = \chi_1 = 0$ , as the returned contradiction can be reached from the new contradiction. Ultimately, since the sync function had not any impact on the symbolic states, the revert-sync also has no impact on the returned contradiction and the initial function call returns the contradiction we expected in Example 4.1.

The following section describes the CHECK-OUTGOING-TRANSITIONS-IMPL operator.

### 4.3. Checking Two Sets of Transitions

An abstracted version of the CHECK-OUTGOING-TRANSITIONS-IMPL operator is presented in Algorithm 4.2. The operator takes as input two sets of outgoing action transitions, both using the same label, and a function that checks for virtual bisimulation in order  $n - 1$ . If contradictions exist, at least one of them is returned.

---

#### Algorithm 4.2 CHECK-OUTGOING-TRANSITIONS-IMPL function

---

```

  ▷ Let  $\text{trans}_A$  and  $\text{trans}_B$  be two sets of transitions and
  ▷  $\text{FUNC} : (L_A \times \mathcal{D}(C_{A,\chi})) \times (L_B \times \mathcal{D}(C_{B,\chi})) \rightarrow 2^{\mathcal{B}(\{\chi_0, \dots, \chi_{|C_A|+|C_B|-1}\})}$ 
  ▷ CHECK-OUTGOING-TRANSITIONS-IMPL returns a set of virtual constraints
1: function CHECK-OUTGOING-TRANSITIONS-IMPL $_{A_{VCG}, B_{VCG}, \text{FUNC}}(D_A, D_B, \text{trans}_A, \text{trans}_B)$ 
2:   found-cont  $\leftarrow$  matrix-of-size( $|\text{trans}_A| \times |\text{trans}_B|, \emptyset$ )           ▷ matrix of empty sets of vc
3:   finished  $\leftarrow$  matrix-of-size( $|\text{trans}_A| \times |\text{trans}_B|, \text{false}$ )       ▷ matrix of booleans, all set to false
4:   repeat
5:     for all  $(l_A, D_A) \xrightarrow[VCG]{\sigma} (l_{\sigma,A}, D_{\sigma,A}) \in \text{trans}_A$  do
6:       for all  $(l_B, D_B) \xrightarrow[VCG]{\sigma} (l_{\sigma,B}, D_{\sigma,B}) \in \text{trans}_B$  do
  ▷ Let  $i_A$  be the index of the transition from  $A$  and  $i_B$  be the index of the transition from  $B$ .
7:         if finished $[i_A][i_B] = \text{true}$  then continue with the next pair
8:          $D_{\text{eq},A} \leftarrow D_{\sigma,A} \wedge \text{extract-virtual-constraint}(D_{\sigma,B})$ 
9:          $D_{\text{eq},B} \leftarrow D_{\sigma,B} \wedge \text{extract-virtual-constraint}(D_{\sigma,A})$ 
10:        cont  $\leftarrow$  CHECK-TARGET-PAIR-IMPL $_{A_{VCG}, B_{VCG}, \text{FUNC}}($ 
11:           $(l_{\sigma,A}, D_{\text{eq},A}), (l_{\sigma,B}, D_{\text{eq},B}), \text{found-cont}[i_A][i_B]$ 
12:        finished $[i_A][i_B] \leftarrow$  (cont =  $\emptyset$  ? true : false)
13:        found-cont $[i_A][i_B] \leftarrow$  found-cont $[i_A][i_B] \cup$  cont
14:      end for
15:    end for
16:    contradiction  $\leftarrow$  search-contradiction( $D_A, D_B, \text{trans}_A, \text{trans}_B, \text{found-cont}$ )
17:    if contradiction  $\neq \emptyset$  then return contradiction
18:  until no-contradiction-possible( $D_A, D_B, \text{trans}_A, \text{trans}_B, \text{found-cont}, \text{finished}$ ) = true
19:  return  $\emptyset$ 
20: end function

```

---

While implementing this operator is straightforward in the case of deterministic transitions, the non-deterministic case is more challenging, as we know from Example 3.6. The cases in which at

least one of the sets is empty are skipped here, as we are primarily interested in the significant aspects. For more details see Appendix AG.

The main idea of the operator is to analyze each pair of transitions, with one transition drawn from each set, until a contradiction is found that cannot be resolved by analyzing a different split or until it is clear that no such contradiction exists. To achieve this, we initialize two matrices, each with as many rows as the first transition set has elements and as many columns as the second transition set has elements. The first matrix contains all contradictions found for each pair of transitions, while the second matrix contains a boolean for each pair of transitions, indicating whether all contradictions for that particular pair have already been found. Since we do not know anything about any pair in the beginning, we initialize each element of the first matrix with the empty set (no contradictions found yet) and each element of the second matrix with false.

Before analyzing the outer loop, we analyze the two for-loops. These loops iterate through each pair of transitions. To identify the corresponding matrix entries, we assume that each transition has a unique index within its respective set, which is denoted as  $i_A$  and  $i_B$ . If a pair is already marked as finished, we skip it. Otherwise, the targets are rendered virtually equivalent (since we already know these contradictions) and use the CHECK-TARGET-PAIR-IMPL function. This function takes the virtually equivalent symbolic states and the already found contradictions of this pair and returns a set of new contradictions, if there exist more, or the empty set if no further contradictions exist. The CHECK-TARGET-PAIR-IMPL function will be explained in the next section. If there are no more contradictions, we mark this pair as finished. Otherwise, the newly found contradictions are added to the contradictions of this pair.

The search for contradictions is repeated until either a contradiction is found that cannot be removed by analyzing a different split or no such contradiction can be found anymore. This is indicated by the outer loop, which repeats until no-contradiction-possible returns true, and the last if-statement, which returns the contradictions if any are present. The search-contradiction operator iterates through each transition of  $\text{trans}_A$  and  $\text{trans}_B$ , conjugating all found contradiction sets pertaining to that transition. If the result is not empty, it contains the contradictions that are contained by all sets of contradictions regarding a certain transition. Therefore, any split, done accordingly to Definition 3.11, will have these overall contradictions as contradictions and we return them. Further details may be found in Appendix AC. The no-contradiction-possible operator essentially replaces all entries in found-cont for which the corresponding finished entry is false with the clock constraint true. Subsequently, the search-contradiction operator is invoked. If the search-contradiction operator cannot find any contradiction even when the non-finished entries are set to true, it can be concluded that irrespective of the outcomes of the following iterations, no contradiction will be found. Consequently, we terminate the outer loop. Further details regarding the no-contradiction-possible operator can be found in Appendix AD. It should be noted that the outer loop will only be executed more than once if both sets of transitions contain non-deterministic choices. If one of the sets contains only deterministic choices, then any pair checked will either return a contradiction that is directly a contradiction for the deterministic choice, or none of the pairs will return a contradiction, which means that there cannot be an overall contradiction.

The practical application of CHECK-OUTGOING-TRANSITIONS-IMPL is illustrated in the following example. We use the nondeterministic TA  $A_5$  from Figure 1 for this.

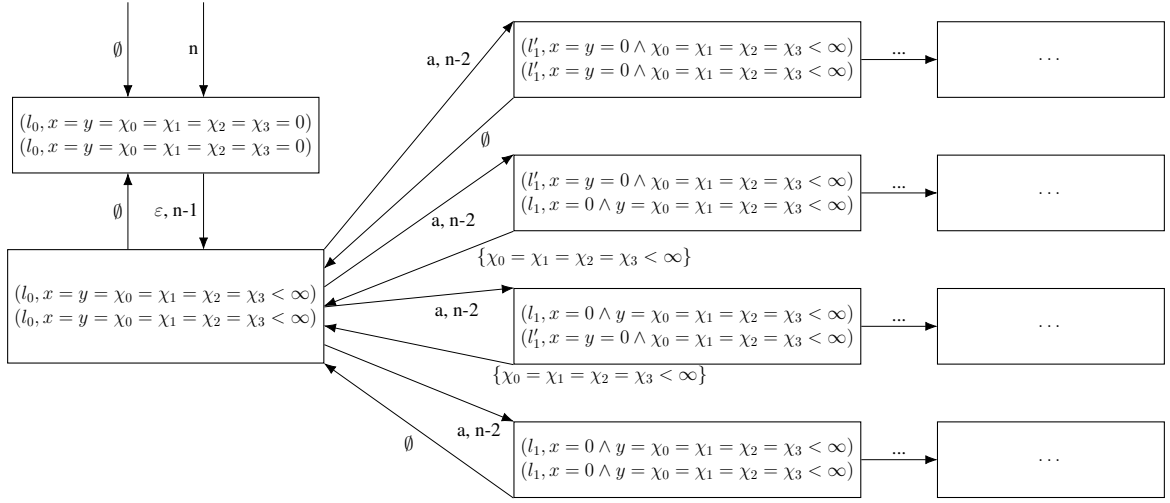

Figure 14: Illustration of Example 4.4

**Example 4.4.** We use the CHECK-FOR-VIRT-BISIM-IN-ORDER-IMPL function to check whether  $A_5$  is bisimilar in order  $n > 6$  to itself (which is obviously the case). The recursive calls are illustrated in Figure 14. For the initial symbolic state, we ignore all outgoing action transitions. After the first  $\varepsilon$ -transition, we reach a pair that consists two times of the symbolic state  $(l_0, x = y = \chi_0 = \chi_1 = \chi_2 = \chi_3 < \infty)$ . Therefore, we apply the CHECK-FOR-VIRT-BISIM-IN-ORDER-IMPL function to this pair. After the check for virtual equivalence and the check of the outgoing  $\varepsilon$ -transitions, we analyze the outgoing action transitions. Since both symbolic states have two outgoing transitions labeled with  $a$ , it can be concluded that found-cont and finished are both  $2 \times 2$ -matrices in this case. In accordance with the illustration in Figure 14, we know that after the for-loops of the CHECK-FOR-OUTGOING-TRANSITIONS-IMPL function have been executed, the matrices have the following entries:

$$\begin{pmatrix} \emptyset & \{\chi_0 = \chi_1 = \chi_2 = \chi_3 < \infty\} \\ \{\chi_0 = \chi_1 = \chi_2 = \chi_3 < \infty\} & \emptyset \end{pmatrix} \text{ and } \begin{pmatrix} \text{true} & \text{false} \\ \text{false} & \text{true} \end{pmatrix}$$

Since the conjunction of any row or column is the empty set, it can be concluded that no contradictions have been found for any transition. From the second matrix, we know that the upper left and lower right elements will remain unaltered upon the completion of another iteration. After we have replaced all other entries by true, it becomes evident that the search-contradiction operator is still unable to find any overall contradictions. Therefore, no other iteration will result into any overall contradictions and the outer loop is terminated, which results into the return of the empty set.

We show the CHECK-TARGET-PAIR-IMPL operator in the next section.

#### 4.4. Checking a Pair of Targets

In the deterministic case, checking a pair of target symbolic states is straightforward: We simply apply the CHECK-FOR-VIRT-BISIM-IN-ORDER function with order  $n - 1$ . However, in the non-deterministic

case it is necessary to have the ability to incorporate some previously found contradictions, ensuring that only those parts of the target symbolic states are compared for which no contradiction has been found.

Algorithm 4.3 shows an abstracted version of the CHECK-TARGET-PAIR-IMPL function. For further details see Appendix AF. If known-cont is empty, the check-target-pair operator is trivial: We invoke FUNC on the given symbolic states and return the result (we use the convention  $\bigvee \emptyset = \emptyset$  here, which implies  $\text{extract-virtual-constraint}(D_{\sigma,A}) \wedge \neg(\bigvee \emptyset) = \{\text{extract-virtual-constraint}(D_{\sigma,A})\}$ ). If known-cont is not empty, it is necessary to extract the parts of the target zones without an already found contradiction. This is achieved by negating the contradictions, which results in a different set of virtual constraints representing the parts of the zones, for which no contradiction has been found, and iterate through that set. In the case that a contradiction is encountered, we return it.

---

**Algorithm 4.3** CHECK-TARGET-PAIR-IMPL function
 

---

▷ Let  $(l_{\sigma,A}, D_{\sigma,A})$  be a symbolic state of  $A_{\text{VCG}}$ ,  $(l_{\sigma,B}, D_{\sigma,B})$  be a symbolic state of  $B_{\text{VCG}}$ ,  
 ▷ found-cont be a set of contradictions, and  
 ▷  $\text{FUNC} : (L_A \times \mathcal{D}(C_{A,\chi})) \times (L_B \times \mathcal{D}(C_{B,\chi})) \rightarrow 2^{\mathcal{B}(\{\chi_0, \dots, \chi_{|C_A|+|C_B|-1}\})}$ .  
 ▷ CHECK-TARGET-PAIR-IMPL returns a set of virtual constraints

- 1: **function** CHECK-TARGET-PAIR-IMPL $_{A_{\text{VCG}}, B_{\text{VCG}}, \text{FUNC}}((l_{\sigma,A}, D_{\sigma,A}), (l_{\sigma,B}, D_{\sigma,B}), \text{found-cont})$
- 2:     without-cont  $\leftarrow$  extract-virtual-constraint( $D_{\sigma,A}$ )  $\wedge$   $\neg(\bigvee \text{found-cont})$
- 3:     contradictions  $\leftarrow \emptyset$
- 4:     **for**  $\phi \in$  without-cont **do**
- 5:         new-cont  $\leftarrow$  FUNC( $(l_{\sigma,A}, D_{\sigma,A} \wedge \phi), (l_{\sigma,B}, D_{\sigma,B} \wedge \phi)$ )
- 6:         contradictions = contradictions  $\cup$  new-cont
- 7:     **end for**
- 8:     **return** contradictions
- 9: **end function**

---

Therefore, the problem on how to split the target zone is solved. However, the algorithm still suffers from the problem described in Example 2.8.

## 4.5. Alternating Sequences

In the preceding section, we used the CHECK-FOR-VIRT-BISIM-IN-ORDER-IMPL function to check for virtual bisimulation in any order  $n$ . We now assume  $n \rightarrow \infty$ . Due to Proposition 2.3, we know that visited has a maximum length and since in each recursion step we add one element to visited, we can follow that the recursion eventually terminates. The validity of Proposition 4.1 and Proposition 4.2 remains intact and, therefore, this function is able to check for virtual bisimulation. We now show that it is permissible to consider only alternating sequences for  $n \rightarrow \infty$ .

The following proposition shows that the outgoing  $\varepsilon$ -transition of a symbolic state, which already is the target of an outgoing  $\varepsilon$ -transition, is a self-loop.



**Proposition 4.3. (Multiple  $\varepsilon$ -transition)**

Assume any VCG  $A_{\text{VCG}}$  and any symbolic state  $(l_A, D_A)$  of  $A_{\text{VCG}}$ . We denote the outgoing  $\varepsilon$ -transition of  $(l_A, D_A)$  with  $(l_A, D_A) \xrightarrow[\text{VCG}]{\varepsilon} (l_A, D_\varepsilon)$  and we denote the outgoing  $\varepsilon$ -transition of  $(l_A, D_\varepsilon)$  with  $(l_A, D_\varepsilon) \xrightarrow[\text{VCG}]{\varepsilon} (l_A, D_{\varepsilon, \varepsilon})$ .

$$(l_A, D_\varepsilon) = (l_A, D_{\varepsilon, \varepsilon})$$

holds.

**Proof:**

See Appendix AI. □

Remembering the cut-off criterion described in Example 4.1, we can follow that the check of self-loops will always return the empty set. Now we show that we are allowed to check  $(l_A, D_\varepsilon)$  instead of  $(l_A, D_A)$  when checking for virtual bisimulation.

**Proposition 4.4. (Check only the Future)**

Assume two TA  $A, B$ , with VCG  $A_{\text{VCG}}$  of  $A$  regarding  $B$ , VCG  $B_{\text{VCG}}$  of  $B$  regarding  $A$ , and the AB-synchronized symbolic states  $(l_A, D_A), (l_B, D_B)$  with  $D_A \equiv_{\text{virtual}} D_B$ . We denote the outgoing  $\varepsilon$ -transitions with  $(l_A, D_A) \xrightarrow[\text{VCG}]{\varepsilon} (l_A, D_{A, \varepsilon})$  and  $(l_B, D_B) \xrightarrow[\text{VCG}]{\varepsilon} (l_B, D_{B, \varepsilon})$ . We denote

$$\varepsilon\text{-result} = \text{CHECK-FOR-VIRT-BISIM-IN-ORDER-IMPL}_{A_{\text{VCG}}, B_{\text{VCG}}, k, \text{visited}, \infty}((l_A, D_{A, \varepsilon}), (l_B, D_{B, \varepsilon}))$$

with

$$\begin{aligned} \text{rev-}\varepsilon\text{-result} &= \text{revert-}\varepsilon\text{-trans}(D_A, D_{A, \varepsilon}, \varepsilon\text{-result} \wedge \text{extract-virtual-constraint}(D_{\varepsilon, A})) \\ &\quad \cup \text{revert-}\varepsilon\text{-trans}(D_B, D_{B, \varepsilon}, \varepsilon\text{-result} \wedge \text{extract-virtual-constraint}(D_{\varepsilon, B})) \end{aligned}$$

and

$$\text{result} = \text{CHECK-FOR-VIRT-BISIM-IN-ORDER-IMPL}_{A_{\text{VCG}}, B_{\text{VCG}}, k, \text{visited}, \infty}((l_A, D_A), (l_B, D_B)).$$

The statement

$$(\text{result} = \emptyset) \Leftrightarrow (\text{rev-}\varepsilon\text{-result} = \emptyset)$$

holds. Moreover, for any non-empty symbolic state  $(l_A, D_{\text{sub}, A})$  with  $\exists \phi \in \text{rev-}\varepsilon\text{-result} : D_{\text{sub}, A} \subseteq D_A \wedge \phi$  there exists no symbolic state  $(l_B, D_{\text{sub}, B})$  with  $D_{\text{sub}, B} \subseteq D_B$  and  $(l_A, D_{\text{sub}, A}) \sim (l_B, D_{\text{sub}, B})$  and vice versa.

**Proof:**

See Appendix AJ. □

Combining Proposition 4.3 and Proposition 4.4 yields the result that we are allowed to check alternating sequences. The reader may recognize that Proposition 4.4 holds only for  $n \rightarrow \infty$ .

## 4.6. Virtual Bisimulation

In this section, we finally present the CHECK-FOR-VIRT-BISIM-IMPL function in Algorithm 4.4, which checks for virtual bisimulation and uses alternating sequences. Furthermore, in the event that an  $\varepsilon$ -transition is deemed superfluous, the algorithm proceeds without it. CHECK-FOR-VIRT-BISIM-IMPL mainly differs to CHECK-FOR-VIRT-BISIM-IN-ORDER-IMPL with  $n \rightarrow \infty$  by the fact that either the  $\varepsilon$ -transitions or the action transitions are checked. After the application of the sync function, we check whether the pair of targets of the  $\varepsilon$ -transitions is equivalent to the current pair of symbolic states.

---

### Algorithm 4.4 CHECK-FOR-VIRT-BISIM-IMPL function

---

▷ Let  $(l_A, D_A), (l_B, D_B)$  be AB-semi-synchronized symbolic states,  
 ▷  $k : C_A \cup C_B \cup \{\chi_0, \dots, \chi_{|C_A|+|C_B|-1}\} \rightarrow \mathbb{N}^{\geq 0}$ , and visited be a set.  
 ▷ The return value of CHECK-FOR-VIRT-BISIM-IMPL is a set of virtual constraints

```

1: function CHECK-FOR-VIRT-BISIM-IMPLAVCG,BVCG,k,visited(( $l_A, D_A$ ), ( $l_B, D_B$ ))
2:   if  $\neg(D_A \equiv_{\text{virtual}} D_B)$  then
3:     return extract-virtual-constraint( $D_A$ )  $\wedge$   $\neg$  extract-virtual-constraint( $D_B$ )  $\cup$ 
4:       extract-virtual-constraint( $D_B$ )  $\wedge$   $\neg$  extract-virtual-constraint( $D_A$ )
5:   end if
6:   (( $l_A, D_{e,A}$ ), ( $l_B, D_{e,B}$ ))  $\leftarrow$  sync(( $l_A, D_A$ ), ( $l_B, D_B$ ))
7:
8:   ▷ Assume ( $l_A, D_{e,A}$ )  $\xrightarrow{VCG}^{\varepsilon}$  ( $l_A, D_{\varepsilon,A}$ ) and ( $l_B, D_{e,B}$ )  $\xrightarrow{VCG}^{\varepsilon}$  ( $l_B, D_{\varepsilon,B}$ ).
9:   if ( $D_{e,A}, D_{e,B}$ )  $\neq$  ( $D_{\varepsilon,A}, D_{\varepsilon,B}$ ) then
10:     $\varepsilon$ -result  $\leftarrow$  CHECK-FOR-VIRT-BISIM-IMPLAVCG,BVCG,k,visited(( $l_A, D_{\varepsilon,A}$ ), ( $l_B, D_{\varepsilon,B}$ ))
11:    contra  $\leftarrow$  revert- $\varepsilon$ -trans( $D_{e,A}, D_{\varepsilon,A}, \varepsilon$ -result  $\wedge$  extract-virtual-constraint( $D_{\varepsilon,A}$ ))
12:       $\cup$  revert- $\varepsilon$ -trans( $D_{e,B}, D_{\varepsilon,B}, \varepsilon$ -result  $\wedge$  extract-virtual-constraint( $D_{\varepsilon,B}$ ))
13:    return revert-sync(( $l_A, D_A$ ), ( $l_B, D_B$ ), contra)
14:   end if
15:
16:   ( $l_A, D_{\text{norm},A}$ )  $\leftarrow$  ( $l_A, \text{norm}(D_{e,A}, k)$ ), ( $l_B, D_{\text{norm},B}$ )  $\leftarrow$  ( $l_B, \text{norm}(D_{e,B}, k)$ )
17:   if ((( $l_A, D_{\text{norm},A}$ ), ( $l_B, D_{\text{norm},B}$ ))  $\in$  visited) then return  $\emptyset$ 
18:   new-visited  $\leftarrow$  visited  $\cup$  {(( $l_A, D_{\text{norm},A}$ ), ( $l_B, D_{\text{norm},B}$ ))}
19:   FUNC = CHECK-FOR-VIRT-BISIM-IMPLAVCG,BVCG,k,new-visited
20:
21:   for all  $\sigma \in \Sigma$  do
22:     ▷ out-trans( $\sigma, (l, D)$ ) is the set of all outgoing transitions of ( $l, D$ ) labeled with  $\sigma$ .
23:     contradiction  $\leftarrow$  check-outgoing-transitionsAVCG,BVCG,FUNC( $D_{e,A}, D_{e,B}$ 
24:       out-trans( $\sigma, (l_A, D_{e,A})$ ), out-trans( $\sigma, (l_B, D_{e,B})$ ))
25:     if (contradiction  $\neq$   $\emptyset$ ) then return revert-sync(( $l_A, D_{e,A}$ ), ( $l_B, D_{e,B}$ ), contradiction)
26:   end for
27:   return  $\emptyset$ 
28: end function
  
```

---

If this is not the case, we utilize Proposition 4.4 and check only the outgoing  $\varepsilon$ -transitions. By Proposition 3.8, we know that these targets are AB-synchronized and, therefore, if the targets are virtually equivalent, the sync function has no impact. Therefore, after an  $\varepsilon$ -transition, Proposition 4.3 applies and the condition in the second if-statement is false. This implies that at least at every second recursion step, the pair of targets of the  $\varepsilon$ -transitions is equivalent to the current pair of symbolic states.

If this is the case, the following part of the algorithm is identical to the corresponding part of the aforementioned CHECK-FOR-VIRT-BISIM-IN-ORDER-IMPL function. However, the check of the outgoing  $\varepsilon$ -transitions is omitted, as it would inevitably yield an empty set.

**Proposition 4.5. (CHECK-FOR-VIRT-BISIM-IMPL is Correct)**

For  $n \rightarrow \infty$ , the propositions regarding the correctness and the return values of CHECK-FOR-VIRT-BISIM-IN-ORDER-IMPL, Proposition 4.1 and Proposition 4.2, also hold for CHECK-FOR-VIRT-BISIM-IMPL.

**Proof:**

See Appendix AK. □

Since the region-based approach of Čerāns [2] has an exponential behavior in the number of symbolic states when applied to linear TA, our algorithm improves the complexity of the bisimulation check significantly.

## 4.7. Comparison to the Region-Based Approach

Since Čerāns [2] uses parallel timer processes (PTPs) and only shows the construction of a finite set for which some properties have to be checked but does not show an actual algorithm, we have to do some interpretation for the comparison. While it may be possible to do slightly better using the region-based construction, the main point remains valid. Moreover, to the best of our knowledge, there is no tool implementing the approach and we need to do the calculations by hand.

The region-based approach proposed by Čerāns [2] uses a product graph. It thus follows that, given two TA  $A$  and  $B$  with sets of clocks  $C_A$  and  $C_B$ , the analyzed symbolic states have  $|C_A| + |C_B|$  many clocks. Since the symbolic states contained in the visited set in Algorithm 4.4 are AB-synchronized, it follows that the original clocks have the same values as the corresponding virtual clocks. Consequently, only the  $|C_A| + |C_B|$  virtual clocks are relevant for the number of recursion steps and, therefore, the number of relevant clocks is the same in both constructions.

It should be noted, however, that the region-based approach is subject to an analog problem as described in Example 2.7.

**Example 4.5.** Figures 15a and 15b show two simple, deterministic, and bisimilar TA. As shown in Figure 15c, the approach from [2] now takes a state from each region of the product of both TA. Since this results in multiple uses of the first transition, and some of the paths result in multiple uses of the second transition, this results into an exponential number of symbolic states. This is not the case when using our Algorithm as shown in Figure 15d.

The next section shows that our algorithm can check realistic TA taken from community benchmarks within an acceptable amount of time.

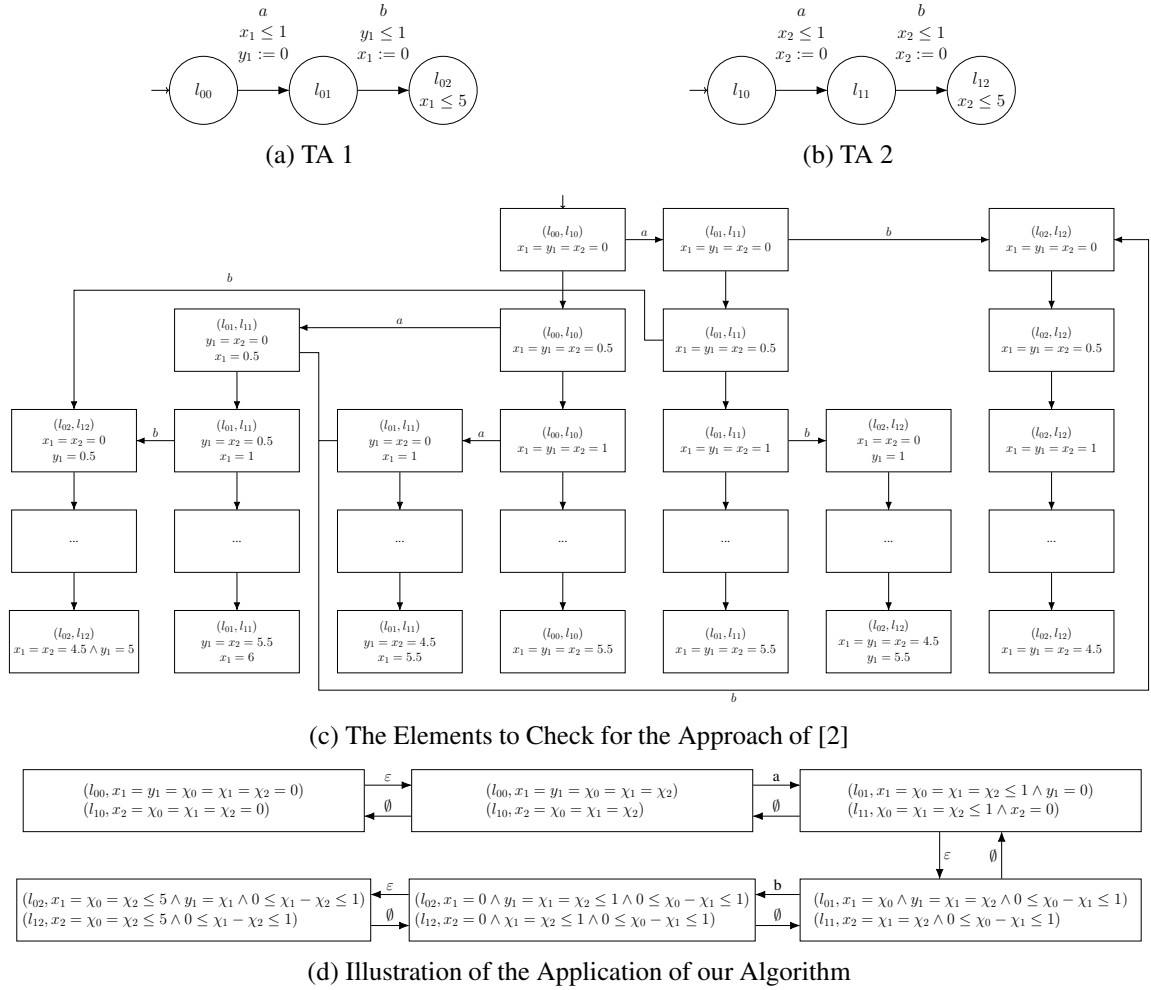

Figure 15: Comparison between [2] and our Algorithm

## 5. Experimental Evaluation and Comparison

In this section, we demonstrate the practical usability of our algorithm and show that our tool is currently the one to use when checking for timed bisimilarity. To achieve this, we compare our tool to CAAL, the only currently available tool for checking timed bisimilarity we are aware of. Since CAAL accepts processes written in *Timed Calculus of Communicating Systems (TCCS)*, we translate the TA under test into TCCS.

In CAAL, the action  $\tau$  has a special meaning. If a transition labeled with  $\tau$  is enabled, no delay can occur, while a transition with any other action can be delayed by any amount of time. Therefore, we use transitions labeled with  $\tau$  to translate invariants of TA into the language of CAAL.

As far as we understand CAAL, the tool assumes a discrete time semantics and enumerates the

states of the resulting TLTS according to Definition 2.4. If the TLTS becomes too large, it is either cut-off, which implies that false positives can occur, or a *Too Much Recursion Error (TMRE)* occurs. The first behavior is demonstrated by the following example.

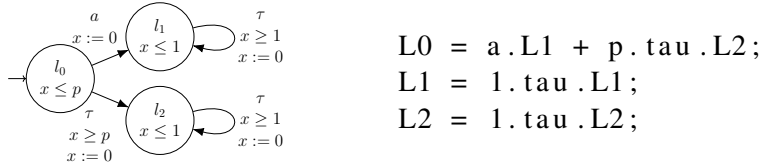

Figure 16: TA (left) and TCCS (right) of our Synthetic Example.

**Example 5.1.** Figure 16 shows the templates for this example. On the left hand side, the template of our TA can be seen. It consists of three locations with invariants.  $l_0$  requires  $x$  to be lower or equals to a parameter  $p$ , while the other locations require  $x$  to be lower or equal to 1. Moreover,  $l_0$  has two outgoing transition, one with the action  $a$  and one with  $\tau$ , and the transition labeled with  $\tau$  can only be used if  $x$  is equal to  $p$ . The locations  $l_1$  and  $l_2$  both have self-loops which use the action  $\tau$  and reset clock  $x$ .

The right hand side of Figure 16 shows the analogous template for CAAL. The initial process is  $L_0$ , which has the options to use the action  $a$  and switch to process  $L_1$  or to wait for  $p$  time steps and switch to process  $L_2$ . The processes  $L_1$  and  $L_2$  wait a timestep and then become itself again using a  $\tau$ -transition.

If we instantiate the templates with  $p < 100$ , the check for timed bisimulation works fine for both tools. However, if we instantiate the templates with  $p = 100$  and  $p = 101$ , resulting in two different processes that are not timed bisimilar, CAAL returns a false positive, which does not happen when using our tool.

The main reason for this behavior is that if the TLTS were not cut off, they would quickly become very large. Therefore, any TLTS-based approach suffers from this problem either by having infinite large runtimes or by producing false positives. Moreover, any approach based on TLTS requires discrete-time modelling, which is not the case for our tool.

We now compare both tools by evaluating frequently used community examples as our subject systems.

## 5.1. Evaluation of our Subject Systems

To evaluate our tool in practice, we utilize three different TA models, which are frequently used in the evaluation of TA analysis techniques:

- Collision Avoidance (CA) [25] : A model of a protocol for the avoidance of collisions on an Ethernet-like broadcast medium.
- Root Contention Protocol (RCP) [26] : A model of the IEEE1394 root contention protocol.

Name	# Locations	# Switches	# Clocks
CA	6	13	1
RCP	10	26	2
AVC	18	30	1

Table 1: Statistics of the models to benchmark

- Audio/Video Components (AVC) [27] : A model of a protocol used in the industry for the purpose of controlling the transmission of messages between audio and video components over a shared bus.

The statistics of the models can be seen in Table 1. CA is the smallest model, with six locations, 13 switches, and a single clock. RCP has ten locations, 26 switches, and two clocks, while AVC has 18 locations, 30 switches, and a single clock.

All these models were originally published as UPPAAL models. We used the uppaal-to-tchecker converter [7] to generate the corresponding TChecker models. For each of these TA, we generated four mutants to obtain a set of similar but different models. To do this, we used a mutation testing approach described in [28]. The first mutant we generated is always timed bisimilar, while the other mutants are not. The first mutant is created by adding a reset (except for the RCP example, where this was not possible and, therefore, we doubled a transition), the second mutant is created by changing an invariant of a location, the third mutant is created by changing a guard, and the fourth mutant is created by removing a reset.

Unfortunately, the found community benchmarks do not include any non-determinism. Therefore, we used another operation of the mutant testing approach that changes the action of a transition. Sometimes this leads to non-deterministic mutants. For each of our models, we picked such a non-deterministic mutant and applied exactly the same mutations as to the original model. We then repeated our evaluation procedure, which allows us to analyze the impact of a single non-deterministic choice.

To compare the tools, we applied them first to the model and its one-to-one copy and afterwards to the model and the corresponding mutants. The results are shown in Table 2 and Table 3. The tools were run eleven times for each pair (always with a reboot in between), and the time values shown are average values. The variances between measurements are shown next to the time values. Table 2 also shows the number of checked pairs of symbolic states, while Table 3 also shows whether the returned result was correct, which is always the case for our tool (the ground truth was obtained manually).

The evaluation was conducted on a workstation equipped with an Intel i7-6700K processor and 64GB main memory, running a Linux Mint 21.2 ("Victoria") operating system.

For our tool, all average time values are below 33ms, which demonstrates the practical usability of our algorithm. Since the algorithm terminates upon the discovery of a contradiction, the number of symbolic states to be examined is reduced for non-bisimilar pairs, resulting in a faster termination compared to bisimilar pairs. Furthermore, the presence of two clocks in RCP, as opposed to the single clock in CA and AVC, leads to a higher computation time, sometimes even if the number of pairs is

Determ.	CA			RCP			AVC		
	# Pairs	t [ms]	Var.	# Pairs	t [ms]	Var	# Pairs	t [ms]	Var
One-To-One	16	0.3	0.00	698	18.3	3.81	808	14.4	11.32
Bisim	16	0.3	0.00	732	20.0	4.50	808	13.4	0.01
Changed G.	12	0.3	0.00	5	0.4	0.01	138	2.7	0.53
Changed Inv.	2	0.1	0.00	3	0.2	0.00	5	0.2	0.00
Rm. Reset	2	0.1	0.00	3	0.2	0.00	20	0.6	0.00
Non-Determ.									
One-To-One	18	0.4	0.38	744	20.1	2.26	1784	32.4	18.14
Bisim	18	0.4	0.0	778	21.9	8.05	1784	30.9	9.82
Changed G.	14	0.4	0.01	8	0.4	8.80	595	10.3	6.45
Changed Inv.	2	0.1	0.0	6	0.3	0.00	5	0.2	0.00
Rm. Reset	2	0.1	0.0	6	0.4	0.01	59	1.5	0.02

Table 2: Benchmark Results of our Tool

Determ.	CA			RCP		AVC		
	Correct	t [ms]	Var.	Correct	t [ms]	Correct	t [ms]	Var.
One-To-One	yes	45.8	111.56	-	TMRE	yes	73.6	312.05
Bisim.	yes	34.6	174.25	-	TMRE	yes	80.3	225.62
Changed Guard	yes	48.2	184.56	-	TMRE	yes	80.1	232.09
Changed Inv.	yes	42.0	172.00	-	TMRE	no	77.73	184.82
Removed Reset	yes	46.6	111.85	-	TMRE	yes	100.8	0.56
Non-Determ.								
One-To-One	yes	39.3	296.62	-	TMRE	yes	75.7	401.42
Bisim.	yes	41.7	176.82	-	TMRE	yes	75.5	125.47
Changed Guard	yes	34.6	295.67	-	TMRE	yes	73.18	54.76
Changed Inv.	yes	30.3	110.62	-	TMRE	no	70.8	106.36
Removed Reset	yes	37.2	185.96	-	TMRE	yes	107.5	135.67

Table 3: Benchmark Results of CAAL

lower. As expected, a non-deterministic choice can lead to a significant increase in the number of pairs needed, as happened especially for the AVC example. The variance of our measurements is low and all measurements were within an acceptable interval.

For CAAL, we can see that for CA, the time required is larger by a factor of about 100 and that CAAL is unable to handle the RCP model due to its size. For AVC, the fact that a false positive occurs proves that the state space is not fully explored. Since we do not know the size of the ignored part of the state space, the time values shown are only a lower bound with an unclear upper bound. Nevertheless, all measured time values are above the corresponding values in Table 2. The variance is high, indicating that we usually had a wide range of measurement values.

Therefore, our tool performs significantly better than CAAL for all three examples. In particular, the fact that RCP is rejected and that there is a false positive for AVC should be taken into account when choosing the tool to be used for checking timed bisimilarity.

## 5.2. Threads to Validity

From Section 5.1, we can conclude that the approach is sufficiently effective for the models. The scope of our experimental setting is limited to the class of safety TA. Our approach could be rendered inapplicable by any non-trivial TA extension. Since timed bisimulation is path-based, it is possible to extend the computation time by incorporating additional paths, for example by adding non-deterministic choices. Due to our approach of generating mutants, we only consider small and locally restricted changes. Nevertheless, we used proofs and exhaustive testing to ensure correctness of our theory and our tool implementation. The used tests and benchmarks are provided within the examples directory of our tool.

We compared our tool to the only tool we know with a similar functionality, namely CAAL. Nevertheless, CAAL works on TCCS instead of TA and, therefore, we had to translate the models. While there might be small improvements possible, the overall outcome will not be changed by using different translations. Timing Measurements are always subject to noise. We run all measurements eleven times and took the average value to reduce the impact.

The final threat we consider is the relatively small set of subject systems. The examples we have selected from community benchmarks are of a reasonable size and complexity. The benchmarks are often used in experiments involving analysis techniques for TA. However, further case studies should be considered in future.

## 6. Conclusion

We presented virtual clock graphs, an extension of zone graphs, with the objective of verifying timed bisimilarity. We used this formalism to develop an algorithm, which we implemented in the open-source tool TChecker. Our experimental evaluation demonstrates that the tool is fit for purpose in practice, particularly in deterministic scenarios, but also in non-deterministic cases. To the best of our knowledge, this is the first practically usable tool for checking timed bisimilarity that uses an algorithm with a publicly available proof of its correctness.



As future work, we intend to utilize virtual clock graphs to develop algorithms that check for different comparison definitions such as timed refinement or weak timed bisimilarity. Furthermore, we plan to improve our cut-off criterion to reduce computation time and to introduce a cache system. Finally, we would like to develop a certificate such that it allows the user to use a graphical user interface that allows for a better understanding of the result.

## References

- [1] Alur R, Dill D. Automata for modeling real-time systems. In: Paterson MS (ed.), *Automata, Languages and Programming*. Springer, Berlin, Heidelberg. ISBN 978-3-540-47159-2, 1990 pp. 322–335.
- [2] Čerāns K. Decidability of bisimulation equivalences for parallel timer processes. In: von Bochmann G, Probst DK (eds.), *Computer Aided Verification*. Springer, Berlin, Heidelberg. ISBN 978-3-540-47572-9, 1993 pp. 302–315.
- [3] Henzinger T, Nicollin X, Sifakis J, Yovine S. Symbolic Model Checking for Real-Time Systems. *Information and Computation*, 1994. **111**(2):193–244.
- [4] Weise C, Lenzkes D. Efficient scaling-invariant checking of timed bisimulation. In: Reischuk R, Morvan M (eds.), *STACS 97*. Springer, Berlin, Heidelberg. ISBN 978-3-540-68342-1, 1997 pp. 177–188.
- [5] Herbreteau F. TChecker file format. <https://github.com/ticktac-project/tchecker/wiki/TChecker-file-format>. Accessed: 2023-11-24.
- [6] Larsen KG, Pettersson P, Yi W. UPPAAL in a Nutshell. *Int. Journal on Software Tools for Technology Transfer*, 1997. **1**(1–2):134–152.
- [7] Herbreteau F, Point G. uppaal-to-tchecker. <https://github.com/ticktac-project/uppaal-to-tchecker>. Accessed: 2023-11-24.
- [8] Moller F, Tofts C. A temporal calculus of communicating systems. In: Baeten JCM, Klop JW (eds.), *CONCUR '90 Theories of Concurrency: Unification and Extension*. Springer, Berlin, Heidelberg. ISBN 978-3-540-46395-5, 1990 pp. 401–415.
- [9] Wang Y. Real-time behaviour of asynchronous agents. In: Baeten JCM, Klop JW (eds.), *CONCUR '90 Theories of Concurrency: Unification and Extension*. Springer, Berlin, Heidelberg. ISBN 978-3-540-46395-5, 1990 pp. 502–520.
- [10] Nicollin X, Sifakis J. The Algebra of Timed Processes, ATP: Theory and Application. *Information and Computation*, 1994. **114**(1):131–178.
- [11] Guha S, Narayan C, Arun-Kumar S. On Decidability of Prebisimulation for Timed Automata. In: Madhusudan P, Seshia SA (eds.), *Computer Aided Verification*. Springer, Berlin, Heidelberg. ISBN 978-3-642-31424-7, 2012 pp. 444–461.
- [12] Tanimoto T, Sasaki S, Nakata A, Higashino T. A Global Timed Bisimulation Preserving Abstraction for Parametric Time-Interval Automata. In: Wang F (ed.), *Automated Technology for Verification and Analysis*. Springer, Berlin, Heidelberg. ISBN 978-3-540-30476-0, 2004 pp. 179–195.
- [13] Alur R, Dill D. The theory of timed automata. In: de Bakker JW, Huizing C, de Roever WP, Rozenberg G (eds.), *Real-Time: Theory in Practice*, volume 600. LNCS, Springer, Berlin, Heidelberg. ISBN 978-3-540-47218-6, 1992 pp. 45–73.

- [14] Bérard B, Petit A, Diekert V, Gastin P. Characterization of the Expressive Power of Silent Transitions in Timed Automata. *Fundam. Inf.*, 1998. **36**(2,3):145–182.
- [15] Lynch N, Vaandrager F. Forward and backward simulations for timing-based systems. In: de Bakker JW, Huizing C, de Roever WP, Rozenberg G (eds.), *Real-Time: Theory in Practice*. Springer, Berlin, Heidelberg, 1992 pp. 397–446.
- [16] Alur R, Dill DL. A theory of timed automata. *Theoretical Computer Science*, 1994. **126**(2):183–235.
- [17] Pettersson P. Modelling and Verification of Real-Time Systems Using Timed Automata: Theory and Practice. PhD thesis, Uppsala University, 1999.
- [18] Yi W, Pettersson P, Daniels M. Automatic Verification of Real-Time Communicating Systems by Constraint-Solving. In: Hogrefe D, Leue S (eds.), *Formal Description Techniques VII: Proceedings of the 7th IFIP WG 6.1 international conference on formal description techniques*. Springer US, Boston, MA, 1995 pp. 243–258.
- [19] Bellman R. *Dynamic Programming*. Princeton University Press, 1957. ISBN 0-486-42809-5.
- [20] Dill DL. Timing assumptions and verification of finite-state concurrent systems. In: Sifakis J (ed.), *Automatic Verification Methods for Finite State Systems*. Springer, Berlin, Heidelberg, 1990 pp. 197–212.
- [21] Bengtsson J, Yi W. Timed Automata: Semantics, Algorithms and Tools. In: Desel J, Reisig W, Rozenberg G (eds.), *Lectures on Concurrency and Petri Nets: Advances in Petri Nets*. Springer, Berlin, Heidelberg. ISBN 978-3-540-27755-2, 2004 pp. 87–124.
- [22] Rokicki TG. Representing and Modeling Digital Circuits. PhD thesis, Stanford University, 1993.
- [23] Milner R. *A Calculus of Communicating Systems*. Springer Berlin Heidelberg, 1980. ISBN 978-3-540-10235-9.
- [24] Sangiorgi D. *Introduction to Bisimulation and Coinduction*. Cambridge University Press, 2011. ISBN 978-0-511-77711-0.
- [25] Jensen HE, Larsen KG, Skou A. Modelling and Analysis of a Collision Avoidance Protocol using SPIN and UPPAAL. *BRICS Report Series*, 1996. **3**(24).
- [26] Collomb-Annichini A, Sighireanu M. Parameterized Reachability Analysis of the IEEE 1394 Root Contention Protocol using TRex. *Proceedings of the Real-Time Tools Workshop (RT TOOLS'01)*, 2001.
- [27] Havelund K, Skou A, Larsen KG, Lund K. Formal modeling and analysis of an audio/video protocol: an industrial case study using UPPAAL. In: *Proceedings Real-Time Systems Symposium*. IEEE, 1997 .
- [28] Aichernig BK, Hörmaier K, Lorber F. Debugging with Timed Automata Mutations. In: Bondavalli A, Di Giandomenico F (eds.), *Computer Safety, Reliability, and Security*. Springer International Publishing, Cham. ISBN 978-3-319-10506-2, 2014 pp. 49–64.
- [29] Tarski A. A lattice-theoretical fixpoint theorem and its applications. *Pacific Journal of Mathematics*, 1955. **5**(2):285 – 309.

## A. Timed Simulation

We define Timed Simulation analogously to Definition 2.4.

### Definition A.1. (Timed Simulation [15, 2])

Let  $A = (L_A, l_{0,A}, \Sigma, C_A, I_A, E_A)$  and  $B = (L_B, l_{0,B}, \Sigma, C_B, I_B, E_B)$  be TA over the same alphabet  $\Sigma$  with  $C_A \cap C_B = \emptyset$ .  $A$  has the corresponding TLTS  $A_{\text{TLTS}} = (V_{\text{TS},A}, v_{0,A}^{\text{TS}}, \Sigma \cup \mathbb{T}, \xrightarrow{\text{TLTS}})$  and  $B$  has the corresponding TLTS  $B_{\text{TLTS}} = (V_{\text{TS},B}, v_{0,B}^{\text{TS}}, \Sigma \cup \mathbb{T}, \xrightarrow{\text{TLTS}})$ . A Relation  $R \subseteq V_{\text{TS},B} \times V_{\text{TS},A}$  is a *Timed Simulation*, if and only if for all pairs  $(v_{1,B}^{\text{TS}}, v_{1,A}^{\text{TS}}) \in R$  it holds that if there is a transition  $v_{1,B}^{\text{TS}} \xrightarrow{\mu}_{\text{TLTS}} v_{2,B}^{\text{TS}}$  for  $\mu \in \Sigma \cup \mathbb{T}$ , then a transition  $v_{1,A}^{\text{TS}} \xrightarrow{\mu}_{\text{TLTS}} v_{2,A}^{\text{TS}}$  with  $(v_{2,B}^{\text{TS}}, v_{2,A}^{\text{TS}}) \in R$ , exists.

$A$  timed simulates  $B$ , denoted  $B \sqsubseteq A$ , if and only if there exists a timed simulation  $R$  with  $(v_{0,B}^{\text{TS}}, v_{0,A}^{\text{TS}}) \in R$ .

We define Bounded Timed Simulation analogously to Definition 3.1.

### Definition A.2. (Bounded Timed Simulation for TLTS)

Let  $A_{\text{TLTS}} = (V_{\text{TS},A}, v_{0,A}^{\text{TS}}, \Sigma \cup \mathbb{T}, \xrightarrow{\text{TLTS}})$  and  $B_{\text{TLTS}} = (V_{\text{TS},B}, v_{0,B}^{\text{TS}}, \Sigma \cup \mathbb{T}, \xrightarrow{\text{TLTS}})$  be two TLTS. Any state  $v_A^{\text{TS}}$  of  $A_{\text{TLTS}}$  is timed simulated in order zero by any state  $v_B^{\text{TS}}$  of  $B_{\text{TLTS}}$ , denoted  $v_A^{\text{TS}} \sqsubseteq_0 v_B^{\text{TS}}$ .

$v_A^{\text{TS}}$  is timed simulated in order  $(n+1)$  by  $v_B^{\text{TS}}$ , denoted  $v_A^{\text{TS}} \sqsubseteq_{n+1} v_B^{\text{TS}}$ , if and only if the existence of a transition  $v_A^{\text{TS}} \xrightarrow{\mu}_{\text{TLTS}} v_{1,A}^{\text{TS}}$  for  $\mu \in \Sigma \cup \mathbb{T}$  implies the existence of a transition  $v_B^{\text{TS}} \xrightarrow{\mu}_{\text{TLTS}} v_{1,B}^{\text{TS}}$ , with  $v_{1,A}^{\text{TS}} \sqsubseteq_n v_{1,B}^{\text{TS}}$ .  $A_{\text{TLTS}}$  is timed simulated in order  $n$  by  $B_{\text{TLTS}}$ , written  $A_{\text{TLTS}} \sqsubseteq_n B_{\text{TLTS}}$ , if and only if  $v_{0,A}^{\text{TS}} \sqsubseteq_n v_{0,B}^{\text{TS}}$  holds.

A TA is *timed simulated in order  $n$*  by another TA, if this holds for their respective TLTS.

## B. DBM Basics

We shortly introduce DBMs here. For more information, see the comprehensive overview of Bengtsson and Yi [21]. We remind the reader of the fact that  $\mathcal{B}(C)$  can only contain natural numbers, even if dense-time model is used in which the clock valuations map clocks to values in  $\mathbb{R}^{\geq 0}$ . There is no loss of generality by using this assumption since all clock constraints of a TA can be multiplied by a sufficient power of ten and the overall behavior of the TA is not changed at all [21]. As already mentioned, for a reachable zone  $D \in \mathcal{D}(C)$  exists a clock constraint  $\phi \in \mathcal{B}(C)$ , such that the set of clock assignments satisfying  $\phi$ , denoted  $[\phi]$ , is equal to  $D$  ( $[\phi] = D$ ).

Let  $C[0] \notin C$  be a clock which has always the value zero and we enumerate the clocks in  $C$  with  $C[1], C[2], \dots, C[|C|]$ . It is well-known that for any zone  $D$ , which is reachable in a zone graph, exist  $z_{i,j} \in \mathbb{Z} \cup \{\infty\}$  and  $\preceq_{i,j} \in \{<, \leq\}$  for  $i, j \in [0, \dots, |C|]$ , such that  $D = [\bigwedge_{i,j \in [0, \dots, |C|]} C[i] - C[j] \preceq_{i,j} z_{i,j}]$  holds. This clock constraint can be represented by a  $|C| + 1 \times |C| + 1$  matrix  $M$  in which each element contains a pair  $(z_{i,j}, \preceq_{i,j})$ , representing a constraint of the form  $C[i] - C[j] \preceq_{i,j} z_{i,j}$ . We call such a matrix *Difference Bound Matrix (DBM)*. We define the set of all DBMs over a set of clocks  $C$

to be  $\mathcal{M}(C)$  and define the operator  $[\ ]$  for DBMs such that it extracts the corresponding zone

$$[M] = [ \bigwedge_{i,j \in [0, \dots, |C|]} C[i] - C[j] \preccurlyeq_{i,j} z_{i,j} ].$$

## C. Soundness and Completeness of Zone Graphs

We show Proposition 2.1 here.

### Proof:

We first show soundness and afterwards completeness. Soundness can be proven by using induction in the length of the transition sequence  $(l_0, D_0) \xrightarrow{ZG}^{\mu_{\varepsilon,1}} \dots \xrightarrow{ZG}^{\mu_{\varepsilon,n}} (l_n, D_n)$ .

**Hypothesis:** Whenever there is a transition sequence  $(l_0, D_0) \xrightarrow{ZG}^{\mu_{\varepsilon,1}} \dots \xrightarrow{ZG}^{\mu_{\varepsilon,n}} (l_n, D_n)$  with  $\forall x \in [1..n] : \mu_{\varepsilon,x} \in \Sigma \cup \{\varepsilon\}$ , then

$$\forall u_n \in D_n : \exists \mu_{\mathbb{T},1}, \dots, \mu_{\mathbb{T},n} \in \Sigma \cup \mathbb{T} : (l_0, u_0) \xrightarrow{TLTS}^{\mu_{\mathbb{T},1}} \dots \xrightarrow{TLTS}^{\mu_{\mathbb{T},n}} (l_n, u_n).$$

**Base Case:** Whenever the run without any symbols is enabled in the zone graph, then the run without any symbols is also enabled in the TLTS.

**Induction Step:** If the hypothesis holds for a transition sequence using  $n$  symbols, then it also holds for a transition sequence using  $n + 1$  symbols.

Since we always assume  $[C \rightarrow 0] \models I(l_0)$  in this publication, the run which consists of the initial state only is always enabled in TLTS and zone graph. Therefore, the base case is fulfilled.

Given a transition sequence  $(l_0, D_0) \xrightarrow{ZG}^{\mu_{\varepsilon,1}} \dots \xrightarrow{ZG}^{\mu_{\varepsilon,n+1}} (l_{n+1}, D_{n+1})$ , we distinguish two cases:

1.  $\mu_{\varepsilon,n+1} = \varepsilon$ . Due to Definition 2.7,  $l_n = l_{n+1}$  and

$$\begin{aligned} D_{n+1} &= D_n^\dagger \wedge I(l_n) \\ &= \{u + d \mid d \in \mathbb{T} \wedge u \in D_n\} \cap \{u \mid u \models I(l_n)\}. \end{aligned}$$

hold, i.e. for all  $u_{n+1} \in D_{n+1}$  there is a  $d \in \mathbb{T}$  and a  $u_n \in D_n$ , such that  $u_{n+1} = u_n + d$ , and  $u_{n+1} \models I(l_n)$  holds. Therefore, there is a transition  $(l_n, u_n) \xrightarrow{TLTS}^d (l_n, u_{n+1})$  in the TLTS by

Definition 2.3. Due to the induction hypothesis, the transition sequence  $(l_0, D_0) \xrightarrow{ZG}^{\mu_{\varepsilon,1}} \dots \xrightarrow{ZG}^{\mu_{\varepsilon,n}} (l_n, D_n)$  implies the transition sequence  $(l_0, u_0) \xrightarrow{TLTS}^{\mu_{\mathbb{T},1}} \dots \xrightarrow{TLTS}^{\mu_{\mathbb{T},n}} (l_n, u_n)$  and, therefore, the transition sequence  $(l_0, u_0) \xrightarrow{TLTS}^{\mu_{\mathbb{T},1}} \dots \xrightarrow{TLTS}^{\mu_{\mathbb{T},n+1}} (l_{n+1}, u_{n+1})$  is enabled.

2.  $\mu_{\varepsilon,n+1} \in \Sigma$ . Definition 2.7 implies that  $A$  contains a transition  $l_n \xrightarrow{TA}^{g, \mu_{\varepsilon,n+1}, R} l_{n+1}$  and

$$D_{n+1} = R(D_n \wedge g) \wedge I(l_{n+1})$$

$$= \{[R \rightarrow 0]u \mid u \in D_n \wedge g\} \cap \{u \mid u \models I(l_{n+1})\}$$

holds. Therefore, for all  $u_{n+1} \in D_{n+1}$  there is a clock valuation  $u_n \in D_n$  such that  $u_n \models g$ ,  $u_{n+1} = [R \rightarrow 0]u_n$ , and  $u_{n+1} \models I(l_{n+1})$ . (Due to Definition 2.7, there is always at least a single  $u_{n+1} \in D_{n+1}$ .) Using this, the transition in  $A$  implies a transition  $(l_n, u_n) \xrightarrow{TLTS, \mu_{\varepsilon, n+1}} (l_{n+1}, u_{n+1})$  in the TLTS by Definition 2.3. Due to the induction hypothesis, the transition sequence  $(l_0, D_0) \xrightarrow{ZG, \mu_{\varepsilon, 1}} \dots \xrightarrow{ZG, \mu_{\varepsilon, n}} (l_n, D_n)$  implies the transition sequence  $(l_0, u_0) \xrightarrow{TLTS, \mu_{\mathbb{T}, 1}} \dots \xrightarrow{TLTS, \mu_{\mathbb{T}, n}} (l_n, u_n)$  and, therefore, the transition sequence  $(l_0, u_0) \xrightarrow{TLTS, \mu_{\mathbb{T}, 1}} \dots \xrightarrow{TLTS, \mu_{\mathbb{T}, n+1}} (l_{n+1}, u_{n+1})$  is enabled.

Now we show completeness. Completeness can be shown by using induction in the length of the transition sequence  $(l_0, u_0) \xrightarrow{TLTS, \mu_{\mathbb{T}, 1}} \dots \xrightarrow{TLTS, \mu_{\mathbb{T}, n}} (l_n, u_n)$ .

**Hypothesis:** Whenever there is a transition sequence  $(l_0, u_0) \xrightarrow{TLTS, \mu_{\mathbb{T}, 1}} \dots \xrightarrow{TLTS, \mu_{\mathbb{T}, n}} (l_n, u_n)$  with  $\forall x \in [1..n] : \mu_{\mathbb{T}, x} \in \Sigma \cup \mathbb{T}$ , then

$$\exists D_n \in \mathcal{D}(C) : \exists \mu_{\varepsilon, 1} \dots \mu_{\varepsilon, n} \in \Sigma \cup \{\varepsilon\} : u_n \in D_n \wedge (l_0, D_0) \xrightarrow{ZG, \mu_{\varepsilon, 1}} \dots \xrightarrow{ZG, \mu_{\varepsilon, n}} (l_n, D_n).$$

**Base Case:** Whenever the run without any symbols is enabled in the TLTS, then the run without any symbols is also enabled in the zone graph.

**Induction Step:** If the hypothesis holds for a transition sequence using  $n$  symbols, then it also holds for a transition sequence using  $n + 1$  symbols.

Since  $[C \rightarrow 0] \models I(l_0)$  is a precondition in this publication, the run which consists of the initial state only is always enabled in TLTS and zone graph. Since  $u_0 \in D_0$ , the base case is fulfilled.

Now we show the induction step. Given a transition sequence  $(l_0, u_0) \xrightarrow{TLTS, \mu_{\mathbb{T}, 1}} \dots \xrightarrow{TLTS, \mu_{\mathbb{T}, n+1}} (l_{n+1}, u_{n+1})$  we need to show that

$$\exists D_{n+1} \in \mathcal{D}(C) : \exists \mu_{\varepsilon, 1} \dots \mu_{\varepsilon, n+1} \in \Sigma \cup \{\varepsilon\} : u_{n+1} \in D_{n+1} \wedge (l_0, D_0) \xrightarrow{ZG, \mu_{\varepsilon, 1}} \dots \xrightarrow{ZG, \mu_{\varepsilon, n+1}} (l_{n+1}, D_{n+1}).$$

holds. We distinguish two cases here:

1.  $\mu_{\mathbb{T}, n+1} \in \mathbb{T}$ . By the induction hypothesis,  $(l_0, u_0) \xrightarrow{TLTS, \mu_{\mathbb{T}, 1}} \dots \xrightarrow{TLTS, \mu_{\mathbb{T}, n}} (l_n, u_n)$  implies the existence of a transition sequence  $(l_0, D_0) \xrightarrow{ZG, \mu_{\varepsilon, 1}} \dots \xrightarrow{ZG, \mu_{\varepsilon, n+1}} (l_n, D_n)$  with  $u_n \in D_n$ .

Moreover, by Definition 2.3,  $l_n = l_{n+1}$ ,  $u_{n+1} \models I(l_n)$ , and  $u_{n+1} = u_n + \mu_{\mathbb{T}, n+1}$  holds. Since each symbolic state has an outgoing  $\varepsilon$ -transition,  $(l_n, D_n)$  has an outgoing transition  $(l_n, D_n) \xrightarrow{ZG, \varepsilon} (l_n, D_{n+1})$  with

$$\begin{aligned} D_{n+1} &= D_n^\dagger \wedge I(l_n) \\ &= \{u + d \mid u \in D_n \wedge d \in \mathbb{T}\} \cap \{u \mid u \models I(l_n)\}. \end{aligned}$$

Since  $u_{n+1} \in \{u + d \mid u \in D_n \wedge u \models I(l_n) \wedge d \in \mathbb{T}\}$  and  $u_{n+1} \in \{u \mid u \models I(l_n)\}$ ,  $u_{n+1} \in D_{n+1}$  and completeness hold in this case.

2.  $\mu_{\mathbb{T},n+1} \in \Sigma$ . By the induction hypothesis,  $(l_0, u_0) \xrightarrow{TLTS}^{\mu_{\mathbb{T},1}} \dots \xrightarrow{TLTS}^{\mu_{\mathbb{T},n}} (l_n, u_n)$  implies the existence of a transition sequence  $(l_0, D_0) \xrightarrow{ZG}^{\mu_{\varepsilon,1}} \dots \xrightarrow{ZG}^{\mu_{\varepsilon,n}} (l_n, D_n)$  with  $u_n \in D_n$ .

If there is a transition  $(l_n, u_n) \xrightarrow{TLTS}^{\mu_{\mathbb{T},n+1}} (l_{n+1}, u_{n+1})$  in  $A_{TLTS}$ , there is a transition  $l_n \xrightarrow{TA}^{g, \mu_{\mathbb{T},n+1}, R} l_{n+1}$  in  $A$ , such that  $u_n \models g$ ,  $u_{n+1} = [R \rightarrow 0]u_n$ , and  $u_{n+1} \models I(l_{n+1})$ . Thus, if  $D_{n+1} = R(D_n \wedge g) \wedge I(l_{n+1}) \neq \emptyset$ , there exists a transition  $(l_n, D_n) \xrightarrow{ZG}^{\mu_{\mathbb{T},n+1}} (l_{n+1}, D_{n+1})$  by Definition 2.7. Since

$$\begin{aligned} D_{n+1} &= R(D_n \wedge g) \wedge I(l_{n+1}) \\ &= \{[R \rightarrow 0]u \mid u \in D_n \wedge u \models g\} \cap \{u \mid u \models I(l_{n+1})\} \end{aligned}$$

and since  $u_{n+1} \in \{[R \rightarrow 0]u \mid u \in D_n \wedge u \models g\}$  and  $u_{n+1} \in \{u \mid u \models I(l_{n+1})\}$ ,  $u_{n+1} \in D_{n+1}$  and, therefore,  $D_{n+1} \neq \emptyset$  hold and the induction step is shown.  $\square$

Therefore, Proposition 2.1 holds.

## D. Soundness of k-Normalization

We show Proposition 2.2 here. We use the shorthand notation  $\sim_{<, \leq} \in \{<, \leq\}$  in the following definition.

### Definition D.1. (k-Normalization)

Let  $C$  be a set of clocks,  $M \in \mathcal{M}(C)$  a DBM over  $C$ , and  $k : C \rightarrow \mathbb{N}^{\geq 0}$ .  $\text{norm}(M, k)$  is defined by

1. replacing all constraints of the form  $c \sim_{<, \leq} n$ ,  $c - c' \sim_{<, \leq} n$  where  $n > k(c)$  with  $c < \infty$  or  $c - c' < \infty$  respectively, and
2. replacing all constraints of the form  $-c \sim_{<, \leq} n$ ,  $c - c' \sim_{<, \leq} n$  where  $n < -k(c)$  with  $-c < -k(c)$  or  $c - c' < -k(c)$  respectively.

We may overload the previous notation by denoting  $k$ -normalization of a zone  $D \in \mathcal{D}(C)$  as

$$\text{norm}(D, k).$$

Before we can show Proposition 2.2 we introduce some helping propositions. The first proposition shows that the calculation rules of Definition D.1 keep a subset relationship.

### Proposition D.1. (norm keeps subset relationship)

Assume a set of clocks  $C$  and two zones  $D, D' \in \mathcal{D}(C)$  with canonic DBMs  $M$  and  $M'$ . Let  $k : C \rightarrow \mathbb{N}^{\geq 0}$  be a function,  $M_{\text{norm}}$  be the DBM, which results if the calculation rules of Definition D.1 are applied to  $M$ , and  $M'_{\text{norm}}$  be the DBM, which results if the calculation rules of Definition D.1 are applied to  $M'$ .

$$[M] \subseteq [M'] \text{ implies } [M_{\text{norm}}] \subseteq [M'_{\text{norm}}].$$

**Proof:**

To show this statement, we assume  $[M] \subseteq [M']$  (otherwise the proposition holds trivially) and show that for any  $u \in [M_{\text{norm}}]$  the statement  $u \in [M'_{\text{norm}}]$  holds. Before we do so, we remind the reader of the fact that from Bengtsson and Yi [21] we know that for the canonic DBMs  $M, M'$  the assumption  $[M] \subseteq [M']$  implies that the solution set of any atomic clock constraint of  $M$  is a subset of the solution set of any atomic clock constraint of  $M'$  if both atomic clock constraints regard the same clocks.

Given any  $u \in [M_{\text{norm}}]$  we show that any atomic clock constraint  $\phi'$  of  $M'_{\text{norm}}$  is fulfilled by  $u$ .

If  $\phi'$  is unchanged by the calculation rules of Definition D.1, we know that any clock valuation of  $M'$  fulfills  $\phi'$  and, therefore, any clock valuation of  $M$  fulfills  $\phi'$ , too. Since the corresponding atomic constraint  $\phi$  of  $M$  is stronger than  $\phi'$ ,  $\phi$  is either unchanged, which trivially implies  $u \models \phi'$ , or  $\phi$  is normed to  $< -k(c)$ . Since  $\phi'$  is unchanged, the normed atomic constraint is stronger than  $\phi'$  and, therefore,  $u \models \phi'$  holds in this case, too.

Now we assume that  $\phi'$  has been changed. We distinguish the following cases:

1.  $\phi' = c < \infty$  or  $\phi = c - c' < \infty$ . In this case,  $u \models \phi$  holds trivially,
2.  $\phi' = -c < -k(c)$ . In this case, there exists an atomic constraint  $c \sim'_{<, \leq} n'$  with  $n' < -k(c)$  in  $M'$ . Since all atomic constraints in  $M$  are at least as strong as in  $M'$ , the corresponding atomic constraint in  $M$  has the form  $c \sim_{<, \leq} n$  with  $n \leq n' < k(c)$ . Therefore, by applying the calculation rules, we know that  $M_{\text{norm}}$  also contains the atomic constraint  $-c < -k(c)$ . Therefore,  $u \models -c < -k(c)$  (since  $u \in [M_{\text{norm}}]$ ) and  $u \models \phi'$  holds,
3.  $\phi' = c - c' < k(c)$ . This case can be shown analogously to the previous case.

Therefore,  $u$  fulfills all atomic constraints of  $M'_{\text{norm}}$ ,  $u \in [M_{\text{norm}}]$  implies  $u \in [M'_{\text{norm}}]$ , and Proposition D.1 holds.  $\square$

The next proposition shows that if the calculation rules of Definition D.1 are applied first and afterwards an operation is applied, the result contains any clock valuation of the zone, which is created by first applying the operation and afterwards applying the calculation rules of Definition D.1.

**Proposition D.2.** ( $u \models M_{\pi, \text{norm}}$  implies  $u \models \pi(M_{\text{norm}})$ )

Assume a set of clocks  $C$ , a zone  $D \in \mathcal{D}(C)$  with canonic DBM  $M$ , and an operation  $\pi$ , which can be a  $\wedge$ -, future-, or reset-operation. If  $\pi$  is a  $\wedge$ -operation, we assume that the used clock constraint has the form  $c \sim n$ , with  $c \in C$ ,  $\sim \in \{<, \leq, \geq, >\}$ , and  $n \in \mathbb{N}^{\geq 0}$ . Let  $k : C \rightarrow \mathbb{N}^{\geq 0}$  be a function, such that  $k(c) > n$  if  $\pi$  is a  $\wedge$ -operation. Let  $M_{\text{norm}}$  be the DBM, which results if the calculation rules of Definition D.1 are applied to  $M$ . Let  $M_{\pi, \text{norm}}$  be the clock constraint, which results if the calculation rules of Definition D.1 are applied to the canonic DBM of  $\pi(D)$ .

$$[M_{\pi, \text{norm}}] \subseteq [\pi(M_{\text{norm}})]$$

holds.

**Proof:**

To show Proposition D.2, we assume any  $u \in [M_{\pi, \text{norm}}]$  and show that  $u \in [\pi(M_{\text{norm}})]$  holds. We distinguish the different possibilities for  $\pi$ .

- $\pi(D) = D \wedge c \sim n$  with  $c \in C$ ,  $\sim \in \{<, \leq, \geq, >\}$ , and  $n \in \mathbb{N}^{\geq 0}$ . Moreover, we know that  $n \in [0, k(c) - 1]$ . Obviously,  $D \wedge c \sim n \subseteq D$  and, therefore,  $[M_{\pi, \text{norm}}] \subseteq [M_{\text{norm}}]$  (Proposition D.1). Therefore,  $u \in [M_{\pi, \text{norm}}]$  implies  $u \in [M_{\text{norm}}]$  and to show that  $u \in [\pi(M_{\text{norm}})] = [M_{\text{norm}} \wedge c \sim n]$  holds, we only have to show that  $u \in [M_{\pi, \text{norm}}]$  implies  $u \models c \sim n$ . We distinguish two cases:
  1.  $\sim \in \{<, \leq\}$ . Since  $n \in [0, k(c) - 1]$ , the atomic clock constraint of  $M$  regarding the clock  $c$  has a value between 0 and  $k(c) - 1$  (a constraint  $c \sim_{<, \leq} n$  with  $n < 0$  does not make any sense). Therefore, the calculation rules of Definition D.1 do not change the atomic clock constraint regarding the upper bound of  $c$ . Therefore,  $u \in [M_{\pi, \text{norm}}]$  implies  $u \models c \sim n$  in this subcase,
  2.  $\sim \in \{>, \geq\}$ . Let  $c \sim'_{>, \geq} n'$  be the atomic constraint of  $M$ . We distinguish two cases:
    - (a)  $[c \sim n] \subseteq [c \sim'_{>, \geq} n']$ . In this case, the atomic constraint of the canonic DBM of  $\pi(D)$  is equal to  $c \sim n$ . Since  $n < k(c)$ , the calculation rules of Definition D.1 do not change the atomic clock constraint regarding the lower bound of  $c$ . Therefore,  $u \in [M_{\pi, \text{norm}}]$  implies  $u \models c \sim n$  in this subcase,
    - (b)  $[c \sim'_{>, \geq} n'] \subseteq [c \sim n]$ . In this case,  $M_{\pi, \text{norm}}$  has as lower bound either  $c \sim'_{>, \geq} n'$  or  $c > k(c)$ . In both cases, since  $n < k(c)$ ,  $u \in [M_{\pi, \text{norm}}]$  implies  $u \models c \sim n$ .
- $\pi(D) = [c \rightarrow 0]D$  with  $c \in C$ . In this case, the upper and lower bound of  $c$  are both set to zero ( $c \leq 0$  and  $-c \leq 0$ ) and any constraint of the form  $c - c' \sim_{<, \leq} n$  or  $c' - c \sim'_{<, \leq} n'$  are set to the upper or lower bound of  $c'$ . Therefore, whether the calculation rules are applied first or the reset is applied first makes no difference and

$$[M_{\pi, \text{norm}}] = [\pi(M_{\text{norm}})]$$

holds.

- $\pi(D) = D^\dagger$ . The future operator replaces all upper bounds of the form  $c \sim_{<, \leq} n$  to  $c < \infty$  and does not change any other atomic constraint. Therefore, the only difference between  $[M_{\pi, \text{norm}}]$   $[\pi(M_{\text{norm}})]$  could be at the atomic constraints of the form  $c \sim_{<, \leq} n$ . If the future operator is applied first and afterwards the calculation rules of Definition D.1 are applied, all upper bounds are set to  $c < \infty$ . If the calculation rules of Definition D.1 are applied first and afterwards the future operator is applied, all upper bounds are set to  $c < \infty$ , too. Therefore, the upper bounds are the same and

$$[M_{\pi, \text{norm}}] = [\pi(M_{\text{norm}})]$$

holds.

Therefore, Proposition D.2 holds. □

The last proposition shows that applying any operation does not change the relationship between a zone and the zone which is created by applying the calculation rules of Definition D.1.



**Proposition D.3. (An Operation does not change equivalent regions)**

Assume a set of clocks  $C$ , a zone  $D \in \mathcal{D}(C)$  with canonic DBM  $M$ , and an operation  $\pi$ , which can be a  $\wedge$ -, future-, or reset-operation. If  $\pi$  is a  $\wedge$ -operation, we assume that the used clock constraint has the form  $c \sim n$ , with  $c \in C$ ,  $\sim \in \{<, \leq, \geq, >\}$ , and  $n \in \mathbb{N}^{\geq 0}$ . Let  $k : C \rightarrow \mathbb{N}^{\geq 0}$  be a function, such that  $k(c) > n$  if  $\pi$  is a  $\wedge$ -operation. Let  $M_{\text{norm}}$  be the DBM, which results if the calculation rules of Definition D.1 are applied to  $M$ . If

$$\forall u_n \in [M_{\text{norm}}] : \exists u \in [M] : u_n \simeq_k u$$

holds, then

$$\forall u_{\pi,n} \in [\pi(M_{\text{norm}})] : \exists u_{\pi} \in [\pi(M)] : u_{\pi,n} \simeq_k u_{\pi}$$

also holds.

**Proof:**

To show that the proposition holds, we assume a canonic DBM  $M$  with

$$\forall u_n \in [M_{\text{norm}}] : \exists u \in [M] : u_n \simeq_k u$$

(otherwise, the proposition holds trivially) and show that for any  $u_{\pi,n} \in [\pi(M_{\text{norm}})]$  there exists a  $u_{\pi} \in [\pi(M)]$  such that  $u_{\pi,n} \simeq_k u_{\pi}$  holds. We distinguish the different possibilities for  $\pi$ .

- $\pi(D) = D \wedge c \sim n$  with  $c \in C$ ,  $\sim \in \{<, \leq, \geq, >\}$ , and  $n \in \mathbb{N}^{\geq 0}$ . In this case,  $\pi(M_{\text{norm}}) = M_{\text{norm}} \wedge c \sim n$ , which implies  $u_{\pi,n} \in [M_{\text{norm}}]$  and  $u_{\pi,n} \models c \sim n$ . By the precondition, there exists a  $u \in [M]$  such that  $u_{\pi,n} \simeq_k u$ . Due to Definition 2.5, we know that region equivalence implies that  $u_{\pi,n} \models c \sim n$  if and only if  $u \models c \sim n$  holds. Therefore,  $u \in [M \wedge c \sim n] = [\pi(M)]$  and Proposition D.3 holds in this case.
- $\pi(D) = [c \rightarrow 0]D$  with  $c \in C$ . In this case,  $\pi(M_{\text{norm}}) = [c \rightarrow 0]M_{\text{norm}}$  and for any  $u_{\pi,n} \in [[c \rightarrow 0]M_{\text{norm}}]$  exists a  $u_n \in [M_{\text{norm}}]$  such that  $u_{\pi,n} = [c \rightarrow 0]u_n$ . By the precondition, there exists a  $u \in [M]$  such that  $u_n \simeq_k u$ . By the definition of the reset operation exists a  $u_{\pi} \in [[c \rightarrow 0]M] = [\pi(M)]$  such that  $u_{\pi} = [c \rightarrow 0]u$ . To show the proposition, we need to show  $u_{\pi} \simeq_k u_{\pi,n}$ . To do so, we choose any clock  $c_{\text{any}} \in C$ . If  $c_{\text{any}} = c$ ,  $u_{\pi}(c_{\text{any}}) = 0 = u_{\pi,n}(c_{\text{any}})$  holds, which obviously implies all three conditions of Definition 2.5. If  $c_{\text{any}} \in C \setminus \{c\}$ ,  $u_{\pi}(c_{\text{any}}) = u(c_{\text{any}})$  and  $u_{\pi,n}(c_{\text{any}}) = u_n(c_{\text{any}})$  holds. In this case, all three conditions of Definition 2.5 are implied by  $u_n \simeq_k u$ .
- $\pi(D) = D^{\uparrow}$ . In this case,  $\pi(M_{\text{norm}}) = M_{\text{norm}}^{\uparrow}$  and for any  $u_{\pi,n} \in [M_{\text{norm}}^{\uparrow}]$  exists a  $u_n \in [M_{\text{norm}}]$  and a  $d \in \mathbb{T}$  such that  $u_{\pi,n} = u_n + d$ . By the precondition, there exists a  $u \in [M]$  such that  $u_n \simeq_k u$ . Alur and Dill [16] show (below Definition 4.6) that there exists a  $d' \in \mathbb{T}$  with  $u_n + d \simeq_k u + d'$ . Therefore, we define  $u_{\pi} = u + d'$  and follow  $u_{\pi,n} \simeq_k u_{\pi}$ . Moreover,  $u_{\pi} \in [M^{\uparrow}]$  holds by the definition of the future-operator and, therefore, the proposition holds in this case, too.

Therefore, Proposition D.3 holds. □

Now we can show Proposition 2.2.

**Proof:**

Since the calculation rules of Definition D.1 only relax constraints and do not strengthen any,  $\Pi(D_0) \subseteq \text{norm}(\Pi(D_0), k)$  trivially holds, and we show only

$$\forall u_n \in \text{norm}(\Pi(D_0), k) : \exists u \in \Pi(D_0) : u_n \simeq_k u.$$

We prove this statement by induction in the number of operation.

**Hypothesis:**  $\forall u_n \in \text{norm}(\Pi(D_0), k) : \exists u \in \Pi(D_0) : u_n \simeq_k u$  holds.

**Base Case:** If no operation is applied to  $D_0$ , then the hypothesis holds.

**Induction Step:** If the hypothesis holds after  $i$  operation are applied to  $D_0$ , it also holds if  $i + 1$  operation are applied to  $D_0$ .

We first show the base case. Since applying the calculation rules of Definition D.1 to the initial DBM  $M_0$  does not change any entry (since they are all set to  $(\leq, 0)$ ), we know  $\text{norm}(D_0, k) = D_0$ . Moreover, the only clock valuation that is in the same region as  $(C \rightarrow 0)$  is  $(C \rightarrow 0)$ . Therefore,

$$\begin{aligned} & \forall u_n \in \text{norm}(D_0, k) : \exists u \in D_0 : u_n \simeq_k u \\ \Leftrightarrow & \forall u_n \in \{(C \rightarrow 0)\} : \exists u \in \{(C \rightarrow 0)\} : u_n \simeq_k u \\ \Leftrightarrow & (C \rightarrow 0) \simeq_k (C \rightarrow 0), \end{aligned}$$

which is obviously a true statement and the base case is implied. We now show the induction step.

To show the induction step, we denote  $D = \Pi(D_0)$ , assume

$$\forall u_n \in \text{norm}(D, k) : \exists u \in D : u_n \simeq_k u,$$

and show

$$\forall u_{\pi, n} \in \text{norm}(\pi(D), k) : \exists u_\pi \in \pi(D) : u_{\pi, n} \simeq_k u_\pi.$$

For any  $u_{\pi, n} \in \text{norm}(\pi(D), k)$  we know  $u_{\pi, n} \in \pi(\text{norm}(D, k))$  (Proposition D.2). If the precondition of Proposition D.3 is fulfilled, then there exists a  $u_\pi \in [\pi(M)]$  such that  $u_{\pi, n} \simeq_k u_\pi$ . Therefore, we only have to check the precondition of Proposition D.3.

The precondition of Proposition D.3 holds if

$$\forall u_n \in \text{norm}(D, k) : \exists u \in D : u_n \simeq_k u,$$

holds, which is the case by the induction hypothesis.

Therefore, the induction step holds, which implies the induction hypothesis, which implies Proposition 2.2.  $\square$

## E. $k$ -Normalization is finite

We show Proposition 2.3 here.

**Proof:**

A DBM has  $(|C| + 1)^2$  entries. Each entry  $M[i][j]$  consists of a value  $\sim \in \{<, \leq\}$  and a value  $z \in \mathbb{Z} \cup \{\infty\}$  with  $-K \leq z \leq K \vee z = \infty$ . Moreover, the  $\infty$  value can be combined with  $<$ , only. Therefore, there are  $|\{<, \leq\}| \cdot (2 \cdot K + 1) + 1 = 4K + 3$  entries possible. Since there are  $(|C| + 1)^2$  entries per DBM, there are no more than  $(4K + 3)^{(|C|+1)^2}$  different DBM possible.  $\square$

## F. Monotonicity of Bounded Bisimulation

We show Proposition 3.1 here. Since monotonicity of bounded bisimulation can be shown analogously to monotonicity of bounded simulation, we show only monotonicity of bounded simulation.

### Proposition F.1. (Monotonicity of Bounded Simulation)

Let  $A_{\text{TLTS}}$  and  $B_{\text{TLTS}}$  be two TLTS with  $v_A^{\text{TS}}$  being a state in  $A_{\text{TLTS}}$  and  $v_B^{\text{TS}}$  being a state in  $B_{\text{TLTS}}$ . For any  $n \in \mathbb{N}^{\geq 0}$ ,  $v_A^{\text{TS}} \sqsubseteq_{n+1} v_B^{\text{TS}}$  implies  $v_A^{\text{TS}} \sqsubseteq_n v_B^{\text{TS}}$ .

**Proof:**

We prove by induction in  $n$ .

**Hypothesis:**  $v_A^{\text{TS}} \sqsubseteq_{n+1} v_B^{\text{TS}}$  implies  $v_A^{\text{TS}} \sqsubseteq_n v_B^{\text{TS}}$ .

**Base Case:**  $v_A^{\text{TS}} \sqsubseteq_1 v_B^{\text{TS}}$  implies  $v_A^{\text{TS}} \sqsubseteq_0 v_B^{\text{TS}}$ .

**Induction Step:** If  $v_A^{\text{TS}} \sqsubseteq_{n+1} v_B^{\text{TS}}$  implies  $v_A^{\text{TS}} \sqsubseteq_n v_B^{\text{TS}}$ , then  $v_A^{\text{TS}} \sqsubseteq_{n+2} v_B^{\text{TS}}$  implies  $v_A^{\text{TS}} \sqsubseteq_{n+1} v_B^{\text{TS}}$ .

Since  $v_A^{\text{TS}} \sqsubseteq_0 v_B^{\text{TS}}$  is always true, the base case holds. If  $v_A^{\text{TS}} \sqsubseteq_{n+2} v_B^{\text{TS}}$  holds, for each transition  $v_A^{\text{TS}} \xrightarrow{\mu}_{\text{TLTS}_A} v_{1,A}^{\text{TS}}$  there is a transition  $v_B^{\text{TS}} \xrightarrow{\mu}_{\text{TLTS}_B} v_{1,B}^{\text{TS}}$  and  $v_{1,A}^{\text{TS}} \sqsubseteq_{n+1} v_{1,B}^{\text{TS}}$  holds. Due to the induction hypothesis,  $v_{1,A}^{\text{TS}} \sqsubseteq_n v_{1,B}^{\text{TS}}$  also holds and therefore  $v_A^{\text{TS}} \sqsubseteq_{n+1} v_B^{\text{TS}}$  by Definition 3.1.  $\square$

## G. Relationship between Bounded (Bi-)Simulation and (Bi-)Simulation of TLTS

This section proves Proposition 3.2. Since the proof of the relation between bounded timed bisimulation and timed bisimulation is analogous to the proof of the relation between bounded timed simulation and timed simulation, we show only the relation between bounded timed simulation and timed simulation.

We first introduce the concept of Bounded Simulation Relations  $R_n$ , which we use as intermediate structure later on.

### Definition G.1. (Bounded Simulation Relation $R_n$ )

Assume two TA  $A, B$ , and the corresponding TLTS  $A_{\text{TLTS}} = (V_{\text{TS},A}, v_{0,A}^{\text{TS}}, \Sigma \cup \mathbb{T}, \xrightarrow{\text{TLTS}_A})$ ,  $B_{\text{TLTS}} = (V_{\text{TS},B}, v_{0,B}^{\text{TS}}, \Sigma \cup \mathbb{T}, \xrightarrow{\text{TLTS}_B})$ . For a given value  $n \in \mathbb{N}^{\geq 0}$ , we define the Bounded Simulation Relation

$R_n \subseteq V_{\text{TS},A} \times V_{\text{TS},B}$  as

$$R_n = \begin{cases} V_{\text{TS},A} \times V_{\text{TS},B}, & \text{if } n = 0 \\ \{(v_A^{\text{TS}}, v_B^{\text{TS}}) \mid \forall v_{1,A}^{\text{TS}} \in V_{\text{TS},A} : \exists v_{1,B}^{\text{TS}} \in V_{\text{TS},B} : \\ v_A^{\text{TS}} \xrightarrow[\text{TLTS}]{\mu} v_{1,A}^{\text{TS}} \text{ implies } (v_B^{\text{TS}} \xrightarrow[\text{TLTS}]{\mu} v_{1,B}^{\text{TS}} \wedge (v_{1,A}^{\text{TS}}, v_{1,B}^{\text{TS}}) \in R_{n-1})\}, & \text{else} \end{cases}$$

We first show that for a pair of states  $(v_A^{\text{TS}}, v_B^{\text{TS}})$  there exists a Bounded Simulation Relation  $R_n$  with  $(v_A^{\text{TS}}, v_B^{\text{TS}}) \in R_n$  if and only if  $v_A^{\text{TS}}$  is simulated in order  $n$  by  $v_B^{\text{TS}}$ .

**Proposition G.1.**  $((v_A^{\text{TS}}, v_B^{\text{TS}}) \in R_n \text{ iff } v_A^{\text{TS}} \sqsubseteq_n v_B^{\text{TS}})$

Assume two TA  $A, B$ , and the corresponding TLTS  $A_{\text{TLTS}}, B_{\text{TLTS}}$ . Let  $v_A^{\text{TS}}$  be a state of  $A_{\text{TLTS}}$  and let  $v_B^{\text{TS}}$  be a state of  $B_{\text{TLTS}}$ . There exists a Bounded Simulation Relation  $R_n$  with  $(v_A^{\text{TS}}, v_B^{\text{TS}}) \in R_n$  if and only if  $v_A^{\text{TS}} \sqsubseteq_n v_B^{\text{TS}}$ .

**Proof:**

We first prove that the left hand side implies the right hand side and afterwards we prove the opposite direction. We show both directions by induction in  $n$ .

**Hypothesis:**  $(v_A^{\text{TS}}, v_B^{\text{TS}}) \in R_n \Rightarrow v_A^{\text{TS}} \sqsubseteq_n v_B^{\text{TS}}$  holds.

**Base Case:**  $(v_A^{\text{TS}}, v_B^{\text{TS}}) \in R_0 \Rightarrow v_A^{\text{TS}} \sqsubseteq_0 v_B^{\text{TS}}$  holds.

**Induction Step:** If  $(v_A^{\text{TS}}, v_B^{\text{TS}}) \in R_n \Rightarrow v_A^{\text{TS}} \sqsubseteq_n v_B^{\text{TS}}$  holds, then  $(v_A^{\text{TS}}, v_B^{\text{TS}}) \in R_{n+1} \Rightarrow v_A^{\text{TS}} \sqsubseteq_{n+1} v_B^{\text{TS}}$  holds, too.

Since  $v_A^{\text{TS}} \sqsubseteq_0 v_B^{\text{TS}}$  is always true, the base case holds trivially. If  $(v_A^{\text{TS}}, v_B^{\text{TS}}) \in R_{n+1}$  is false, the induction step is obviously true, and, therefore, we consider the case in which there exists a Bounded Simulation  $R_{n+1}$  with  $(v_A^{\text{TS}}, v_B^{\text{TS}}) \in R_{n+1}$ , only.  $(v_A^{\text{TS}}, v_B^{\text{TS}}) \in R_{n+1}$  implies that for every outgoing transition  $v_A^{\text{TS}} \xrightarrow[\text{TLTS}]{\mu} v_{1,A}^{\text{TS}}$  there exists a transition  $v_B^{\text{TS}} \xrightarrow[\text{TLTS}]{\mu} v_{1,B}^{\text{TS}}$  and due to  $(v_{1,A}^{\text{TS}}, v_{1,B}^{\text{TS}}) \in R_n$  we can apply the induction hypothesis, which yields  $v_{1,A}^{\text{TS}} \sqsubseteq_n v_{1,B}^{\text{TS}}$ . Therefore, for each transition  $v_A^{\text{TS}} \xrightarrow[\text{TLTS}]{\mu} v_{1,A}^{\text{TS}}$  there exists an outgoing transition  $v_B^{\text{TS}} \xrightarrow[\text{TLTS}]{\mu} v_{1,B}^{\text{TS}}$ , where  $v_{1,A}^{\text{TS}} \sqsubseteq_n v_{1,B}^{\text{TS}}$ , and, therefore,  $v_A^{\text{TS}} \sqsubseteq_{n+1} v_B^{\text{TS}}$  holds by Definition 3.1.

Now we show that the right hand side implies the left hand side.

**Hypothesis:**  $v_A^{\text{TS}} \sqsubseteq_n v_B^{\text{TS}} \Rightarrow (v_A^{\text{TS}}, v_B^{\text{TS}}) \in R_n$  holds.

**Base Case:**  $v_A^{\text{TS}} \sqsubseteq_0 v_B^{\text{TS}} \Rightarrow (v_A^{\text{TS}}, v_B^{\text{TS}}) \in R_0$  holds.

**Induction Step:** If  $v_A^{\text{TS}} \sqsubseteq_n v_B^{\text{TS}} \Rightarrow (v_A^{\text{TS}}, v_B^{\text{TS}}) \in R_n$  holds, then  $v_A^{\text{TS}} \sqsubseteq_{n+1} v_B^{\text{TS}} \Rightarrow (v_A^{\text{TS}}, v_B^{\text{TS}}) \in R_{n+1}$  holds, too.

Once again, the base is easy to show since  $(v_A^{\text{TS}}, v_B^{\text{TS}}) \in R_0$  is always true. If  $v_A^{\text{TS}} \sqsubseteq_{n+1} v_B^{\text{TS}}$  is false, the induction step is obviously true, and, therefore, we consider the case in which  $v_A^{\text{TS}} \sqsubseteq_{n+1} v_B^{\text{TS}}$  is true.  $v_A^{\text{TS}} \sqsubseteq_{n+1} v_B^{\text{TS}}$  implies that for every outgoing transition  $v_A^{\text{TS}} \xrightarrow[\text{TLTS}]{\mu} v_{1,A}^{\text{TS}}$  there exists a transition  $v_B^{\text{TS}} \xrightarrow[\text{TLTS}]{\mu} v_{1,B}^{\text{TS}}$  and due to  $v_{1,A}^{\text{TS}} \sqsubseteq_n v_{1,B}^{\text{TS}}$  we can apply the induction hypothesis, which yields  $(v_{1,A}^{\text{TS}}, v_{1,B}^{\text{TS}}) \in R_n$ . Therefore, for each transition  $v_A^{\text{TS}} \xrightarrow[\text{TLTS}]{\mu} v_{1,A}^{\text{TS}}$  there exists an outgoing transition

$v_B^{\text{TS}} \xrightarrow[\text{TLTS}]{\mu} v_{1,B}^{\text{TS}}$ , where  $(v_{1,A}^{\text{TS}}, v_{1,B}^{\text{TS}}) \in R_n$ , and, therefore,  $(v_A^{\text{TS}}, v_B^{\text{TS}}) \in R_{n+1}$  holds by Definition G.1.  $\square$

Due to Proposition G.1 we also know that the Bounded Simulation Relations cannot become larger with growing  $n$ :

**Corollary G.1.** ( $R_{n+1} \subseteq R_n$ )

Assume two TA  $A$ ,  $B$ , and the corresponding TLTS  $A_{\text{TLTS}}$ ,  $B_{\text{TLTS}}$ . Let for all  $n \in \mathbb{N}^{\geq 0}$   $R_n \subseteq V_{\text{TS},A} \times V_{\text{TS},B}$  be Bounded Simulation Relations as defined in Definition G.1.  $R_{n+1} \subseteq R_n$  holds.

**Proof:**

For any  $(v_A^{\text{TS}}, v_B^{\text{TS}}) \in R_{n+1}$ ,  $v_A^{\text{TS}} \sqsubseteq_{n+1} v_B^{\text{TS}}$  holds due to Proposition G.1. Due to Proposition F.1  $v_A^{\text{TS}} \sqsubseteq_n v_B^{\text{TS}}$  holds and again due to Proposition G.1,  $(v_A^{\text{TS}}, v_B^{\text{TS}}) \in R_n$  holds.  $\square$

In the following, we show that the series  $R_0, R_1, \dots$  has a limit  $\lim_{n \rightarrow \infty} R_n$  and this limit is a Timed Simulation. Given the set of pairs  $V_{\text{TS},A} \times V_{\text{TS},B}$  with  $V_{\text{TS},A}$  being the set of states of  $A_{\text{TLTS}}$  and  $V_{\text{TS},B}$  being the set of states of  $B_{\text{TLTS}}$ , it is well-known that the power set  $\mathcal{P}(V_{\text{TS},A} \times V_{\text{TS},B})$  with the relation  $\subseteq$  is a complete lattice. Moreover, there is a function  $f : \mathcal{P}(V_{\text{TS},A} \times V_{\text{TS},B}) \rightarrow \mathcal{P}(V_{\text{TS},A} \times V_{\text{TS},B})$  with

$$\begin{aligned} f(\mathcal{P}(V_{\text{TS},A} \times V_{\text{TS},B})) &= R_0 \\ f(R_0) &= R_1 \\ f(R_1) &= R_2 \\ &\dots \end{aligned}$$

and this function is obviously monotonic due to Corollary G.1. Due to the Knaster-Tarski theorem [29] and the monotonicity of Corollary G.1, there exists a greatest fixed point which is the intersection of all  $R_n$  and which we name  $\lim_{n \rightarrow \infty} R_n$  in the following.

**Definition G.2.** ( $\lim_{n \rightarrow \infty} R_n$ )

Assume two TA  $A$ ,  $B$ , and the corresponding TLTS  $A_{\text{TLTS}}$ ,  $B_{\text{TLTS}}$ . Let  $v_A^{\text{TS}}$  be a state of  $A_{\text{TLTS}}$ ,  $v_B^{\text{TS}}$  be a state of  $B_{\text{TLTS}}$ , and let for all  $n \in \mathbb{N}^{\geq 0}$   $R_n \subseteq V_{\text{TS},A} \times V_{\text{TS},B}$  be Bounded Simulation Relations as defined in Definition G.1. We define

$$(v_A^{\text{TS}}, v_B^{\text{TS}}) \in \lim_{n \rightarrow \infty} R_n \Leftrightarrow \forall n \in \mathbb{N}^{\geq 0} : (v_A^{\text{TS}}, v_B^{\text{TS}}) \in R_n.$$

The following proposition shows that  $\lim_{n \rightarrow \infty} R_n$  is a Timed Simulation.

**Proposition G.2.** ( $\lim_{n \rightarrow \infty} R_n$  is a Timed Simulation)

Assume two TA  $A$ ,  $B$ , and the corresponding TLTS  $A_{\text{TLTS}}$ ,  $B_{\text{TLTS}}$ . Let for all  $n \in \mathbb{N}^{\geq 0}$   $R_n \subseteq V_{\text{TS},A} \times V_{\text{TS},B}$  be Bounded Simulation Relations as defined in Definition G.1.  $\lim_{n \rightarrow \infty} R_n$  is a Timed Simulation by Definition A.1.

**Proof:**

It holds that

$$\begin{aligned}
& (v_A^{\text{TS}}, v_B^{\text{TS}}) \in \lim_{n \rightarrow \infty} R_n \\
& \Leftrightarrow \forall n \in \mathbb{N}^{\geq 0} : (v_A^{\text{TS}}, v_B^{\text{TS}}) \in R_n \\
& \Leftrightarrow \forall n \in \mathbb{N}^{\geq 0} : v_A^{\text{TS}} \xrightarrow{TLTS}^{\mu} v_{1,A}^{\text{TS}} \text{ implies } (\exists v_{1,B}^{\text{TS}} : v_B^{\text{TS}} \xrightarrow{TLTS}^{\mu} v_{1,B}^{\text{TS}} \wedge (v_{1,A}, v_{1,B}) \in R_{n-1}) \\
& \Leftrightarrow v_A^{\text{TS}} \xrightarrow{TLTS}^{\mu} v_{1,A}^{\text{TS}} \text{ implies } (\forall n \in \mathbb{N}^{\geq 0} : \exists v_{1,B}^{\text{TS}} : v_B^{\text{TS}} \xrightarrow{TLTS}^{\mu} v_{1,B}^{\text{TS}} \wedge (v_{1,A}, v_{1,B}) \in R_{n-1})
\end{aligned}$$

Due to  $R_{n+1} \subseteq R_n$ ,  $\forall n \in \mathbb{N}^{\geq 0} : \exists v_{1,B}^{\text{TS}} : v_B^{\text{TS}} \xrightarrow{TLTS}^{\mu} v_{1,B}^{\text{TS}} \wedge (v_{1,A}, v_{1,B}) \in R_{n-1}$  holds if and only if there exists a  $v_{1,B}$ , such that  $(v_{1,A}, v_{1,B})$  is a fixed point (since  $v_B^{\text{TS}}$  and  $\mu$  are fixed, there are always finitely many candidates for  $v_{1,B}^{\text{TS}}$ ). Therefore,  $n$  and  $v_{1,B}^{\text{TS}}$  are independent, meaning that for all  $n$  there exists the same  $v_{1,B}^{\text{TS}}$ , resulting into

$$\begin{aligned}
& (v_A^{\text{TS}}, v_B^{\text{TS}}) \in \lim_{n \rightarrow \infty} R_n \\
& \Leftrightarrow v_A^{\text{TS}} \xrightarrow{TLTS}^{\mu} v_{1,A}^{\text{TS}} \text{ implies } (\exists v_{1,B}^{\text{TS}} : \forall n \in \mathbb{N}^{\geq 0} : v_B^{\text{TS}} \xrightarrow{TLTS}^{\mu} v_{1,B}^{\text{TS}} \wedge (v_{1,A}, v_{1,B}) \in R_{n-1}) \\
& \Leftrightarrow v_A^{\text{TS}} \xrightarrow{TLTS}^{\mu} v_{1,A}^{\text{TS}} \text{ implies } (\exists v_{1,B}^{\text{TS}} : v_B^{\text{TS}} \xrightarrow{TLTS}^{\mu} v_{1,B}^{\text{TS}} \wedge \forall n \in \mathbb{N}^{\geq 0} : (v_{1,A}, v_{1,B}) \in R_{n-1})
\end{aligned}$$

and since  $\forall n \in \mathbb{N}^{\geq 0} : (v_{1,A}, v_{1,B}) \in R_{n-1} \Leftrightarrow \forall n \in \mathbb{N}^{\geq 0} : (v_{1,A}, v_{1,B}) \in R_n$

$$\begin{aligned}
& (v_A^{\text{TS}}, v_B^{\text{TS}}) \in \lim_{n \rightarrow \infty} R_n \\
& \Leftrightarrow v_A^{\text{TS}} \xrightarrow{TLTS}^{\mu} v_{1,A}^{\text{TS}} \text{ implies } (\exists v_{1,B}^{\text{TS}} : v_B^{\text{TS}} \xrightarrow{TLTS}^{\mu} v_{1,B}^{\text{TS}} \wedge \forall n \in \mathbb{N}^{\geq 0} : (v_{1,A}, v_{1,B}) \in R_n)
\end{aligned}$$

holds. Obviously, a pair  $(v_A^{\text{TS}}, v_B^{\text{TS}})$  is element of  $\lim_{n \rightarrow \infty} R_n$  if and only if a transition  $v_A^{\text{TS}} \xrightarrow{TLTS}^{\mu} v_{1,A}^{\text{TS}}$  implies the existence of a transition  $v_B^{\text{TS}} \xrightarrow{TLTS}^{\mu} v_{1,B}^{\text{TS}}$  with  $(v_{1,A}, v_{1,B}) \in (\lim_{n \rightarrow \infty} R_n)$ . Therefore,  $\lim_{n \rightarrow \infty} R_n$  is a Timed Simulation by Definition A.1.  $\square$

Now we can conclude that a Timed Simulation exists if and only if all Bounded Timed Simulations exist.

**Proposition G.3. ( $R$  exists iff all  $R_n$  exist)**

Assume two TA  $A$ ,  $B$ , and the corresponding TLTS  $A_{\text{TLTS}}$ ,  $B_{\text{TLTS}}$ . Let for all  $n \in \mathbb{N}^{\geq 0}$   $R_n \subseteq V_{\text{TS},A} \times V_{\text{TS},B}$  be Bounded Simulation Relations as defined in Definition G.1. There exists a Timed Simulation  $R$  with  $(v_A^{\text{TS}}, v_B^{\text{TS}}) \in R$  if and only if  $\forall n \in \mathbb{N}^{\geq 0} : (v_A^{\text{TS}}, v_B^{\text{TS}}) \in R_n$  holds.

**Proof:**

Since the right hand side implies the left hand side by Definition G.2 and Proposition G.2, we show that the left hand side implies the right hand side only. We prove this by induction in  $n$ .

**Hypothesis:**  $(v_A^{\text{TS}}, v_B^{\text{TS}}) \in R$  implies  $\forall n \in \mathbb{N}^{\geq 0} : (v_A^{\text{TS}}, v_B^{\text{TS}}) \in R_n$ .

**Base Case:**  $(v_A^{\text{TS}}, v_B^{\text{TS}}) \in R$  implies  $(v_A^{\text{TS}}, v_B^{\text{TS}}) \in R_0$ .

**Induction Step:** If  $(v_A^{\text{TS}}, v_B^{\text{TS}}) \in R$  implies  $(v_A^{\text{TS}}, v_B^{\text{TS}}) \in R_n$ , then  $(v_A^{\text{TS}}, v_B^{\text{TS}}) \in R$  implies  $(v_A^{\text{TS}}, v_B^{\text{TS}}) \in R_{n+1}$ .

Since  $(v_A^{\text{TS}}, v_B^{\text{TS}}) \in R_0$  always holds, the base case is obviously true. If  $(v_A^{\text{TS}}, v_B^{\text{TS}}) \in R$  holds then for each outgoing transition  $v_A^{\text{TS}} \xrightarrow[\text{TLTS}]{\mu} v_{1,A}^{\text{TS}}$  there exists a transition  $v_B^{\text{TS}} \xrightarrow[\text{TLTS}]{\mu} v_{1,B}^{\text{TS}}$  with  $(v_{1,A}^{\text{TS}}, v_{1,B}^{\text{TS}}) \in R$ . By the induction hypothesis,  $(v_{1,A}^{\text{TS}}, v_{1,B}^{\text{TS}}) \in R_n$  holds and  $(v_A^{\text{TS}}, v_B^{\text{TS}}) \in R_{n+1}$  is implied.  $\square$

Now we introduce the proposition to show.

#### Proposition G.4. (Bounded Simulation and Simulation)

Let  $A, B$  be two TA with TLTS  $A_{\text{TLTS}}, B_{\text{TLTS}}$ . Let  $v_A^{\text{TS}}$  be a state in  $A_{\text{TLTS}}$  and let  $v_B^{\text{TS}}$  be a state in  $B_{\text{TLTS}}$ . There exists a timed simulation  $R$  with  $(v_A^{\text{TS}}, v_B^{\text{TS}}) \in R$ , if and only if  $\forall n \in \mathbb{N}^{\geq 0} : v_A^{\text{TS}} \sqsubseteq_n v_B^{\text{TS}}$  holds.

**Proof:**

Trivially by the combination of Proposition G.1 and Proposition G.3.  $\square$

## H. Outgoing Transitions of Synchronized States

We show Proposition 3.3 here.

**Proof:**

Since the second part of the proposition can be shown analogously, we show only the first two statements regarding the outgoing transitions of  $v_A^{\text{TV}}$ . We denote  $v_A^{\text{TV}} = (l_A, u_A)$ ,  $v_{d,A}^{\text{TV}} = (l_A, u_{d,A})$ , and  $v_{\sigma,A}^{\text{TV}} = (l_{\sigma,A}, u_{\sigma,A})$ . Since  $v_A^{\text{TV}}$  is AB-synchronized,

$$\forall j \in [0, |C_A| - 1] : u_A(C_A[j]) = u_A(\chi_j)$$

holds. We distinguish the statements:

1.  $v_A^{\text{TV}} \xrightarrow[\text{TSVC}]{d} v_{d,A}^{\text{TV}}$  with  $d \in \mathbb{T}$ . In this case, we have to show that  $v_{d,A}^{\text{TV}}$  is AB-synchronized. By Definition 3.3 and 2.3,  $u_{d,A} = u_A + d$  holds. Therefore,

$$\begin{aligned} \forall j \in [0, |C_A| - 1] : u_{d,A}(C_A[j]) &= u_A(C_A[j]) + d \\ &= u_A(\chi_j) + d \\ &= u_{d,A}(\chi_j) \end{aligned}$$

and

$$\forall j \in [0, |C_A| - 1] : u_{d,A}(C_A[j]) = u_{d,A}(\chi_j)$$

is implied. Therefore, the proposition holds in this case.

2.  $v_A^{\text{TV}} \xrightarrow{TSVC} v_{\sigma,A}^{\text{TV}}$  with  $\sigma \in \Sigma$ . In this case, we have to show that  $v_{\sigma,A}^{\text{TV}}$  is AB-semi-synchronized.

By Definition 3.3 and 2.3 there exists a transition  $l_A \xrightarrow{TA} l_{\sigma,A}$  and  $u_{\sigma,A} = [R_A \rightarrow 0]u_A$  holds. Since  $R_A \subseteq C_A$  and  $\forall j \in \mathbb{N}^{\geq 0} : \chi_j \notin C_A$ , the values of the virtual clocks remain unchanged. Therefore,

$$\begin{aligned} \forall j \in [0, |C_A| - 1] : u_{\sigma,A}(C_A[j]) &= \begin{cases} 0, & \text{if } C_A[j] \in R_A, \\ u_A(C_A[j]), & \text{else,} \end{cases} \\ &= \begin{cases} 0, & \text{if } C_A[j] \in R_A, \\ u_A(\chi_j), & \text{else,} \end{cases} \\ &= \begin{cases} 0, & \text{if } C_A[j] \in R_A, \\ u_{\sigma,A}(\chi_j), & \text{else.} \end{cases} \end{aligned}$$

Therefore, the value of an original clock is either zero or equal to the value of the corresponding virtual clock. We can follow that

$$\forall j \in [0, |C_A| - 1] : (u_{\sigma,A}(C_A[j]) = u_{\sigma,A}(\chi_j) \vee u_{\sigma,A}(C_A[j]) = 0)$$

holds and the proposition holds in this case, too. □

## I. Properties of sync for states

We show Proposition 3.4 here.

### Proof:

Since  $(l_A, u_{e,A})$  is obviously a state of  $A_{\text{TSVC}}$  and  $(l_B, u_{e,B})$  is obviously a state of  $B_{\text{TSVC}}$ , Proposition 3.4 consists of two individual statements to show. We first show that both states are AB-synchronized, and afterwards we show that the values of the virtual clocks of  $u_{e,A}$  and  $u_{e,B}$  are the same.

By Definition 3.5

$$\text{virt-A}(u_{e,A})(\chi_i) = \begin{cases} u_A(\chi_i), & \text{if } u_A(C_A[i]) \neq 0, \\ 0, & \text{else,} \end{cases}$$

holds. Since we assumed  $(l_A, u_A)$  to be an AB-semi-synchronized state,

$$\forall i \in [0, |C_A| - 1] : (u_A(C_A[i]) = u_A(\chi_i) \vee u_A(C_A[i]) = 0)$$

holds. Therefore, we can follow

$$\text{virt-A}(u_{e,A})(\chi_i) = \begin{cases} u_A(C_A[i]), & \text{if } u_A(C_A[i]) \neq 0, \\ 0, & \text{else.} \end{cases}$$



Using  $\text{orig}(u_{e,A}) = \text{orig}(u_A)$  (Def. 3.5) we know

$$\text{virt-A}(u_{e,A})(\chi_i) = \begin{cases} u_{e,A}(C_A[i]), & \text{if } u_{e,A}(C_A[i]) \neq 0, \\ 0, & \text{else.} \end{cases}$$

Therefore, either  $u_{e,A}(C_A[i]) \neq 0$ , which implies  $u_{e,A}(\chi_i) = u_{e,A}(C_A[i])$ , or  $u_{e,A}(C_A[i]) = 0$ , which implies  $u_{e,A}(\chi_i) = 0 = u_{e,A}(C_A[i])$ , holds. Therefore,

$$\forall i \in [0, |C_A| - 1] : u_{e,A}(C_A[i]) = u_{e,A}(\chi_i)$$

holds and  $(l_A, u_{e,A})$  is AB-synchronized. Analogously, we can show that  $(l_B, u_{e,B})$  is AB-synchronized.

Now we show that the virtual clock values of  $u_{e,A}$  and  $u_{e,B}$  are the same. We only show  $\text{virt-A}(u_{e,A}) = \text{virt-A}(u_{e,B})$ , since  $\text{virt-B}(u_{e,A}) = \text{virt-B}(u_{e,B})$  can be shown analogously.

In the proposition,  $\text{virt}(u_A) = \text{virt}(u_B)$  is assumed. For any  $i \in [0, |C_A| - 1]$ , we distinguish two cases:

1.  $u_A(C_A[i]) \neq 0$ . In this case,

$$\begin{aligned} u_{e,A}(\chi_i) &= u_A(\chi_i) \text{ (Def. 3.5)} \\ &= u_B(\chi_i) \text{ (due to } \text{virt}(u_A) = \text{virt}(u_B)) \\ &= u_{e,B}(\chi_i) \text{ (Def. 3.5).} \end{aligned}$$

2.  $u_A(C_A[i]) = 0$ . In this case,

$$\begin{aligned} u_{e,A}(\chi_i) &= 0 \text{ (Def. 3.5)} \\ &= u_{e,B}(\chi_i) \text{ (Def. 3.5).} \end{aligned}$$

Therefore, for any  $i \in [0, |C_A| - 1] : u_{e,A}(\chi_i) = u_{e,B}(\chi_i)$  holds, which is equivalent to  $\text{virt-A}(u_{e,A}) = \text{virt-A}(u_{e,B})$ . Since  $\text{virt-B}(u_{e,A}) = \text{virt-B}(u_{e,B})$  can be shown analogously, Proposition 3.4 holds.  $\square$

## J. sync on synchronized States

We show Proposition 3.5 here.

### Proof:

We denote

$$((l_A, u_{e,A}), (l_B, u_{e,B})) = \text{sync}(v_A^{\text{TV}}, v_B^{\text{TV}}),$$

$v_A^{\text{TV}} = (l_A, u_A)$ , and  $v_B^{\text{TV}} = (l_B, u_B)$ . Since the locations do not change by Definition 3.5, we only have to show that  $u_A = u_{e,A}$  and  $u_B = u_{e,B}$  holds. Since  $u_B = u_{e,B}$  can be shown analogously to  $u_A = u_{e,A}$ , we show only  $u_A = u_{e,A}$ .

Since  $\text{orig}(u_A) = \text{orig}(u_{e,A})$  holds trivially by Definition 3.5, we show  $\text{virt}(u_A) = \text{virt}(u_{e,A})$  only.

$\text{virt}(u_A) = \text{virt}(u_{e,A})$  holds if and only if  $\text{virt-A}(u_A) = \text{virt-A}(u_{e,A})$  and  $\text{virt-B}(u_A) = \text{virt-B}(u_{e,A})$  hold. Since both statements can be shown analogously, we show only  $\text{virt-A}(u_A) = \text{virt-A}(u_{e,A})$ .

Since we assume  $v_A^{\text{TV}}$  to be AB-synchronized,

$$\forall i \in [0, |C_A| - 1] : u_A(C_A[i]) = u_A(\chi_i)$$

holds by Definition 3.4. By Definition 3.5 for any  $i \in [0, |C_A| - 1]$

$$\begin{aligned} \text{virt-A}(u_{e,A})(\chi_i) &= \begin{cases} u_A(\chi_i), & \text{if } u_A(C_A[i]) \neq 0, \\ 0, & \text{else,} \end{cases} \\ &= \begin{cases} u_A(\chi_i), & \text{if } u_A(\chi_i) \neq 0, \\ 0, & \text{else.} \end{cases} \end{aligned}$$

Therefore, if  $u_A(\chi_i) \neq 0$ , then  $u_{e,A}(\chi_i) = u_A(\chi_i)$  and if  $u_A(\chi_i) = 0$ , then  $u_{e,A}(\chi_i) = 0 = u_A(\chi_i)$ . This implies  $\text{virt-A}(u_A) = \text{virt-A}(u_{e,A})$  and Proposition 3.5 holds.  $\square$

## K. Timed (Bi-)Simulation using TSVC

We show Theorem 3.1 here. Since the theorem for timed bisimulation can be shown analogously to the theorem for timed simulation, we show the theorem for timed simulation only. We start with the definition of timed simulation using TSVC.

### Definition K.1. (Timed Simulation using TSVC)

Assume two TA  $A, B$  with TSVC  $A_{\text{TSVC}}$  of  $A$  regarding  $B$  and TSVC  $B_{\text{TSVC}}$  of  $B$  regarding  $A$  using the same alphabet  $\Sigma$ . Let  $v_A^{\text{TV}} = (l_A, u_A)$  be an AB-semi-synchronized state of  $A_{\text{TSVC}}$  and let  $v_B^{\text{TV}} = (l_B, u_B)$  be an AB-semi-synchronized state of  $B_{\text{TSVC}}$ .

We define that  $v_A^{\text{TV}}$  is virtually simulated in order zero by  $v_B^{\text{TV}}$ , denoted  $v_A^{\text{TV}} \sqsubseteq_0 v_B^{\text{TV}}$ , if and only if  $\text{virt}(u_A) = \text{virt}(u_B)$  holds.

We define  $v_A^{\text{TV}}$  to be virtually simulated in order  $n+1$  by  $v_B^{\text{TV}}$ , denoted  $v_A^{\text{TV}} \sqsubseteq_{n+1} v_B^{\text{TV}}$ , if and only if  $\text{virt}(u_A) = \text{virt}(u_B)$  and for the AB-synchronized states

$$(v_{e,A}^{\text{TV}}, v_{e,B}^{\text{TV}}) = \text{sync}(v_A^{\text{TV}}, v_B^{\text{TV}})$$

the existence of a transition  $v_{e,A}^{\text{TV}} \xrightarrow[\text{TSVC}]{\mu} v_{\mu,e,A}^{\text{TV}}$  implies the existence of a transition  $v_{e,B}^{\text{TV}} \xrightarrow[\text{TSVC}]{\mu} v_{\mu,e,B}^{\text{TV}}$  with  $v_{\mu,e,A}^{\text{TV}} \sqsubseteq_n v_{\mu,e,B}^{\text{TV}}$ .

$A_{\text{TSVC}}$  is virtually simulated in order  $n$  by  $B_{\text{TSVC}}$ , denoted  $A_{\text{TSVC}} \sqsubseteq_n B_{\text{TSVC}}$ , if and only if  $v_{0,A}^{\text{TV}} \sqsubseteq_n v_{0,B}^{\text{TV}}$  holds.  $A_{\text{TSVC}}$  is virtually simulated by  $B_{\text{TSVC}}$ , denoted  $A_{\text{TSVC}} \sqsubseteq B_{\text{TSVC}}$ , if and only if  $\forall n \in \mathbb{N}^{\geq 0} : A_{\text{TSVC}} \sqsubseteq_n B_{\text{TSVC}}$  holds.

The following theorem shows that timed simulation using TSVC is correct. Since the proof for timed simulation using TSVC is analogous to the proof of Theorem 3.1 we prove correctness of the following theorem, only, and skip the proof for Theorem 3.1.

**Theorem K.1. (Timed Simulation using TSVC is correct.)**

Let  $A_{\text{TSVC}}$  be the TSVC of TA  $A$  regarding  $B$ ,  $B_{\text{TSVC}}$  be the TSVC of TA  $B$  regarding  $A$ .  $A \sqsubseteq_n B$  holds if and only if  $A_{\text{TSVC}} \sqsubseteq_n B_{\text{TSVC}}$  holds.  $A \sqsubseteq B$  is equivalent to  $A_{\text{TSVC}} \sqsubseteq B_{\text{TSVC}}$ .

**Proof:**

To show this theorem, we have to show that for the initial states  $v_{0,A}^{\text{TS}}$  of the TLTS  $A_{\text{TLTS}}$  of  $A$  and  $v_{0,B}^{\text{TS}}$  of the TLTS  $B_{\text{TLTS}}$  of  $B$  the statement  $v_{0,A}^{\text{TS}} \sqsubseteq_n v_{0,B}^{\text{TS}}$  holds if and only if for the initial states  $v_{0,A}^{\text{TV}}$  of TSVC  $A_{\text{TSVC}}$  of  $A$  regarding  $B$  and  $v_{0,B}^{\text{TV}}$  of TSVC  $B_{\text{TSVC}}$  of  $B$  regarding  $A$  the statement  $v_{0,A}^{\text{TV}} \sqsubseteq_n v_{0,B}^{\text{TV}}$  holds.

To do so, we first assume any states  $(l_A, u_{A,\text{TS}})$  of  $A_{\text{TLTS}}$ ,  $(l_B, u_{B,\text{TS}})$  of  $B_{\text{TLTS}}$ ,  $(l_A, u_{A,\text{TV}})$  of  $A_{\text{TSVC}}$ , and  $(l_B, u_{B,\text{TV}})$  of  $B_{\text{TSVC}}$ . We show that if certain conditions are fulfilled, then  $(l_A, u_{A,\text{TS}}) \sqsubseteq_n (l_B, u_{B,\text{TS}})$  implies  $(l_A, u_{A,\text{TV}}) \sqsubseteq_n (l_B, u_{B,\text{TV}})$  and afterwards the opposite direction. We show both directions by induction in  $n$ .

**Hypothesis:** If  $(l_A, u_{A,\text{TV}})$ ,  $(l_B, u_{B,\text{TV}})$  are AB-semi-synchronized,  $u_{A,\text{TS}} = \text{orig}(u_{A,\text{TV}})$ ,  $u_{B,\text{TS}} = \text{orig}(u_{B,\text{TV}})$ , and  $\text{virt}(u_{A,\text{TV}}) = \text{virt}(u_{B,\text{TV}})$  hold, then  $(l_A, u_{A,\text{TS}}) \sqsubseteq_n (l_B, u_{B,\text{TS}})$  implies  $(l_A, u_{A,\text{TV}}) \sqsubseteq_n (l_B, u_{B,\text{TV}})$ .

**Base Case:** The hypothesis holds for  $n = 0$ .

**Induction Step:** If the hypothesis holds for  $n$ , then it also holds for  $n + 1$ .

Since  $\text{virt}(u_{A,\text{TV}}) = \text{virt}(u_{B,\text{TV}})$  implies  $(l_A, u_{A,\text{TV}}) \sqsubseteq_0 (l_B, u_{B,\text{TV}})$ , the base case is obviously a true statement.

Since the induction step can only be false if  $(l_A, u_{A,\text{TS}}) \sqsubseteq_{n+1} (l_B, u_{B,\text{TS}})$  is true, we assume this to be the case and ignore the case in which  $(l_A, u_{A,\text{TS}}) \sqsubseteq_{n+1} (l_B, u_{B,\text{TS}})$  is false. To prove the induction step, we need to show  $(l_A, u_{A,\text{TV}}) \sqsubseteq_{n+1} (l_B, u_{B,\text{TV}})$ . By Definition K.1 this is the case if and only if for the AB-synchronized states

$$((l_A, u_{e,A}), (l_B, u_{e,B})) = \text{sync}((l_A, u_{A,\text{TV}}), (l_B, u_{B,\text{TV}}))$$

the existence of a transition  $(l_A, u_{e,A}) \xrightarrow{\mu}_{\text{TSVC}} (l_{\mu,A}, u_{\mu,A,\text{TV}})$  implies the existence of a transition  $(l_B, u_{e,B}) \xrightarrow{\mu}_{\text{TSVC}} (l_{\mu,B}, u_{\mu,B,\text{TV}})$  with  $(l_{\mu,A}, u_{\mu,A,\text{TV}}) \sqsubseteq_n (l_{\mu,B}, u_{\mu,B,\text{TV}})$ . By Proposition 3.3, we know that  $(l_{\mu,A}, u_{\mu,A,\text{TV}})$ ,  $(l_{\mu,B}, u_{\mu,B,\text{TV}})$  are both AB-semi-synchronized. We distinguish two cases here.

1.  $\mu \in \mathbb{T}$ . In this case,  $l_A = l_{\mu,A}$ ,  $u_{\mu,A,\text{TV}} = u_{e,A} + \mu$ , and  $u_{e,A} + \mu \models I(l_A)$  by Definition 3.3 and Definition 2.3. Due to  $u_{A,\text{TS}} = \text{orig}(u_{A,\text{TV}}) = \text{orig}(u_{e,A})$  and  $I(l_A) \in \mathcal{B}(C_A)$ ,  $u_{A,\text{TS}} + \mu \models I(l_A)$  also holds. This implies the existence of a transition  $(l_A, u_{A,\text{TS}}) \xrightarrow{\mu}_{\text{TLTS}} (l_A, u_{\mu,A,\text{TS}})$  by Definition 2.3. Obviously,

$$u_{\mu,A,\text{TS}} = u_{A,\text{TS}} + \mu = \text{orig}(u_{A,\text{TV}} + \mu) = \text{orig}(u_{\mu,A,\text{TV}}).$$

Due to  $(l_A, u_{A,TS}) \sqsubseteq_{n+1} (l_B, u_{B,TS})$ , there exists a transition  $(l_B, u_{B,TS}) \xrightarrow{TLTS}^{\mu} (l_B, u_{\mu,B,TS})$  with  $(l_A, u_{\mu,A,TS}) \sqsubseteq_n (l_B, u_{\mu,B,TS})$  by Definition A.1. This implies  $u_{\mu,B,TS} \models I(l_B)$ . Due to  $u_{B,TS} = \text{orig}(u_{B,TV}) = \text{orig}(u_{e,B})$ ,  $I(l_B) \in \mathcal{B}(C_B)$ , and  $u_{\mu,B,TS} = u_{B,TS} + \mu$  by Definition 2.3, we know  $u_{e,B} + \mu \models I(l_B)$ . Therefore, there exists a transition  $(l_B, u_{e,B}) \xrightarrow{TSVC}^{\mu} (l_{\mu,B}, u_{\mu,B,TV})$  by Definition 3.3 and Definition 2.3 and, obviously,

$$\text{orig}(u_{\mu,B,TV}) = \text{orig}(u_{B,TV} + \mu) = u_{B,TS} + \mu = u_{\mu,B,TS}.$$

Moreover, we can show

$$\begin{aligned} \text{virt}(u_{\mu,B,TV}) &= \text{virt}(u_{e,B} + \mu) \\ &= \text{virt}(u_{e,A} + \mu) \text{ (Proposition 3.4)} \\ &= \text{virt}(u_{\mu,A,TV}). \end{aligned}$$

Therefore,  $(l_{\mu,A}, u_{\mu,A,TV})$ ,  $(l_{\mu,B}, u_{\mu,B,TV})$  are both AB-semi-synchronized,  $u_{\mu,A,TS} = \text{orig}(u_{\mu,A,TV})$ ,  $u_{\mu,B,TS} = \text{orig}(u_{\mu,B,TV})$ , and  $\text{virt}(u_{\mu,B,TV}) = \text{virt}(u_{\mu,A,TV})$  holds. Therefore, we can apply the induction hypothesis and since  $(l_A, u_{\mu,A,TS}) \sqsubseteq_n (l_B, u_{\mu,B,TS})$  holds,  $(l_{\mu,A}, u_{\mu,A,TV}) \sqsubseteq_n (l_{\mu,B}, u_{\mu,B,TV})$  is implied.

2.  $\mu \in \Sigma$ . In this case, there exists a transition  $l_A \xrightarrow{TA}^{g_A, \mu, R_A} l_{\mu,A}$  with  $u_{\mu,A,TV} = [R_A \rightarrow 0]u_{e,A}$ ,  $u_{e,A} \models g_A$ , and  $[R_A \rightarrow 0]u_{e,A} \models I(l_{\mu,A})$  by Definition 3.3 and Definition 2.3. Since  $\text{orig}(u_{e,A}) = u_{A,TS}$  and  $g_A, I(l_{\mu,A}) \in \mathcal{B}(C_A)$ , we also know  $u_{A,TS} \models g_A$ ,  $[R_A \rightarrow 0]u_{A,TS} \models I(l_{\mu,A})$  and, therefore, there exists a transition  $(l_A, u_{A,TS}) \xrightarrow{TLTS}^{\mu} (l_{\mu,A}, u_{\mu,A,TS})$  by Definition 2.3. Obviously,

$$\begin{aligned} u_{\mu,A,TS} &= [R_A \rightarrow 0]u_{A,TS} \\ &= [R_A \rightarrow 0]\text{orig}(u_{e,A}) \\ &= \text{orig}(u_{\mu,A,TV}). \end{aligned}$$

Due to  $(l_A, u_{A,TS}) \sqsubseteq_{n+1} (l_B, u_{B,TS})$ , there exists a transition  $(l_B, u_{B,TS}) \xrightarrow{TLTS}^{\mu} (l_{\mu,B}, u_{\mu,B,TS})$  with  $(l_{\mu,A}, u_{\mu,A,TS}) \sqsubseteq_n (l_{\mu,B}, u_{\mu,B,TS})$  by Definition 3.1. This implies  $u_{B,TS} \models g_B$ ,  $u_{\mu,B,TS} \models I(l_{\mu,B})$ ,  $u_{\mu,B,TS} = [R_B \rightarrow 0]u_{B,TS}$ , and the existence of a transition  $l_B \xrightarrow{TA}^{g_B, \mu, R_B} l_{\mu,B}$  by Definition 2.3. Due to  $u_{B,TS} = \text{orig}(u_{e,B})$  and  $g_B, I(l_B) \in \mathcal{B}(C_B)$ , we know  $u_{e,B} \models g_B$  and  $[R_B \rightarrow 0]u_{e,B} \models I(l_B)$ . Therefore, there exists a transition  $(l_B, u_{e,B}) \xrightarrow{TSVC}^{\mu} (l_{\mu,B}, u_{\mu,B,TV})$  by Definition 3.3 and, obviously,

$$\begin{aligned} u_{\mu,B,TS} &= [R_B \rightarrow 0]u_{B,TS} \\ &= [R_B \rightarrow 0]\text{orig}(u_{e,B}) \\ &= \text{orig}(u_{\mu,B,TV}). \end{aligned}$$

Since  $R_A \subseteq C_A$  and  $R_B \subseteq C_B$ , and no virtual clock is element of  $C_A$  or  $C_B$ , we can show

$$\begin{aligned} \text{virt}(u_{\mu,B,\text{TV}}) &= [R_B \rightarrow 0] \text{virt}(u_{B,\text{TV}}) = \text{virt}(u_{B,\text{TV}}) \\ &= \text{virt}(u_{A,\text{TV}}) = [R_A \rightarrow 0] \text{virt}(u_{A,\text{TV}}) \\ &= \text{virt}(u_{\mu,A,\text{TV}}). \end{aligned}$$

Therefore,  $(l_{\mu,A}, u_{\mu,A,\text{TV}}), (l_{\mu,B}, u_{\mu,B,\text{TV}})$  are both AB-semi-synchronized,  $u_{\mu,A,\text{TS}} = \text{orig}(u_{\mu,A,\text{TV}})$ ,  $u_{\mu,B,\text{TS}} = \text{orig}(u_{\mu,B,\text{TV}})$ , and  $\text{virt}(u_{\mu,B,\text{TV}}) = \text{virt}(u_{\mu,A,\text{TV}})$  hold. Therefore, we can apply the induction hypothesis and since  $(l_A, u_{\mu,A,\text{TS}}) \sqsubseteq_n (l_B, u_{\mu,B,\text{TS}})$  holds,  $(l_{\mu,A}, u_{\mu,A,\text{TV}}) \sqsubseteq_n (l_{\mu,B}, u_{\mu,B,\text{TV}})$  is implied.

Now we show the opposite direction, in which  $(l_A, u_{A,\text{TV}}) \sqsubseteq_n (l_B, u_{B,\text{TV}})$  implies  $(l_A, u_{A,\text{TS}}) \sqsubseteq_n (l_B, u_{B,\text{TS}})$ , if  $(l_A, u_{A,\text{TV}}), (l_B, u_{B,\text{TV}})$  are AB-semi-synchronized,  $u_{A,\text{TS}} = \text{orig}(u_{A,\text{TV}})$ ,  $u_{B,\text{TS}} = \text{orig}(u_{B,\text{TV}})$ , and  $\text{virt}(u_{A,\text{TV}}) = \text{virt}(u_{B,\text{TV}})$ .

**Hypothesis:**  $(l_A, u_{A,\text{TV}}) \sqsubseteq_n (l_B, u_{B,\text{TV}})$  implies  $(l_A, u_{A,\text{TS}}) \sqsubseteq_n (l_B, u_{B,\text{TS}})$ , if  $(l_A, u_{A,\text{TV}}), (l_B, u_{B,\text{TV}})$  are AB-semi-synchronized,  $u_{A,\text{TS}} = \text{orig}(u_{A,\text{TV}})$ ,  $u_{B,\text{TS}} = \text{orig}(u_{B,\text{TV}})$ , and  $\text{virt}(u_{A,\text{TV}}) = \text{virt}(u_{B,\text{TV}})$ .

**Base Case:** The hypothesis holds for  $n = 0$ .

**Induction Step:** If the induction step holds for  $n$ , it also holds for  $n + 1$ .

Since  $(l_A, u_{A,\text{TS}}) \sqsubseteq_0 (l_B, u_{B,\text{TS}})$  always holds, the base case holds, too.

Since the induction step can only be false, if  $(l_A, u_{A,\text{TV}}) \sqsubseteq_{n+1} (l_B, u_{B,\text{TV}})$  is true, we assume this to be the case and ignore the case in which  $(l_A, u_{A,\text{TV}}) \sqsubseteq_{n+1} (l_B, u_{B,\text{TV}})$  is false. By Definition K.1, we know that for the AB-synchronized states

$$((l_A, u_{e,A}), (l_B, u_{e,B})) = \text{sync}((l_A, u_{A,\text{TV}}), (l_B, u_{B,\text{TV}}))$$

the existence of a transition  $v_{e,A}^{\text{TV}} \xrightarrow[\text{TSVC}]{\mu} v_{\mu,A}^{\text{TV}}$  implies the existence of a transition  $v_{e,B}^{\text{TV}} \xrightarrow[\text{TSVC}]{\mu} v_{\mu,B}^{\text{TV}}$  with  $v_{\mu,A}^{\text{TV}} \sqsubseteq_n v_{\mu,B}^{\text{TV}}$ .

To show the induction step, we need to show  $(l_A, u_{A,\text{TS}}) \sqsubseteq_{n+1} (l_B, u_{B,\text{TS}})$ . To do so, we need to show that the existence of an outgoing transition  $(l_A, u_{A,\text{TS}}) \xrightarrow[\text{TLTS}]{\mu} (l_{\mu,A}, u_{\mu,A,\text{TS}})$  implies the existence of an outgoing transition  $(l_B, u_{B,\text{TS}}) \xrightarrow[\text{TLTS}]{\mu} (l_{\mu,B}, u_{\mu,B,\text{TS}})$  with  $(l_{\mu,A}, u_{\mu,A,\text{TS}}) \sqsubseteq_n (l_{\mu,B}, u_{\mu,B,\text{TS}})$ . We distinguish two cases here:

1.  $\mu \in \mathbb{T}$ . In this case,  $l_A = l_{\mu,A}$ ,  $u_{\mu,A,\text{TS}} = u_{A,\text{TS}} + \mu$ , and  $u_{A,\text{TS}} + \mu \models I(l_A)$  by Definition 2.3. Due to  $u_{A,\text{TS}} = \text{orig}(u_{A,\text{TV}}) = \text{orig}(u_{e,A})$  and  $I(l_A) \in \mathcal{B}(C_A)$ ,  $u_{e,A} + \mu \models I(l_A)$  also holds. Therefore, there is a transition  $(l_A, u_{e,A}) \xrightarrow[\text{TSVC}]{\mu} (l_A, u_{\mu,A,\text{TV}})$  with  $u_{\mu,A,\text{TV}} = u_{e,A} + \mu$  by Definition 3.3 and

$$u_{\mu,A,\text{TS}} = u_{A,\text{TS}} + \mu = \text{orig}(u_{e,A}) + \mu = \text{orig}(u_{\mu,A,\text{TV}})$$

holds.

Since we assume  $(l_A, u_{A,TV}) \sqsubseteq_{n+1} (l_B, u_{B,TV})$ , there exists a transition  $(l_B, u_{e,B}) \xrightarrow{TSVC}^{\mu} (l_B, u_{\mu,B,TV})$  with  $(l_A, u_{\mu,A,TV}) \sqsubseteq_n (l_B, u_{\mu,B,TV})$  by Definition K.1. By Definition 3.3, this implies  $u_{\mu,B,TV} = u_{e,B} + \mu$  and  $u_{\mu,B,TV} \models I(l_B)$ . Due to  $u_{B,TS} = \text{orig}(u_{B,TV}) = \text{orig}(u_{e,B})$  and  $I(l_B) \in \mathcal{B}(C_B)$ ,  $u_{B,TS} + \mu \models I(l_B)$  and, therefore, there exists a transition  $(l_B, u_{B,TS}) \xrightarrow{TLTS}^{\mu} (l_B, u_{\mu,B,TS})$  with  $u_{\mu,B,TS} = u_{B,TS} + \mu$  by Definition 2.3. We can show

$$u_{\mu,B,TS} = u_{B,TS} + \mu = \text{orig}(u_{B,TV}) + \mu = \text{orig}(u_{\mu,B,TV}).$$

Since  $(l_A, u_{\mu,A,TV})$ ,  $(l_B, u_{\mu,B,TV})$  are AB-semi-synchronized by Proposition 3.3,  $u_{\mu,A,TS} = \text{orig}(u_{\mu,A,TV})$ ,  $u_{\mu,B,TS} = \text{orig}(u_{\mu,B,TV})$ , and

$$\begin{aligned} \text{virt}(u_{\mu,A,TV}) &= \text{virt}(u_{e,A}) + \mu \\ &= \text{virt}(u_{e,B}) + \mu \\ &= \text{virt}(u_{\mu,B,TV}) \end{aligned}$$

hold, we can apply the induction hypothesis and since  $(l_A, u_{\mu,A,TV}) \sqsubseteq_n (l_B, u_{\mu,B,TV})$  holds,  $(l_A, u_{\mu,A,TS}) \sqsubseteq_n (l_B, u_{\mu,B,TS})$  is implied and the induction step holds in this case.

2.  $\mu \in \Sigma$ . In this case, there exists a transition  $l_A \xrightarrow{TA}^{g_A, \mu, R_A} l_{\mu,A}$  with  $u_{\mu,A,TS} = [R_A \rightarrow 0]u_{A,TS}$ ,  $u_{A,TS} \models g_A$ , and  $u_{\mu,A,TS} \models I(l_{\mu,A})$  by Definition 2.3. Due to  $u_{A,TS} = \text{orig}(u_{A,TV}) = \text{orig}(u_{e,A})$  and  $I(l_A) \in \mathcal{B}(C_A)$ ,  $u_{e,A} \models g_A$  and  $[R_A \rightarrow 0]u_{e,A} \models I(l_A)$  also hold. Therefore, there exists a transition  $(l_A, u_{e,A}) \xrightarrow{TSVC}^{\mu} (l_A, u_{\mu,A,TV})$  with  $u_{\mu,A,TV} = [R_A \rightarrow 0]u_{e,A}$  by Definition 3.3 and

$$u_{\mu,A,TS} = [R_A \rightarrow 0]u_{A,TS} = [R_A \rightarrow 0]\text{orig}(u_{e,A}) = \text{orig}(u_{\mu,A,TV})$$

holds. Since we assume  $(l_A, u_{A,TV}) \sqsubseteq_{n+1} (l_B, u_{B,TV})$  to hold, there exists a transition  $(l_B, u_{e,B}) \xrightarrow{TSVC}^{\mu} (l_B, u_{\mu,B,TV})$  with  $(l_A, u_{\mu,A,TV}) \sqsubseteq_n (l_B, u_{\mu,B,TV})$  by Definition K.1. By Definition 3.3, this implies the existence of a transition  $l_B \xrightarrow{TA}^{g_B, \mu, R_B} l_{\mu,B}$ ,  $u_{\mu,B,TV} = [R_B \rightarrow 0]u_{e,B}$ ,  $u_{e,B} \models g_B$ , and  $u_{\mu,B,TV} \models I(l_B)$ . Due to  $u_{B,TS} = \text{orig}(u_{B,TV})$  and  $g_B, I(l_B) \in \mathcal{B}(C_B)$ ,  $u_{B,TS} \models g_B$ ,  $[R_B \rightarrow 0]u_{B,TS} \models I(l_B)$  hold and, therefore, there exists a transition  $(l_B, u_{B,TS}) \xrightarrow{TLTS}^{\mu} (l_{\mu,B}, u_{\mu,B,TS})$  with  $u_{\mu,B,TS} = [R_B \rightarrow 0]u_{B,TS}$  by Definition 2.3. We can show

$$u_{\mu,B,TS} = [R_B \rightarrow 0]u_{B,TS} = [R_B \rightarrow 0]\text{orig}(u_{e,B}) = \text{orig}(u_{\mu,B,TV}).$$

Since  $(l_{\mu,A}, u_{\mu,A,TV})$ ,  $(l_{\mu,B}, u_{\mu,B,TV})$  are AB-semi-synchronized by Proposition 3.3,  $u_{\mu,A,TS} = \text{orig}(u_{\mu,A,TV})$ ,  $u_{\mu,B,TS} = \text{orig}(u_{\mu,B,TV})$ , and

$$\begin{aligned} \text{virt}(u_{\mu,A,TV}) &= \text{virt}([R_A \rightarrow 0]u_{e,A}) = \text{virt}(u_{e,A}) \quad (R_A \subseteq C_A \text{ and no virtual clock in } C_A) \\ &= \text{virt}(u_{e,B}) = \text{virt}([R_B \rightarrow 0]u_{e,B}) \quad (R_B \subseteq C_B \text{ and no virtual clock in } C_B) \\ &= \text{virt}(u_{\mu,B,TV}) \end{aligned}$$

hold, we can apply the induction hypothesis and since  $(l_A, u_{\mu,A,TV}) \sqsubseteq_n (l_B, u_{\mu,B,TV})$  holds,  $(l_{\mu,A}, u_{\mu,A,TS}) \sqsubseteq_n (l_{\mu,B}, u_{\mu,B,TS})$  is implied and the induction step holds in this case, too.

Therefore, if  $(l_A, u_{A,TV}), (l_B, u_{B,TV})$  are AB-semi-synchronized,  $\text{orig}(u_{A,TV}) = u_{A,TS}$ ,  $\text{orig}(u_{B,TV}) = u_{B,TS}$ , and  $\text{virt}(u_{A,TV}) = \text{virt}(u_{B,TV})$  hold, then  $(l_A, u_{A,TV}) \sqsubseteq_n (l_B, u_{B,TV})$  holds if and only if  $(l_A, u_{A,TS}) \sqsubseteq_n (l_B, u_{B,TS})$  holds. For the initial states of TSVC and TLTS, the previous condition obviously holds, since the values of all clocks are set to zero. Therefore,

$$\begin{aligned} A &\sqsubseteq_n B \\ \Leftrightarrow A_{\text{TLTS}} &\sqsubseteq_n B_{\text{TLTS}} \text{ (Definition K.1)} \\ \Leftrightarrow v_{0,A}^{\text{TS}} &\sqsubseteq_n v_{0,B}^{\text{TS}} \text{ (Definition 3.1)} \\ \Leftrightarrow v_{0,A}^{\text{TV}} &\sqsubseteq_n v_{0,B}^{\text{TV}} \text{ (shown previously)} \\ \Leftrightarrow A_{\text{TSVC}} &\sqsubseteq_n B_{\text{TSVC}} \text{ (Definition K.1)} \end{aligned}$$

holds. Since

$$\begin{aligned} A &\sqsubseteq B \\ \Leftrightarrow \forall n \in \mathbb{N}^{\geq 0} : A &\sqsubseteq_n B \text{ (Definition 3.1)} \\ \Leftrightarrow \forall n \in \mathbb{N}^{\geq 0} : A_{\text{TSVC}} &\sqsubseteq_n B_{\text{TSVC}} \\ \Leftrightarrow A_{\text{TSVC}} &\sqsubseteq B_{\text{TSVC}} \text{ (Definition K.1)} \end{aligned}$$

also holds, Theorem K.1 is shown and Theorem 3.1 can be shown analogously.  $\square$

## L. Backward Stability

We prove Proposition 3.6 here.

### Proof:

First, we show backward stability for transitions labeled with  $\varepsilon$ , then we prove backward stability for transitions labeled with  $\sigma \in \Sigma$ .

For a transition  $(l_1, D_1) \xrightarrow[VCG]{\varepsilon} (l_1, D_2)$ ,

$$\begin{aligned} D_2 &= D_1^\uparrow \wedge I(l_1) \\ &= \{u_2 \mid \exists u_1 \in D_1 : \exists d \in \mathbb{T}(C) : u_2 = u_1 + d \wedge u_2 \models I(l_1)\} \end{aligned}$$

holds by Definition 3.7. Thus, for all  $u_2 \in D_2$  exists a  $u_1 \in D_1$  with  $d \in \mathbb{T}$ ,  $u_2 = u_1 + d$ , and  $u_2 \models I(l_1)$ . Therefore, there exists a transition  $(l_1, u_1) \xrightarrow[TSVC]{d} (l_1, u_2)$  by Definition 3.3 and the proposition holds for transitions labeled with  $\varepsilon$ .

If there exists a transition  $(l_1, D_1) \xrightarrow[VCG]{\sigma} (l_2, D_2)$ , then there exists a transition  $l_1 \xrightarrow[TA]{g, \sigma, R} l_2$  and

$$\begin{aligned} D_2 &= R(D_1 \wedge g) \wedge I(l_2) \\ &= \{u_2 \mid \exists u_1 \in D_1 : u_1 \models g \wedge u_2 = [R \rightarrow 0]u_1 \wedge u_2 \models I(l_2)\} \end{aligned}$$

holds by Definition 3.7. Thus, for all  $u_2 \in D_2$  exists an  $u_1 \in D_1$  with  $u_1 \models g$ ,  $u_2 = [R \rightarrow 0]u_1$ , and  $u_2 \models I(l_2)$ . A transition  $(l_1, u_1) \xrightarrow[TSVC]{\sigma} (l_2, u_2)$  exists by Definition 3.3 and the proposition also holds for transitions labeled with  $\sigma \in \Sigma$ .  $\square$

## M. Forward Stability

Now we show forward stability (Proposition 3.7).

### Proof:

We first show forward stability for transitions labeled with  $d \in \mathbb{T}$  and afterwards we show forward stability for transitions labeled with  $\sigma \in \Sigma$ .

If there is a transition  $(l_1, u_1) \xrightarrow{TSVC}^d (l_1, u_2)$  then  $u_2 = u_1 + d$ , and  $u_2 \models I(l_1)$  by Definition 3.3.

In VCGs, each symbolic state has an outgoing  $\varepsilon$ -transition  $(l_1, D_1) \xrightarrow{VCG}^\varepsilon (l_1, D_2)$ . By Definition 3.7,

$$\begin{aligned} D_2 &= D_1^\uparrow \wedge I(l_1) \\ &= \{u_2 \mid \exists u_1 \in D_1 : \exists d \in \mathbb{T} : u_2 = u_1 + d \wedge u_2 \models I(l_1)\}. \end{aligned}$$

Since,  $u_1 \in D_1$ ,  $u_2 = u_1 + d$ , and  $u_2 \models I(l_1)$  holds,  $u_2 \in D_2$  holds and, therefore, the proposition holds for transitions labeled with  $d \in \mathbb{T}$ .

If there is a transition  $(l_1, u_1) \xrightarrow{TSVC}^\sigma (l_2, u_2)$  with  $\sigma \in \Sigma$ , then there exists a transition  $l_1 \xrightarrow{TA}^{g, \sigma, R} l_2$  and  $u_1 \models g$ ,  $u_2 = [R \rightarrow 0]u_1$ , and  $u_2 \models I(l_2)$  by Definition 3.3. For any symbolic state  $(l_1, D_1)$  with  $v_1^{\text{TV}} \in (l_1, D_1)$ , we know that there exists a transition  $(l_1, D_1) \xrightarrow{VCG}^\sigma (l_2, R(D_1 \wedge g) \wedge I(l_2))$  if  $D_2 = R(D_1 \wedge g) \wedge I(l_2)$  is not empty by Definition 3.7. We know that

$$\begin{aligned} D_2 &= R(D \wedge g) \wedge I(l_2) \\ &= \{u_2 \mid \exists u_1 \in D_1 : u_2 = [R \rightarrow 0]u_1 \wedge u_1 \models g \wedge u_2 \models I(l_2)\} \end{aligned}$$

Obviously,  $u_2 \in D_2$  and  $D_2$  is not empty. Therefore, the proposition also holds for transitions labeled with  $\sigma \in \Sigma$ .  $\square$

## N. Outgoing Transitions of Synchronized Symbolic States

We show Proposition 3.8 here.

### Proof:

Since the second part can be shown analogously to the first, we show only the first part regarding the outgoing transitions of  $v_A^{\text{VC}}$ . We denote  $v_A^{\text{VC}} = (l_A, D_A)$ ,  $v_{\varepsilon, A}^{\text{VC}} = (l_A, D_{\varepsilon, A})$ , and  $v_{\sigma, A}^{\text{VC}} = (l_{\sigma, A}, D_{\sigma, A})$ . Since  $v_A^{\text{VC}}$  is AB-synchronized,

$$\forall i \in [0, |C_A| - 1] : \forall u_A \in D_A : u_A(C_A[i]) = u_A(\chi_i)$$

holds. We distinguish the two statements:

1.  $v_A^{\text{VC}} \xrightarrow{VCG}^\varepsilon v_{\varepsilon, A}^{\text{VC}}$ . In this case, we have to show that  $v_{\varepsilon, A}^{\text{VC}}$  is AB-synchronized. Due to backward stability (Proposition 3.6), for any  $u_{d, A} \in D_{\varepsilon, A}$  exists a  $u_A \in D_A$ , such that

$$\exists d \in \mathbb{T} : (l_A, u_A) \xrightarrow{TSVC}^d (l_A, u_{d, A})$$



holds. We can follow

$$\begin{aligned} \forall i \in [0, |C_A| - 1] : \forall u_{d,A} \in D_{\varepsilon,A} : \exists u_A \in D_A : \exists d \in \mathbb{T} : & u_{d,A}(C_A[i]) = u_A(C_A[i]) + d \\ & = u_A(\chi_i) + d \\ & = u_{\varepsilon,A}(\chi_i). \end{aligned}$$

Therefore,  $v_{\varepsilon,A}^{\text{VC}}$  is AB-synchronized and the proposition holds in this case.

2.  $v_A^{\text{VC}} \xrightarrow[VCG]{\sigma} v_{\sigma,A}^{\text{VC}}$ . In this case, we have to show that  $v_{\sigma,A}^{\text{VC}}$  is AB-semi-synchronized. Due to backward stability (Proposition 3.6), for any  $u_{\sigma,A} \in D_{\sigma,A}$  exists a  $u_A \in D_A$ , such that a transition  $(l_A, u_A) \xrightarrow[TSVC]{\sigma} (l_{\sigma,A}, u_{\sigma,A})$  exists. By Definition 3.3 and Definition 2.3, this implies the existence of a transition  $l_A \xrightarrow[TA]{g,\mu,R} l_{\mu,A}$  with  $u_{\sigma,A} = [R \rightarrow 0]u_A$ . Since  $v_A^{\text{VC}}$  is AB-synchronized, we know

$$\forall i \in [0, |C_A| - 1] : \forall u_A \in D_A : u_A(C_A[i]) = u_A(\chi_i).$$

We can follow

$$\begin{aligned} \forall i \in [0, |C_A| - 1] : \forall u_{\sigma,A} \in D_{\sigma,A} : \exists u_A \in D_A : u_{\sigma,A}(C_A[i]) &= \begin{cases} 0, & \text{if } C_A[i] \in R, \\ u_A(C_A[i]), & \text{else} \end{cases} \\ &= \begin{cases} 0, & \text{if } C_A[i] \in R, \\ u_A(\chi_i), & \text{else} \end{cases} \\ &= \begin{cases} 0, & \text{if } C_A[i] \in R, \\ u_{\sigma,A}(\chi_i), & \text{else} \end{cases} \end{aligned}$$

and, therefore,

$$\begin{aligned} \forall i \in [0, |C_A| - 1] : ( & (\forall u_{\sigma,A} \in D_{\sigma,A} : u_{\sigma,A}(C_A[i]) = u_{\sigma,A}(\chi_i)) \\ & \vee (\forall u_{\sigma,A} \in D_{\sigma,A} : u_{\sigma,A}(C_A[i]) = 0)). \end{aligned}$$

This implies that  $v_{\sigma,A}^{\text{VC}}$  is AB-semi-synchronized by Definition 3.8. Therefore, Proposition 3.8 holds in this case, too.  $\square$

## O. Virtual Inclusion of Zones using DBMs

The basic idea to solve the virtual inclusion problem for zones is to reduce the problem to an inclusion problem for DBMs, which can efficiently be solved by the well-known *relation* algorithm [21]. We first define a function, which removes all non-virtual clocks from the DBM.

**Definition O.1. (extract-virtual function)**

Given a set of clocks  $C$ , the  $\text{extract-virtual} : \mathcal{M}(C \cup \{\chi_0, \dots, \chi_{i-1}\}) \rightarrow \mathcal{M}(\{\chi_0, \dots, \chi_{i-1}\})$  function extracts the submatrix of a DBM, which belongs to the virtual clocks. It is defined as follows:

$$\begin{aligned} \text{extract-virtual} & \left( \begin{array}{ccc} (z_{0,0}, \preceq_{0,0}) & \cdots & (z_{0,|C|+i}, \preceq_{0,|C|+i}) \\ \vdots & \ddots & \vdots \\ (z_{|C|+i,0}, \preceq_{|C|+i,0}) & \cdots & (z_{|C|+i,|C|+i}, \preceq_{|C|+i,|C|+i}) \end{array} \right) \\ = & \left( \begin{array}{cccc} (z_{0,0}, \preceq_{0,0}) & (z_{0,|C|+1}, \preceq_{0,|C|+1}) & \cdots & (z_{0,|C|+i}, \preceq_{0,|C|+i}) \\ (z_{|C|+1,0}, \preceq_{|C|+1,0}) & (z_{|C|+1,|C|+1}, \preceq_{|C|+1,|C|+1}) & \cdots & (z_{|C|+1,|C|+i}, \preceq_{|C|+1,|C|+i}) \\ \vdots & \vdots & \ddots & \vdots \\ (z_{|C|+i,0}, \preceq_{|C|+i,0}) & (z_{|C|+i,|C|+1}, \preceq_{|C|+i,|C|+1}) & \cdots & (z_{|C|+i,|C|+i}, \preceq_{|C|+i,|C|+i}) \end{array} \right) \end{aligned}$$

The result of the  $\text{extract-virtual}$  function creates a DBM  $M$ , with  $[M]$  being virtually equivalent to the original zone as the following proposition shows.

**Proposition O.1. (extract-virtual returns an virtually equivalent Zone)**

For a canonic DBM  $M \in \mathcal{M}(C \cup \{\chi_0, \dots, \chi_{i-1}\})$ , with  $[M]$  being a zone of an AB-semi-synchronized symbolic state of a VCG,  $[M] \leq_{\text{virtual}} [\text{extract-virtual}(M)]$  and  $[\text{extract-virtual}(M)] \leq_{\text{virtual}} [M]$  hold.

**Proof:**

We first show  $[M] \leq_{\text{virtual}} [\text{extract-virtual}(M)]$  and afterwards the opposite direction.

By Definition 3.9,

$$\begin{aligned} [M] & \leq_{\text{virtual}} [\text{extract-virtual}(M)] \\ \Leftrightarrow \forall u_1 \in [M] : \exists u_2 \in [\text{extract-virtual}(M)] : \text{virt}(u_1) &= \text{virt}(u_2) \\ \Leftrightarrow \forall u_1 \in [M] : \exists u_2 \in [\text{extract-virtual}(M)] : \forall j \in [1, i] : u_1(C[|C| + j]) &= u_2(c[|C| + j]). \end{aligned}$$

For any clock valuation  $u_1 \in [M]$ ,

$$\begin{aligned} u_1 & \models \bigwedge_{k,l \in [0, \dots, |C|+i]} C[k] - C[l] \preceq_{k,l} z_{k,l} \\ \text{implies } u_1 & \models \bigwedge_{k,l \in \{0\} \cup [C|+1, \dots, |C|+i]} C[k] - C[l] \preceq_{k,l} z_{k,l} \end{aligned}$$

holds. For the clock valuation  $u_2 \in [\{\chi_0, \dots, \chi_{i-1}\} \rightarrow \mathbb{T}]$  with  $\text{virt}(u_1) = \text{virt}(u_2)$ ,

$$\begin{aligned} u_2 & \models \bigwedge_{i,j \in \{0\} \cup [C|+1, \dots, |C|+i]} C[k] - C[l] \preceq_{k,l} z_{k,l} \\ \Leftrightarrow u_2 & \in [\text{extract-virtual}(M)] \end{aligned}$$

is implied. Therefore, for any clock valuation  $u_1 \in [M]$  exists a clock valuation  $u_2 \in [\text{extract-virtual}(M)]$  with  $\text{virt}(u_1) = \text{virt}(u_2)$  and  $[M] \leq_{\text{virtual}} [\text{extract-virtual}(M)]$  is shown.

By Definition 3.9,

$$\begin{aligned} & [\text{extract-virtual}(M)] \leq_{\text{virtual}} [M] \\ \Leftrightarrow & \forall u_1 \in [\text{extract-virtual}(M)] : \exists u_2 \in [M] : \text{virt}(u_1) = \text{virt}(u_2) \\ \Leftrightarrow & \forall u_1 \in [\text{extract-virtual}(M)] : \exists u_2 \in [M] : \forall j \in [1, i] : u_1(C[|C| + j]) = u_2(C[|C| + j]) \end{aligned}$$

holds. For any clock valuation  $u_1 \in [\text{extract-virtual}(M)]$ ,

$$u_1 \models \bigwedge_{i,j \in \{0\} \cup \{|C|+1, \dots, |C|+i\}} C[k] - C[l] \preceq_{k,l} z_{k,l}$$

holds. Due to Definition 3.8, each clock  $c \in C$  in an AB-semi-synchronized zone has a corresponding virtual clock  $\chi_j$  or is set to zero. Therefore, the DBM entries which belong to a clock  $c$  are a copy of the DBM entries which belong to  $\chi_j$  (since  $M$  is canonic) or the corresponding DBM entries are a copy of the zero entries. If we define  $u_2$  such that  $\forall j \in [1, i] : u_1(C[|C| + j]) = u_2(C[|C| + j])$  and set for each  $c \in C$   $u_2(c)$  to the value of the corresponding virtual clock  $u_2(\chi_j)$  or to zero,  $u_2 \models \bigwedge_{i,j \in \{0, \dots, |C|+i\}} C[k] - C[l] \preceq_{k,l} z_{k,l}$  and  $u_2 \in [M]$  hold.  $\square$

To show that the result of the DBM comparison is not changed if extract-virtual is applied to both sides, we first show that virtual equivalence is transitive.

**Proposition O.2. (Virtual Inclusion is Transitive)**

Given three zones  $D_A \in \mathcal{D}(C_A \cup \{\chi_0, \dots, \chi_{i-1}\})$ ,  $D_B \in \mathcal{D}(C_B \cup \{\chi_0, \dots, \chi_{i-1}\})$ , and  $D_C \in \mathcal{D}(C_C \cup \{\chi_0, \dots, \chi_{i-1}\})$ , with  $D_A \leq_{\text{virtual}} D_B$  and  $D_B \leq_{\text{virtual}} D_C$ .  $D_A \leq_{\text{virtual}} D_C$  holds.

**Proof:**

By Definition 3.9,  $D_A \leq_{\text{virtual}} D_B$  is equivalent to  $\forall u_A \in D_A : \exists u_B \in D_B : \forall j \in [0, \dots, i-1] : u_A(\chi_j) = u_B(\chi_j)$  and  $D_B \leq_{\text{virtual}} D_C$  is equivalent to  $\forall u_B \in D_B : \exists u_C \in D_C : \forall j \in [0, \dots, i-1] : u_B(\chi_j) = u_C(\chi_j)$ . Therefore,

$$\begin{aligned} & \forall u_A \in D_A : \exists u_B \in D_B : \exists u_C \in D_C : \forall j \in [0, \dots, i-1] : u_A(\chi_j) = u_B(\chi_j) = u_C(\chi_j) \\ & \text{implies } \forall u_A \in D_A : \exists u_C \in D_C : \forall j \in [0, \dots, i-1] : u_A(\chi_j) = u_C(\chi_j) \\ & \text{implies } D_A \leq_{\text{virtual}} D_C \end{aligned}$$

holds.  $\square$

Now we can reduce the virtual equivalence of  $[M_1]$  and  $[M_2]$  to the virtual equivalence of  $[\text{extract-virtual}(M_1)]$  and  $[\text{extract-virtual}(M_2)]$ .

**Proposition O.3. (extract-virtual preserves Virtual Inclusion)**

For two canonic DBM  $M_1 \in \mathcal{M}(C_A \cup \{\chi_0, \dots, \chi_{i-1}\})$  and  $M_2 \in \mathcal{M}(C_B \cup \{\chi_0, \dots, \chi_{i-1}\})$ , with  $[M_1]$  being a zone of an AB-semi-synchronized symbolic state of a VCG and  $[M_2]$  being a zone of an AB-semi-synchronized symbolic state of (another) VCG,  $[M_1] \leq_{\text{virtual}} [M_2]$  is equivalent to  $[\text{extract-virtual}(M_1)] \leq_{\text{virtual}} [\text{extract-virtual}(M_2)]$ .

**Proof:**

We first show that  $[M_1] \leq_{\text{virtual}} [M_2]$  implies  $[\text{extract-virtual}(M_1)] \leq_{\text{virtual}} [\text{extract-virtual}(M_2)]$  and afterwards we show the opposite direction.

Since  $[M_1] \leq_{\text{virtual}} [M_2]$  implies  $[\text{extract-virtual}(M_1)] \leq_{\text{virtual}} [\text{extract-virtual}(M_2)]$  can only be false, if  $[M_1] \leq_{\text{virtual}} [M_2]$  is true, we assume this to be the case and show that  $[\text{extract-virtual}(M_1)] \leq_{\text{virtual}} [\text{extract-virtual}(M_2)]$  is implied. Due to Proposition O.1,  $[\text{extract-virtual}(M_1)] \leq_{\text{virtual}} [M_1]$  holds and due to the precondition  $[M_1] \leq_{\text{virtual}} [M_2]$  and Proposition O.2, this implies  $[\text{extract-virtual}(M_1)] \leq_{\text{virtual}} [M_2]$ . Since  $[M_2] \leq_{\text{virtual}} [\text{extract-virtual}(M_2)]$  by Proposition O.1,  $[\text{extract-virtual}(M_1)] \leq_{\text{virtual}} [\text{extract-virtual}(M_2)]$  follows by Proposition O.2.

Now we show the opposite direction. Since  $[\text{extract-virtual}(M_1)] \leq_{\text{virtual}} [\text{extract-virtual}(M_2)]$  implies  $[M_1] \leq_{\text{virtual}} [M_2]$  can only be false, if  $[\text{extract-virtual}(M_1)] \leq_{\text{virtual}} [\text{extract-virtual}(M_2)]$  is true, we assume this to be the case and show that  $[M_1] \leq_{\text{virtual}} [M_2]$  is implied. Due to Proposition O.1,  $[M_1] \leq_{\text{virtual}} [\text{extract-virtual}(M_1)]$  holds and due to the precondition  $[\text{extract-virtual}(M_1)] \leq_{\text{virtual}} [\text{extract-virtual}(M_2)]$  and Proposition O.2, this implies  $[M_1] \leq_{\text{virtual}} [\text{extract-virtual}(M_2)]$ . Since  $[\text{extract-virtual}(M_2)] \leq_{\text{virtual}} [M_2]$  by Proposition O.1,  $[\text{extract-virtual}(M_1)] \leq_{\text{virtual}} [\text{extract-virtual}(M_2)]$  follows by Proposition O.2.  $\square$

Due to Proposition O.3,  $[M_1] \leq_{\text{virtual}} [M_2]$  is an inclusion problem as the following proposition shows.

**Proposition O.4. (Virtual Inclusion is an Inclusion Problem)**

For two canonic DBM  $M_1 \in \mathcal{M}(C_A \cup \{\chi_0, \dots, \chi_{i-1}\})$  and  $M_2 \in \mathcal{M}(C_B \cup \{\chi_0, \dots, \chi_{i-1}\})$ , with  $[M_1]$  being a zone of an AB-semi-synchronized symbolic state of a VCG and  $[M_2]$  being a zone of an AB-semi-synchronized symbolic state of (another) VCG,  $[M_1] \leq_{\text{virtual}} [M_2]$  holds if and only if  $[\text{extract-virtual}(M_1)] \subseteq [\text{extract-virtual}(M_2)]$  holds.

**Proof:**

Due to Proposition O.3,  $[M_1] \leq_{\text{virtual}} [M_2]$  holds if and only if  $[\text{extract-virtual}(M_1)] \leq_{\text{virtual}} [\text{extract-virtual}(M_2)]$  holds and this is the case if and only if  $\forall u_1 \in [\text{extract-virtual}(M_1)] : \exists u_2 \in [\text{extract-virtual}(M_2)] : \forall j \in [0, \dots, i-1] : u_1(\chi_j) = u_2(\chi_j)$  is fulfilled. Since  $[\text{extract-virtual}(M_1)]$ ,  $[\text{extract-virtual}(M_2)] \in \mathcal{M}(\{\chi_0, \dots, \chi_{i-1}\})$ ,  $\forall j \in [0, \dots, i-1] : u_1(\chi_j) = u_2(\chi_j)$  implies  $u_1 = u_2$  and, therefore,  $\forall u_1 \in [\text{extract-virtual}(M_1)] : \exists u_2 \in [\text{extract-virtual}(M_2)] : \forall j \in [0, \dots, i-1] : u_1(\chi_j) = u_2(\chi_j)$  holds if and only if  $[\text{extract-virtual}(M_1)] \subseteq [\text{extract-virtual}(M_2)]$  holds.  $\square$

It is well-known that the inclusion problem for DBMs is solved, e.g. the *relation* algorithm with polynomial complexity, as described in the comprehensive guide of Bengtsson and Yi [21], can be used to easily check for this property. Therefore, to check for virtual equivalence of  $[M_1]$  and  $[M_2]$ , with  $[M_1]$ ,  $[M_2]$  being zones of AB-semi-synchronized symbolic states, we just need to run the relation algorithm using the DBMs  $\text{extract-virtual}(M_1)$  and  $\text{extract-virtual}(M_2)$ .

**P.  $u(\chi_i)$  is Unique**

The following corollary shows that within an AB-semi-synchronized symbolic state, each virtual clock values define a certain clock valuation.

**Corollary P.1.** ( $u(\chi_i)$  is unique)

Assume two TA  $A, B$ , with VCG  $A_{\text{VCG}}$  of  $A$  regarding  $B$  and VCG  $B_{\text{VCG}}$  of  $B$  regarding  $A$ , using the sets of clock  $C_A, C_B$ . Let  $v_A^{\text{VC}}$  be an AB-semi-synchronized symbolic state in  $A_{\text{VCG}}$  and  $v_B^{\text{VC}}$  be an AB-semi-synchronized symbolic state in  $B_{\text{VCG}}$ .

For any two states  $(l_A, u_{A,1}), (l_A, u_{A,2}) \in v_A^{\text{VC}}$

$$\text{virt}(u_{1,A}) = \text{virt}(u_{2,A}) \text{ implies } u_{1,A} = u_{2,A}.$$

For any two states  $(l_B, u_{B,1}), (l_B, u_{B,2}) \in v_B^{\text{VC}}$

$$\text{virt}(u_{1,B}) = \text{virt}(u_{2,B}) \text{ implies } u_{1,B} = u_{2,B}.$$

**Proof:**

We define  $v_A^{\text{VC}} = (l_A, D_A)$ . By Definition 3.8

$$\begin{aligned} \forall j \in [0, |C_A| - 1] : u_{1,A}(C_A[j]) &= \begin{cases} 0, & \text{if } \forall u_A \in D_A : u_A(C_A[j]) = 0, \\ u_{1,A}(\chi_j), & \text{else} \end{cases} \\ &= \begin{cases} 0, & \text{if } \forall u_A \in D_A : u_A(C_A[j]) = 0, \\ u_{2,A}(\chi_j), & \text{else} \end{cases} \\ &= u_{2,A}(C_A[j]). \end{aligned}$$

Therefore,  $\forall c \in C \cup \{\chi_0, \dots, \chi_{i-1}\} : u_{1,A}(c) = u_{2,A}(c)$ , which implies  $u_{1,A} = u_{2,A}$ . The second part can be shown analogously.  $\square$

**Q. Properties of sync for Symbolic States**

We show Proposition 3.9 here. For better readability, we first show that the sync function can be implemented using the reset set as defined in Proposition 3.9.

**Proposition Q.1. (Reshape of the sync function)**

Assume two TA  $A, B$ , the VCG  $A_{\text{VCG}} = (V_{\text{VC},A}, v_{0,A}^{\text{VC}}, \Sigma \cup \{\varepsilon\}, \xrightarrow{\text{VCG}})$  of  $A$  regarding  $B$  and the VCG  $B_{\text{VCG}} = (V_{\text{VC},B}, v_{0,B}^{\text{VC}}, \Sigma \cup \{\varepsilon\}, \xrightarrow{\text{VCG}})$  of  $B$  regarding  $A$ , using the sets of clocks  $C_A, C_B$ . Let  $(l_A, D_A)$  be an AB-semi-synchronized symbolic state of  $A_{\text{VCG}}$  and  $(l_B, D_B)$  be an AB-semi-synchronized symbolic state of  $B_{\text{VCG}}$  with  $D_A \equiv_{\text{virtual}} D_B$ . We define

$$R_A = \{\chi_i \mid i \in [0, |C_A| - 1] \wedge \forall u_A \in D_A : u_A(C_A[i]) = 0\},$$

$$R_B = \{\chi_{i+|C_A|} \mid i \in [0, |C_B| - 1] \wedge \forall u_B \in D_B : u_B(C_B[i]) = 0\},$$

and  $R = R_A \cup R_B$ .

$$\text{sync}(v_A^{\text{VC}}, v_B^{\text{VC}}) = ((l_A, R(D_A)), (l_B, R(D_B)))$$

holds.

**Proof:**

We denote

$$\text{sync}(v_A^{\text{VC}}, v_B^{\text{VC}}) = ((l_A, D_{e,A}), (l_B, D_{e,B})).$$

Since  $D_{e,B} = R(D_B)$  can be shown analogously to  $D_{e,A} = R(D_A)$ , we show only  $D_{e,A} = R(D_A)$ . To do so, we first show  $R(D_A) \subseteq D_{e,A}$  and afterwards  $D_{e,A} \subseteq R(D_A)$ .

From the background section we know

$$u_{R,A} \in R(D_A) \Leftrightarrow \exists u_A \in D_A : [R \rightarrow 0]u_A = u_{R,A}.$$

Therefore, for any  $u_{R,A} \in R(D_A)$  there exists a  $u_A \in D_A$  with  $[R \rightarrow 0]u_A = u_{R,A}$  and due to  $D_A \equiv_{\text{virtual}} D_B$ , there exists a  $u_B \in D_B$  with  $\text{virt}(A) = \text{virt}(B)$ . To prove that  $u_{R,A} \in D_{e,A}$  holds, we need to show that the first element of  $\text{sync}(u_A, u_B)$  is equivalent to  $(l_A, u_{R,A})$ . This is the case if and only if

$$\begin{aligned} \text{orig}(u_{R,A}) &= \text{orig}(u_A) \\ \text{virt-A}(u_{R,A})(\chi_i) &= \begin{cases} u_A(\chi_i), & \text{if } u_A(C_A[i]) \neq 0, \\ 0, & \text{else,} \end{cases} \\ \text{virt-B}(u_{R,A})(\chi_{|C_A|+i}) &= \begin{cases} u_A(\chi_{|C_A|+i}), & \text{if } u_B(C_B[i]) \neq 0, \\ 0, & \text{else,} \end{cases} \end{aligned}$$

holds (Definition 3.5). We distinguish the three conditions:

1. Since  $R \subseteq \{\chi_0, \dots, \chi_{|C_A|+|C_B|-1}\}$ , the original clocks are not changed by the reset and  $\text{orig}(u_{R,A}) = \text{orig}([R \rightarrow 0]u_A) = \text{orig}(u_A)$  holds trivially.
2. For any virtual clock  $\chi_i$  with  $i \in [0, |C_A| - 1]$ , we distinguish two cases:

(a)  $\chi_i \in R$ . This implies  $u_{R,A}(\chi_i) = 0$  and  $\forall u_A \in D_A : u_A(C_A[i]) = 0$ . Therefore,

$$\begin{aligned} \text{virt-A}(u_{R,A})(\chi_i) &= 0 \\ &= \begin{cases} u_A(\chi_i), & \text{if } u_A(C_A[i]) \neq 0, \text{ (invalid case)} \\ 0, & \text{else,} \end{cases} \end{aligned}$$

holds trivially.

(b)  $\chi_i \notin R$ . In this case,  $u_{R,A}(\chi_i) = u_A(\chi_i)$ . Therefore, if  $u_A(C_A[i]) \neq 0$ , the equation holds trivially and we assume  $u_A(C_A[i]) = 0$ . Since  $(l_A, D_A)$  is AB-semi-synchronized,

$$((\forall u_A \in D_A : u_A(C_A[i]) = u_A(\chi_i)) \vee (\forall u_A \in D_A : u_A(C_A[i]) = 0))$$

holds. Moreover, due to  $\chi_i \notin R$ ,  $\exists u_{-0,A} \in D_A : u_{-0,A}(C_A[i]) \neq 0$ , which implies  $u_A(C_A[i]) = u_A(\chi_i)$ . Therefore,  $u_{R,A}(\chi_i) = u_A(C_A[i]) = 0$ , and

$$\text{virt-A}(u_{R,A})(\chi_i) = \begin{cases} u_A(\chi_i), & \text{if } u_A(C_A[i]) \neq 0, \\ 0, & \text{else,} \end{cases}$$

holds.

3. For any virtual clock  $\chi_{i+|C_A|}$  with  $i \in [0, |C_B| - 1]$ , we distinguish two cases:

(a)  $\chi_i \in R$ . This implies  $u_{R,A}(\chi_i) = 0$  and  $\forall u_B \in D_B : u_B(C_B[i]) = 0$ . Therefore,

$$\text{virt-B}(u_{R,A})(\chi_{|C_A|+i}) = \begin{cases} u_A(\chi_{|C_A|+i}), & \text{if } u_B(C_B[i]) \neq 0, \\ 0, & \text{else,} \end{cases}$$

holds trivially, since  $u_B(C_B[i]) = 0$ .

(b)  $\chi_i \notin R$ . In this case,  $u_{R,A}(\chi_{i+|C_A|}) = u_A(\chi_{i+|C_A|})$ . Therefore, if  $u_B(C_B[i]) \neq 0$ , the equation holds trivially and we assume  $u_B(C_B[i]) = 0$ . Since  $(l_B, D_B)$  is AB-semisynchronized,

$$(\forall u_B \in D_B : u_B(C_B[i]) = u_B(\chi_{i+|C_A|})) \vee (\forall u_B \in D_B : u_B(C_B[i]) = 0)$$

holds. Since  $\chi_i \notin R$ ,  $\exists u_{-0,B} \in D_B : u_{-0,B}(C_B[i]) \neq 0$  holds, which implies  $u_B(C_B[i]) = u_B(\chi_{i+|C_A|}) = 0$ . Therefore,  $u_{R,A}(\chi_{i+|C_A|}) = u_A(\chi_{i+|C_A|}) = u_B(\chi_{i+|C_A|}) = 0$ , and

$$\text{virt-B}(u_{R,A})(\chi_{|C_A|+i}) = \begin{cases} u_A(\chi_{|C_A|+i}), & \text{if } u_B(C_B[i]) \neq 0, \\ 0, & \text{else,} \end{cases}$$

holds.

Therefore,  $R(D_A) \subseteq D_{e,A}$  holds. In the following, we show the opposite direction.

By definition, we know that for any  $u_{e,A} \in D_{e,A}$ , there exists a  $u_A \in D_A$  and a  $u_B \in D_B$ , with  $\text{virt}(u_A) = \text{virt}(u_B)$ , such that

$$\begin{aligned} \text{orig}(u_{e,A}) &= \text{orig}(u_A) \\ \text{virt-A}(u_{e,A})(\chi_i) &= \begin{cases} u_A(\chi_i), & \text{if } u_A(C_A[i]) \neq 0, \\ 0, & \text{else,} \end{cases} \\ \text{virt-B}(u_{e,A})(\chi_{|C_A|+i}) &= \begin{cases} u_A(\chi_{|C_A|+i}), & \text{if } u_B(C_B[i]) \neq 0, \\ 0, & \text{else,} \end{cases} \end{aligned}$$

holds. To show  $D_{e,A} \subseteq R(D_A)$ , we need to show  $u_{e,A} \in R(D_A)$ . To do so, it is sufficient to show  $[R \rightarrow 0]u_A = u_{e,A}$ . This is the case, if and only if for any clock  $c \in C_A \cup \{\chi_0, \dots, \chi_{|C_A|+|C_B|-1}\} : [R \rightarrow 0]u_A(c) = u_{e,A}(c)$  holds. We distinguish our well-known ranges:

1.  $c \in C_A$ . Since  $R \subseteq \{\chi_0, \dots, \chi_{|C_A|+|C_B|-1}\}$ , the original clocks are not changed by the reset and  $[R \rightarrow 0]u_A(c) = u_{e,A}(c)$  holds by  $\text{orig}(u_{e,A}) = \text{orig}(u_A)$ .
2.  $c = \chi_i$ , with  $i \in [0, \dots, |C_A| - 1]$ . We distinguish the following two subcases:
  - (a)  $u_A(C_A[i]) \neq 0$ . In this case,  $u_A(\chi_i) = u_{e,A}(\chi_i)$  and due to  $\chi_i \notin R$  (implied by  $u_A(C_A[i]) \neq 0$ ),  $[R \rightarrow 0]u_A(\chi_i) = u_{e,A}(\chi_i)$  holds.

- (b)  $u_A(C_A[i]) = 0$ . In this case,  $u_{e,A}(\chi_i) = 0$ . If  $\chi_i \in R$ ,  $[R \rightarrow 0]u_A(\chi_i) = 0 = u_{e,A}(\chi_i)$  holds trivially. Therefore, we assume  $\chi_i \notin R$ . Since  $(l_A, D_A)$  is AB-semi-synchronized,

$$((\forall u_A \in D_A : u_A(C_A[i]) = u_A(\chi_i)) \vee (\forall u_A \in D_A : u_A(C_A[i]) = 0))$$

holds. Due to  $\chi_i \notin R$ ,  $\exists u_{-0,A} \in D_A : u_{-0,A}(C_A[i]) \neq 0$  holds and  $u_A(C_A[i]) = 0 = u_A(\chi_i)$  is implied. Therefore,  $u_{e,A}(\chi_i) = 0 = u_A(\chi_i) = [R \rightarrow 0]u_A(\chi_i)$  holds in this subcase, too.

3.  $c = \chi_{i+|C_A|}$ , with  $i \in [0, |C_B| - 1]$ . We distinguish the following two subcases:

- (a)  $u_B(C_B[i]) \neq 0$ . In this case,  $u_A(\chi_{i+|C_A|}) = u_{e,A}(\chi_{i+|C_A|})$  and due to  $\chi_{i+|C_A|} \notin R$  (implied by  $u_B(C_B[i]) \neq 0$ ),  $[R \rightarrow 0]u_A(\chi_{i+|C_A|}) = u_{e,A}(\chi_{i+|C_A|})$  holds.
- (b)  $u_B(C_B[i]) = 0$ . In this case,  $u_{e,A}(\chi_{i+|C_A|}) = 0$ . If  $\chi_{i+|C_A|} \in R$ ,  $[R \rightarrow 0]u_A(\chi_{i+|C_A|}) = 0 = u_{e,A}(\chi_{i+|C_A|})$  holds trivially. Therefore, we assume  $\chi_{i+|C_A|} \notin R$ . Since  $(l_B, D_B)$  is AB-semi-synchronized,

$$(\forall u_B \in D_B : u_B(C_B[i]) = u_B(\chi_{i+|C_A|})) \vee (\forall u_B \in D_B : u_B(C_B[i]) = 0)$$

holds and due to  $\chi_{i+|C_A|} \notin R$ , we know  $\exists u_{-0,B} \in D_B : u_{-0,B}(C_B[i]) \neq 0$ . Therefore,  $u_B(\chi_{i+|C_A|}) = u_B(C_B[i]) = 0$  holds and  $u_A(\chi_{i+|C_A|}) = u_B(\chi_{i+|C_A|}) = 0 = u_{e,A}(\chi_{i+|C_A|})$  is implied.

Therefore,  $R(D_A) = D_{e,A}$  holds. □

Now we show Proposition 3.9.

**Proof:**

$$\text{sync}(v_A^{\text{VC}}, v_B^{\text{VC}}) = ((l_A, R(D_A)), (l_B, R(D_B)))$$

holds by Proposition Q.1.

We now show  $R(D_A) \equiv_{\text{virtual}} R(D_B)$ .  $D_A \equiv_{\text{virtual}} D_B$  implies  $D_A \leq_{\text{virtual}} D_B$ , which is equivalent to

$$\forall u_A \in D_A : \exists u_B \in D_B : \text{virt}(u_A) = \text{virt}(u_B)$$

by Definition 3.9. From the background section, we know that for any  $u_{R,A} \in R(D_A)$  exists a  $u_A \in D_A$ , such that  $u_{R,A} = [R \rightarrow 0]u_A$ . Let  $u_B \in D_B$  be the clock valuation with  $\text{virt}(u_A) = \text{virt}(u_B)$ . From the background section, we know that there exists a clock valuation  $u_{R,B} \in D_{R,B}$ , such that  $u_{R,B} = [R \rightarrow 0]u_B$  holds. For any virtual clock  $\chi_i$ , we distinguish two cases:

1.  $\chi_i \in R$ . In this case,  $u_{R,B}(\chi_i) = [R \rightarrow 0]u_B(\chi_i) = 0 = [R \rightarrow 0]u_A(\chi_i) = u_{R,A}(\chi_i)$ .
2.  $\chi_i \notin R$ . In this case,  $u_{R,B}(\chi_i) = [R \rightarrow 0]u_B(\chi_i) = u_B(\chi_i) = u_A(\chi_i) = [R \rightarrow 0]u_A(\chi_i) = u_{R,A}(\chi_i)$ .



Therefore,

$$\forall u_{R,A} \in D_{R,A} : \exists u_{R,B} \in D_{R,B} : \text{virt}(u_{R,A}) = \text{virt}(u_{R,B})$$

holds, which is equivalent to  $D_{R,A} \leq_{\text{virtual}} D_{R,B}$ . Since  $D_{R,B} \leq_{\text{virtual}} D_{R,A}$  can be shown analogously,  $D_{R,A} \equiv_{\text{virtual}} D_{R,B}$  holds.

Finally, we show that the result of the sync function is AB-synchronized. We only show that  $(l_A, D_{e,A})$  is AB-synchronized, since the AB-synchronizedness of  $(l_B, D_{e,B})$  can be shown analogously.

$(l_A, D_{e,A})$  is AB-synchronized if and only if

$$\forall i \in [0, |C_A| - 1] : \forall u_{e,A} \in D_{e,A} : u_{e,A}(C_A[i]) = u_{e,A}(\chi_i)$$

holds. We assume any value  $i \in [0, |C_A| - 1]$ . By Definition 3.5 and Definition 3.10 we know that for any  $u_{e,A} \in D_{e,A}$  there exists a  $u_A \in D_A$  and a  $u_B \in D_B$  such that

$$\begin{aligned} \text{orig}(u_{e,A}) &= \text{orig}(u_A), \\ \text{virt-A}(u_{e,A})(\chi_i) &= \begin{cases} u_A(\chi_i), & \text{if } u_A(C_A[i]) \neq 0, \\ 0, & \text{else,} \end{cases} \\ \text{virt-B}(u_{e,A})(\chi_{|C_A|+i}) &= \begin{cases} u_A(\chi_{|C_A|+i}), & \text{if } u_B(C_B[i]) \neq 0, \\ 0, & \text{else,} \end{cases} \end{aligned}$$

holds. Since  $v_A^{\text{VC}}$  is AB-semi-synchronized, we know that either  $\forall u_A \in D_A : u_A(C_A[i]) = 0$  or  $\forall u_A \in D_A : u_A(C_A[i]) = u_A(\chi_i)$  holds (Definition 3.8). We distinguish those two cases:

1.  $\forall u_A \in D_A : u_A(C_A[i]) = 0$  holds. In this case, we know by Proposition Q.1 that  $u_{e,A}(\chi_i) = 0$  holds (since  $\chi_i \in R$ ), which implies  $u_{e,A}(C_A[i]) = u_A(C_A[i]) = 0 = u_{e,A}(\chi_i)$ .
2.  $\exists u_{-0,A} \in D_A : u_{-0,A}(C_A[i]) \neq 0$ . In this case,  $u_A(C_A[i]) = u_A(\chi_i)$  holds, due to the fact that  $v_A^{\text{VC}}$  is AB-semi-synchronized. By Proposition Q.1, we know  $u_A(C_A[i]) = u_{e,A}(C_A[i])$  and  $u_A(\chi_i) = u_{e,A}(\chi_i)$  ( $\chi_i \notin R_A$ , due to  $\exists u_{-0,A} \in D_A : u_{-0,A}(C_A[i]) \neq 0$ ). Therefore,  $u_{e,A}(C_A[i]) = u_A(C_A[i]) = u_A(\chi_i) = u_{e,A}(\chi_i)$ .

Therefore, Proposition 3.9 holds.  $\square$

## R. sync on Synchronized Symbolic States

We show Proposition 3.10 here.

**Proof:**

We define

$$((l_A, D_{e,A}), (l_B, D_{e,B})) = \text{sync}((l_A, D_A), (l_B, D_B)).$$

To show the proposition, we have to show that if  $(l_A, D_A)$  and  $(l_B, D_B)$  are AB-synchronized, then  $D_{e,A} = D_A$  and  $D_{e,B} = D_B$  holds. Since the second equation can be shown analogously to the first equation, we show only the first equation. By Proposition 3.9, we know that  $D_{e,A} = R(D_A)$  with

$$R_A = \{\chi_i \mid i \in [0, |C_A| - 1] \wedge \forall u_A \in D_A : u_A(C_A[i]) = 0\},$$

$$R_B = \{\chi_{i+|C_A|} \mid i \in [0, |C_B| - 1] \wedge \forall u_B \in D_B : u_B(C_B[i]) = 0\},$$

and  $R = R_A \cup R_B$ . To show the proposition, we need to show that  $D_A$  is equivalent to  $R(D_A)$ . To do so, we first show  $D_A \subseteq R(D_A)$  and afterwards the opposite direction.

From the background section, we know that for any  $u_A \in D_A$  exists a  $u_{R,A} \in R(D_A)$  with  $u_{R,A} = [R \rightarrow 0]u_A$ . Since  $R \subseteq \{\chi_0, \dots, \chi_{|C_A|+|C_B|-1}\}$ ,  $\text{orig}(u_A) = \text{orig}(u_{R,A})$ . For any virtual clock  $\chi_i$ , we distinguish two cases:

1.  $\chi_i \notin R$ . In this case, obviously  $u_A(\chi_i) = u_{R,A}(\chi_i)$ .
2.  $\chi_i \in R$ . In this case,  $u_{R,A}(\chi_i) = 0$ . We distinguish two subcases:
  - (a)  $i \in [0, |C_A| - 1]$ . We remind the reader of the fact that  $D_A$  being AB-synchronized implies  $u_A$  being AB-synchronized and, therefore,  $u_A(C_A[i]) = u_A(\chi_i)$ . Due to  $\chi_i \in R$ ,  $u_A(C_A[i]) = 0$  holds and  $u_A(\chi_i) = u_A(C_A[i]) = 0 = u_{R,A}(\chi_i)$ .
  - (b)  $i \in [ |C_A|, |C_A| + |C_B| - 1 ]$ . In this case,  $\forall u_B \in D_B : u_B(C_B[i - |C_A|]) = 0$ . Since  $D_B$  is AB-synchronized, this implies  $\forall u_B \in D_B : u_B(\chi_i) = 0$ . Since  $D_A \leq_{\text{virtual}} D_B$  holds,  $\forall u_A \in D_A : u_A(\chi_i) = 0$  holds (since otherwise, there was a clock valuation in  $D_A$  without an virtually equivalent clock valuation in  $D_B$ , which is a contradiction to  $D_A \leq_{\text{virtual}} D_B$ ). Therefore,  $u_A(\chi_i) = 0 = u_{R,A}(\chi_i)$ .

Therefore,  $u_A = u_{R,A} \in R(D_A)$ , and  $D_A \subseteq R(D_A)$  holds. Now we show the opposite direction.

From the background section, we know that for any  $u_{R,A} \in R(D_A)$  exists a  $u_A \in D_A$  with  $u_{R,A} = [R \rightarrow 0]u_A$ . Once again, we can show analogously that  $u_A = u_{R,A}$  holds, which implies  $u_{R,A} \in D_A$  and, therefore,  $R(D_A) \subseteq D_A$ . Therefore,  $D_{e,A} = R(D_A) = D_A$  and Proposition 3.10 holds.  $\square$

## S. Splitting a Zone into Regions

In this appendix, we show how to split a zone into its regions. This algorithm will be used in Appendix U.

To do so, we use the hint of Alur and Dill [16] that a region can be specified by

1. defining a clock constraint of the form  $c = m_c$ ,  $m_c - 1 < c < m_c$ , or  $k(c) < c$ , for every clock  $c \in C$  and
2. defining for every pair  $c, c' \in C$  such that  $m_c - 1 < c < m_c$ ,  $m_{c'} - 1 < c' < m_{c'}$  appear in the previous case, the ordering relationship between  $\text{frac}(c)$  and  $\text{frac}(c')$ .

We first show how to split a zone such that the first condition is fulfilled for all subzones and afterwards we show how to split all subzones such that the second condition is fulfilled, too. The following operator splits a zone into a list of zones, which all fulfill the first condition.

**Definition S.1. (split-clock-values operator)**

Let  $C$  be a set of clocks,  $D \in \mathcal{D}(C)$  be a zone, and  $k : C \rightarrow \mathbb{N}^{\geq 0}$  be a function. We define the operator

$$\text{split-clock-values} : \mathbb{N}^{\geq 0} \times \mathcal{D}(C)^* \times C \rightarrow \mathbb{N}^{\geq 0} \rightarrow \mathcal{D}(C)^*$$

such that

$$\text{split-clock-values}(0, D, k) = [D_0, \dots, D_n]$$

with

1.  $\forall i \in [0, n] : D_i \neq \emptyset$ ,
2.  $\bigcup_{i \in [0, n]} D_i = D$ ,
3.  $\forall i, j \in [0, n] : D_i \cap D_j \neq \emptyset$  implies  $i = j$ ,
4.  $\forall i \in [0, n] : \forall c \in C : \exists m \in \mathbb{N}^{\geq 0} : ((D_i \wedge (c = m)) = D_i) \vee ((D_i \wedge (m - 1 < c < m)) = D_i) \vee ((D_i \wedge (c > k(c))) = D_i)$ ,
5.  $\forall i, j \in [0, n] : (\exists u_i \in D_i : \exists u_j \in D_j : u_i \simeq_k u_j)$  implies  $(i = j)$ .

Before we can show that SPLIT-CLOCK-VALUES-IMPL of Algorithm S.1 is a split-clock-values operator, we need the following auxiliary proposition which describes some properties of SPLIT-ZONE-ALONG-A-CLOCK.

**Proposition S.1. (Properties of SPLIT-ZONE-ALONG-A-CLOCK)**

Assume a set of clocks  $C$ , a zone  $D \in \mathcal{D}(C)$ , and a function  $k : C \rightarrow \mathbb{N}^{\geq 0}$ . The function

$$\text{SPLIT-ZONE-ALONG-A-CLOCK} : \mathcal{D}(C) \times C \times (C \rightarrow \mathbb{N}^{\geq 0}) \rightarrow \mathcal{D}(C)^*$$

of Algorithm S.1 returns a list of zones

$$\text{SPLIT-ZONE-ALONG-A-CLOCK}(D, c, k) = [D_0, \dots, D_n],$$

such that

1.  $\bigcup_{i \in [0, n]} D_i = D$ ,
2.  $\forall i, j \in [0, n] : D_i \cap D_j \neq \emptyset$  implies  $i = j$ ,
3.  $\forall i \in [0, n] : \exists m \in \mathbb{N}^{\geq 0} : (D_i \wedge (c = m) = D_i) \vee (D_i \wedge (m - 1 < c < m) = D_i) \vee (D_i \wedge (c > k(c)) = D_i)$ ,
4.  $\forall i, j \in [0, n] : (\exists u_i \in D_i : \exists u_j \in D_j : u_i \simeq_k u_j)$  implies  $(i = j)$ .

holds.

---

**Algorithm S.1** An implementation of the split-clock-values operator (Definition S.1)
 

---

▷ Let  $D \in \mathcal{D}(C)$ ,  $c \in C$ , and  $k : C \rightarrow \mathbb{N}^{\geq 0}$ .

```

1: function SPLIT-ZONE-ALONG-A-CLOCK( $D, c, k$ )
2:   result  $\leftarrow$  emptylist
3:   result.append( $D \wedge c = 0$ )
4:   for  $i = 1; i \leq k(c); i = i + 1$  do
5:     result.append( $D \wedge c > i - 1 \wedge c < i$ )
6:     result.append( $D \wedge c = i$ )
7:   end for
8:   result.append( $D \wedge c > k(c)$ )
9:   return result
10: end function

```

▷ Let  $i \in [0, |C|]$ ,  $D \in \mathcal{D}(C)$ , and  $k : C \rightarrow \mathbb{N}^{\geq 0}$ .

```

1: function SPLIT-CLOCK-VALUES-IMPL( $i, D, k$ )
2:   if  $D = \emptyset$  then
3:     return []
4:   end if
5:   if  $i \geq |C|$  then
6:     return [ $D$ ]
7:   end if
8:   split  $\leftarrow$  SPLIT-ZONE-ALONG-A-CLOCK( $D, C[i], k$ )
9:   result  $\leftarrow$  []
10:  for  $D_{\text{split}} \in$  split do
11:    result.append(SPLIT-CLOCK-VALUES-IMPL( $i + 1, D_{\text{split}}, k$ ))
12:  end for
13:  return result
14: end function

```

---

**Proof:**

To prove this proposition, we first define the following precondition and invariant for the loop of the SPLIT-ZONE-ALONG-A-CLOCK function. Afterwards we show the conditions of the proposition.

**Precondition:**  $D$  is a zone,  $c \in C$ ,  $k$  is a function  $k : C \rightarrow \mathbb{N}^{\geq 0}$ , and result is a list of length one with  $\text{result}[0] = (D \wedge (c = 0))$ .

**Invariant:** After  $j$  iteration, result is a list of zones  $D_l$ , such that

1.  $|\text{result}| = 2 \cdot j + 1$ ,
2.  $\forall l \in [0, 2 \cdot j] : ((l \bmod 2 = 0) \text{ implies } (D_l \wedge (c = l/2)) = D_l) \wedge ((l \bmod 2 = 1) \text{ implies } (D_l \wedge ((l-1)/2 < c < (l-1)/2 + 1)) = D_l)$ ,
3.  $\bigcup_{l \in [0, 2 \cdot j]} D_l \cup D \wedge (c > j) = D$ ,

holds. We show this invariant by induction.

**Base Case:** The invariant holds after 0 iteration.

**Induction Step:** If the invariant holds after  $j$  iteration, then it also holds for  $j + 1$  iteration.

We show the base case by showing one statement after the other.

1.  $|\text{result}| = 1$  by the precondition. Since  $2 \cdot 0 + 1 = 1$ , this statement holds,
2. We can show

$$\begin{aligned}
& \forall l \in [0, 0] : ((l \bmod 2 = 0) \text{ implies } D_l \wedge (c = l/2) = D_l) \wedge \\
& \quad ((l \bmod 2 = 1) \text{ implies } D_l \wedge ((l-1)/2 < c < (l-1)/2 + 1) = D_l) \\
\Leftrightarrow & \quad ((0 \bmod 2 = 0) \text{ implies } D_0 \wedge (c = 0/2) = D_0) \wedge \\
& \quad ((0 \bmod 2 = 1) \text{ implies } D_0 \wedge ((0-1)/2 < c < (0-1)/2 + 1) = D_0) \\
\Leftrightarrow & \quad (\text{true implies } D_0 \wedge (c = 0) = D_0) \wedge \\
& \quad (\text{false implies } D_0 \wedge ((0-1)/2 < c < (0-1)/2 + 1) = D_0) \\
\Leftrightarrow & \quad D_0 \wedge (c = 0) = D_0 \\
\Leftrightarrow & \quad D \wedge (c = 0) \wedge (c = 0) = D_0 \\
\Leftrightarrow & \quad D \wedge (c = 0) = D_0 \\
\Leftrightarrow & \quad \text{true.}
\end{aligned}$$

Therefore, this statement holds in the base case, and

3.  $\bigcup_{l \in [0, 0]} D_l \cup D \wedge (c \geq 0) = (D \wedge c = 0) \cup (D \wedge c > 0) = D$  holds.

Now we show the induction step. Once again, we show one statement after the other.

1.  $|\text{result}| = 2 \cdot (j + 1) + 1$ . By the induction hypothesis, there are  $2 \cdot j + 1$  entries after  $j$  iteration. Since there are two entries added in the  $j + 1$ th iteration, there are  $2 \cdot j + 1 + 2 = 2 \cdot (j + 1)$  entries after  $j + 1$  iteration,

2.  $\forall l \in [0, 2 \cdot (j+1)] : ((l \bmod 2 = 0) \text{ implies } D_l \wedge (c = l/2) = D_l) \wedge ((l \bmod 2 = 1) \text{ implies } D_l \wedge ((l-1)/2 < c < (l-1)/2+1) = D_l)$ . By the induction hypothesis, we know that  $\forall l \in [0, 2 \cdot j] : ((l \bmod 2 = 0) \text{ implies } D_l \wedge (c = l/2) = D_l) \wedge ((l \bmod 2 = 1) \text{ implies } D_l \wedge ((l-1)/2 < c < (l-1)/2+1) = D_l)$  holds. Therefore, we only have to check the statements for  $l = 2 \cdot (j+1) - 1$  and  $l = 2 \cdot (j+1)$ .

- $l = 2 \cdot (j+1) - 1$ . Obviously,  $(2 \cdot (j+1) - 1) \bmod 2 = 1$ . Therefore, we only have to show  $D_{2 \cdot (j+1) - 1} \wedge ((2 \cdot (j+1) - 1 - 1)/2 < c < (2 \cdot (j+1) - 1 - 1)/2 + 1) = D_{2 \cdot (j+1) - 1}$ . Obviously,

$$\begin{aligned} & D_{2 \cdot (j+1) - 1} \wedge ((2 \cdot (j+1) - 1 - 1)/2 < c < (2 \cdot (j+1) - 1 - 1)/2 + 1) \\ &= D_{2 \cdot (j+1) - 1} \wedge ((2 \cdot j)/2 < c < (2 \cdot j)/2 + 1) \\ &= D_{2 \cdot (j+1) - 1} \wedge (j < c < j + 1) \end{aligned}$$

By the first statement, we know that  $|\text{result}| = 2 \cdot (j+1) + 1$ . Therefore,  $D_{2 \cdot (j+1) - 1}$  is the second to last zone of result. Due to line four of the SPLIT-ZONE-ALONG-A-CLOCK function, we know that  $D_{2 \cdot (j+1) - 1} = D \wedge (j < c < (j+1))$ . Therefore,

$$\begin{aligned} & D_{2 \cdot (j+1) - 1} \wedge (j < c < j + 1) \\ &= D \wedge (j < c < j + 1) \wedge (j < c < j + 1) \\ &= D \wedge (j < c < j + 1) \\ &= D_{2 \cdot (j+1) - 1} \end{aligned}$$

and the statement holds in this subcase.

- $l = 2 \cdot (j+1)$ . In this case,  $l \bmod 2 = 0$  holds. Therefore, we only have to show  $D_l \wedge (c = l/2) = D_l$ . We know

$$\begin{aligned} D_{2 \cdot (j+1)} \wedge (c = l/2) &= D_{2 \cdot (j+1)} \wedge (c = 2 \cdot (j+1)/2) \\ &= D_{2 \cdot (j+1)} \wedge (c = (j+1)). \end{aligned}$$

By the first statement, we know that  $|\text{result}| = 2 \cdot (j+1) + 1$ . Therefore,  $D_{2 \cdot (j+1)}$  is the last zone of result. Due to line five of the SPLIT-ZONE-ALONG-A-CLOCK function, we know that  $D_{2 \cdot (j+1)} = D \wedge (c = j+1)$ . Therefore,

$$\begin{aligned} D_{2 \cdot (j+1)} \wedge (c = (j+1)) &= D \wedge (c = (j+1)) \wedge (c = (j+1)) \\ &= D \wedge (c = (j+1)) \\ &= D_{2 \cdot (j+1)} \end{aligned}$$

and the statement holds in this subcase, too.

3.  $\bigcup_{l \in [0, 2 \cdot (j+1)]} D_l \cup D \wedge (c > j+1) = D$ . By the induction hypothesis, we know that  $\bigcup_{l \in [0, 2 \cdot j]} D_l \cup D \wedge (c > j) = D$ . We can show

$$D_{2 \cdot j+1} \cup D_{2 \cdot (j+1)} = D \wedge (c = j+1) \cup D \wedge (j < c < j+1)$$

$$\begin{aligned}
&\Leftrightarrow D_{2 \cdot j+1} \cup D_{2 \cdot (j+1)} = D \wedge (j < c \leq j+1) \\
&\Leftrightarrow D_{2 \cdot j+1} \cup D_{2 \cdot (j+1)} \cup D \wedge (c > j+1) = D \wedge (j < c \leq j+1) \cup D \wedge (c > j+1) \\
&\Leftrightarrow D_{2 \cdot j+1} \cup D_{2 \cdot (j+1)} \cup D \wedge (c > j+1) = D \wedge (c > j)
\end{aligned}$$

and, therefore,

$$\begin{aligned}
&\Leftrightarrow \bigcup_{l \in [0, 2 \cdot j]} D_l \cup D_{2 \cdot j+1} \cup D_{2 \cdot (j+1)} \cup D \wedge (c > j+1) = \bigcup_{l \in [0, 2 \cdot j]} D_l \cup D \wedge (c > j) \\
&\Leftrightarrow \bigcup_{l \in [0, 2 \cdot (j+1)]} D_l \cup D \wedge (c > j+1) = \bigcup_{l \in [0, 2 \cdot j]} D_l \cup D \wedge (c > j) \\
&\Leftrightarrow \bigcup_{l \in [0, 2 \cdot (j+1)]} D_l \cup D \wedge (c > j+1) = D.
\end{aligned}$$

Therefore, the invariant holds. Before starting the loop, the preconditions of the invariant are fulfilled. Since  $k(c)$  is finite, the loop terminates after  $k(c)$  iterations. Since the invariant holds, after the loop terminates

1.  $|\text{result}| = 2 \cdot k(c) + 1$ ,
2.  $\forall l \in [0, 2 \cdot k(c)] : ((l \bmod 2 = 0) \text{ implies } D_l \wedge (c = l/2) = D_l) \wedge ((l \bmod 2 = 1) \text{ implies } D_l \wedge ((l-1)/2 < c < (l-1)/2 + 1) = D_l)$ ,
3.  $\bigcup_{l \in [0, 2 \cdot k(c)]} D_l \cup D \wedge (c > k(c)) = D$

hold. After the loop finishes,  $D \wedge (c > k(c))$  is added to result and, finally, result is returned. We now show one statement of Proposition S.1 after the other.

1.  $\bigcup_{l \in [0, n]} D_l = D$  holds due to  $\bigcup_{l \in [0, 2 \cdot k(c)]} D_l \cup D \wedge (c > k(c)) = D$  and since  $D \wedge (c > k(c))$  is added to result,
2.  $\forall i, j \in [0, n] : D_i \cap D_j \neq \emptyset$  implies  $i = j$  holds due the second statement (any  $u \in D$  can fulfill  $(c = l/2)$  or  $((l-1)/2 < c < (l-1)/2 + 1)$  for no more than a single  $l$ ) of the invariant and since  $D \wedge (c > k(c))$  is disjoint to any previously added zone,
3.  $\forall i \in [0, n] : \exists m \in \mathbb{N}^{\geq 0} : (D_i \wedge (c = m) = D_i) \vee (D_i \wedge (m-1 < c < m) = D_i) \vee (D_i \wedge (c > k(c)) = D_i)$  holds by the second statement of the invariant and since  $D \wedge (c > k(c)) \wedge (c > k(c)) = D \wedge (c > k(c))$ ,
4.  $\forall i, j \in [0, n] : (\exists u_i \in D_i : \exists u_j \in D_j : u_i \simeq_k u_j)$  implies  $(i = j)$  holds, since we know from Alur and Dill that  $u_i \simeq_k u_j$  implies that there exists an  $m$  such that both clock valuations fulfill  $(c = m)$ , or  $(m-1 < c < m)$ , or  $(c > k(c))$  for any  $c \in C$ .

Therefore, Proposition S.1 holds. □

The following proposition shows that SPLIT-CLOCKS-VALUES-IMPL is a split-clock-values operator.

**Proposition S.2. (SPLIT-CLOCKS-VALUES-IMPL is a split-clock-values operator)**

The function SPLIT-CLOCKS-VALUES-IMPL is a split-clock-values operator.

**Proof:**

SPLIT-CLOCKS-VALUES-IMPL is a recursive function. Therefore, we show termination and correctness.

The recursion terminates, since in each recursion step, the value  $i$  is incremented and after it has reached the final value  $|C|$ , no more recursion happens. To show correctness, we define an invariant and show it by induction.

**Invariant:** When SPLIT-CLOCKS-VALUES-IMPL terminates, it returns a list of zones  $[D_0, \dots, D_n]$  such that

1.  $\forall j \in [0, n] : D_j \neq \emptyset$ ,
2.  $\bigcup_{j \in [0, n]} D_j = D$ ,
3.  $\forall j, l \in [0, n] : D_j \cap D_l \neq \emptyset$  implies  $j = l$ ,
4.  $\forall j \in [0, n] : \forall l \in [i, |C| - 1] : \exists m \in \mathbb{N}^{\geq 0} : (D_j \wedge (c = m) = D_j) \vee (D_j \wedge (m - 1 < c < m) = D_j) \vee (D_j \wedge (c > k(c)) = D_j)$ ,
5.  $\forall j, l \in [0, n] : (\exists u_j \in D_j : \exists u_l \in D_l : u_j \simeq_k u_l)$  implies  $(j = l)$ .

We show the invariant by induction.

**Base Case:** The invariant holds after zero recursion steps.

**Induction Step:** If the invariant holds after  $h$  recursion steps, it also holds after  $h + 1$  recursion steps. We first show the base case. If no recursion is needed, either  $D = \emptyset$ ,  $i \geq |C|$ , or SPLIT-ZONE-ALONG-A-CLOCK returned an empty list. Since the call of SPLIT-ZONE-ALONG-A-CLOCK is proper according to Proposition S.1, we know that SPLIT-ZONE-ALONG-A-CLOCK can only return an empty list if  $D$  is empty. Therefore, we only have to consider  $D = \emptyset$  or  $i \geq |C|$ .

- $D = \emptyset$ . In this case, the empty list is returned. We show one statement after the other.

1.  $\forall j \in [0, n] : D_j \neq \emptyset$  holds, since the list is empty,
2.  $\bigcup_{j \in [0, n]} D_j = \emptyset = D$  holds,
3.  $\forall j, l \in [0, n] : D_j \cap D_l \neq \emptyset$  implies  $j = l$  holds, since the list is empty,
4.  $\forall j \in [0, n] : \forall l \in [i, |C| - 1] : \exists m \in \mathbb{N}^{\geq 0} : (D_j \wedge (c = m) = D_j) \vee (D_j \wedge (m - 1 < c < m) = D_j) \vee (D_j \wedge (c > k(c)) = D_j)$  holds, since the list is empty, and
5.  $\forall j, l \in [0, n] : (\exists u_j \in D_j : \exists u_l \in D_l : u_j \simeq_k u_l)$  implies  $(j = l)$  holds, since the list is empty.



- $i \geq |C| \wedge D \neq \emptyset$ . In this case, the list  $[D]$  is returned. We show one statement after the other.
  1.  $\forall j \in [0, n] : D_j \neq \emptyset$  holds due to  $D \neq \emptyset$ ,
  2.  $\bigcup_{j \in [0, n]} D_j = D$  holds obviously,
  3.  $\forall j, l \in [0, n] : D_j \cap D_l \neq \emptyset$  implies  $j = l$  holds since  $j = 0 = l$  always holds,
  4.  $\forall j \in [0, n] : \forall l \in [i, |C| - 1] : \exists m \in \mathbb{N}^{\geq 0} : (D_j \wedge (c = m) = D_j) \vee (D_j \wedge (m - 1 < c < m) = D_j) \vee (D_j \wedge (c > k(c)) = D_j)$  holds, since  $i \geq |C|$  and, therefore,  $[i, |C| - 1]$  is empty, and
  5.  $\forall j, l \in [0, n] : (\exists u_j \in D_j : \exists u_l \in D_l : u_j \simeq_k u_l)$  implies  $(j = l)$  holds, since  $j = 0 = l$  always holds.

Therefore, the base case holds and we now show the induction step. We show one statement after the other.

1.  $\forall j \in [0, n] : D_j \neq \emptyset$  holds, since result consists only of elements which were generated by an recursive call (line 11). Since we know by the induction hypothesis that none of those elements are empty, there is no empty element in result,
2.  $\bigcup_{j \in [0, n]} D_j = D$  holds, since by Proposition S.1 we know that the union of all elements of split is equal to  $D$  and by the induction hypothesis we know that the statement also holds for the recursive calls. Therefore, no clock valuation is lost or added and the statement holds,
3.  $\forall j, l \in [0, n] : D_j \cap D_l \neq \emptyset$  implies  $j = l$ , holds since by Proposition S.1 we know that all zones of split are disjoint and by the induction hypothesis we know that all return values of the recursive calls are also disjoint. Therefore, all zones of result are disjoint,
4.  $\forall j \in [0, n] : \forall l \in [i, |C| - 1] : \exists m \in \mathbb{N}^{\geq 0} : (D_j \wedge (c = m) = D_j) \vee (D_j \wedge (m - 1 < c < m) = D_j) \vee (D_j \wedge (c > k(c)) = D_j)$ . By the induction hypothesis, we know that  $\forall j \in [0, n] : \forall l \in [i + 1, |C| - 1] : \exists m \in \mathbb{N}^{\geq 0} : (D_j \wedge (c = m) = D_j) \vee (D_j \wedge (m - 1 < c < m) = D_j) \vee (D_j \wedge (c > k(c)) = D_j)$  holds and we only have to check whether  $\forall j \in [0, n] : \exists m \in \mathbb{N}^{\geq 0} : (D_j \wedge (C[i] = m) = D_j) \vee (D_j \wedge (m - 1 < C[i] < m) = D_j) \vee (D_j \wedge (C[i] > k(C[i])) = D_j)$  holds. By Proposition S.1 we know that this is the case for any zone of split. Since any zone of result is a subzone of a zone of split by the induction hypothesis, this also holds for any zone of result, and
5.  $\forall j, l \in [0, n] : (\exists u_j \in D_j : \exists u_l \in D_l : u_j \simeq_k u_l)$  implies  $(j = l)$ . By Proposition S.1 we know that for any  $u_l, u_i$  this holds for split. By the induction hypothesis, we can follow that after the recursive call, this property holds, too.

Therefore, the function SPLIT-CLOCKS-VALUES-IMPL is a split-clock-values operator.  $\square$

While the result of the split-clocks-values operator fulfills the first condition, the result of the following order-frac operator fulfills the second condition.

**Definition S.2. (order-frac operator)**

Let  $C$  be a set of clocks,  $k \in (C \rightarrow \mathbb{N}^{\geq 0})$  be a function, and  $D \in \mathcal{D}(C)$  be a zone. We define the operator

$$\text{order-frac} : \mathcal{D}(C) \times (C \rightarrow \mathbb{N}^{\geq 0}) \rightarrow \mathcal{D}(C)^*$$

such that

$$\text{order-frac}(D, k) = [D_0, \dots, D_n]$$

with

1.  $\forall i \in [0, n] : D_i \neq \emptyset$ ,
2.  $\bigcup_{i \in [0, n]} D_i = D$ ,
3.  $\forall i, j \in [0, n] : D_i \cap D_j \neq \emptyset$  implies  $i = j$ ,
4.  $\forall i \in [0, n] : c, c' \in C : (\exists m, m' \in \mathbb{N}^{\geq 0} : \forall u \in D_i : m \leq k(c) \wedge m' \leq k(c') \wedge m - 1 < u(c) < m \wedge m' - 1 < u(c') < m')$  implies  $(\forall u_1, u_2 \in D_i : \text{frac}(u_1(c)) \leq \text{frac}(u_1(c')) \Leftrightarrow \text{frac}(u_2(c)) \leq \text{frac}(u_2(c')))$ ,
5.  $\forall i, j \in [0, n] : (\exists u_i \in D_i : \exists u_j \in D_j : u_i \simeq_k u_j)$  implies  $(i = j)$ .

If we use canonic DBM to represent zones, it is easy to check whether  $\exists m \in \mathbb{N}^{\geq 0} : \forall u \in D_i : m - 1 < u(c) < m$  holds for any  $c \in C$ . Let  $c$  be the  $j$ th clock of  $C$ .  $\exists m \in \mathbb{N}^{\geq 0} : \forall u \in D_i : m - 1 < u(c) < m$  holds if and only if the DBM entry of line  $j$  and column 0 is equal to  $(m, <)$  and the DBM entry of line 0 and column  $j$  is equal to  $-(m - 1, <)$ . Before we can show that ORDER-FRAC-IMPL is an order-frac operator, we show some properties of CREATE-FRAC-ORDER of Algorithm S.2.

**Proposition S.3. (Properties of CREATE-FRAC-ORDER)**

Assume a set of clocks  $C$ , values  $\text{clk}_1, \text{clk}_2 \in [0, |C| - 1]$ , two values  $z_1, z_2 \in \mathbb{Z}$ , and a list of zones  $\text{lo-zones} \in \mathcal{D}(C)^*$ . The function

$$\text{CREATE-FRAC-ORDER} : [0, |C| - 1] \times [0, |C| - 1] \times \mathbb{Z} \times \mathbb{Z} \times \mathcal{D}(C)^* \rightarrow \mathcal{D}(C)^*$$

returns a list of zones

$$\text{CREATE-FRAC-ORDER}(\text{clk}_1, \text{clk}_2, M, \text{lo-zones}) = [D_0, \dots, D_n].$$

If

$$\begin{aligned} \forall i \in [0, |\text{lo-zones}| - 1] : \forall u \in \text{lo-zones}[i] : z_1 - 1 < u(C[\text{clk}_1]) < z_1 \wedge \\ \forall i \in [0, |\text{lo-zones}| - 1] : \forall u \in \text{lo-zones}[i] : z_2 - 1 < u(C[\text{clk}_2]) < z_2 \end{aligned}$$

holds, then

1.  $|\text{res}| = 3 \cdot |\text{lo-zones}|$  and

**Algorithm S.2** An implementation of the split-clock-values operator (Definition S.1)

---

▷ Let  $\text{clk}_1, \text{clk}_2 \in [0, |C| - 1]$ ,  $z_1, z_2 \in \mathbb{Z}$ , and  $\text{lo-zones} \in \mathcal{D}(C)^*$ .  
 ▷ We assume any different zones  $D_1, D_2 \in \text{lo-zones}$  to be disjoint.

```

1: function CREATE-FRAC-ORDER( $\text{clk}_1, \text{clk}_2, M, \text{lo-zones}$ )
2:    $\text{res} \leftarrow []$ 
3:   for all  $D \in \text{lo-zones}$  do
4:      $\text{res.append}(D \wedge (C[\text{clk}_1] - C[\text{clk}_2] = z_1 - z_2))$ 
5:      $\text{res.append}(D \wedge (C[\text{clk}_1] - C[\text{clk}_2] > z_1 - z_2))$ 
6:      $\text{res.append}(D \wedge (C[\text{clk}_1] - C[\text{clk}_2] < z_1 - z_2))$ 
7:   end for
8:   return  $\text{res}$ 
9: end function

```

▷ Let  $M \in \mathcal{M}(C)$  be canonic,  $[M]$  be non-empty and  $k \in (C \rightarrow \mathbb{N}^{\geq 0})$ .

```

1: function ORDER-FRAC-IMPL( $M, k$ )
2:    $\text{clocks} \leftarrow []$ 
3:   for all  $i \in [0, |C| - 1]$  do
4:      $(z_{\text{low}}, \sim_{\text{low}}) = M[0][i]$ 
5:      $(z_{\text{up}}, \sim_{\text{up}}) = M[i][0]$ 
6:     if  $z_{\text{up}} \leq k(C[i]) \wedge -z_{\text{low}} = z_{\text{up}} - 1 \wedge \sim_{\text{low}} = < \wedge \sim_{\text{up}} = <$  then
7:        $\text{clocks.append}(i)$ 
8:     end if
9:   end for
11:   $\text{result} \leftarrow [ [M] ]$  ▷ result is a list of zones, initialized with the zone  $[M]$ .
12:  for all  $i \in [0, |\text{clocks}| - 2]$  do
13:    for all  $j \in [i + 1, |\text{clocks}| - 1]$  do
14:       $(z_1, \sim_1) = M[\text{clk}_1][0]$ 
15:       $(z_2, \sim_2) = M[\text{clk}_2][0]$ 
16:       $\text{result} \leftarrow \text{CREATE-FRAC-ORDER}(\text{clocks}[i], \text{clocks}[j], z_1, z_2, \text{result})$ 
17:       $\text{result.remove-empty-zones}()$  ▷ iterate through result and remove empty zones.
18:    end for
19:  end for
20:  return  $\text{result}$ 
21: end function

```

---

2.

$$\begin{aligned} \forall i \in [0, |\text{lo-zones}| - 1] : \text{res}[3 \cdot i] &= D_i \wedge C[\text{clk}_1] - C[\text{clk}_2] = z_1 - z_2 \wedge \\ \text{res}[3 \cdot i + 1] &= D_i \wedge C[\text{clk}_1] - C[\text{clk}_2] > z_1 - z_2 \wedge \\ \text{res}[3 \cdot i + 2] &= D_i \wedge C[\text{clk}_1] - C[\text{clk}_2] < z_1 - z_2 \end{aligned}$$

hold.

**Proof:**

To show this proposition, we show correctness and termination of the loop. Since the loop iterates through all elements of lo-zones, the loop obviously terminates after  $|\text{lo-zones}|$  iterations. To show correctness, we define a precondition and an invariant:

**Precondition:** Before the loop is run, we assume  $\text{clk}_1, \text{clk}_2 \in [0, |C| - 1]$ ,  $\text{lo-zones} \in \mathcal{D}(C)^*$ ,  $z_1$  is a value such that

$$\forall i \in [0, |\text{lo-zones}| - 1] : \forall u \in \text{lo-zones}[i] : z_1 - 1 < u(C[\text{clk}_1]) < z_1$$

and analogously for  $z_2$ . Moreover, res is an empty list.

**Invariant:** After  $l$  iterations,

1.  $|\text{res}| = 3 \cdot l$  and

2.

$$\begin{aligned} \forall i \in [0, l - 1] : \text{res}[3 \cdot i] &= D_i \wedge C[\text{clk}_1] - C[\text{clk}_2] = z_1 - z_2 \wedge \\ \text{res}[3 \cdot i + 1] &= D_i \wedge C[\text{clk}_1] - C[\text{clk}_2] > z_1 - z_2 \wedge \\ \text{res}[3 \cdot i + 2] &= D_i \wedge C[\text{clk}_1] - C[\text{clk}_2] < z_1 - z_2 \end{aligned}$$

hold. We show this invariant by induction.

**Base Case:** The invariant holds after zero iteration.

**Induction Step:** If the invariant holds after  $l$  iteration, it also holds after  $l + 1$  iteration.

We first show the base case. Since res is empty by the precondition and  $l = 0$ ,  $|\text{res}| = 0 = 3 \cdot l$  holds. Since the interval  $[0, l - 1]$  is empty, the second statement also holds for  $l = 0$  and the base case is implied.

We now show the induction step. To do so, we need to show that the invariant holds after  $l + 1$  steps. We remind the reader of the fact that each iteration adds exactly three new zones to result, while the zones which were already element of result before the  $l + 1$ th iteration stay the same. Once again, we show one statement after the other.

1. By the induction hypothesis, we know that after  $l$  iteration  $|\text{res}|$  has the size  $3 \cdot l$ . During the  $l + 1$ th iteration, three elements are added to res. Therefore, after  $l + 1$  iteration,  $|\text{res}| = 3 \cdot l + 3 = 3 \cdot (l + 1)$ , and

2. due to the induction hypothesis, we know that after  $l$  iteration,

$$\begin{aligned}\forall i \in [0, l-1] : \text{res}[3 \cdot i] &= D_i \wedge C[\text{clk}_1] - C[\text{clk}_2] = z_1 - z_2 \wedge \\ \text{res}[3 \cdot i + 1] &= D_i \wedge C[\text{clk}_1] - C[\text{clk}_2] > z_1 - z_2 \wedge \\ \text{res}[3 \cdot i + 2] &= D_i \wedge C[\text{clk}_1] - C[\text{clk}_2] < z_1 - z_2\end{aligned}$$

holds. Therefore, we only need to show that

$$\begin{aligned}\text{res}[3 \cdot l] &= D_l \wedge C[\text{clk}_1] - C[\text{clk}_2] = z_1 - z_2 \wedge \\ \text{res}[3 \cdot l + 1] &= D_l \wedge C[\text{clk}_1] - C[\text{clk}_2] > z_1 - z_2 \wedge \\ \text{res}[3 \cdot l + 2] &= D_l \wedge C[\text{clk}_1] - C[\text{clk}_2] < z_1 - z_2\end{aligned}$$

holds. Since after  $l$  iteration,  $\text{res}$  has the length  $3 \cdot l$ ,  $\text{res}[3 \cdot l]$  is the first element added in the  $l+1$ th iteration. Obviously, the loop adds  $D_l \wedge C[\text{clk}_1] - C[\text{clk}_2] = z_1 - z_2$  first and, therefore,  $\text{res}[3 \cdot l] = D_l \wedge C[\text{clk}_1] - C[\text{clk}_2] = z_1 - z_2$ . The following two statements can be shown analogously and, therefore,

$$\begin{aligned}\forall i \in [0, l] : \text{res}[3 \cdot i] &= D_i \wedge C[\text{clk}_1] - C[\text{clk}_2] = z_1 - z_2 \wedge \\ \text{res}[3 \cdot i + 1] &= D_i \wedge C[\text{clk}_1] - C[\text{clk}_2] > z_1 - z_2 \wedge \\ \text{res}[3 \cdot i + 2] &= D_i \wedge C[\text{clk}_1] - C[\text{clk}_2] < z_1 - z_2\end{aligned}$$

holds after  $l+1$  iteration.

Therefore, the invariant holds. If we replace the  $l$  value with  $|\text{lo-zones}|$  in the invariant, we get the properties of Proposition S.3. Since the DBM is canonic,  $z_1$  is the upper bound of  $C[\text{clk}_1]$  and  $z_2$  is the upper bound of  $C[\text{clk}_2]$ . Therefore, the preconditions of Proposition S.3 imply the preconditions of the invariant and vice versa. Since  $\text{res}$  is returned without any change, Proposition S.3 holds.  $\square$

The following proposition shows that ORDER-FRAC-IMPL is an order-frac operator.

**Proposition S.4. (ORDER-FRAC-IMPL is an order-frac operator)**

Assume a zone  $D \in \mathcal{D}(C)$  and a canonic DBM  $M \in \mathcal{M}(C)$  with  $[M] = C$ . The result of  $\text{ORDER-FRAC-IMPL}(M)$  fulfills all properties of  $\text{order-frac}(D)$ .

**Proof:**

To show this proposition, we analyze both loops, starting with the first. In both cases, we show termination and correctness.

Since the first loop iterates through the interval  $[0, |C| - 1]$ , the loop terminates after  $|C|$  iterations. To show correctness, we provide a precondition and an invariant.

**Precondition:** Before the loop is run we assume that  $\text{clocks}$  is an empty list,  $k \in (C \rightarrow \mathbb{N}^{\geq 0})$  is a function, and  $M \in \mathcal{M}(C)$  is a canonic DBM.

**Invariant:** After  $l$  iteration,

1.  $\forall j \in \text{clocks} : \exists z_{\text{up}} \in \mathbb{N}^{\geq 0} : \forall u \in [M] : z_{\text{up}} - 1 < u(C[j]) < z_{\text{up}}$  and

2.  $\forall j \in [0, l - 1] : \forall z_{\text{up}} \in \mathbb{N}^{\geq 0} : (z_{\text{up}} \leq k(C[j]) \wedge \forall u \in [M] : z_{\text{up}} - 1 < u(C[j]) < z_{\text{up}})$  implies  $(j \in \text{clocks})$

holds. We show the invariant by induction.

**Base Case:** The invariant holds after zero iteration.

**Induction Step:** If the invariant holds after  $l$  iteration, it also holds after  $l + 1$  iteration.

We first show the base case. Since clocks is empty before the first iteration by the precondition, the first statement trivially holds. Since the interval  $[0, l - 1]$  is empty for  $l = 0$ , the second statement also holds trivially, which implies the base case.

We now show the induction step. We show one statement after the other. We remind the reader of the fact that in the  $l + 1$ th iteration, no previously existing element of clocks is changed and no more than a single element is added.

1. If no element is added to clocks, the first statement holds trivially by the induction hypothesis. Therefore, we only consider the case in which a new element, we denote it with  $m$ , is added to clocks in the  $j + 1$ th iteration. By the induction hypothesis, we know that  $\forall j \in \text{clocks} \setminus \{m\} : \exists z_{\text{up}} \in \mathbb{N}^{\geq 0} : \forall u \in [M] : z_{\text{up}} - 1 < u(C[j]) < z_{\text{up}}$  holds. Therefore, to show the statement, we only need to show  $\exists z_{\text{up}} \in \mathbb{N}^{\geq 0} : \forall u \in [M] : z_{\text{up}} - 1 < u(C[m]) < z_{\text{up}}$ . Since  $m$  was added to clocks,  $z_{\text{up}} \leq k(C[i]) \wedge -z_{\text{low}} = z_{\text{up}} - 1 \wedge \sim_{\text{low}} = < \wedge \sim_{\text{up}} = <$  evaluated to true. Therefore, we know  $-z_{\text{low}} = z_{\text{up}} - 1$ ,  $\sim_{\text{low}} = <$ , and  $\sim_{\text{up}} = <$ . Moreover, since we know that  $(z_{\text{low}}, \sim_{\text{low}}) = M[0][m]$ , we know that all clock valuations in  $[M]$  fulfill

$$\begin{aligned} 0 - C[m] &\sim_{\text{low}} z_{\text{low}} \\ \Leftrightarrow -C[m] &< z_{\text{low}} \\ \Leftrightarrow C[m] &> -z_{\text{low}}. \end{aligned}$$

Since the same can be shown for  $(z_{\text{up}}, \sim_{\text{up}}) = M[i][0]$ , we know that all clock valuations fulfill  $z_{\text{low}} < u(C[j]) < z_{\text{up}}$  with  $-z_{\text{low}} = z_{\text{up}} - 1$  and the statement is implied.

2. By the induction hypothesis, we know that  $\forall j \in [0, l - 1] : \forall z_{\text{up}} \in \mathbb{N}^{\geq 0} : (z_{\text{up}} \leq k(C[j]) \wedge \forall u \in [M] : z_{\text{up}} - 1 < u(C[j]) < z_{\text{up}})$  implies  $(j \in \text{clocks})$  holds. Therefore, to show the induction step, we only need to show  $\forall z_{\text{up}} \in \mathbb{N}^{\geq 0} : (z_{\text{up}} \leq k(C[l]) \wedge \forall u \in [M] : z_{\text{up}} - 1 < u(C[l]) < z_{\text{up}})$  implies  $(l \in \text{clocks})$ . If  $(z_{\text{up}} \leq k(C[l]) \wedge \forall u \in [M] : z_{\text{up}} - 1 < u(C[l]) < z_{\text{up}})$  does not hold, the statement holds trivially. Therefore, we only consider the case in which  $(z_{\text{up}} \leq k(C[l]) \wedge \forall u \in [M] : z_{\text{up}} - 1 < u(C[l]) < z_{\text{up}})$  holds. Since  $M$  is canonic and  $z_{\text{low}}, z_{\text{up}} \in \mathbb{Z}^{\geq 0}$ ,  $(z_{\text{up}} \leq k(C[l]) \wedge \forall u \in [M] : z_{\text{up}} - 1 < u(C[l]) < z_{\text{up}})$  implies that the condition of the if-statement evaluates to true and  $l$  is added to clocks. Therefore,  $\forall z_{\text{up}} \in \mathbb{N}^{\geq 0} : (z_{\text{up}} \leq k(C[l]) \wedge \forall u \in [M] : z_{\text{up}} - 1 < u(C[l]) < z_{\text{up}})$  implies  $(l \in \text{clocks})$  holds and the induction step is implied.

Therefore, after the first loop is run,

1.  $\forall j \in \text{clocks} : \exists z_{\text{up}} \in \mathbb{N}^{\geq 0} : \forall u \in [M] : z_{\text{up}} - 1 < u(C[j]) < z_{\text{up}}$  and
2.  $\forall j \in [0, |C| - 1] : \forall z_{\text{up}} \in \mathbb{N}^{\geq 0} : (z_{\text{up}} \leq k(C[j]) \wedge \forall u \in [M] : z_{\text{up}} - 1 < u(C[j]) < z_{\text{up}})$  implies  $(j \in \text{clocks})$

holds. We now analyze the second loop. To do so, we start with the inner loop and afterwards analyze the outer loop. The inner loop runs exactly  $[|\text{clocks}| - i - 1]$  times. Therefore, the inner loop terminates. To show correctness of the inner loop, we define the following precondition and invariant:

**Precondition:** Before the loop is run, we assume that  $k \in (C \rightarrow \mathbb{N}^{\geq 0})$  is a function,  $M \in \mathcal{M}(C)$  is a canonic DBM,  $\text{clocks}$  is a list such that

1.  $\forall j \in \text{clocks} : \exists z_{\text{up}} \in \mathbb{N}^{\geq 0} : \forall u \in [M] : z_{\text{up}} - 1 < u(C[j]) < z_{\text{up}}$  and
2.  $\forall j \in [0, |C| - 1] : \forall z_{\text{up}} \in \mathbb{N}^{\geq 0} : (z_{\text{up}} \leq k(C[j]) \wedge \forall u \in [M] : z_{\text{up}} - 1 < u(C[j]) < z_{\text{up}})$  implies  $(j \in \text{clocks})$

holds,  $i \in [0, |\text{clocks}| - 2]$ , and  $\text{result} \in \mathcal{D}(C)^*$  is a list of zones with

1.  $\forall D_m \in \text{result} : D_m \neq \emptyset$ ,
2.  $\bigcup_{D_{\text{cur}} \in \text{result}} D_{\text{cur}} = [M]$ ,
3.  $\forall i, j \in [0, |\text{result}| - 1] : D_i \cap D_j \neq \emptyset$  implies  $i = j$ ,
4.  $\forall m \in [0, i] : \forall p \in \text{clocks} : \forall D_q \in \text{result} : \forall u_1, u_2 \in D_q : \text{frac}(u_1(C[\text{clocks}[m]])) \leq \text{frac}(u_1(C[p])) \Leftrightarrow \text{frac}(u_2(C[\text{clocks}[m]])) \leq \text{frac}(u_2(C[p]))$ , and
5.  $\forall D_m, D_{m'} \in \text{result} : (\exists u_m \in D_m : \exists u_{m'} \in D_{m'} : u_m \simeq_k u_{m'})$  implies  $(D_m = D_{m'})$ .

**Invariant:** After  $l$  iteration,  $\text{result} = [D_0, \dots, D_n]$  with

1.  $\forall D_m \in \text{result} : D_m \neq \emptyset$ ,
2.  $\bigcup_{m \in [0, n]} D_m = [M]$ ,
3.  $\forall m, m' \in [0, n] : D_m \cap D_{m'} \neq \emptyset$  implies  $m = m'$ ,
4.  $\forall m \in [0, i] : \forall p \in \text{clocks} : \forall q \in [0, n] : \forall u_1, u_2 \in D_q : \text{frac}(u_1(C[\text{clocks}[m]])) \leq \text{frac}(u_1(C[p])) \Leftrightarrow \text{frac}(u_2(C[\text{clocks}[m]])) \leq \text{frac}(u_2(C[p]))$ ,
5.  $\forall m \in [0, i+l] : \forall q \in [0, n] : \forall u_1, u_2 \in D_q : \text{frac}(u_1(C[\text{clocks}[i]])) \leq \text{frac}(u_1(C[\text{clocks}[m]])) \Leftrightarrow \text{frac}(u_2(C[\text{clocks}[i]])) \leq \text{frac}(u_2(C[\text{clocks}[m]]))$ ,
6.  $\forall m, m' \in [0, n] : (\exists u_m \in D_m : \exists u_{m'} \in D_{m'} : u_m \simeq_k u_{m'})$  implies  $(m = m')$ .

We show this invariant by induction.

**Base Case:** The invariant holds for  $l = 0$ .

**Induction Step:** If the invariant holds after  $l$  iteration, it also holds after  $l + 1$  iteration.

We first show the base case. We show one statement after the other. After zero iteration

1.  $\forall D_m \in \text{result} : D_m \neq \emptyset$  holds by the precondition,
2.  $\bigcup_{m \in [0, n]} D_m = [M]$  holds by the precondition,

3.  $\forall m, m' \in [0, n] : D_m \cap D_{m'} \neq \emptyset$  implies  $m = m'$  holds by the precondition,
4.  $\forall m \in [0, i] : \forall p \in \text{clocks} : \forall q \in [0, n] : \forall u_1, u_2 \in D_q : \text{frac}(u_1(C[\text{clocks}[m]])) \leq \text{frac}(u_1(C[p])) \Leftrightarrow \text{frac}(u_2(C[\text{clocks}[m]])) \leq \text{frac}(u_2(C[p]))$  holds by the precondition,
5.  $\forall m \in [0, i+l] : \forall q \in [0, n] : \forall u_1, u_2 \in D_q : \text{frac}(u_1(C[\text{clocks}[i]])) \leq \text{frac}(u_1(C[\text{clocks}[m]])) \Leftrightarrow \text{frac}(u_2(C[\text{clocks}[i]])) \leq \text{frac}(u_2(C[\text{clocks}[m]]))$  holds since the interval  $[0, i]$  holds by the precondition and the interval  $[i+1, i+l]$  is empty for  $l = 0$ , and
6.  $\forall m, m' \in [0, n] : (\exists u_m \in D_m : \exists u_{m'} \in D_{m'} : u_m \simeq_k u_{m'})$  implies  $(m = m')$  holds by the precondition.

Now we show the induction step. We assume result to have the length  $n'$  after  $l+1$  iteration. Once again, we show one statement after the other.

1.  $\forall D_m \in \text{result} : D_m \neq \emptyset$  obviously holds, since the second statement in the loop removes all empty zones,
2.  $\bigcup_{m \in [0, n']} D_m = D$  holds, since we know by the induction hypothesis that this statement holds before the  $l+1$ th iteration, by Proposition S.3 we know that CREATE-FRAC-ORDER does not add or remove any clock valuation and the same holds for the second statement of the inner loop,
3.  $\forall m, m' \in [0, n'] : D_m \cap D_{m'} \neq \emptyset$  implies  $m = m'$  holds by the induction hypothesis, which ensures that all elements before the  $l+1$ th iteration are disjoint, and by Proposition S.3, which ensures that no resulting zone of CREATE-FRAC-ORDER overlaps with any other resulting zone,
4.  $\forall m \in [0, i] : \forall p \in \text{clocks} : \forall q \in [0, n'] : \forall u_1, u_2 \in D_q : \text{frac}(u_1(C[\text{clocks}[m]])) \leq \text{frac}(u_1(C[p])) \Leftrightarrow \text{frac}(u_2(C[\text{clocks}[m]])) \leq \text{frac}(u_2(C[p]))$  holds since we know by the induction hypothesis that this statement holds before the  $l+1$ th iteration and Proposition S.3 ensures that any resulting zone is a subzone of any previous zone. Obviously, if  $\forall u_1, u_2 \in D_q : \text{frac}(u_1(C[\text{clocks}[m]])) \leq \text{frac}(u_1(C[p])) \Leftrightarrow \text{frac}(u_2(C[\text{clocks}[m]])) \leq \text{frac}(u_2(C[p]))$  holds for any  $D_q$ , then the same holds for any zone  $D_{\text{sub}} \subseteq D_q$  and, therefore, this statement holds,
5. by the previous statement,

$$\forall m \in [0, i] : \forall q \in [0, n'] : \forall u_1, u_2 \in D_q :$$

$$\text{frac}(u_1(C[\text{clocks}[i]])) \leq \text{frac}(u_1(C[m])) \Leftrightarrow \text{frac}(u_2(C[\text{clocks}[i]])) \leq \text{frac}(u_2(C[\text{clocks}[m]]))$$

holds. Moreover, by the induction hypothesis and by Proposition S.3, we know that  $\forall m \in [i+1, i+l] : \forall q \in [0, n'] : \forall u_1, u_2 \in D_q : \text{frac}(u_1(C[\text{clocks}[i]])) \leq \text{frac}(u_1(C[m])) \Leftrightarrow \text{frac}(u_2(C[\text{clocks}[i]])) \leq \text{frac}(u_2(C[\text{clocks}[m]]))$  holds. Therefore, we only have to show  $\forall q \in [0, n'] : \forall u_1, u_2 \in D_q : \text{frac}(u_1(C[\text{clocks}[i]])) \leq \text{frac}(u_1(C[\text{clocks}[i+l+1]])) \Leftrightarrow \text{frac}(u_2(C[\text{clocks}[i]])) \leq \text{frac}(u_2(C[\text{clocks}[i+l+1]]))$ .

By Proposition S.3, we know that after the  $l+1$ th iteration for any zone  $D_{\text{res}} \in \text{result}$

$$\bullet D_{\text{res}} \wedge z_1 - z_2 = (C[\text{clocks}[i]] - C[\text{clocks}[i+l+1]]) = D_{\text{res}},$$



- $D_{\text{res}} \wedge z_1 - z_2 > (C[\text{clocks}[i]] - C[\text{clocks}[i + l + 1]]) = D_{\text{res}}$ , or
- $D_{\text{res}} \wedge z_1 - z_2 < (C[\text{clocks}[i]] - C[\text{clocks}[i + l + 1]]) = D_{\text{res}}$

holds, with  $z_1 \in \mathbb{N}^{\geq 0}$  being the upper and  $z_1 - 1$  being the lower bound of any clock valuation for  $C[\text{clocks}[i]]$  and  $z_2 \in \mathbb{N}^{\geq 0}$  being the upper and  $z_2 - 1$  being the lower bound of any clock valuation for  $C[\text{clocks}[i + l + 1]]$ . We distinguish these three cases.

- (a)  $D_{\text{res}} \wedge z_1 - z_2 = (C[\text{clocks}[i]] - C[\text{clocks}[i + l + 1]]) = D_{\text{res}}$ . Since  $z_1$  and  $z_2$  are integers,  $z_1 - z_2$  is also an integer and, therefore,  $\text{frac}(z_1 - z_2) = 0$ . This can only be the case, if and only if for all clock valuations  $u_{\text{res}} \in D_{\text{res}}$  the statement  $u_{\text{res}}(C[\text{clocks}[i]]) = u_{\text{res}}(C[\text{clocks}[i + l + 1]])$  holds. Therefore,  $\forall u_1, u_2 \in D_{\text{res}} : \text{frac}(u_1(C[\text{clocks}[i]])) \leq \text{frac}(u_1(C[\text{clocks}[i + l + 1]])) \Leftrightarrow \text{frac}(u_2(C[\text{clocks}[i]])) \leq \text{frac}(u_2(C[\text{clocks}[i + l + 1]]))$  obviously holds,
- (b)  $D_{\text{res}} \wedge z_1 - z_2 > (C[\text{clocks}[i]] - C[\text{clocks}[i + l + 1]]) = D_{\text{res}}$ . We remind the reader of the fact that for any clock valuation  $u_{\text{res}} \in D_{\text{res}}$  the statements  $\lfloor u_{\text{res}}(C[\text{clocks}[i]]) \rfloor = z_1 - 1$  and  $\lfloor u_{\text{res}}(C[\text{clocks}[i + l + 1]]) \rfloor = z_2 - 1$  hold. We can show

$$\begin{aligned} & z_1 - z_2 > (u_{\text{res}}(C[\text{clocks}[i]]) - u_{\text{res}}(C[\text{clocks}[i + l + 1]])) \\ \Leftrightarrow & z_1 - z_2 > (z_1 - 1 + \text{frac}(u_{\text{res}}(C[\text{clocks}[i]])) - z_2 + 1 - \text{frac}(u_{\text{res}}(C[\text{clocks}[i + l + 1]]))) \\ \Leftrightarrow & 0 > \text{frac}(u_{\text{res}}(C[\text{clocks}[i]])) - \text{frac}(u_{\text{res}}(C[\text{clocks}[i + l + 1]])) \\ \Leftrightarrow & \text{frac}(u_{\text{res}}(C[\text{clocks}[i + l + 1]])) > \text{frac}(u_{\text{res}}(C[\text{clocks}[i]])), \end{aligned}$$

Therefore, for all  $u_{\text{res}} \in D_{\text{res}}$ , the statement  $\text{frac}(u_{\text{res}}(C[\text{clocks}[i + l + 1]])) > \text{frac}(u_{\text{res}}(C[\text{clocks}[i]]))$  holds, which implies  $\forall u_1, u_2 \in D_{\text{res}} : \text{frac}(u_1(C[\text{clocks}[i]])) \leq \text{frac}(u_1(C[\text{clocks}[i + l + 1]])) \Leftrightarrow \text{frac}(u_2(C[\text{clocks}[i]])) \leq \text{frac}(u_2(C[\text{clocks}[i + l + 1]]))$ ,

- (c)  $D_{\text{res}} \wedge z_1 - z_2 < (C[\text{clocks}[i]] - C[\text{clocks}[i + l + 1]]) = D_{\text{res}}$ . Analogously to the previous case, we can show that for all  $u_{\text{res}} \in D_{\text{res}}$ , the statement  $\text{frac}(u_{\text{res}}(C[\text{clocks}[i + l + 1]])) < \text{frac}(u_{\text{res}}(C[\text{clocks}[i]]))$  holds, which implies  $\forall u_1, u_2 \in D_{\text{res}} : \text{frac}(u_1(C[\text{clocks}[i]])) \leq \text{frac}(u_1(C[\text{clocks}[i + l + 1]])) \Leftrightarrow \text{frac}(u_2(C[\text{clocks}[i]])) \leq \text{frac}(u_2(C[\text{clocks}[i + l + 1]]))$ ,
6.  $\forall m, m' \in [0, n'] : (\exists u_m \in D_m : \exists u_{m'} \in D_{m'} : u_m \simeq_k u_{m'})$  implies  $(m = m')$ . If  $(\exists u_m \in D_m : \exists u_{m'} \in D_{m'} : u_m \simeq_k u_{m'})$  does not hold, the statement holds trivially. Therefore, for any  $m, m'$  we assume  $\exists u_m \in D_m : \exists u_{m'} \in D_{m'} : u_m \simeq_k u_{m'}$ . By the induction hypothesis, we know that  $u_m$  and  $u_{m'}$  were in the same zone before the  $l + 1$ th iteration. Since we know by Alur and Dill [16] that two region equivalent clock valuations both fulfill  $z_1 - z_2 = (C[\text{clocks}[i]] - C[\text{clocks}[i + l + 1]])$ ,  $z_1 - z_2 < (C[\text{clocks}[i]] - C[\text{clocks}[i + l + 1]])$ , or  $z_1 - z_2 > (C[\text{clocks}[i]] - C[\text{clocks}[i + l + 1]])$  (both fulfill the same!), we know that they are in the same zone afterwards, too.

Therefore, the invariant holds. Therefore, if the shown precondition holds, we know that after the inner loop terminates,  $\text{result} = [D_0, \dots, D_n]$  with

1.  $\forall D_m \in \text{result} : D_m \neq \emptyset$ ,

2.  $\bigcup_{m \in [0, n]} D_m = [M]$ ,
3.  $\forall m, m' \in [0, n] : D_m \cap D_{m'} \neq \emptyset$  implies  $m = m'$ ,
4.  $\forall m \in [0, i] : \forall p \in \text{clocks} : \forall q \in [0, n] : \forall u_1, u_2 \in D_q : \text{frac}(u_1(C[\text{clocks}[m]])) \leq \text{frac}(u_1(C[p])) \Leftrightarrow \text{frac}(u_2(C[\text{clocks}[m]])) \leq \text{frac}(u_2(C[p]))$ ,
5.  $\forall m \in [0, |\text{clocks}| - 1] : \forall q \in [0, n] : \forall u_1, u_2 \in D_q : \text{frac}(u_1(C[\text{clocks}[i]])) \leq \text{frac}(u_1(C[\text{clocks}[m]])) \Leftrightarrow \text{frac}(u_2(C[\text{clocks}[i]])) \leq \text{frac}(u_2(C[\text{clocks}[m]]))$ ,
6.  $\forall m, m' \in [0, n] : (\exists u_m \in D_m : \exists u_{m'} \in D_{m'} : u_m \simeq_k u_{m'})$  implies  $(m = m')$ .

holds. We now analyze the outer loop. The outer loop iterates exactly  $|\text{clocks}| - 1$  times (if clocks is empty, it iterates zero times) and, therefore, terminates. To show correctness of the outer loop, we define the following precondition and invariant.

**Precondition:** Before the loop is run, we assume that  $k \in (C \rightarrow \mathbb{N}^{\geq 0})$  is a function,  $M \in \mathcal{M}(C)$  is a canonic DBM, clocks is a list such that

1.  $\forall j \in \text{clocks} : \exists z_{\text{up}} \in \mathbb{N}^{\geq 0} : \forall u \in [M] : z_{\text{up}} - 1 < u(C[j]) < z_{\text{up}}$  and
2.  $\forall j \in [0, |C| - 1] : \forall z_{\text{up}} \in \mathbb{N}^{\geq 0} : (z_{\text{up}} \leq k(C[j]) \wedge \forall u \in [M] : z_{\text{up}} - 1 < u(C[j]) < z_{\text{up}})$  implies  $(j \in \text{clocks})$

holds and result =  $[ [M] ]$  holds.

**Invariant:** After  $l$  iterations, result =  $[D_0, \dots, D_n]$  with

1.  $\forall i \in [0, n] : D_i \neq \emptyset$ ,
2.  $\bigcup_{i \in [0, n]} D_i = [M]$ ,
3.  $\forall i, j \in [0, n] : D_i \cap D_j \neq \emptyset$  implies  $i = j$ ,
4.  $\forall i \in [0, n] : \forall m \in [0, l - 1] : \forall p \in \text{clocks} : (\forall u_1, u_2 \in D_i : \text{frac}(u_1(C[\text{clocks}[m]])) \leq \text{frac}(u_1(C[\text{clocks}[p]])) \Leftrightarrow \text{frac}(u_2(C[\text{clocks}[m]])) \leq \text{frac}(u_2(C[\text{clocks}[p]]))$ ,
5.  $\forall i, j \in [0, n] : (\exists u_i \in D_i : \exists u_j \in D_j : u_i \simeq_k u_j)$  implies  $(i = j)$ .

We show this invariant by induction.

**Base Case:** The invariant holds after zero iteration.

**Induction Step:** If the invariant holds after  $l$  iteration, it also holds after  $l + 1$  iteration.

We first show the base case. We show one statement after the other.

1.  $\forall i \in [0, n] : D_i \neq \emptyset$  holds by the precondition, since result has exactly a single element,  $[M]$ , which we assumed to be non-empty,
2.  $\bigcup_{i \in [0, n]} D_i = [M]$  holds by the precondition,
3.  $\forall i, j \in [0, n] : D_i \cap D_j \neq \emptyset$  implies  $i = j$  holds, since  $i = 0 = j$  always holds,

4.  $\forall i \in [0, n] : \forall m \in [0, l - 1] : \forall p \in \text{clocks} : (\forall u_1, u_2 \in D_i : \text{frac}(u_1(C[\text{clocks}[m]])) \leq \text{frac}(u_1(C[\text{clocks}[p]])) \Leftrightarrow \text{frac}(u_2(C[\text{clocks}[m]])) \leq \text{frac}(u_2(C[\text{clocks}[p]]))$  holds since the interval  $[0, l - 1]$  is empty for  $l = 0$ ,
5.  $\forall i, j \in [0, n] : (\exists u_i \in D_i : \exists u_j \in D_j : u_i \simeq_k u_j)$  implies  $(i = j)$  holds, since  $i = 0 = j$  always holds.

We now show the induction step. To do so, we first show that the preconditions for the inner loop analysis always hold and afterwards we show one statement after the other.

The inner loop analysis assumes that before the loop is run,

- $k \in (C \rightarrow \mathbb{N}^{\geq 0})$  is a function holds by the precondition of the outer loop analysis,
- $M \in \mathcal{M}(C)$  is a canonic DBM holds by the precondition of the outer loop analysis,
- $\text{clocks}$  is a list such that
  1.  $\forall j \in \text{clocks} : \exists z_{\text{up}} \in \mathbb{N}^{\geq 0} : \forall u \in [M] : z_{\text{up}} - 1 < u(C[j]) < z_{\text{up}}$  and
  2.  $\forall j \in [0, |C| - 1] : \forall z_{\text{up}} \in \mathbb{N}^{\geq 0} : (z_{\text{up}} \leq k(C[j]) \wedge \forall u \in [M] : z_{\text{up}} - 1 < u(C[j]) < z_{\text{up}})$  implies  $(j \in \text{clocks})$

holds by the precondition of the outer loop analysis,

- $i \in [0, |\text{clocks}| - 2]$  holds since the outer loop iterates  $i$  through  $[0, |\text{clocks}| - 2]$ , and
- $\text{result} \in \mathcal{D}(C)^*$  is a list of zones with
  1.  $\forall D_m \in \text{result} : D_m \neq \emptyset$ ,
  2.  $\bigcup_{D_{\text{cur}} \in \text{result}} D_{\text{cur}} = D$ ,
  3.  $\forall i, j \in [0, |\text{result}| - 1] : D_i \cap D_j \neq \emptyset$  implies  $i = j$ ,
  4.  $\forall m \in [0, i] : \forall p \in \text{clocks} : \forall D_q \in \text{result} : \forall u_1, u_2 \in D_q : \text{frac}(u_1(C[\text{clocks}[m]])) \leq \text{frac}(u_1(C[p])) \Leftrightarrow \text{frac}(u_2(C[\text{clocks}[m]])) \leq \text{frac}(u_2(C[p]))$ , and
  5.  $\forall D_m, D_{m'} \in \text{result} : (\exists u_m \in D_m : \exists u_{m'} \in D_{m'} : u_m \simeq_k u_{m'})$  implies  $(D_m = D_{m'})$ .

holds by the induction hypothesis of the outer loop analysis (remember:  $l = i - 1$ ).

Therefore, we can apply the inner loop analysis. To show the induction step, we show one statement after the other.

1.  $\forall i \in [0, n] : D_i \neq \emptyset$  holds due to the fact that this is the case after the inner loop is run (see the inner loop analysis),
2.  $\bigcup_{i \in [0, n]} D_i = [M]$  holds due to the fact that this is the case after the inner loop is run (see the inner loop analysis),
3.  $\forall i, j \in [0, n] : D_i \cap D_j \neq \emptyset$  implies  $i = j$  holds due to the fact that this is the case after the inner loop is run (see the inner loop analysis),

4.  $\forall i \in [0, n] : \forall m \in [0, l] : \forall p \in \text{clocks} : (\forall u_1, u_2 \in D_i : \text{frac}(u_1(C[\text{clocks}[m]])) \leq \text{frac}(u_1(C[\text{clocks}[p]])) \Leftrightarrow \text{frac}(u_2(C[\text{clocks}[m]])) \leq \text{frac}(u_2(C[\text{clocks}[p]]))$  holds due to the fact that this is the case after the inner loop is run (see the inner loop analysis),
5.  $\forall i, j \in [0, n] : (\exists u_i \in D_i : \exists u_j \in D_j : u_i \simeq_k u_j)$  implies  $(i = j)$  holds due to the fact that this is the case after the inner loop is run (see the inner loop analysis).

Therefore, the invariant holds and after the outer loop is run,

1.  $\forall i \in [0, n] : D_i \neq \emptyset$ ,
2.  $\bigcup_{i \in [0, n]} D_i = [M]$ ,
3.  $\forall i, j \in [0, n] : D_i \cap D_j \neq \emptyset$  implies  $i = j$ ,
4.  $\forall i \in [0, n] : \forall m \in [0, |\text{clocks}| - 2] : \forall p \in \text{clocks} : (\forall u_1, u_2 \in D_i : \text{frac}(u_1(C[\text{clocks}[m]])) \leq \text{frac}(u_1(C[\text{clocks}[p]])) \Leftrightarrow \text{frac}(u_2(C[\text{clocks}[m]])) \leq \text{frac}(u_2(C[\text{clocks}[p]]))$ ,
5.  $\forall i, j \in [0, n] : (\exists u_i \in D_i : \exists u_j \in D_j : u_i \simeq_k u_j)$  implies  $(i = j)$ .

To show that ORDER-FRAC-IMPL is an order-frac operator (if  $[M] = D$ ), we now compare the result of the outer loop with the properties of an order-frac operator. Since they are all exactly the same, except the fourth property, we only compare the fourth property of the outer loop analysis with the fourth property of Definition S.2.

After the outer loop terminates,  $\forall i \in [0, n] : \forall m \in [0, |\text{clocks}| - 2] : \forall p \in \text{clocks} : (\forall u_1, u_2 \in D_i : \text{frac}(u_1(C[\text{clocks}[m]])) \leq \text{frac}(u_1(C[\text{clocks}[p]])) \Leftrightarrow \text{frac}(u_2(C[\text{clocks}[m]])) \leq \text{frac}(u_2(C[\text{clocks}[p]]))$  holds. By the precondition (and the analysis of the first loop), we know that  $\text{clocks}$  is a list such that

1.  $\forall j \in \text{clocks} : \exists z_{\text{up}} \in \mathbb{N}^{\geq 0} : \forall u \in [M] : z_{\text{up}} - 1 < u(C[j]) < z_{\text{up}}$  and
2.  $\forall j \in [0, |C| - 1] : \forall z_{\text{up}} \in \mathbb{N}^{\geq 0} : (z_{\text{up}} \leq k(C[j]) \wedge \forall u \in [M] : z_{\text{up}} - 1 < u(C[j]) < z_{\text{up}})$  implies  $(j \in \text{clocks})$ .

Therefore,

$$\begin{aligned}
& \forall i \in [0, n] : \forall m \in [0, |\text{clocks}| - 2] : \forall p \in \text{clocks} : \\
& \quad (\forall u_1, u_2 \in D_i : \text{frac}(u_1(C[\text{clocks}[m]])) \leq \text{frac}(u_1(C[\text{clocks}[p]])) \\
& \quad \Leftrightarrow \text{frac}(u_2(C[\text{clocks}[m]])) \leq \text{frac}(u_2(C[\text{clocks}[p]])) \\
& \Leftrightarrow \forall i \in [0, n] : c, c' \in C : \\
& \quad \neg(c \in \text{clocks} \wedge c' \in \text{clocks}) \vee \\
& \quad (\forall u_1, u_2 \in D_i : \text{frac}(u_1(C[\text{clocks}[m]])) \leq \text{frac}(u_1(C[\text{clocks}[p]])) \\
& \quad \Leftrightarrow \text{frac}(u_2(C[\text{clocks}[m]])) \leq \text{frac}(u_2(C[\text{clocks}[p]])) \\
& \Leftrightarrow \forall i \in [0, n] : c, c' \in C : \\
& \quad \neg(\exists m \in \mathbb{N}^{\geq 0} : \forall u \in D_i : m \leq k(c) \wedge m - 1 < u(c) < m \wedge \\
& \quad \exists m' \in \mathbb{N}^{\geq 0} : \forall u \in D_i : m' \leq k(c') \wedge m' - 1 < u(c') < m') \vee
\end{aligned}$$

$$\begin{aligned}
& (\forall u_1, u_2 \in D_i : \text{frac}(u_1(C[\text{clocks}[m]])) \leq \text{frac}(u_1(C[\text{clocks}[p]]))) \\
& \quad \Leftrightarrow \text{frac}(u_2(C[\text{clocks}[m]])) \leq \text{frac}(u_2(C[\text{clocks}[p]])) \\
\Leftrightarrow \forall i \in [0, n] : c, c' \in C : \\
& \quad (\exists m \in \mathbb{N}^{\geq 0} : \forall u \in D_i : m \leq k(c) \wedge m - 1 < u(c) < m \\
& \quad \quad \wedge \exists m' \in \mathbb{N}^{\geq 0} : \forall u \in D_i : m' \leq k(c') \wedge m' - 1 < u(c') < m') \text{ implies} \\
& \quad (\forall u_1, u_2 \in D_i : \text{frac}(u_1(C[\text{clocks}[m]])) \leq \text{frac}(u_1(C[\text{clocks}[p]]))) \\
& \quad \Leftrightarrow \text{frac}(u_2(C[\text{clocks}[m]])) \leq \text{frac}(u_2(C[\text{clocks}[p]])).
\end{aligned}$$

Since the last statement is equivalent to the fourth statement of Definition S.2, Proposition S.4 holds.  $\square$

Therefore, we can define an operator which takes a zone and outputs the included regions.

**Definition S.3. (extract-regions operator)**

Let  $C$  be a set of clocks,  $k \in (C \rightarrow \mathbb{N}^{\geq 0})$  be a function, and  $D \in \mathcal{D}(C)$  be a zone. We define the operator

$$\text{extract-regions} : \mathcal{D}(C) \times (C \rightarrow \mathbb{N}^{\geq 0}) \rightarrow \mathcal{D}(C)^*$$

such that

$$\text{extract-regions}(D, k) = [D_0, \dots, D_n]$$

with

1.  $\forall i \in [0, n] : D_i \neq \emptyset$ ,
2.  $\bigcup_{i \in [0, n]} D_i = D$ ,
3.  $\forall i, j \in [0, n] : D_i \cap D_j \neq \emptyset$  implies  $i = j$ ,
4.  $\forall u_1, u_2 \in D : ((u_1 \simeq_k u_2) \Leftrightarrow (\exists i \in [0, n] : u_1, u_2 \in D_i))$ .

Using the split-clock-values and the order-frac operator, we can calculate the extract-regions operator.

**Proposition S.5. (Implementing extract-regions)**

Let  $C$  be a set of clocks,  $k \in (C \rightarrow \mathbb{N}^{\geq 0})$  be a function, and  $D \in \mathcal{D}(C)$  be a zone. The function

$$\text{EXTRACT-REGIONS-IMPL} : \mathcal{D}(C) \times (C \rightarrow \mathbb{N}^{\geq 0}) \rightarrow \mathcal{D}(C)^*$$

$$\text{EXTRACT-REGIONS-IMPL}(D, k) = \text{APPLY-ORDER-FRAC}(\text{split-clock-values}(0, D, k), k)$$

with

$$\text{APPLY-ORDER-FRAC} : \mathcal{D}(C)^* \rightarrow \mathcal{D}(C)^*$$

being defined as

$$\text{APPLY-ORDER-FRAC}(\text{lo-zones}, k) = \begin{cases} [], & \text{if lo-zones} = [], \\ \text{order-frac}(\text{lo-zones}[0], k) \circ & \\ \text{apply-order-frac}(\text{lo-zones} \setminus \text{lo-zones}[0], k), & \text{else} \end{cases}$$

is an extract-regions operator.

**Proof:**

To show this proposition, we first analyze the APPLY-ORDER-FRAC function. Since this function is recursive, we show termination and correctness.

Since there is exactly a single recursive call for each element of lo-zones, APPLY-ORDER-FRAC terminates. To show correctness, we define the following precondition and invariant:

**Precondition:** Before APPLY-ORDER-FRAC is called, lo-zones should be a list of zones  $[D_{0,\text{loz}}, \dots, D_{m,\text{loz}}]$  such that

1.  $\forall i \in [0, m] : D_{i,\text{loz}} \neq \emptyset$ ,
2.  $\forall i, j \in [0, n] : D_i \cap D_j \neq \emptyset$  implies  $i = j$ ,
3.  $\forall i \in [0, n] : \forall c \in C : \exists m \in \mathbb{N}^{\geq 0} : (D_i \wedge (c = m) = D_i) \vee (D_i \wedge (m - 1 < c < m) = D_i) \vee (D_i \wedge (c > k(c)) = D_i)$ ,
4.  $\forall i, j \in [0, n] : (\exists u_i \in D_i : \exists u_j \in D_j : u_i \simeq_k u_j)$  implies  $(i = j)$ .

holds.

**Invariant:** After  $l$  recursive calls, APPLY-ORDER-FRAC returns a list  $[D_0, \dots, D_n]$ , such that

1.  $\forall i \in [0, n] : D_i \neq \emptyset$ ,
2.  $\bigcup_{i \in [0, n]} D_i = \bigcup_{i \in [m-(l-1), m]} D_{i,\text{loz}}$ ,
3.  $\forall i \in [0, n] : \exists j \in [0, m] : D_i \subseteq D_{j,\text{loz}}$ ,
4.  $\forall i, j \in [0, n] : D_i \cap D_j \neq \emptyset$  implies  $i = j$ ,
5.  $\forall i \in [0, n] : c, c' \in C : (\exists m, m' \in \mathbb{N}^{\geq 0} : \forall u \in D_i : m \leq k(c) \wedge m' \leq k(c') \wedge m - 1 < u(c) < m \wedge m' - 1 < u(c') < m')$  implies  $(\forall u_1, u_2 \in D_i : \text{frac}(u_1(c)) \leq \text{frac}(u_1(c')) \Leftrightarrow \text{frac}(u_2(c)) \leq \text{frac}(u_2(c')))$ ,
6.  $\forall i, j \in [0, n] : (\exists u_i \in D_i : \exists u_j \in D_j : u_i \simeq_k u_j)$  implies  $(i = j)$ .

holds. We show this invariant by induction.

**Base Case:** If no recursive call happens, the invariant holds.

**Induction Step:** If the invariant holds if  $l$  recursive calls happen, then it also holds if  $l + 1$  recursive calls happen.

We first show the base case. If no recursive call happens, lo-zones = [] holds and the returned value is also the empty list []. We show one statement after the other.

1.  $\forall i \in [0, n] : D_i \neq \emptyset$  holds since the returned list is empty and, therefore,  $[0, n]$  is an empty interval,
2.  $\bigcup_{i \in [0, n]} D_i = \emptyset = \bigcup_{i \in [m-(l-1), m]} D_{i, \text{loz}}$  holds,
3.  $\forall i \in [0, n] : \exists j \in [0, m] : D_i \subseteq D_{j, \text{loz}}$  holds since the returned list is empty and, therefore,  $[0, n]$  is an empty interval,
4.  $\forall i, j \in [0, n] : D_i \cap D_j \neq \emptyset$  implies  $i = j$  holds since the returned list is empty and, therefore,  $[0, n]$  is an empty interval,
5.  $\forall i \in [0, n] : c, c' \in C : (\exists m, m' \in \mathbb{N}^{\geq 0} : \forall u \in D_i : m \leq k(c) \wedge m' \leq k(c') \wedge m - 1 < u(c) < m \wedge m' - 1 < u(c') < m')$  implies  $(\forall u_1, u_2 \in D_i : \text{frac}(u_1(c)) \leq \text{frac}(u_1(c')) \Leftrightarrow \text{frac}(u_2(c)) \leq \text{frac}(u_2(c')))$  holds since the returned list is empty and, therefore,  $[0, n]$  is an empty interval,
6.  $\forall i, j \in [0, n] : (\exists u_i \in D_i : \exists u_j \in D_j : u_i \simeq_k u_j)$  implies  $(i = j)$  holds since the returned list is empty and, therefore,  $[0, n]$  is an empty interval.

Therefore, the base case holds and we now show the induction step. Each step calls the order-frac operator on the next zone of lo-zones and concatenates it to the result of the recursive call. Therefore, the result of the next recursive call is unchanged. We show one statement of the invariant after the other. With  $n' \in \mathbb{N}^{\geq 0}$  we denote the length of the result after  $l$  recursive calls.

1.  $\forall i \in [0, n] : D_i \neq \emptyset$  holds by the induction hypothesis and Definition S.2,
2. By the induction hypothesis, we know that after  $l$  recursive calls,  $\bigcup_{i \in [n-n', n]} D_i = \bigcup_{i \in [m-l+1, m]} D_{i, \text{loz}}$  holds. Therefore, we only have to show that  $\bigcup_{i \in [0, n-n'-1]} D_i = D_{m-l}$ . Since the  $l + 1$ th recursive step calls  $\text{order-frac}(D_{m-l}, k)$  and the result is equal to  $[D_0, D_{n-n'-1}]$ ,  $\bigcup_{i \in [0, n]} D_i = \bigcup_{i \in [m-l, m]} D_{i, \text{loz}}$  holds after  $l + 1$  recursion steps,
3.  $\forall i \in [0, n] : \exists j \in [0, m] : D_i \subseteq D_{j, \text{loz}}$  holds by the induction hypothesis and Definition S.2,
4.  $\forall i, j \in [0, n] : D_i \cap D_j \neq \emptyset$  implies  $i = j$  holds by the induction hypothesis and Definition S.2,
5.  $\forall i \in [0, n] : c, c' \in C : (\exists m, m' \in \mathbb{N}^{\geq 0} : \forall u \in D_i : m \leq k(c) \wedge m' \leq k(c') \wedge m - 1 < u(c) < m \wedge m' - 1 < u(c') < m')$  implies  $(\forall u_1, u_2 \in D_i : \text{frac}(u_1(c)) \leq \text{frac}(u_1(c')) \Leftrightarrow \text{frac}(u_2(c)) \leq \text{frac}(u_2(c')))$  holds by the induction hypothesis and Definition S.2,
6.  $\forall i, j \in [0, n] : (\exists u_i \in D_i : \exists u_j \in D_j : u_i \simeq_k u_j)$  implies  $(i = j)$  holds by the induction hypothesis and Definition S.2.

Therefore, the invariant holds and after  $|\text{lo-zones}|$  recursive calls,

1.  $\forall i \in [0, n] : D_i \neq \emptyset$ ,
2.  $\bigcup_{i \in [0, n]} D_i = \bigcup_{i \in [0, m]} D_{i, \text{loz}}$ ,

3.  $\forall i \in [0, n] : \exists j \in [0, m] : D_i \subseteq D_{j, \text{loz}}$ ,
4.  $\forall i, j \in [0, n] : D_i \cap D_j \neq \emptyset$  implies  $i = j$ ,
5.  $\forall i \in [0, n] : c, c' \in C : (\exists m, m' \in \mathbb{N}^{\geq 0} : \forall u \in D_i : m \leq k(c) \wedge m' \leq k(c') \wedge m - 1 < u(c) < m \wedge m' - 1 < u(c') < m')$  implies  $(\forall u_1, u_2 \in D_i : \text{frac}(u_1(c)) \leq \text{frac}(u_1(c')) \Leftrightarrow \text{frac}(u_2(c)) \leq \text{frac}(u_2(c')))$ ,
6.  $\forall i, j \in [0, n] : (\exists u_i \in D_i : \exists u_j \in D_j : u_i \simeq_k u_j)$  implies  $(i = j)$ .

holds. From now on, we call the previously shown statements the postcondition. Since the output of the split-clock-values operator is given to APPLY-ORDER-FRAC, the precondition holds. Therefore, we only have to show that the postcondition of the result of APPLY-ORDER-FRAC (which is also the result of EXTRACT-REGIONS-IMPL) imply the properties of the result of an extract-regions operator.

1. The first statement of Definition S.5 is equivalent to the first statement of the postcondition and, therefore, the first statement of Definition S.5 is fulfilled by EXTRACT-REGIONS-IMPL,
2. the second statement is fulfilled by  $\bigcup_{i \in [0, n]} D_i = \bigcup_{i \in [0, m]} D_{i, \text{loz}}$ , the fact that  $[D_0, \dots, D_{m, \text{loz}}]$  is the output of the split-clock-values operator and Definition S.1,
3. the third statement of Definition S.5 is obviously fulfilled by the third statement of the postcondition,
4. since  $\forall u_1, u_2 \in D : ((u_1 \simeq_k u_2) \text{ implies } (\exists i \in [0, n] : u_1, u_2 \in D_i))$  obviously holds by the postcondition, we only have to show  $\forall u_1, u_2 \in D : ((\exists i \in [0, n] : u_1, u_2 \in D_i) \text{ implies } (u_1 \simeq_k u_2))$ .

Since the statement holds obviously if the two clock valuations under investigation are not in the same zone, we assume them to be in the same zone and, therefore, the precondition of the implication holds. This means we have to show  $u_1 \simeq_k u_2$ . By Definition 2.5 this holds if and only if the three conditions of Definition 2.5 are fulfilled. We show one condition after the other.

- $\forall c \in C : ((\lfloor u_1(c) \rfloor = \lfloor u_2(c) \rfloor) \vee (u_1(c) > k(c) \wedge u_2(c) > k(c)))$ . By Definition S.1 and the third statement of the postcondition, we know that for any  $c \in C$  there exists a  $m \in \mathbb{N}^{\geq 0}$ , such that  $u_1, u_2 \models (c = m)$ ,  $u_1, u_2 \models (m - 1 < c < m)$ , or  $u_1, u_2 \models (c > k(c))$ . In the first case,  $\lfloor u_1(c) \rfloor = m = \lfloor u_2(c) \rfloor$  holds, in the second case,  $\lfloor u_1(c) \rfloor = m - 1 = \lfloor u_2(c) \rfloor$  holds, and in the third case  $u_1(c) > k(c) \wedge u_2(c) > k(c)$  holds. Therefore, the first condition is fulfilled,
- $\forall c, c' \in C : (u_1(c) \leq k(c) \wedge u_1(c') \leq k(c')) \text{ implies } (\text{frac}(u_1(c)) \leq \text{frac}(u_1(c')) \Leftrightarrow \text{frac}(u_2(c)) \leq \text{frac}(u_2(c')))$ . If  $u_1(c) \leq k(c) \wedge u_1(c') \leq k(c')$  does not hold, the statement holds trivially. Therefore, we assume the precondition to hold. Due to  $k(c).k(c') \in \mathbb{N}^{\geq 0}$  and the first condition, we know that if  $u_1(c) \leq k(c) \wedge u_1(c') \leq k(c')$  holds, then  $u_2(c) \leq k(c) \wedge u_2(c') \leq k(c')$  holds, too.

Analogously to the first case, we can follow that either  $u_1, u_2 \models (c = m)$  (respectively  $u_1, u_2 \models (c' = m')$ ) or  $u_1, u_2 \models (m - 1 < c < m)$  (respectively  $u_1, u_2 \models (m' - 1 < c' < m')$ ) hold. We distinguish the following case:



- $u_1, u_2 \models (c = m)$ . In this case,  $\text{frac}(u_1(c)) = \text{frac}(u_2(c)) = 0$  and, therefore  $\text{frac}(u_1(c)) \leq \text{frac}(u_1(c'))$ ,  $\text{frac}(u_2(c)) \leq \text{frac}(u_2(c'))$  are both true statements, which implies  $(\text{frac}(u_1(c)) \leq \text{frac}(u_1(c')) \Leftrightarrow \text{frac}(u_2(c)) \leq \text{frac}(u_2(c')))$ ,
- $u_1, u_2 \models (m - 1 < c < m)$  and  $u_1, u_2 \models (c' = m')$ . In this case,  $\text{frac}(u_1(c)) > 0 \wedge \text{frac}(u_2(c)) > 0$  and  $\text{frac}(u_1(c')) = \text{frac}(u_2(c')) = 0$ . Therefore,  $\text{frac}(u_1(c)) \leq \text{frac}(u_1(c'))$ ,  $\text{frac}(u_2(c)) \leq \text{frac}(u_2(c'))$  are both false statements, which implies  $(\text{frac}(u_1(c)) \leq \text{frac}(u_1(c')) \Leftrightarrow \text{frac}(u_2(c)) \leq \text{frac}(u_2(c')))$ ,
- $u_1, u_2 \models (m - 1 < c < m)$  and  $u_1, u_2 \models (m' - 1 < c' < m')$ . This subcase holds by the fifth precondition,
- $\forall c \in C : (u_1(c) \leq k(c))$  implies  $(\text{frac}(u_1(c)) = 0 \Leftrightarrow \text{frac}(u_2(c)) = 0)$ . By the first condition, we know that  $u_1(c) \leq k(c)$  implies  $u_2(c) \leq k(c)$ . Therefore, either  $u_1, u_2 \models (c = m)$  or  $u_1, u_2 \models (m - 1 < c < m)$  holds. In the first case  $\text{frac}(u_1(c)) = 0$  and  $\text{frac}(u_2(c)) = 0$  are both true statements, in the second case both statements are false. In either case  $\text{frac}(u_1(c)) = 0 \Leftrightarrow \text{frac}(u_2(c)) = 0$  is implied.

Therefore, the fourth statement holds.

Since the result of EXTRACT-REGIONS-IMPL fulfills all properties of Definition S.5, EXTRACT-REGIONS-IMPL is an extract-regions operator.  $\square$

Therefore, Proposition S.5 shows how the regions of a zone can be extracted.

## T. Region Equivalence preserves (Bi-)Simulation of TSVC

In this appendix, we show that Region Equivalence preserves (Bi-)Simulation of TSVC. This will be used later in Appendix U and Appendix V. We start with some helping propositions.

### Proposition T.1. (Properties of Region Equivalence)

Assume a set of clocks  $C$  and a function  $k : C \rightarrow \mathbb{N}^{\geq 0}$ . Region Equivalence is

1. reflexive (i.e.  $u \simeq_k u$  holds for any  $u \in C \rightarrow \mathbb{T}$ ),
2. transitive (i.e.  $u_1 \simeq_k u_2$  and  $u_2 \simeq_k u_3$  implies  $u_1 \simeq_k u_3$  for any  $u_1, u_2, u_3 \in C \rightarrow \mathbb{T}$ ), and
3. symmetric (i.e.  $u_1 \simeq_k u_2$  implies  $u_2 \simeq_k u_1$  for any  $u_1, u_2 \in C \rightarrow \mathbb{T}$ ).

### Proof:

We prove one property after another.

We first show that region equivalence is reflexive. By Definition 2.5,  $u \simeq_k u$  holds if and only if

1.  $\forall x \in C : ((\lfloor u(x) \rfloor = \lfloor u(x) \rfloor) \vee (u(x) > k(x) \wedge u(x) > k(x)))$ ,
2.  $\forall x, y \in C : (u(x) \leq k(x) \wedge u(y) \leq k(y))$  implies  $(\text{frac}(u(x)) \leq \text{frac}(u(y)) \Leftrightarrow \text{frac}(u(x)) \leq \text{frac}(u(y)))$ , and

3.  $\forall x \in C : (u(x) \leq k(x)) \text{ implies } (\text{frac}(u(x)) = 0 \Leftrightarrow \text{frac}(u(x)) = 0)$ .

holds. For any clock valuation  $u$ , the statement  $\forall c \in C : u(c) = u(c)$  is obviously true. This implies all conditions,  $u \simeq_k u$  holds, and region equivalence is reflexive.

Now we show that region equivalence is transitive. By Definition 2.5,  $u_1 \simeq_k u_3$  holds if and only if

1.  $\forall x \in C : ((\lfloor u_1(x) \rfloor = \lfloor u_3(x) \rfloor) \vee (u_1(x) > k(x) \wedge u_3(x) > k(x)))$ ,
2.  $\forall x, y \in C : (u_1(x) \leq k(x) \wedge u_1(y) \leq k(y)) \text{ implies } (\text{frac}(u_1(x)) \leq \text{frac}(u_1(y)) \Leftrightarrow \text{frac}(u_3(x)) \leq \text{frac}(u_3(y)))$ , and
3.  $\forall x \in C : (u_1(x) \leq k(x)) \text{ implies } (\text{frac}(u_1(x)) = 0 \Leftrightarrow \text{frac}(u_3(x)) = 0)$ .

holds. We remind the reader of the fact that  $u_1 \simeq_k u_2$  and  $u_2 \simeq_k u_3$  are preconditions. We show one statement after another:

1.  $\forall x \in C : ((\lfloor u_1(x) \rfloor = \lfloor u_3(x) \rfloor) \vee (u_1(x) > k(x) \wedge u_3(x) > k(x)))$ . To show this statement, we assume any  $x \in C$  and remind the reader of the fact that either  $\lfloor u_1(x) \rfloor = \lfloor u_2(x) \rfloor$  or  $(u_1(x) > k(x) \wedge u_2(x) > k(x))$  holds (since  $u_1 \simeq_k u_2$ ) and analogously for  $u_2$  and  $u_3$ . Therefore, we distinguish the four possible cases:
  - (a)  $\lfloor u_1(x) \rfloor = \lfloor u_2(x) \rfloor$  and  $\lfloor u_2(x) \rfloor = \lfloor u_3(x) \rfloor$ . In this case  $\lfloor u_1(x) \rfloor = \lfloor u_3(x) \rfloor$  and, therefore, the statement under investigation holds,
  - (b)  $\lfloor u_1(x) \rfloor = \lfloor u_2(x) \rfloor$  and  $(u_2(x) > k(x) \wedge u_3(x) > k(x))$ . Therefore, either  $u_1(x) = k(x)$  or  $u_1(x) > k(x)$ . Since  $k(x)$  is an integer,  $\text{frac}(u_1) = 0$  holds, which implies  $\text{frac}(u_2(x)) = 0$  by the third condition. Since we assumed  $u_2(x) > k(x)$ , this is a contradiction. Therefore,  $u_1(x) > k(x)$  holds, which implies the statement under investigation,
  - (c)  $(u_1(x) > k(x) \wedge u_2(x) > k(x))$  and  $\lfloor u_2(x) \rfloor = \lfloor u_3(x) \rfloor$ . Analogously to the previous case,
  - (d)  $(u_1(x) > k(x) \wedge u_2(x) > k(x))$  and  $(u_2(x) > k(x) \wedge u_3(x) > k(x))$ . The statement holds, since  $u_1(x) > k(x)$  and  $u_3(x) > k(x)$  are assumed.
2.  $\forall x, y \in C : (u_1(x) \leq k(x) \wedge u_1(y) \leq k(y)) \text{ implies } (\text{frac}(u_1(x)) \leq \text{frac}(u_1(y)) \Leftrightarrow \text{frac}(u_3(x)) \leq \text{frac}(u_3(y)))$ . For any  $x, y \in C$ , we only check this statement for the case in which  $(u_1(x) \leq k(x) \wedge u_1(y) \leq k(y))$  holds (otherwise it is trivial). By  $u_1 \simeq_k u_2$ , we know that  $(\text{frac}(u_1(x)) \leq \text{frac}(u_1(y)) \Leftrightarrow \text{frac}(u_2(x)) \leq \text{frac}(u_2(y)))$ . Since we assumed  $(u_1(x) \leq k(x) \wedge u_1(y) \leq k(y))$  we also know  $\lfloor u_1(x) \rfloor = \lfloor u_2(x) \rfloor$  and  $\lfloor u_1(y) \rfloor = \lfloor u_2(y) \rfloor$ , which implies  $(u_2(x) \leq k(x) \wedge u_2(y) \leq k(y))$ . By  $u_2 \simeq_k u_3$ , this implies  $(\text{frac}(u_2(x)) \leq \text{frac}(u_2(y)) \Leftrightarrow \text{frac}(u_3(x)) \leq \text{frac}(u_3(y)))$  and, therefore,  $(\text{frac}(u_1(x)) \leq \text{frac}(u_1(y)) \Leftrightarrow \text{frac}(u_3(x)) \leq \text{frac}(u_3(y)))$ .
3.  $\forall x \in C : (u_1(x) \leq k(x)) \text{ implies } (\text{frac}(u_1(x)) = 0 \Leftrightarrow \text{frac}(u_3(x)) = 0)$ . For the same reason as in the previous case, we know that  $u_1(x) \leq k(x)$  implies  $u_2(x) \leq k(x)$  and, therefore,  $(\text{frac}(u_1(x)) = 0 \Leftrightarrow \text{frac}(u_2(x)) = 0 \Leftrightarrow \text{frac}(u_3(x)) = 0)$  holds.

Since all conditions are fulfilled, we know that  $u_1 \simeq_k u_2$  and  $u_2 \simeq_k u_3$  imply  $u_1 \simeq_k u_3$  and region equivalence is transitive.

Finally, we show that region equivalence is symmetric. To do so, we show that  $u_1 \simeq_k u_2$  implies  $u_2 \simeq_k u_1$ . We assume  $u_1 \simeq_k u_2$  (otherwise the statement holds trivially) and distinguish the three conditions

1.  $\forall x \in C : ((\lfloor u_2(x) \rfloor = \lfloor u_1(x) \rfloor) \vee (u_2(x) > k(x) \wedge u_1(x) > k(x)))$ . Since for any  $x \in C$ ,  $\lfloor u_1(x) \rfloor = \lfloor u_2(x) \rfloor$  implies  $\lfloor u_2(x) \rfloor = \lfloor u_1(x) \rfloor$  and  $u_1(x) > k(x) \wedge u_2(x) > k(x)$  implies  $u_2(x) > k(x) \wedge u_1(x) > k(x)$ ,  $((\lfloor u_1(x) \rfloor = \lfloor u_2(x) \rfloor) \vee (u_1(x) > k(x) \wedge u_2(x) > k(x)))$  implies  $((\lfloor u_2(x) \rfloor = \lfloor u_1(x) \rfloor) \vee (u_2(x) > k(x) \wedge u_1(x) > k(x)))$ ,
2.  $\forall x, y \in C : (u_2(x) \leq k(x) \wedge u_2(y) \leq k(y))$  implies  $(\text{frac}(u_2(x)) \leq \text{frac}(u_2(y)) \Leftrightarrow \text{frac}(u_1(x)) \leq \text{frac}(u_1(y)))$ . For any  $x, y \in C$ , we assume  $(u_2(x) \leq k(x) \wedge u_2(y) \leq k(y))$  (since otherwise the statement holds trivially). By the previous statment, we know that  $(u_2(x) \leq k(x) \wedge u_2(y) \leq k(y))$  implies  $(u_1(x) \leq k(x) \wedge u_1(y) \leq k(y))$  (since the integer parts have to be identic) and, therefore,  $(\text{frac}(u_1(x)) \leq \text{frac}(u_1(y)) \Leftrightarrow \text{frac}(u_2(x)) \leq \text{frac}(u_2(y)))$  holds, which is equivalent to  $(\text{frac}(u_2(x)) \leq \text{frac}(u_2(y)) \Leftrightarrow \text{frac}(u_1(x)) \leq \text{frac}(u_1(y)))$ ,
3.  $\forall x \in C : (u_2(x) \leq k(x))$  implies  $(\text{frac}(u_2(x)) = 0 \Leftrightarrow \text{frac}(u_1(x)) = 0)$ . Once again, we assume  $u_2(x) \leq k(x)$  and follow  $(u_1(x) \leq k(x))$ . This implies  $\text{frac}(u_1(x)) = 0 \Leftrightarrow \text{frac}(u_2(x)) = 0$ , which is equivalent to  $\text{frac}(u_2(x)) = 0 \Leftrightarrow \text{frac}(u_1(x)) = 0$ .

Therefore, region equivalence is symmetric.  $\square$

The next proposition shows that if two states are region equivalent, for any outgoing transition of one of them, there exists an outgoing transition of the other one, such that the target states are in the same region. This proposition becomes obvious to anyone who has read chapter 4.3 of Alur and Dill [16].

### Proposition T.2. (Outgoing Transitions of Region Equivalent States)

Assume two diagonal-free TA  $A, B$  using the sets of clocks  $C_A, C_B$ , with TSVC  $A_{\text{TSVC}}$  of  $A$  regarding  $B$ , AB-semi-synchronized states  $(l_A, u_{1,A}), (l_A, u_{2,A})$  of  $A_{\text{TSVC}}$ , and a function  $k : C \rightarrow \mathbb{N}^{\geq 0}$ , such that for any clock constraint  $c \sim m$ , which occurs in  $A$  or  $B$ ,  $m < k(x)$ , for any  $i \in [0, |C_A| - 1] : k(C_A[i]) = k(\chi_i)$ , and for any  $i \in [0, |C_B| - 1] : k(C_B[i]) = k(\chi_{i+|C_A|})$  hold.

If  $u_{1,A} \simeq_k u_{2,A}$ , then for any outgoing transition  $(l_A, u_{1,A}) \xrightarrow[\text{TSVC}]{\mu_1} (l_{\mu,A}, u_{1,\mu,A})$  there exists an outgoing transition  $(l_A, u_{2,A}) \xrightarrow[\text{TSVC}]{\mu_2} (l_{\mu,A}, u_{2,\mu,A})$  such that  $u_{1,\mu,A} \simeq_k u_{2,\mu,A}$ .

#### Proof:

By Definition 2.3, we know that  $\mu_1 \in \Sigma \cup \mathbb{T}$ . To show this proposition, we distinguish two cases:

1.  $\mu_1 \in \Sigma$ . By Definition 2.3, this can only be the case if there exists a transition  $l_A \xrightarrow[\text{TA}]{g, \mu_1, R} l_{\mu,A}$  with  $u_{1,A} \models g$  and  $[R \rightarrow 0]u_{1,A} \models I(l_{\mu,A})$ . Since  $A$  is diagonal-free, we know that  $g \in \mathcal{B}(C_A)$  and  $I(l_{\mu,A}) \in \mathcal{B}(C_A)$  consist of a conjunction of atomic constraints of the form  $c \sim m$ , with

$c \in C_A$  and  $m \in \mathbb{N}^{\geq 0}$ . By Definition 2.5, we know that  $\forall c \in C_A : (([u_{1,A}(c)] = [u_{2,A}(c)]) \vee (u_{1,A}(c) > k(c) \wedge u_{2,A}(c) > k(c)))$ . For any atomic constraint  $c \sim m$  of  $g$ , we distinguish two cases:

- (a)  $[u_{1,A}(c)] = [u_{2,A}(c)]$ . In this case,  $u_{1,A} \models c \sim m$  implies  $u_{2,A} \models c \sim m$ ,
- (b)  $u_{1,A}(c) > k(c) \wedge u_{2,A}(c) > k(c)$ . By the preconditions of the proposition, we know  $m < k(c)$ . Due to  $u_{1,A} \models c \sim m$ , we know  $\sim \in \{\geq, >\}$  and, therefore,  $u_{2,A} \models c \sim m$ .

Therefore, we know that  $u_{1,A} \models g$  implies  $u_{2,A} \models g$ . For any atomic constraint  $c \sim m$  in  $I(l_{\mu,A})$ , we distinguish two cases:

- (a)  $c \in R$ . In this case,  $[R \rightarrow 0]u_{1,A}(c) = 0 = [R \rightarrow 0]u_{2,A}$  and  $[R \rightarrow 0]u_{1,A} \models c \sim m$  implies  $[R \rightarrow 0]u_{2,A} \models c \sim m$ ,
- (b) otherwise  $[R \rightarrow 0]u_{1,A}(c) = u_{1,A}(c)$  and  $[R \rightarrow 0]u_{2,A}(c) = u_{2,A}(c)$ . Therefore, we can show  $[R \rightarrow 0]u_{1,A} \models c \sim m$  implies  $[R \rightarrow 0]u_{2,A} \models c \sim m$  analogously to  $g$ .

Therefore, the existence of a transition  $(l_A, u_{1,A}) \xrightarrow{TSVC}^{\mu_1} (l_{\mu,A}, u_{1,\mu,A})$  with  $\mu_1 \in \Sigma$  implies the existence of a transition  $(l_A, u_{2,A}) \xrightarrow{TSVC}^{\mu_1} (l_{\mu,A}, u_{2,\mu,A})$  and we need to show  $u_{1,\mu,A} \simeq_k u_{2,\mu,A}$ . To do so, we need to show the three conditions of Definition 2.5. In each of them, we consider a clock  $c \in C_A$  and in the second case, we also consider a clock  $c' \in C_A$ . Since  $u_{1,\mu,A}(c) = u_{1,A}(c)$  and  $u_{2,\mu,A}(c) = u_{2,A}(c)$  hold, if  $c \notin R$  (and the same for  $c'$ ), all the conditions hold trivially by  $u_{1,A} \simeq_k u_{2,A}$ , if  $c$  and  $c'$  are not element of  $R$ . Therefore, we will skip those cases and only consider those, in which  $c$  or  $c'$  is element of  $R$ .

- (a)  $\forall c \in C_A : (([u_{1,\mu,A}(c)] = [u_{2,\mu,A}(c)]) \vee (u_{1,\mu,A}(c) > k(c) \wedge u_{2,\mu,A}(c) > k(c)))$ . For any  $c \in C_A$  with  $c \in R$ ,  $u_{1,\mu,A}(c) = [R \rightarrow 0]u_{1,A}(c) = 0 = [R \rightarrow 0]u_{2,A}(c) = u_{2,\mu,A}(c)$  holds, which implies  $[u_{1,\mu,A}(c)] = [u_{2,\mu,A}(c)]$ .
- (b)  $\forall c, c' \in C_A : (u_{1,\mu,A}(c) \leq k(c) \wedge u_{1,\mu,A}(c') \leq k(c'))$  implies  $(\text{frac}(u_{1,\mu,A}(c)) \leq \text{frac}(u_{1,\mu,A}(c')) \Leftrightarrow \text{frac}(u_{2,\mu,A}(c)) \leq \text{frac}(u_{2,\mu,A}(c')))$ . We only consider the case in which  $u_{1,\mu,A}(c) \leq k(c) \wedge u_{1,\mu,A}(c') \leq k(c')$  holds, since otherwise this condition holds trivially. We distinguish the following subcases:
  - i.  $c \in R$ . In this case, the postcondition holds trivially since  $\text{frac}(u_{1,\mu,A}(c)) = 0$ ,  $\text{frac}(u_{2,\mu,A}(c)) = 0$  which implies  $\text{frac}(u_{1,\mu,A}(c)) \leq \text{frac}(u_{1,\mu,A}(c'))$  and  $\text{frac}(u_{2,\mu,A}(c)) \leq \text{frac}(u_{2,\mu,A}(c'))$  for any values of  $\text{frac}(u_{1,\mu,A}(c'))$  and  $\text{frac}(u_{2,\mu,A}(c'))$ .
  - ii.  $c \notin R$  and  $c' \in R$ . We remind the reader of the third condition of Definition 2.5, from which we know that  $\text{frac}(u_{1,\mu,A}(c)) = 0$  holds if and only if  $\text{frac}(u_{2,\mu,A}(c)) = 0$ . We distinguish two more subcases:
    - A.  $\text{frac}(u_{1,\mu,A}(c)) = 0 \wedge \text{frac}(u_{2,\mu,A}(c)) = 0$ . In this case, the postcondition holds trivially since  $\text{frac}(u_{1,\mu,A}(c)) \leq \text{frac}(u_{1,\mu,A}(c'))$  and  $\text{frac}(u_{2,\mu,A}(c)) \leq \text{frac}(u_{2,\mu,A}(c'))$  hold.
    - B.  $\text{frac}(u_{1,\mu,A}(c)) > 0 \wedge \text{frac}(u_{2,\mu,A}(c)) > 0$ . In this case,  $\text{frac}(u_{1,\mu,A}(c)) > \text{frac}(u_{1,\mu,A}(c'))$  and  $\text{frac}(u_{2,\mu,A}(c)) > \text{frac}(u_{2,\mu,A}(c'))$  and, therefore, the postcondition holds.

- (c)  $\forall c \in C_A : (u_{1,\mu,A}(c) \leq k(c))$  implies  $(\text{frac}(u_{1,\mu,A}(c)) = 0 \Leftrightarrow \text{frac}(u_{2,\mu,A}(c)) = 0)$ . We assume any  $c \in C_A$  with  $c \in R$ .  $\text{frac}(u_{1,\mu,A}(c)) = 0$  and  $\text{frac}(u_{2,\mu,A}(c)) = 0$  hold and, therefore,  $\text{frac}(u_{1,\mu,A}(c)) = 0 \Leftrightarrow \text{frac}(u_{2,\mu,A}(c)) = 0$  holds.
2.  $\mu_1 \in \mathbb{T}$ . For any clock valuation  $u_k$  with  $u_k \simeq_k u_{1,\mu,A}$ ,  $u_k \models I(l_A)$  holds for the same reason as in the previous case. Therefore, we only have to check, whether there exists a  $\mu_2$ , such that  $u_{2,A} + \mu_2 \simeq_k u_{1,\mu,A}$  to show that there exists a transition  $(l_A, u_{2,A}) \xrightarrow{TSVC}^{\mu_2} (l_A, u_{2,\mu,A})$ . We use the time-successors of Chapter 4.3 of Alur and Dill [16] here. Given a clock valuation  $u$ , its clock region  $\alpha = [u]$  is the set of all  $u_k$  with  $u \simeq_k u_k$ . A region  $\alpha'$  is called a time-successor of  $\alpha$ , if and only if  $\forall u \in \alpha : \exists d \in \mathbb{T} : u + d \in \alpha'$  (Definition 4.6 of [16]). If  $\forall c \in C_A : u(c) > k(c)$  holds, any delay is possible and  $\alpha$  is its only time-successor. In this case, the proposition holds trivially and, therefore, we assume that there exists at least a single  $c \in C$  with  $u(c) \leq k(c)$ . Then, there exists a region  $\alpha' \neq \alpha$ , which is called the least time-successor. For all clock valuations  $u \in \alpha$  there exists a  $t \in \mathbb{T}$ , such that  $u + t \in \alpha'$ . Moreover, any time-successor of  $\alpha$ , except  $\alpha$  itself, is also a time-successor of  $\alpha'$  and any time-successor of  $\alpha'$  is also a time-successor of  $\alpha$ . Last but not least, it can be shown that  $[u_{1,\mu,A}]$  is a time-successor of  $\alpha$  (Lemma 4.13 of [16]). Given two clock valuations  $u_{\text{before}}$  and  $u_{\text{after}}$ , such that  $[u_{\text{after}}]$  is a time-successor of  $[u_{\text{before}}]$ , we denote with  $[u_{\text{before}}] \setminus [u_{\text{after}}]$  all regions that are successor-regions of  $[u_{\text{before}}]$  but which are not successor-regions of  $[u_{\text{after}}]$ . We do an induction:

**Hypothesis:** For any outgoing transition  $(l_A, u_{1,A}) \xrightarrow{TSVC}^{\mu_1} (l_A, u_{1,\mu,A})$  with  $\mu_1 \in \mathbb{T}$  there exists an outgoing transition  $(l_A, u_{2,A}) \xrightarrow{TSVC}^{\mu_2} (l_A, u_{2,\mu,A})$  such that  $(l_{1,\mu,A}, u_{1,\mu,A}) \simeq_k (l_{2,\mu,A}, u_{2,\mu,A})$ .

**Base Case:** The hypothesis holds if  $|[u_{1,A}] \setminus [u_{1,\mu,A}]| = 0$ .

**Induction Step:** If the hypothesis holds if  $|[u_{1,A}] \setminus [u_{1,\mu,A}]| = n$ , then the hypothesis also holds if  $|[u_{1,A}] \setminus [u_{1,\mu,A}]| = n + 1$ .

We first show the base case. Obviously,  $|[u_{1,A}] \setminus [u_{1,\mu,A}]| = 0$  holds if and only if  $u_{1,A} \simeq_k u_{1,\mu,A}$ . If we set  $\mu_2 = 0$ ,  $u_{2,A} = u_{2,\mu,A}$ , which implies  $u_{1,\mu,A} \simeq_k u_{1,A} \simeq_k u_{2,A} = u_{2,\mu,A}$  and since region equivalence is transitive,  $u_{1,\mu,A} \simeq_k u_{2,\mu,A}$  is implied.

Now we show the induction step.  $\mu_1$  can be splitted into two different delays  $d_1, d_2$ , such that  $\mu_1 = d_1 + d_2$  and  $(l_A, u_{1,A}) \xrightarrow{TSVC}^{d_1} (l_A, u_{1,d,A})$  and  $(l_A, u_{1,d,A}) \xrightarrow{TSVC}^{d_2} (l_A, u_{1,\mu,A})$  with  $|[u_{1,A}] \setminus [u_{1,d,A}]| = n$ . By the induction hypothesis, there exists a  $d_3$ , such that there exists a transition  $(l_A, u_{2,A}) \xrightarrow{TSVC}^{d_3} (l_A, u_{2,d,A})$  with  $(l_A, u_{1,d,A}) \simeq_k (l_A, u_{2,d,A})$ . By the induction hypothesis, we also know that there exists a  $d_4$  such that  $(l_A, u_{2,d,A}) \xrightarrow{TSVC}^{d_4} (l_A, u_{2,\mu,A})$  with  $(l_A, u_{1,\mu,A}) \simeq_k (l_A, u_{2,\mu,A})$ . If we set  $\mu_2 = d_3 + d_4$ , the induction step holds.  $\square$

Moreover, we can show that the `sync` function preserves region equivalence.

**Proposition T.3. (sync for States preserves Region Equivalence)**

Assume two diagonal-free TA  $A, B$  using the sets of clocks  $C_A, C_B$ , with  $TSVC A_{TSVC}$  of  $A$  regarding

$B$ , with AB-semi-synchronized states  $(l_A, u_{1,A})$ ,  $(l_A, u_{2,A})$ , and TSVC  $B_{\text{TSVC}}$  of  $B$  regarding  $A$ , with AB-semi-synchronized states  $(l_B, u_{1,B})$ ,  $(l_B, u_{2,B})$ , and a function  $k : C \rightarrow \mathbb{N}^{\geq 0}$ , such that for any clock constraint  $c \sim m$ , which occurs in  $A$  or  $B$ ,  $m < k(x)$ , for any  $i \in [0, |C_A| - 1] : k(C_A[i]) = k(\chi_i)$ , and for any  $i \in [0, |C_B| - 1] : k(C_B[i]) = k(\chi_{i+|C_A|})$  hold. We denote

$$\begin{aligned} ((l_A, u_{1,e,A}), (l_B, u_{1,e,B})) &= \text{sync}((l_A, u_{1,A}), (l_B, u_{1,B})) \text{ and} \\ ((l_A, u_{2,e,A}), (l_B, u_{2,e,B})) &= \text{sync}((l_A, u_{2,A}), (l_B, u_{2,B})). \end{aligned}$$

If  $u_{1,A} \simeq_k u_{2,A}$  and  $u_{1,B} \simeq_k u_{2,B}$ , then  $u_{1,e,A} \simeq_k u_{2,e,A}$  and  $u_{1,e,B} \simeq_k u_{2,e,B}$ .

**Proof:**

Before we show this proposition, we show that for any  $C_B[i]$ , either  $u_{1,B}(C_B[i]) = 0$  and  $u_{2,B}(C_B[i]) = 0$  or  $u_{1,B}(C_B[i]) \neq 0$  and  $u_{2,B}(C_B[i]) \neq 0$  holds.  $u_{1,B}(C_B[i]) = 0$  and  $u_{2,B}(C_B[i]) \neq 0$  is a contradiction to  $u_{1,B} \simeq_k u_{2,B}$ . Obviously,  $u_{1,B}(C_B[i]) = 0$  implies  $u_{1,B}(C_B[i]) \leq k(C_B[i])$ . Therefore, the first condition of Definition 2.5 implies  $u_{2,B}(C_B[i]) < 1$  and the third condition implies  $\text{frac}(u_{2,B}(C_B[i])) = 0$ . Therefore,  $u_{1,B}(C_B[i]) = 0$  implies  $u_{2,B}(C_B[i]) = 0$ , which is a contradiction to the assumption. The same holds for the opposite direction (remember the symmetry of region equivalence).

We show only  $u_{1,e,A} \simeq_k u_{2,e,A}$ , since  $u_{1,e,B} \simeq_k u_{2,e,B}$  can be shown analogously. To show  $u_{1,e,A} \simeq_k u_{2,e,A}$ , we need to show the three conditions of Definition 2.5. Since the original clocks are untouched by the sync function and since  $\forall i \in [0, |C_A| - 1] : u_{1,e,A}(C_A[i]) = u_{1,e,A}(\chi_i)$  (and analog for  $u_{2,e,A}$ ) all three statements hold trivially by  $u_{1,A} \simeq_k u_{2,A}$  if the considered clocks are element of  $C_A \cup \{\chi_0, \dots, \chi_{|C_A|-1}\}$ . Therefore, we only check the statements for the cases in which at least a single clock considered is element of  $\{\chi_{|C_A|}, \dots, \chi_{|C_A|+|C_B|-1}\}$ .

1.  $\forall i \in [0, |C_B|-1] : ((\lfloor u_{1,e,A}(\chi_{i+|C_A|}) \rfloor = \lfloor u_{2,e,A}(\chi_{i+|C_A|}) \rfloor) \vee (u_{1,e,A}(\chi_{i+|C_A|}) > k(\chi_{i+|C_A|}) \wedge u_{2,e,A}(\chi_{i+|C_A|}) > k(\chi_{i+|C_A|})))$ . Since for any  $i$ , either  $u_{1,B}(C_B[i]) = 0$  and  $u_{2,B}(C_B[i]) = 0$  or  $u_{1,B}(C_B[i]) \neq 0$  and  $u_{2,B}(C_B[i]) \neq 0$  holds, we only distinguish these cases:
  - (a)  $u_{1,B}(C_B[i]) = 0$  and  $u_{2,B}(C_B[i]) = 0$ . In this case,  $u_{1,e,A}(\chi_{|C_A|+i}) = 0 = u_{2,e,A}(\chi_{|C_A|+i})$  and the statement holds trivially,
  - (b)  $u_{1,B}(C_B[i]) \neq 0$  and  $u_{2,B}(C_B[i]) \neq 0$ . In this case,  $u_{1,A}(\chi_{|C_A|+i}) = u_{1,e,A}(\chi_{|C_A|+i})$  and analogously for  $u_{2,e,A}$  and, therefore, the statement holds by  $u_{1,e,A} \simeq_k u_{2,e,A}$ .
2.  $\forall c, c' \in C_A \cup \{\chi_0, \dots, \chi_{|C_A|+|C_B|-1}\} : (u_{1,e,A}(c) \leq k(c) \wedge u_{1,e,A}(c') \leq k(c'))$  implies  $(\text{frac}(u_{1,e,A}(c)) \leq \text{frac}(u_{1,e,A}(c')) \Leftrightarrow \text{frac}(u_{2,e,A}(c)) \leq \text{frac}(u_{2,e,A}(c')))$ . We assume the precondition to hold, otherwise the statement holds trivially. We only check the cases in which at least a single clock considered is element of  $\{\chi_{|C_A|}, \dots, \chi_{|C_A|+|C_B|-1}\}$ .
  - (a)  $c = \chi_{i+|C_A|}$  with  $i \in [0, |C_B|-1]$ . We know that either  $u_{1,B}(C_B[i]) = 0$  and  $u_{2,B}(C_B[i]) = 0$  or  $u_{1,B}(C_B[i]) \neq 0$  and  $u_{2,B}(C_B[i]) \neq 0$  hold (due to  $u_{1,B} \simeq_k u_{2,B}$ ). If  $u_{1,B}(C_B[i]) = 0$  and  $u_{2,B}(C_B[i]) = 0$  hold,  $u_{1,e,A}(\chi_{i+|C_A|}) = 0$  and  $u_{2,e,A}(\chi_{i+|C_A|}) = 0$ , which obviously implies  $\text{frac}(u_{1,e,A}(c)) \leq \text{frac}(u_{1,e,A}(c'))$  and  $\text{frac}(u_{2,e,A}(c)) \leq \text{frac}(u_{2,e,A}(c'))$  for any values of  $u_{1,e,A}(c')$  and  $u_{2,e,A}(c')$ . Therefore, we assume  $u_{1,B}(C_B[i]) \neq 0$

and  $u_{2,B}(C_B[i]) \neq 0$ . Therefore,  $u_{1,A}(\chi_{i+|C_A|}) = u_{1,e,A}(\chi_{i+|C_A|}) \wedge u_{2,A}(\chi_{i+|C_A|}) = u_{2,e,A}(\chi_{i+|C_A|})$  hold by Definition 3.5. Since  $u_{1,A} \simeq_k u_{2,A}$ , we know that either  $\text{frac}(u_{1,A}(\chi_{i+|C_A|})) = 0 \wedge \text{frac}(u_{2,A}(\chi_{i+|C_A|})) = 0$  or  $\text{frac}(u_{1,A}(\chi_{i+|C_A|})) \neq 0 \wedge \text{frac}(u_{2,A}(\chi_{i+|C_A|})) \neq 0$  (Condition three). In the first case,  $\text{frac}(u_{1,e,A}(\chi_{i+|C_A|})) \leq \text{frac}(u_{1,e,A}(\chi_{j+|C_A|}))$  and  $(\text{frac}(u_{2,e,A}(\chi_{i+|C_A|})) \leq \text{frac}(u_{2,e,A}(\chi_{j+|C_A|})))$  both hold and, therefore, we assume  $\text{frac}(u_{1,A}(\chi_{i+|C_A|})) \neq 0 \wedge \text{frac}(u_{2,A}(\chi_{i+|C_A|})) \neq 0$ . We distinguish two sub-cases:

- i.  $c' = \chi_{j+|C_A|}$ ,  $j \in [0, |C_B| - 1]$ . Either  $u_{1,B}(C_B[j]) = 0 \wedge u_{2,B}(C_B[j]) = 0$ . In this case,  $(\text{frac}(u_{1,e,A}(\chi_{i+|C_A|})) \leq \text{frac}(u_{1,e,A}(\chi_{j+|C_A|})))$  and  $(\text{frac}(u_{2,e,A}(\chi_{i+|C_A|})) \leq \text{frac}(u_{2,e,A}(\chi_{j+|C_A|})))$  are both false, or  $u_{1,B}(C_B[j]) \neq 0 \wedge u_{2,B}(C_B[j]) \neq 0$  in which case the statement reduces to  $(u_{1,A}(c) \leq k(c) \wedge u_{1,A}(c') \leq k(c'))$  implies  $(\text{frac}(u_{1,A}(c)) \leq \text{frac}(u_{1,A}(c')) \Leftrightarrow \text{frac}(u_{2,A}(c)) \leq \text{frac}(u_{2,A}(c')))$ , which is implied by the second condition of  $u_{1,A} \simeq_k u_{2,A}$ .
  - ii.  $c' \in C_A \cup \{\chi_0, \dots, \chi_{|C_A|-1}\}$ . Since we know that for any  $j \in [0, |C_A| - 1]$  :  $u_{1,e,A}(C_A[j]) = u_{1,e,A}(\chi_j) \wedge u_{2,e,A}(C_A[j]) = u_{2,e,A}(\chi_j)$  (remember: the result of the sync function is AB-synchronized), it is enough to check for  $c' \in C_A$ . Since  $\forall c' \in C_A : u_{1,e,A}(c) = u_{1,A}(c) \wedge u_{2,e,A}(c) = u_{2,A}(c)$  and we assumed  $u_{1,e,A}(c) = u_{1,A}(c) \wedge u_{2,e,A}(c) = u_{2,A}(c)$ , this condition reduces to  $(u_{1,A}(c) \leq k(c) \wedge u_{1,A}(c') \leq k(c'))$  implies  $(\text{frac}(u_{1,A}(c)) \leq \text{frac}(u_{1,A}(c')) \Leftrightarrow \text{frac}(u_{2,A}(c)) \leq \text{frac}(u_{2,A}(c')))$ , which is implied by the second condition of  $u_{1,A} \simeq_k u_{2,A}$ .
- (b)  $c \in C_A \cup \{\chi_0, \dots, \chi_{|C_A|-1}\}$ . In this case, we only consider  $c' = \chi_{j+|C_A|}$  with  $j \in [0, |C_B| - 1]$ . This case can be shown analogously to the previous case.
3.  $\forall c \in \{\chi_{|C_A|}, \dots, \chi_{|C_A|+|C_B|-1}\} : (u_{1,e,A}(c) \leq k(c))$  implies  $(\text{frac}(u_{1,e,A}(c)) = 0 \Leftrightarrow \text{frac}(u_{2,e,A}(c)) = 0)$ . We distinguish two cases:
- (a)  $u_{1,B}(C_B[i]) = 0$  and  $u_{2,B}(C_B[i]) = 0$ . In this case,  $\text{frac}(u_{1,e,A}(c)) = 0 \wedge \text{frac}(u_{2,e,A}(c)) = 0$  and the postcondition holds trivially,
  - (b)  $u_{1,B}(C_B[i]) \neq 0$  and  $u_{2,B}(C_B[i]) \neq 0$ . In this case,  $u_{1,e,A}(c) = u_{1,A}(c) \wedge u_{2,e,A}(c) = u_{2,A}(c)$  and the statement reduces to  $\forall c \in \{\chi_{|C_A|}, \dots, \chi_{|C_A|+|C_B|-1}\} : (u_{1,A}(c) \leq k(c))$  implies  $(\text{frac}(u_{1,A}(c)) = 0 \Leftrightarrow \text{frac}(u_{2,A}(c)) = 0)$  which holds by  $u_{1,A} \simeq_k u_{2,A}$ .

□

Now we can show Proposition T.4.

Given a TSVC  $A_{\text{TSVC}}$  with states  $(l_1, u_1)$ ,  $(l_2, u_2)$ , we define the states to be region equivalent, denoted  $(l_1, u_1) \simeq_k (l_2, u_2)$ , if and only if  $l_1 = l_2$  and  $u_1 \simeq_k u_2$  hold. We can show that if two states are virtually bisimilar, then any region equivalent states are virtually bisimilar, too.

**Proposition T.4. (Region Equivalence preserves Virtual (Bi-)Simulation of TSVC)**

Assume two diagonal-free TA  $A, B$  using the sets of clocks  $C_A, C_B$ , with TSVC  $A_{\text{TSVC}}$  of  $A$  regarding  $B$ , TSVC  $B_{\text{TSVC}}$  of  $B$  regarding  $A$ , AB-semi-synchronized states  $(l_A, u_{1,A})$ ,  $(l_B, u_{1,B})$ ,  $(l_A, u_{2,A})$ ,  $(l_B, u_{2,B})$ , with  $(l_A, u_{1,A})$ ,  $(l_A, u_{2,A})$  being states of  $A_{\text{TSVC}}$  and  $(l_B, u_{1,B})$ ,  $(l_B, u_{2,B})$  being states

of  $B_{\text{TSVC}}$ , and a function  $k : C_A \cup C_B \cup \{\chi_0, \dots, \chi_{|C_A|+|C_B|-1}\} \rightarrow \mathbb{N}^{\geq 0}$ , such that for any clock constraint  $c \sim m$ , which occurs in  $A$  or  $B$ ,  $m < k(x)$ , for any  $i \in [0, |C_A| - 1] : k(C_A[i]) = k(\chi_i)$ , and for any  $i \in [0, |C_B| - 1] : k(C_B[i]) = k(\chi_{i+|C_A|})$  hold. Moreover, assume any value  $n \in \mathbb{N}^{\geq 0}$ ,  $\text{virt}(u_{1,A}) = \text{virt}(u_{1,B})$ ,  $\text{virt}(u_{2,A}) = \text{virt}(u_{2,B})$ , and  $u_{1,A} \simeq_k u_{2,A}$ ,  $u_{1,B} \simeq_k u_{2,B}$ .

$(l_A, u_{1,A}) \sqsubseteq_n (l_B, u_{1,B})$  holds if and only if  $(l_A, u_{2,A}) \sqsubseteq_n (l_B, u_{2,B})$  holds.  $(l_A, u_{1,A}) \sim_n (l_B, u_{1,B})$  holds if and only if  $(l_A, u_{2,A}) \sim_n (l_B, u_{2,B})$  holds.

**Proof:**

Since the second part of Proposition T.4 can be shown analogously to the first part, we show only the first part of Proposition T.4. Since  $\simeq_k$  is symmetric (Proposition T.1), we only have to show that  $(l_A, u_{1,A}) \sqsubseteq_n (l_B, u_{1,B})$  implies  $(l_A, u_{2,A}) \sqsubseteq_n (l_B, u_{2,B})$  and the opposite direction is implied by the symmetry of  $\simeq_k$ . We show this by induction.

**Hypothesis:**  $(l_A, u_{1,A}) \sqsubseteq_n (l_B, u_{1,B})$  implies  $(l_A, u_{2,A}) \sqsubseteq_n (l_B, u_{2,B})$ , if  $n \in \mathbb{N}^{\geq 0}$ ,  $\text{virt}(u_{2,A}) = \text{virt}(u_{2,B})$ , and  $u_{1,A} \simeq_k u_{2,A}$ ,  $u_{1,B} \simeq_k u_{2,B}$ .

**Base Case:** The hypothesis holds for  $n = 0$ .

**Induction Step:** If the hypothesis holds for  $n$ , then it also holds for  $n + 1$ .

Due to  $\text{virt}(u_{2,A}) = \text{virt}(u_{2,B})$ ,  $(l_A, u_{2,A}) \sqsubseteq_0 (l_B, u_{2,B})$  and the base case holds.

To show that  $(l_A, u_{2,A}) \sqsubseteq_{n+1} (l_B, u_{2,B})$  holds, we have to show that for the AB-synchronized states

$$((l_A, u_{2,e,A}), (l_B, u_{2,e,B})) = \text{sync}(v_{2,A}^{\text{TV}}, v_{2,B}^{\text{TV}})$$

the existence of a transition  $v_{2,e,A}^{\text{TV}} \xrightarrow{\text{TSVC}}^{\mu} v_{2,\mu,A}^{\text{TV}}$  implies the existence of a transition  $v_{2,e,B}^{\text{TV}} \xrightarrow{\text{TSVC}}^{\mu} v_{2,\mu,B}^{\text{TV}}$  with  $v_{2,\mu,A}^{\text{TV}} \sqsubseteq_n v_{2,\mu,B}^{\text{TV}}$  ( $\text{virt}(u_{2,A}) = \text{virt}(u_{2,B})$  holds by the precondition). The precondition  $(l_A, u_{1,A}) \sqsubseteq_{n+1} (l_B, u_{1,B})$  implies that for the AB-synchronized states

$$((l_A, u_{1,e,A}), (l_B, u_{1,e,B})) = \text{sync}(v_{1,A}^{\text{TV}}, v_{1,B}^{\text{TV}})$$

the condition regarding the outgoing transition holds. Moreover, by Proposition T.3 we know that  $u_{1,e,A} \simeq_k u_{2,e,A}$  and  $u_{1,e,B} \simeq_k u_{2,e,B}$ . By Proposition T.2, we know that the existence of a transition  $(l_A, u_{2,e,A}) \xrightarrow{\text{TSVC}}^{\mu} (l_{\mu,A}, u_{2,\mu,A})$  implies the existence of a transition  $(l_A, u_{1,e,A}) \xrightarrow{\text{TSVC}}^{\mu} (l_{\mu,A}, u_{1,\mu,A})$  with  $u_{2,\mu,A} \simeq_k u_{1,\mu,A}$ . By  $(l_A, u_{1,A}) \sqsubseteq_{n+1} (l_B, u_{1,B})$ , we know that there exists a transition  $(l_B, u_{1,e,B}) \xrightarrow{\text{TSVC}}^{\mu} (l_{\mu,B}, u_{1,\mu,B})$  with  $(l_A, u_{1,\mu,A}) \sqsubseteq_n (l_B, u_{1,\mu,B})$ . Due to Proposition T.2, this implies the existence of a transition  $(l_B, u_{2,e,B}) \xrightarrow{\text{TSVC}}^{\mu} (l_{\mu,B}, u_{2,\mu,B})$  with  $u_{1,\mu,B} \simeq_k u_{2,\mu,B}$ . Since for any  $\mu \in \Sigma \cup \mathbb{T}$ ,  $\text{virt}(u_{2,A}) = \text{virt}(u_{2,B})$  implies  $\text{virt}(u_{2,\mu,A}) = \text{virt}(u_{2,\mu,B})$ ,  $(l_A, u_{1,\mu,A}) \sqsubseteq_n (l_B, u_{1,\mu,B})$  implies  $(l_A, u_{2,\mu,A}) \sqsubseteq_n (l_B, u_{2,\mu,B})$  by the induction hypothesis.  $\square$

## U. VCG simulate if and only if TA simulate

We define virtual simulation and show Theorem 3.2 here. We start with the definition of virtual simulation.



**Definition U.1. (Virtual Simulation for VCGs)**

Assume two TA  $A, B$  with VCG  $A_{\text{VCG}}$  of  $A$  regarding  $B$  and VCG  $B_{\text{VCG}}$  of  $B$  regarding  $A$ , using the same alphabet  $\Sigma$ . Let  $v_A^{\text{VC}} = (l_A, D_A)$  be an AB-semi-synchronized symbolic state of  $A_{\text{VCG}}$  and let  $v_B^{\text{VC}} = (l_B, D_B)$  be an AB-semi-synchronized symbolic state of  $B_{\text{VCG}}$ .

We define  $v_A^{\text{VC}}$  to be simulated in order zero by  $v_B^{\text{VC}}$ , denoted  $v_A^{\text{VC}} \sqsubseteq_0 v_B^{\text{VC}}$ , if and only if  $D_A \equiv_{\text{virtual}} D_B$  holds.

We define  $v_A^{\text{VC}}$  to be simulated in order  $n + 1$  by  $v_B^{\text{VC}}$ , denoted  $v_A^{\text{VC}} \sqsubseteq_n v_B^{\text{VC}}$ , if and only if  $D_A \equiv_{\text{virtual}} D_B$  and for the AB-synchronized symbolic states

$$(v_{e,A}^{\text{VC}}, v_{e,B}^{\text{VC}}) = \text{sync}(v_A^{\text{VC}}, v_B^{\text{VC}})$$

the existence of an outgoing transition  $v_{e,A}^{\text{VC}} \xrightarrow[VCG]{\mu} (l_{\mu,A}, D_{\mu,A})$  implies the existence of a finite set of symbolic states  $\{(l_{\mu,A}, D_{\mu,0,A}), (l_{\mu,A}, D_{\mu,1,A}), \dots\}$  with  $(\bigcup D_{\mu,i,A}) = D_{\mu,A}$  and for any  $(l_{\mu,A}, D_{\mu,i,A})$  exists an outgoing transition  $v_{e,B}^{\text{VC}} \xrightarrow[VCG]{\mu} (l_{\mu,B}, D_{\mu,B})$  such that there exists a zone  $D_{\mu,i,B} \subseteq D_{\mu,B}$  with  $(l_{\mu,A}, D_{\mu,i,A}) \sqsubseteq_n (l_{\mu,B}, D_{\mu,i,B})$ .

$A_{\text{VCG}}$  is simulated in order  $n$  by  $B_{\text{VCG}}$ , denoted  $A_{\text{VCG}} \sqsubseteq_n B_{\text{VCG}}$ , if and only if  $v_{0,A}^{\text{VC}} \sqsubseteq_n v_{0,B}^{\text{VC}}$  holds.  $A_{\text{VCG}}$  is simulated by  $B_{\text{VCG}}$ , denoted  $A_{\text{VCG}} \sqsubseteq B_{\text{VCG}}$ , if and only if  $\forall n \in \mathbb{N}^{\geq 0} : A_{\text{VCG}} \sqsubseteq_n B_{\text{VCG}}$  holds.

Instead of Theorem 3.2, we show the theorem for Virtual Simulation here. Theorem 3.2 can be shown analogously.

**Theorem U.1. (Virtual Simulation of VCGs is correct)**

Assume two TA  $A, B$ , the VCG  $A_{\text{VCG}}$  of  $A$  regarding  $B$ , and the VCG  $B_{\text{VCG}}$  of  $B$  regarding  $A$ .  $A \sqsubseteq_n B$  holds if and only if  $A_{\text{VCG}} \sqsubseteq_n B_{\text{VCG}}$  holds.  $A \sqsubseteq B$  is equivalent to  $A_{\text{VCG}} \sqsubseteq B_{\text{VCG}}$ .

**Proof:**

Let  $v_A^{\text{VC}} = (l_A, D_A)$  be a non-empty, AB-semi-synchronized symbolic state of  $A_{\text{VCG}}$  and  $v_B^{\text{VC}} = (l_B, D_B)$  be a non-empty, AB-semi-synchronized symbolic state of  $B_{\text{VCG}}$  with  $D_A \equiv_{\text{virtual}} D_B$ . We show that  $v_A^{\text{VC}} \sqsubseteq_n v_B^{\text{VC}}$  is equivalent to

$$\forall v_A^{\text{TV}} \in v_A^{\text{VC}} : \exists v_B^{\text{TV}} \in v_B^{\text{VC}} : v_A^{\text{TV}} \sqsubseteq_n v_B^{\text{TV}}.$$

We first show that  $v_A^{\text{VC}} \sqsubseteq_n v_B^{\text{VC}}$  implies the second statement and afterwards the opposite direction. We show both directions by induction in  $n$ . We remind the reader of the fact that if  $v_A^{\text{VC}}$  is AB-semi-synchronized, then  $v_A^{\text{TV}} \in v_A^{\text{VC}}$  implies that  $v_A^{\text{TV}}$  is AB-semi-synchronized and the same holds for all states in  $v_B^{\text{VC}}$ . The analog statement holds for AB-synchronized symbolic states.

**Hypothesis:** If  $v_A^{\text{VC}}$  is non-empty and AB-semi-synchronized and  $v_B^{\text{VC}}$  is non-empty and AB-semi-synchronized, then  $v_A^{\text{VC}} \sqsubseteq_n v_B^{\text{VC}}$  implies

$$\forall (l_A, u_A) \in v_A^{\text{VC}} : \exists (l_B, u_B) \in v_B^{\text{VC}} : (l_A, u_A) \sqsubseteq_n (l_B, u_B)$$

**Base Case:** The hypothesis holds if  $n = 0$ .

**Induction Step:** If the hypothesis holds for  $n$ , then it also holds for  $n + 1$ .

We first show the base case. Let  $(l_A, u_A) \in v_A^{\text{VC}}$  be any state. To show the base, we have to show that there exists a  $(l_B, u_B) \in v_B^{\text{VC}}$  with  $(l_A, u_A) \sqsubseteq_0 (l_B, u_B)$ .

By Definition 3.11,  $v_A^{\text{VC}} \sqsubseteq_0 v_B^{\text{VC}}$  implies  $D_A \equiv_{\text{virtual}} D_B$ . By Definition 3.9, this implies the existence of a  $(l_B, u_B) \in v_B^{\text{VC}}$ , such that  $\text{virt}(u_A) = \text{virt}(u_B)$ . Since  $(l_A, u_A), (l_B, u_B)$  are AB-semi-synchronized and  $\text{virt}(u_A) = \text{virt}(u_B)$  holds,  $(l_A, u_A) \sqsubseteq_0 (l_B, u_B)$  is implied by Definition 3.6. Therefore,  $v_A^{\text{VC}} \sqsubseteq_0 v_B^{\text{VC}}$  implies

$$\forall (l_A, u_A) \in v_A^{\text{VC}} : \exists (l_B, u_B) \in v_B^{\text{VC}} : (l_A, u_A) \sqsubseteq_0 (l_B, u_B)$$

and the base case holds.

We now show the induction step. The induction step can only be false, if  $v_A^{\text{VC}} \sqsubseteq_{n+1} v_B^{\text{VC}}$  holds. Therefore, we assume this to be the case. Let  $(l_A, u_A) \in v_A^{\text{VC}}$  be any state.  $v_A^{\text{VC}} \sqsubseteq_{n+1} v_B^{\text{VC}}$  implies  $D_A \equiv_{\text{virtual}} D_B$ . Therefore, as we have already seen in the base case,  $\exists (l_B, u_B) \in v_B^{\text{VC}} : \text{virt}(u_A) = \text{virt}(u_B)$  is implied and we need to show that  $(l_A, u_A) \sqsubseteq_{n+1} (l_B, u_B)$  holds. Due to Corollary P.1 we know that for each  $u_A$  there exists exactly a single  $u_B$ , such that  $\text{virt}(u_A) = \text{virt}(u_B)$ .

To show  $(l_A, u_A) \sqsubseteq_{n+1} (l_B, u_B)$ , we have to show that for the AB-synchronized states

$$((l_A, u_{e,A}), (l_B, u_{e,B})) = \text{sync}((l_A, u_A), (l_B, u_B))$$

the existence of a transition  $(l_A, u_{e,A}) \xrightarrow[\text{TSVC}]{\mu} (l_{\mu,A}, u_{\mu,A})$  ( $\mu \in \Sigma \cup \mathbb{T}$ ) implies the existence of a transition  $(l_B, u_{e,B}) \xrightarrow[\text{TSVC}]{\mu} (l_{\mu,B}, u_{\mu,B})$  with  $(l_{\mu,A}, u_{\mu,A}) \sqsubseteq_n (l_{\mu,B}, u_{\mu,B})$ .

We define for the symbolic states

$$((l_A, D_{e,A}), (l_B, D_{e,B})) = \text{sync}((l_A, D_A), (l_B, D_B))$$

and by Definition 3.10, we know that  $(l_A, u_{e,A}) \in (l_A, D_{e,A})$  and  $(l_B, u_{e,B}) \in (l_B, D_{e,B})$ .

Due to forward stability (Proposition 3.7), the existence of  $(l_A, u_{e,A}) \xrightarrow[\text{TSVC}]{\mu} (l_{\mu,A}, u_{\mu,A})$  implies the existence of a transition  $(l_A, D_{e,A}) \xrightarrow[\text{VCG}]{\mu_\varepsilon} (l_{\mu,A}, D_{\mu,A})$  with  $u_{\mu,A} \in D_{\mu,A}$ ,  $\mu_\varepsilon = \mu$  if  $\mu \in \Sigma$  and  $\mu_\varepsilon = \varepsilon$ , else. Due to Definition 3.11 and  $v_A^{\text{VC}} \sqsubseteq_{n+1} v_B^{\text{VC}}$ , this implies the existence of a zone  $D_{\mu,i,A} \subseteq D_{\mu,A}$  with  $(l_{\mu,A}, u_{\mu,A}) \in (l_{\mu,A}, D_{\mu,i,A})$  such that there exists an outgoing transition  $v_B^{\text{VC}} \xrightarrow[\text{VCG}]{\mu_\varepsilon} (l_{\mu,B}, D_{\mu,B})$  such that there exists a zone  $D_{\mu,i,B} \subseteq D_{\mu,B}$  with  $(l_{\mu,A}, D_{\mu,i,A}) \sqsubseteq_n (l_{\mu,B}, D_{\mu,i,B})$ .

Since  $(l_{\mu,A}, D_{\mu,i,A})$  and  $(l_{\mu,B}, D_{\mu,i,B})$  are both non-empty and AB-semi-synchronized (due to Proposition 3.8 and since substates of AB-semi-synchronized states are AB-semi-synchronized, too), we can apply the induction hypothesis here. Therefore,

$$\forall (l_{\mu,A}, u_{\mu,A}) \in (l_{\mu,A}, D_{\mu,A}) : \exists (l_{\mu,B}, u_{\mu,B}) \in (l_{\mu,B}, D_{\mu,B}) : (l_{\mu,A}, u_{\mu,A}) \sqsubseteq_n (l_{\mu,B}, u_{\mu,B})$$

holds. Therefore, there exists a  $(l_{\mu,B}, u_{\mu,B}) \in (l_{\mu,B}, D_{\mu,B})$  such that  $(l_{\mu,A}, u_{\mu,A}) \sqsubseteq_n (l_{\mu,B}, u_{\mu,B})$  and we only have to show that there exists a transition  $(l_B, u_{e,B}) \xrightarrow[\text{TSVC}]{\mu} (l_{\mu,B}, u_{\mu,B})$ .

Due to backward stability (Proposition 3.6), the existence of a transition  $(l_B, D_{e,B}) \xrightarrow[\text{VCG}]{\mu_\varepsilon} (l_{\mu,B}, D_{\mu,B})$  with  $(l_{\mu,B}, u_{\mu,B}) \in (l_{\mu,B}, D_{\mu,B})$  implies the existence of a transition  $(l_B, u_{\text{help},B}) \xrightarrow[\text{TSVC}]{\mu} (l_{\mu,B}, u_{\mu,B})$ .

$(l_{\mu,B}, u_{\mu,B})$  with  $(l_B, u_{\text{help},B}) \in v_B^{\text{VC}}$ . In the following, we show that  $u_{\text{help},B} = u_B$ , which implies the transition  $(l_B, u_B) \xrightarrow[\text{TSVC}]{\mu} (l_{\mu,B}, u_{\mu,B})$ . We distinguish two subcases here:

1.  $\mu \in \mathbb{T}$ . By Definition 3.3, we know that  $\forall i \in [0, |C_A| + |C_B| - 1] : u_{\text{help},B}(\chi_i) + \mu = u_{\mu,B}(\chi_i)$ . Due to  $(l_{\mu,A}, u_{\mu,A}) \sqsubseteq_n (l_{\mu,B}, u_{\mu,B})$  and  $\text{virt}(u_A) = \text{virt}(u_B)$ , we can show

$$\begin{aligned} \forall i \in [0, |C_A| + |C_B| - 1] : u_{\text{help},B}(\chi_i) + \mu &= u_{\mu,B}(\chi_i) \\ &= u_{\mu,A}(\chi_i) \\ &= u_A(\chi_i) + \mu \\ &= u_B(\chi_i) + \mu, \end{aligned}$$

which implies  $\text{virt}(u_{\text{help},B}) = \text{virt}(u_B)$ .

2.  $\mu \in \Sigma$ . By Definition 3.3, we know that  $\forall i \in [0, |C_A| + |C_B| - 1] : u_{\text{help},B}(\chi_i) = u_{\mu,B}(\chi_i)$ . Due to  $(l_{\mu,A}, u_{\mu,A}) \sqsubseteq_n (l_{\mu,B}, u_{\mu,B})$  and  $\forall j \in [0, |C_A| + |C_B| - 1] : u_A(\chi_j) = u_B(\chi_j)$ , we can show

$$\begin{aligned} \forall i \in [0, |C_A| + |C_B| - 1] : u_{\text{help},B}(\chi_i) &= u_{\mu,B}(\chi_i) \\ &= u_{\mu,A}(\chi_i) \\ &= u_A(\chi_i) \\ &= u_B(\chi_i), \end{aligned}$$

which implies  $\text{virt}(u_{\text{help},B}) = \text{virt}(u_B)$ .

Since  $(l_B, u_B), (l_B, u_{\text{help},B}) \in v_B^{\text{VC}}$ ,  $v_B^{\text{VC}}$  is AB-semi-synchronized, and  $\text{virt}(u_{\text{help},B}) = \text{virt}(u_B)$  hold, Corollary P.1 implies  $u_{\text{help},B} = u_B$ . Therefore, there exists a transition  $(l_B, u_B) \xrightarrow[\text{TSVC}]{\mu} (l_{\mu,B}, u_{\mu,B})$  with  $(l_{\mu,A}, u_{\mu,A}) \sqsubseteq_n (l_{\mu,B}, u_{\mu,B})$  and the induction step holds.

Now we show the opposite direction.

**Hypothesis:** If  $v_A^{\text{VC}}$  is non-empty and AB-semi-synchronized and  $v_B^{\text{VC}}$  is non-empty and AB-semi-synchronized with  $D_A \equiv_{\text{virtual}} D_B$ , then

$$\forall (l_A, u_A) \in v_A^{\text{VC}} : \exists (l_B, u_B) \in v_B^{\text{VC}} : (l_A, u_A) \sqsubseteq_n (l_B, u_B)$$

implies  $v_A^{\text{VC}} \sqsubseteq_n v_B^{\text{VC}}$ .

**Base Case:** The hypothesis holds if  $n = 0$ .

**Induction Step:** If the hypothesis holds for  $n$ , then it also holds for  $n + 1$ .

Since the base case is obviously implied by the precondition  $D_A \equiv_{\text{virtual}} D_B$ , we only show the induction step. The induction step can only be false, if

$$\forall (l_A, u_A) \in v_A^{\text{VC}} : \exists (l_B, u_B) \in v_B^{\text{VC}} : (l_A, u_A) \not\sqsubseteq_{n+1} (l_B, u_B)$$

is true. Therefore, we assume this to be the case. To show the induction step, we have to prove that  $v_A^{\text{VC}} \sqsubseteq_{n+1} v_B^{\text{VC}}$  holds. Since  $D_A \equiv_{\text{virtual}} D_B$  holds by the precondition, the first condition is fulfilled and we have to show that for the AB-synchronized symbolic states

$$((l_A, D_{e,A}), (l_B, D_{e,B})) = \text{sync}((l_A, D_A), (l_B, D_B))$$

the existence of an outgoing transition  $(l_A, D_{e,A}) \xrightarrow[VCG]{\mu} (l_{\mu,A}, D_{\mu,A})$  implies the existence of a finite set of symbolic states  $\{(l_{\mu,A}, D_{\mu,0,A}), (l_{\mu,A}, D_{\mu,1,A}), \dots\}$  with  $(\bigcup D_{\mu,i,A}) = D_{\mu,A}$  and for any  $(l_{\mu,A}, D_{\mu,i,A})$  exists an outgoing transition  $(l_B, D_{e,B}) \xrightarrow[VCG]{\mu} (l_{\mu,B}, D_{\mu,B})$  such that there exists a zone  $D_{\mu,i,B} \subseteq D_{\mu,B}$  with  $(l_{\mu,A}, D_{\mu,i,A}) \sqsubseteq_n (l_{\mu,B}, D_{\mu,i,B})$ . In the following, we assume the existence of a transition  $(l_A, D_{e,A}) \xrightarrow[VCG]{\mu} (l_{\mu,A}, D_{\mu,A})$  (otherwise  $v_A^{\text{VC}} \sqsubseteq_{n+1} v_B^{\text{VC}}$  holds trivially).

Due to backward stability (Proposition 3.6), for each  $(l_{\mu,A}, u_{\mu,A}) \in (l_{\mu,A}, D_{\mu,A})$  exists a  $(l_A, u_{e,A}) \in (l_A, D_{e,A})$ , such that there exists a transition  $(l_A, u_{e,A}) \xrightarrow[TSVC]{\mu_d} (l_{\mu,A}, u_{\mu,A})$  (with  $\mu_d \in \mathbb{N}^{\geq 0}$  if  $\mu = \varepsilon$  and  $\mu_d = \mu$  else). Due to Definition 3.10, we know that there exists a  $(l_B, u_{e,B}) \in (l_B, D_{e,B})$  such that there exists a  $(l_A, u_A) \in (l_A, D_A)$  and a  $(l_B, u_B) \in (l_B, D_B)$  such that

$$((l_A, u_{e,A}), (l_B, u_{e,B})) = \text{sync}((l_A, u_A), (l_B, u_B))$$

holds. By Definition 3.5 we know that  $\text{virt}(u_A) = \text{virt}(u_B)$  (otherwise we are not allowed to apply the sync function) and since we assumed that there exists a state in  $(l_B, D_B)$  which virtually simulates  $(l_A, u_A)$  in order  $n + 1$  and since we know by Corollary P.1 that  $(l_B, u_B)$  is the only state with  $\text{virt}(u_A) = \text{virt}(u_B)$ , we know that  $(l_A, u_A) \sqsubseteq_{n+1} (l_B, u_B)$  and, therefore,  $(l_A, u_{e,A}) \sqsubseteq_{n+1} (l_B, u_{e,B})$ .

Therefore, and by Definition 3.6, the existence of the transition  $(l_A, u_{e,A}) \xrightarrow[TSVC]{\mu_d} (l_{\mu,A}, u_{\mu,A})$  implies the existence of a transition  $(l_B, u_{e,B}) \xrightarrow[TSVC]{\mu_d} (l_{\mu,B}, u_{\mu,B})$  with  $(l_{\mu,A}, u_{\mu,A}) \sqsubseteq_n (l_{\mu,B}, u_{\mu,B})$ . Being aware of that fact, we distinguish two cases:

1.  $\mu = \varepsilon$ . In this case, we define the finite set of symbolic states  $\{(l_{\mu,A}, D_{\mu,0,A}), (l_{\mu,A}, D_{\mu,1,A}), \dots\}$  to be equal to  $\{(l_{\mu,A}, D_{\mu,A})\}$ . Therefore,  $(\bigcup D_{\mu,i,A}) = D_{\mu,A}$  holds trivially. Moreover, there exists an outgoing transition  $(l_B, D_B) \xrightarrow[VCG]{\varepsilon} (l_{\mu,B}, D_{\mu,B})$  by Definition 3.7. Due to forward stability,  $(l_{\mu,B}, u_{\mu,B}) \in (l_{\mu,B}, D_{\mu,B})$  and, therefore,  $D_{\mu,A} \leq_{\text{virtual}} D_{\mu,B}$  holds. The zone

$$D_{\mu,0,B} = \{u_{\mu,0,B} \in D_{\mu,B} \mid \exists u_{\mu,A} \in D_{\mu,A} : \text{virt}(u_{\mu,0,B}) = \text{virt}(u_{\mu,A})\}$$

is obviously a subzone of  $D_{\mu,B}$  (i.e.  $D_{\mu,0,B} \subseteq D_{\mu,B}$ ). Since  $D_{\mu,A} \equiv_{\text{virtual}} D_{\mu,0,B}$  holds, both symbolic states are non-empty and AB-semi-synchronized by Proposition 3.8, and for any  $(l_{\mu,A}, u_{\mu,A})$  exists a  $(l_{\mu,B}, u_{\mu,B})$  with  $(l_{\mu,A}, u_{\mu,A}) \sqsubseteq_n (l_{\mu,B}, u_{\mu,B})$ , we can apply the induction hypothesis, which implies  $(l_{\mu,A}, D_{\mu,A}) \sqsubseteq_n (l_{\mu,B}, D_{\mu,0,B})$  and, therefore, the induction step holds in this case.

2.  $\mu \in \Sigma$ . By using the extract-regions operator of Appendix S, we split  $D_{\mu,A}$  into its regions and we define the finite set of symbolic states  $\{(l_{\mu,A}, D_{\mu,0,A}), (l_{\mu,A}, D_{\mu,1,A}), \dots\}$  such that each of the  $D_{\mu,i,A}$  represents a region of  $D_{\mu,A}$ . Since  $(\bigcup D_{\mu,i,A}) = D_{\mu,A}$  holds by Definition S.3, we only have to show that for any  $D_{\mu,i,A}$  exists a transition  $(l_B, D_{e,B}) \xrightarrow[VCG]{\mu} (l_{\mu,B}, D_{\mu,B})$  such that there exists a zone  $D_{\mu,i,B} \subseteq D_{\mu,B}$  with  $(l_{\mu,A}, D_{\mu,i,A}) \sqsubseteq_n (l_{\mu,B}, D_{\mu,i,B})$ .

Since an action transition can only reset an original clock, we know that for any  $u_{\mu,A} \in D_{\mu,A}$  exists a  $u_{e,A} \in D_{e,A}$  with  $(l_A, u_{e,A}) \xrightarrow[TSVC]{\mu} (l_{\mu,A}, u_{\mu,A})$  and  $\text{virt}(u_{e,A}) = \text{virt}(u_{\mu,A})$ . Due

to Corollary P.1, we know that there is only a single  $u_{e,A}$  fulfilling this property. Since  $(l_A, u_{e,A})$  is AB-synchronized, we know that the original clocks of  $u_{e,A}$  have the same values as the corresponding virtual clocks. The same holds for any other  $u_{\mu,1,A} \in D_{\mu,A}$  and since the virtual clock values of  $u_{\mu,A}$  and  $u_{\mu,1,A}$  fulfill the properties of Definition 2.5, we know that  $u_{e,A}$  and  $u_{e,1,A}$  (the predecessor of  $u_{\mu,1,A}$ ) are in the same region.

Due to the precondition, we know that there exists a  $u_{e,B} \in D_{e,B}$  such that  $(l_A, u_{e,A}) \sqsubseteq_{n+1} (l_B, u_{e,B})$ . Due to  $\text{virt}(u_{e,A}) = \text{virt}(u_{e,B})$  and since  $(l_B, u_{e,B})$  is AB-synchronized and, therefore, the original clock values are equal to the corresponding virtual clock values, we know that for any  $u_{e,1,B} \in D_{e,B}$ , which has a partner  $u_{e,1,A} \in D_{e,A}$  with  $u_{e,1,A} \simeq_k u_{e,A}$  and  $\text{virt}(u_{e,1,B}) = \text{virt}(u_{e,1,A})$  the statement  $u_{e,B} \simeq_k u_{e,1,B}$  holds.

Due to  $(l_A, u_{e,A}) \sqsubseteq_{n+1} (l_B, u_{e,B})$  and  $(l_A, u_{e,A}) \xrightarrow{TSVC} (l_{\mu,A}, u_{\mu,A})$ , there exists a transition  $(l_B, u_{e,B}) \xrightarrow{TSVC} (l_{\mu,B}, u_{\mu,B})$  with  $(l_{\mu,A}, u_{\mu,A}) \sqsubseteq_n (l_{\mu,B}, u_{\mu,B})$ . This is also the case for any other state, which is region equivalent to  $(l_A, u_{e,A})$  (respectively  $(l_B, u_{e,B})$ ). Moreover, by Proposition T.2, the target state is region equivalent to  $(l_{\mu,B}, u_{\mu,B})$ .

Therefore, there exists a transition  $l_B \xrightarrow{TA} l_{\mu,B}$ , such that for  $u_{e,B}$  the statements  $u_{e,B} \models g$  and  $[R \rightarrow 0]u_{e,B} \models I(l_{\mu,B})$  hold. Therefore, by Definition 3.7 and Definition 2.7, there exists a transition  $(l_B, D_{e,B}) \xrightarrow{VCG} (l_{\mu,B}, D_{\mu,B})$  such that  $u_{\mu,B} \in D_{\mu,B}$ . Moreover, for any  $u_{e,1,B} \in D_{e,B}$  with  $u_{e,B} \simeq_k u_{e,1,B}$  the statement  $u_{e,1,B} \in D_{\mu,B}$  holds (Proposition T.2). Since the region of  $D_{\mu,B}$  which contains  $u_{e,B}$  can, once again, easily be extracted from  $D_{\mu,B}$  by using the extract-regions operator of Appendix S (obviously, the region is a subzone of  $D_{\mu,B}$ ) and, moreover, since the region is virtually equivalent to  $D_{\mu,i,A}$ , we can apply the induction hypothesis and the induction step holds.

Therefore, we know that if  $v_A^{\text{VC}}, v_B^{\text{VC}}$  are non-empty and AB-semi-synchronized with  $D_A \equiv_{\text{virtual}} D_B$ , then

$$\forall (l_A, u_A) \in v_A^{\text{VC}} : \exists (l_B, u_B) \in v_B^{\text{VC}} : (l_A, u_A) \sqsubseteq_n (l_B, u_B)$$

holds if and only if  $v_A^{\text{VC}} \sqsubseteq_n v_B^{\text{VC}}$  holds. We remind the reader of the fact that for the initial symbolic state  $(l_{0,A}, u_{0,A}) \in (l_{0,A}, D_{0,A})$  implies  $u_{0,A} = [C_A \cup \{\chi_0, \dots, \chi_{|C_A|+|C_B|-1}\} \rightarrow 0]$  (and the same for  $B$ ). Now we can easily show the proposition:

$$\begin{aligned} A &\sqsubseteq_n B \\ \Leftrightarrow A_{\text{TSVC}} &\sqsubseteq_n B_{\text{TSVC}} && \text{(Theorem 3.1)} \\ \Leftrightarrow (l_{0,A}, u_{0,A}) &\sqsubseteq_n (l_{0,B}, u_{0,B}) && \text{(Definition 3.6)} \\ \Leftrightarrow \forall (l_{0,A}, u_{0,A}) \in (l_{0,A}, D_{0,A}) : &\exists (l_{0,B}, u_{0,B}) \in (l_{0,B}, D_{0,B}) : (l_A, u_A) \sqsubseteq_n (l_B, u_B) \\ \Leftrightarrow (l_{0,A}, D_{0,A}) &\sqsubseteq_n (l_{0,B}, D_{0,B}) && \text{(previously)} \\ \Leftrightarrow A_{\text{VCG}} &\sqsubseteq_n B_{\text{VCG}} && \text{(Definition 3.11)} \end{aligned}$$

□

Analogously, we can show that  $v_A^{\text{VC}} \sim_n v_B^{\text{VC}}$  with  $(l_A, D_A)$  and  $(l_B, D_B)$  being AB-semi-synchronized and  $D_A \equiv_{\text{virtual}} D_B$  is equivalent to

$$\forall v_A^{\text{TV}} \in v_A^{\text{VC}} : \exists v_B^{\text{TV}} \in v_B^{\text{VC}} : v_A^{\text{TV}} \sim_n v_B^{\text{TV}} \wedge \forall v_B^{\text{TV}} \in v_B^{\text{VC}} : \exists v_A^{\text{TV}} \in v_A^{\text{VC}} : v_A^{\text{TV}} \sim_n v_B^{\text{TV}},$$

which implies Theorem 3.2.

## V. k-Normalization preserves (Bi-)Simulation of VCG

We show Proposition 3.11 here. Instead of Virtual Bisimulation, we show the proposition for Virtual Simulation. The proposition for Virtual Bisimulation can be shown analogously.

To do so, we start with the observation that if the norm operator is applied to two virtual equivalent zones, the result is virtually equivalent, too.

### Proposition V.1. (norm and virtual equivalence)

Assume two sets of clocks  $C_A, C_B$ , a value  $i \in \mathbb{N}^{\geq 0}$ , a function  $k : C_A \cup C_B \cup \{\chi_0, \dots, \chi_{|C_A|+|C_B|-1}\} \rightarrow \mathbb{N}^{\geq 0}$ , and AB-semi-synchronized zones  $D_A \in \mathcal{D}(C_A \cup \{\chi_0, \dots, \chi_i\})$ ,  $D_B \in \mathcal{D}(C_B \cup \{\chi_0, \dots, \chi_i\})$ .  $D_A \equiv_{\text{virtual}} D_B$  implies  $\text{norm}(D_A, k) \equiv_{\text{virtual}} \text{norm}(D_B, k)$ .

### Proof:

Before we prove this proposition, we remind the reader of the extract-virtual function from Definition O.1, which extracts the submatrix from a DBM, which belongs to the virtual clocks. Since the extract-virtual function does not change any entry,  $\text{extract-virtual}(\text{norm}(M, k)) = \text{norm}(\text{extract-virtual}(M), k)$  trivially holds for any (canonic) DBM  $M$  corresponding to an AB-semi-synchronized symbolic state. We can show

$$\begin{aligned} D_A \equiv_{\text{virtual}} D_B &\text{ implies } [\text{extract-virtual}(M_A)] = [\text{extract-virtual}(M_B)] \text{ (Prop. O.4)} \\ &\text{ implies } \text{extract-virtual}(M_A) = \text{extract-virtual}(M_B) \\ &\text{ (since } M_A \text{ and } M_B \text{ are canonic, so are their virtual extracts)} \\ &\text{ implies } \text{norm}(\text{extract-virtual}(M_A), k) = \text{norm}(\text{extract-virtual}(M_B), k) \\ &\text{ implies } \text{extract-virtual}(\text{norm}(M_A, k)) = \text{extract-virtual}(\text{norm}(M_B, k)) \\ &\text{ implies } \text{norm}(D_A, k) \equiv_{\text{virtual}} \text{norm}(D_B, k). \end{aligned}$$

□

If the original zone is part of an AB-synchronized symbolic state, the pair consisting of the location and the normalized zone is also AB-synchronized, as the following proposition shows:

### Proposition V.2. (AB-synchronized normalized symbolic states)

Assume two sets of clocks  $C_A, C_B$ , a function  $k : C_A \cup C_B \cup \{\chi_0, \dots, \chi_{|C_A|+|C_B|-1}\} \rightarrow \mathbb{N}^{\geq 0}$ , and any AB-synchronized symbolic state  $(l, D)$ . The symbolic state  $(l, \text{norm}(D, k))$  is AB-synchronized.

**Proof:**

Since the proof for an AB-synchronized symbolic state of  $B$  is similar to the proof for an AB-synchronized symbolic state of  $A$ , we only show the latter.

By Definition 3.4,

$$\forall i \in [0, |C_A| - 1] : \forall u \in D : u(C_A[i]) = u(\chi_i)$$

holds. Therefore,  $\forall i \in [0, |C_A| - 1] : C_A[i] - \chi_i \leq 0 \wedge \chi_i - C_A[i] \leq 0$  holds. The canonic DBM  $M$  of  $D$  transforms this statement into DBM entries, which fulfill

$$\forall i \in [0, |C_A| - 1] : \sim_{i, |C_A|+i} \leq \wedge z_{i, |C_A|+i} = 0$$

and

$$\forall i \in [0, |C_A| - 1] : \sim_{|C_A|+i, i} \leq \wedge z_{|C_A|+i, i} = 0$$

Since  $k(\chi_i) \in \mathbb{N}^{\geq 0}$ ,  $z_{i, |C_A|+i} \leq k(\chi_i)$  and  $z_{|C_A|+i, i} \leq k(\chi_i)$  holds, which implies that the normalisation operator does not change these entries. Therefore, the canonic DBM  $\text{norm}(M, k)$  contains the same entries and

$$\forall i \in [0, |C_A| - 1] : \forall u \in \text{norm}(D, k) : u(C_A[i]) = u(\chi_i)$$

holds, which implies that  $(l, \text{norm}(D, k))$  is AB-synchronized.  $\square$

Now we can show our proposition.

**Proposition V.3. (k-Normalization preserves (Bi-)Simulation of VCGs)**

Assume two diagonal-free TA  $A, B$  using the sets of clocks  $C_A, C_B$ , with VCG  $A_{\text{VCG}}$  of  $A$  regarding  $B$  and VCG  $B_{\text{VCG}}$  of  $B$  regarding  $A$ , the AB-synchronized symbolic states  $(l_A, D_A)$  of  $A_{\text{VCG}}$  and  $(l_B, D_B)$  of  $B_{\text{VCG}}$ , and a normalization function  $k$ . Moreover, we require  $D_A \equiv_{\text{virtual}} D_B$ .

$(l_A, D_A) \sqsubseteq_n (l_B, D_B)$  holds if and only if  $(l_A, \text{norm}(D_A, k)) \sqsubseteq_n (l_B, \text{norm}(D_B, k))$  holds.

**Proof:**

We denote  $D_{n,A} = \text{norm}(D_A, k)$  and  $D_{n,B} = \text{norm}(D_B, k)$ , resp.  $v_{n,A}^{\text{VC}} = (l_A, D_{n,A})$  and  $v_{n,B}^{\text{VC}} = (l_B, D_{n,B})$ . From Appendix U, we know that for two non-empty symbolic states  $v_A^{\text{VC}}, v_B^{\text{VC}}$  with  $D_A \equiv_{\text{virtual}} D_B$ ,  $v_A^{\text{VC}} \sqsubseteq_n v_B^{\text{VC}}$  holds if and only if

$$\forall (l_A, u_A) \in v_A^{\text{VC}} : \exists (l_B, u_B) \in v_B^{\text{VC}} : (l_A, u_A) \sqsubseteq_n (l_B, u_B)$$

holds. We first show that  $v_A^{\text{VC}} \sqsubseteq_n v_B^{\text{VC}}$  implies  $v_{n,A}^{\text{VC}} \sqsubseteq_n v_{n,B}^{\text{VC}}$  and afterwards the opposite direction.

By Proposition V.1,  $v_A^{\text{VC}} \sqsubseteq_n v_B^{\text{VC}}$  implies  $D_{n,A} \equiv_{\text{virtual}} D_{n,B}$ . Therefore, we only have to show

$$\forall (l_A, u_{n,A}) \in (l_A, D_{n,A}) : \exists (l_B, u_{n,B}) \in (l_B, D_{n,B}) : (l_A, u_{n,A}) \sqsubseteq_n (l_B, u_{n,B}).$$

For any  $(l_A, u_{n,A}) \in (l_A, D_{n,A})$  exists a  $(l_B, u_{n,B}) \in (l_B, D_{n,B})$  such that  $\text{virt}(u_{n,A}) = \text{virt}(u_{n,B})$  due to  $D_{n,A} \equiv_{\text{virtual}} D_{n,B}$ . Moreover, by Proposition 2.2, we know that there exists a region equivalent state  $(l_A, u_A) \in v_A^{\text{VC}}$ . Due to  $v_A^{\text{VC}} \sqsubseteq_n v_B^{\text{VC}}$ , there exists a  $(l_B, u_B) \in v_B^{\text{VC}}$  such that  $(l_A, u_A) \sqsubseteq_n (l_B, u_B)$ .

$u_B$ ) holds (which implies  $\text{virt}(u_A) = \text{virt}(u_B)$ ). By Proposition T.4 we only have to show  $(l_B, u_{n,B}) \simeq_k (l_B, u_B)$ , which implies  $(l_A, u_{n,A}) \sqsubseteq_n (l_B, u_{n,B})$ .

Since  $\text{virt}(u_A) = \text{virt}(u_B)$  and  $u_A \simeq_k u_{n,A}$ , we know that all virtual clock values fulfill the requirements of Definition 2.5. Since we assumed  $v_B^{\text{VC}}$  to be AB-synchronized, which implies  $v_{n,B}^{\text{VC}}$  to be AB-synchronized by Proposition V.2, we know that  $\forall i \in [0, |C_B| - 1] : u_B(C_B[i]) = u_B(\chi_i) \wedge u_{n,B}(C_B[i]) = u_{n,B}(\chi_i)$ . Therefore, if there was any clock  $c \in C_B$ , such that any condition of Definition 2.5 does not hold, the same would be the case for the corresponding virtual clock. Since this cannot be the case due to  $\text{virt}(u_A) = \text{virt}(u_B)$  and  $u_A \simeq_k u_{n,A}, u_B \simeq_k u_{n,B}$  holds.

Now we show the opposite direction, i.e. that  $\text{norm}(v_A^{\text{VC}}, k) \sqsubseteq_n \text{norm}(v_B^{\text{VC}}, k)$  implies  $v_A^{\text{VC}} \sqsubseteq_n v_B^{\text{VC}}$  if  $D_A \equiv_{\text{virtual}} D_B$  holds. This is the case if and only if

$$\forall (l_A, u_A) \in v_A^{\text{VC}} : \exists (l_B, u_B) \in v_B^{\text{VC}} : (l_A, u_A) \sqsubseteq_n (l_B, u_B).$$

holds. For any  $(l_A, u_A) \in v_A^{\text{VC}}$  exists a  $(l_B, u_B) \in v_B^{\text{VC}}$  such that  $\text{virt}(u_A) = \text{virt}(u_B)$  due to  $D_A \equiv_{\text{virtual}} D_B$ . Moreover we know that  $(l_A, u_A) \in v_{n,A}^{\text{VC}}$  and  $(l_B, u_B) \in v_{n,B}^{\text{VC}}$ , due to  $D_A \subseteq D_{n,A}$  and  $D_B \subseteq D_{n,B}$ . Due to  $\text{norm}(v_A^{\text{VC}}, k) \sqsubseteq_n \text{norm}(v_B^{\text{VC}}, k)$ , we know that there exists a  $(l_B, u_{n,B}) \in v_{n,B}^{\text{VC}}$  such that  $(l_A, u_A) \sqsubseteq_n (l_B, u_{n,B})$  holds. This can only be the case if  $\text{virt}(u_A) = \text{virt}(u_{n,B})$ . Due to Corollary P.1 and  $\text{virt}(u_{n,B}) = \text{virt}(u_A) = \text{virt}(u_B)$ ,  $(l_B, u_B) = (l_B, u_{n,B})$  holds, which implies  $(l_A, u_A) \sqsubseteq_n (l_B, u_B)$ .  $\square$

## W. Implementing extract-virtual-constraint

DBMs were introduced in section 2, including the term canonic, and more detailed notations are explained in Appendix O. As a short reminder, the element in line  $i$  and column  $j$  is denoted as  $(\preceq_{i,j}, z_{i,j})$ . This section shows how to implement the extract-virtual-constraint operator, using DBMs. The result is shown in the following proposition:

### Proposition W.1. (Implementing the extract-virtual-constraint operator)

Assume a set of clocks  $C$  and a zone  $D \in \mathcal{D}(C \cup \{\chi_0, \dots, \chi_{i-1}\})$  with canonic DBM  $M \in \mathcal{M}(C \cup \{\chi_0, \dots, \chi_{i-1}\})$ , such that  $D = [M]$ .

$$\begin{aligned} \text{extract-virtual-constraint}(D) = & \bigwedge_{j,k \in [0, i-1]} \chi_j - \chi_k \preceq_{|C|+1+j, |C|+1+k} z_{|C|+1+j, |C|+1+k} \\ & \wedge \bigwedge_{j \in [0, i-1]} \chi_j \preceq_{|C|+1+j, 0} z_{|C|+1+j, 0} \wedge -\chi_j \preceq_{0, |C|+1+j} z_{0, |C|+1+j} \end{aligned}$$

holds.

### Proof:

To show this proposition, we remind the reader of the extract-virtual function for DBMs, which we defined in Definition O.1. Due to Proposition O.1, we know that the extract-virtual function keeps the zone of  $M$  virtually equivalent, i.e.

$$\forall u_1 \in [M] : \exists u_2 \in [\text{extract-virtual}(M)] : \text{virtual}(u_1) = \text{virtual}(u_2) \wedge$$



$$\forall u_1 \in [\text{extract-virtual}(M)] : \exists u_2 \in [M] : \text{virtual}(u_1) = \text{virtual}(u_2)$$

holds. In the following, we first show

$$[\text{extract-virtual-constraint}([M])] \subseteq [\text{extract-virtual-constraint}([\text{extract-virtual}(M)])]$$

and afterwards we show

$$[\text{extract-virtual-constraint}([\text{extract-virtual}(M)])] \subseteq [\text{extract-virtual-constraint}([M])].$$

We conclude that  $\text{extract-virtual-constraint}([\text{extract-virtual}(M)])$  can be used as result for  $\text{extract-virtual-constraint}([M])$ . Since  $\text{extract-virtual}(M)$  uses virtual clocks only, the virtual constraint of this DBM can easily be calculated and we show that it is equivalent to the right hand side of the equation to show.

For any  $u_{\text{any}}$ ,

$$u_{\text{any}} \in [\text{extract-virtual-constraint}([M])]$$

implies the existence of a  $u_M \in [M]$  with  $\text{virt}(u_M) = \text{virt}(u_{\text{any}})$  by soundness of the  $\text{extract-virtual-constraint}$  operator. Since  $[M] \leq_{\text{virtual}} [\text{extract-virtual}(M)]$  there exists a  $u_{\text{extr}_M} \in [\text{extract-virtual}(M)]$  with  $\text{virt}(u_{\text{extr}_M}) = \text{virt}(u_M) = \text{virt}(u_{\text{any}})$ .

Due to completeness of the  $\text{extract-virtual-constraint}$  operator,

$$u_{\text{extr}_M} \models \text{extract-virtual-constraint}([\text{extract-virtual}(M)])$$

holds, too. Finally, since  $\text{extract-virtual-constraint}([\text{extract-virtual}(M)]) \in \mathcal{B}(\chi_0, \dots, \chi_{i-1})$ ,

$$u_{\text{any}} \models \text{extract-virtual-constraint}([\text{extract-virtual}(M)])$$

and, therefore,  $u_{\text{any}} \in [\text{extract-virtual-constraint}([\text{extract-virtual}(M)])]$ .

Now we show the opposite direction. For any  $u_{\text{any}}$ ,

$$u_{\text{any}} \in [\text{extract-virtual-constraint}([\text{extract-virtual}(M)])]$$

implies the existence of a  $u_{\text{extr}_M} \in \text{extract-virtual}(M)$  with  $\text{virt}(u_{\text{extr}_M}) = \text{virt}(u_{\text{any}})$  by soundness of the  $\text{extract-virtual-constraint}$  operator. Since  $[\text{extract-virtual}(M)] \leq_{\text{virtual}} [M]$  there exists a  $u_M \in [M]$  with  $\text{virt}(u_M) = \text{virt}(u_{\text{extr}_M}) = \text{virt}(u_{\text{any}})$ . Due to completeness of the  $\text{extract-virtual-constraint}$  operator,

$$u_M \models \text{extract-virtual-constraint}([M])$$

holds, too. Finally, since  $\text{extract-virtual-constraint}([M]) \in \mathcal{B}(\chi_0, \dots, \chi_{i-1})$

$$u_{\text{any}} \models \text{extract-virtual-constraint}([M])$$

and, therefore,  $u_{\text{any}} \in [\text{extract-virtual-constraint}([M])]$ .

Since the solution sets of  $\text{extract-virtual-constraint}([M])$  and  $\text{extract-virtual-constraint}([\text{extract-virtual}(M)])$  are the same, we conclude that the result of  $\text{extract-virtual-constraint}([\text{extract-virtual}(M)])$

can be used as the result for  $\text{extract-virtual-constraint}(M)$ . It is well-known that the clock constraint of a DBM  $M$

$$\begin{aligned} & \text{extract-virtual}(M) \\ = & \text{extract-virtual} \left( \begin{array}{ccc} (z_{0,0}, \preceq_{0,0}) & \cdots & (z_{0,|C|+i}, \preceq_{0,|C|+i}) \\ \vdots & \ddots & \vdots \\ (z_{|C|+i,0}, \preceq_{|C|+i,0}) & \cdots & (z_{|C|+i,|C|+i}, \preceq_{|C|+i,|C|+i}) \end{array} \right) \\ = & \left( \begin{array}{ccc} (z_{0,0}, \preceq_{0,0}) & (z_{0,|C|+1}, \preceq_{0,|C|+1}) & \cdots & (z_{0,|C|+i}, \preceq_{0,|C|+1,|C|+1}) \\ (z_{|C|+1,0}, \preceq_{|C|+1,0}) & (z_{|C|+1,|C|+1}, \preceq_{|C|+1,|C|+1}) & \cdots & (z_{|C|+1,|C|+i}, \preceq_{|C|+1,|C|+i}) \\ \vdots & \vdots & \ddots & \vdots \\ (z_{|C|+i,0}, \preceq_{|C|+i,0}) & (z_{|C|+i,|C|+1}, \preceq_{|C|+i,|C|+1}) & \cdots & (z_{|C|+i,|C|+i}, \preceq_{|C|+i,|C|+i}) \end{array} \right) \end{aligned}$$

is

$$\begin{aligned} \phi = & \bigwedge_{j,k \in [0, i-1]} \chi_j - \chi_k \preceq_{|C|+1+j, |C|+1+k} z_{|C|+1+j, |C|+1+k} \\ & \wedge \bigwedge_{j \in [0, i-1]} \chi_j \preceq_{|C|+1+j, 0} z_{|C|+1+j, 0} \wedge \neg \chi_j \preceq_{0, |C|+1+j} z_{0, |C|+1+j}, \end{aligned}$$

which implies  $[\phi] = [\text{extract-virtual}(M)]$ . We now show that  $\phi$  is a virtual constraint of  $\text{extract-virtual}(M)$ . Since  $\phi \in \mathcal{B}(\{\chi_0, \dots, \chi_{|C_A|+|C_B|-1}\})$ , we show one statement of Definition 4.1 after the other.

1. (Soundness) Any  $u_{\text{virtual}} : \{\chi_0, \dots, \chi_{i-1}\} \rightarrow \mathbb{T}$  with  $u_{\text{virtual}} \models \phi$  is also element of  $[\phi]$  and, therefore,  $u_{\text{virtual}} \in [\text{extract-virtual}(M)]$  holds. Since  $u_{\text{virtual}}$  is virtually equivalent to itself, soundness holds.
2. (Completeness) For any  $u_{\text{virtual}} \in [\text{extract-virtual}(M)]$ , the statement  $u_{\text{virtual}} \in [\phi]$  implies  $u_{\text{virtual}} \models \phi$ . Therefore, completeness holds.
3. (Simple Structure) Since  $\phi$  consists of  $i^2 + 2 * i = (i + 1)^2 - 1$  conjugated atomic constraints, simple structure holds (the minus one is due to the fact that we ignore the statement in which both clocks are the zero clock).
4. (Canonic) Since  $M$  is canonic,  $\text{extract-virtual}(M)$  is canonic, and, therefore,  $\phi$  is canonic.

All conditions of Definition 4.1 are fulfilled and  $\text{extract-virtual-constraint}$  can easily be implemented using DBMs.  $\square$

## X. Implementing vc and neg vc operator

We describe the operator  $\phi_1 \wedge \neg \phi_2$  here.

**Definition X.1. ( $\phi_1 \wedge \neg\phi_2$  operator)**

Assume a value  $i \in \mathbb{N}^{\geq 0}$  and two virtual constraints  $\phi_1, \phi_2 \in \mathcal{B}(\{\chi_0, \dots, \chi_{i-1}\})$ . We define

$$\phi_1 \wedge \neg\phi_2 = \{\phi_{r,0}, \dots, \phi_{r,n}\}$$

such that

1. (Non-Emptiness)  $\forall j \in [0, n] : [\phi_{r,j}] \neq \emptyset$ ,
2. (Disjointness)  $\forall j, k \in [0, n] : ([\phi_{r,j} \wedge \phi_{r,k}] \neq \emptyset)$  implies  $(j = k)$ ,
3. (Soundness)  $\forall j \in [0, n] : \forall u \in [\phi_{r,j}] : u \models \phi_1 \wedge u \not\models \phi_2$ , and
4. (Completeness)  $\forall u \in [\{\chi_0, \dots, \chi_{i-1}\} \rightarrow \mathbb{T}] : (u \models \phi_1 \wedge u \not\models \phi_2)$  implies  $(\exists j \in [0, n] : u \models \phi_{r,j})$ .

The intuitive way to implement this operator is to split  $\phi_2 = \phi_{2,0} \wedge \dots \wedge \phi_{2,i^2-1}$  into its atomic constraints and create each possible combination using negation. Afterwards, each of the resulting constraints is conjugated with  $\phi_1$ . We improve this procedure. All atomic constraints of the form  $c - c \leq 0$  are excluded from it (for obvious reasons). Moreover, if the atomic constraint of  $\phi_2$  is not stronger than the atomic constraint of  $\phi_1$ , this atomic constraint can also be excluded (since the negation will be conjugated with  $\phi_1$ ). Finally, we use the algorithm of Rokicki [22] to reduce the number of virtual constraints while the clock valuation that fulfill them are the same. Since in practice,  $\phi_1$  and  $\phi_2$  are usually quite similar, these improvements result into a set of virtual constraints which is usually quite small.

## Y. Implementing revert-action-trans

This section shows how to implement the revert-action-trans operator. To do so, we first define the behaviour of this operator.

**Definition Y.1. (revert-action-trans operator)**

Assume two TA  $A, B$ , using the sets of clocks  $C_A, C_B$ , an AB-synchronized symbolic state  $(l_A, D_A)$  of the VCG of  $A$  regarding  $B$ , and a transition  $(l_A, D_A) \xrightarrow{VCG} (l_{\sigma,A}, D_{\sigma,A})$  with  $\sigma \in \Sigma$ . Let  $l_A \xrightarrow{TA} l_{\sigma,A}$  be the corresponding transition of  $A$ . Let  $\phi_{\text{split}} \in \mathcal{B}(\chi_0, \dots, \chi_{|C_A|+|C_B|-1})$  be a virtual constraint with  $[\phi_{\text{split}}] \subseteq [\text{extract-virtual-constraint}(D_{\sigma,A})]$ . We define the operator

$$\begin{aligned} \text{revert-action-trans} : \mathcal{D}(C_{A,\chi}) \times \mathcal{B}(C_A) \times 2^{C_A} \times \mathcal{B}(C_A) \times \mathcal{B}(\chi_0, \dots, \chi_{|C_A|+|C_B|-1}) \\ \rightarrow \mathcal{B}(\chi_0, \dots, \chi_{|C_A|+|C_B|-1}) \end{aligned}$$

such that

$$\text{revert-action-trans}(D_A, g, R, I(l_{\sigma,A}), \phi_{\text{split}}) = \phi_{\text{res}}$$

with

1. (Usefulness)  $[\phi_{\text{res}}] \subseteq [\text{extract-virtual-constraint}(D_A)]$ ,
2. (Soundness) for any non-empty zone  $D_{\text{sub},A} \subseteq D_A$  with  $D_{\text{sub},A} \wedge \phi_{\text{res}} \neq \emptyset$  there exists an outgoing transition  $(l_A, D_{\text{sub},A}) \xrightarrow[VCG]{\sigma} (l_{\sigma,A}, D_{\text{sub},\sigma,A})$  which corresponds to  $l_A \xrightarrow[TA]{g,\sigma,R} l_{\sigma,A}$  with  $D_{\text{sub},\sigma,A} \wedge \phi_{\text{split}} \neq \emptyset$ , and
3. (Completeness) for any zone  $D_{\text{sub},A} \subseteq D_A$  with  $D_{\text{sub},A} \wedge \phi_{\text{res}} = \emptyset$  if there exists a transition  $(l_A, D_{\text{sub},A}) \xrightarrow[VCG]{\sigma} (l_{\sigma,A}, D_{\text{sub},\sigma,A})$  which corresponds to  $l_A \xrightarrow[TA]{g,\sigma,R} l_{\sigma,A}$  the statement  $D_{\text{sub},\sigma,A} \wedge \phi_{\text{split}} = \emptyset$  holds.

To implement this operator, we first show how to revert the  $\wedge$ - and reset-operator individually.

**Proposition Y.1. (Reverting the  $\wedge$ -operation)**

Assume two TA  $A, B$ , using the sets of clocks  $C_A, C_B$ , an AB-semi-synchronized symbolic state  $(l_A, D_A)$  of the VCG of  $A$  regarding  $B$ , and a clock constraint  $c \sim n$  with  $c \in C_A$ ,  $\sim \in \{<, \leq, \geq, >\}$ , and  $n \in \mathbb{N}^{\geq 0}$ . Let  $D_{\text{split}} \in \mathcal{D}(C_A \cup \{\chi_0, \dots, \chi_{|C_A|+|C_B|-1}\})$  be a zone such that  $D_{\text{split}} \subseteq (D_A \wedge c \sim n)$  holds. The statement

$$D_A \wedge \text{extract-virtual-constraint}(D_{\text{split}}) = D_{\text{split}}$$

holds.

**Proof:**

To show the proposition, we first show

$$D_A \wedge \text{extract-virtual-constraint}(D_{\text{split}}) \subseteq D_{\text{split}}$$

and afterwards the opposite direction.

To show the first direction, we assume any  $u_{\text{lhs}} \in D_A \wedge \text{extract-virtual-constraint}(D_{\text{split}})$  and show that  $u_{\text{lhs}} \in D_{\text{split}}$  holds. Obviously,  $u_{\text{lhs}} \in D_A$  and  $u_{\text{lhs}} \models \text{extract-virtual-constraint}(D_{\text{split}})$ . By Soundness of Definition 4.1, this implies that there exists a  $u_{\text{tmp}} \in D_{\text{split}}$ , such that  $\text{virt}(u_{\text{lhs}}) = \text{virt}(u_{\text{tmp}})$  holds. Due to  $D_{\text{split}} \subseteq D_A$ , we know that  $u_{\text{tmp}} \in D_A$ . Due to  $u_{\text{lhs}} \in D_A$ ,  $u_{\text{tmp}} \in D_A$ , and since  $(l_A, D_A)$  is AB-semi-synchronized, we are allowed to apply Corollary P.1, which implies  $u_{\text{lhs}} = u_{\text{tmp}}$  and, therefore,  $u_{\text{lhs}} \in D_{\text{split}}$ .

We now show the opposite direction. We assume any  $u_{\text{rhs}} \in D_{\text{split}}$  and show that  $u_{\text{rhs}} \in D_A \wedge \text{extract-virtual-constraint}(D_{\text{split}})$  holds. By Completeness of Definition 4.1 we know that  $u_{\text{rhs}} \models \text{extract-virtual-constraint}(D_{\text{split}})$ . Moreover, since  $D_{\text{split}} \subseteq D_A$ ,  $u_{\text{rhs}} \in D_A \wedge \text{extract-virtual-constraint}(D_{\text{split}})$  holds. □

To show how to revert the Reset-operation, we introduce the free-operation [21].

**Definition Y.2. (free Operator)**

Assume a set of clocks  $C$ . We define the free operator

$$\text{free} : \mathcal{D}(C) \times C \rightarrow \mathcal{D}(C)$$

such that for any zone  $D \in \mathcal{D}(C)$  and any  $c \in C$

$$\text{free}(D, c) = \{[c \rightarrow d]u \mid u \in D \wedge d \in \mathbb{T}\}$$

holds.

Using DBMs, the free operator is implementable [21].

**Proposition Y.2. (Reverting the Reset-operation)**

Assume two TA  $A, B$ , using the sets of clocks  $C_A, C_B$ , an symbolic state  $(l_A, D_A)$  of the VCG of  $A$  regarding  $B$ , and a clock  $c \in C_A \cup \{\chi_0, \dots, \chi_{|C_A|+|C_B|-1}\}$ . Let  $D_{\text{split}} \in \mathcal{D}(C_A \cup \{\chi_0, \dots, \chi_{|C_A|+|C_B|-1}\})$  be a zone such that  $D_{\text{split}} \subseteq \{c\}D_A$  holds. For the zone

$$D_{\text{res}} = D_A \cap \text{free}(D_{\text{split}}, c)$$

the statements

1.  $D_{\text{res}} \subseteq D_A$ ,
2. for any non-empty zone  $D_{\cap} \subseteq D_A$  with  $D_{\cap} \cap D_{\text{res}} \neq \emptyset$  the statement  $\{c\}D_{\cap} \cap D_{\text{split}} \neq \emptyset$ , and
3. for any non-empty zone  $D_{\text{diff}} \subseteq D_A \setminus D_{\text{res}}$  the statement  $\{c\}D_{\text{diff}} \cap D_{\text{split}} = \emptyset$

hold.

**Proof:**

Since  $D_A \cap \text{free}(D_{\text{split}}) \subseteq D_A$  obviously holds, we show the second and third statement, only. To show the second statement, we consider any  $u_{\cap, \text{res}} \in D_{\cap} \cap D_{\text{res}} = D_{\cap} \cap D_A \cap \text{free}(D_{\text{split}}, c)$ .

By Definition Y.2, we know that  $u_{\cap, \text{res}} \in \text{free}(D_{\text{split}}, c)$  implies  $\{c\}u_{\cap, \text{res}} \in D_{\text{split}}$ . By the definition of the reset operation, we know that  $u_{\cap, \text{res}} \in D_{\cap}$  implies  $\{c\}u_{\cap, \text{res}} \in \{c\}D_{\cap}$ . Since  $\{c\}u_{\cap, \text{res}} \in D_{\text{split}}$  and  $\{c\}u_{\cap, \text{res}} \in \{c\}D_{\cap}$  implies  $\{c\}u_{\cap, \text{res}} \in \{c\}D_{\cap} \cap D_{\text{split}}$ , the second statement holds.

To show the third statement we consider any  $u_{\text{diff}, c} \in \{c\}D_{\text{diff}}$  and show that  $u_{\text{diff}, c} \notin D_{\text{split}}$  holds.

By the definition of the reset operator, there exists at least a single  $u_{\text{diff}} \in D_{\text{diff}}$  such that  $u_{\text{diff}, c} = \{c\}u_{\text{diff}}$ . We consider any such  $u_{\text{diff}}$ . Since  $u_{\text{diff}} \notin \text{free}(D_{\text{split}}, c)$  the statement  $\{c\}u_{\text{diff}} \notin D_{\text{split}}$  holds by Definition Y.2 and the third statement holds.  $\square$

In the following, we show how to revert the reset operation for multiple resets. While in this appendix,  $R \subseteq C_A$  holds, we define  $R \subseteq C_A \cup \{\chi_0, \dots\}$  such that we can reuse this proposition in Appendix AB.

**Proposition Y.3. (Reverting multiple Resets)**

Assume two TA  $A, B$ , using the sets of clocks  $C_A, C_B$ , an symbolic state  $(l_A, D_A)$  of the VCG of  $A$  regarding  $B$ , and a set of clocks  $R \subseteq C_A \cup \{\chi_0, \dots, \chi_{|C_A|+|C_B|-1}\}$ . Let  $D_{\text{split}} \in \mathcal{D}(C_A \cup \{\chi_0, \dots, \chi_{|C_A|+|C_B|-1}\})$  be a zone such that  $D_{\text{split}} \subseteq R(D_A)$  holds. We define the function

$$\text{multiple-reset}(D_A, D_{\text{split}}, R)$$

$$= \begin{cases} D_{\text{split}} & \text{if } R = \emptyset, \\ D_A \cap \text{free}(\text{multiple-reset}(\{c\}D_A, D_{\text{split}}, R \setminus \{c\}), c) & \text{else, for any } c \in R. \end{cases}$$

For the zone  $D_{\text{res}} = \text{multiple-reset}(D_A, D_{\text{split}}, R)$  the statements

1.  $D_{\text{res}} \subseteq D_A$ ,
2. for any non-empty zone  $D_\cap \subseteq D_A$  with  $D_\cap \cap D_{\text{res}} \neq \emptyset$  the statement  $R(D_\cap) \cap D_{\text{split}} \neq \emptyset$  holds, and
3. for any non-empty zone  $D_{\text{diff}} \subseteq D_A \setminus D_{\text{res}}$  the statement  $R(D_{\text{diff}}) \cap D_{\text{split}} = \emptyset$  hold.

**Proof:**

We show one statement after the other.

If  $R = \emptyset$  then the first statement trivially holds due to the precondition  $D_{\text{split}} \subseteq R(D_A)(= D_A)$ . Else, the first statement holds due to  $D_A \cap \text{free}(\text{multiple-reset}(\{c\}D_A, D_{\text{split}}, R \setminus \{c\}), c) \subseteq D_A$ . We show the second statement by induction:

**Hypothesis:** If  $D_{\text{split}} \subseteq R(D_A)$ , then for any non-empty zone  $D_\cap \subseteq D_A$  with

$$D_\cap \cap \text{multiple-reset}(D_A, D_{\text{split}}, R) \neq \emptyset$$

the statement  $R(D_\cap) \cap D_{\text{split}} \neq \emptyset$  holds.

**Base Case:** The hypothesis holds for  $R = \emptyset$ .

**Induction Step:** If the hypothesis holds if  $|R| = n$  then it also holds if  $|R| = n + 1$ .

We first show the base case. If  $R = \emptyset$ , then  $\text{multiple-reset}(D_A, D_{\text{split}}, R)$  returns  $D_{\text{split}}$ . Therefore, the hypothesis reduces to the statement that if  $D_{\text{split}} \subseteq D_A$  then for any non-empty zone  $D_\cap \subseteq D_A$  with  $D_\cap \cap D_{\text{split}} \neq \emptyset$  the statement  $D_\cap \cap D_{\text{split}} \neq \emptyset$  holds, which is obviously the case. We now show the induction step.

To show the induction step, we have to show that if  $D_{\text{split}} \subseteq R_{n+1}(D_A)$  with  $R_{n+1} \subseteq C_A \cup \{\chi_0, \dots\}$  such that  $|R_{n+1}| = n + 1$  then for any non-empty zone  $D_\cap \subseteq D_A$  with

$$D_\cap \cap \text{multiple-reset}(D_A, D_{\text{split}}, R_{n+1}) \neq \emptyset$$

the statement  $R_{n+1}(D_\cap) \cap D_{\text{split}} \neq \emptyset$  holds if we assume that this statement holds for any different zones and any reset set  $R_n \subseteq C_A \cup \{\chi_0, \dots\}$  with  $|R_n| = n$ .

If  $D_{\text{split}} \subseteq R_{n+1}(D_A)$  with  $|R_{n+1}| = n + 1$ , then  $\text{multiple-reset}(D_A, D_{\text{split}}, R_{n+1})$  returns  $D_A \cap \text{free}(\text{multiple-reset}(\{c\}D_A, D_{\text{split}}, R_{n+1} \setminus \{c\}), c)$  with  $c \in R_{n+1}$ . By Proposition Y.3, we know that for any  $D_\cap \subseteq D_A$ , the statement

$$\begin{aligned} & (D_\cap \cap \text{multiple-reset}(D_A, D_{\text{split}}, R_{n+1})) \neq \emptyset \\ \Leftrightarrow & (D_\cap \cap D_A \cap \text{free}(\text{multiple-reset}(\{c\}D_A, D_{\text{split}}, R_{n+1} \setminus \{c\}), c)) \neq \emptyset \end{aligned}$$

implies

$$\{c\}(D_\cap) \cap \text{multiple-reset}(\{c\}D_A, D_{\text{split}}, R_{n+1} \setminus \{c\}) \neq \emptyset.$$

By the induction hypothesis, this implies

$$\begin{aligned} & (R_{n+1} \setminus \{c\})(\{c\}(D_\cap)) \cap D_{\text{split}} \neq \emptyset \\ \Leftrightarrow & R_{n+1}(D_\cap) \cap D_{\text{split}} \neq \emptyset \end{aligned}$$

and the induction step holds.

Therefore, the second statement also holds and we now show the third. Once again, we show it by induction.

**Hypothesis:** If  $D_{\text{split}} \subseteq R(D_A)$ , then for any non-empty zone  $D_{\text{diff}} \subseteq D_A \setminus (\text{multiple-reset}(D_A, D_{\text{split}}, R))$  the statement  $R(D_{\text{diff}}) \cap D_{\text{split}} = \emptyset$  holds.

**Base Case:** The hypothesis holds for  $R = \emptyset$ .

**Induction Step:** If the hypothesis holds if  $|R| = n$  then it also holds if  $|R| = n + 1$ .

We first show the base case. If  $R = \emptyset$ , then  $\text{multiple-reset}(D_A, D_{\text{split}}, R)$  returns  $D_{\text{split}}$ . Therefore, the hypothesis reduces to the statement that if  $D_{\text{split}} \subseteq D_A$  then for any non-empty zone  $D_{\text{diff}} \subseteq D_A \setminus D_{\text{split}}$  the statement  $D_{\text{diff}} \cap D_{\text{split}} = \emptyset$  holds. This is obviously the case. We now show the induction step.

To show the induction step, we have to show that for any non-empty  $D_{\text{diff}} \subseteq D_A \setminus (\text{multiple-reset}(D_A, D_{\text{split}}, R_{n+1}))$  the statement  $R_{n+1}(D_{\text{diff}}) \cap D_{\text{split}} = \emptyset$  with  $|R_{n+1}| = n + 1$  holds if we assume that this statement holds for any different zones and any reset set  $R_n \subseteq C_A \cup \{\chi_0, \dots\}$  with  $|R_n| = n$ .

If  $D_{\text{split}} \subseteq R_{n+1}(D_A)$  with  $|R_{n+1}| = n + 1$ , then  $\text{multiple-reset}(D_A, D_{\text{split}}, R_{n+1})$  returns  $D_A \cap \text{free}(\text{multiple-reset}(\{c\}D_A, D_{\text{split}}, R_{n+1} \setminus \{c\}), c)$  with  $c \in R_{n+1}$ . By Proposition Y.3, we know that for any such  $D_{\text{diff}}$ , the statement

$$\begin{aligned} & (D_{\text{diff}} \cap \text{multiple-reset}(D_A, D_{\text{split}}, R_{n+1})) = \emptyset \\ \Leftrightarrow & (D_{\text{diff}} \cap D_A \cap \text{free}(\text{multiple-reset}(\{c\}D_A, D_{\text{split}}, R_{n+1} \setminus \{c\}), c)) = \emptyset \end{aligned}$$

implies

$$\{c\}(D_{\text{diff}}) \cap \text{multiple-reset}(\{c\}D_A, D_{\text{split}}, R_{n+1} \setminus \{c\}) = \emptyset.$$

By the induction hypothesis, this implies

$$\begin{aligned} & (R_{n+1} \setminus \{c\})(\{c\}(D_{\text{diff}})) \cap D_{\text{split}} = \emptyset \\ \Leftrightarrow & R_{n+1}(D_{\text{diff}}) \cap D_{\text{split}} = \emptyset \end{aligned}$$

and the induction step holds.  $\square$

The following proposition prepares the implementation of the revert-action-trans operator.

**Proposition Y.4. (Preparation to implement revert-action-trans)**

Assume two TA  $A, B$ , using the sets of clocks  $C_A, C_B$ , and an AB-synchronized symbolic state  $(l_A, D_A)$  of the VCG of  $A$  regarding  $B$ . Let  $D_{\text{split}} \in \mathcal{D}(C_A \cup \{\chi_0, \dots, \chi_{|C_A|+|C_B|-1}\})$  be a zone such that  $D_{\text{split}} \subseteq D_{\sigma, A}$  with  $(l_{\sigma, A}, D_{\sigma, A})$  being the target of an outgoing action transition of  $(l_A, D_A)$ , labeled with  $\sigma \in \Sigma$ . Let  $l_A \xrightarrow[TA]{g, \sigma, R} l_{\sigma, A}$  be the corresponding transition of  $A$ . We define the zone

$$D_{\text{res}} = \text{multiple-reset}(D_A \wedge g, D_{\text{split}}, R).$$

Any  $(l_A, u_{\text{res}}) \in (l_A, D_{\text{res}})$  has an outgoing transition  $(l_A, u_{\text{res}}) \xrightarrow{TSVC^\sigma} (l_{\sigma,A}, u_{\text{split}})$  with  $(l_{\sigma,A}, u_{\text{split}}) \in (l_{\sigma,A}, D_{\text{split}})$ .

For any  $(l_A, u_{\text{diff}}) \in (l_A, D_A \wedge g)$  with  $(l_A, u_{\text{diff}}) \notin (l_A, D_{\text{res}})$  the statement  $[R \rightarrow 0]u_{\text{diff}} \notin D_{\text{split}}$  holds.

**Proof:**

Before we start with the proof of the statements, we recognize that  $D_{\text{split}} \subseteq D_{\sigma,A} = R(D_A \wedge g) \wedge I(l_{\sigma,A}) \subseteq R(D_A \wedge g)$  holds (Definition 2.7) and we are, therefore, allowed to apply Proposition Y.3.

We show one statement after the other. To show the first statement, we show that any  $(l_A, u_{\text{res}}) \in (l_A, D_{\text{res}})$  has an outgoing transition  $(l_A, u_{\text{res}}) \xrightarrow{TSVC^\sigma} (l_{\sigma,A}, u_{\sigma,\text{res}})$  such that  $(l_{\sigma,A}, u_{\sigma,\text{res}}) \in (l_{\sigma,A}, D_{\text{split}})$ . By Definition 2.3, we know that  $u_{\text{split}} = [R \rightarrow 0]u_{\text{res}}$  and such an outgoing transition exists if and only if  $u_{\text{res}} \models g$  and  $[R \rightarrow 0]u_{\text{res}} \models I(l_{\sigma,A})$  hold. Therefore, we have to show these two statements.

By Proposition Y.3, we know that  $D_{\text{res}} \subseteq (D_A \wedge g)$ , which implies  $u_{\text{res}} \models g$ , and we only have to show  $[R \rightarrow 0]u_{\text{res}} \models I(l_{\sigma,A})$ . We now consider the zone  $\{u_{\text{res}}\} \subseteq (D_A \wedge g)$ . Since  $\{u_{\text{res}}\} \cap D_{\text{res}} = \{u_{\text{res}}\} \cap \text{multiple-reset}(D_g, D_{\text{split}}, R) \neq \emptyset$ , we know by Proposition Y.3 that  $R(\{u_{\text{res}}\}) \cap D_{\text{split}} \neq \emptyset$ , which can only be the case if  $[R \rightarrow 0]u_{\text{res}} \in D_{\text{split}}$ . Since  $D_{\text{split}} \subseteq D_{\sigma,A}$ , we know that  $[R \rightarrow 0]u_{\text{res}} \models I(l_{\sigma,A})$  holds and the first statement is shown.

We now show the second statement of the proposition. We consider any  $u_{\text{diff}} \in D_A \wedge g$  with  $u_{\text{diff}} \notin D_{\text{res}}$ . We have to show that  $[R \rightarrow 0]u_{\text{diff}} \notin D_{\text{split}}$  holds.

Due to  $u_{\text{diff}} \notin D_{\text{res}}$ , we know that  $\{u_{\text{diff}}\} \cap D_{\text{res}} = \{u_{\text{diff}}\} \cap \text{multiple-reset}(D_g, D_{\text{split}}, R) = \emptyset$ , we know by Proposition Y.3 that  $R(\{u_{\text{diff}}\}) \cap D_{\text{split}} = \emptyset$ , which can only be the case if  $[R \rightarrow 0]u_{\text{diff}} \notin D_{\text{split}}$ . Therefore, the second statement also holds and the proposition is shown.  $\square$

Now we can implement the revert-action-trans operator.

**Proposition Y.5. (Implementing revert-action-trans)**

The function

$$\begin{aligned} & \text{revert-action-trans-impl}(D_A, g, R, I(l_{\sigma,A}), \phi_{\text{split}}) \\ & = \text{extract-virtual-constraint}(\text{multiple-reset}(D_A \wedge g, R(D_A \wedge g) \wedge \phi_{\text{split}}, R)) \end{aligned}$$

is a revert-action-trans operator.

**Proof:**

To show this proposition, we have to show that revert-action-trans-impl fulfills the three conditions of Definition Y.1. We show one statement after the other.

To show usefulness, we first recognize that

$$R(D_A \wedge g) \wedge \text{extract-virtual-constraint}(D_{\text{split}}) \subseteq R(D_A \wedge g)$$

and, therefore, we are allowed to apply Proposition Y.3, which implies

$$\text{multiple-reset}(D_A \wedge g, R(D_A \wedge g) \wedge \phi_{\text{split}}, R) \subseteq D_A \wedge g \subseteq D_A.$$



Usefulness is implied by Definition 4.1.

To show soundness, we have to show that for any non-empty zone  $D_{\text{sub},A} \subseteq D_A$  with  $D_{\text{sub},A} \wedge \phi_{\text{res}} \neq \emptyset$  there exists an outgoing transition  $(l_A, D_{\text{sub},A}) \xrightarrow[VCG]{\sigma} (l_{\sigma,A}, D_{\text{sub},\sigma,A})$  which corresponds to  $l_A \xrightarrow[TA]{g,\sigma,R} l_{\sigma,A}$  with  $D_{\text{sub},\sigma,A} \wedge \phi_{\text{split}} \neq \emptyset$ . We consider any such  $D_{\text{sub},A}$  and show that the transition of the TA causes such an outgoing transition.

Since  $D_{\text{sub},A} \wedge \phi_{\text{res}} \neq \emptyset$  holds there exists a clock valuation  $u_A \in D_{\text{sub},A} \wedge \phi_{\text{res}}$ . Due to Proposition Y.4, we know that there exists a transition  $(l_A, u_A) \xrightarrow[TSVC]{\sigma} (l_{\sigma,A}, u_{\sigma})$  with  $u_{\sigma} = [R \rightarrow 0]u_A$  and  $u_{\sigma} \models \phi_{\text{split}}$ . Due to forward stability (Proposition 3.7) this implies the existence of a transition  $(l_A, D_{\text{sub},A}) \xrightarrow[VCG]{\sigma} (l_{\sigma,A}, D_{\text{sub},\sigma,A})$  with  $u_{\sigma} \in D_{\text{sub},\sigma,A}$ . Since  $u_{\sigma} \models \phi_{\text{split}}$  and  $u_{\sigma} \in D_{\text{sub},\sigma,A}$ ,  $D_{\text{sub},\sigma,A} \wedge \phi_{\text{split}} \neq \emptyset$  holds and soundness is implied.

To show completeness, we have to show that for any zone  $D_{\text{sub},A} \subseteq D_A$  with  $D_{\text{sub},A} \wedge \phi_{\text{res}} = \emptyset$  if there exists a transition  $(l_A, D_{\text{sub},A}) \xrightarrow[VCG]{\sigma} (l_{\sigma,A}, D_{\text{sub},\sigma,A})$  which corresponds to  $l_A \xrightarrow[TA]{g,\sigma,R} l_{\sigma,A}$  the statement  $D_{\text{sub},\sigma,A} \wedge \phi_{\text{split}} = \emptyset$  holds. We consider any such  $D_{\text{sub},A}$  and show that the transition of the TA cannot cause such an outgoing transition.

Since  $D_{\text{sub},A} \wedge \phi_{\text{res}} = \emptyset$  holds,  $\forall u_A \in D_{\text{sub},A} : u_A \not\models \phi_{\text{res}}$ . By Definition 4.1, this implies

$$\forall u_A \in D_{\text{sub},A} : u_A \notin \text{multiple-reset}(D_A \wedge g, R(D_A \wedge g) \wedge \text{extract-virtual-constraint}(D_{\text{split}}, R)).$$

By Proposition Y.4, we know that this implies that for no  $(l_A, u_A) \in (l_A, D_{\text{sub},A})$  there exists an outgoing transition  $(l_A, u_A) \xrightarrow[TSVC]{\sigma} (l_{\sigma,A}, u_{\sigma,A})$  corresponding to our TA transition such that  $u_{\sigma,A} \in D_{\text{split}}$ . By backward stability (Proposition 3.6), this implies that there is no corresponding transition in the VCG and, therefore, Completeness also holds.  $\square$

## Z. Implementing revert- $\varepsilon$ -trans

We show how to implement the revert- $\varepsilon$ -trans operator here, which is defined as follows.

### Definition Z.1. (revert- $\varepsilon$ -trans operator)

Assume two TA  $A, B$ , using the sets of clocks  $C_A, C_B$ , an AB-synchronized symbolic state  $(l_A, D_A)$  of the VCG of  $A$  regarding  $B$ , and a transition  $(l_A, D_A) \xrightarrow[VCG]{\varepsilon} (l_A, D_{\varepsilon,A})$ . Let  $\phi_{\text{split}} \in \mathcal{B}(\chi_0, \dots, \chi_{|C_A|+|C_B|-1})$  be a virtual constraint with  $[\phi_{\text{split}}] \subseteq [\text{extract-virtual-constraint}(D_{\varepsilon,A})]$ . We define the operator

$$\text{revert-}\varepsilon\text{-trans} : \mathcal{D}(C_{A,\chi}) \times \mathcal{D}(C_{A,\chi}) \times \mathcal{B}(\{\chi_0, \dots, \chi_{|C_A|+|C_B|-1}\}) \rightarrow \mathcal{B}(\chi_0, \dots, \chi_{|C_A|+|C_B|-1})$$

such that

$$\text{revert-}\varepsilon\text{-trans}(D_A, D_{\varepsilon,A}, \phi_{\text{split}}) = \phi_{\text{res}}$$

with

1. (Usefulness)  $[\phi_{\text{res}}] \subseteq [\text{extract-virtual-constraint}(D_A)]$ ,

2. (Soundness) for any non-empty zone  $D_{\text{sub},A} \subseteq D_A$  with  $D_{\text{sub},A} \wedge \phi_{\text{res}} \neq \emptyset$  there exists an outgoing transition  $(l_A, D_{\text{sub},A}) \xrightarrow[VCG]{\varepsilon} (l_A, D_{\text{sub},\varepsilon,A})$  with  $D_{\text{sub},\varepsilon,A} \wedge \phi_{\text{split}} \neq \emptyset$ , and
3. (Completeness) for any zone  $D_{\text{sub},A} \subseteq D_A$  with  $D_{\text{sub},A} \wedge \phi_{\text{res}} = \emptyset$  and outgoing transition  $(l_A, D_{\text{sub},A}) \xrightarrow[VCG]{\varepsilon} (l_A, D_{\text{sub},\varepsilon,A})$  the statement  $D_{\text{sub},\varepsilon,A} \wedge \phi_{\text{split}} = \emptyset$  holds.

To implement this operator, we introduce the past operator [21].

**Definition Z.2. (Past Operator [21])**

Assume a set of clocks  $C$ . We define the past operator

$$\downarrow: \mathcal{D}(C) \rightarrow \mathcal{D}(C)$$

such that for any zone  $D \in \mathcal{D}(C)$

$$D^\downarrow = \{u \mid \exists d \in \mathbb{T} : u + d \in D\}$$

holds.

Using DBMs, it is possible to implement the past operator [21] and using it, we are able to revert the future operator.

**Proposition Z.1. (Implementing revert- $\varepsilon$ -trans)**

The function

$$\text{revert-}\varepsilon\text{-trans-impl}(D_A, D_{\varepsilon,A}, \phi_{\text{split}}) = \text{extract-virtual-constraint}(D_A \cap (D_{\varepsilon,A} \wedge \phi_{\text{split}})^\downarrow)$$

is a revert- $\varepsilon$ -trans operator.

**Proof:**

We show one statement after the other. Since  $D_A \cap (D_{\varepsilon,A} \wedge \phi_{\text{split}})^\downarrow \subseteq D_A$  obviously holds, usefulness holds by Definition 4.1.

To show the second statement, we assume any  $D_{\text{sub},A} \subseteq D_A$  with  $D_{\text{sub},A} \wedge \phi_{\text{res}} \neq \emptyset$ . In this case, there exists a  $u_{\text{sub},A} \in D_{\text{sub},A}$  such that  $u_{\text{sub},A} \in (D_A \cap (D_{\varepsilon,A} \wedge \phi_{\text{split}})^\downarrow)$  by Definition 4.1. We recognize that by Definition Z.2 there exists a  $d$  such that  $u_{\text{sub},A} + d \in (D_{\varepsilon,A} \wedge \phi_{\text{split}})$ .

Since  $(D_{\varepsilon,A} \wedge \phi_{\text{split}}) \subseteq D_{\varepsilon,A}$ ,  $(u_{\text{sub},A} + d) \in D_{\varepsilon,A}$  holds. By Definition 2.7 and 3.7 this implies  $(u_{\text{sub},A} + d) \models I(l_A)$  and by Definition 2.3 and 3.3, this implies the existence of a transition  $(l_A, u_{\text{sub},A}) \xrightarrow[TSVC]{d} (l_A, (u_{\text{sub},A} + d))$ .

Since  $u_{\text{sub},A} \in D_{\text{sub},A}$  we know by forward stability (Proposition 3.7) that the existence of the transition  $(l_A, u_{\text{sub},A}) \xrightarrow[TSVC]{d} (l_A, (u_{\text{sub},A} + d))$  implies the existence of a transition  $(l_A, D_{\text{sub},A}) \xrightarrow[VCG]{\varepsilon} (l_A, D_{\text{sub},\varepsilon,A})$  with  $(u_{\text{sub},A} + d) \in D_{\text{sub},\varepsilon,A}$ . Therefore,  $(u_{\text{res}} + d) \in (D_{\text{sub},\varepsilon,A} \wedge \phi_{\text{split}})$ , which implies  $(D_{\text{sub},\varepsilon,A} \wedge \phi_{\text{split}}) \neq \emptyset$ .

To show the third statement we assume any  $D_{\text{sub},A} \subseteq D_A$  with  $D_{\text{sub},A} \wedge \text{extract-virtual-constraint}(D_A \cap (D_{\varepsilon,A} \wedge \phi_{\text{split}})^\downarrow) = \emptyset$  and outgoing  $\varepsilon$ -transition  $(l_A, D_{\text{sub},A}) \xrightarrow[VCG]{\varepsilon} (l_A, D_{\varepsilon,\text{sub},A})$ . To show the third statement, we have to show that

$$\forall u_{\varepsilon,\text{sub},A} \in D_{\varepsilon,\text{sub},A} : u_{\varepsilon,\text{sub},A} \not\models \phi_{\text{split}}$$

holds.

By Definition 4.1, we know that

$$\forall u_{\text{sub},A} \in D_{\text{sub},A} : u_{\text{sub},A} \notin D_A \cap (D_{\varepsilon,A} \wedge \phi_{\text{split}})^\downarrow.$$

Due to  $D_{\text{sub},A} \subseteq D_A$  and by Definition Z.2, we know that this implies that for any  $d \in \mathbb{T}$  the statement  $u_{\text{sub},A} + d \notin D_{\varepsilon,A} \wedge \phi_{\text{split}}$  holds. Since we know by backward stability (Proposition 3.6) that  $u_{\varepsilon,\text{sub},A} \in D_{\varepsilon,\text{sub},A}$  implies the existence of a  $u_{\text{sub},A} \in D_{\text{sub},A}$  and a  $d \in \mathbb{T}$  such that  $u_{\varepsilon,\text{sub},A} = u_{\text{sub},A} + d$ , this implies  $u_{\varepsilon,\text{sub},A} \not\models \phi_{\text{split}}$  and the proposition is shown.  $\square$

## AA. Implementing combine

This section shows how to implement the combine operator, which is defined as follows.

### Definition AA.1. (combine operator)

Assume a list of virtual constraints  $\text{lo-vc} \in (\mathcal{B}(\{\chi_0, \dots, \chi_m\}))^*$ . We define the operator

$$\text{combine} : (\mathcal{B}(\{\chi_0, \dots, \chi_m\}))^* \rightarrow 2^{\mathcal{B}(\{\chi_0, \dots, \chi_m\})}$$

with

$$\text{combine}(\text{lo-vc}) = \{\phi_0, \dots, \phi_n\}$$

such that

1. (Non-Emptiness)  $\forall i \in [0, n] : [\phi_i] \neq \emptyset$ ,
2. (Disjointness)  $\forall i, j \in [0, n] : ([\phi_i \wedge \phi_j] \neq \emptyset)$  implies  $i = j$ , and
3. (Correctness)

$$\bigcup_{\phi \in \text{lo-vc}} [\phi] = \bigcup_{i \in [0, n]} [\phi_i]$$

hold.

The COMBINE-IMPL function is shown in Algorithm AA.1.

### Proposition AA.1. (Implementing the combine operator.)

The function COMBINE-IMPL is a combine operator.

**Algorithm AA.1** An implementation of the combine operator

---

```

1: function COMBINE-IMPL(lo-vc)
2:   result  $\leftarrow \emptyset$ 
3:   for  $\phi \in \text{lo-vc}$  do
4:     inter  $\leftarrow \{\phi\}$ 
5:     for  $\phi_r \in \text{result}$  do
6:        $\triangleright$  Each element of inter is conjugated with each element of  $\neg\phi_r$ 
7:       inter  $\leftarrow \text{inter} \wedge \neg\phi_r$ 
8:     end for
9:     for  $\phi \in \text{inter}$  do
10:      if  $[\phi] \neq \emptyset$  then
11:        result.append( $\phi$ )
12:      end if
13:    end for
14:  end function

```

---

**Proof:**

Since the COMBINE-IMPL function obviously terminates, we skip that part of the proof. We first show some properties for the first inner loop.

**Precondition:** Before the first inner loop is run, result is a set of virtual constraints such that Non-Emptiness and Disjointness hold. Moreover,  $\text{inter} = \{\phi\}$ .

**Invariant:** After  $i$  iteration of the first inner loop, inter is a set of disjoint virtual constraints such that for the first  $i$  elements of result, denoted  $\text{result}[0] \dots \text{result}[i-1]$ , the statements

$$\forall \phi_{\text{inter}} \in \text{inter} : \forall u \in [\phi_{\text{inter}}] : \forall j \in [0, i-1] : u \models \phi \wedge u \not\models \text{result}[j]$$

and

$$\forall u \in \phi : (\forall j \in [0, i-1] : u \not\models \text{result}[j]) \text{ implies } (\exists \phi_{\text{inter}} \in \text{inter} : u \models \phi_{\text{inter}})$$

hold.

**Postcondition:** After the first inner loop terminates, inter is a set of disjoint virtual constraints such that for all elements of result the statements

$$\forall \phi_{\text{inter}} \in \text{inter} : \forall u \in [\phi_{\text{inter}}] : \forall \phi_{\text{result}} \in \text{result} : u \models \phi \wedge u \not\models \phi_{\text{result}}$$

and

$$\forall u \in \phi : (\forall \phi_{\text{result}} \in \text{result} : u \not\models \phi_{\text{result}}) \text{ implies } (\exists \phi_{\text{inter}} \in \text{inter} : u \models \phi_{\text{inter}})$$

hold.

The postcondition is implied by the invariant. We show the invariant by induction in the number of iteration.

**Base Case:** After zero iteration, the invariant holds.

**Induction Step:** If the invariant holds after  $i-1$  iteration, it also holds after  $i$  iteration.

We first show the base case. Since after zero iteration *inter* contains a single element only, disjointness is obviously fulfilled. Since  $i = 0$ , both equations are trivially fulfilled and the base case holds.

We now show the invariant. Obviously, after the  $i$ th iteration, for each element of *inter* exists a virtual constraint in *inter* after  $i - 1$  iteration such that the solution set of the new element is subset of the solution set of the old virtual constraint. Since disjointness holds before the  $i$ th iteration, this implies that disjointness also holds after  $i$  iteration. Due to the same fact, we know

$$\forall \phi_{\text{inter}} \in \text{inter} : \forall u \in [\phi_{\text{inter}}] : u \models \phi$$

and

$$\forall \phi_{\text{inter}} \in \text{inter} : \forall u \in [\phi_{\text{inter}}] : \forall j \in [0, i - 2] : u \not\models \text{result}[j]$$

by the induction hypothesis and we only have to show

$$\forall \phi_{\text{inter}} \in \text{inter} : \forall u \in [\phi_{\text{inter}}] : u \not\models \text{result}[i - 1]$$

to show the first equation. This is the case, since for any  $u \in [\phi_{\text{inter}}]$  the statement  $u \not\models \text{result}[i - 1]$  holds by construction of  $\phi_{\text{inter}}$ .

To show the second equation, we assume any  $u \in \phi$ . Moreover, we assume  $(\forall j \in [0, i - 1] : u \not\models \text{result}[j])$ , since otherwise the equation holds trivially. By the induction hypothesis, we know that there exists a  $\phi_{\text{prev}}$  in *inter* before the  $i$ th iteration, such that  $u \models \phi_{\text{prev}}$ . Due to  $u \not\models \text{result}[i - 1]$ , we know that  $u \models \phi_{\text{prev}} \wedge \neg \text{result}[i - 1]$  and the second equation holds.

Since the properties of the second inner loop are obvious, each non-empty virtual constraint of *inter* is added to *result*, we skip that part of the proof and proceed to the properties of the outer loop.

**Precondition:** Before the outer loop is run, *result* is an empty set of virtual constraints and *lo-vc* is a list of virtual constraints.

**Invariant:** After  $i$  iteration, all elements of *result* are non-empty, disjoint, and

$$\bigcup_{j \in [0, i - 1]} [\text{lo-vc}[j]] = \bigcup_{\phi_{\text{result}} \in \text{result}} [\phi_{\text{result}}]$$

holds.

**Postcondition:** After the outer loop terminates, all elements of *result* are non-empty, disjoint, and

$$\bigcup_{\phi_{\text{lo-vc}} \in \text{lo-vc}} [\phi_{\text{lo-vc}}] = \bigcup_{\phi_{\text{result}} \in \text{result}} [\phi_{\text{result}}]$$

holds.

The postcondition is implied by the invariant. We show the invariant by induction in the number of iteration.

**Base Case:** After zero iteration, the invariant holds.

**Induction Step:** If the invariant holds after  $i - 1$  iteration, it also holds after  $i$  iteration.

We first show the base case. Due to the precondition, we know that *result* is an empty set. Therefore, all included virtual constraints are non-empty and disjoint. Moreover,

$$\bigcup_{j \in [0, -1]} [\text{lo-vc}[j]] = \emptyset = \bigcup_{\phi_{\text{result}} \in \emptyset} [\phi_{\text{result}}].$$

Therefore, the base case holds.

We now show the invariant by showing one statement after the other. Obviously, the precondition for the inner loop is always fulfilled and we are allowed to apply the previously seen postcondition of the inner loop.

- By the induction hypothesis, we know that before the  $i$ th iteration, all elements of result are non-empty. Since we ensure by the second inner loop that only non-empty elements are added to result, result fulfills non-emptiness trivially.
- By the induction hypothesis, we know that before the  $i$ th iteration, all elements of result are disjoint. By the postcondition of the inner loop, we know that after the first inner loop terminates, all elements of inter are disjoint between each other and with each element of result. Therefore, disjointness also holds after  $i$  iteration.
- To show this statement, we have to show that after the  $i$ th iteration

$$\bigcup_{j \in [0, i-1]} [\text{lo-vc}[j]] = \bigcup_{\phi_{\text{result}} \in \text{result}} [\phi_{\text{result}}]$$

holds. To do so, we first show that the left hand side is a subset of the right hand side and afterwards vice versa. By the induction hypothesis, we know that before the  $i$ th iteration,

$$\bigcup_{j \in [0, i-2]} [\text{lo-vc}[j]] = \bigcup_{\phi_{\text{result}} \in \text{result}} [\phi_{\text{result}}]$$

holds. By the second equation of the postcondition of the inner loop, we know that after the first inner loop

$$\forall u \in [\text{lo-vc}[i-1]] : (\exists \phi_{\text{result}} \in \text{result} : u \models \phi_{\text{result}}) \vee (\exists \phi_{\text{inter}} \in \text{inter} : u \models \phi_{\text{inter}})$$

holds, which implies

$$[\text{lo-vc}[i-1]] \subseteq \bigcup_{\phi_{\text{result}} \in \text{result}} [\phi_{\text{result}}] \cup \bigcup_{\phi_{\text{inter}} \in \text{inter}} [\phi_{\text{inter}}].$$

Therefore, after the second inner loop,

$$\bigcup_{j \in [0, i-1]} [\text{lo-vc}[j]] \subseteq \bigcup_{\phi_{\text{result}} \in \text{result}} [\phi_{\text{result}}]$$

holds. We now show the opposite direction. By the first equation of the postcondition of the inner loop, we know that after the first inner loop

$$\forall \phi_{\text{inter}} \in \text{inter} : \forall u \in \phi_{\text{inter}} : u \models \text{lo-vc}[i-1]$$

holds, which implies

$$\bigcup_{\phi_{\text{inter}} \in \text{inter}} [\phi_{\text{inter}}] \subseteq [\text{lo-vc}[i-1]].$$

Therefore, by the induction hypothesis,

$$\bigcup_{j \in [0, i-1]} [\text{lo-vc}[j]] \supseteq \bigcup_{\phi_{\text{result}} \in \text{result}} [\phi_{\text{result}}] \cup \bigcup_{\phi_{\text{inter}} \in \text{inter}} [\phi_{\text{inter}}],$$

and after the second inner loop

$$\bigcup_{j \in [0, i-1]} [\text{lo-vc}[j]] \supseteq \bigcup_{\phi_{\text{result}} \in \text{result}} [\phi_{\text{result}}].$$

Therefore, the third statement also holds.

Therefore, the invariant of the outer loop is shown. Since COMBINE-IMPL returns result immediately after the outer loop terminates, COMBINE-IMPL fulfils all conditions of Definition AA.1 and Proposition AA.1 holds.  $\square$

## AB. Implementing revert-sync

This section shows how to implement the revert-sync operator, which is defined as follows.

### Definition AB.1. (revert-sync operator)

Assume two TA  $A, B$ , using the sets of clocks  $C_A, C_B$ , an AB-semi-synchronized symbolic state  $(l_A, D_A)$  of the VCG of  $A$  regarding  $B$  and an AB-semi-synchronized symbolic state  $(l_B, D_B)$  of the VCG of  $B$  regarding  $A$  with  $D_A \equiv_{\text{virtual}} D_B$ . We denote

$$((l_A, D_{e,A}), (l_B, D_{e,B})) = \text{sync}((l_A, D_A), (l_B, D_B)).$$

Let  $\phi_e \in \mathcal{B}(\{\chi_0, \dots, \chi_{|C_A|+|C_B|-1}\})$  be a virtual constraint, such that

$$[\phi_e] \subseteq [\text{extract-virtual-constraint}(D_{e,A})] (= [\text{extract-virtual-constraint}(D_{e,B})]).$$

We define the operator

$$\begin{aligned} \text{revert-sync} : \mathcal{D}(C_{A,\chi}) \times \mathcal{D}(C_{B,\chi}) \times \mathcal{B}(\{\chi_0, \dots, \chi_{|C_A|+|C_B|-1}\}) \\ \rightarrow 2^{\mathcal{B}(\{\chi_0, \dots, \chi_{|C_A|+|C_B|-1}\})} \end{aligned}$$

such that

$$\text{revert-sync}(D_A, D_B, \phi_e) = \{\phi_0, \dots, \phi_n\}$$

with

1. (Non-Emptiness)  $\forall \phi \in \{\phi_0, \dots, \phi_n\} : [\phi] \neq \emptyset$ .
2. (Usefulness)  $\forall \phi \in \{\phi_0, \dots, \phi_n\} : [\phi] \subseteq [\text{extract-virtual-constraint}(D_A)]$ ,
3. (Disjointness)  $\forall i, j \in [0, n] : [\phi_i \wedge \phi_j] \neq \emptyset$  implies  $i = j$ ,

4. (Soundness) for any non-empty zone  $D_{\text{sub},A} \subseteq D_A$  with  $D_{\text{sub},A} \wedge \phi_A \neq \emptyset$  and

$$\begin{aligned} & ((l_A, D_{e,\text{sub},A}), (l_B, D_{e,\text{sub},B})) \\ & = \text{sync}((l_A, D_{\text{sub},A}), (l_B, D_B \wedge \text{extract-virtual-constraint}(D_{\text{sub},A}))), \end{aligned}$$

the statement  $D_{e,\text{sub},A} \wedge \phi_A \neq \emptyset$  holds,

5. (Completeness) for any non-empty zone  $D_{\text{sub},A} \subseteq D_A$  with  $D_{\text{sub},A} \wedge \phi_A = \emptyset$  and

$$\begin{aligned} & ((l_A, D_{e,\text{sub},A}), (l_B, D_{e,\text{sub},B})) \\ & = \text{sync}((l_A, D_{\text{sub},A}), (l_B, D_B \wedge \text{extract-virtual-constraint}(D_{\text{sub},A}))), \end{aligned}$$

the statement  $D_{e,\text{sub},A} \wedge \phi_A = \emptyset$  holds, and

6. the analog statements for B hold.

We remind the reader of Proposition 3.9 which shows that the sync function can be implemented by using resets. Therefore, we implement the revert-sync function by using the multiple-reset function of Proposition Y.3. With  $(l_A, D_{e,A})$  and  $(l_B, D_{e,B})$ , we denote the resulting symbolic states of  $\text{sync}((l_A, D_A), (l_B, D_B))$ .

**Proposition AB.1. (Implementing revert-sync)**

We define

$$\begin{aligned} R_A &= \{\chi_i \mid i \in [0, |C_A| - 1] \wedge \forall u_A \in D_A : u_A(C_A[i]) = 0\}, \\ R_B &= \{\chi_{i+|C_A|} \mid i \in [0, |C_B| - 1] \wedge \forall u_B \in D_B : u_B(C_B[i]) = 0\}, \end{aligned}$$

and  $R = R_A \cup R_B$ . The function

$$\begin{aligned} & \text{revert-sync-impl}(D_A, D_B, \phi_e) = \\ & \quad \text{combine}(\text{extract-virtual-constraint}(\text{multiple-reset}(D_A, D_{e,A} \wedge \phi_e, R)), \\ & \quad \text{extract-virtual-constraint}(\text{multiple-reset}(D_B, D_{e,B} \wedge \phi_e, R))) \end{aligned}$$

is a revert-sync operator.

**Proof:**

We only show the statements for  $A$ , since the statements for  $B$  can be shown analogously. While Non-Emptiness and Disjointness hold by Definition AA.1, Usefulness holds by Proposition Y.3 and Definition 4.1.

To show Soundness, we assume any non-empty zone  $D_{\text{sub},A} \subseteq D_A$  with

$$D_{\text{sub},A} \wedge \text{extract-virtual-constraint}(\text{multiple-reset}(D_A, D_{e,A} \wedge \phi_e, R)) \neq \emptyset$$

and show that  $D_{e,\text{split},A} \wedge \phi_e \neq \emptyset$  holds.

By the first statement and by Definition 4.1, we know

$$D_A \wedge \text{extract-virtual-constraint}(\text{multiple-reset}(D_A, D_{e,A} \wedge \phi_e, R))$$



$$= \text{multiple-reset}(D_A, D_{e,A} \wedge \phi_e, R).$$

Obviously,  $D_{\text{sub},A} \subseteq D_A$  implies  $D_{\text{sub},A} \cap D_A = D_{\text{sub},A}$ . Therefore,

$$\begin{aligned} & D_{\text{sub},A} \wedge \text{extract-virtual-constraint}(\text{multiple-reset}(D_A, D_{e,A} \wedge \phi_e, R)) \neq \emptyset \\ \Leftrightarrow & D_{\text{sub},A} \cap D_A \wedge \text{extract-virtual-constraint}(\text{multiple-reset}(D_A, D_{e,A} \wedge \phi_e, R)) \neq \emptyset \\ \Leftrightarrow & D_{\text{sub},A} \cap \text{multiple-reset}(D_A, D_{e,A} \wedge \phi_e, R) \neq \emptyset \end{aligned}$$

holds. By Proposition 3.9 we know that  $D_{e,A} = R(D_A)$ , which implies  $(D_{e,A} \wedge \phi_e) \subseteq R(D_A)$ , and  $R(D_{\text{sub},A}) = D_{e,\text{sub},A}$ . Therefore, we are allowed to apply the second statement of Proposition Y.3, which implies that

$$\begin{aligned} & R(D_{\text{sub},A}) \cap D_{e,A} \wedge \phi_e \neq \emptyset \\ \Leftrightarrow & D_{e,\text{sub},A} \cap D_{e,A} \wedge \phi_e \neq \emptyset \end{aligned}$$

which obviously implies  $D_{e,\text{sub},A} \wedge \phi_e \neq \emptyset$  and the second statement holds.

To show Completeness, we assume any non-empty zone  $D_{\text{sub},A} \subseteq D_A$  with

$$D_{\text{sub},A} \wedge \text{extract-virtual-constraint}(\text{multiple-reset}(D_A, D_{e,A} \wedge \phi_e, R)) = \emptyset$$

and show the statement  $D_{e,\text{split},A} \wedge \phi_e = \emptyset$ .

Analogously to the previous part of the proof, we can show that

$$\begin{aligned} & D_{\text{sub},A} \wedge \text{extract-virtual-constraint}(\text{multiple-reset}(D_A, D_{e,A} \wedge \phi_e, R)) = \emptyset \\ \Leftrightarrow & D_{\text{sub},A} \cap \text{multiple-reset}(D_A, D_{e,A} \wedge \phi_e, R) = \emptyset, \end{aligned}$$

$(D_{e,A} \wedge \phi_e) \subseteq R(D_A)$ , and  $R(D_{\text{sub},A}) = D_{e,\text{split},A}$ . Therefore, we are allowed to apply the third statement of Proposition Y.3, which yields

$$\begin{aligned} & R(D_{\text{sub},A}) \cap D_{e,A} \wedge \phi_e = \emptyset \\ \Leftrightarrow & D_{e,\text{split},A} \cap D_{e,A} \wedge \phi_e = \emptyset. \end{aligned}$$

This obviously implies  $D_{e,\text{split},A} \wedge \phi_e = \emptyset$  and the proposition holds.  $\square$

Obviously, the revert-sync can be extended to revert a set of virtual constraints by reverting each individually and afterwards applying combine to the result.

## AC. Implementing search-contradiction

When we compare a single transition with multiple transitions, as in Example 3.6, we also get multiple sets of virtual constraints. To calculate, which part of the target symbolic state has no bisimilar partner, we need to check which part of the virtual constraints occurs in all returned sets. To do this, we define the search-contradiction operator, which essentially just does some conjunction and disjunction on the sets of virtual constraints. Given an ordered set  $\text{trans}$  of transitions of a VCG, we denote  $\text{trans}[i]$  for the  $i$ th transition,  $\text{trans}[i].\text{start}$  for the symbolic start state of that transition,  $\text{trans}[i].\text{target}$  for the symbolic target state, and  $D_{\text{trans}[i].\text{target}}$  for the zone of  $\text{trans}[i].\text{target}$ .

**Definition AC.1. (search-contradiction operator)**

Assume two TA  $A, B$ , the corresponding VCGs  $A_{\text{VCG}}, B_{\text{VCG}}$ , an AB-synchronized symbolic state  $(l_A, D_A)$  of  $A_{\text{VCG}}$  and an AB-synchronized symbolic state  $(l_B, D_B)$  of  $B_{\text{VCG}}$  with  $D_A \equiv_{\text{virtual}} D_B$ . Let  $\text{trans}_A$  be a non-empty, ordered set of outgoing action transitions of  $(l_A, D_A)$  and  $\text{trans}_B$  be a non-empty, ordered set of outgoing transitions of  $(l_B, D_B)$ . Let  $k$  be a normalization function and  $\text{found-cont}$  be a matrix of sets of virtual constraints with  $|\text{trans}_A|$  lines and  $|\text{trans}_B|$  columns. Moreover, we assume

$$\begin{aligned} \forall i \in [0, |\text{trans}_A| - 1] : \forall j \in [0, |\text{trans}_B| - 1] : \forall \phi \in \text{found-cont}[i][j] : \\ [\phi] \subseteq [\text{extract-virtual-constraint}(\text{norm}(D_{\text{trans}_A[i].\text{target}}, k)) \wedge \\ \text{extract-virtual-constraint}(\text{norm}(D_{\text{trans}_B[j].\text{target}}, k))] \end{aligned}$$

and

$$\forall \phi \in \text{found-cont} : \phi = \text{norm}(\phi, k).$$

We define the operator

$$\begin{aligned} \text{search-contradiction} : \mathcal{D}(C_{A,\chi}) \times \mathcal{D}(C_{B,\chi}) \times \\ (L_A \times \mathcal{D}(C_{A,\chi})) \times \Sigma \times (L_A \times \mathcal{D}(C_{A,\chi}))^* \times \\ (L_B \times \mathcal{D}(C_{B,\chi})) \times \Sigma \times (L_B \times \mathcal{D}(C_{B,\chi}))^* \times \\ \mathcal{B}\{\chi_0, \dots, \chi_{|C_A|+|C_B|-1}\}^{**} \\ \rightarrow 2^{\mathcal{B}(\{\chi_0, \dots, \chi_{|C_A|+|C_B|-1}\})} \end{aligned}$$

such that

$$\text{search-contradiction}(D_A, D_B, \text{trans}_A, \text{trans}_B, \text{found-cont}) = \{\phi_0, \dots, \phi_n\}$$

with

1.  $\forall i \in [0, n] : [\phi_i] \neq \emptyset$ ,

- 2.

$$\begin{aligned} \forall i \in [0, n] : [\phi_i] \subseteq [\text{extract-virtual-constraint}(D_A)] \\ (= [\text{extract-virtual-constraint}(D_B)]), \end{aligned}$$

3.  $\forall i, j \in [0, n] : ([\phi_i \wedge \phi_j] \neq \emptyset)$  implies  $(i = j)$ , and

4. for any virtual constraint  $\phi \in \mathcal{B}(\{\chi_0, \dots, \chi_{|C_A|+|C_B|-1}\})$  with  $\exists i \in [0, n] : [\phi \wedge \phi_i] \neq \emptyset$  and  $D_A \wedge \phi \neq \emptyset$  one of the two following statements hold:

- (a) Either there exists a transition  $(l_A, D_A \wedge \phi) \xrightarrow[VCG]{\sigma} (l_{\sigma,A}, D_{\sigma,\text{sub},A})$  with corresponding TA transition  $l_A \xrightarrow[TA]{g,\sigma,R} l_{\sigma,A}$  with corresponding transition  $(l_A, D_A) \xrightarrow[VCG]{\sigma} (l_{\sigma,A}, D_{\sigma,A})$  with  $D_{\sigma,\text{sub},A} \subseteq D_{\sigma,A}$  in  $\text{trans}_A$  with index  $i$  such that

$$D_{\sigma,\text{sub},A} \wedge \left( \bigwedge_{j \in [0, |\text{trans}_B| - 1]} \right)$$

$$\left( \bigvee_{\phi_{\text{con}} \in \text{found-cont}[i][j]} \phi_{\text{con}} \vee \neg \text{extract-virtual-constraint}(D_{\text{trans}_B[j], \text{target}}) \right) \neq \emptyset$$

(b) or the analog statement for  $B$  holds,

5. for any virtual constraint  $\phi \in \mathcal{B}(\{\chi_0, \dots, \chi_{|C_A|+|C_B|-1}\})$  with  $\forall i \in [0, n] : [\phi \wedge \phi_i] = \emptyset$ , there exists no such transition.

To implement search-contradiction, we first introduce the FIND-CONTRADICTION function of Algorithm AC.1.

---

**Algorithm AC.1** The FIND-CONTRADICTION function.

---

▷ Let  $(l, D)$  be a symbolic state,  
 ▷ trans a set of transitions,  
 ▷ found-cont be a list of sets of virtual constraints of size  $|\text{trans}|$ , and  
 ▷ overhang be a list of sets of virtual constraints of size  $|\text{trans}|$ .  
 ▷ FIND-CONTRADICTION returns a set of virtual constraints

```

1: function FIND-CONTRADICTION( $(l, D)$ , trans, found-cont, overhang)
2:   result  $\leftarrow$  {extract-virtual-constraint( $D$ )}
3:   for  $i \in [0, |\text{trans}| - 1]$  do
4:     ▷ cont is the concatenation of found-cont and overhang
     cont  $\leftarrow$  found-cont[ $i$ ]  $\circ$  overhang[ $i$ ]
     ▷ The logical and of two lists of virtual constraints can be done by using distributivity
5:     result  $\leftarrow$  result  $\wedge$  cont
6:   end for
7:   return combine(result)
8: end function

```

---

**Proposition AC.1. (FIND-CONTRADICTION is Correct)**

We assume a symbolic state  $(l, D)$  and a set of transitions trans such that

$$\forall \text{cur}_1, \text{cur}_2 \in \text{trans} : \text{cur}_1.\text{start} = \text{cur}_2.\text{start}$$

and

$$\forall \text{cur} \in \text{trans} : \text{cur.start} \equiv_{\text{virtual}} D$$

holds. Moreover, we assume two lists of sets of virtual constraints found-cont and overhang of size  $|\text{trans}|$ . For

$$\text{FIND-CONTRADICTION}((l, D), \text{trans}, \text{found-cont}, \text{overhang}) = \{\phi_0, \dots, \phi_n\}$$

the statements

1.  $\forall i \in [0, n] : [\phi_i] \neq \emptyset$ ,
2.  $\forall i \in [0, n] : [\phi_i] \subseteq [\text{extract-virtual-constraint}(D)]$ ,
3.  $\forall i, j \in [0, n][\phi_i \wedge \phi_j] \neq \emptyset$  implies  $i = j$ , and
- 4.

$$\bigcup_{i \in [0, n]} [\phi_i] = \\ [\text{extract-virtual-constraint}(D)] \cap \\ \left( \bigcap_{i \in [0, |\text{trans}| - 1]} \left( \bigcup_{\phi_{\text{con}} \in \text{found-cont}[i]} [\phi_{\text{con}}] \cup \bigcup_{\phi_{\text{over}} \in \text{overhang}[i]} [\phi_{\text{over}}] \right) \right)$$

hold.

**Proof:**

The first and the third condition are directly implied by Definition AA.1. Since the second condition is trivially implied by the fourth condition, we only show the fourth condition. To show the fourth condition, we first show

$$\bigcup_{i \in [0, n]} [\phi_i] \subseteq \\ [\text{extract-virtual-constraint}(D)] \cap \\ \left( \bigcap_{i \in [0, |\text{trans}| - 1]} \left( \bigcup_{\phi_{\text{con}} \in \text{found-cont}[i]} [\phi_{\text{con}}] \cup \bigcup_{\phi_{\text{over}} \in \text{overhang}[i]} [\phi_{\text{over}}] \right) \right)$$

and afterwards the opposite direction. We show both directions by induction. Due to Definition AA.1, we know that any clock valuation which fulfills any returned virtual constraint, also fulfills a constraint of result and vice versa. Therefore, we are allowed to show the statements for the virtual constraints given in result instead of the returned. To show this statement, we define a precondition, an invariant, and a postcondition for the loop inside of the FIND-CONTRADICTION function. Since the loop obviously terminates after  $|\text{trans}|$  iteration, we skip that part of the proof.

**Precondition:** Let  $(l, D)$  be a symbolic state,  $\text{trans}$  be a set of transitions such that

$$\forall \text{cur}_1, \text{cur}_2 \in \text{trans} : \text{cur}_1.\text{start} = \text{cur}_2.\text{start}$$

and

$$\forall \text{cur} \in \text{trans} : \text{cur.start} \equiv_{\text{virtual}} D$$

holds. Moreover, we assume two lists of sets of virtual constraints  $\text{found-cont}$  and  $\text{overhang}$  of size  $|\text{trans}|$ . Assume

$$\text{result} = \{\text{extract-virtual-constraint}(D)\}.$$

**Invariant:** After  $n$  iteration, the statement

$$\bigcup_{\phi_{\text{res}} \in \text{result}} [\phi_{\text{res}}] =$$

$$[\text{extract-virtual-constraint}(D)] \cap$$

$$\left( \bigcap_{i \in [0, n-1]} \left( \bigcup_{\phi_{\text{con}} \in \text{found-cont}[i]} [\phi_{\text{con}}] \vee \bigcup_{\phi_{\text{over}} \in \text{overhang}} [\phi_{\text{over}}] \right) \right)$$

holds.

**Postcondition:** The statement

$$\bigcup_{\phi_{\text{res}} \in \text{result}} [\phi_{\text{res}}] =$$

$$[\text{extract-virtual-constraint}(D)] \cap$$

$$\left( \bigcap_{i \in [0, |\text{trans}|-1]} \left( \bigcup_{\phi_{\text{con}} \in \text{found-cont}[i]} [\phi_{\text{con}}] \vee \bigcup_{\phi_{\text{over}} \in \text{overhang}} [\phi_{\text{over}}] \right) \right)$$

holds.

Since the precondition is fulfilled and the postcondition is implied by the invariant, we only show the invariant by induction using the precondition.

**Hypothesis:** The invariant holds.

**Base Case:** The hypothesis holds for  $|\text{trans}| = 0$ .

**Induction Step:** If the invariant holds after  $n$  iteration, it also holds after  $n + 1$  iteration.

Before the first iteration,

$$\bigcup_{\phi_{\text{res}} \in \text{result}} [\phi_{\text{res}}] = \text{extract-virtual-constraint}(D)$$

by the precondition. Moreover,

$$[\text{extract-virtual-constraint}(D)] \cap$$

$$\left( \bigcap_{i \in [0, |\text{trans}|-1]} \left( \bigcup_{\phi_{\text{con}} \in \text{found-cont}[i]} [\phi_{\text{con}}] \vee \bigcup_{\phi_{\text{over}} \in \text{overhang}} [\phi_{\text{over}}] \right) \right)$$

$$= [\text{extract-virtual-constraint}(D)] \cap$$

$$\left( \bigcap_{i \in [0, -1]} \left( \bigcup_{\phi_{\text{con}} \in \text{found-cont}[i]} [\phi_{\text{con}}] \vee \bigcup_{\phi_{\text{over}} \in \text{overhang}} [\phi_{\text{over}}] \right) \right)$$

$$= [\text{extract-virtual-constraint}(D)] \cap \text{true}$$

$$= [\text{extract-virtual-constraint}(D)]$$

$$= \bigcup_{\phi_{\text{res}} \in \text{result}} [\phi_{\text{res}}]$$

and, therefore, the base case holds and we now show the induction step.

By the induction hypothesis, we know that after  $n$  iteration, the statement

$$\bigcup_{\phi_{\text{res}} \in \text{result}_n} [\phi_{\text{res}}] = [\text{extract-virtual-constraint}(D)] \cap \left( \bigcap_{i \in [0, n-1]} \left( \bigcup_{\phi_{\text{con}} \in \text{found-cont}[i]} [\phi_{\text{con}}] \vee \bigcup_{\phi_{\text{over}} \in \text{overhang}} [\phi_{\text{over}}] \right) \right)$$

holds. After the  $n + 1$ th iteration,

$$\text{result}_{n+1} = \text{result}_n \wedge (\text{found-cont}[n] \circ \text{overhang}[n])$$

holds, which implies

$$\begin{aligned} \bigcup_{\phi_{\text{res}} \in \text{result}_{n+1}} [\phi_{\text{res}}] &= \bigcup_{\phi_{\text{res}} \in \text{result}_n \wedge (\text{found-cont}[n] \circ \text{overhang}[n])} [\phi_{\text{res}}] \\ &= \bigcup_{\phi_{\text{res}} \in \text{result}_n} [\phi_{\text{res}} \wedge (\text{found-cont}[n] \circ \text{overhang}[n])] \text{ (Distributivity)} \\ &= \bigcup_{\phi_{\text{res}} \in \text{result}_n} [\phi_{\text{res}}] \cap [(\text{found-cont}[n] \circ \text{overhang}[n])] \\ &= \bigcup_{\phi_{\text{res}} \in \text{result}_n} [\phi_{\text{res}}] \cap \left( \bigcup_{\phi_{\text{cont}} \in \text{found-cont}[n]} [\phi_{\text{cont}}] \cup \bigcup_{\phi_{\text{cont}} \in \text{overhang}[n]} [\phi_{\text{cont}}] \right) \\ &= ([\text{extract-virtual-constraint}(D)] \cap \left( \bigcap_{i \in [0, n-1]} \left( \bigcup_{\phi_{\text{con}} \in \text{found-cont}[i]} [\phi_{\text{con}}] \vee \bigcup_{\phi_{\text{over}} \in \text{overhang}} [\phi_{\text{over}}] \right) \right)) \cap \\ &\quad \left( \bigcup_{\phi_{\text{cont}} \in \text{found-cont}[n]} [\phi_{\text{cont}}] \cup \bigcup_{\phi_{\text{cont}} \in \text{overhang}[n]} [\phi_{\text{cont}}] \right) \\ &= ([\text{extract-virtual-constraint}(D)] \cap \left( \bigcap_{i \in [0, n]} \left( \bigcup_{\phi_{\text{con}} \in \text{found-cont}[i]} [\phi_{\text{con}}] \vee \bigcup_{\phi_{\text{over}} \in \text{overhang}} [\phi_{\text{over}}] \right) \right)). \end{aligned}$$

Therefore, the induction step is also shown and the proposition holds.  $\square$

Now we show how that SEARCH-CONTRADICTION-IMPL of Algorithm AC.2 is a search-contradiction operator.

**Proposition AC.2. (SEARCH-CONTRADICTION-IMPL is Correct)**

SEARCH-CONTRADICTION-IMPL is a search-contradiction operator.

**Proof:**

The first and the third condition are directly implied by Definition AA.1. Therefore, we show only the second, the fourth, and the fifth statement. Due to Definition AA.1, we know that any clock valuation

**Algorithm AC.2** The SEARCH-CONTRADICTION-IMPL function.

---

▷ Let the inputs be according to Definition AC.1  
 ▷ SEARCH-CONTRADICTION returns a set of virtual constraints

```

1: function SEARCH-CONTRADICTION( $D_A, D_B, \text{trans}_A, \text{trans}_B, \text{found-cont}$ )
2:   contradictionA ← []                                     ▷ contradiction is a empty list of vc
3:   for  $i \in [0, |\text{trans}_A| - 1]$  do
4:      $((l_A, D_A) \xrightarrow[VCG]{\sigma} (l_{\sigma,A}, D_{\sigma,A})) \leftarrow \text{trans}_A[i]$ 
5:     overhangs ← []                                       ▷ overhangs is a list of list of vc
6:     for  $j \in [0, |\text{trans}_B| - 1]$  do
7:        $((l_B, D_B) \xrightarrow[VCG]{\sigma} (l_{\sigma,B}, D_{\sigma,B})) \leftarrow \text{trans}_B[j]$ 
8:       overhangs.append(
9:         extract-virtual-constraint( $D_{\sigma,A}$ )  $\wedge$   $\neg$ extract-virtual-constraint( $D_{\sigma,B}$ ))
10:      end for
11:      found ← FIND-CONTRADICTION( $(l_{\sigma,A}, D_{\sigma,A}), \text{trans}_B,$ 
12:        found-cont.get-row( $i$ ), overhangs)
    ▷ Let  $l_A \xrightarrow[TA]{g, \sigma, R} l_{\sigma,B}$  be the TA transition of  $(l_A, D_A) \xrightarrow[VCG]{\sigma} (l_{\sigma,A}, D_{\sigma,A})$ .
13:    contradictionA.appendAll(revert-action-trans( $D_A, g, R, I(l_{\sigma,A}), \text{found}$ ))
14:  end for
15:
16:  contradictionB ← []
17:  for  $i \in [0, |\text{trans}_B| - 1]$  do
18:     $((l_B, D_B) \xrightarrow[VCG]{\sigma} (l_{\sigma,B}, D_{\sigma,B})) \leftarrow \text{trans}_B[i]$ 
19:    overhangs ← []                                       ▷ overhangs is a list of list of vc
20:    for  $j \in [0, |\text{trans}_A| - 1]$  do
21:       $((l_A, D_A) \xrightarrow[VCG]{\sigma} (l_{\sigma,A}, D_{\sigma,A})) \leftarrow \text{trans}_A[j]$ 
22:      overhangs.append(
23:        extract-virtual-constraint( $D_{\sigma,B}$ )  $\wedge$   $\neg$ extract-virtual-constraint( $D_{\sigma,A}$ ))
24:      end for
25:      found ← FIND-CONTRADICTION( $(l_{\sigma,B}, D_{\sigma,B}), \text{trans}_A,$ 
26:        found-cont.get-column( $i$ ), overhangs)
    ▷ Let  $l_B \xrightarrow[TA]{g, \sigma, R} l_{\sigma,A}$  be the TA transition of  $(l_B, D_B) \xrightarrow[VCG]{\sigma} (l_{\sigma,B}, D_{\sigma,B})$ .
27:    contradictionB.appendAll(revert-action-trans( $D_B, g, R, I(l_{\sigma,B}), \text{found}$ ))
28:  end for
29:  contradiction ← contradictionA  $\circ$  contradictionB
30:  return combine(contradiction)
31: end function
  
```

---

which fulfills any returned virtual constraint, also fulfills a constraint of contradiction and vice versa. Therefore, we are allowed to show the statements for the virtual constraints given in contradiction instead of the returned.

The second statement holds trivially by the first condition of Definition Y.1, since any element added to contradiction is the return value of the revert-action-operator called either with  $D_A$  or  $D_B$  as first argument. Therefore, we show only the fourth and the fifth statement. We do this by defining a precondition, invariant, and a postcondition for the first loop. We show the invariant by induction and, afterwards, we show that the fourth and the fifth statement regarding the transitions of  $\text{trans}_A$  are implied. The statements for the second loop can be shown analogously and, therefore, we skip that. Since all loops obviously terminate, we skip that part of the proof, too.

**Precondition:** Let  $(l_A, D_A), (l_B, D_B)$  be AB-synchronized symbolic states with  $D_A \equiv_{\text{virtual}} D_B$ . Let  $\text{trans}_A$  be a non-empty, ordered set of outgoing action transitions of  $(l_A, D_A)$  and  $\text{trans}_B$  be a non-empty, ordered set of outgoing transitions of  $(l_B, D_B)$ . Let  $\text{found-cont}$  be a matrix of sets of virtual constraints with  $|\text{trans}_A|$  lines and  $|\text{trans}_B|$  columns. Let  $\text{contradiction}_A$  be an empty list. Moreover, we assume

$$\begin{aligned} \forall i \in [0, |\text{trans}_A| - 1] : \forall j \in [0, |\text{trans}_B| - 1] : \forall \phi \in \text{found-cont}[i][j] : \\ [\phi] \subseteq [\text{extract-virtual-constraint}(\text{norm}(D_{\text{trans}_A[i].\text{target}}, k)) \\ \wedge \text{extract-virtual-constraint}(\text{norm}(D_{\text{trans}_B[j].\text{target}}, k))]. \end{aligned}$$

**Invariant:** After  $n$  iteration, the following statements hold:

1. for any virtual constraint  $\phi \in \mathcal{B}(\{\chi_0, \dots, \chi_{|C_A|+|C_B|-1}\})$  with  $\exists \phi_{\text{con}} \in \text{contradiction}_A : [\phi \wedge \phi_{\text{con}}] \neq \emptyset$  there exists a transition  $(l_A, D_A \wedge \phi) \xrightarrow[VCG]{\sigma} (l_{\sigma,A}, D_{\sigma,\text{sub},A})$  with corresponding TA transition  $l_A \xrightarrow[TA]{g,\sigma,R} l_{\sigma,A}$  and the corresponding transition  $(l_A, D_A) \xrightarrow[VCG]{\sigma} (l_{\sigma,A}, D_{\sigma,A})$  with  $D_{\sigma,\text{sub},A} \subseteq D_{\sigma,A}$  in  $\text{trans}_A$  and with an index  $i < n$  such that

$$\begin{aligned} D_{\sigma,\text{sub},A} \wedge ( \bigwedge_{j \in [0, |\text{trans}_B| - 1]} \\ ( \bigvee_{\phi_{\text{con}} \in \text{found-cont}[i][j]} \phi_{\text{con}} \vee \neg \text{extract-virtual-constraint}(D_{\text{trans}_B[j].\text{target}}) ) ) \\ \neq \emptyset \end{aligned}$$

holds.

2. for any virtual constraint  $\phi \in \mathcal{B}(\{\chi_0, \dots, \chi_{|C_A|+|C_B|-1}\})$  with  $\forall \phi_{\text{con}} \in \text{contradiction}_A : [\phi \wedge \phi_{\text{con}}] = \emptyset$ , there exists no such transition.

**Postcondition:** After the loop terminated, the invariant holds for  $n = |\text{trans}_A|$ .

We show the invariant by induction.

**Hypothesis:** The invariant holds.

**Base Case:** The invariant holds for  $n = 0$ .

**Induction Step:** If the invariant holds after  $n$  iteration, then it also holds after  $n + 1$  iteration.



We first show the base case. Since  $\text{contradiction}_A$  is empty,  $\forall \phi_{\text{con}} \in \text{contradiction}_A : [\phi \wedge \phi_{\text{con}}] = \emptyset$  holds for any  $\phi$ . Since there is no transition with an index  $i < 0$ , the base case holds.

We now show the induction step. We denote the difference between  $\text{contradiction}_{A,n}$  and  $\text{contradiction}_{A,n+1}$  with

$$\text{contradiction}_{\text{new}} = [\phi_{\text{new},0}, \dots, \phi_{\text{new},m}].$$

Since no virtual constraint is removed from  $\text{contradiction}_A$ , the induction hypothesis implies

1. for any virtual constraint  $\phi \in \mathcal{B}(\{\chi_0, \dots, \chi_{|C_A|+|C_B|-1}\})$  with

$$\exists \phi_{\text{con}} \in \text{contradiction}_{A,n+1} \setminus \text{contradiction}_{A,\text{new}} : [\phi \wedge \phi_{\text{con}}] \neq \emptyset,$$

there exists a transition  $(l_A, D_A \wedge \phi) \xrightarrow[VCG]{\sigma} (l_{\sigma,A}, D_{\sigma,\text{sub},A})$  with corresponding TA transition

$$l_A \xrightarrow[TA]{g,\sigma,R} l_{\sigma,A} \text{ and the corresponding transition } (l_A, D_A) \xrightarrow[VCG]{\sigma} (l_{\sigma,A}, D_{\sigma,A}) \text{ with } D_{\sigma,\text{sub},A} \subseteq D_{\sigma,A} \text{ in } \text{trans}_A \text{ and with an index } i < n \text{ such that}$$

$$\begin{aligned} & D_{\sigma,\text{sub},A} \wedge \left( \bigwedge_{j \in [0, |\text{trans}_B|-1]} \right. \\ & \quad \left. \left( \bigvee_{\phi_{\text{con}} \in \text{found-cont}[i][j]} \phi_{\text{con}} \vee \neg \text{extract-virtual-constraint}(D_{\text{trans}_B[j].\text{target}}) \right) \right) \\ & \neq \emptyset \end{aligned}$$

holds.

2. for any virtual constraint  $\phi \in \mathcal{B}(\{\chi_0, \dots, \chi_{|C_A|+|C_B|-1}\})$  with

$$\forall \phi_{\text{con}} \in \text{contradiction}_{A,n+1} \setminus \text{contradiction}_{A,\text{new}} : [\phi \wedge \phi_{\text{con}}] = \emptyset,$$

there exists no such transition with  $i < n$ .

Therefore, to show the induction step, we only need to show

1. for any virtual constraint  $\phi \in \mathcal{B}(\{\chi_0, \dots, \chi_{|C_A|+|C_B|-1}\})$  with

$$\exists \phi_{\text{con}} \in \text{contradiction}_{A,\text{new}} : [\phi \wedge \phi_{\text{con}}] \neq \emptyset,$$

there exists a transition  $(l_A, D_A \wedge \phi) \xrightarrow[VCG]{\sigma} (l_{\sigma,A}, D_{\sigma,\text{sub},A})$  with corresponding TA transition

$$l_A \xrightarrow[TA]{g,\sigma,R} l_{\sigma,A} \text{ and the corresponding transition } (l_A, D_A) \xrightarrow[VCG]{\sigma} (l_{\sigma,A}, D_{\sigma,A}) \text{ with } D_{\sigma,\text{sub},A} \subseteq D_{\sigma,A} \text{ in } \text{trans}_A \text{ and with an index } i = n \text{ such that}$$

$$\begin{aligned} & D_{\sigma,\text{sub},A} \wedge \left( \bigwedge_{j \in [0, |\text{trans}_B|-1]} \right. \\ & \quad \left. \left( \bigvee_{\phi_{\text{con}} \in \text{found-cont}[i][j]} \phi_{\text{con}} \vee \neg \text{extract-virtual-constraint}(D_{\text{trans}_B[j].\text{target}}) \right) \right) \\ & \neq \emptyset \end{aligned}$$

holds and

2. for any virtual constraint  $\phi \in \mathcal{B}(\{\chi_0, \dots, \chi_{|C_A|+|C_B|-1}\})$  with

$$\forall \phi_{\text{con}} \in \text{contradiction}_{A,\text{new}} : [\phi \wedge \phi_{\text{con}}] = \emptyset,$$

there exists no such transition with  $i = n$ .

We show one statement after the other.

1. To show the first statement, we assume any  $\phi \in \mathcal{B}(\{\chi_0, \dots, \chi_{|C_A|+|C_B|-1}\})$  with

$$\exists \phi_{\text{con}} \in \text{contradiction}_{A,\text{new}} : [\phi \wedge \phi_{\text{con}}] \neq \emptyset$$

and  $D_A \wedge \phi \neq \emptyset$  by Definition Y.1. We denote

$$(l_A, D_A) \xrightarrow[VCG]{\sigma} (l_{\sigma,A}, D_{\sigma,A}) = \text{trans}_A[n]$$

with corresponding TA transition  $l_A \xrightarrow[TA]{g,\sigma,R} l_{\sigma,A}$ .

After the inner loop, the statement

$$\begin{aligned} & \forall i \in [0, \text{trans}_B - 1] : \text{overhangs}[i] \\ & = \text{extract-virtual-constraint}(D_{\sigma,A}) \wedge \neg \text{extract-virtual-constraint}(D_{\text{trans}_B[i].\text{target}}) \end{aligned}$$

obviously holds. Therefore, we are allowed to apply Proposition AC.1. Since  $\phi_{\text{con}}$  is element of the return value of revert-action-trans, we know by Definition Y.1 that there exists a transition  $(l_A, D_A \wedge \phi) \xrightarrow[VCG]{\sigma} (l_{\sigma,A}, D_{\sigma,\text{sub},A})$  with  $D_{\sigma,\text{sub},A} \subseteq D_{\sigma,A}$  and  $(D_{\sigma,\text{sub},A} \wedge \bigvee_{\phi_{\text{found}} \in \text{found}} \phi_{\text{found}}) \neq \emptyset$ .

By Proposition AC.1:

$$\begin{aligned} & \bigvee_{\phi_{\text{found}} \in \text{found}} \phi_{\text{found}} \\ & = \text{extract-virtual-constraint}(D_{\sigma,A}) \wedge \\ & \quad \left( \bigwedge_{i \in [0, |\text{trans}_B| - 1]} \left( \bigvee_{\phi_{\text{con}} \in \text{found-cont.get-row}(i)} \phi_{\text{con}} \vee \bigvee_{\phi_{\text{over}} \in \text{overhang}[i]} \phi_{\text{over}} \right) \right) \\ & = \text{extract-virtual-constraint}(D_{\sigma,A}) \wedge \\ & \quad \left( \bigwedge_{i \in [0, |\text{trans}_B| - 1]} \left( \bigvee_{\phi_{\text{con}} \in \text{found-cont.get-row}(i)} \phi_{\text{con}} \vee \right. \right. \\ & \quad \left. \left. \text{extract-virtual-constraint}(D_{\sigma,A}) \wedge \neg \text{extract-virtual-constraint}(D_{\text{trans}_B[i].\text{target}}) \right) \right) \\ & = \text{extract-virtual-constraint}(D_{\sigma,A}) \wedge \\ & \quad \left( \bigwedge_{i \in [0, |\text{trans}_B| - 1]} \left( \bigvee_{\phi_{\text{con}} \in \text{found-cont.get-row}(i)} \phi_{\text{con}} \vee \neg \text{extract-virtual-constraint}(D_{\text{trans}_B[i].\text{target}}) \right) \right) \end{aligned}$$

and this case of the induction step holds.

2. To show the second statement, we assume any virtual constraint  $\phi \in \mathcal{B}(\{\chi_0, \dots, \chi_{|C_A|+|C_B|-1}\})$  with

$$\forall \phi_{\text{con}} \in \text{contradiction}_{A,\text{new}} : [\phi \wedge \phi_{\text{con}}] = \emptyset.$$

Since we know from the previous case that

$$\begin{aligned} & \bigvee_{\phi_{\text{found}} \in \text{found}} \phi_{\text{found}} \\ &= \text{extract-virtual-constraint}(D_{\sigma,A}) \wedge \\ & \left( \bigwedge_{i \in [0, |\text{trans}_B| - 1]} \left( \bigvee_{\phi_{\text{con}} \in \text{found-cont.get-row}(i)} \phi_{\text{con}} \vee \right. \right. \\ & \quad \left. \left. \neg \text{extract-virtual-constraint}(D_{\text{trans}_B[i].\text{target}}) \right) \right) \end{aligned}$$

holds, this case of the induction step holds by Definition Y.1.

Since we can show the analog statement for  $B$  for the second loop, Proposition AC.2 holds.  $\square$

## AD. Implementing no-contradiction-possible

This section shows how to implement the no-contradiction-possible operator. It is defined as follows.

### Definition AD.1. (no-contradiction-possible operator)

Assume two TA  $A$  and  $B$ , the corresponding VCGs  $A_{\text{VCG}}, B_{\text{VCG}}$ , an AB-synchronized symbolic state  $(l_A, D_A)$  of  $A_{\text{VCG}}$ , and an AB-synchronized symbolic state  $(l_B, D_B)$  of  $B_{\text{VCG}}$  with  $D_A \equiv_{\text{virtual}} D_B$ . Let  $\text{trans}_A$  be a non-empty, ordered set of outgoing action transitions of  $(l_A, D_A)$  and  $\text{trans}_B$  be a non-empty, ordered set of outgoing transitions  $(l_B, D_B)$ . Let  $\text{found-cont}$  be a matrix of sets of virtual constraints with  $|\text{trans}_A|$  lines and  $|\text{trans}_B|$  columns. Moreover, we assume

$$\begin{aligned} & \forall i \in [0, |\text{trans}_A| - 1] : \forall j \in [0, |\text{trans}_B| - 1] : \forall \phi \in \text{found-cont}[i][j] : \\ & \quad [\phi] \subseteq [\text{extract-virtual-constraint}(\text{norm}(D_{\text{trans}_A[i].\text{target}}, k)) \wedge \\ & \quad \quad \text{extract-virtual-constraint}(\text{norm}(D_{\text{trans}_B[j].\text{target}}, k))] \end{aligned}$$

and let  $\text{finished}$  be a matrix with  $|\text{trans}_A|$  lines and  $|\text{trans}_B|$  columns with

$$\forall i \in [0, |\text{trans}_A| - 1] : \forall j \in [0, |\text{trans}_B| - 1] : \text{finished}[i][j] \in \{\text{true}, \text{false}\}.$$

We define the operator

$$\begin{aligned} \text{no-contradiction-possible} : & \mathcal{D}(C_{A,\chi}) \times \mathcal{D}(C_{B,\chi}) \times \\ & (L_A \times \mathcal{D}(C_{A,\chi})) \times \Sigma \times (L_A \times \mathcal{D}(C_{A,\chi}))^* \times \\ & (L_B \times \mathcal{D}(C_{B,\chi})) \times \Sigma \times (L_B \times \mathcal{D}(C_{B,\chi}))^* \times \\ & \mathcal{B}\{\chi_0, \dots, \chi_{|C_A|+|C_B|-1}\}^{**} \end{aligned}$$

$$\begin{aligned} & \{\text{true}, \text{false}\}^{*\times*} \\ & \rightarrow \{\text{true}, \text{false}\} \end{aligned}$$

such that

$$\text{no-contradiction-possible}(D_A, D_B, \text{trans}_A, \text{trans}_B, \text{found-cont}, \text{finished})$$

returns true if and only if

$$\text{search-contradiction}(D_A, D_B, \text{trans}_A, \text{trans}_B, \text{new-cont}) = \emptyset$$

with

$$\begin{aligned} & \forall i \in [0, \text{trans}_A - 1] : \forall j \in [0, \text{trans}_B - 1] : \\ & \text{new-cont}[i][j] = \begin{cases} \text{found-cont}[i][j], & \text{if finished}[i][j] = \text{true} \\ \text{extract-virtual-constraint}(\text{norm}(D_{\text{trans}_A[i].\text{target}}, k)) \wedge \\ \quad \text{extract-virtual-constraint}(\text{norm}(D_{\text{trans}_B[j].\text{target}}, k)), & \text{else.} \end{cases} \end{aligned}$$

We can easily implement this operator.

---

**Algorithm AD.1** The NO-CONTRADICTION-POSSIBLE-IMPL function.

---

▷ Let the inputs be according to Definition AD.1.  
 ▷ NO-CONTRADICTION-POSSIBLE returns true or false

```

1: function NO-CONTRADICTION-POSSIBLE( $D_A, D_B, \text{trans}_A, \text{trans}_B, \text{found-cont}, \text{finished}$ )
2:   new-cont  $\leftarrow$  matrix( $|\text{trans}_A|, |\text{trans}_B|$ )           ▷ new-cont is a  $|\text{trans}_A| \times |\text{trans}_B|$  matrix
3:   for  $i \in [0, |\text{trans}_A| - 1]$  do
4:     for  $j \in [0, |\text{trans}_B| - 1]$  do
5:       if finished[ $i$ ][ $j$ ] = true then
6:         new-cont[ $i$ ][ $j$ ]  $\leftarrow$  found-cont[ $i$ ][ $j$ ]
7:       else
8:         new-cont[ $i$ ][ $j$ ]  $\leftarrow$  extract-virtual-constraint(norm( $D_{\text{trans}_A[i].\text{target}}, k$ ))  $\wedge$ 
9:           extract-virtual-constraint(norm( $D_{\text{trans}_B[j].\text{target}}, k$ ))
10:      end if
11:    end for
12:  end for
13:  result  $\leftarrow$  search-contradiction( $D_A, D_B, \text{trans}_A, \text{trans}_B, \text{new-cont}$ )
14:  if result =  $\emptyset$  then
15:    return true
16:  else
17:    return false
18:  end if
19: end function

```

---

**Proposition AD.1. (NO-CONTRADICTION-POSSIBLE-IMPL is Correct.)**

NO-CONTRADICTION-POSSIBLE-IMPL is a no-contradiction-possible operator.

**Proof:**

Obvious. □

**AE. Definition of check-for-virt-bisim-in-order**

This section defines the check-for-virt-bisim-in-order-function.

**Definition AE.1. (check-for-virt-bisim-in-order function)**

Assume two TA  $A, B$ , using the sets of clocks  $C_A, C_B$ , the AB-semi-synchronized symbolic states  $(l_A, D_A)$  of the VCG  $A_{\text{VCG}}$  of  $A$  regarding  $B$  and  $(l_B, D_B)$  of the VCG  $B_{\text{VCG}}$  of  $B$  regarding  $A$ . Moreover, let  $n \in \mathbb{N}^{\geq 0}$ ,  $\text{visited}$  be a set of pairs of symbolic states, and  $k : C_A \cup C_B \cup \{\chi_0, \dots, \chi_{|C_A|+|C_B|-1}\} \rightarrow \mathbb{N}^{\geq 0}$  be a function, such that for any clock constraint  $c \sim n$ , which occurs in  $A$  or  $B$ ,  $n < k(c)$ , for any  $i \in [0, |C_A| - 1] : k(C_A[i]) = k(\chi_i)$ , and for any  $i \in [0, |C_B| - 1] : k(C_B[i]) = k(\chi_{i+|C_A|})$  hold. We define a function

$$\begin{aligned} \text{check-for-virt-bisim-in-order}_{n, A_{\text{VCG}}, B_{\text{VCG}}, k, \text{visited}} : & (L_A \times \mathcal{D}(C_A \cup \{\chi_0, \dots, \chi_{|C_A|+|C_B|-1}\})) \\ & \times (L_B \times \mathcal{D}(C_B \cup \{\chi_0, \dots, \chi_{|C_A|+|C_B|-1}\})) \\ & \rightarrow \mathcal{2}^{\mathcal{B}(\{\chi_0, \chi_1, \dots, \chi_{|C_A|+|C_B|-1}\})} \end{aligned}$$

with

$$\text{check-for-virt-bisim-in-order}_{n, A_{\text{VCG}}, B_{\text{VCG}}, k, \text{visited}}((l_A, D_A), (l_B, D_B)) = \{\phi_0, \dots, \phi_m\}$$

with  $\phi_0, \dots, \phi_m$  being virtual constraints, such that

1. (Non-Emptiness)  $\phi \in \{\phi_0, \dots, \phi_m\} : [\phi] \neq \emptyset$ ,
2. (Usefulness)
 
$$\forall \phi \in \{\phi_0, \dots, \phi_m\} : [\phi] \subseteq [\text{extract-virtual-constraint}(D_A)] \cup [\text{extract-virtual-constraint}(D_B)],$$
3. (Disjointness)  $\forall i, j \in [0, m] : [\phi_i \wedge \phi_j] \neq \emptyset$  implies  $i = j$ ,
4. (Soundness) for any non-empty zone  $D_{\text{sub},A} \subseteq D_A$  with  $\exists \phi \in \{\phi_0, \dots, \phi_m\} : D_{\text{sub},A} \wedge \phi \neq \emptyset$  exists no  $D_{\text{sub},B} \subseteq D_B$  such that  $(l_A, D_{\text{sub},A}) \sim_n (l_B, D_{\text{sub},B})$  and vice versa, and
5. (Completeness) if we assume  $\forall ((l_{v,A}, D_{v,A}), (l_{v,B}, D_{v,B})) \in \text{visited} : (l_{v,A}, D_{v,A}) \sim_n (l_{v,B}, D_{v,B})$  and

$$\text{check-for-virt-bisim-in-order}_{n, A_{\text{VCG}}, B_{\text{VCG}}, k, \text{visited}}((l_A, D_A), (l_B, D_B)) = \emptyset,$$

then for any  $D_{\text{sub},A} \subseteq D_A$  with  $D_{\text{sub},A} \neq \emptyset$  the statement

$$(l_A, D_{\text{sub},A}) \sim_n (l_B, D_B \wedge \text{extract-virtual-constraint}(D_{\text{sub},A}))$$

and the analog for  $B$

hold. The check-for-virt-bisim-in-order operator with  $n \rightarrow \infty$  is called a check-for-virt-bisim operator.

## AF. check-target-pair Operator

We describe the check-target-pair operator here.

### Definition AF.1. (check-target-pair Operator)

Assume two TA  $A, B$ , using the sets  $C_A, C_B$ , the AB-semi-synchronized symbolic states  $(l_{\sigma,A}, D_{\sigma,A})$  of the VCG  $A_{\text{VCG}}$  of  $A$  regarding  $B$  and  $(l_{\sigma,B}, D_{\sigma,B})$  of the VCG  $B_{\text{VCG}}$  of  $B$  regarding  $A$  with  $D_{\sigma,A} \equiv_{\text{virtual}} D_{\sigma,B}$ . Moreover, assume a normalization function  $k$  and a set of virtual constraints found-cont with

$$\begin{aligned} \forall \phi \in \text{found-cont} : [\phi] \subseteq & [\text{extract-virtual-constraint}(\text{norm}(D_{\sigma,A}, k))] \\ & (= [\text{extract-virtual-constraint}(\text{norm}(D_{\sigma,B}, k))]) \end{aligned}$$

and

$$\forall \phi \in \text{found-cont} : \phi = \text{norm}(\phi, k).$$

Let FUNC be a check-for-vist-bisim-in-order function with the visited set according to Definition AE.1 with order  $n \in \mathbb{N}^{\geq 0}$ . We define a function

$$\begin{aligned} \text{check-target-pair}_{A_{\text{VCG}}, B_{\text{VCG}}, \text{FUNC}} : & L_A \times \mathcal{D}(C_A \cup \{\chi_0, \dots, \chi_{|C_A|+|C_B|-1}\}) \times \\ & L_B \times \mathcal{D}(C_B \cup \{\chi_0, \dots, \chi_{|C_A|+|C_B|-1}\}) \\ & \mathcal{2}^{\mathcal{B}(\{\chi_0, \dots, \chi_{|C_A|+|C_B|-1}\})} \\ & \rightarrow \mathcal{2}^{\mathcal{B}(\{\chi_0, \dots, \chi_{|C_A|+|C_B|-1}\})} \end{aligned}$$

with

$$\text{check-target-pair}_{A_{\text{VCG}}, B_{\text{VCG}}, \text{FUNC}}((l_{\sigma,A}, D_{\sigma,A}), (l_{\sigma,B}, D_{\sigma,B}), \text{found-cont}) = \{\phi_0, \dots, \phi_m\}$$

such that

1.  $\forall \phi \in \{\phi_0, \dots, \phi_m\} : [\phi] \neq \emptyset$ ,
2.  $\forall \phi \in \{\phi_0, \dots, \phi_m\} : [\phi] \subseteq [\text{extract-virtual-constraint}(\text{norm}(D_{\sigma,A}))] \wedge (\phi = \text{norm}(\phi, k))$ ,
3.  $\forall \phi \in \{\phi_0, \dots, \phi_m\} : \forall \phi_{\text{cont}} \in \text{found-cont} : [\phi \wedge \phi_{\text{cont}}] = \emptyset$ ,
4.  $\forall i, j \in [0, m] : [\phi_i \wedge \phi_j] \neq \emptyset$  implies  $i = j$ ,
5. for any non-empty zone  $D_{\text{sub},A} \subseteq D_{\sigma,A}$  with  $\exists \phi \in \{\phi_0, \dots, \phi_m\} : D_{\text{sub},A} \wedge \phi \neq \emptyset$  exists no  $D_{\text{sub},B} \subseteq D_{\sigma,B}$  such that  $\text{FUNC}((l_A, D_{\text{sub},A}), (l_B, D_{\text{sub},B})) = \emptyset$  and vice versa, and

6. if we assume  $\forall((l_{v,A}, D_{v,A}), (l_{v,B}, D_{v,B})) \in \text{visited} : (l_{v,A}, D_{v,A}) \sim_n (l_{v,B}, D_{v,B})$  and the set  $\{\phi_0, \dots, \phi_m\}$  to be the empty set, then for any  $D_{\text{sub},A} \subseteq D_{\sigma,A}$  with  $D_{\text{sub},A} \neq \emptyset$  and  $\forall \phi \in \text{found-cont} : [D_{\text{sub},A} \wedge \phi] = \emptyset$  the statement

$$\text{FUNC}((l_{\sigma,A}, D_{\text{sub},A}), (l_{\sigma,B}, D_{\text{sub},B} \wedge \text{extract-virtual-constraint}(D_{\text{sub},A}))) = \emptyset$$

and the same for  $B$  holds.

---

**Algorithm AF.1** CHECK-TARGET-PAIR-IMPL-FULL function
 

---

- ▷ Let  $(l_{\sigma,A}, D_{\sigma,A})$  be a symbolic state of  $A_{\text{VCG}}$ ,
- ▷  $(l_{\sigma,B}, D_{\sigma,B})$  be a symbolic state of  $B_{\text{VCG}}$ ,
- ▷ found-cont be a set of contradictions, and
- ▷  $\text{FUNC} : (L_A \times \mathcal{D}(C_{A,\chi})) \times (L_B \times \mathcal{D}(C_{B,\chi})) \rightarrow 2^{\mathcal{B}(\{\chi_0, \dots, \chi_{|C_A|+|C_B|-1}\})}$ .
- ▷ CHECK-TARGET-PAIR-IMPL returns a set of virtual constraints

```

1: function CHECK-TARGET-PAIR-IMPLAVCG, BVCG, FUNC(( $l_{\sigma,A}, D_{\sigma,A}$ ), ( $l_{\sigma,B}, D_{\sigma,B}$ ), found-cont)
2:   without-cont  $\leftarrow$  extract-virtual-constraint( $D_{\sigma,A}$ )  $\wedge$   $\neg(\bigvee \text{found-cont})$ 
3:   contradictions  $\leftarrow$   $\emptyset$ 
4:   for  $\phi \in \text{without-cont}$  do
5:     new-cont  $\leftarrow$  FUNC(( $l_{\sigma,A}, D_{\sigma,A} \wedge \phi$ ), ( $l_{\sigma,B}, D_{\sigma,B} \wedge \phi$ ))
6:     contradictions = contradictions  $\cup$  new-cont
7:   end for
8:   contradictions  $\leftarrow$  norm(contradictions,  $k$ )
9:   return combine(contradictions)
10: end function

```

---

We now show that CHECK-TARGET-PAIR-IMPL-FULL of Algorithm AF.1 is a check-target-pair operator.

**Proposition AF.1. (CHECK-TARGET-PAIR-IMPL is Correct)**

CHECK-TARGET-PAIR-IMPL-FULL is a check-target-pair operator.

**Proof:**

We show the proposition by defining a precondition, invariant, and a postcondition for the loop, which afterwards imply the conditions. Since the loop obviously terminates, we skip that part of the proof.

**Precondition:** We assume the preconditions of Definition AF.1, contradictions =  $\emptyset$ , and without-cont = extract-virtual-constraint( $D_{\sigma,A}$ )  $\wedge$   $\neg(\bigvee \text{found-cont})$ .

**Invariant:** After  $i$  iteration, the statements

1.  $\forall \phi_{\text{con}} \in \text{contradictions} : [\phi_{\text{con}}] \neq \emptyset$ ,
2.  $\forall \phi_{\text{con}} \in \text{contradictions} : [\phi_{\text{con}}] \subseteq [\text{extract-virtual-constraint}(D_{\sigma,A}) \wedge \bigvee_{j \in [0, i]} \text{without-cont}[j]]$ ,
3.  $\forall \phi_{\text{con}} \in \text{contradictions} : \forall \phi_{\text{found}} \in \text{found-cont} : [\phi_{\text{con}} \wedge \phi_{\text{found}}] = \emptyset$ ,

4.  $\forall \phi_i, \phi_j \in \text{contradictions} : [\phi_i \wedge \phi_j] \neq \emptyset$  implies  $i = j$ ,
5. for any non-empty zone  $D_{\text{sub},A} \subseteq D_{\sigma,A}$  with  $\exists \phi_{\text{con}} \in \text{contradictions} : D_{\text{sub},A} \wedge \phi_{\text{con}} \neq \emptyset$  exists no  $D_{\text{sub},B} \subseteq D_{\sigma,B}$  such that  $\text{FUNC}((l_{\sigma,A}, D_{\text{sub},A}), (l_{\sigma,B}, D_{\text{sub},B})) = \emptyset$  and vice versa, and
6. if we assume  $\forall ((l_{v,A}, D_{v,A}), (l_{v,B}, D_{v,B})) \in \text{visited} : (l_{v,A}, D_{v,A}) \sim_n (l_{v,B}, D_{v,B})$  and  $\text{contradictions} = \emptyset$ , then for any  $D_{\text{sub},A} \subseteq D_{\sigma,A}$  with  $D_{\text{sub},A} \neq \emptyset$ ,  $\forall \phi \in \text{found-cont} : D_{\text{sub},A} \wedge \phi = \emptyset$ , and  $\forall j \in [i, |\text{without-cont}| - 1] : \text{without-cont}[j] \wedge D_{\text{sub},A} = \emptyset$  the statement

$$\text{FUNC}((l_{\sigma,A}, D_{\text{sub},A}), (l_{\sigma,B}, D_{\text{sub},B} \wedge \text{extract-virtual-constraint}(D_{\text{sub},A}))) = \emptyset$$

and the same for  $B$  holds,

hold.

**Postcondition:** After the loop terminates, the invariant holds for  $i = |\text{without-cont}| - 1$ .

Obviously, the invariant implies the postcondition. Therefore, we show only the invariant by induction.

**Hypothesis:** The invariant holds.

**Base Case:** The invariant holds for  $i = 0$ .

**Induction Step:** If the invariant holds for  $i$ , then it also holds for  $i + 1$ .

We first show the base case. Since we know by the precondition that  $\text{contradictions}$  is empty before the first iteration, the first five statements hold trivially. Since  $\text{contradictions} = \emptyset$ , we have to show the right hand side of the sixth condition. Since it is an implication, the statement trivially holds if the precondition of the implication is not fulfilled. Therefore, we show that for  $i = 0$ , there exists no  $D_{\text{sub},A} \subseteq D_{\sigma,A}$  with  $\forall \phi \in \text{found-cont} : D_{\text{sub},A} \wedge \phi = \emptyset$ ,  $\forall j \in [0, |\text{without-cont}| - 1] : \text{without-cont}[j] \wedge D_{\text{sub},A} = \emptyset$ , and  $D_{\text{sub},A} \neq \emptyset$ .

We can show

$$\begin{aligned} & [\bigvee \text{without-cont}] \cup [\bigvee \text{found-cont}] \\ &= [\text{extract-virtual-constraint}(D_{\sigma,A}) \wedge \neg(\bigvee \text{found-cont})] \cup [\bigvee \text{found-cont}] \\ &= [\text{extract-virtual-constraint}(D_{\sigma,A}) \wedge \neg(\bigvee \text{found-cont})] \cup \\ & \quad [\text{extract-virtual-constraint}(D_{\sigma,A}) \wedge \bigvee \text{found-cont}] \cup \\ & \quad [\neg(\text{extract-virtual-constraint}(D_{\sigma,A})) \wedge \bigvee \text{found-cont}] \\ &= [\text{extract-virtual-constraint}(D_{\sigma,A})] \cup [\neg(\text{extract-virtual-constraint}(D_{\sigma,A})) \wedge \bigvee \text{found-cont}]. \end{aligned}$$

Therefore,

$$[\text{extract-virtual-constraint}(D_{\sigma,A})] \subseteq [\bigvee \text{without-cont}] \cup [\bigvee \text{found-cont}]$$

and

$$(D \wedge D_{\sigma,A}) \neq \emptyset \text{ implies}$$



$$[\text{extract-virtual-constraint}(D) \wedge (\bigvee \text{without-cont} \vee \bigvee \text{found-cont})] \neq \emptyset,$$

which implies that there exists no  $D_{\text{sub},A} \subseteq D_{\sigma,A}$  with  $\forall \phi \in \text{found-cont} : [D_{\text{sub},A} \wedge \phi] = \emptyset$ ,  $\forall j \in [0, |\text{without-cont}| - 1] : \text{without-cont}[j] \wedge D_{\text{sub},A} = \emptyset$ , and  $D_{\text{sub},A} \neq \emptyset$ . Therefore, the base case holds.

We now show the induction step. We show one statement after the other.

1. By the induction hypothesis, we know that before the  $i + 1$ th iteration,  $\forall \phi \in \text{contradictions}_i : [\phi] \neq \emptyset$ . Since all virtual constraints that might be added during the  $i + 1$ th iteration are return values of FUNC, which is a check-for-virt-bisim-in-order function, the statement also holds after the  $i + 1$ th iteration by Definition AE.1.
2. Analogously to the previous case.
3. By the induction hypothesis, we know that the statements holds for all elements of  $\text{contradictions}_i$ . Therefore, we only have to check whether one of the elements of  $\text{new-cont}$  overlaps with an element of  $\text{contradictions}_i$  or whether two of the new elements overlap. By Definition AE.1, we know that for all virtual constraints  $\phi \in \text{new-cont}$  the statement

$$[\phi] \subseteq [\text{extract-virtual-constraint}(D_{\sigma,A}) \wedge \text{without-cont}[i]]$$

holds. By the second condition, we know that none of the virtual constraints of  $\text{contradictions}_i$  overlaps with  $\text{without-cont}[i]$  and, therefore,

$$\forall \phi_{\text{cond}} \in \text{contradictions}_i : \forall \phi_{\text{new}} \in \text{new-cont} : [\phi_{\text{cond}} \wedge \phi_{\text{new}}] = \emptyset$$

holds. Two elements of  $\text{new-cont}$  cannot overlap due to Disjointness of Definition AE.1. Therefore, this condition holds.

4. This condition is directly implied by Disjointness of Definition X.1 and Definition AE.1.
5. By the induction hypothesis, we know that this statement holds before the  $i + 1$ th iteration. Since we know by the previous case that Disjointness holds, we only have to show this statement for the elements of  $\text{new-cont}$ . Therefore, we assume any non-empty  $D_{\text{sub},A} \subseteq D_{\sigma,A}$  with  $\exists \phi_{\text{new}} \in \text{new-cont} : [D_{\text{sub},A} \wedge \phi_{\text{new}}] \neq \emptyset$  and show that there exists no  $D_{\text{sub},B} \subseteq D_{\sigma,B}$  such that  $\text{FUNC}((l_{\sigma,A}, D_{\text{sub},A}), (l_{\sigma,B}, D_{\text{sub},B})) = \emptyset$ . Since the same statement for  $B$  can be shown analogously, we only show this statement for  $A$ .

Since  $\text{new-cont}$  is the return value of the application of FUNC (which is a check-for-virt-bisim-in-order function), we know that  $[\phi_{\text{new}}] \subseteq [\text{without-cont}[i]]$ . Therefore,  $D_{\text{sub},A} \wedge \phi_{\text{new}} \subseteq D_{\sigma,A} \wedge \text{without-cont}[i]$ . By Definition AE.1, this implies that for any  $D_{\text{subsub},B} \subseteq D_{\sigma,B} \wedge \text{without-cont}[i]$  the statement

$$(l_{\sigma,A}, D_{\text{sub},A} \wedge \phi_{\text{new}}) \not\sim_n (l_{\sigma,B}, D_{\text{subsub},B})$$

holds. Since  $D_{\sigma,A} \wedge \text{without-cont}[i] \equiv_{\text{virtual}} D_{\sigma,B} \wedge \text{without-cont}[i]$ , we know that

$$D_{\sigma,B} \wedge \text{without-cont}[i] \wedge \text{extract-virtual-constraint}(D_{\text{sub},A} \wedge \phi_{\text{new}}) \equiv_{\text{virtual}} D_{\text{sub},A} \wedge \phi_{\text{new}}.$$

By Appendix U, we can follow

$$\begin{aligned}
& \exists v_A^{\text{TV}} \in (l_{\sigma,A}, D_{\text{sub},A} \wedge \phi_{\text{new}}) : \\
& \quad \forall v_B^{\text{TV}} \in (l_{\sigma,B}, D_{\sigma,B} \wedge \text{without-cont}[i] \wedge \text{extract-virtual-constraint}(D_{\text{sub},A} \wedge \phi_{\text{new}})) : \\
& \quad \quad v_A^{\text{TV}} \not\sim_n v_B^{\text{TV}} \vee \\
& \exists v_B^{\text{TV}} \in (l_{\sigma,B}, D_{\sigma,B} \wedge \text{without-cont}[i] \wedge \text{extract-virtual-constraint}(D_{\text{sub},A} \wedge \phi_{\text{new}})) : \\
& \quad \forall v_A^{\text{TV}} \in (l_{\sigma,A}, D_{\text{sub},A} \wedge \phi_{\text{new}}) : \\
& \quad \quad v_A^{\text{TV}} \not\sim_n v_B^{\text{TV}}.
\end{aligned}$$

By Corollary P.1,  $D_{\text{sub},A} \wedge \phi_{\text{new}} \subseteq D_{\sigma,A}$ , and

$$D_{\sigma,B} \wedge \text{without-cont}[i] \wedge \text{extract-virtual-constraint}(D_{\text{sub},A} \wedge \phi_{\text{new}}) \subseteq D_{\sigma,B},$$

we can follow

$$\begin{aligned}
& \exists v_{\sigma,A}^{\text{TV}} \in (l_{\sigma,A}, D_{\text{sub},A}) : \forall v_{\sigma,B}^{\text{TV}} \in (l_{\sigma,B}, D_{\sigma,B}) : \\
& \quad v_{\sigma,A}^{\text{TV}} \not\sim_n v_{\sigma,B}^{\text{TV}} \vee \\
& \exists v_{\sigma,B}^{\text{TV}} \in (l_{\sigma,B}, D_{\sigma,B}) : \forall v_{\sigma,A}^{\text{TV}} \in (l_{\sigma,A}, D_{\text{sub},A}) : \\
& \quad v_{\sigma,A}^{\text{TV}} \not\sim_n v_{\sigma,B}^{\text{TV}}.
\end{aligned}$$

By Corollary P.1 this implies that there exists a  $(l_{\sigma,A}, u_{\sigma,A}) \in (l_{\sigma,A}, D_{\text{sub},A})$  and a  $(l_{\sigma,B}, u_{\sigma,B}) \in (l_{\sigma,B}, D_{\sigma,B})$  such that  $\text{virt}(u_{\sigma,A}) = \text{virt}(u_{\sigma,B})$  and  $(l_{\sigma,A}, u_{\sigma,A}) \not\sim_n (l_{\sigma,B}, u_{\sigma,B})$ . By Corollary P.1 this implies that for any non-empty  $D_{\text{sub},B} \subseteq D_{\sigma,B}$  with  $D_{\text{sub},A} \equiv_{\text{virtual}} D_{\text{sub},B}$  the statement

$$\begin{aligned}
& \exists v_{\sigma,A}^{\text{TV}} \in (l_{\sigma,A}, D_{\text{sub},A}) : \forall v_{\sigma,B}^{\text{TV}} \in (l_{\sigma,B}, D_{\text{sub},B}) : \\
& \quad v_{\sigma,A}^{\text{TV}} \not\sim_n v_{\sigma,B}^{\text{TV}} \vee \\
& \exists v_{\sigma,B}^{\text{TV}} \in (l_{\sigma,B}, D_{\text{sub},B}) : \forall v_{\sigma,A}^{\text{TV}} \in (l_{\sigma,A}, D_{\text{sub},A}) : \\
& \quad v_{\sigma,A}^{\text{TV}} \not\sim_n v_{\sigma,B}^{\text{TV}}
\end{aligned}$$

holds, which implies by Appendix U

$$(l_{\sigma,A}, D_{\text{sub},A}) \not\sim_n (l_{\sigma,B}, D_{\text{sub},B}),$$

which implies  $\text{FUNC}((l_{\sigma,A}, D_{\text{sub},A}), (l_{\sigma,B}, D_{\text{sub},B})) \neq \emptyset$  and this case of the induction step holds.

6. To show the sixth condition, we assume contradictions  $i_{+1} = \emptyset$  and any  $D_{\text{sub},A} \subseteq D_{\sigma,A}$  with  $D_{\text{sub},A} \neq \emptyset$ ,  $\forall \phi \in \text{found-cont} : D_{\text{sub},A} \wedge \phi = \emptyset$ , and  $\forall j \in [i+1, |\text{without-cont}| - 1] : \text{without-cont}[j] \wedge D_{\text{sub},A} = \emptyset$  and show that the statement

$$\text{FUNC}((l_{\sigma,A}, D_{\text{sub},A}), (l_{\sigma,B}, D_{\text{sub},B} \wedge \text{extract-virtual-constraint}(D_{\text{sub},A}))) = \emptyset$$

holds. Since the analog statement for  $B$  can be shown analogously, we only show the statement for  $A$ .

Obviously,  $\text{contradictions}_{i+1} = \emptyset$  implies  $\text{contradictions}_i = \emptyset$ . By the induction hypothesis, we know that the statement holds if  $\forall j \in [i, |\text{without-cont}| - 1] : \text{without-cont}[j] \wedge D_{\text{sub},A} = \emptyset$  holds. By Appendix U, this implies

$$\begin{aligned} \forall v_{\sigma,A}^{\text{TV}} \in (l_{\sigma,A}, D_{\sigma,A}) : \exists v_{\sigma,B}^{\text{TV}} \in (l_{\sigma,B}, D_{\sigma,B}) : \\ (u_{\sigma,A} \not\equiv \bigvee_{j \in [i, \text{without-cont}-1]} \text{without-cont}[j]) \text{ implies } v_{\sigma,A}^{\text{TV}} \sim_n v_{\sigma,B}^{\text{TV}} \wedge \\ \forall v_{\sigma,B}^{\text{TV}} \in (l_{\sigma,B}, D_{\sigma,B}) : \exists v_{\sigma,A}^{\text{TV}} \in (l_{\sigma,A}, D_{\sigma,A}) : \\ (u_{\sigma,B} \not\equiv \bigvee_{j \in [i, \text{without-cont}-1]} \text{without-cont}[j]) \text{ implies } v_{\sigma,A}^{\text{TV}} \sim_n v_{\sigma,B}^{\text{TV}}. \end{aligned}$$

By Definition AE.1, we know that after the  $i + 1$ th iteration,  $\text{contradictions}_{i+1} = \emptyset$  implies  $(l_{\sigma,A}, D_{\sigma,A} \wedge \text{without-cont}[i]) \sim_n (l_{\sigma,B}, D_{\sigma,B} \wedge \text{without-cont}[i])$  (using the assumptions given in visited). By Appendix U, this implies

$$\begin{aligned} \forall v_{\sigma,A}^{\text{TV}} \in (l_{\sigma,A}, D_{\sigma,A} \wedge \text{without-cont}[i]) : \exists v_{\sigma,B}^{\text{TV}} \in (l_{\sigma,B}, D_{\sigma,B} \wedge \text{without-cont}[i]) : v_{\sigma,A}^{\text{TV}} \sim_n v_{\sigma,B}^{\text{TV}} \wedge \\ \forall v_{\sigma,B}^{\text{TV}} \in (l_{\sigma,B}, D_{\sigma,B} \wedge \text{without-cont}[i]) : \exists v_{\sigma,A}^{\text{TV}} \in (l_{\sigma,A}, D_{\sigma,A} \wedge \text{without-cont}[i]) : v_{\sigma,A}^{\text{TV}} \sim_n v_{\sigma,B}^{\text{TV}}. \end{aligned}$$

Therefore,

$$\begin{aligned} \forall v_{\sigma,A}^{\text{TV}} \in (l_{\sigma,A}, D_{\sigma,A}) : \exists v_{\sigma,B}^{\text{TV}} \in (l_{\sigma,B}, D_{\sigma,B}) : \\ (u_{\sigma,A} \not\equiv \bigvee_{j \in [i+1, \text{without-cont}-1]} \text{without-cont}[j]) \text{ implies } v_{\sigma,A}^{\text{TV}} \sim_n v_{\sigma,B}^{\text{TV}} \wedge \\ \forall v_{\sigma,B}^{\text{TV}} \in (l_{\sigma,B}, D_{\sigma,B}) : \exists v_{\sigma,A}^{\text{TV}} \in (l_{\sigma,A}, D_{\sigma,A}) : \\ (u_{\sigma,B} \not\equiv \bigvee_{j \in [i+1, \text{without-cont}-1]} \text{without-cont}[j]) \text{ implies } v_{\sigma,A}^{\text{TV}} \sim_n v_{\sigma,B}^{\text{TV}} \end{aligned}$$

holds, which implies by Appendix U that for  $D_{\text{sub},A}$  exists a  $D_{\text{sub},B} \subseteq D_{\sigma,B}$  such that  $(l_{\sigma,A}, D_{\text{sub},A}) \sim_n (l_{\sigma,B}, D_{\text{sub},B})$  holds. By Corollary P.1 we know

$$D_{\text{sub},B} = D_{\text{sub},A} \wedge \text{extract-virtual-constraint}(D_A)$$

and due to Non-Emptiness, Usefulness, and Soundness of Definition AE.1, we can follow

$$\text{FUNC}((l_{\sigma,A}, D_{\text{sub},A}), (l_{\sigma,B}, D_{\text{sub},B} \wedge \text{extract-virtual-constraint}(D_{\text{sub},A}))) = \emptyset$$

and the induction step holds.

Since the induction step implies the postcondition, which implies the proposition by Proposition 2.2, Proposition 3.11, and Definition AA.1 the proposition holds.  $\square$

## AG. Check Outgoing Transitions

We describe the check-outgoing-transitions operator here.

### Definition AG.1. (check-outgoing-transitions operator)

Assume two diagonal-free TA  $A, B$ , using the sets of clocks  $C_A, C_B$ , the VCG  $A_{\text{VCG}}$  of  $A$  regarding  $B$ , the VCG  $B_{\text{VCG}}$  of  $B$  regarding  $A$  and two AB-synchronized symbolic states  $(l_A, D_A), (l_B, D_B)$  with  $D_A \equiv_{\text{virtual}} D_B$ . Assume a  $\sigma \in \Sigma$  and let  $\text{trans}_A \in 2^{\overrightarrow{\text{VCG}}}$  be the set of all outgoing transitions of  $(l_A, D_A)$  labeled with  $\sigma$  and let  $\text{trans}_B \in 2^{\overrightarrow{\text{VCG}}}$  be the set of all outgoing transitions of  $(l_B, D_B)$  labeled with  $\sigma$ . We assume a  $n \in \mathbb{N}^{\geq 0}$  and  $\text{FUNC}$  to be a check-for-virt-bisim-in-order  $n, A_{\text{VCG}}, B_{\text{VCG}}, k, \text{visited}$  function. We define the operator

$$\begin{aligned} \text{check-outgoing-transitions}_{A_{\text{VCG}}, B_{\text{VCG}}, \text{FUNC}} : & \mathcal{D}(C_A \cup \{\chi_0, \dots, \chi_{|C_A|+|C_B|-1}\}) \times \\ & \mathcal{D}(C_B \cup \{\chi_0, \dots, \chi_{|C_A|+|C_B|-1}\}) \times \\ & 2^{\overrightarrow{\text{VCG}}} \times 2^{\overrightarrow{\text{VCG}}} \\ \rightarrow & 2^{\mathcal{B}(\chi_0, \dots, \chi_{|C_A|+|C_B|-1})} \end{aligned}$$

with

$$\text{check-outgoing-transitions}_{A_{\text{VCG}}, B_{\text{VCG}}, \text{FUNC}}(D_A, D_B, \text{trans}_A, \text{trans}_B) = \{\phi_0, \dots, \phi_m\}$$

with  $\{\phi_0, \dots, \phi_m\}$  being virtual constraints such that

1. (Non-Emptiness)  $\forall \phi \in \{\phi_0, \dots, \phi_m\} : [\phi] \neq \emptyset$ ,
2. (Usefulness)

$$\forall \phi \in \{\phi_0, \dots, \phi_m\} : [\phi] \subseteq [\text{extract-virtual-constraint}(D_A)] (= [\text{extract-virtual-constraint}(D_B)])$$

3. (Disjointness)  $\forall i, j \in [0, m] : [\phi_i \wedge \phi_j] \neq \emptyset$  implies  $i = j$ .
4. (Soundness) for any non-empty zone  $D_{\text{sub},A} \subseteq D_A$  with  $\exists \phi \in \{\phi_0, \dots, \phi_m\} : D_{\text{sub},A} \wedge \phi \neq \emptyset$  either exists a transition  $(l_A, D_{\text{sub},A}) \xrightarrow{\sigma} (l_{\sigma,A}, D_{\text{sub},\sigma,A})$  such that there exists *no* finite set of symbolic states  $\{(l_{\sigma,A}, D_{0,\text{sub},\sigma,A}), (l_{\sigma,A}, D_{1,\text{sub},\sigma,A}), \dots\}$  with  $(\bigcup D_{i,\text{sub},\sigma,A}) = D_{\sigma,A}$  such that for any  $(l_{\sigma,A}, D_{i,\text{sub},\sigma,A})$  there exists a transition  $(l_B, D_B) \xrightarrow{\sigma} (l_{\sigma,B}, D_{\sigma,B})$  such that there exists a zone  $D_{\text{sub},\sigma,B} \subseteq D_{\sigma,B}$  with

$$\text{FUNC}((l_{\sigma,A}, D_{i,\sigma,A}), (l_{\sigma,B}, D_{\text{sub},\sigma,B})) = \emptyset$$

or the symbolic state  $(l_B, D_B \wedge \text{extract-virtual-constraint}(D_{\text{sub},A}))$  has such a transition, and

5. (Completeness) the statement

$$\text{check-outgoing-transitions}_{A_{\text{VCG}}, B_{\text{VCG}}, \text{FUNC}}(\text{trans}_A, \text{trans}_B) = \emptyset$$

implies that for any transition  $(l_A, D_A) \xrightarrow{VCG, \sigma} (l_{\sigma, A}, D_{\sigma, A})$  exists a finite set of symbolic states  $\{(l_{\sigma, A}, D_{0, \sigma, A}), (l_{\sigma, A}, D_{1, \sigma, A}), \dots\}$  with  $(\bigcup D_{i, \sigma, A}) = D_{\sigma, A}$  such that for any  $(l_{\sigma, A}, D_{i, \sigma, A})$  there exists a transition  $(l_B, D_B) \xrightarrow{VCG, \sigma} (l_{\sigma, B}, D_{\sigma, B})$  such that there exists a zone  $D_{\text{sub}, \sigma, B} \subseteq D_{\sigma, B}$  with

$$\text{FUNC}((l_{\sigma, A}, D_{i, \sigma, A}), (l_{\sigma, B}, D_{\text{sub}, \sigma, B})) = \emptyset$$

and the analog statement for  $B$ .

The CHECK-OUTGOING-TRANSITIONS-IMPL-FULL function of Algorithm 4.2 is a check-outgoing-transitions operator. We first show that this is true in case at least one of the transition sets is empty.

**Proposition AG.1. (Part I of CHECK-OUTGOING-TRANSITIONS-IMPL-FULL is Correct)**

CHECK-OUTGOING-TRANSITIONS-IMPL-FULL is a check-outgoing-transitions operator if one of the given transition sets is empty.

**Proof:**

If one of the transition sets is empty, the condition of the first if statement evaluates to true. Therefore, combine(result) is returned and the first three statements hold by Definition AA.1. We only show the statements for  $|\text{trans}_A| = 0$  since the statements for  $|\text{trans}_B| = 0$  can be shown analogously. Before the loop, result is set to the empty list. After the loop, for any non-empty zone  $D_{\text{sub}, B} \subseteq D_B$  with  $\exists \phi \in \text{result} : D_{\text{sub}, B} \wedge \phi \neq \emptyset$  exists an outgoing transition  $(l_B, D_{\text{sub}, B}) \xrightarrow{VCG, \sigma} (l_{\sigma, B}, D_{\text{sub}, \sigma, B})$  by Definition Y.1. Since there exists no outgoing transition of  $(l_A, D_A)$  labeled with  $\sigma$ , soundness holds in this case. The empty set can only be returned if result is an empty list. This can only be the case if  $|\text{trans}_B| = 0$ , which implies completeness.  $\square$

To show the same proposition in case none of the transition sets is empty, we start with defining a postcondition of the innermost loop.

**Proposition AG.2. (The innermost loop of CHECK-OUTGOING-TRANSITIONS-IMPL-FULL)**

We assume the preconditions of check-outgoing-transitions. Let  $\exists i_A \in [0, |\text{trans}_A| - 1] : (l_A, D_A) \xrightarrow{VCG, \sigma} (l_{\sigma, A}, D_{\sigma, A}) = \text{trans}_A[i_A]$ ,  $|\text{trans}_B| > 0$ , found-cont be a set of virtual constraints such that

$$\begin{aligned} & \forall i \in [0, |\text{trans}_A| - 1] : \forall j \in [0, |\text{trans}_B| - 1] : \forall \phi \in \text{found-cont}[i][j] : \\ & \quad [\phi] \subseteq [\text{extract-virtual-constraint}(\text{norm}(D_{\text{trans}_A[i].\text{target}}, k)) \wedge \\ & \quad \quad \text{extract-virtual-constraint}(\text{norm}(D_{\text{trans}_B[j].\text{target}}, k)) \wedge \\ & \quad \quad \phi = \text{norm}(\phi, k)] \end{aligned}$$

and for any  $\phi \in \mathcal{B}(\{\chi_0, \dots, \chi_{|C_A|+|C_B|-1}\})$  for which there exists a  $\phi_{\text{con}} \in \text{found-cont}[i][j]$  with  $D_{\text{trans}_A[i].\text{target}} \wedge (\phi \wedge \phi_{\text{con}}) \neq \emptyset$ , there exists *no* symbolic substate  $(l_{\sigma, B}, D_{\text{sub}, \sigma, B}) \subseteq \text{trans}_B[j].\text{target}$  such that

$$\text{FUNC}(\text{trans}_A[i].\text{target} \wedge (\phi \wedge \phi_{\text{con}}), (l_{\sigma, B}, D_{\text{sub}, \sigma, B})) = \emptyset,$$

**Algorithm AG.1** CHECK-OUTGOING-TRANSITIONS-IMPL-FULL function

---

▷ Let  $\text{trans}_A$  and  $\text{trans}_B$  be two sets of transitions and  
 ▷  $\text{FUNC} : (L_A \times \mathcal{D}(C_{A,\chi})) \times (L_B \times \mathcal{D}(C_{B,\chi})) \rightarrow 2^{\mathcal{B}(\{\chi_0, \dots, \chi_{|C_A|+|C_B|-1}\})}$   
 ▷ CHECK-OUTGOING-TRANSITIONS-IMPL returns a set of virtual constraints

- 1: **function** CHECK-OUTGOING-TRANSITIONS-IMPL $_{A_{\text{VCG}}, B_{\text{VCG}}, \text{FUNC}}(D_A, D_B, \text{trans}_A, \text{trans}_B)$
- 2:   **if**  $\exists C \in \{A, B\} : 0 = |\text{trans}_C|$  **then** ▷ Let  $\neg C \in \{A, B\}$  with  $C \neq \neg C$
- 3:     result  $\leftarrow []$
- 4:     **for**  $(l_{\neg C}, D_{\neg C}) \xrightarrow[VCG]{\sigma} (l_{\sigma, \neg C}, D_{\sigma, \neg C}) \in \text{trans}_{\neg C}$  **do**
- ▷ Let  $l_{\neg C} \xrightarrow[TA]{g, \sigma, R} l_{\sigma, \neg C}$  be the corresponding TA transition.
- 5:     result  $\leftarrow$  result  $\circ$  revert-action-trans( $D_{\neg C}, g, R, I(l_{\sigma, \neg C}),$   
    extract-virtual-constraint( $D_{\sigma, \neg C}$ ))
- 6:
- 7:     **end for**
- 8:     **return** combine(result)
- 9: **end if**
- 10: found-cont  $\leftarrow$  matrix-of-size( $|\text{trans}_A| \times |\text{trans}_B|, \emptyset$ ) ▷ matrix of empty sets of vc
- 11: finished  $\leftarrow$  matrix-of-size( $|\text{trans}_A| \times |\text{trans}_B|, \text{false}$ ) ▷ matrix of booleans, all set to false
- 12: **repeat**
- 13:   **for all**  $(l_A, D_A) \xrightarrow[VCG]{\sigma} (l_{\sigma, A}, D_{\sigma, A}) \in \text{trans}_A$  **do**
- 14:     **for all**  $(l_B, D_B) \xrightarrow[VCG]{\sigma} (l_{\sigma, B}, D_{\sigma, B}) \in \text{trans}_B$  **do**
- 15:        $i_A \leftarrow$  index( $(l_A, D_A) \xrightarrow[VCG]{\sigma} (l_{\sigma, A}, D_{\sigma, A}), \text{trans}_A$ )
- 16:        $i_B \leftarrow$  index( $(l_B, D_B) \xrightarrow[VCG]{\sigma} (l_{\sigma, B}, D_{\sigma, B}), \text{trans}_B$ )
- 17:       **if** finished $[i_A][i_B] = \text{true}$  **then** continue with the next pair
- 18:        $D_{\text{eq}, A} \leftarrow D_{\sigma, A} \wedge$  extract-virtual-constraint( $D_{\sigma, B}$ )
- 19:        $D_{\text{eq}, B} \leftarrow D_{\sigma, B} \wedge$  extract-virtual-constraint( $D_{\sigma, A}$ )
- 20:       cont  $\leftarrow$  check-target-pair $_{A_{\text{VCG}}, B_{\text{VCG}}, \text{FUNC}}$ (  
        $(l_{\sigma, A}, D_{\text{eq}, A}), (l_{\sigma, B}, D_{\text{eq}, B}),$  found-cont $[i_A][i_B]$ )
- 21:       finished $[i_A][i_B] \leftarrow$  (cont =  $\emptyset$  ? true : false)
- 22:       found-cont $[i_A][i_B] \leftarrow$  found-cont $[i_A][i_B] \cup$  cont
- 23:
- 24:     **end for**
- 25:   **end for**
- 26:   contradiction  $\leftarrow$  search-contradiction( $D_A, D_B, \text{trans}_A, \text{trans}_B,$  found-cont)
- 27:   **if** contradiction  $\neq \emptyset$  **then**
- 28:     **return** contradiction
- 29:   **end if**
- 30: **until** no-contradiction-possible( $D_A, D_B, \text{trans}_A, \text{trans}_B,$  found-cont, finished) = true
- 31: **return**  $\emptyset$
- 32: **end function**

---

and the analog statement for  $B$  holds, and let `finished` be a matrix with  $\forall i \in [0, |\text{trans}_A| - 1] : \forall j \in [0, |\text{trans}_B| - 1] : \text{finished}[i][j] \in \{\text{true}, \text{false}\}$  and

$$\begin{aligned} & \forall i \in [0, |\text{trans}_A| - 1] : \forall j \in [0, |\text{trans}_B| - 1] : \\ & \quad \text{finished}[i][j] == \text{true} \text{ implies} \\ & \quad \text{check-target-pair}_{A_{\text{VCG}}, B_{\text{VCG}}, \text{FUNC}}( \\ & \quad \quad (\text{trans}_A[i].\text{target} \wedge \text{extract-virtual-constraint}(D_{\text{trans}_B[j].\text{target}})), \\ & \quad \quad (\text{trans}_B[j].\text{target} \wedge \text{extract-virtual-constraint}(D_{\text{trans}_A[i].\text{target}})), \\ & \quad \quad \text{found-cont}[i][j]) \\ & \quad = \emptyset. \end{aligned}$$

The most inner loop terminates and after it terminated, the statements

$$\begin{aligned} & \forall i \in [0, |\text{trans}_A| - 1] : \forall j \in [0, |\text{trans}_B| - 1] : \forall \phi \in \text{found-cont}[i][j] : \\ & \quad [\phi] \subseteq [\text{extract-virtual-constraint}(\text{norm}(D_{\text{trans}_A[i].\text{target}}, k)) \wedge \\ & \quad \quad \text{extract-virtual-constraint}(\text{norm}(D_{\text{trans}_B[j].\text{target}}, k)))] \wedge \\ & \quad \phi = \text{norm}(\phi, k), \end{aligned}$$

and for any  $\phi \in \mathcal{B}(\{\chi_0, \dots, \chi_{|C_A|+|C_B|-1}\})$  for which there exists a  $\phi_{\text{con}} \in \text{found-cont}[i][j]$  with  $D_{\text{trans}_A[i].\text{target}} \wedge (\phi \wedge \phi_{\text{con}}) \neq \emptyset$ , there exists *no* symbolic substate  $(l_{\sigma, B}, D_{\text{sub}, \sigma, B}) \subseteq \text{trans}_B[j].\text{target}$  such that

$$\text{FUNC}(\text{trans}_A[i].\text{target} \wedge (\phi \wedge \phi_{\text{con}}), (l_{\sigma, B}, D_{\text{sub}, \sigma, B})) = \emptyset,$$

and the analog statement for  $B$  holds, and `finished` is a matrix with  $\forall i \in [0, |\text{trans}_A| - 1] : \forall j \in [0, |\text{trans}_B| - 1] : \text{finished}[i][j] \in \{\text{true}, \text{false}\}$  and

$$\begin{aligned} & \forall i \in [0, |\text{trans}_A| - 1] : \forall j \in [0, |\text{trans}_B| - 1] : \\ & \quad \text{finished}[i][j] == \text{true} \text{ implies} \\ & \quad \text{check-target-pair}_{A_{\text{VCG}}, B_{\text{VCG}}, \text{FUNC}}( \\ & \quad \quad (\text{trans}_A[i].\text{target} \wedge \text{extract-virtual-constraint}(D_{\text{trans}_B[j].\text{target}})), \\ & \quad \quad (\text{trans}_B[j].\text{target} \wedge \text{extract-virtual-constraint}(D_{\text{trans}_A[i].\text{target}})), \\ & \quad \quad \text{found-cont}[i][j]) \\ & \quad = \emptyset. \end{aligned}$$

still holds and for all  $j \in [0, |\text{trans}_B| - 1]$  either  $\text{finished}[i_A][j] = \text{true}$  or

$$\begin{aligned} & \bigcup_{\phi \in \text{found-cont}_{\text{before}[i_A][j]}} [\phi] \subseteq \bigcup_{\phi \in \text{found-cont}[i_A][j]} [\phi] \wedge \\ & \bigcup_{\phi \in \text{found-cont}[i_A][j]} [\phi] \not\subseteq \bigcup_{\phi \in \text{found-cont}_{\text{before}[i_A][j]}} [\phi] \end{aligned}$$

with  $\text{found-cont}_{\text{before}}$  being the `found-cont` matrix before the loop was entered, hold.

**Proof:**

Since  $|\text{trans}_B|$  is finite, the innermost loop obviously terminates and we skip that part of the proof.

**Invariant:** After  $n$  iteration, the statements

$$\begin{aligned} & \forall i \in [0, |\text{trans}_A| - 1] : \forall j \in [0, |\text{trans}_B| - 1] : \forall \phi \in \text{found-cont}[i][j] : \\ & \quad [\phi] \subseteq [\text{extract-virtual-constraint}(\text{norm}(D_{\text{trans}_A[i].\text{target}}, k)) \wedge \\ & \quad \quad \text{extract-virtual-constraint}(\text{norm}(D_{\text{trans}_B[j].\text{target}}, k)))] \wedge \\ & \quad \phi = \text{norm}(\phi, k), \end{aligned}$$

and for any  $\phi \in \mathcal{B}(\{\chi_0, \dots, \chi_{|C_A|+|C_B|-1}\})$  for which there exists a  $\phi_{\text{con}} \in \text{found-cont}[i][j]$  with  $D_{\text{trans}_A[i].\text{target}} \wedge (\phi \wedge \phi_{\text{con}}) \neq \emptyset$ , there exists *no* symbolic substate  $(l_{\sigma,B}, D_{\text{sub},\sigma,B}) \subseteq \text{trans}_B[j].\text{target}$  such that

$$\text{FUNC}(\text{trans}_A[i].\text{target} \wedge (\phi \wedge \phi_{\text{con}}), (l_{\sigma,B}, D_{\text{sub},\sigma,B})) = \emptyset,$$

and the analog statement for  $B$  holds, and finished be a matrix with  $\forall i \in [0, |\text{trans}_A| - 1] : \forall j \in [0, |\text{trans}_B| - 1] : \text{finished}[i][j] \in \{\text{true}, \text{false}\}$  and

$$\begin{aligned} & \forall i \in [0, |\text{trans}_A| - 1] : \forall j \in [0, |\text{trans}_B| - 1] : \\ & \quad \text{finished}[i][j] == \text{true} \text{ implies} \\ & \quad \text{check-target-pair}_{A_{\text{VCG}}, B_{\text{VCG}}, \text{FUNC}}( \\ & \quad \quad (\text{trans}_A[i].\text{target} \wedge \text{extract-virtual-constraint}(D_{\text{trans}_B[j].\text{target}})), \\ & \quad \quad (\text{trans}_B[j].\text{target} \wedge \text{extract-virtual-constraint}(D_{\text{trans}_A[i].\text{target}})), \\ & \quad \quad \text{found-cont}[i][j]) \\ & \quad = \emptyset. \end{aligned}$$

still hold and for all  $j < n$  either  $\text{finished}[i_A][j] = \text{true}$  or

$$\begin{aligned} & \bigcup_{\phi \in \text{found-cont}_{\text{before}}[i_A][j]} [\phi] \subseteq \bigcup_{\phi \in \text{found-cont}[i_A][j]} [\phi] \wedge \\ & \bigcup_{\phi \in \text{found-cont}[i_A][j]} [\phi] \not\subseteq \bigcup_{\phi \in \text{found-cont}_{\text{before}}[i_A][j]} [\phi] \end{aligned}$$

with  $\text{found-cont}_{\text{before}}$  being the  $\text{found-cont}$  matrix before the loop was entered.

Since the proposition is directly implied by the invariant, we show only the invariant by induction.

**Hypothesis:** The invariant holds.

**Base Case:** The invariant holds for  $n = 0$ .

**Induction Step:** If the invariant holds for  $n$ , then it also holds for  $n + 1$ .

The base case obviously holds by the precondition and by  $n = 0$ . Therefore, we only show the induction step.

If before the  $n + 1$ th iteration the statement  $\text{finished}[i_A][n] = \text{true}$  holds, the statements hold trivially by the induction hypothesis. Therefore, we assume  $\text{finished}[i_A][n] = \text{false}$  before the  $n + 1$ th



iteration. Since only  $\text{found-cont}[i_A][n]$  and  $\text{finished}[i_A][n]$  can be changed during the  $n + 1$ th iteration, we only have to show that after the  $n + 1$ th iteration,

$$\begin{aligned} \forall \phi \in \text{found-cont}[i_A][n] : \\ [\phi] \subseteq [\text{extract-virtual-constraint}(\text{norm}(D_{\text{trans}_A[i_A].\text{target}}, k)) \wedge \\ \text{extract-virtual-constraint}(\text{norm}(D_{\text{trans}_B[n].\text{target}}, k)))] \wedge \\ \phi = \text{norm}(\phi, k), \end{aligned}$$

and for any  $\phi \in \mathcal{B}(\{\chi_0, \dots, \chi_{|C_A|+|C_B|-1}\})$  for which there exists a  $\phi_{\text{con}} \in \text{found-cont}[i][j]$  with  $D_{\text{trans}_A[i].\text{target}} \wedge (\phi \wedge \phi_{\text{con}}) \neq \emptyset$ , there exists *no* symbolic substate  $(l_{\sigma,B}, D_{\text{sub},\sigma,B}) \subseteq \text{trans}_B[j].\text{target}$  such that

$$\text{FUNC}(\text{trans}_A[i].\text{target} \wedge (\phi \wedge \phi_{\text{con}}), (l_{\sigma,B}, D_{\text{sub},\sigma,B})) = \emptyset,$$

and the analog statement for  $B$  holds,

$$\begin{aligned} \text{finished}[i_A][n] == \text{true} \text{ implies} \\ \text{check-target-pair}_{A_{\text{VCG}}, B_{\text{VCG}}, \text{FUNC}}( \\ (\text{trans}_A[i_A].\text{target} \wedge \text{extract-virtual-constraint}(D_{\text{trans}_B[n].\text{target}})), \\ (\text{trans}_B[n].\text{target} \wedge \text{extract-virtual-constraint}(D_{\text{trans}_A[i_A].\text{target}})), \\ \text{found-cont}[i_A][n]) \\ = \emptyset, \end{aligned}$$

and either  $\text{finished}[i_A][n] = \text{true}$  or

$$\begin{aligned} \bigcup_{\phi \in \text{found-cont}_{\text{before}}[i_A][n]} [\phi] \subseteq \bigcup_{\phi \in \text{found-cont}[i_A][n]} [\phi] \wedge \\ \bigcup_{\phi \in \text{found-cont}[i_A][n]} [\phi] \not\subseteq \bigcup_{\phi \in \text{found-cont}_{\text{before}}[i_A][n]} [\phi] \end{aligned}$$

with  $\text{found-cont}_{\text{before}}$  being the found-cont matrix before the loop was entered, hold.

The first and second statements are trivially implied by Definition AF.1. Since we assumed that the corresponding entry of  $\text{finished}$  is set to false, we know that it can be only changed to true (but not be true beforehand). This is the case if and only if the check-target-pair operator returns the empty set. Therefore, the third statement also trivially holds.

To show the third statement, we assume that  $\text{finished}[i_A][n]$  is not set to true (otherwise the statement holds trivially). This can only be the case if  $\text{cont}$  is not empty. By Definition AF.1, we know that  $\forall \phi_{\text{cont}} \in \text{cont} : \forall \phi_{\text{found}} \in \text{found-contra} : [\phi_{\text{cont}} \wedge \phi_{\text{found}}] \neq \emptyset$ . Therefore, the induction step is implied.  $\square$

The analog proposition holds for the loop in the middle.

**Proposition AG.3. (The loop in the middle of CHECK-OUTGOING-TRANSITIONS-IMPL-FULL)**

Assume the preconditions of check-outgoing-transitions. Let  $|\text{trans}_A| > 0$ ,  $|\text{trans}_B| > 0$ ,  $\text{found-cont}$  be an empty set of virtual constraints such that

$$\begin{aligned} & \forall i \in [0, |\text{trans}_A| - 1] : \forall j \in [0, |\text{trans}_B| - 1] : \forall \phi \in \text{found-cont}[i][j] : \\ & \quad [\phi] \subseteq [\text{extract-virtual-constraint}(\text{norm}(D_{\text{trans}_A[i].\text{target}}, k)) \wedge \\ & \quad \quad \quad \text{extract-virtual-constraint}(\text{norm}(D_{\text{trans}_B[j].\text{target}}, k)))] \wedge \\ & \quad \phi = \text{norm}(\phi, k), \end{aligned}$$

and for any  $\phi \in \mathcal{B}(\{\chi_0, \dots, \chi_{|C_A|+|C_B|-1}\})$  for which there exists a  $\phi_{\text{con}} \in \text{found-cont}[i][j]$  with  $D_{\text{trans}_A[i].\text{target}} \wedge (\phi \wedge \phi_{\text{con}}) \neq \emptyset$ , there exists *no* symbolic substate  $(l_{\sigma,B}, D_{\text{sub},\sigma,B}) \subseteq \text{trans}_B[j].\text{target}$  such that

$$\text{FUNC}(\text{trans}_A[i].\text{target} \wedge (\phi \wedge \phi_{\text{con}}), (l_{\sigma,B}, D_{\text{sub},\sigma,B})) = \emptyset,$$

and the analog statement for  $B$  holds, and  $\text{finished}$  be a matrix with  $\forall i \in [0, |\text{trans}_A| - 1] : \forall j \in [0, |\text{trans}_B| - 1] : \text{finished}[i][j] \in \{\text{true}, \text{false}\}$  and

$$\begin{aligned} & \forall i \in [0, |\text{trans}_A| - 1] : \forall j \in [0, |\text{trans}_B| - 1] : \\ & \quad \text{finished}[i][j] == \text{true} \text{ implies} \\ & \quad \text{check-target-pair}_{A_{\text{VCG}}, B_{\text{VCG}}, \text{FUNC}}( \\ & \quad \quad (\text{trans}_A[i].\text{target} \wedge \text{extract-virtual-constraint}(D_{\text{trans}_B[j].\text{target}})), \\ & \quad \quad (\text{trans}_B[j].\text{target} \wedge \text{extract-virtual-constraint}(D_{\text{trans}_A[i].\text{target}})), \\ & \quad \quad \text{found-cont}[i][j]) \\ & \quad = \emptyset. \end{aligned}$$

The loop in the middle terminates and after it terminated, the statements

$$\begin{aligned} & \forall i \in [0, |\text{trans}_A| - 1] : \forall j \in [0, |\text{trans}_B| - 1] : \forall \phi \in \text{found-cont}[i][j] : \\ & \quad [\phi] \subseteq [\text{extract-virtual-constraint}(\text{norm}(D_{\text{trans}_A[i].\text{target}}, k)) \wedge \\ & \quad \quad \quad \text{extract-virtual-constraint}(\text{norm}(D_{\text{trans}_B[j].\text{target}}, k)))] \wedge \\ & \quad \phi = \text{norm}(\phi, k), \end{aligned}$$

and for any  $\phi \in \mathcal{B}(\{\chi_0, \dots, \chi_{|C_A|+|C_B|-1}\})$  for which there exists a  $\phi_{\text{con}} \in \text{found-cont}[i][j]$  with  $D_{\text{trans}_A[i].\text{target}} \wedge (\phi \wedge \phi_{\text{con}}) \neq \emptyset$ , there exists *no* symbolic substate  $(l_{\sigma,B}, D_{\text{sub},\sigma,B}) \subseteq \text{trans}_B[j].\text{target}$  such that

$$\text{FUNC}(\text{trans}_A[i].\text{target} \wedge (\phi \wedge \phi_{\text{con}}), (l_{\sigma,B}, D_{\text{sub},\sigma,B})) = \emptyset,$$

and the analog statement for  $B$  holds, and  $\text{finished}$  be a matrix with  $\forall i \in [0, |\text{trans}_A| - 1] : \forall j \in [0, |\text{trans}_B| - 1] : \text{finished}[i][j] \in \{\text{true}, \text{false}\}$  and

$$\begin{aligned} & \forall i \in [0, |\text{trans}_A| - 1] : \forall j \in [0, |\text{trans}_B| - 1] : \\ & \quad \text{finished}[i][j] == \text{true} \text{ implies} \end{aligned}$$

$$\begin{aligned}
& \text{check-target-pair}_{A_{\text{VCG}}, B_{\text{VCG}}, \text{FUNC}}( \\
& \quad (\text{trans}_A[i].\text{target} \wedge \text{extract-virtual-constraint}(D_{\text{trans}_B[j].\text{target}})), \\
& \quad (\text{trans}_B[j].\text{target} \wedge \text{extract-virtual-constraint}(D_{\text{trans}_A[i].\text{target}})), \\
& \quad \text{found-cont}[i][j]) \\
& = \emptyset.
\end{aligned}$$

still hold and the statement  $\text{finished}[i][j] = \text{true}$  or

$$\begin{aligned}
& \forall j \in [0, |\text{trans}_B| - 1] : \\
& \quad \bigcup_{\phi \in \text{found-cont}_{\text{before}}[i][j]} [\phi] \subseteq \bigcup_{\phi \in \text{found-cont}[i][j]} [\phi] \wedge \\
& \quad \bigcup_{\phi \in \text{found-cont}[i][j]} [\phi] \not\subseteq \bigcup_{\phi \in \text{found-cont}_{\text{before}}[i][j]} [\phi]
\end{aligned}$$

with  $\text{found-cont}_{\text{before}}$  being the  $\text{found-cont}$  matrix before the loop was entered, hold.

**Proof:**

Since  $|\text{trans}_A|$  is finite, the loop obviously terminates and we skip that part of the proof.

**Invariant:** After  $n$  iteration, the statements

$$\begin{aligned}
& \forall i \in [0, |\text{trans}_A| - 1] : \forall j \in [0, |\text{trans}_B| - 1] : \forall \phi \in \text{found-cont}[i][j] : \\
& \quad [\phi] \subseteq [\text{extract-virtual-constraint}(\text{norm}(D_{\text{trans}_A[i].\text{target}}, k)) \wedge \\
& \quad \quad \text{extract-virtual-constraint}(\text{norm}(D_{\text{trans}_B[j].\text{target}}, k))] \wedge \\
& \quad \phi = \text{norm}(\phi, k),
\end{aligned}$$

and for any  $\phi \in \mathcal{B}(\{\chi_0, \dots, \chi_{|C_A|+|C_B|-1}\})$  for which there exists a  $\phi_{\text{con}} \in \text{found-cont}[i][j]$  with  $D_{\text{trans}_A[i].\text{target}} \wedge (\phi \wedge \phi_{\text{con}}) \neq \emptyset$ , there exists *no* symbolic substate  $(l_{\sigma, B}, D_{\text{sub}, \sigma, B}) \subseteq \text{trans}_B[j].\text{target}$  such that

$$\text{FUNC}(\text{trans}_A[i].\text{target} \wedge (\phi \wedge \phi_{\text{con}}), (l_{\sigma, B}, D_{\text{sub}, \sigma, B})) = \emptyset,$$

and the analog statement for  $B$  holds, and  $\text{finished}$  be a matrix with  $\forall i \in [0, |\text{trans}_A| - 1] : \forall j \in [0, |\text{trans}_B| - 1] : \text{finished}[i][j] \in \{\text{true}, \text{false}\}$  and

$$\begin{aligned}
& \forall i \in [0, |\text{trans}_A| - 1] : \forall j \in [0, |\text{trans}_B| - 1] : \\
& \quad \text{finished}[i][j] == \text{true} \text{ implies} \\
& \quad \text{check-target-pair}_{A_{\text{VCG}}, B_{\text{VCG}}, \text{FUNC}}( \\
& \quad \quad (\text{trans}_A[i].\text{target} \wedge \text{extract-virtual-constraint}(D_{\text{trans}_B[j].\text{target}})), \\
& \quad \quad (\text{trans}_B[j].\text{target} \wedge \text{extract-virtual-constraint}(D_{\text{trans}_A[i].\text{target}})), \\
& \quad \quad \text{found-cont}[i][j]) \\
& = \emptyset.
\end{aligned}$$

still hold and for all  $i < n$  the statement  $\text{finished}[i][j] = \text{true}$  or

$$\forall j \in [0, |\text{trans}_B| - 1] : \\ \bigcup_{\phi \in \text{found-cont}_{\text{before}}[i][j]} [\phi] \subseteq \bigcup_{\phi \in \text{found-cont}[i][j]} [\phi] \wedge \\ \bigcup_{\phi \in \text{found-cont}[i][j]} [\phi] \not\subseteq \bigcup_{\phi \in \text{found-cont}_{\text{before}}[i][j]} [\phi]$$

with  $\text{found-cont}_{\text{before}}$  being the found-cont matrix before the loop was entered.

Since the proposition is implied by the invariant and the invariant is trivially implied by Proposition AG.2, the proposition to show holds.  $\square$

Now we can show that CHECK-OUTGOING-TRANSITIONS-IMPL-FULL of Algorithm 4.2 is a check-outgoing-transitions operator.

**Proposition AG.4. (CHECK-OUTGOING-TRANSITIONS-IMPL-FULL is Correct)**

CHECK-OUTGOING-TRANSITIONS-IMPL-FULL is a check-outgoing-transitions operator.

**Proof:**

Due to Proposition AG.1, we only need to analyze the case in which both transition sets are not empty.

We first show that the outermost loop terminates.

The outer loop is either terminated if search-contradiction returns a non-empty set or if no-contradiction-possible returns true. Therefore, we only have to show that no-contradiction-possible becomes eventually true if search-contradiction always returns the empty set (otherwise the loop is terminated anyway).

If  $\forall i \in [0, |\text{trans}_A| - 1] : \forall j \in [0, |\text{trans}_B| - 1] : \text{finished}[i][j] = \text{true}$  then no-contradiction-possible returns true if and only if

$$\text{search-contradiction}(D_A, D_B, \text{trans}_A, \text{trans}_B, \text{found-cont}) = \emptyset,$$

which we assumed to be the case. Therefore, we only have to show that each entry of finished will eventually become true. Since we know by Proposition 2.3 that there are only finitely many normalized virtual constraints,

$$\forall i \in [0, |\text{trans}_A| - 1] : \forall j \in [0, |\text{trans}_B| - 1] : \\ \bigcup \text{found-cont}[i][j] \\ = [\text{extract-virtual-constraint}(\text{norm}(D_{\text{trans}_A[i].\text{target}}, k))] \cup \\ [\text{extract-virtual-constraint}(\text{norm}(D_{\text{trans}_B[j].\text{target}}, k))]$$

will happen eventually due to Proposition AG.3, which implies that check-target-pair returns the empty set (implied by Condition two and three of Definition AF.1), which implies

$$\forall i \in [0, |\text{trans}_A| - 1] : \forall j \in [0, |\text{trans}_B| - 1] : \text{finished}[i][j] = \text{true}$$

and the loop terminates. Therefore, we now show Correctness.

Since the return value of CHECK-OUTGOING-TRANSITIONS-IMPL-FULL is either  $\emptyset$  or the return value of search-contradiction, the first three statements hold by Definition AC.1. Therefore, we only have to show Soundness and Completeness.

We first show Soundness. Since the precondition of Soundness can only be true if search-contradiction returned a non-empty set, we assume that search-contradiction returned the non-empty set  $\{\phi_{\text{con},0}, \dots, \phi_{\text{con},n_{\text{con}}}\}$ . To show Soundness, we assume any non-empty zone  $D_{\text{sub},A} \subseteq D_A$  with  $\exists \phi_{\text{con}} \in \{\phi_{\text{con},0}, \dots, \phi_{\text{con},n_{\text{con}}}\} : D_{\text{sub},A} \wedge \phi_{\text{con}} \neq \emptyset$ . We have to show that there either exists a transition  $(l_A, D_A) \xrightarrow[VCG]{\sigma} (l_{\sigma,A}, D_{\sigma,A})$  such that there exists no finite set of symbolic states  $\{(l_{\sigma,A}, D_{0,\text{sub},\sigma,A}), \dots\}$  with  $(\bigcup D_{i,\text{sub},\sigma,A}) = D_{\sigma,A}$  such that for any  $D_{i,\text{sub},\sigma,A}$  there exists a transition  $(l_B, D_B) \xrightarrow[VCG]{\sigma} (l_{\sigma,B}, D_{\sigma,B})$  such that there exists a zone  $D_{\text{sub},\sigma,B} \subseteq D_{\sigma,B}$  with

$$\text{FUNC}((l_{\sigma,A}, D_{i,\sigma,A}), (l_{\sigma,B}, D_{\text{sub},\sigma,B})) = \emptyset$$

or the symbolic state  $(l_B, D_B \wedge \text{extract-virtual-constraint}(D_{\text{sub},A}))$  has such an outgoing transition.

By Definition AC.1 (with  $\phi = \text{extract-virtual-constraint}(D_A)$ ), we know that either there exists a transition  $(l_A, D_{\text{sub},A}) \xrightarrow[VCG]{\sigma} (l_{\sigma,A}, D_{\sigma,\text{sub},A})$  with corresponding TA transition  $l_A \xrightarrow[TA]{g,\sigma,R} l_{\sigma,A}$  with corresponding transition  $(l_A, D_A) \xrightarrow[VCG]{\sigma} (l_{\sigma,A}, D_{\sigma,A})$  with  $D_{\sigma,\text{sub},A} \subseteq D_{\sigma,A}$  in  $\text{trans}_A$  with index  $i$  such that

$$\begin{aligned} & D_{\sigma,\text{sub},A} \wedge \left( \bigcap_{j \in [0, |\text{trans}_B| - 1]} \right. \\ & \quad \left. \left( \bigcup_{\phi_{\text{con}} \in \text{found-cont}[i][j]} [\phi_{\text{con}}] \cup [\neg \text{extract-virtual-constraint}(D_{\text{trans}_B[j].\text{target}})] \right) \right) \\ & \neq \emptyset \end{aligned}$$

or the analog statement for  $(l_B, D_{\text{sub},B} \wedge \text{extract-virtual-constraint}(D_{\text{sub},A}))$  holds. We distinguish these cases.

1. If the first case holds, we denote the result of the shown operation with  $\phi_{\sigma,\text{sub},A,\text{found-cont}}$ . By the Proposition AG.3, we know that for any  $j$  and for any non-empty partition  $D_{\text{subsub},A} \subseteq D_{\sigma,A} \wedge \text{phi}_{\sigma,\text{sub},A,\text{found-cont}}$ , there exists no symbolic substate  $(l_{\sigma,B}, D_{\text{sub},\sigma,B}) \subseteq \text{trans}_B[j].\text{target}$  such that

$$\text{FUNC}((l_{\sigma,A}, D_{\text{subsub},A}), (l_{\sigma,B}, D_{\text{sub},\sigma,B})) = \emptyset$$

holds. Therefore, Soundness holds in this case.

2. If the second case holds, Soundness can be shown analogously to the first case.

We now show Completeness. The precondition of Completeness can only be true if no-contradiction-possible returned true. To show Completeness, we have to show that no-contradiction-possible returns true implies that for any transition  $(l_A, D_A) \xrightarrow[VCG]{\sigma} (l_{\sigma,A}, D_{\sigma,A})$  with an value  $i \in [0, |\text{trans}_A| -$

1] such that  $(l_A, D_A) \xrightarrow{VCG} (l_{\sigma,A}, D_{\sigma,A}) = \text{trans}_A[i]$ , exists a finite set of symbolic states  $\{(l_{\sigma,A}, D_{0,\sigma,A}), (l_{\sigma,A}, D_{1,\sigma,A}), \dots\}$  with  $(\bigcup D_{i,\sigma,A}) = D_{\sigma,A}$  such that for any  $(l_{\sigma,A}, D_{i,\sigma,A})$  there exists a transition  $(l_B, D_B) \xrightarrow{VCG} (l_{\sigma,B}, D_{\sigma,B})$  such that there exists a zone  $D_{\text{sub},\sigma,B} \subseteq D_{\sigma,B}$  with

$$\text{FUNC}((l_{\sigma,A}, D_{i,\sigma,A}), (l_{\sigma,B}, D_{\text{sub},\sigma,B})) = \emptyset$$

and the analog statement for  $B$ . Since the analog statement for  $B$  can be shown analogously to the statement of  $A$ , we skip that part of the proof. By Definition AD.1 and Definition AC.1, we know that no-contradiction-possible can only return true if for any transition  $(l_A, D_A) \xrightarrow{VCG} (l_{\sigma,A}, D_{\sigma,A}) = \text{trans}_A[i]$  there exists a set  $\{(l_{\sigma,A}, D_{0,\sigma,A}), (l_{\sigma,A}, D_{1,\sigma,A}), \dots\}$  with  $(\bigcup D_{k,\sigma,A}) = D_{\sigma,A}$  and

$$\begin{aligned} \forall (l_{\sigma,A}, D_{\text{cur},\sigma,A}) \in \{(l_{\sigma,A}, D_{0,\sigma,A}), (l_{\sigma,A}, D_{1,\sigma,A}), \dots\} : \exists j \in [0, \text{trans}_B - 1] : \forall \phi \in \text{found-cont} : \\ \text{finished}[i][j] = \text{true} \wedge \\ (D_{\text{cur},\sigma,A} \wedge \phi \cup D_{\text{cur},\sigma,A} \wedge \neg \text{extract-virtual-constraint}(D_{\text{exttrans}_B[j]}.target)) = \emptyset. \end{aligned}$$

By Proposition AG.3 and Definition AF.1, this implies Completeness.  $\square$

## AH. Check-For-Virt-Bisim-In-Order Impl

In this section, we show that the CHECK-FOR-VIRT-BISIM-IN-ORDER-IMPL function of Algorithm 4.1 is a check-for-virt-bisim-in-order function according to Definition AE.1.

### Proposition AH.1. (CHECK-FOR-VIRT-BISIM-IN-ORDER-IMPL is Correct)

CHECK-FOR-VIRT-BISIM-IN-ORDER-IMPL is a check-for-virt-bisim-in-order function.

#### Proof:

Since  $\Sigma$  is finite and with every recursion step,  $n$  is decreased by one and, therefore, will eventually become zero, we skip the termination proof. For every recursion step, we define a precondition and an invariant.

**Precondition:** We assume the preconditions of Definition AE.1.

**Invariant:** After the function returns, we assume the return value  $\{\phi_0, \dots, \phi_m\}$  and the statements

1. (Non-Emptiness)  $\phi \in \{\phi_0, \dots, \phi_m\} : [\phi] \neq \emptyset$ ,
2. (Usefulness)

$$\forall \phi \in \{\phi_0, \dots, \phi_m\} : [\phi] \subseteq [\text{extract-virtual-constraint}(D_A)] \cup [\text{extract-virtual-constraint}(D_B)],$$

3. (Disjointness)  $\forall i, j \in [0, m] : [\phi_i \wedge \phi_j] \neq \emptyset$  implies  $i = j$ ,
4. (Soundness) for any non-empty zone  $D_{\text{sub},A} \subseteq D_A$  with  $\exists \phi \in \{\phi_0, \dots, \phi_m\} : D_{\text{sub},A} \wedge \phi \neq \emptyset$  exists no  $D_{\text{sub},B} \subseteq D_B$  such that  $(l_A, D_{\text{sub},A}) \sim_n (l_B, D_{\text{sub},B})$  and vice versa, and

5. (Completeness) if we assume  $\forall((l_{v,A}, D_{v,A}), (l_{v,B}, D_{v,B})) \in \text{visited} : (l_{v,A}, D_{v,A}) \sim_n (l_{v,B}, D_{v,B})$  and

$$\text{check-for-virt-bisim-in-order}_{n, \text{AVCG}, \text{BVCG}, k, \text{visited}}((l_A, D_A), (l_B, D_B)) = \emptyset,$$

then for any  $D_{\text{sub},A} \subseteq D_A$  with  $D_{\text{sub},A} \neq \emptyset$  the statement

$$(l_A, D_{\text{sub},A}) \sim_n (l_B, D_B \wedge \text{extract-virtual-constraint}(D_{\text{sub},A}))$$

and the analog for  $B$

hold.

We show the invariant by induction.

**Hypothesis:** The invariant holds.

**Base Case:** The invariant holds if  $n = 0$ .

**Induction Step:** If the invariant holds for  $n$ , then it also holds for  $n + 1$ .

We first show the base case. If  $n = 0$ , the condition of the first if statement evaluates to true. Therefore,

$$\begin{aligned} & \text{extract-virtual-constraint}(D_A) \wedge \neg \text{extract-virtual-constraint}(D_B) \cup \\ & \text{extract-virtual-constraint}(D_B) \wedge \neg \text{extract-virtual-constraint}(D_A) \end{aligned}$$

is returned. We show that all statements hold.

1. Non-Emptiness holds by Definition X.1.
2. Usefulness holds by Definition X.1 and Definition 4.1.
3. Disjointness holds by Definition X.1 and by the fact that

$$\text{extract-virtual-constraint}(D_A) \wedge \neg \text{extract-virtual-constraint}(D_B)$$

and

$$\text{extract-virtual-constraint}(D_B) \wedge \neg \text{extract-virtual-constraint}(D_A)$$

are obviously disjoint.

4. We show Soundness only for a non-empty zone  $D_{\text{sub},A} \subseteq D_A$  since the statement for a subzone of  $D_B$  can be shown analogously. By Definition X.1 and Definition 4.1, we know that

$$\begin{aligned} & \exists \phi \in \text{extract-virtual-constraint}(D_A) \wedge \neg \text{extract-virtual-constraint}(D_B) \cup \\ & \text{extract-virtual-constraint}(D_B) \wedge \neg \text{extract-virtual-constraint}(D_A) : \\ & D_{\text{sub},A} \wedge \phi \neq \emptyset \end{aligned}$$

implies

$$\exists \phi \in \text{extract-virtual-constraint}(D_A) \wedge \neg \text{extract-virtual-constraint}(D_B)$$

$$D_{\text{sub},A} \wedge \phi \neq \emptyset,$$

since a subzone of  $D_A$  cannot fulfill any virtual constraint of  $\neg\text{extract-virtual-constraint}(D_A)$ . Therefore,

$$\exists \phi \in \neg\text{extract-virtual-constraint}(D_B) : D_{\text{sub},A} \wedge \phi \neq \emptyset.$$

By Definition 4.1, there cannot be any subzone of  $D_B$  which is virtually equivalent to  $D_{\text{sub},A}$ , which is required for virtual bisimulation in order 0 by Definition 3.11 and, therefore, Soundness holds in the base case.

5. The return value can only be the empty set if and only if  $D_A \equiv_{\text{virtual}} D_B$  holds. Therefore, for any non-empty  $D_{\text{sub},A} \subseteq D_A$ , the statement

$$D_{\text{sub},A} \equiv_{\text{virtual}} D_B \wedge \text{extract-virtual-constraint}(D_{\text{sub},A})$$

holds, which implies

$$(l_A, D_{\text{sub},A}) \sim_0 (l_B, D_B \wedge \text{extract-virtual-constraint}(D_{\text{sub},A}))$$

by Definition 3.11. Therefore, Completeness also holds in the base case.

Therefore, the base case holds and we show the induction step. If  $D_A$  and  $D_B$  are not virtual equivalent, we can show all statements analogously to the base case. Therefore, we assume the zones to be virtually equivalent.

If the pair of normalized symbolic states is element of visited, the condition of the second if statement evaluates to true and  $\emptyset$  is returned. The first four statements hold trivially, while Completeness holds by Proposition 3.11. Therefore, we also assume that the normalized symbolic states are not element of visited. Under these two assumptions, either  $\emptyset$  or the return value of revert-sync are returned. We show one statement after the other.

1. Non-Emptiness trivially holds by Definition AB.1.
2. Since we assumed  $D_A \equiv_{\text{virtual}} D_B$ , the virtual constraints of both zones are the same. Therefore, Usefulness also holds by AB.1.
3. Analogously to the first case.
4. To show Soundness, we assume a non-empty zone  $D_{\text{sub},A} \subseteq D_A$  with

$$\begin{aligned} \exists \phi \in \text{CHECK-FOR-VIRT-BISIM-IN-ORDER-IMPL}_{A_{\text{VCG}}, B_{\text{VCG}}, k, \text{visited}, n+1}((l_A, D_A), (l_B, D_B)) : \\ D_{\text{sub},\varepsilon,A} \wedge \phi_\varepsilon \neq \emptyset. \end{aligned}$$

Since the case for  $B$  can be shown analogously, we skip that. If the returned value is not  $\emptyset$ , either

$$\text{FUNC}((l_A, D_{\varepsilon,A}), (l_B, D_{\varepsilon,B})) \neq \emptyset$$



or

$$\exists \sigma \in \Sigma : \text{CHECK-OUTGOING-TRANSITIONS-IMPL}_{A_{\text{VCG}}, B_{\text{VCG}}, \text{FUNC}}(D_{e,A}, D_{e,B}, \text{out-trans}(\sigma, (l_A, D_{e,A})), \text{out-trans}(\sigma, (l_B, D_{e,B}))) \neq \emptyset$$

holds. In both cases, the  $\phi$  regarding our  $D_{\text{sub},A}$  is a return value of  $\text{revert-sync}((l_A, D_A), (l_B, D_B), \text{sync-cond})$ . We denote

$$((l_A, D_{\text{sub},e,A}), (l_B, D_{\text{sub},e,B})) = \text{sync}((l_A, D_{\text{sub},A}), (l_B, D_B \wedge \text{extract-virtual-constraint}(D_{\text{sub},A})))$$

and remind the reader of the fact that  $D_B \wedge \text{extract-virtual-constraint}(D_{\text{sub},A})$  is the only subzone of  $D_B$  being virtual equivalent to  $D_{\text{sub},A}$ . Moreover,  $D_{\text{sub},e,A} \subseteq D_{e,A}$  and  $D_{\text{sub},e,B} \subseteq D_{e,B}$ . By Definition AB.1 we know that

$$\exists \phi_e \in \text{sync-cond} : D_{e,\text{sub},A} \wedge \phi_e \neq \emptyset.$$

We now distinguish the two cases.

(a) In this case, we assume

$$\text{FUNC}((l_A, D_{\varepsilon,A}), (l_B, D_{\varepsilon,B})) = \{\phi_{\varepsilon,0}, \dots, \phi_{\varepsilon,p}\} \neq \emptyset.$$

We denote the target of the  $\varepsilon$ -transition of  $(l_A, D_{e,\text{sub},A})$  with  $(l_A, D_{\varepsilon,\text{sub},A})$  and remind the reader of the fact that  $D_{e,\text{sub},A} \subseteq D_{e,A}$  implies  $D_{\varepsilon,\text{sub},A} \subseteq D_{\varepsilon,A}$  and analogous for  $B$ . By Definition Z.1, this implies

$$\exists \phi_\varepsilon \in \varepsilon\text{-result} : D_{\varepsilon,\text{sub},A} \wedge \phi_\varepsilon \neq \emptyset.$$

By the induction hypothesis, we know that  $\text{FUNC}$  is a check-for-virt-bisim-in-order function for order  $n$ . Therefore, we know by Soundness of Definition AE.1 that for any non-empty zone  $D_{\text{sub},\varepsilon,A} \subseteq D_{\varepsilon,A}$  with

$$\exists \phi_\varepsilon \in \{\phi_{\varepsilon,0}, \dots, \phi_{\varepsilon,p}\} : D_{\text{sub},\varepsilon,A} \wedge \phi_\varepsilon \neq \emptyset$$

exists no  $D_{\text{sub},\varepsilon,B} \subseteq D_B$  such that

$$(l_A, D_{\text{sub},\varepsilon,A}) \sim_n (l_B, D_{\text{sub},\varepsilon,B}).$$

Therefore,  $(l_A, D_{\text{sub},e,A})$  has an outgoing  $\varepsilon$ -transition, such that the target is not virtual bisimilar to any symbolic substate of the target of the  $\varepsilon$ -transition of  $(l_B, D_{\text{sub},e,B})$  and Soundness holds by Definition 3.11.

(b) In this case, we assume

$$\exists \sigma \in \Sigma : \text{CHECK-OUTGOING-TRANSITIONS-IMPL}_{A_{\text{VCG}}, B_{\text{VCG}}, \text{FUNC}}(D_{e,A}, D_{e,B}, \text{out-trans}(\sigma, (l_A, D_{e,A})), \text{out-trans}(\sigma, (l_B, D_{e,B}))) \neq \emptyset.$$

By the induction hypothesis, we are allowed to apply Definition AG.1, which implies Soundness in this case.

5. When checking for Virtual Bisimulation in order  $n+1$  of  $(l_A, D_A)$  and  $(l_B, D_B)$  we are allowed to assume Virtual Bisimulation in order  $n$  of those symbolic states since if we find a contradiction within the next  $n$  steps, we will also find it within the next  $n+1$  steps and do not have to recheck cycles. Therefore, the assumption

$$\forall((l_{v,A}, D_{v,A}), (l_{v,B}, D_{v,B})) \in \text{visited} : (l_{v,A}, D_{v,A}) \sim_{n+1} (l_{v,B}, D_{v,B})$$

implies the assumption

$$\forall((l_{v,A}, D_{v,A}), (l_{v,B}, D_{v,B})) \in \text{new-visited} : (l_{v,A}, D_{v,A}) \sim_n (l_{v,B}, D_{v,B})$$

by Proposition 3.1.

If CHECK-FOR-VIRT-BISIM-IN-ORDER-IMPL returns the emptyset,

$$\text{FUNC}((l_A, D_{\varepsilon,A}), (l_B, D_{\varepsilon,B})) = \emptyset$$

and

$$\forall \sigma \in \Sigma : \text{CHECK-OUTGOING-TRANSITIONS-IMPL}_{A_{\text{VCG}}, B_{\text{VCG}}, \text{FUNC}}(D_{e,A}, D_{e,B}, \text{out-trans}(\sigma, (l_A, D_A)), \text{out-trans}(\sigma, (l_B, D_B))) = \emptyset$$

hold. To show completeness, we assume any non-empty  $D_{\text{sub},A} \subseteq D_A$ . Since Completeness for any  $D_{\text{sub},B} \subseteq D_B$  can be shown analogously, we skip that part of the proof. Since

$$D_{\text{sub},A} \equiv_{\text{virtual}} D_B \wedge \text{extract-virtual-constraint}(D_{\text{sub},A})$$

obviously holds, we know by Definition 3.11 that we have to analyze the outgoing transitions of

$$((l_A, D_{\text{sub},e,A}), (l_B, D_{\text{sub},e,B})) = \text{sync}((l_A, D_{\text{sub},A}), (l_B, D_B \wedge \text{extract-virtual-constraint}(D_{\text{sub},A}))).$$

We distinguish between the outgoing  $\varepsilon$ -transitions and the outgoing action transitions.

- (a)  $\varepsilon$ -transition. We denote the target of the  $\varepsilon$ -transition of  $(l_A, D_{\text{sub},e,A})$  with  $(l_A, D_{\text{sub},\varepsilon,A})$  and the target of the  $\varepsilon$ -transition of  $(l_B, D_{\text{sub},e,B})$  with  $(l_B, D_{\text{sub},\varepsilon,B})$ . Due to  $D_{\text{sub},e,A} \subseteq D_{e,A}$ ,  $D_{\text{sub},\varepsilon,A} \subseteq D_{\varepsilon,A}$ ,  $D_{e,A} \equiv_{\text{virtual}} D_{e,B}$  and the analog statements for  $B$ , we can show

$$\begin{aligned} & \text{extract-virtual-constraint}(D_{\text{sub},\varepsilon,A}) \\ &= \text{extract-virtual-constraint}(D_{\text{sub},A}^\uparrow \wedge I(l_A)) \\ &= \text{extract-virtual-constraint}(D_A^\uparrow \cap D_{\text{sub},A}^\uparrow \wedge I(l_A)) \\ &= \text{extract-virtual-constraint}(D_A^\uparrow \wedge I(l_A)) \wedge \text{extract-virtual-constraint}(D_{\text{sub},A}^\uparrow) \\ &= \text{extract-virtual-constraint}(D_{\varepsilon,A}) \wedge \text{extract-virtual-constraint}(D_{\text{sub},A}^\uparrow) \\ &= \text{extract-virtual-constraint}(D_{\varepsilon,B}) \wedge \text{extract-virtual-constraint}(D_{\text{sub},B}^\uparrow) \\ &= \text{extract-virtual-constraint}(D_{\varepsilon,B} \cap D_{\text{sub},B}^\uparrow) \end{aligned}$$

$$\begin{aligned}
&= \text{extract-virtual-constraint}(D_B^\uparrow \cap D_{\text{sub},B}^\uparrow \wedge I(l_B)) \\
&= \text{extract-virtual-constraint}(D_{\text{sub},B}^\uparrow \wedge I(l_B)) \\
&= \text{extract-virtual-constraint}(D_{\text{sub},\varepsilon,B}^\uparrow)
\end{aligned}$$

which implies  $D_{\text{sub},\varepsilon,A} \equiv_{\text{virtual}} D_{\text{sub},\varepsilon,B}$ . Therefore,

$$D_{\text{sub},\varepsilon,B} = D_{\varepsilon,B} \wedge \text{extract-virtual-constraint}(D_{\text{sub},\varepsilon,A})$$

and Completeness holds by the induction hypothesis.

- (b) Any action transition with  $\sigma \in \Sigma$ . By the induction hypothesis, we are allowed to apply Definition AG.1, which implies Completeness in this case.

Therefore, CHECK-FOR-VIRT-BISIM-IN-ORDER-IMPL is a check-for-virt-bisim-in-order function.  $\square$

## AI. Multiple $\varepsilon$ -transitions

We show Proposition 4.3 here. To do so, we first show the following proposition.

### Proposition AI.1. (Future of Future)

Assume a set of clocks  $C$ , any zone  $D \in \mathcal{D}(C)$  and a clock constraint  $c \sim n$  with  $c \in C$ ,  $\sim \in \{<, \leq, \geq, >\}$ , and  $n \in \mathbb{N}^{\geq 0}$ .

$$(D^\uparrow \wedge (c \sim n))^\uparrow \wedge (c \sim n) = D^\uparrow \wedge (c \sim n)$$

holds.

#### Proof:

According to Definition 2.6, we know

$$D^\uparrow \wedge (c \sim n) = \{u + d \mid u \in D \wedge d \in \mathbb{T} \wedge u + d \models (c \sim n)\}$$

and

$$(D^\uparrow \wedge (c \sim n))^\uparrow \wedge (c \sim n) = \{u + d \mid u \in (D^\uparrow \wedge (c \sim n)) \wedge d \in \mathbb{T} \wedge u + d \models (c \sim n)\}.$$

To show the proposition, we have to show that both sets are the same. To do so, we first show that the first set is a subset of the second and afterwards the opposite direction.

To show the first direction, we assume any  $u_{\text{lhs}} \in D^\uparrow \wedge (c \sim n)$  and show  $u_{\text{lhs}} \in (D^\uparrow \wedge (c \sim n))^\uparrow \wedge (c \sim n)$ . Since we consider  $\mathbb{T} \in \{\mathbb{N}^{\geq 0}, \mathbb{R}^{\geq 0}\}$ , we assume  $0 \in \mathbb{T}$ . By the precondition, we know

$$\begin{aligned}
&u_{\text{lhs}} \in D^\uparrow \wedge (c \sim n) \\
\Rightarrow &u_{\text{lhs}} \in (D^\uparrow \wedge (c \sim n)) \wedge u_{\text{lhs}} + 0 \models (c \sim n)
\end{aligned}$$

$$\begin{aligned} &\Rightarrow u_{\text{lhs}} \in \{u + d \mid u \in (D^\dagger \wedge (c \sim n)) \wedge d \in \mathbb{T} \wedge u + d \models (c \sim n)\} \\ &\Rightarrow u_{\text{lhs}} \in (D^\dagger \wedge (c \sim n))^\dagger \wedge (c \sim n) \end{aligned}$$

and the first direction holds. We now show the opposite direction. To do so, we assume any  $u_{\text{rhs}} \in (D^\dagger \wedge (c \sim n))^\dagger \wedge (c \sim n)$  and show  $u_{\text{rhs}} \in D^\dagger \wedge (c \sim n)$ . By the precondition, we know

$$\begin{aligned} &u_{\text{rhs}} \in (D^\dagger \wedge (c \sim n))^\dagger \wedge (c \sim n) \\ \Rightarrow &u_{\text{rhs}} \in \{u + d \mid u \in (D^\dagger \wedge (c \sim n)) \wedge d \in \mathbb{T} \wedge u + d \models (c \sim n)\} \\ \Rightarrow &u_{\text{rhs}} \in \{u + d \mid u \in \{u + d' \mid u \in D \wedge d' \in \mathbb{T} \wedge u + d' \models (c \sim n)\} \wedge d \in \mathbb{T} \wedge u + d \models (c \sim n)\} \\ \Rightarrow &u_{\text{rhs}} \in \{u + d + d' \mid u \in D \wedge d' \in \mathbb{T} \wedge u + d' \models (c \sim n) \wedge d \in \mathbb{T} \wedge u + d + d' \models (c \sim n)\} \\ \Rightarrow &u_{\text{rhs}} \in \{u + d'' \mid u \in D \wedge d'' \in \mathbb{T} \wedge u + d'' \models (c \sim n)\} \\ \Rightarrow &u_{\text{rhs}} \in D^\dagger \wedge (c \sim n) \end{aligned}$$

and the second direction is shown, too. Therefore, Proposition AI.1 holds.  $\square$

We show Proposition 4.3.

**Proof:**

$(l_A, D_\varepsilon) = (l_A, D_{\varepsilon, \varepsilon})$  holds if and only if  $l_A = l_A$  and  $D_\varepsilon = D_{\varepsilon, \varepsilon}$ . Since the first obviously holds, we show only the second. By Definition 2.7 and 3.7, we know  $D_\varepsilon = D^\dagger \wedge I(l_A)$  and  $D_{\varepsilon, \varepsilon} = D_\varepsilon^\dagger \wedge I(l_A)$ . Moreover, since we assume diagonal-free TA, we know that  $I(l_A) = c \sim n$  with  $c \in C$ ,  $\sim \in \{<, \leq, \geq, >\}$ , and  $n \in \mathbb{N}^{\geq 0}$ . Therefore, we are allowed to apply Proposition AI.1. We can follow

$$\begin{aligned} D_\varepsilon &= D^\dagger \wedge I(l_A) \\ &= D^\dagger \wedge (c \sim n) \\ &= (D^\dagger \wedge (c \sim n))^\dagger \wedge (c \sim n) \text{ (Prop. AI.1)} \\ &= D_\varepsilon^\dagger \wedge (c \sim n) \\ &= D_\varepsilon^\dagger \wedge I(l_A) \\ &= D_{\varepsilon, \varepsilon}. \end{aligned}$$

Therefore, Proposition 4.3 holds.  $\square$

## AJ. Check only the Future

In this section, we show a proposition that implies Proposition 4.4. We remind the reader of Definition AE.1.

**Proposition AJ.1. (Check only the Future (Full))**

Assume two TA  $A, B$ , with VCG  $A_{\text{VCG}}$  of  $A$  regarding  $B$ , VCG  $B_{\text{VCG}}$  of  $B$  regarding  $A$ , and the AB-synchronized symbolic states  $(l_A, D_A), (l_B, D_B)$  with  $D_A \equiv_{\text{virtual}} D_B$ . We denote the outgoing

$\varepsilon$ -transitions with  $(l_A, D_A) \xrightarrow{VCG} (l_A, D_{\varepsilon,A})$  and  $(l_B, D_B) \xrightarrow{VCG} (l_B, D_{\varepsilon,B})$ . Moreover, consider any check-for-virt-bisim function  $\text{check}_{A_{VCG}, B_{VCG}}$ . We denote

$$\varepsilon\text{-result} = \text{check}_{A_{VCG}, B_{VCG}}((l_A, D_{\varepsilon,A}), (l_B, D_{\varepsilon,B})).$$

The returned set of virtual constraints of

$$\begin{aligned} & \text{check-}\varepsilon\text{-only}_{A_{VCG}, B_{VCG}}((l_A, D_A), (l_B, D_B)) \\ &= \text{combine}(\text{revert-}\varepsilon\text{-trans}(D_A, D_{\varepsilon,A}, \varepsilon\text{-result} \wedge \text{extract-virtual-constraint}(D_{\varepsilon,A})) \\ & \quad \cdot \text{revert-}\varepsilon\text{-trans}(D_B, D_{\varepsilon,B}, \varepsilon\text{-result} \wedge \text{extract-virtual-constraint}(D_{\varepsilon,B}))) \end{aligned}$$

fulfills all conditions of a check-for-virt-bisim function.

**Proof:**

To show Proposition 4.4, we have to show that the given operator fulfills all conditions of Definition AE.1. We denote the return value of the operator with  $\{\phi_0, \dots, \phi_n\}$ .

1. (Non-Emptiness) Holds trivially by Definition AA.1.
2. (Usefulness) Holds by a combination of Usefulness of the revert- $\varepsilon$ -trans operator (Definition Z.1) and Correctness of the combine operator (Definition AA.1).
3. (Disjointness) Holds trivially by Definition AA.1.
4. (Soundness) We show soundness only for the A-part, since the B-part can be shown analogously. We assume any non-empty zone  $D_{\text{sub},A} \subseteq D_A$  with  $\exists i \in [0, n] : D_{\text{sub},A} \wedge \phi_i \neq \emptyset$  and show that there exists no  $D_{\text{sub},B} \subseteq D_B$  such that  $(l_A, D_{\text{sub},A}) \sim (l_B, D_{\text{sub},B})$  holds. By correctness of the combine operator, we know that  $\exists i \in [0, n] : D_{\text{sub},A} \wedge \phi_i \neq \emptyset$  implies

$$\begin{aligned} & \exists \phi \in \text{revert-}\varepsilon\text{-trans}(D_A, D_{\varepsilon,A}, \varepsilon\text{-result} \wedge \text{extract-virtual-constraint}(D_{\varepsilon,A})) : D_{\text{sub},A} \wedge \phi \neq \emptyset \\ & \vee \exists \phi \in \text{revert-}\varepsilon\text{-trans}(D_B, D_{\varepsilon,B}, \varepsilon\text{-result} \wedge \text{extract-virtual-constraint}(D_{\varepsilon,B})) : D_{\text{sub},A} \wedge \phi \neq \emptyset. \end{aligned}$$

We distinguish these cases.

- (a) In this case, we assume

$$\exists \phi \in \text{revert-}\varepsilon\text{-trans}(D_A, D_{\varepsilon,A}, \varepsilon\text{-result} \wedge \text{extract-virtual-constraint}(D_{\varepsilon,A})) : D_{\text{sub},A} \wedge \phi \neq \emptyset.$$

By Definition Z.1 this implies that there exists an outgoing transition  $(l_A, D_{\text{sub},A}) \xrightarrow{VCG} (l_A, D_{\text{sub},\varepsilon,A})$  such that

$$\exists \phi_\varepsilon \in \varepsilon\text{-result} : D_{\text{sub},\varepsilon,A} \wedge \phi_\varepsilon \neq \emptyset.$$

Since  $D_{\text{sub},\varepsilon,A} \subseteq D_{\varepsilon,A}$ , this implies by Definition AE.1 that there exists no  $D_{\text{sub},\varepsilon,B} \subseteq D_{\varepsilon,B}$  such that  $(l_A, D_{\text{sub},\varepsilon,A}) \sim (l_B, D_{\text{sub},\varepsilon,B})$ . Since for any  $D_{\text{sub},B} \subseteq D_B$  the symbolic state  $(l_B, D_{\text{sub},B})$  has an outgoing transition  $(l_B, D_{\text{sub},B}) \xrightarrow{VCG} (l_B, D_{\text{sub},\varepsilon,B})$  such that  $D_{\text{sub},\varepsilon,B} \subseteq D_{\varepsilon,B}$ , the statement  $(l_A, D_{\text{sub},\varepsilon,A}) \not\sim (l_B, D_{\text{sub},\varepsilon,B})$  holds.

(b) In this case, we assume

$$\exists \phi \in \text{revert-}\varepsilon\text{-trans}(D_B, D_{\varepsilon,B}, \varepsilon\text{-result} \wedge \text{extract-virtual-constraint}(D_{\varepsilon,B})) : D_{\text{sub},A} \wedge \phi \neq \emptyset.$$

We assume any  $D_{\text{sub},B} \subseteq D_B$ . If  $D_{\text{sub},A} \equiv_{\text{virtual}} D_{\text{sub},B}$  does not hold, virtual bisimulation also does not hold by Definition 3.11. Therefore, we assume virtual equivalence to hold. This implies

$$\exists \phi \in \text{revert-}\varepsilon\text{-trans}(D_B, D_{\varepsilon,B}, \varepsilon\text{-result} \wedge \text{extract-virtual-constraint}(D_{\varepsilon,B})) : D_{\text{sub},B} \wedge \phi \neq \emptyset$$

and we can show soundness analogously to the previous case.

5. (Completeness) We show Completeness only for the A-part, since the B-part can be shown analogously. We assume any non-empty zone  $D_{\text{sub},A} \subseteq D_A$  with  $\forall i \in [0, n] : D_{\text{sub},A} \wedge \phi_i = \emptyset$  and have to show that there exists a zone  $D_{\text{sub},B} \subseteq D_B$  with  $\forall i \in [0, n] : D_{\text{sub},B} \wedge \phi_i = \emptyset$  such that  $(l_A, D_{\text{sub},A}) \sim (l_B, D_{\text{sub},B})$ . We denote the outgoing  $\varepsilon$ -transition of  $D_{\text{sub},A}$  with  $D_{\text{sub},A} \xrightarrow[VCG]{\varepsilon} D_{\text{sub},\varepsilon,A}$ . By correctness of the combine operator, we know that  $\forall i \in [0, n] : D_{\text{sub},A} \wedge \phi_i = \emptyset$  implies

$$\begin{aligned} & \forall \phi \in \text{revert-}\varepsilon\text{-trans}(D_A, D_{\varepsilon,A}, \varepsilon\text{-result} \wedge \text{extract-virtual-constraint}(D_{\varepsilon,A})) : D_{\text{sub},A} \wedge \phi \neq \emptyset \\ & \wedge \forall \phi \in \text{revert-}\varepsilon\text{-trans}(D_B, D_{\varepsilon,B}, \varepsilon\text{-result} \wedge \text{extract-virtual-constraint}(D_{\varepsilon,B})) : D_{\text{sub},A} \wedge \phi \neq \emptyset. \end{aligned}$$

Since we know by Definition AE.1 that all virtual constraints of  $\varepsilon$ -result have as solution set a subset of the union of the solution sets of the virtual constraints of  $D_A$  and  $D_B$ , this implies by Completeness of the revert- $\varepsilon$ -trans operator,

$$\forall \phi \in \varepsilon\text{-result} : D_{\text{sub},\varepsilon,A} \wedge \phi = \emptyset.$$

Since check is a check-for-virt-bisim function, this implies by Completeness that there exists a zone  $D_{\text{sub},\varepsilon,B} \subseteq D_{\varepsilon,B}$ , such that  $(l_A, D_{\text{sub},\varepsilon,A}) \sim (l_B, D_{\text{sub},\varepsilon,B})$ . We remind the reader of  $D_{\text{sub},A} \subseteq D_{\text{sub},\varepsilon,A}$ , which implies

$$\forall \phi \in \varepsilon\text{-result} : D_{\text{sub},A} \wedge \phi = \emptyset.$$

Therefore, there exists a  $D_{\text{sub},\varepsilon,B} \subseteq D_{\varepsilon,B}$  such that  $(l_A, D_{\text{sub},A}) \sim (l_B, D_{\text{sub},\varepsilon,B})$ . By Definition 3.11, this implies  $D_{\text{sub},A} \equiv_{\text{virtual}} D_{\text{sub},\varepsilon,B}$ . Due to  $D_{\text{sub},A} \subseteq D_A$ , the assumption  $D_A \equiv_{\text{virtual}} D_B$ , and Corollary P.1, the statement  $D_{\text{sub},\varepsilon,B} \subseteq D_B$  is implied and Completeness holds.  $\square$

Proposition AJ.1 implies Proposition 4.4 by Definition AA.1.

## AK. Implementing check-for-virt-bisim

For  $n \rightarrow \infty$ , a check-for-virt-bisim-in-order function is obviously a check-for-virt-bisim function (if it terminates). Since CHECK-FOR-VIRT-BISIM-IN-ORDER-IMPL of Algorithm 4.1 is a check-for-virt-bisim-in-order function by Proposition AH.1, we only have to set  $n \rightarrow \infty$  and show termination to have a first version of our check-for-virt-bisim function. The result can be seen in Algorithm AK.1.

**Algorithm AK.1** CHECK-FOR-VIRT-BISIM-IMPL-INF-N function

---

▷ Let  $(l_A, D_A), (l_B, D_B)$  be AB-semi-synchronized symbolic states,  
 ▷  $k : C_A \cup C_B \cup \{\chi_0, \dots, \chi_{|C_A|+|C_B|-1}\} \rightarrow \mathbb{N}^{\geq 0}$ , and visited be a set.  
 ▷ The return value of CHECK-FOR-VIRT-BISIM-IMPL-INF-N is a set of virtual constraints.

```

1: function CHECK-FOR-VIRT-BISIM-IMPL-INF- $N_{AVCG, BVCG, k, visited}((l_A, D_A), (l_B, D_B))$ 
2:   if  $\neg(D_A \equiv_{\text{virtual}} D_B)$  then
3:     return  $\text{extract-virtual-constraint}(D_A) \wedge \neg \text{extract-virtual-constraint}(D_B) \cup$ 
4:        $\text{extract-virtual-constraint}(D_B) \wedge \neg \text{extract-virtual-constraint}(D_A)$ 
5:   end if
6:
7:    $((l_A, D_{e,A}), (l_B, D_{e,B})) \leftarrow \text{sync}((l_A, D_A), (l_B, D_B))$ 
8:
9:    $(l_A, D_{\text{norm},A}) \leftarrow (l_A, \text{norm}(D_{e,A}, k))$ 
10:   $(l_B, D_{\text{norm},B}) \leftarrow (l_B, \text{norm}(D_{e,B}, k))$ 
11:  if  $((l_A, D_{\text{norm},A}), (l_B, D_{\text{norm},B})) \in \text{visited}$  then
12:    return  $\emptyset$ 
13:  end if
14:   $\text{new-visited} \leftarrow \text{visited} \cup \{(l_A, D_{\text{norm},A}), (l_B, D_{\text{norm},B})\}$ 
15:
16:   $\text{FUNC} = \text{CHECK-FOR-VIRT-BISIM-IMPL-INF-}N_{AVCG, BVCG, k, \text{new-visited}}$ 
17:
18:  ▷ Assume  $(l_A, D_{e,A}) \xrightarrow{VCG} (l_A, D_{\varepsilon,A})$  and  $(l_B, D_{e,B}) \xrightarrow{VCG} (l_B, D_{\varepsilon,B})$ .
19:   $\varepsilon\text{-result} \leftarrow \text{FUNC}((l_A, D_{\varepsilon,A}), (l_B, D_{\varepsilon,B}))$ 
20:   $\text{sync-cond} \leftarrow \text{revert-}\varepsilon\text{-trans}(D_{e,A}, D_{\varepsilon,A}, \varepsilon\text{-result} \wedge \text{extract-virtual-constraint}(D_{\varepsilon,A}))$ 
21:     $\cup \text{revert-}\varepsilon\text{-trans}(D_{e,B}, D_{\varepsilon,B}, \varepsilon\text{-result} \wedge \text{extract-virtual-constraint}(D_{\varepsilon,B}))$ 
22:  if  $(\text{sync-cond} \neq \emptyset)$  then return  $\text{revert-sync}((l_A, D_A), (l_B, D_B), \text{sync-cond})$ 
23:
24:  for all  $\sigma \in \Sigma$  do
25:    ▷  $\text{out-trans}(\sigma, (l, D))$  is the set of all outgoing transitions of  $(l, D)$  labeled with  $\sigma$ .
26:     $\text{sync-cond} \leftarrow \text{CHECK-OUTGOING-TRANSITIONS-IMPL}_{AVCG, BVCG, \text{FUNC}}(D_{e,A}, D_{e,B},$ 
27:       $\text{out-trans}(\sigma, (l_A, D_{e,A})), \text{out-trans}(\sigma, (l_B, D_{e,B})))$ 
28:    if  $(\text{sync-cond} \neq \emptyset)$  then return  $\text{revert-sync}((l_A, D_A), (l_B, D_B), \text{sync-cond})$ 
29:  end for
30:  return  $\emptyset$ 
31: end function

```

---

**Corollary AK.1. (CHECK-FOR-VIRT-BISIM-IMPL-INF-N is Correct)**

Assume two TA  $A, B$ , using the sets of clocks  $C_A, C_B$ , the AB-semi-synchronized symbolic states  $(l_A, D_A)$  of the VCG  $A_{\text{VCG}}$  of  $A$  regarding  $B$  and  $(l_B, D_B)$  of the VCG  $B_{\text{VCG}}$  of  $B$  regarding  $A$ . Moreover, let  $\text{visited}$  be a set of pairs of symbolic states and  $k : C_A \cup C_B \cup \{\chi_0, \dots, \chi_{|C_A|+|C_B|-1}\} \rightarrow \mathbb{N}^{\geq 0}$  be a function, such that for any clock constraint  $c \sim p$ , which occurs in  $A$  or  $B$ ,  $p < k(c)$ , for any  $i \in [0, |C_A| - 1] : k(C_A[i]) = k(\chi_i)$ , and for any  $i \in [0, |C_B| - 1] : k(C_B[i]) = k(\chi_{i+|C_A|})$  hold.  $\text{CHECK-FOR-VIRT-BISIM-IMPL-INF-N}_{A_{\text{VCG}}, B_{\text{VCG}}, k, \text{visited}}$  is a check-for-virt-bisim function.

**Proof:**

By Definition AE.1 and Proposition AH.1, we only have to show that  $\text{CHECK-FOR-VIRT-BISIM-IMPL-INF-N}$  terminates. This is the case since  $\text{visited}$  becomes larger each time a recursive call happens, and the number of normalized pairs of symbolic states is finite by Proposition 2.3.  $\square$

$\text{CHECK-FOR-VIRT-BISIM-IMPL-INF-N}$  suffers from the exponential behavior of zone graphs (see Example 2.7). Therefore, we use Proposition 4.3 and 4.4 to improve the behavior. The result can be seen in Algorithm AK.2.

**Corollary AK.2. (CHECK-FOR-VIRT-BISIM-IMPL-NO-EXP is Correct)**

Assume two TA  $A, B$ , using the sets of clocks  $C_A, C_B$ , the AB-semi-synchronized symbolic states  $(l_A, D_A)$  of the VCG  $A_{\text{VCG}}$  of  $A$  regarding  $B$  and  $(l_B, D_B)$  of the VCG  $B_{\text{VCG}}$  of  $B$  regarding  $A$ . Moreover, let  $\text{visited}$  be a set of pairs of symbolic states and  $k : C_A \cup C_B \cup \{\chi_0, \dots, \chi_{|C_A|+|C_B|-1}\} \rightarrow \mathbb{N}^{\geq 0}$  be a function, such that for any clock constraint  $c \sim p$ , which occurs in  $A$  or  $B$ ,  $p < k(c)$ , for any  $i \in [0, |C_A| - 1] : k(C_A[i]) = k(\chi_i)$ , and for any  $i \in [0, |C_B| - 1] : k(C_B[i]) = k(\chi_{i+|C_A|})$  hold.  $\text{CHECK-FOR-VIRT-BISIM-IMPL-NO-EXP}_{A_{\text{VCG}}, B_{\text{VCG}}, k, \text{visited}}$  is a check-for-virt-bisim function.

**Proof:**

By Corollary AK.1 and Proposition AJ.1, we only have to show that  $\text{CHECK-FOR-VIRT-BISIM-IMPL-NO-EXP}$  terminates. This is the case since  $\text{visited}$  becomes larger each time a recursive call happens and the synchronized symbolic states are equivalent to the targets of the  $\varepsilon$ -transitions, which is the case in at least every second recursive step by Proposition 3.8, 3.9, and 4.3, and the number of normalized pairs of symbolic states is finite by Proposition 2.3.  $\square$

Between  $\text{CHECK-FOR-VIRT-BISIM-IMPL-NO-EXP}$  and  $\text{CHECK-FOR-VIRT-BISIM-IMPL}$  of Algorithm 4.4 are two differences. One the one hand, the combine operator inside the second if is missing and the check for the outgoing  $\varepsilon$ -transitions after the third if statement is missing. We can show that both statements do not change the overall results regarding the conditions of a check-for-virt-bisim function.

**Theorem AK.1. (CHECK-FOR-VIRT-BISIM-IMPL is Correct)**

Assume two TA  $A, B$ , using the sets of clocks  $C_A, C_B$ , the AB-semi-synchronized symbolic states  $(l_A, D_A)$  of the VCG  $A_{\text{VCG}}$  of  $A$  regarding  $B$  and  $(l_B, D_B)$  of the VCG  $B_{\text{VCG}}$  of  $B$  regarding  $A$ . Moreover, let  $\text{visited}$  be a set of pairs of symbolic states and  $k : C_A \cup C_B \cup \{\chi_0, \dots, \chi_{|C_A|+|C_B|-1}\} \rightarrow \mathbb{N}^{\geq 0}$  be a function, such that for any clock constraint  $c \sim p$ , which occurs in  $A$  or  $B$ ,  $p < k(c)$ , for any  $i \in [0, |C_A| - 1] : k(C_A[i]) = k(\chi_i)$ , and for any  $i \in [0, |C_B| - 1] : k(C_B[i]) = k(\chi_{i+|C_A|})$  hold.  $\text{CHECK-FOR-VIRT-BISIM-IMPL}_{A_{\text{VCG}}, B_{\text{VCG}}, k, \text{visited}}$  is a check-for-virt-bisim function.



**Algorithm AK.2** CHECK-FOR-VIRT-BISIM-IMPL-NON-EXP function

---

▷ Let  $(l_A, D_A), (l_B, D_B)$  be AB-semi-synchronized symbolic states,  
 ▷  $k : C_A \cup C_B \cup \{\chi_0, \dots, \chi_{|C_A|+|C_B|-1}\} \rightarrow \mathbb{N}^{\geq 0}$ , and visited be a set.  
 ▷ The return value of CHECK-FOR-VIRT-BISIM-IMPL-NON-EXP is a set of virtual constraints.

```

1: function CHECK-FOR-VIRT-BISIM-IMPL-NON-EXPAVCG,BVCG,k,visited((lA, DA), (lB, DB))
2:   if  $\neg(D_A \equiv_{\text{virtual}} D_B)$  then
3:     return extract-virtual-constraint(DA)  $\wedge$   $\neg$  extract-virtual-constraint(DB)  $\cup$ 
4:       extract-virtual-constraint(DB)  $\wedge$   $\neg$  extract-virtual-constraint(DA)
5:   end if
6:
7:   ((lA, De,A), (lB, De,B))  $\leftarrow$  sync((lA, DA), (lB, DB))
8:
9:   ▷ Assume  $(l_A, D_{e,A}) \xrightarrow[VCG]{\varepsilon} (l_A, D_{\varepsilon,A})$  and  $(l_B, D_{e,B}) \xrightarrow[VCG]{\varepsilon} (l_B, D_{\varepsilon,B})$ .
10:  if  $(D_{e,A}, D_{e,B}) \neq (D_{\varepsilon,A}, D_{\varepsilon,B})$  then
11:     $\varepsilon$ -result  $\leftarrow$ 
12:      CHECK-FOR-VIRT-BISIM-IMPL-NON-EXPAVCG,BVCG,k,visited((lA, Dε,A), (lB, Dε,B))
13:    contra  $\leftarrow$  combine(revert- $\varepsilon$ -trans(De,A, Dε,A,  $\varepsilon$ -result  $\wedge$  extract-virtual-constraint(Dε,A))
14:      · revert- $\varepsilon$ -trans(De,B, Dε,B,  $\varepsilon$ -result  $\wedge$  extract-virtual-constraint(Dε,B)))
15:    return revert-sync((lA, DA), (lB, DB), contra)
16:  end if
17:
18:  (lA, Dnorm,A)  $\leftarrow$  (lA, norm(De,A, k))
19:  (lB, Dnorm,B)  $\leftarrow$  (lB, norm(De,B, k))
20:  if (((lA, Dnorm,A), (lB, Dnorm,B))  $\in$  visited) then
21:    return  $\emptyset$ 
22:  end if
23:  new-visited  $\leftarrow$  visited  $\cup$  {((lA, Dnorm,A), (lB, Dnorm,B))}
24:  FUNC = CHECK-FOR-VIRT-BISIM-IMPL-INF-NAVCG,BVCG,k,new-visited
25:
26:   $\varepsilon$ -result  $\leftarrow$  FUNC((lA, Dε,A), (lB, Dε,B))
27:  sync-cond  $\leftarrow$  revert- $\varepsilon$ -trans(De,A, Dε,A,  $\varepsilon$ -result  $\wedge$  extract-virtual-constraint(Dε,A))
28:     $\cup$  revert- $\varepsilon$ -trans(De,B, Dε,B,  $\varepsilon$ -result  $\wedge$  extract-virtual-constraint(Dε,B))
29:  if (sync-cond  $\neq$   $\emptyset$ ) then return revert-sync((lA, DA), (lB, DB), sync-cond)
30:
31:  for all  $\sigma \in \Sigma$  do
32:    ▷ out-trans( $\sigma, (l, D)$ ) is the set of all outgoing transitions of  $(l, D)$  labeled with  $\sigma$ .
33:    sync-cond  $\leftarrow$  CHECK-OUTGOING-TRANSITIONS-IMPLAVCG,BVCG,FUNC(De,A, De,B,
34:      out-trans( $\sigma, (l_A, D_{e,A})$ ), out-trans( $\sigma, (l_B, D_{e,B})$ ))
35:    if (sync-cond  $\neq$   $\emptyset$ ) then return revert-sync((lA, DA), (lB, DB), sync-cond)
36:  end for
37:  return  $\emptyset$ 
38: end function
  
```

---

**Proof:**

We start with the difference regarding the combine operator. In this case,  $(D_{e,A}, D_{e,B}) \neq (D_{\varepsilon,A}, D_{\varepsilon,B})$  holds. We denote

$$\{\phi_0, \dots, \phi_n\} = \text{revert-sync}((l_A, D_A), (l_B, D_B), \text{contra}).$$

We show one statement of Definition AE.1 after the other.

1. Non-Emptiness trivially holds by Definition AB.1.
2. Usefulness trivially holds by Definition AB.1.
3. Disjointness trivially holds by Definition AB.1.
4. By Soundness of the revert-sync operator, we know that for any non-empty zone  $D_{\text{sub},A} \subseteq D_A$ ,  $\exists \phi_i \in \{\phi_0, \dots, \phi_n\} : D_{\text{sub},A} \neq \emptyset$  holds implies that for the corresponding synchronized symbolic state  $(l_A, D_{\text{sub},e,A})$  the statement  $\exists \phi_{i,e} \in \text{contra} : D_{\text{sub},e,A} \wedge \phi_{i,e} \neq \emptyset$  holds. By Correctness of the combine operator, this is the case if and only if  $\exists \phi_{i,e} \in \text{combine}(\text{contra}) : D_{\text{sub},e,A} \wedge \phi_{i,e} \neq \emptyset$  holds, which implies Soundness by Proposition AJ.1.
5. Analogously to Soundness.

The second difference regards the missing check of the outgoing  $\varepsilon$ -transition. Obviously, this part of the algorithm changes the output of the algorithm if  $\text{FUNC}((l_A, D_{\varepsilon,A}), (l_B, D_{\varepsilon,B}))$  returns not the empty set. Therefore, to show that we are allowed to remove this part of the algorithm, we have to show that  $\text{FUNC}((l_A, D_{\varepsilon,A}), (l_B, D_{\varepsilon,B}))$  always returns the empty set.

The missing part can only be reached if  $(D_{e,A}, D_{e,B}) = (D_{\varepsilon,A}, D_{\varepsilon,B})$  holds. In this case we know that  $((l_A, \text{norm}(D_{\varepsilon,A}), (l_B, \text{norm}(D_{\varepsilon,B})))$  is element of new-visited. Due to Proposition 3.9 and since we already know that  $(D_{e,A}, D_{e,B}) = (D_{\varepsilon,A}, D_{\varepsilon,B})$  holds, which implies the same for the next  $\varepsilon$ -transition, we reach the third if-statement in which we check whether  $(l_A, \text{norm}(D_{\varepsilon,A}), (l_B, \text{norm}(D_{\varepsilon,B})))$  is element of new-visited. Since we know that this is the case, the empty set is returned.

Therefore,  $\text{FUNC}((l_A, D_{\varepsilon,A}), (l_B, D_{\varepsilon,B}))$  always returns the empty set and we are allowed to remove this part without changing the output.

Therefore, Corollary AK.2 implies this theorem. □