

The Analytic Arc Cover Problem and its Applications to Contiguous Art Gallery, Polygon Separation, and Shape Carving

Eliot W. Robson ✉ 

Department of Computer Science, University of Illinois Urbana-Champaign

Jack Spalding-Jamieson ✉ 

Independent

Da Wei Zheng ✉ 

Department of Computer Science, University of Illinois Urbana-Champaign

Abstract

We show the following problems are in P:

1. The contiguous art gallery problem – a variation of the art gallery problem where each guard can protect a contiguous interval along the boundary of a simple polygon. This was posed at the open problem session at CCCG '24 by Thomas C. Shermer.
2. The polygon separation problem for line segments – For two sets of line segments S_1 and S_2 , find a minimum-vertex convex polygon P that completely contains S_1 and does not contain or cross any segment of S_2 .
3. Minimizing the number of half-plane cuts to carve a 3D polytope.

To accomplish this, we study the *analytic arc cover problem* – an interval set cover problem over the unit circle with infinitely many implicitly-defined arcs, given by a function.

2012 ACM Subject Classification Theory of computation → Computational geometry

Keywords and phrases Art gallery, polygon separation, arc cover, 3D carving, interval set cover

Funding *Da Wei Zheng*: Research supported in part by an NSERC PGSD.

Acknowledgements Thanks to Thomas C. Shermer for proposing the contiguous art gallery problem at the open problem session at the Canadian Conference on Computational Geometry 2024 (CCCG24) at Brock University, Canada, and for fruitful discussions at the conference.

1 Introduction

Many classic problems in computational geometry are minimum covering problems. One class of examples are art gallery problems [18, 24, 27, 19] which asks for the a minimum number star-shaped polygons that cover a given polygon. Each star-shaped polygon describes a region that can be seen by a single guard. Some variants of art gallery allow guards to be placed anywhere, while others only allow guards to be placed at a finite set of points (such as vertices of a polygon). Many variants of the former type are $\exists\mathbb{R}$ -complete, while variants of the latter type are almost universally in NP, and are often in P. This distinction is not surprising: When there are infinitely many choices for the covering sets it is often not clear if the problem is even in NP.

In this work, we study three problems with no immediate proofs that they are in any complexity class smaller than $\exists\mathbb{R}$. The first problem is a variant of the art gallery problem with a restriction that each guard can only be responsible for a contiguous region. The other two problems relate to separation. We will show that each of these problems can be reduced to a problem call the *analytic arc cover problem*. We establish machinery for dealing with some “well-behaved” infinite classes of possible covering sets, allowing us to show all three of our problems are in P.

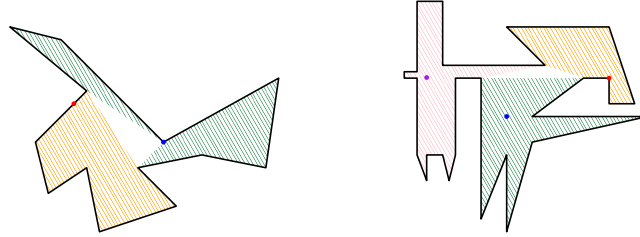

■ **Figure 1** Some examples of `CONTIGUOUSARTGALLERY`, with optimal solutions. On the right, it is necessary to place a guard at a non-vertex point.

1.1 Art Gallery Problem

Given a simple polygon P and points $x, y \in P$, a guard standing at x sees the point y if the line segment xy is contained in P . A set S of points is said to *guard* the polygon P if every point of P can be seen by some guard. Minimizing the cardinality of S is known as the `ARTGALLERY` problem¹, and is a very well-studied problem in computational geometry (See one of the numerous surveys dedicated to the problem [18, 24, 27, 19]). This problem was first formulated by Victor Klee in 1976 (see O’Rourke [18]). Many variations have been studied since then, such as when the guards are restricted to the boundary or the vertices of the polygon. There are other variants like the `BOUNDARYARTGALLERY` problem where guards are allowed to be anywhere but only the boundary of P needs to be guarded.

All of the aforementioned variants were shown to be NP-hard [3, 16, 15]. It can be seen that variants that allow for guards in the interior may not even be in NP, since it was shown that an optimal solution to `ARTGALLERY` may need guards at irrational points [1]. Further evidence towards this was recently given by Abrahamsen, Adamaszek, and Miltzow [2], who showed that Victor Klee’s original formulation is $\exists\mathbb{R}$ -complete. Subsequent work by Stade [25] shows that many of the variants of art gallery are also $\exists\mathbb{R}$ -complete.

One salient feature of many of the hardness proofs for `ARTGALLERY` and its variations is that a single guard may be responsible for disjoint regions of the polygon, even with respect to guarding just the boundary of P . In contrast, we can consider the `CONTIGUOUSARTGALLERY` problem – a variation of the `BOUNDARYARTGALLERY` problem where each guard can only be responsible for a contiguous section of the boundary, see Figure 1. This problem was described by Thomas C. Shermer at the CCCG ’24 open problem session, where he asked the following question:

*Is the guarding of disjoint regions necessary for the hardness proofs of `ARTGALLERY` and variations like `BOUNDARYARTGALLERY`?
What is the complexity of `CONTIGUOUSARTGALLERY`? Is it even in NP?*

1.2 Minimum Polygon Separation

Given a convex polygon P that is contained inside another convex polygon Q , the minimum polygon separation problem asks for the polygon S with the minimum number of vertices such that S contains P and is contained within Q . We denote this problem as `POLYGONSEPARATION`. `POLYGONSEPARATION` was first studied by Aggarwal, Booth,

¹ Throughout this paper, we will abuse notation and refer to problems like `ARTGALLERY` as both the optimization variant to minimize the set of guards, as well as the decision variant, where we wish to decide if k guards are sufficient.

O'Rourke, Suri, and Yap [4], who also showed that any minimal S is convex. This problem is related to the problem of finding a convex polygon with the minimum number of sides that separates two sets of points S_1 with S_2 that was studied by Edelsbrunner and Preparata [11]. We denote this problem as POINTSEPARATION.

One feature of the algorithm of [4] is that they work in the real RAM model of computation [23], where it is assumed that elementary operations (like $+$, $-$, \times , and \div) can be performed in $O(1)$ time on real numbers. However, the algorithm they present involves iteratively composing many functions together, and ultimately solving an equation. While [4] claim that their algorithm runs in $O(n \log n)$ time when the input consists of n points, it is unclear what the runtime of the algorithm is in other models of computation (e.g. in a Turing Machine model where inputs are points with rational coordinates). This is because their algorithm may compose $O(n)$ different functions, leading to a function with very high bit complexity, while [4] assume an equation with such a function can be solved in $O(1)$ time.

One can also consider another similar problem: The problem of separating two collections of line segments by a convex polygon with the minimum number of sides. We call this problem SEGMENTSEPARATION. It can be seen that SEGMENTSEPARATION generalizes the problem of POLYGONSEPARATION when we wish to separate the edges of outer polygon with the inner polygon. Furthermore, the POINTSEPARATION problem is a special case of SEGMENTSEPARATION when all segments are of zero length. To the best of our knowledge, SEGMENTSEPARATION has not been studied before, and the algorithms of [4] and [11] do not immediately work for this problem.

Moreover, while the problems POLYGONSEPARATION and POINTSEPARATION were implicitly shown to be in \mathbf{P} using the algorithms of [4] and [11] respectively (with a larger time complexity in the Turing Machine model of computation rather than the real RAM models used in those papers), the same techniques do not immediately apply to SEGMENTSEPARATION, so it is not immediately clear that SEGMENTSEPARATION is in \mathbf{NP} .

1.3 Polytope Carving

Related to POLYGONSEPARATION is the problem of *carving* one shape out of another. One could also carve a shape out of an arbitrary containing shape, which is equivalent to asking for a set of cuts separating the shape from the ambient space. Two-dimensional carving was first studied by Overmars and Welzl [20], where they aimed to find the cheapest sequence of line cuts to carve out a convex polygon out of a piece of flat material. It has also been studied in the context of rays cuts [7, 26] and line segments cuts [8, 10].

Three dimensional versions of carving have also been studied in the form of plane cuts [5], line cuts [14], half-plane cuts [22], and “sweeping” ray cuts [22]. The work of Robson, Spalding-Jamieson and Zheng [22] on half-plane cuts left open the question of computing the minimum number of half-plane cuts needed to carve out a specified 3D polytope from the ambient space of \mathbb{R}^3 .

1.4 Our Contribution

We answer the question posed by Thomas C. Sherman with the following theorem, showing that adding contiguity constraints for BOUNDARYARTGALLERY makes the problem significantly simpler. We also show that SEGMENTSEPARATION is in \mathbf{P} .

► **Theorem 1.** *CONTIGUOUSARTGALLERY is in \mathbf{P} .*

► **Theorem 2.** *SEGMENTSEPARATION is in \mathbf{P} .*

We show that a question about minimizing the number of half-plane cuts to carve a 3D polytope, reduces to multiple instances of `SEGMENTSEPARATION`. By the theorem above, we can conclude that finding the minimum cuts to carve a polytope is also in P .

► **Theorem 3.** *Minimizing the number of half-plane cuts to carve a 3D polytope is in P .*

To prove our results, we reduce both `SEGMENTSEPARATION` and `CONTIGUOUSARTGALLERY` to a problem we call `ANALYTICARCCOVER`. This problem is a version of the interval cover problem on a circle with infinite number of intervals. Each interval is described by the counterclockwise segment between two points a and b on the circle S^1 . We denote this as an half-open interval $[a, b)$, containing a , and not containing b , and call this an **arc**. This infinite set of intervals is given implicitly as a function, as can be seen in the following definition.

► **Definition 4.** *Let $g : S^1 \rightarrow S^1$ be a function that maps points on the unit circle S^1 to other points on the unit circle S^1 . `ANALYTICARCCOVER` asks: given g , find the minimum set $X \subset S^1$ such that the set of counter-clockwise arcs $\{[x, g(x)) : x \in X\}$ covers S^1 .*

We show that `CONTIGUOUSARTGALLERY` reduces to `ANALYTICARCCOVER` with piecewise linear-rational functions, and `SEGMENTSEPARATION` reduces to `ANALYTICARCCOVER` with a two dimensional analogue. We crucially use the fact that a compositions of two linear rational functions yields another linear rational function.

1.5 Concurrent work

Concurrent work by Merrill, Rysgaard, Schou, and Svenning [17] also investigate the `CONTIGUOUSARTGALLERY` problem and give a polynomial time algorithm in the real RAM model of computation but do not bound the bit complexity of the intermediate numbers produced by the algorithm. To contrast, in our work, we give a framework for solving a larger class of problems in polynomial time on a Turing machine, including the `CONTIGUOUSARTGALLERY` problem.

1.6 Organization

The remainder of this paper is organized as follows. In Section 2, we formally define and then solve the `ANALYTICARCCOVER` problem. In Section 3, we reduce the `CONTIGUOUSARTGALLERY` problem to the `ANALYTICARCCOVER` problem, proving Theorem 1. Similarly, in Section 4, we reduce the `SEGMENTSEPARATION` problem to the `ANALYTICARCCOVER` problem, proving Theorem 2. Finally, in Section 5, we prove Theorem 3 via a reduction to `SEGMENTSEPARATION`, leveraging Theorem 2.

2 The Analytic Arc Cover Problem

Throughout the paper we will work with S_1 the unit circle centered at the origin. For points a, b in S_1 , we will use the notation $[a, b)$ to denote the half-open counter-clockwise arc from a to b that includes a but does not include b (the choice of orientation is arbitrary).

2.1 Warmup

We begin with a definition of the interval cover and arc cover problems.

► **Definition 5.** *Let \mathcal{I} be a set of n half-open intervals of the form $[a, b)$ covering the unit interval $[0, 1)$. The `INTERVALCOVER` problem asks for the minimum subset of intervals $I \subset \mathcal{I}$ that can cover $[0, 1)$.*

► **Definition 6.** Let \mathcal{I} be a set of n half-open arcs covering the unit circle S^1 . The **ARCCOVER** problem asks for the minimum subset of arcs $I \subset \mathcal{I}$ that can cover S^1 .

While the set cover problem is NP-Hard [12], the interval set cover problem and the arc cover problem are each solvable in $O(n \log n)$ time [6, 13]. In particular, there is a folklore greedy algorithm for **INTERVALCOVER** that repeatedly looks for the leftmost uncovered point p , and finds the interval $[a, b)$ that covers p and has the maximum value of b . This same algorithm can be applied to **ARCCOVER** if one fixes a branch cut (i.e., starting point), although it only achieves an additive approximation:

► **Lemma 7.** Let \mathcal{I} be an instance of **ARCCOVER** where the minimum arc cover has size k . Fixing a point $p \in S^1$ and running the greedy algorithm counter-clockwise from p yields a solution with at most $k + 1$ intervals.

Proof. Let I_1, \dots, I_k be an optimal solution to the arc cover problem with $p \in I_1$. Let I'_1, \dots, I'_ℓ be the solution found by the greedy algorithm starting at p . Observe that by the greedy algorithm has the counter-clockwise point of I'_j farther than the counter-clockwise point of I_j . Taking the interval I_1 along with I'_1, \dots, I'_k would cover all of S^1 . Thus $\ell \leq k + 1$. ◀

2.2 Formulating the Analytic Arc Cover Problem

In this section we will generalize **ARCCOVER** to carefully chosen settings where the set of arcs \mathcal{I} can be infinite. Given a set of (possibly infinite) arcs \mathcal{I} , we can define the **next-generator** $g : S^1 \rightarrow S^1$ that takes as input a point $t \in S^1$ computes the “farthest” interval that covers t with respect to the branch cut at a :

$$g(t) = \sup\{b \mid [a, b) \in \mathcal{I} \text{ and } t \in [a, b)\}$$

For simplicity and to avoid pathological examples, in this paper we will always assume that \mathcal{I} has the property that for every t , there is some interval that contains $[t, g(t))$. That is, the sup can be replaced with a max. This can be thought of as analogous to a completeness property in analysis.

The core problem we address is what we call the **ANALYTICARCCOVER** problem. In its most general form, the problem is as follows:

► **Definition 8.** Let \mathcal{I} be a set of (possibly infinite) half-open arcs covering the unit circle S^1 with a next-generator g . The **ANALYTICARCCOVER** problem asks for the minimum integer k for which there exists an x where:

$$[x, g(x)) \cup [g(x), g(g(x))) \cup \dots \cup [g^{(k-1)}(x), g^{(k)}(x)) = S^1.$$

This definition coincides with solving **ARCCOVER** using the (possibly infinite) set of intervals \mathcal{I} . To actually discuss algorithms for this problem, it will be helpful to work in a particular space homeomorphic to \mathbb{R} , rather than S^1 . Our space of choice is $\mathbb{Z} \times S^1$, equipped with a canonical branch cut (i.e. the positive x axis). This space has a natural ordering, lexicographical with counterclockwise ordering relative to the branch cut. A next-generator function $g : S^1 \rightarrow S^1$ can be **lifted** to a function $\tilde{g} : \mathbb{Z} \times S^1 \rightarrow \mathbb{Z} \times S^1$ so that $\tilde{g}(z, x) = (z + 1, g(x))$ if $[x, g(x))$ contains the branch cut point, and $\tilde{g}(z, x) = (z, g(x))$ otherwise. We call \tilde{g} the **lifted next-generator**. See Figure 2 for a visualization.

Observe a next-generator g has the property that for any $t_1, t_2 \in S^1$ where $t_2 \in [t_1, g(t_1))$, then $g(t_2) \notin [t_1, g(t_1))$. The lifted next-generator \tilde{g} is in fact monotonic with our choice of lexicographical ordering on $\mathbb{Z} \times S^1$. Furthermore, the lifted next-generator has the feature that

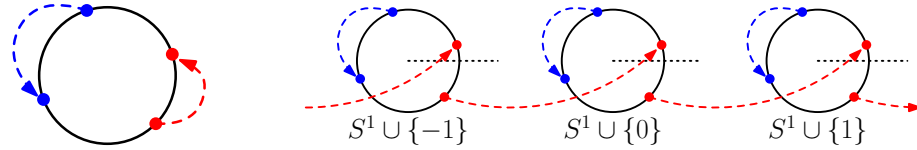

■ **Figure 2** Two mappings of a next-generator and the same mappings in the lifted next-generator.

$\tilde{g}(z, x) \leq (z + 1, x)$. We call functions from $\mathbb{Z} \times S^1 \rightarrow \mathbb{Z} \times S^1$ that have this property **proper functions**.

In our applications, rather than directly working with the infinite set \mathcal{I} , we will be able to compute a compact representation of the next-generator, which will also induce a straightforward representation of the lifted next-generator. The possible forms of the next-generator function can be quite varied. Typically, one would want an oracle to evaluate the next-generator function, although in our case that would only allow us to get an additive $+1$ approximation to the optimal solution. Instead, we will require that our lifted next-generator function comes from a family of functions \mathcal{F} with the following properties:

1. \mathcal{F} is closed under composition.
2. One can perform an **existential threshold test**: For a function $f \in \mathcal{F}$, one can check if there exists $x \in S^1$ such that $f(0, x) \geq (1, x)$ (as points on $\mathbb{Z} \times S^1$), and output a representation of that point as a witness. In other words, we can test if f is a proper function.

We will call such a function family **strongly computable**, although we note that this is not a generalization of a function family with an evaluation oracle.

► **Theorem 9.** *Let \mathcal{F} be a strongly computable function family, and let $\tilde{g} \in \mathcal{F}$ be a lifted next-generator for some set of intervals \mathcal{I} . Let I^* be a minimum cover of \mathcal{I} of size k . Then ANALYTICARCCOVER on \mathcal{I} can be solved in $k - 1$ function compositions and k existential threshold tests.*

Proof. Let $g^{(i)}$ denote the function \tilde{g} composed with itself i times, so $g^{(i)} = g \circ g^{(i-1)}$. Thus we can compute $g^{(i)}$ for each i via function compositions. For each $g^{(i)}$ we can compute an existential threshold test to determine if there is a solution of size i , and halt if so. This algorithm terminates after $k - 1$ function compositions and k existential threshold tests. ◀

Importantly, note that to use this algorithm, one only needs to provide a representation of \tilde{g} . In the next section, we will show that if g is a piecewise linear rational function, a representation of \tilde{g} follows, and the above algorithm runs in polynomial time.

► **Remark 10.** It is possible to reduce the number of function compositions and existential threshold tests in Theorem 9 from k down to $O(\log k)$ by using repeated doubling to binary search for k . We omit such details as we do not focus on exact runtimes in this paper.

2.3 Representations of the Unit Circle

Since we are dealing with covering problems on the unit circle S^1 , we need to have useful ways of representing points along it. There is one obvious method: Represent points by their angle. Rather than using units of radians or degrees, it suffices to simply represent each angle as an element of the range $[0, 1)$. We will use this in Section 3. We refer to this as the **unit-interval representation**.

The other method we will use in Section 4 is more involved. We start by describing a slightly simpler method: Represent each point in S^1 by the coordinates of its embedding in

\mathbb{R}^2 . This is equivalent to using the two-dimensional real-valued unit vectors as representatives. Although we could use these for Section 4, some of the details would be more involved, so it will make things simpler later to add a bit of extra complexity to the representation. Specifically, we represent each point x in S^1 with *any* of the points in $\mathbb{R}^2 \setminus \{(0, 0)\}$ along the ray from the origin through x in the embedding of S^1 in \mathbb{R}^2 . This representation will greatly aid with the presentation of some computational purposes, since it will allow us to bypass directly representing angles in Section 4. It should be noted that some care will have to be taken to ensure the next-generator functions are well-defined in this form. We refer to this as the **ray representation**, although computationally we will store the rays simply as a point along the ray (since the origin of all rays are identical). The point not necessarily of unit distance from the origin, but rather the rays induce an equivalence relation.

In both cases, the primary computational aspect we need is that any two points along S^1 can be compared in their counter-clockwise order relative to a branch cut (note that a branch cut itself is a point in S^1). This is trivial in the unit-interval representation. In the ray representation, this can be done with a cross product. Importantly, this means that obtaining a lifted next-generator is as simple as performing such a comparison with some canonical branch cut.

2.4 Piecewise Linear Rational Functions

A d -dimensional linear rational function is a function of the form:

$$\bar{x} \mapsto \frac{A\bar{x} + \bar{b}}{C\bar{x} + \bar{d}} \quad \text{for } A, C \in \mathbb{Z}^{d \times d} \text{ and } \bar{b}, \bar{d} \in \mathbb{Z}^d \text{ (division is pointwise).}$$

We will only consider $d \in \{1, 2\}$. As discussed in the previous section, the 2-dimensional representation specifically corresponds to the ray representation, in which case we require that $\bar{b} = \bar{d} = \bar{0}$. The reason for this is simple: this is enough to guarantee that all points along a ray map to points along the same “next” ray.

We will consider **piecewise linear rational functions** that are linear rational functions when the domain is partitioned into several intervals (i.e. arcs along the unit circle). We call the end points of these intervals **boundary points**, which themselves are just points in S^1 in our chosen representation. Note that in the ray representation, boundary points are entire rays (represented by a point along the ray). Since we have the ability to compare ordering relative to a branch cut, there is no fundamental difference between the unit-interval and ray representations.

In this paper, we will use piecewise linear rational functions with rational coefficients of one or two variables in the aforementioned domains, whose boundary points (unlike the coefficients) use values from the field of **first order radical numbers**. That is, numbers of the form $a + \sqrt{c}$, where a, b, c are rationals. Surprisingly, this will not cause any significant difficulties in our constructions, as we will not have higher order radicals. Note that the sum of square roots is a major bottleneck in proving NP-completeness of geometric problems in the Turing machine model of computation [21, 9]. In our case, we will only deal with two square roots at a time (at most one on each side of a comparison), so we avoid this problem.

We defer the details of the following theorem to Section 2.5, where we prove that the algorithm given in Theorem 9 runs in polynomial time:

► **Theorem 11.** *If g is a piecewise linear rational function for either the unit-interval or ray representations of S^1 , the ANALYTICARCCOVER problem can be solved in time polynomial in the size of the optimal solution k , the combined bit-complexity of the end points of the*

pieces and each linear rational function (i.e. polynomial in k and in the bit complexity of the representation of g).

2.5 Details for piecewise linear rational functions

We care about the **bit complexities** of the rational functions whose end points are radicals. We define bit complexity as follows.

► **Definition 12.** *The bit complexity of:*

1. an integer x is the number of bits that it takes to store x , i.e. the bit complexity is $\lceil \log_2 x \rceil$.
2. a linear rational function f is the maximum bit complexity of its coefficients.
3. a rational number is the maximum of the bit complexity of the denominator or numerator.
4. a radical $a + b\sqrt{c}$ is the maximum bit complexity of a , b , and c .

Note that these definitions ensure that the bit complexities of these objects are proportional to the number of bits needed to store them on a Turing machine. Furthermore, they have the following properties whose proofs are straightforward and thus omitted:

► **Lemma 13.** *The following are facts about bit complexities.*

1. The bit complexity of $f \circ g$, the composition of two linear rational functions f and g , is at most the sum of the bit complexities of f and g .
2. The bit complexities of $x \cdot y$, the product of two rational numbers x and y , is at most the sum of the bit complexities of x and y .
3. The bit complexities of $f(x)$, the evaluation of a linear rational function f on a first-order radical x , is at most the sum of complexity of f and x .

► **Lemma 14.** *Let f_A and f_B be two piecewise linear rational functions in either the unit-interval or ray representation, with domains $D_A, D_B \subset S^1$ (none of D_A, D_B, S^1 are necessarily equal). Then, for any choice of branch cut, the following are also piecewise linear rational functions with domain $D_A \cup D_B$:*

$$\begin{aligned} \blacksquare f_{\max}(x) &= \begin{cases} \max(f_A(x), f_B(x)) & x \in D_A \cap D_B \\ f_A(x) & x \in D_A \setminus D_B \\ f_B(x) & x \in D_B \setminus D_A \end{cases} \\ \blacksquare f_{\min}(x) &= \begin{cases} \min(f_A(x), f_B(x)) & x \in D_A \cap D_B \\ f_A(x) & x \in D_A \setminus D_B \\ f_B(x) & x \in D_B \setminus D_A \end{cases} \end{aligned}$$

Moreover, if f_A and f_B respectively have n and m pieces within their respective domains, then f_{\max} and f_{\min} each have $O(n + m)$ boundary points, and the description complexity of the resulting function is at most the sum of the description complexity of f_A and f_B .

Proof. Consider f_{\max} (the proof is identical for f_{\min}). Split into maximal arcs of S^1 contained entirely within some piece of f_A and some piece of f_B , or entirely out of the domain of one but not the other. There are at most $O(n + m)$ such maximal arcs. Within each arc entirely out of the domain of one, there are no additional boundary points added. To complete the proof, it suffices to show that within each shared maximal arc, there are $O(1)$ points x such that $f_A(x) = f_B(x)$, and all the additional boundary points are first order radical numbers, since that would imply $O(n + m)$ total boundary points.

In the unit-interval representation, the equation $f_A(x) = f_B(x)$ is asking for equality of general one-dimensional two rational functions, which is a quadratic equation, with at most two solution (unless the two are equal everywhere, which does not induce new boundary points).

In the ray representation, the equation $f_A(x) = f_B(x)$ is equivalent to requiring that $\frac{A\bar{x}}{B\bar{x}} = \frac{C\bar{x}}{D\bar{x}}$, for matrices $A, B, C, D \in \mathbb{R}^{2 \times 2}$, or $A\bar{x} \odot D\bar{x} = C\bar{x} \odot B\bar{x}$, where \odot denotes point-wise multiplication. This is a system of (two) quadratic equations in two variables with pure quadratic terms (all terms are of the form ax_i^2 for one of the variables x_i), which can be reduced to a system of general quadratic equations in one variable, and hence has at most 2 solutions, both of which are first-order radical numbers. ◀

► **Lemma 15.** *Let \tilde{g} be a lifted next-generator function such that g is a piecewise linear rational function (in either the unit-interval or ray representations) with at most n boundary points, each of bit complexity $\leq b$. Then $\tilde{g}^{(m)}$ has at most $\text{poly}(n, m)$ boundary points within one period, i.e. within $(S^1 \times \{0\}) \subset (S^1 \times \mathbb{Z})$. Moreover, each of them is of bit complexity also at most $\text{poly}(b, m)$.*

Proof. First, note that each $\tilde{g}^{(m)}$ is monotonic and periodic with period one as well. We will now prove the first fact inductively. For the base case, $\tilde{g}^{(1)}$ has exactly n boundary points in $(S^1 \times \{0\})$. We claim that $\tilde{g}^{(m)}$ has at most nm boundary points in $(S^1 \times \{0\})$. Assume this is true for $m \geq 1$. The boundary points of $\tilde{g}^{(m+1)} = \tilde{g} \circ \tilde{g}^{(m)}$ are the boundary points of \tilde{g} in addition to the boundary points of the form $\tilde{g}^{(-1)}(x)$, where x is a boundary point of $\tilde{g}^{(m)}$. Note that $\tilde{g}^{(-1)}$ is also a periodic and monotonic piecewise linear rational function (with the same period), so there are $\leq nm$ points of this form within each period. Thus $\tilde{g}^{(m+1)}$ has at most $(m+1)n$ boundary points within each period.

The bit complexity of these boundary points follows a similar argument. The base case is obvious. Assume for induction that the boundary points of $\tilde{g}^{(m)}$ have bit complexity at most mb . The bit complexity of $\tilde{g}^{(-1)}$ is at most b in both representations. Hence, the bit complexity of each additional boundary point added is at most $(m+1)b$ by Lemma 13 ◀

Observe that the above lemma directly implies Theorem 11.

3 The Contiguous Art Gallery Problem

As a reminder, we can formalize CONTIGUOUSARTGALLERY as follows:

► **Definition 16.** *Let P be a simple polygon. The CONTIGUOUSARTGALLERY problem asks to find the minimum set of contiguous paths covering the boundary, such that each path is visible in its entirety by some point inside the polygon.*

The intuition for the reduction to ANALYTICARCCOVER is quite natural: The circle is topologically equivalent to the polygon, and so the arcs \mathcal{I} will represent (maximal) contiguous paths along the polygon that have a non-empty intersected visibility region. Defining the next-generator function g is similarly straightforward. The main focus of this section is to obtain a piecewise linear rational representation of g .

We present the proof as a series of lemmas. The sequence of lemmas can be viewed a series of progressively more general carefully chosen toy examples, each building on the previous by making use of Lemma 14. The first few lemmas will be mostly standalone:

► **Lemma 17.** *Let p, p' be two points along the same edge e in a simple polygon P . Then if y is a point in P from which both p and p' are visible, all points along the edge e in between p and p' are also visible from y .*

Proof. The P is a simple polygon, the triangle with vertices p, p', y must be contained entirely inside the polygon, including each of its edges. See Figure 3. ◀

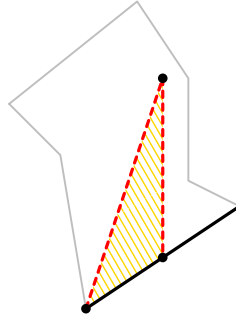

■ **Figure 3** Two two points along a shared edge both visible from a shared point, and the corresponding (empty) triangular region.

► **Lemma 18.** *Let P be a polygon and x be a point along the boundary. Then, it is possible to compute, in polynomial time, the furthest edge around the polygon counter-clockwise for which some guard point inside the polygon contains the initial location up to some non-vertex point along the edge in its visibility region.*

Note that this is different from computing the furthest point counter-clockwise, although it does narrow down which edge that point is on.

Proof. Starting at x , traverse the polygon in counter-clockwise order. For each edge encountered, start by computing the visibility region of the shared vertex in the path so far. Intersect this with the visibility region computed so far. By Lemma 17, this is no different than intersecting the visibility polygons over the continually changing point of the boundary for each edge. Then, if the visibility region becomes empty, halt, since only a partial edge is visible. Before the next iteration, check if any part of the visibility region is contained in the half-plane aligned with the edge, directed inside the polygon. If not, halt, since no part of the next edge will be visible. ◀

The remaining lemmas build on each other. Each deals with a pair of line segments e and f , and we will use some common notation for brevity. In particular, each lemma will map points on e to a particular point on f , each in parametrized form. These represent edges in the general problem, although we need not consider the general problem until the main proof. Specifically, assume $e = (p_e, p'_e)$ and $f = (p_f, p'_f)$. Then a point along each can be defined by parameters t and r , as $(p_e + t(p'_e - p_e))$ and $(p_f + r(p'_f - p_f))$. For concise statements, we let e_t and f_r denote each of these respective parametrized points.

► **Lemma 19.** *Let e, f and l be non-crossing line segments in \mathbb{R}^2 , with e, f as before. Assume that neither e nor f is crossed by the extension of l to a line. Let x_1, x_2 be points in \mathbb{R}^2 . Assume l, x_1 , and x_2 all lie within the intersection of two half-planes whose boundaries are the line extensions of e and f . Then we can compute a piecewise linear rational function R which maps a value $t \in [0, 1]$ to the maximum value $r \in [0, 1]$, such that there exists a point y along l for which $\text{Cone}(e_t, y, f_r)$ does not contain x_1 or x_2 . Some values in $[0, 1]$ may not have any such valid values, and we can also compute the ranges of values which are valid.*

Proof. First, note that it suffices to find the optimal guard point with respect to only the line passing through f . Such a function can be combined with two constants for the endpoints via a min and max, using Lemma 14.

Given the guard point as a parameter along l , we can compute the final value along the line passing through f as the minimum (parametrized) point intersected by the rays from the guard points through x_1 and x_2 (or ∞ if neither intersects), and this minimum can be taken as a piecewise linear rational function due to Lemma 14. Since linear rational functions can be composed, it suffices to find the guard point, or to compute a small number of potential guard points, and to take the maximum over those.

Consider the lines passing through the pairs of points (e_t, x_1) , (e_t, x_2) , (x_1, x_2) , as well as e_t with each endpoint of l . Consider all the intersections with each of these lines with the edge f (at least two of which are just the endpoints of l themselves). We claim that one of these intersection points forms an optimal guard point (note that optimal guard points may not be unique). This would be enough to complete the proof. Suppose for a pair of points e_t and f_r that there is an optimal guard point y along l . Then $\text{Cone}(e_t, y, f_r)$ does not contain either of x_1 and x_2 .

We will break into a series of cases. We have a subfigure for each case in Figure 4, with labels in parentheses. If y is an endpoint of l (case a), we are done. Consider moving y along each direction of l to obtain maximal-distance points y' and y'' along l from y such that $\text{Cone}(e_t, y', f_r)$ and $\text{Cone}(e_t, y'', f_r)$ do not contain either x_1 or x_2 . If either y' or y'' is equal to an endpoint of l (case b), we are done. If either pair of points (e_t, y') or (e_t, y'') induce lines containing x_1 or x_2 on their boundaries (case c), we are also done. If the lines induced by either of (y', f_r) or (y'', f_r) contain both x_1 or x_2 on their boundaries (case d), we are done. The only remaining case is that one of x_1 or x_2 lies on the line induced by (y', f_r) and the other lies on the line induced by (y'', f_r) . If this happens, then either each of x_1 and x_2 lie on opposite sides of the line through (f_r, y) (case e, a contradiction since then one would be inside a cone for some y''' in between y' and y'') or each of x_1 and x_2 lie on opposite sides of f (case f, a contradiction of the half-plane assumption). ◀

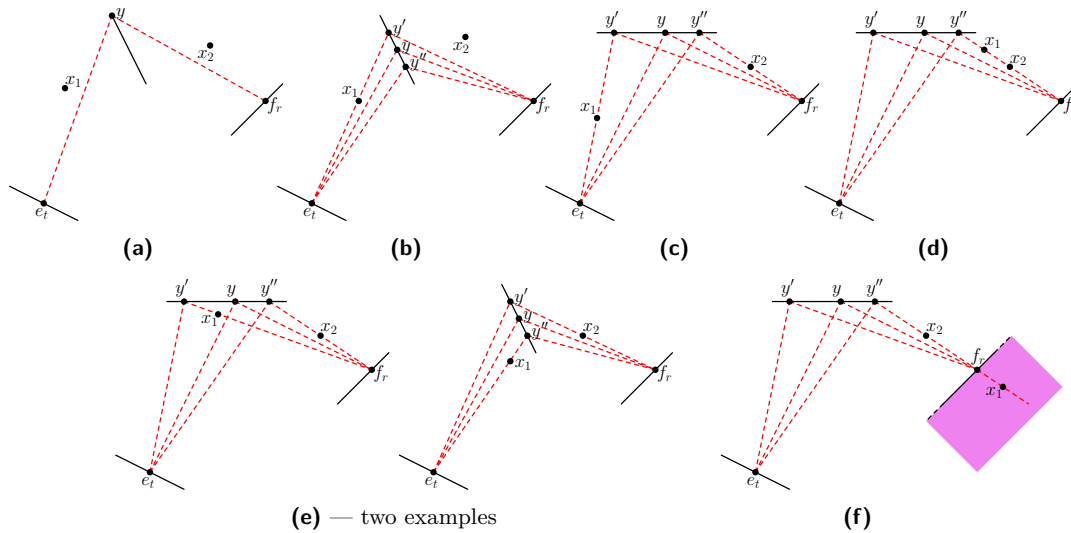

■ **Figure 4** Visualizations of the cases for Lemma 19.

► **Lemma 20.** *Let e, f and l be non-crossing line segments in \mathbb{R}^2 , with e, f as before. Let X be a finite set of points. Assume l and all $x \in X$ all lie within the intersection of two half-planes whose boundaries are the line extensions of e and f . Then we can compute a piecewise linear rational function R which maps a value $t \in [0, 1]$ to the maximum value*

$r \in [0, 1]$, such that there exists some point y along l for which $\text{Cone}(e_t, y, f_r)$ does not contain any $x \in X$. Some values in $[0, 1]$ may not have any such valid values, and we can also compute the ranges of values which are valid.

Proof. Take the minimum over applications of Lemma 19 for each (ordered) pair x_1, x_2 from X , and apply Lemma 14. ◀

► **Lemma 21.** Let e, f be non-crossing line segments in \mathbb{R}^2 as before. Let X be a finite set of points. Let C be a simple polygon that does not contain any part of e, f , or X in its interior. Assume C and each $x \in X$ are all contained within the intersection of a pair of half-planes whose boundaries pass through e and f . Then we can compute a piecewise linear rational function R which maps a value $t \in [0, 1]$ to the maximum value $r \in [0, 1]$, such that there exists some point y in C for which $\text{Cone}(e_t, y, f_r)$ does not contain any $x \in X$. Some values in $[0, 1]$ may not have any such valid values, and we can also compute the ranges of values which are valid.

Proof. Apply Lemma 20 to each edge of C as l , and apply Lemma 14. It suffices to show that a guard location on an edge of C suffices (as opposed to in the interior of C).

Fix points e_t and f_r (so that f_r is the optimal choice with respect to e_t). Let v be a valid guard point in C attaining f_r , so that $\text{Cone}(e_t, v, f_r)$ does not contain any element of X in its interior. Since $\text{Cone}(e_t, v, f_r)$ is contained in C , it must contain within it at least one point y along the boundary of C . If $\text{Cone}(e_t, y, f_r)$ covered any points in X not covered by $\text{Cone}(e_t, v, f_r)$, then the half-plane constraint would be violated, so we are done. See Figure 5 for a visualization of this argument. ◀

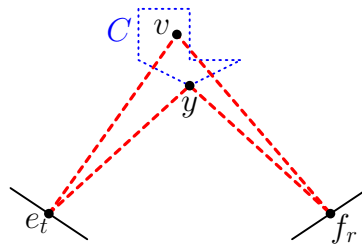

■ **Figure 5** A visualization of the argument for Lemma 21.

Note that in all of the above series of lemmas, the final range $[a, b]$ may in fact be empty. Now we are ready to present the final theorem of this section. A visualization of the lemmas applied here can be found in Figure 7.

► **Theorem 22.** Let P be a simple polygon for an instance of `CONTIGUOUSARTGALLERY`, with $n = |P|$ and b bits per coordinate. Then the instance can be reduced to the (computational) Analytic Arc Cover Problem by way of a piecewise linear rational function g , with polynomially many pieces, each with $\text{poly}(n, b)$ bits, and $\text{poly}(n, b)$ bits per endpoint.

Proof. Let the edges of the polygon be e_0, e_1, \dots, e_{n-1} . We can create a mapping of a counterclockwise traversal of these edges onto $[0, 1]$ which itself induces a (circular) traversal of S^1 when $[0, 1]$ is mapped onto it. The choice of mapping is unimportant, e.g. map the traversal of e_i onto the interval $[\frac{i}{n}, \frac{i+1}{n})$. Let $g : \mathbb{R} \rightarrow \mathbb{R}$ be the next-generator function for this traversal. That is, g takes a value $t \in [0, 1)$, proof, we will assume e_i is fixed, since the function can be defined piecewise for each e_i .

For each segment e_j we can first check if there is any part of e_i that g maps to e_j with Lemma 18. If so: Let X be the set of vertices of P along the edges $e_{(j+1) \pmod n}, \dots, e_{(i-1) \pmod n}$ which are found in the cone formed half-planes whose boundaries overlap e_i and e_j directed into the polygon. Let C be the visibility polygon(-al region) that can “see” all the edges $e_{(i+1) \pmod n}, \dots, e_{(j-1) \pmod n}$ (or the shared vertex of e_i and e_j if $j = (i + 1) \pmod n$). Finally, apply Lemma 21 on $e = e_i, f = e_j, X = X, C = C$ to obtain a piece-wise linear rational function $f_{i,j}$ defined on some sub-interval of e_i .

Let f_i be the function which takes the maximum values over all applicable $f_{i,j}$ via Lemma 14. We claim that, when scaled to the appropriate bounds for e_i , f agrees with g over e_i . Let p and q be points along e_i and e_j respectively, so that g maps p to q . Let y be any optimal guard location. By definition, y must be inside C . Moreover, no point in X can be contained in the cone formed by p, y, q , since the presence of such a point would violate the requirement that the lines \overline{py} and \overline{qy} are contained fully within the polygon (i.e., that the pairs p, y and q, y are each mutually visible). Hence, $f(t) \geq g(t)$.

Finally, suppose for contradiction that the guard location y' produced for $f(t)$ did not contain the entire path from p to q in its visibility polygon. Since y' is inside C , Lemma 17 gives that y' must not contain one of p or q within its visibility polygon. Without loss of generality assume that it is p . Then the line segment from y' to p must intersect the exterior of P , and hence must intersect some edge e_k of P . We obtain two cases:

- If e_k is in $e_{(i+1) \pmod n}, \dots, e_{(j-1) \pmod n}$, then assume without loss of generality that $(k - i) \pmod n$ is minimal. Since y' is in C , y' is in the visibility polygon of e_k , and hence e_k has a particular orientation at the crossing point with $\overline{py'}$. The minimality of e_k implies that p has the opposite orientation. Hence y' is not in the half-plane induced by e_i , and hence not in C , a contradiction.
- If e_k is in $e_{(j+1) \pmod n}, \dots, e_{(i-1) \pmod n}$, then since no point in X is in the cone formed by p, y', q , e_k must cross both $\overline{py'}$ and $\overline{qy'}$. Hence, y' does not contain any of $e_{(i+1) \pmod n}, \dots, e_{(j-1) \pmod n}$ (nor the shared endpoint of e_i and e_j if $j = (i + 1) \pmod n$), and so y' is not in C , a contradiction.

See Figure 6 for visualizations of each argument. With this, we have completed the proof. ◀

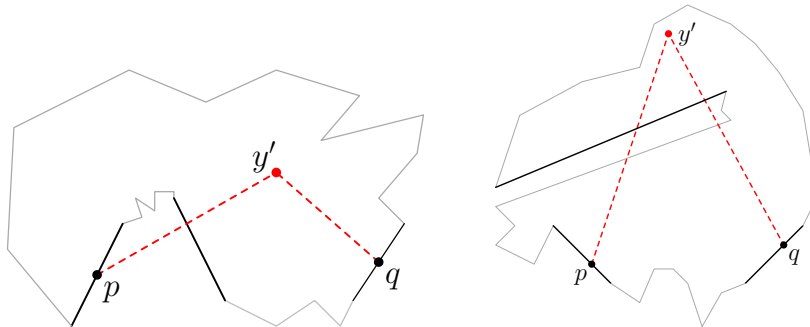

■ **Figure 6** Visualizations of the cases used for the final step in the proof for Theorem 22.

As a consequence of this proof, we obtain Theorem 1 by applying Theorem 11.

4 The Polygon Separating Problem

In this section, we will study SEGMENTSEPARATION. Recall that SEGMENTSEPARATION considers separating two sets of line segments with a minimum-vertex convex polygon. We

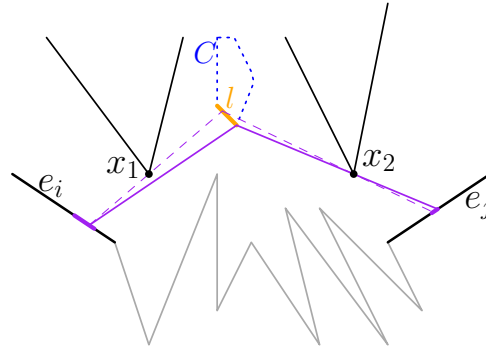

■ **Figure 7** A visualization of the construction for the piecewise rational function used for CONTIGUOUSARTGALLERY.

can also consider the problem SEGMENTPOLYGONCONVEXSEPARATION, where we wish to separate a convex polygon from a collection of line segments with a minimum-vertex polygon (not necessarily convex). In fact, these two problems are equivalent. First, note that a convex polygon contains a set of line segments if and only if it contains their convex hull, so SEGMENTSEPARATION is equivalent to separating a set of line segments from an “inner” convex polygon. We can make another observation for SEGMENTPOLYGONCONVEXSEPARATION:

► **Theorem 23.** *Let P be a convex polygon contained by a polygon Q . If Q is non-convex, there is another convex polygon Q' with at most as many sides as Q such that $P \subset Q' \subset Q$.*

See Figure 8 for an example. This theorem is analogous to a similar theorem proved by [4], although we require a different (but still elementary) proof.

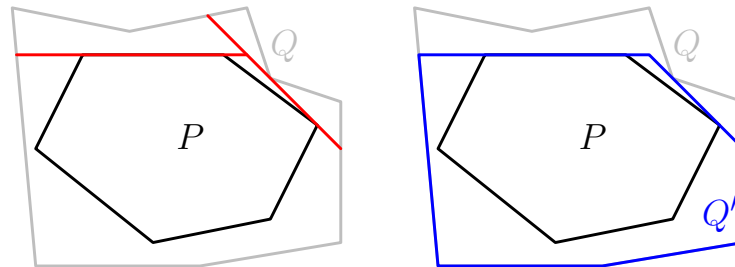

■ **Figure 8** A construction for the equivalence between convex and non-convex separating polygons.

Proof. Consider a reflex vertex v of Q . Take some tangent line L of P separating v from the interior of P . Q and L together separate \mathbb{R}^2 into cells, one of which contains P . The boundary of that cell is then a smaller polygon containing P with at most as many sides as Q , at least one fewer vertices. Repeat until a polygon Q' with no reflex vertices is found. ◀

This gives us an immediate corollary:

► **Corollary 24.** *SEGMENTSEPARATION is in P if and only if SEGMENTPOLYGONCONVEXSEPARATION is in P .*

This is because both problems are equivalent to the problem of separating a set of “outer” line segments from an “inner” convex polygon with a separating convex polygon. We will henceforth refer to the resulting problem SEGMENTCONVEXPOLYGONSEPARATION. Note

that without loss of generality, it can be assumed that each side of the convex polygon must touch the boundary of the inner polygon (follows from a standard separating line argument). See Figure 9 for an example of a `SEGMENTCONVEXPOLYGONSEPARATION`.

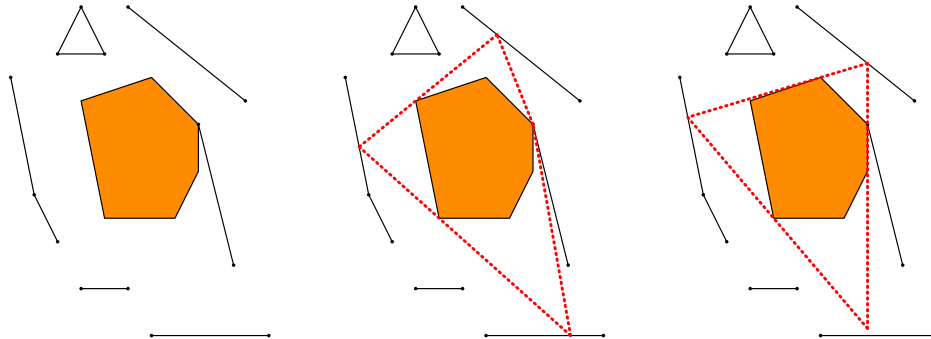

■ **Figure 9** An instance of `SEGMENTCONVEXPOLYGONSEPARATION`, and two potential solutions (one sub-optimal).

If we knew one of the sides of the optimal solution, we could go counterclockwise around the inner polygon and greedily take the next edge that covers as many uncovered segments as possible. This approach would work for `POINTSEPARATION` as it can be shown that there exists an edge that passes through two input points. However, for `POLYGONSEPARATION` and `SEGMENTSEPARATION`, we are unable to prove that this is the case. Indeed, the algorithm of [4] for `POLYGONSEPARATION` also accounts for this possibility.

► **Theorem 25.** *Consider an instance of the minimum carving by line segments problem with a convex hull of size m , n line segments, and $\leq b$ bits per coordinate. Then, it can be reduced to `ANALYTICARCCOVER`, whose next-generator is a piecewise linear rational function of two dimensions g , whose domain is the unit circle S^1 embedded in \mathbb{R}^2 . g has polynomially many pieces, polynomially many bits per linear rational function, and polynomially many bits per boundary point.*

Unlike the art gallery problem we discussed, it is not as intuitive how this problem can be reduced to the arc cover problem. The key idea here is that we will map cuts to points on S^1 (through the ray representation in this case). Specifically, the normal vector of each cut (where the cut is treated as a half-plane away from the inner polygon) can be easily mapped to a point on the unit circle, by way of the standard embedding in \mathbb{R}^2 .

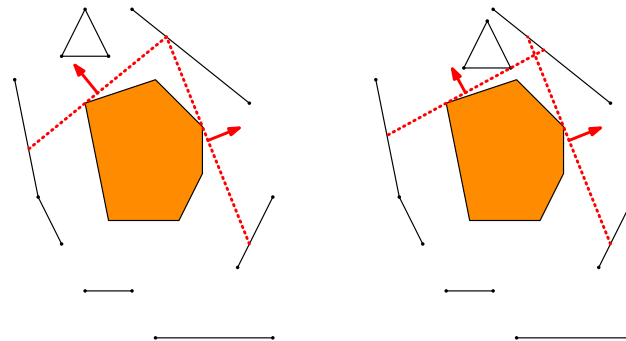

■ **Figure 10** The two types of “sequential” cuts, along with their normal vectors.

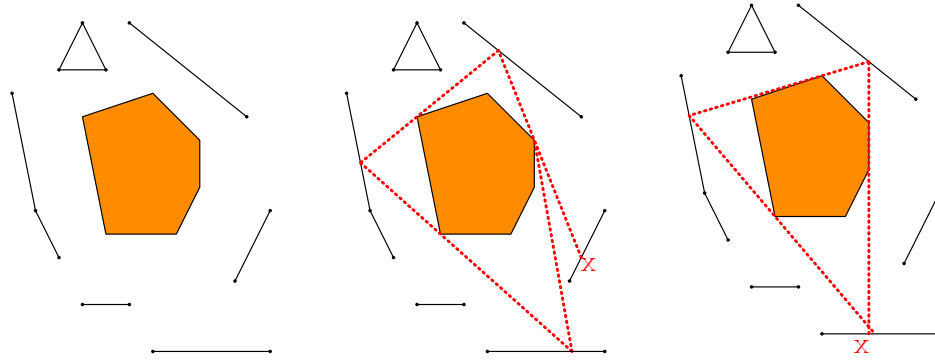

■ **Figure 11** An instance of `SEGMENTCONVEXPOLYGONSEPARATION`, and two greedy cut sequences from different starting points x . These are the same resulting polygons as Figure 9.

Proof. For any cut C , sweep counter-clockwise starting from C , with these events:

1. An uncovered segment or partial segment begins intersecting the half-plane.
 2. An uncovered segment or partial segment is about to stop intersecting the half-plane.
- Terminate the sweep on the first instance of the second kind. The resulting “next” cut takes on two possible forms (see Figure 10 for an example of each):
- The other tangent line from a point along the first line segment intersected by C . We will refer to this as a greedy reflection.
 - A tangent line through the endpoint of some other line segment.

Our reduction is as follows: Let S be the set of all lines passing through both a line segment endpoint, p or q for every line segment pq , and another vertex r of the inner polygon. Let T be the set of tangents into the half-planes induced by each line in S as well as the set of lines L_P extending the polygon. The set T forms the boundaries of our “outer-most” pieces, and the next generator at these boundaries can be computed directly.

Next, within the open interval inside each of these pieces, there is a unique vertex of the polygon through which we consider the crossing half-planes. That is, there is one current vertex around which a line is being swept. Moreover, the set of intersected line segments remains constant as one sweeps around this vertex within the piece (by definition). We need only specify the next-generator g within each piece. Rather than carefully handle the cases in Figure 10, we take the first of all potential next half-planes required to fully cover each line segment not covered by the current half-plane. This can be performed with a minimum operation after taking an appropriate branch cut, and the resulting function is itself a piecewise linear rational function by Lemma 14.

In particular, there are two types of valid choices of next half-plane: Either the next half-plane intersects a segment at the same location (but from “behind”), or it starts from an endpoint of a fully uncovered line segment. In either case, it suffices to find the vertex of the inner polygon P for which the corresponding tangent line is formed, since given that point we can compute a 2D linear rational function giving the (not-necessarily-unit) normal vector of the next half-plane subject to the constraints of the ray representation (see Figure 12 for this derivation). For the endpoints, the next tangent vertex can be computed ahead of time. For the segments, the next tangent vertex choice can be also computed as a mapping of partitions of the segment. Each of these take polynomial time to compute.

We have described the entire linear rational function. Moreover, the reduction itself takes polynomial time, so we are done. ◀

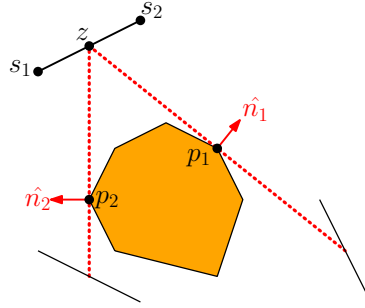

■ **Figure 12** A linear rational function for the next half-plane by its normal vector \hat{n}_2 from \hat{n}_1 , with p_1, p_2, s_1, s_2 all fixed. In particular, $z = s_1 + \frac{\hat{n}_1 \cdot (p_1 - s_1)}{\hat{n}_1 \cdot (s_2 - s_1)}(s_2 - s_1)$ and $\hat{n}_2 = ((p_2 - z)_y, -(p_2 - z)_x)$.

By Theorem 11, we have proven Theorem 2 and have also shown SEGMENTPOLYGON-CONVEXSEPARATION and SEGMENTCONVEXPOLYGONSEPARATION to be in P.

5 Optimal 3D Half-Plane Carving

Recent work by Robson, Spalding-Jamieson, and Zheng [22] has presented an algorithm for determining if a 3D polytope can be “carved” with half-plane cuts. That is, if a set of half-planes \mathcal{H} can produce a connected region in $\mathbb{R}^3 \setminus (\bigcup_{H \in \mathcal{H}} H)$ equal to the interior of a particular polytope P . Examples of “YES” and “NO” instances for this problem can be found in Figure 13 and Figure 14. This solved an open problem posed by Demaine, Demaine, and Kaplan [8], who considered a 2D variant of this problem utilizing line segment cuts. The latter work also posed another open problem in their 2D model: Does there exist an algorithm to minimize the number of cuts. In this section, we will solve this problem for the 3D model with half-plane cuts. That is, we will compute a minimum-sized set of half-planes \mathcal{H} carving P .

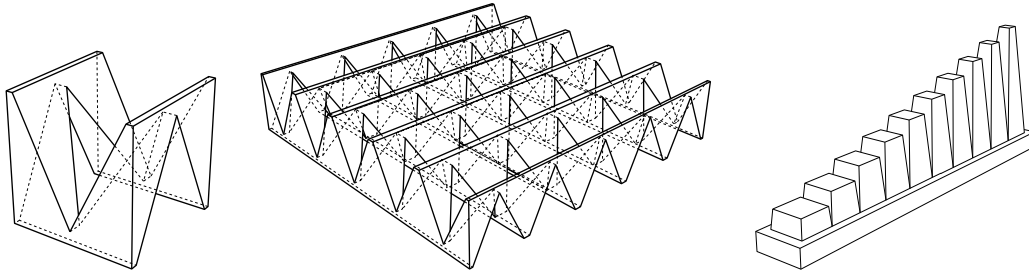

■ **Figure 13** Some examples of 3D polytopes that *can* be carved with half-planes.

Importantly, Robson, Spalding-Jamieson, and Zheng proved the following theorem:

► **Theorem 26** ([22, thm 1]). *Let $CH(S)$ denote the convex hull of a set of points S . Let $Int(P)$ denote the interior of a polytope P . Then, for a triangulated 3D polytope P (that is, each face is triangulated), the following are equivalent:*

- (a) P is carveable with a set of half-planes.
- (b) For each facial triangle T in P , let L_T denote the plane containing T . There is a single half-plane H containing T and not containing $CH(Int(P) \cap L_T)$ whose boundary line passes through a vertex of $CH(Int(P) \cap L_T)$, and also passes through a vertex v of T .

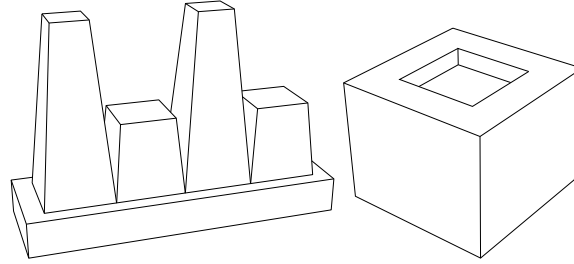

■ **Figure 14** Some examples of 3D polytopes that *cannot* be carved with half-planes.

An example of the latter condition can be found in Figure 15. In particular, a set of all half-planes corresponds to the latter condition if and only if it corresponds to a set of carving half-planes. For additional details and examples, we point readers to the original paper [22].

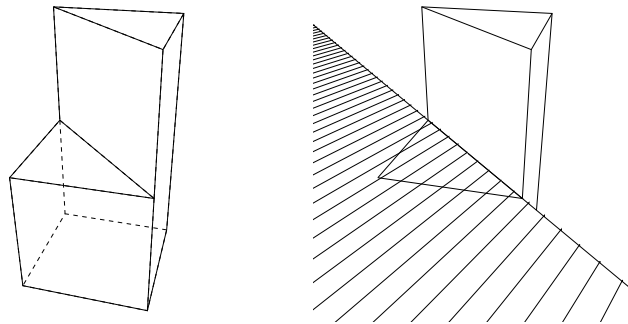

■ **Figure 15** An example of a half-plane cut for a particular face.

That said, while such a set of half-planes has size n (for n triangular faces of the polytope), and can be found in polynomial time via the methods of the original paper, it does not necessarily result in the fewest number of cuts. In particular, it may be possible to replace a set of co-planar half-planes with a smaller set. In fact, this is the only case we must consider: For a face to be carved, there must be a set of co-planar half-planes covering the face. Hence, this allows us to reduce the optimization variant to the two-dimensional Polygon Separating problem:

► **Lemma 27.** *Let P be a polytope with triangulated faces that can be carved with half-planes. Partition the triangular faces by coplanarity. For each partition containing a set of triangles \mathcal{T} along a plane $L_{\mathcal{T}}$, let $Q_{\mathcal{T}}$ be the polygon formed by $\text{Int}(P) \cap L_{\mathcal{T}}$, and let $S_{\mathcal{T}}$ be the set of edges of triangles in \mathcal{T} . Solve the Polygon Separating problem on each $Q_{\mathcal{T}}, S_{\mathcal{T}}$. Then, the resulting set of half-planes also forms a minimum set of half-planes carving P .*

This is enough to obtain a polynomial-time solution to the optimization problem. That is, applying Theorem 2 and Theorem 11 proves Theorem 3.

References

- 1 Mikkel Abrahamsen, Anna Adamaszek, and Tillmann Miltzow. Irrational guards are sometimes needed. In Boris Aronov and Matthew J. Katz, editors, *33rd International Symposium on Computational Geometry, SoCG 2017, July 4-7, 2017, Brisbane, Australia*, volume 77 of *LIPICs*, pages 3:1–3:15. Schloss Dagstuhl - Leibniz-Zentrum für Informatik, 2017. doi: 10.4230/LIPICs.S0CG.2017.3.

- 2 Mikkel Abrahamsen, Anna Adamaszek, and Tillmann Miltzow. The art gallery problem is $\exists\text{R}$ -complete. *J. ACM*, 69(1):4:1–4:70, 2022. doi:10.1145/3486220.
- 3 Alok Aggarwal. *The art gallery theorem: its variations, applications and algorithmic aspects*. PhD thesis, Johns Hopkins University, 1984.
- 4 Alok Aggarwal, Heather Booth, Joseph O’Rourke, Subhash Suri, and Chee-Keng Yap. Finding minimal convex nested polygons. *Inf. Comput.*, 83(1):98–110, 1989. doi:10.1016/0890-5401(89)90049-7.
- 5 Syed Ishtiaque Ahmed, Masud Hasan, and Md. Ariful Islam. Cutting a convex polyhedron out of a sphere. *Graphs Comb.*, 27(3):307–319, 2011. doi:10.1007/s00373-011-1018-1.
- 6 Thomas H Cormen, Charles E Leiserson, Ronald L Rivest, and Clifford Stein. *Introduction to algorithms*. MIT press, 2022.
- 7 Ovidiu Daescu and Jun Luo. Cutting out polygons with lines and rays. *Int. J. Comput. Geom. Appl.*, 16(2-3):227–248, 2006. doi:10.1142/S0218195906002014.
- 8 Erik D. Demaine, Martin L. Demaine, and Craig S. Kaplan. Polygons cuttable by a circular saw. *Comput. Geom.*, 20(1-2):69–84, 2001. doi:10.1016/S0925-7721(01)00036-0.
- 9 Erik D. Demaine, Joseph S. B. Mitchell, and Joseph O’Rourke. Problem 33: Sum of Square Roots. URL: <https://topp.openproblem.net/p33>.
- 10 Adrian Dumitrescu and Masud Hasan. Cutting out polygons with a circular saw. *Int. J. Comput. Geom. Appl.*, 23(2):127–140, 2013. doi:10.1142/S0218195913600030.
- 11 Herbert Edelsbrunner and Franco P. Preparata. Minimum polygonal separation. *Inf. Comput.*, 77(3):218–232, 1988. doi:10.1016/0890-5401(88)90049-1.
- 12 M. R. Garey and David S. Johnson. *Computers and Intractability: A Guide to the Theory of NP-Completeness*. W. H. Freeman, 1979.
- 13 Wen-Lian Hsu and Kuo-Hui Tsai. Linear time algorithms on circular-arc graphs. *Information Processing Letters*, 40(3):123–129, 1991.
- 14 Jerzy W. Jaromczyk and Mirosław Kowaluk. Sets of lines and cutting out polyhedral objects. *Comput. Geom.*, 25(1-2):67–95, 2003. doi:10.1016/S0925-7721(02)00131-1.
- 15 Aldo Laurentini. Guarding the walls of an art gallery. *Vis. Comput.*, 15(6):265–278, 1999. doi:10.1007/S003710050177.
- 16 D. T. Lee and Arthur K. Lin. Computational complexity of art gallery problems. *IEEE Trans. Inf. Theory*, 32(2):276–282, 1986. doi:10.1109/TIT.1986.1057165.
- 17 Magnus Christian Ring Merrild, Casper Moldrup Rysgaard, Jens Kristian Refsgaard Schou, and Rolf Svenning. The contiguous art gallery problem is solvable in polynomial time, 2024. URL: <https://arxiv.org/abs/2412.13938>, arXiv:2412.13938.
- 18 Joseph O’rourke. *Art gallery theorems and algorithms*. Oxford University Press, Inc., 1987.
- 19 Joseph O’Rourke. Visibility. In Jacob E. Goodman and Joseph O’Rourke, editors, *Handbook of Discrete and Computational Geometry, Second Edition*, pages 643–663. Chapman and Hall/CRC, 2004. doi:10.1201/9781420035315.CH28.
- 20 Mark H. Overmars and Emo Welzl. The complexity of cutting paper (extended abstract). In *Proceedings of the First Annual Symposium on Computational Geometry, Baltimore, Maryland, USA, June 5-7, 1985*, pages 316–321. ACM, 1985. doi:10.1145/323233.323274.
- 21 Joseph O’Rourke. Advanced problem 6369. *Amer. Math. Monthly*, 88(10):769, 1981.
- 22 Eliot W. Robson, Jack Spalding-Jamieson, and Da Wei Zheng. Carving polytopes with saws in 3d. In Rahnuma Islam Nisha, editor, *Proceedings of the 36th Canadian Conference on Computational Geometry, CCCG 2024, Brock University, St. Catharines, Ontario, Canada, July 17 - August 19, 2024*, pages 145–152, 2024.
- 23 Michael Ian Shamos. *Computational Geometry*. PhD thesis, Yale University, 1978. URL: <http://euro.ecom.cmu.edu/people/faculty/mshamos/1978ShamosThesis.pdf>.
- 24 Thomas C. Shermer. Recent results in art galleries (geometry). *Proc. IEEE*, 80(9):1384–1399, 1992. doi:10.1109/5.163407.
- 25 Jack Stade. Complexity of the boundary-guarding art gallery problem. *CoRR*, abs/2210.12817, 2022. arXiv:2210.12817, doi:10.48550/ARXIV.2210.12817.

- 26 Xuehou Tan. Approximation algorithms for cutting out polygons with lines and rays. In *Computing and Combinatorics, 11th Annual International Conference, COCOON 2005, Kunming, China, August 16-29, 2005, Proceedings*, volume 3595 of *Lecture Notes in Computer Science*, pages 534–543. Springer, 2005. doi:10.1007/11533719_54.
- 27 Jorge Urrutia. Art gallery and illumination problems. In Jörg-Rüdiger Sack and Jorge Urrutia, editors, *Handbook of Computational Geometry*, pages 973–1027. North Holland / Elsevier, 2000. doi:10.1016/B978-044482537-7/50023-1.