

# Performance of ChatGPT on tasks involving physics visual representations: the case of the Brief Electricity and Magnetism Assessment

Giulia Polverini, Jakob Melin, Elias Önerud, and Bor Gregorcic

Department of Physics and Astronomy, Uppsala University, Box 516, 75120 Uppsala, Sweden

**Abstract:** Artificial intelligence-based chatbots are increasingly influencing physics education due to their ability to interpret and respond to textual and visual inputs. This study evaluates the performance of two large multimodal model-based chatbots, ChatGPT-4 and ChatGPT-4o on the Brief Electricity and Magnetism Assessment (BEMA), a conceptual physics inventory rich in visual representations such as vector fields, circuit diagrams, and graphs. Quantitative analysis shows that ChatGPT-4o outperforms both ChatGPT-4 and a large sample of university students, and demonstrates improvements in ChatGPT-4o's vision interpretation ability over its predecessor ChatGPT-4. However, qualitative analysis of ChatGPT-4o's responses reveals persistent challenges. We identified three types of difficulties in the chatbot's responses to tasks on BEMA: (1) difficulties with visual interpretation, (2) difficulties in providing correct physics laws or rules, and (3) difficulties with spatial coordination and application of physics representations. Spatial reasoning tasks, particularly those requiring the use of the right-hand rule, proved especially problematic. These findings highlight that the most broadly used large multimodal model-based chatbot, ChatGPT-4o, still exhibits significant difficulties in engaging with physics tasks involving visual representations. While the chatbot shows potential for educational applications, including personalized tutoring and accessibility support for students who are blind or have low vision, its limitations necessitate caution. On the other hand, our findings can also be leveraged to design assessments that are difficult for chatbots to solve.

## I. INTRODUCTION

Large Language Models (LLMs) have emerged as a transformative force in society since late 2022, when OpenAI's GPT model was made available to the public in the form of ChatGPT, a user-friendly and broadly accessible chatbot. LLM-based chatbots can process textual inputs, including natural language, mathematical symbols, and computer code, and generate contextually relevant textual outputs. Their abilities, in combination with ease of use and broad availability, have disrupted various areas of life, with education being one of the most impacted [1,2]. The rapid adoption, quickly improving capabilities, and inherent flexibility of their use make LLMs a technology that continues to influence and disrupt educational practices worldwide [3].

Physics education is no exception to this trend [4]. A significant advancement in LLM technology has been the development of models able to process not only text but also other data types, such as images and audio. These are referred to as Large Multimodal Models (LMMs). Their ability to interpret diverse inputs broadens their potential for educational applications. In the context of physics education, the relevance of LMMs is particularly pronounced, because doing physics requires a deep engagement with diagrams, graphs, sketches [5], as well as other visual and embodied representations [6,7].

Because building LLMs and LMMs from scratch and fine-tuning them is computationally demanding and costly, educators often turn to commercial actors like OpenAI and Google for ready-made baseline models [8]. These models serve as foundational tools that can be adapted for a variety of educational purposes (e.g., [9–11]). Given their growing adoption and diverse potential applications, it is important for the educational research community to continuously assess the abilities of widely used commercial LLMs and LMMs in different educational contexts. The ability to work with different graphical

representations, which is especially relevant for physics education, is one such area in need of continuous assessment.

However, research on this topic in physics is still scarce. Our study addresses this gap by investigating the ability of widely used LMM-based chatbots – ChatGPT-4 and ChatGPT-4o – to engage with conceptual physics tasks involving diverse graphical representations. This is a continuation of our previous work assessing ChatGPT’s ability to interpret kinematics graphs [12], but extends our scope to a broader range of physics representations that have not been systematically explored yet. To do this, we focus on electricity and magnetism, an area of physics particularly rich in different representations. We test OpenAI chatbots’ performance on the Brief Electricity and Magnetism Assessment (BEMA) [13], a well-established research-based survey in physics education research, which features a diverse range of disciplinary representations, including sketches, vectors, vector fields, circuit diagrams, and graphs.

The study addresses the following two research questions:

*RQ1. What is the performance of ChatGPT-4 and ChatGPT-4o on BEMA?*

*RQ2. What difficulties does the more recent and more widely used model, ChatGPT-4o, face in interpreting and solving tasks that involve diverse visual physics representations?*

To answer these questions, we divide our investigation into two parts. For RQ1, we quantitatively evaluate the performance of both models on BEMA, comparing their performance to each other and to those of a sample of university students taking a calculus-based course on electricity and magnetism [14]. For RQ2, we investigate qualitatively the difficulties encountered by the more recent and more widely used model, ChatGPT-4o, in solving tasks on BEMA. By addressing these research questions, we aim to provide the physics education community with a critical perspective on the abilities of the two broadly used commercial LLM-based chatbots. Our findings can guide decisions on whether and how these models can effectively support the teaching and learning of representationally rich physics topics. For instance, our findings have the potential to inform the design of educational applications and accessibility solutions for learners who are blind or have low vision, as well as support efforts to uphold academic integrity through the design and selection of assessments, which is difficult for chatbots to answer correctly.

## II. BACKGROUND

### A. LLMs and LMMs in physics education

Since the public release of ChatGPT in November 2022, and the implementation of its vision ability in October 2023, Large Language Models (LLMs) and Large Multimodal Models (LMMs) have become active research areas in physics education.

#### 1. Performance and application of LLMs in physics education

Early studies have laid the groundwork for understanding how these models perform on various physics tasks, uncovering both opportunities and challenges in leveraging them for educational purposes. Research has evaluated LLMs’ performance across a range of physics contexts:

*Research-based assessments.* Several studies have assessed LLMs’ performance on the Force Concept Inventory (FCI). ChatGPT-3.5 was shown to perform at beginners’ level [15,16], while ChatGPT-4 demonstrated expert-level performance [17]. In addition, Wheeler and Scherr [18] found that ChatGPT-3.5’s responses to FCI often mirrored common student misconceptions. Kieser et al. [19] found that ChatGPT-4 achieved 83% correctness on FCI and was, with appropriate prompting, also able to simulate realistic student misconceptions, offering a potential tool for the refining of surveys such as FCI.

*Conceptual physics tasks.* Gregorcic and Pendrill [20] analyzed ChatGPT-3.5's responses to a simple conceptual mechanics problem and found that its answers often contained incorrect or contradictory reasoning. Sirnoorkar et al. [21] explored the responses of ChatGPT-3.5 and 4 to physics problems framed to elicit sensemaking and mechanistic reasoning. While the LLMs' responses showcased structured and detailed solutions, students demonstrated comparatively richer epistemic practices such as iterative refinement and diagram-based reasoning.

*Short-form physics essay-writing.* Yeadon et al. [22] demonstrated that ChatGPT-3.5 could produce essays in a university course on the history and philosophy of physics that would achieve first-class grades. Additionally, in a follow-up study [23] the authors suggest that at-home essay-style examination is no longer sensible, since it is very hard to reliably detect LLM-generated text when it is even slightly modified by the user.

*Programming tasks.* Kortemeyer [15] found that ChatGPT-3.5 is very good at solving programming-related tasks, which often require a logical and structured approach. Yeadon et al. [24] explored the performance of GPT-3.5 and GPT-4 in university-level physics coding assignments, revealing that while GPT-4 can approach good performance in university-level physics coding assignments, students' submissions were often better due to nuanced and creative design choices.

*Laboratory-based tasks.* Low and Kalender [25] tested ChatGPT-4 in combination with a Python code-running plugin in introductory mechanics lab-related tasks. They assessed its ability to generate realistic data, analyze real experimental data, and perform statistical calculations. They found that while ChatGPT-4 could successfully handle such tasks, the quality of its output heavily depended on the specificity of prompts, and its synthetic data often displayed heteroscedasticity.

*Physics course examinations.* Yeadon and Hardy [26] evaluated ChatGPT-3.5 on physics exam questions across secondary school and university levels. While it mostly provided correct answers for simpler problems, its performance varied significantly with problem complexity. Similarly, Frenkel and Emara [27] showed that GPT-4 achieved a correctness rate of 76.6% on engineering exams, significantly outperforming GPT-3.5's 51.1%, but struggled with multistep calculations.

*Problem-solving.* Wang et al. [28] explored ChatGPT-4's ability to solve problems from a college-level engineering physics course, showing that the chatbot can achieve a success rate of 62.5% on well-specified problems but struggled with under-specified problems. Kumar and Kats [29] demonstrated that ChatGPT-4, in combination with a Python code-running plugin, could successfully solve introductory college-level vector calculus and electromagnetism problems.

Collectively, these studies indicate that LLMs mostly excel in well-defined, structured problems that involve straightforward applications of formulas or principles, regardless of the specific subarea of physics, as well as in physics programming tasks. However, they struggle more with multi-step reasoning or problems requiring implicit assumptions or contextual understanding. Studies also show that the performance of newer models (e.g., ChatGPT-4) is generally better than that of the older models (e.g., ChatGPT-3.5).

The growing interest in integrating LLMs into education has led to several proposals aimed at enhancing teaching and learning of physics. These proposals include diverse applications aimed at fostering critical thinking, enhancing student engagement, and supporting teacher training:

*Fostering critical thinking.* Bitzenbauer [30] proposed tasks where students evaluate ChatGPT-generated content for accuracy and revise it using additional sources, with the aim of promoting reflection and deeper engagement with the material. Similarly, Dahlkemper et al. [31] designed

an activity where students analyzed ChatGPT-3.5-generated answers to a series of progressively challenging questions across three physics topics, aimed at engaging students in evaluating the quality of the chatbot's outputs.

*Using a chatbot as a peer.* Vasconcelos and Dos Santos [32] suggested positioning the chatbot as a peer or “an object to think with.” By interacting with the chatbot, students could explore ideas, refine their understanding, and develop critical thinking skills in a collaborative and exploratory manner.

*Supporting teacher training.* Küchemann et al. [33] investigated the use of ChatGPT-3.5 to assist prospective physics teachers in developing physics assessment tasks. In a randomized trial comparing tasks that pre-service teachers developed with ChatGPT's assistance and by consulting traditional textbooks, they found similar levels of correctness but highlighted issues such as lower specificity and contextual embedding in chatbot-generated tasks. Gregorcic et al. [34] used ChatGPT-3.5 and 4 to support the training of pre-service teachers. By interacting with the chatbots, future educators could engage with teaching scenarios, reflect on pedagogical strategies, and practice responding to students in a Socratic fashion.

Several studies also focused on developing surveys or questionnaires that examine the perception of LLM-based chatbots by students [35,36] and teachers [37,38]. Others have also pointed out emerging concerns and challenges accompanying using LLM-based technology. For example, one such challenge is the unreliability of LLMs in generating consistently accurate outputs [39], which limits the potential for their adoption and necessitates human oversight and critical interpretation [40]. Concerns have also emerged regarding their educational use, such as the risk of spreading biases that may amplify inequities or mislead learners [41], challenges to academic integrity in educational environments [42], and broader ethical issues such as fairness and accountability [43,44].

More recently, the evolution of LLMs into LMMs has resulted in big commercial players showcasing the potential of LMM-based chatbots as math and physics tutoring systems [45,46]. Researchers have explored the potential of LMMs to take on different roles, such as tips providers [47], grading assistants for handwritten students' submissions [48,49], and tools for providing feedback [50]. Notably, assisting teachers with grading and feedback has garnered significant interest, particularly given the increasing demands on educators, who often face challenges such as large class sizes, limited resources, and high costs associated with education [51]. LMMs and LLMs could potentially serve as tools to reduce teacher workload by automating routine grading tasks [48] or helping students solve problems [52]. However, initial findings suggest that while LLMs can identify common errors or provide productive feedback, they often fail to account for nuances in student reasoning and do not provide well-differentiated assessment [53]. Mitigating these issues requires targeted prompting approaches and other techniques that reduce the risks associated with their unreliability [54].

## 2. *Application and performance of LMMs in physics education*

The abilities of LMMs to handle multimodal input, especially visual input, play a crucial role in their potential adoption in physics education. Thus, there is a need for research that evaluates the abilities of LMMs to interpret and work with visual representations. While systematic evaluations of the multimodal abilities of LMMs and LMM-based chatbots in the context of physics remain scarce, some insights can be drawn from related domains where image interpretation also plays a critical role, such as medicine (e.g., [55,56]) and medical education (e.g., [57]). These studies demonstrate the potential of commercially available LMMs to perform complex tasks by integrating textual and visual information. The field of physics, with its heavy reliance on graphical representations, also stands to benefit from these demonstrated abilities. However, the nature of physics problems presents challenges,

including the conceptual nature of graphical representations and their integration into problem-solving processes. In one of the first studies investigating the performance of LMM-based chatbots in physics [12], we investigated ChatGPT-4’s performance on the Test of Understanding Graphs in Kinematics (TUG-K), focusing on its reasoning and vision abilities when working with kinematics graphs. The chatbot achieved a 41.7% average score, comparable to physics students at the high school level. However, qualitative analysis revealed key differences between ChatGPT’s and students’ performance. While 69.7% of ChatGPT’s responses demonstrated effective problem-solving strategies, its visual interpretation accuracy was only 30.9%, making visual interpretation errors the primary cause of incorrect answers.

In a follow-up study, we also found that enabling the chatbot to use the Python code-running plugin<sup>1</sup> did not result in an improvement in the overall performance [58]. Nevertheless, ChatGPT-4 outperformed other freely available and subscription-based LMM-based chatbots from commercial competitors [58,59]. ChatGPT-4o, the successor to ChatGPT-4 and currently the most widely used vision-capable chatbot, released in May 2024, showed further improvement in the overall score on the test, achieving a correctness score of 58.6% [58].

More recently, other studies have contributed to the growing research on LMMs in physics education. Aldazharova *et al.* [60] extended the existing research on FCI, by evaluating ChatGPT-4’s performance on the test. While previous studies provided the chatbot with textual descriptions of the images on the test [15,16], Aldazharova *et al.* explored how ChatGPT performs when it is given these images as part of the multimodal input. While the model demonstrated strong reasoning abilities, often providing logical explanations even for incorrect answers, it struggled significantly with spatial reasoning and figure-based questions. Pimblet and Morrell [61] investigated ChatGPT-4’s performance on summative examinations for all courses leading to an undergraduate physics degree at a UK-based university. The chatbot achieved an upper second-class grade overall (65%), by excelling in computational tasks and single-step problems. However, it had difficulties handling multi-step reasoning, graphical interpretation, and, not surprisingly, laboratory or viva-based assessments. He *et al.* [62] explored the use of an LMM (IFlytek Spark) to assist middle school students in interpreting graphs in the context of acoustics experiments. They found that the model successfully analyzed graphs and provided detailed feedback, but also exhibited issues, such as providing too complex explanations for the target audience, as well as occasional inaccuracies. Suhonen [63] evaluated the vision interpretation abilities of several LMMs in both analyzing handwritten answers and interpreting free-body diagrams. Their study highlights that while vision-capable models can analyze and critique visual data, their accuracy and reliability vary, with ChatGPT-4 performing the best among the tested models. The scarcity of existing research on visual interpretation abilities of LMMs means that there is still a lot to be learned about this topic. Our paper aims to contribute to this early body of research.

### 3. Chain of Thought

OpenAI’s chatbots nearly always provide argumentation to justify their final answers. This feature results from the use of the Chain-of-thought approach (CoT), a technique that directs a chatbot to write out its reasoning step-by-step [64]. By writing out the answer step-by-step, CoT enables the chatbot to present what appears to be a structured argument supporting its conclusion. This technique has proven effective in improving LLMs’ performance on tasks involving multiple and complex reasoning steps [65]. Initially, explicit CoT prompting was necessary to elicit such reasoning [39]. However, recent developments suggest that OpenAI has integrated CoT into ChatGPT’s default pre-prompt,

---

<sup>1</sup> Advanced Data Analysis, previously known as Code Interpreter.

making step-by-step reasoning a standard behavior without requiring special CoT prompting from the user.

This built-in reasoning process not only enhances the chatbot’s performance on complex tasks but also serves as a valuable tool for researchers. Examining the generated reasoning steps provides a window into the models’ problem-solving process, allowing researchers to qualitatively assess their capabilities and potential limitations (see [66], for example). However, most existing studies have focused on textual or numerical problems, with little exploration of CoT in tasks requiring the integration of textual and graphical reasoning.

This paper addresses this gap by investigating LMM-based chatbots’ performance on physics tasks that combine textual and visual reasoning. It also contributes to the emerging literature on CoT analysis in the context of multimodal physics tasks, with a focus on tasks involving visual representations of electricity and magnetism. In Sec. V, we take advantage of the CoT style of responses to infer ChatGPT-4o’s abilities by closely analyzing its output. Since technical details about how ChatGPT processes images are not disclosed, analyzing CoT-style outputs can offer valuable insights into how the chatbot “sees” images.

## **B. The role of multiple representations**

Physics as a discipline relies on a range of different representations to capture and communicate disciplinary meaning. While algebraic expressions are often seen as the “language of physics,” they are only a part of the rich representational repertoire that physics uses [67–69]. In physics education, this repertoire is sometimes expanded with representations that help learners develop conceptual understanding [70], even if they are later not used to the same degree by experts [71]. On the other hand, some non-algebraic representations, such as Feynman diagrams, have actually facilitated progress in physics research and remain integral to experts’ work [5]. The topic of multiple representations is a well-developed research area in physics education [72]. Most commonly, the representations discussed in physics education research are either linguistic, mathematical, or graphical. However, some research has also looked at embodied representations (e.g., [6,7,73–75]).

From a multiple-representation perspective, electromagnetism is an especially interesting topic. Unlike classical mechanics, which often aligns closely with human experience, electricity and magnetism involve phenomena and concepts that are less directly accessible to the senses. Consequently, learning electricity and magnetism requires students to learn how to work with representations, such as vector fields and circuit diagrams, alongside with those they have already met in mechanics, such as force diagrams and graphs. Because electromagnetism often cannot be simplified to two-dimensional problems, there is also a need for three-dimensional representations, which can be fitted on a two-dimensional medium (i.e., paper or screen). To aid in visualizing and reasoning about three-dimensional relationships, physics has also developed some helpful heuristics. One of these is the right-hand rule, which allows for representing and reasoning about the direction of interrelated physics quantities, i.e., vector fields, velocities of charged particles, and forces experienced by charged particles. In the context of this paper, dealing with computer-based LMMs, the right-hand rule is especially interesting since it inherently relies on having access to, or at least having a coherent model of, a human right hand.

### III. METHOD

#### A. The Brief Electricity and Magnetism Assessment (BEMA)

To assess ChatGPT’s ability to interpret multiple types of physics visual representations, we tested its performance on the Brief Electricity and Magnetism Assessment (BEMA)<sup>2</sup>. BEMA is an established and widely used research-based assessment of students’ conceptual understanding of fundamental topics in electromagnetism, including electrostatics, magnetostatics, electric circuits, electric potential, and magnetic induction. Developed by Ding et al. [13], the test has been extensively used in physics education research (e.g., [77–79]). It consists of 31 multiple-choice items, 30 of which include visual representations such as images of electrical circuits, magnets and magnetic fields, point charges and electrical fields, current loops, etc. In 14 items, the offered answer options themselves contain visual elements, such as arrows, graphs, or depictions of objects with charge distributions. This richness of visual representations makes BEMA well-suited for our purpose of investigating ChatGPT’s ability to work with multiple physics representations. We take the results from a sample of 12214 students who took a university-level calculus-based electricity and magnetism course [14] as a reference point for comparison between the students’ and chatbots’ average performance on the test.

#### B. Data collection

All responses were generated using OpenAI’s online chat interface, with ChatGPT-4 tested in April 2024 and ChatGPT-4o in May 2024. We took high-resolution screenshots of all 31 BEMA items. Each screenshot captured the whole test item, comprising a visual representation of a situation, a question, and answer options. For 13 items, multiple survey items referred to the same image. For these, we combined all items referring to the same image into a single screenshot. In one case, 3 items were captured in the same screenshot. As a result, the original 31 BEMA items were condensed into 22 screenshots. Figure 1 (left) shows an example of one such screenshot. The prompt given to the chatbot consisted solely of the uploaded screenshot, without any additional textual instructions.

Each screenshot was submitted 60 times to ChatGPT-4. Because we prompted the chatbot in separate chat windows for each screenshot and disabled the “memory” function in the ChatGPT settings, we treated the performance on an item as an independent variable. Due to the probabilistic nature of chatbot outputs [39], responses were different every time, often arriving at different final answers on the same item. We determined the correctness of each response<sup>3</sup> and awarded it a score of either 0 or 1. This allowed us to treat the chatbot’s performance on each item as a Bernoulli variable, with an experimentally determined success rate corresponding to the chatbot’s performance score on the item ( $N$  of correct responses/ $N$  of iterations). The standard error (SE) of the performance score for each item was determined by taking the standard deviation of the item sample, divided by the square root of the number of iterations. The standard error for the different items was in the interval from 0.0 to 6.5%. The standard error of the mean (SEM) across all items on the survey was 0.8% of the available points on the test.

As a second step, we repeated the process with ChatGPT-4o. The only methodological difference is that we iterated each item 30 times instead of 60. The lower number of iterations of each item for the ChatGPT-4o data means that the uncertainty in the results is somewhat larger. The SE, in this case, was

---

<sup>2</sup> In order to protect the test integrity, we do not share the test. To facilitate the reading and interpretation of this paper, we suggest readers download the whole test from the Phyport.org website [76].

<sup>3</sup> To simplify this process, we used the basic scoring key for individual items and did not use the advanced scoring approach for the test as a whole, which links together answers on certain items [76].

in the range between 0.0% and 9.1% for the different items. The SEM across all items on the survey was 1.1% of the available points on the test. We have made the data available in an open online repository, as a resource for supporting potential future studies [80].

<p>Here is a bar magnet. The magnetic field made by the bar magnet at one location is shown on the diagram:</p>  <p>Choose from the following possible directions to answer the questions below:</p> <p>→ <b>Q21</b> What is the direction (a-j) of the magnetic field of the bar magnet at location 1 (marked with x)?</p> <p>→ <b>Q22</b> What is the direction (a-j) of the magnetic field of the bar magnet at location 2 (marked with x)?</p>	<p><b>Q21-22_20</b></p> <p>To determine the direction of the magnetic field at the given locations around the bar magnet, we need to consider the magnetic field lines which emanate from the north pole of the bar magnet and curve around to enter the south pole. Here's a detailed analysis:</p> <p>### Q21: Location 1</p> <p>Location 1 is directly to the left of the bar magnet. Magnetic field lines move from the north pole to the south pole, and on the left side of the magnet, the field lines would be pointing directly to the left.</p> <p>- Therefore, the direction of the magnetic field at location 1 is <b>a</b> (to the left).</p> <p>### Q22: Location 2</p> <p>Location 2 is below the bar magnet. For a bar magnet, the magnetic field lines loop from the north pole at the right end to the south pole at the left end. Below the magnet, the field lines will be curving downwards and back towards the left.</p> <p>- Therefore, the direction of the magnetic field at location 2 is <b>e</b> (down and to the left).</p> <p>To summarize:  - Q21: The direction of the magnetic field at location 1 is <b>a</b>.  - Q22: The direction of the magnetic field at location 2 is <b>e</b>.</p>
---	--

Figure 1: Example of two related items in the same uploaded screenshot (left) and one of the responses to it, given by ChatGPT-4o (right).

### C. Coding of answers

Like in our previous work [12,58,59], we coded the answers by noting the letter option stated by the chatbot, typically at the very end of its response (see the last four lines in Fig.1, right). In most cases, the chatbots provided a clear answer by explicitly stating a letter, making the process mostly straightforward. When a chatbot failed to select one of the provided choices explicitly or indicated that none were correct, we marked the response as not answered, “N,” and considered it incorrect (5.5% for ChatGPT-4 and 3.2% for ChatGPT-4o).

However, we observed some discrepancies between the letter option stated as the answer and the content attributed to that letter option (see the response in Fig. 1, for example). To further investigate the impact of this inconsistency on the measured performance of the two models, we implemented a second coding approach. We looked at the content of the chatbots’ output, and matched it to the corresponding answer option, regardless of the letter explicitly stated. For example, in Fig.1, using the second coding approach, the answer to question 21 was coded as “e,” and the answer to question 22 was coded as “N” because it did not match any of the offered answer options. For simplicity, we refer to the initial coding method as *coding by letter*, and to the second as *coding by meaning*.

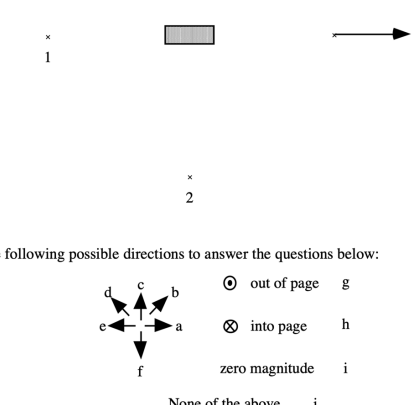
### D. Qualitative analysis of difficulties

In Section V, we take a closer look at the difficulties exhibited by ChatGPT-4o, which is the better performing, more recent and computationally cheaper model. We decided to limit our attention only to the items with below-average performance, i.e., items on which less than 67% of the responses are correct, when coded by meaning. We analyzed 14 items, ranging in performance from 3% to 60% (items 4, 5, 8-10, 21-26, and 28-30). The chatbot’s responses always contained step-by-step explanations, which allowed us to see the path by which the model arrived at the final answer and infer what difficulties it had (see Sec. II.A.3 for a discussion of the Chain-of-Thought approach).



In line with our previous research, we began by coding if a response contained any of the following two types of difficulties: difficulties with vision, and difficulties with physics reasoning [12]. However, in doing so, we observed a type of difficulty which did not fit into the two aforementioned two categories. Namely, we saw that the model often had issues with correctly solving the task, despite having correctly described the relevant features of the accompanying image (i.e., it did not exhibit difficulties in vision), and correctly stated physics principles/rules/procedures to be applied and applied them consistently (i.e., did not exhibit difficulties in reasoning) [12]. This type of difficulty can be described as unsuccessful spatial coordination of the described visual elements and stated physics laws/rules/procedures. For example, this happened when the model incorrectly applied a correctly stated the right-hand rule when determining the direction of the magnetic field around a wire with a correctly described orientation.

For each of the 420 analyzed responses, we thus noted if it contained any of the following three types of difficulties:

1. Difficulties with vision. This category includes errors in visual interpretations of the representations accompanying the items (excluding the difficulties in interpreting the answer options field, accounted for in Sec. IV). For example, the model had difficulties correctly describing the location of an element in the image.
2. Difficulties in providing correct physics laws or rules. For example, the model stated an incorrect right-hand rule.
3. Difficulties with spatial coordination and application of physics representations, laws, rules, and procedures. For example, the model incorrectly applied the principle superposition of electric fields in a given point, despite stating the principle correctly and describing the position of charges relative to the point correctly.

Two coders independently classified the difficulties in the 420 responses. They disagreed on 46 of the responses, making the intercoder agreement 89%. The disagreements were resolved after a discussion and joint coding of the discrepant items.

In addition, we observed that the model had a lot of difficulties with three-dimensional problems that typically require the use of the right-hand rule. We additionally analyzed the responses to these tasks. For each response, we noted (1) if (a version of) the right-hand rule was explicitly stated, (2) if it was stated correctly (coupled the directions to each other in the correct way), (3) how it was formulated (e.g., what the thumb, fingers and palm stand for), and (4) if it was applied correctly in the accompanying task. This allowed us to glean further insight into the model's behavior on a subset of 7 items (23-26 and 28-30) that typically involve using the right-hand rule.

#### IV. QUANTITATIVE ANALYSIS

In the first, quantitative part of our analysis, we answer RQ1 by examining the performance of ChatGPT-4 and 4o on BEMA in terms of their scores on individual items and across the entire test.

We do this by first comparing both chatbots' scores when we code the responses by the letter that the chatbot states at the end of every answer (*coding by letter*). We then examine how the score changes for each chatbot when we code their answers based on the verbal content of their answer (*coding by meaning*). The difference in each chatbot's performance gives us initial insights into their visual interpretation ability. We then compare the chatbots' performance when their responses are coded by meaning. This coding system better captures the chatbots' abilities to interpret and work with physics representations. Finally, we compare the performance of the better-performing and more recent vision-capable model, ChatGPT-4o, to that of a sample of physics students [14].

As outlined in Sec. III.D, we started coding both the answers from ChatGPT-4 and 4o by letter. According to the letter coding system, ChatGPT-4 achieves a performance of 50.2% on BEMA, while

ChatGPT-4o reaches 59.8%. Notably, both chatbots performed better on BEMA than on the TUG-K, where the performance was 42.4% and 58.6%, respectively [58]. The higher performance on BEMA likely stems from the differences in the types of representations used on both tests.

### A. The difference in performance depending on the coding system

This mismatch between the two coding systems occurred in 26.8% of ChatGPT-4’s responses and 10.8% of ChatGPT-4o’s responses. The analysis revealed that most of the time this was caused by the chatbot misinterpreting the spatial arrangement of the answer option lists, mismatching a letter with the content belonging to another answer option. Usually, in items where directions were represented using arrows labeled with letters, the chatbot mismatched the verbal description of the direction with the corresponding letter (see Fig. 1). These types of answer option lists are present in 10 out of 31 BEMA items and their graphical design appears to have negatively impacted the performance.

Coding by meaning allows us to bypass the impact of this visual interpretation problem and measure the chatbots’ ability to interpret other graphical elements in the items, namely the more canonical physics representations.

#### 1. The difference in performance of ChatGPT-4 when using the two coding systems

When coding ChatGPT-4’s responses by letter, the chatbot scored an average of 50.2% on the test. Passing from coding by letter to coding by meaning, its performance improved by 10.5 percentage points, indicating its ability to extract and process relevant information from graphical representations despite difficulties with answer option formats. Figure 2 presents the performance as captured by both coding systems. It also highlights the differences in scores on individual items: when the color of the range line is the same as “ChatGPT-4\_meaning,” it means that the performance has improved when switching to coding by meaning.

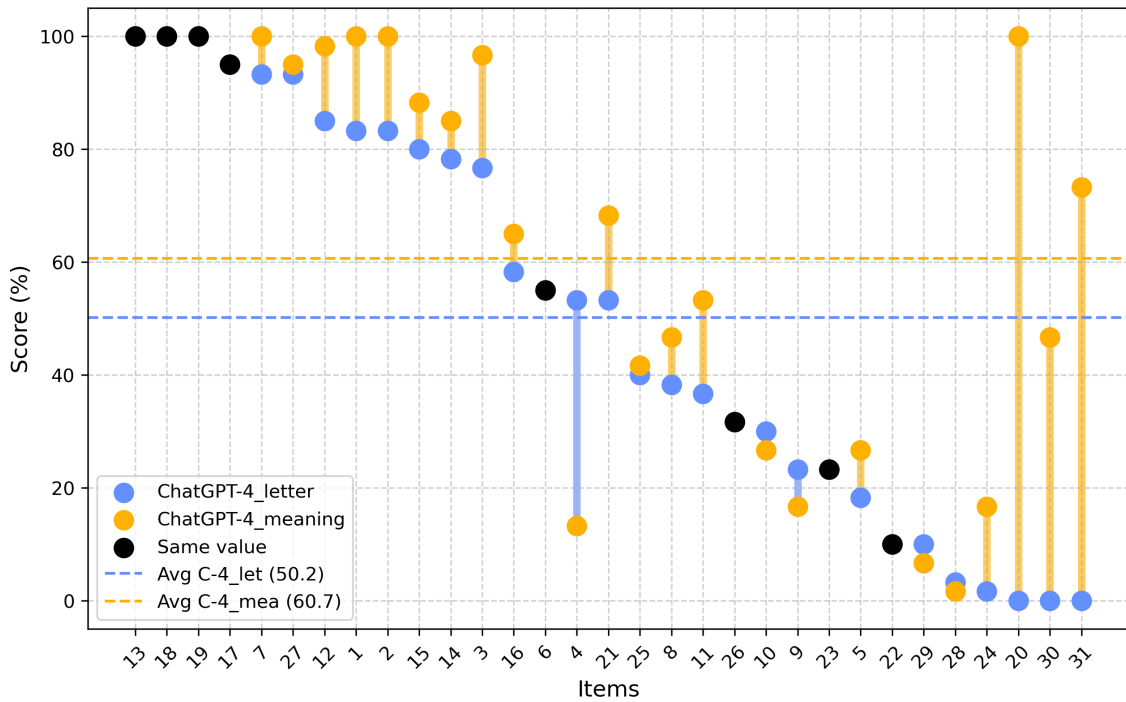

Figure 2: Differences in the performance of ChatGPT-4, when the answers are coded by letter (orange) and meaning (violet). Test items are ranked from highest to lowest score according to the letter coding system.

When coding by meaning, the performance is better for 18 out of 31 items. Item 20 benefits the most from the shift, passing from 0% to 100% correctness. This item features an answer option layout very similar to that depicted in Fig. 1 (Sec. III.B), with the issue consistently being the incorrect association of the selected letter with the intended meaning.

On the other hand, the performance is worse for 5 out of 31 items, but with only item 4 showing a sizeable decline. However, a closer analysis shows that the correct letter was mostly selected by mistake, and coding by meaning reveals the chatbot’s difficulty in correctly visually interpreting the image accompanying the item.

The performance on items 22, 24, 28, and 29 is under 20% in both coding systems. All of these items concern magnetism, with three requiring the use of the cross-product or right-hand rule. We will address this in more detail in the analysis of the responses from ChatGPT-4o, which turns out to have similar difficulties on these items (see Sec. V).

## 2. The difference in performance of ChatGPT-4o when using the two coding systems

When coding ChatGPT-4o’s responses by letter, the chatbot scored an average of 59.8% on the test. Switching to coding by meaning resulted in a 7.2 percentage point improvement, bringing the average performance to 67.0%. Figure 3 presents the scores for individual items and the overall difference in average performance across the two coding systems.

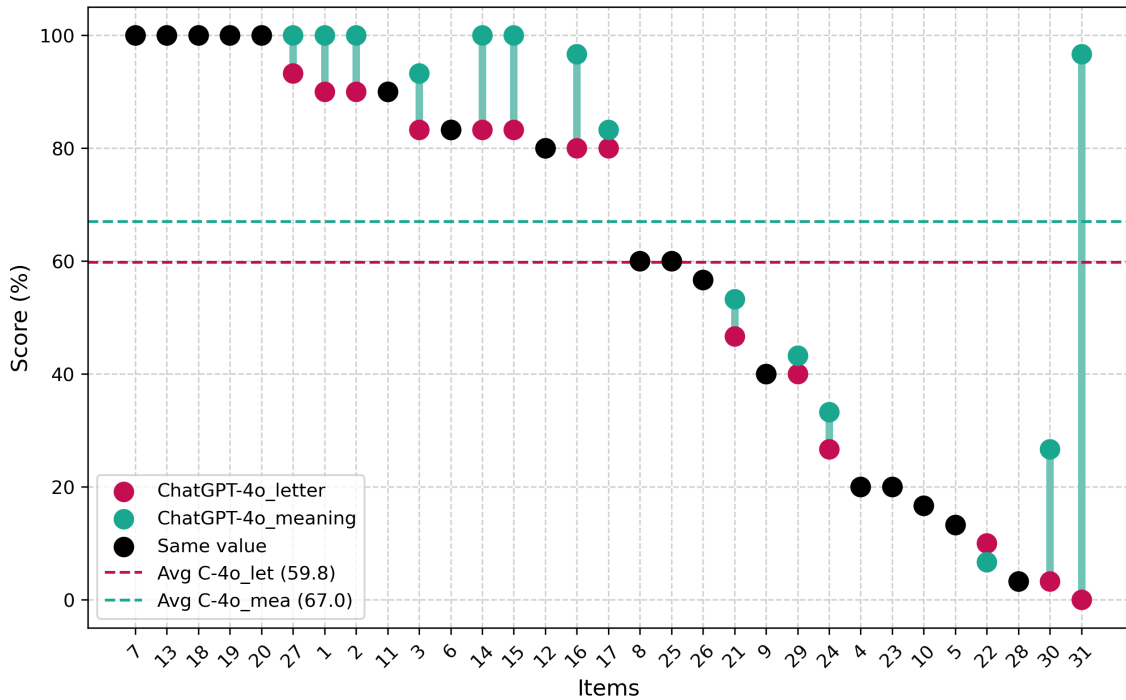

Figure 3: Differences in the performance of ChatGPT-4o, when the answers are coded by letter (magenta) and meaning (green). Test items are ranked from highest to lowest score according to the letter coding system.

Despite the improvement being much smaller than for ChatGPT-4, ChatGPT-4o’s performance increases for 16 out of 31 items, when coded by meaning. The improvement is largest for item 31,  $\mathbb{d}$  accounting for 3.1 percentage points of the total 7.2-point improvement. Interestingly, this item includes six graphs as possible answer options, each depicting the time dependence of a voltmeter reading. Consistent with our previous research, ChatGPT-4o struggles with graph-based tasks, especially when they require selecting the right graph among several options [58]. In this case, the chatbot always correctly described how the graph should look like, but failed to pick out the graph that matched the

description. This difficulty is qualitatively different from the predominant difficulty causing the mismatch in ChatGPT-4. In addition, 14 out of 31 items kept the same score, and only item 22 presents a small decline.

All in all, the smaller difference in performance when changing the coding system means that ChatGPT-4o was better than ChatGPT-4 in correctly interpreting the list of answer options and assigning verbal answers to the actual corresponding letters. This suggests that ChatGPT-4o’s vision abilities have improved compared to its predecessor.

### 3. Comparison between ChatGPT-4’s and ChatGPT-4o’s performance when coded by meaning

From here on, we analyze the models in terms of their performance when the answers were coded by meaning. The comparison between ChatGPT-4 and 4o, shown in Fig. 4, disregards the visual interpretation inaccuracies influencing the performance of both chatbots when using the letter coding system. The performance coded by meaning thus more directly tracks the chatbots’ abilities to work with physics representations embedded in the test items.

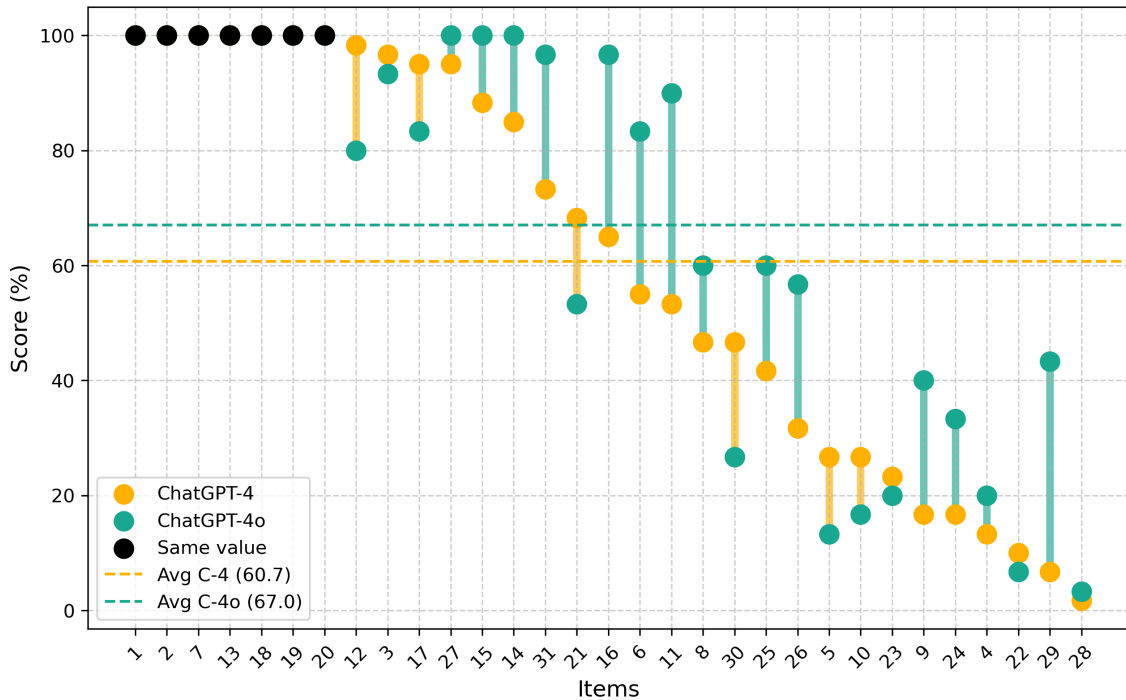

Figure 4: Difference in test performance of ChatGPT-4 (orange) and ChatGPT-4o (green), when the answers are coded by meaning. Test items are ranked from highest to lowest score according to ChatGPT-4.

When coding by meaning, ChatGPT-4o outperforms ChatGPT-4 on nearly half of the items. Although the difference in both models’ performance on the test as a whole is only 6.3 percentage points, it signifies an advantage in ChatGPT-4o’s ability to handle tasks involving the interpretation of graphical physics representations.

### B. Comparison between ChatGPT-4o’s and students’ performance

Previous research on ChatGPT-4o’s performance on visual tasks indicates that it outperforms both its predecessor ChatGPT-4 [58] and students at the high school level [59]. On BEMA, its performance, regardless of the coding system used, exceeds the average score for students (53.4%) as reported by Wheatley et al. [14] for a sample of 12214 students enrolled in an introductory calculus-based electricity

and magnetism course. Figure 5 shows the comparison between its performance, coded by meaning, and that of the student sample.

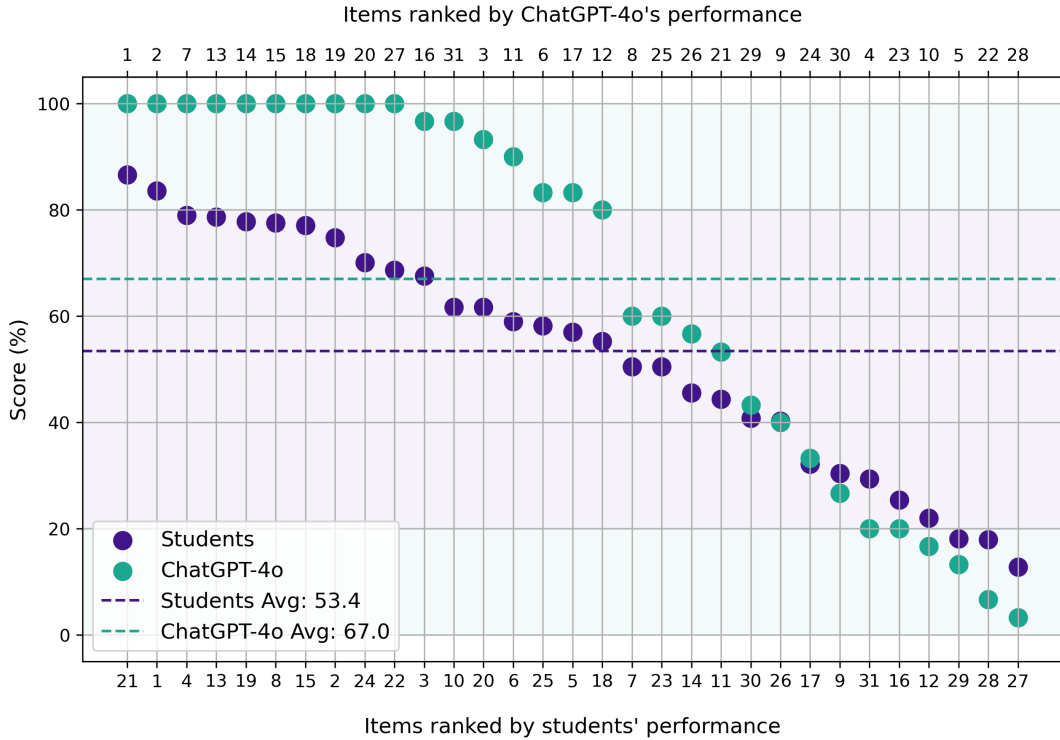

Figure 5: Test performance of ChatGPT-4o (green) and a sample of students [14] (purple). Test items are ranked from highest to lowest score.

A notable difference between ChatGPT-4o and the student dataset is the distribution of item scores. Student scores were relatively evenly spread out between 16% and 83%, with two items at 80% or above, and 3 items at 20% or below. In contrast, the chatbot’s distribution was more tail-heavy, with 14 out of 31 items scoring 80% or higher (including 10 items at 100%) and 6 scoring 20% or less. This pattern, similar to that previously observed in other work [59], highlights the chatbot’s tendency to perform either very well or poorly on specific items.

## V. QUALITATIVE ANALYSIS

In the previous section, we presented the findings of the quantitative analysis of the performance of ChatGPT-4 and 4o on BEMA. This section focuses on answering the RQ2 through a qualitative analysis of a subset of ChatGPT-4o’s responses. We limit our focus to ChatGPT-4o, which is the more recent and better-performing of the two chatbots. Additionally, it is faster and cheaper to run, thus likely to be used more broadly in educational applications.

In all its responses ChatGPT-4o provided a step-by-step explanation of the steps taken in solving each item. As we have explained in Section II.A.3, this feature, also referred to as the Chain-of-thought approach, is not only useful for users who want to understand how the answer can be arrived at, but is also a strategy employed to improve the model’s performance. Furthermore, it also provides us with a window into its processing of the tasks we submit to it.

To better understand its difficulties, we focus our analysis on items on which the chatbot showed below-average performance when coded by meaning. For simplicity, we draw the line for poor performance

at average performance (67%), giving us 14 items ranging in performance from 3% to 60%. We analyzed each of the 30 responses on these 14 items (420 in total), noting down observed difficulties. We categorized the observed difficulties into 3 categories, described below. We provide an example of each of these difficulties, as observed in our data, and a quantitative summary of their prevalence. Additionally, in Sec. V.D, we further narrow our focus on a subset of seven tasks requiring three-dimensional reasoning about moving charges/currents and associated magnetic and electrical fields, which typically involve the use of the right-hand rule.

### A. Difficulties with vision

Despite ChatGPT-4o showing an improvement over ChatGPT-4 in visual interpretation, a number of issues remain. Of the 420 responses, 136 (32%) contain errors in visual interpretation. Most commonly, these are difficulties in correctly describing the location of points of interest in the image (43% of responses on items 4, 5, 21, 22, 28, and 29). See Fig. 6 for an example. Other difficulties include incorrectly describing circuits (83% of responses on item 10, see Fig. 7 for an example) and incorrectly identifying the direction of current in a loop shown in perspective view (when the plane of the loop is not the same as the plane of the page) (70% of responses on item 24).

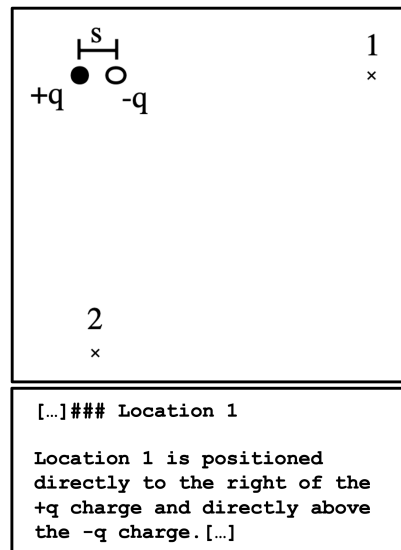

Figure 6: Image shared by items 4 and 5 (above) and the relevant part of ChatGPT-4o’s description of the image (below). The description is incorrect.

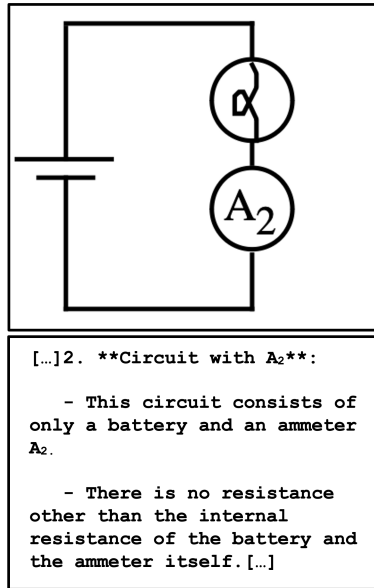

Figure 7: A cropped part of the image in item 10 (above) and the relevant part of ChatGPT-4o's description of the image (below). The description is incorrect.

## B. Difficulties with providing correct physics laws or rules

This category includes errors such as incorrectly stating physics laws and principles, or incorrectly deriving their consequences. This type of difficulty was the least common of the three categories and was present in 14% of the analyzed responses. For example, it was identified as the main culprit of wrong responses on item 9 (see Fig. 8). The relatively low number of errors in this category is not particularly surprising since language models are typically well-equipped for declarative knowledge of physics laws and principles. This corroborates our previous findings [58,59]. Still, the 14% prevalence of this type of difficulty is not insignificant, indicating that even in areas where ChatGPT-4o is typically expected to excel, inaccuracies can occur.

The magnitude of the drift velocity of the sodium ions is  $v_{Na}$ , and the magnitude of the drift velocity of the chloride ions is  $v_{Cl}$ . Assume that  $v_{Na} > v_{Cl}$ . (+e is the charge of a proton.)

→ Q9 What is the magnitude of the ammeter reading?

- (a)  $enAv_{Na} - enAv_{Cl}$
- (b)  $enAv_{Na} + enAv_{Cl}$
- (c)  $enAv_{Na}$
- (d)  $enAv_{Cl}$
- (e) zero

Since the chloride ions are negatively charged and move in the opposite direction to the sodium ions, their contribution to the total current will be in the opposite direction. Therefore, the total current  $I$  is the difference between the current due to sodium ions and the current due to chloride ions.

The total current  $I$  can be written as:

$$I = I_{Na} - I_{Cl} = neAv_{Na} - neAv_{Cl}$$

Simplifying, we get:

$$I = neA(v_{Na} - v_{Cl})$$

**\*\*Answer: (a)  $enAv_{Na} - enAv_{Cl}$  \*\***

Figure 8: Question from item 9 (above) and the relevant part of ChatGPT-4o's response (below). The reasoning is incorrect.

### C. Difficulties with spatial coordination and application of physics representations, laws, rules, and procedures

ChatGPT-4o frequently struggles with correctly applying physics principles (for example, the superposition principle and the right-hand rule) in the context of the concrete spatial configuration in a task. For example, even when it correctly stated the principles for finding the total field of an electrical or magnetic dipole, and correctly located the points of interest, it often failed to execute the procedure of obtaining the total field in a given point (see Fig. 9 for an example). This appears to be due to its difficulty in sustaining and applying a coherent spatial model of the situation, often confusing up and down, left and right, and into and out of the page (see Fig. 10 for an example). This type of difficulty was present in answers to all of the survey items, except items 8, 9, and 10, and in 60% of responses on items 4, 5, 21, 22, 23, 24, 25, 26, 28, 29, and 30, making it the most prevalent type of difficulty in our data.

	<p>[...]### Configuration:</p> <p>We have two charges:</p> <ul style="list-style-type: none"> <li>+q on the left</li> <li>-q on the right</li> </ul> <p>Points to analyze:</p> <ul style="list-style-type: none"> <li>- <b>Location 1</b> is directly to the right of -q</li> <li>- <b>Location 2</b> is directly below the midpoint between +q and -q [...]</li> </ul> <p>[...]### Electric Field at Location 2:</p> <p><b>From +q</b>: The field points away from +q downwards and rightwards.</p> <p><b>From -q</b>: The field points towards -q downwards and leftwards.</p> <p>At location 2, both fields have a vertical component downwards and horizontal components cancel out due to symmetry:</p> <p>Thus, the resultant field is directly downwards (<math>\mathbf{E}</math>). [...]</p>
--	--

Figure 9: Shared image for items 4 and 5 (left) and the relevant parts of ChatGPT-4o's response to item 5, which asks about the direction of the electric field at point 2. Despite the correct description of the image and the superposition principle, the chatbot incorrectly determined the direction of the field contribution of the negative charge, which led to an incorrect final answer.



<p>[...]To determine the direction of the magnetic force that wire 1 exerts on wire 2, we can use the right-hand rule for magnetic forces between parallel currents.</p> <p>1. <b>Right-Hand Rule for Magnetic Field</b>: The direction of the magnetic field created by a current-carrying wire can be found using the right-hand rule. For a wire with current flowing to the left (wire 1), point the thumb of your right hand in the direction of the current, and curl your fingers. Your fingers curl around the wire in the direction of the magnetic field.</p> <p>2. <b>Magnetic Field Around Wire 1</b>: For wire 1 (current <math>I_1</math> flowing to the left), the magnetic field around wire 1 at the location of wire 2 (below wire 1) will be into the page (<math>\otimes</math>). [...]</p>

Figure 10: Image from item 25 (above) and the relevant part of ChatGPT-4o's response (below). The description of the image is correct, and the right-hand rule is stated correctly, but the conclusion is incorrect, implying that the chatbot has difficulties with coordinating its vision and reasoning abilities when applying them to concrete situations.

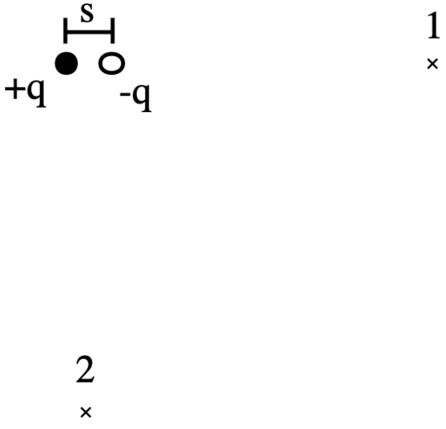

## D. Right-hand rule

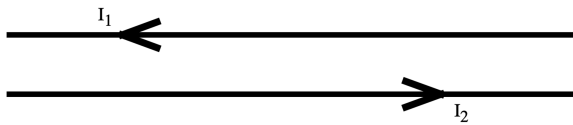
Tasks on which the right-hand rule (RHR) can be used turned out to be especially interesting for our qualitative analysis (items 23-26 and 28-30). The average performance across these tasks was 35%, indicating that they are difficult for the model to solve. Some of these items contained subtasks (steps to solving the problem), each requiring the use of some form of the RHR (items 25, 28, and 29). Throughout the tasks and subtasks where the RHR could be used, it was explicitly invoked and explained in 53% of cases. When the RHR was not explicitly stated by the chatbot, an alternative rule was typically given, such as the cross-product formula connecting the directions of velocity (or current), the magnetic field, and force, or a statement about the magnetic field's direction in a clockwise or counterclockwise current loop.

Of the responses where some form of the RHR was invoked, 9% contained an incorrectly stated RHR, and 41% contained an incorrect implementation of the stated rule (see Fig. 10 for an example).

The chatbot articulated multiple versions of the RHR depending on the task type. Below, we outline these versions, their prevalence, and ChatGPT-4o's success rates.

### 1. RHR for force on charged particle/current carrying wire

This version of the RHR was explicitly stated in 79% of the responses on the four items where it could be used. When explicitly stated, it was correctly stated 95% of the time. However, the chatbot failed to correctly apply it in 70% of these cases, suggesting that it struggles with correctly applying this three-dimensional representation. Notably, humans typically do not perform this task in the "mind's eye," but rather *off-load* it to the body [81,82], using the right hand as an embodied representation for coordinating the graphical representation of the problem and the physics laws in three-dimensional space [83]. Not having a body [84], the chatbot does not have the means for such *off-loading*.

A further intriguing observation is that in some cases, the model of the hand inferred from the chatbot's output was anatomically impossible, as is illustrated in the following quote from one of its responses to item 23:

"Point your fingers to the right (direction of  $v$ ). To get the thumb to point upward (force direction for a positive charge), your fingers would need to curl out of the page."

We also observed that different variants of the RHR for force on a charged particle/current carrying wire were described by the chatbot on repeated iterations of one and the same task. For example, the fingers, thumb and palm did not always stand for the same physics quantity. While in most cases the relative directions of the three quantities were correctly captured by the stated rule, this inconsistency is something that educators should take into account when planning on using ChatGPT-4o in educational contexts, or directing the students to interact with it.

### 2. RHR for a current loop

This version of the RHR relates the direction of the current in a current loop with the resulting magnetic field. It was explicitly stated by the chatbot in 30% of responses on the two items where it could be used. Of these, it was correctly stated 94% of the time. However, more often in the same tasks, the direction of  $B$  was expressed without referring to the hand at all. Instead, the direction of the magnetic field was simply stated to be in or out of the page, depending on whether the current was circulating clockwise or counterclockwise (55% of responses on the two items). ChatGPT-4o was mostly successful applying this rule on tasks where the loop was aligned with the plane of the page, but struggled when it was oriented perpendicularly to the page or shown in perspective view. This is

somewhat similar to the difficulties experienced by students [83], reinforcing the idea that ChatGPT-4o has difficulties applying this three-dimensional representation in concrete tasks.

### 3. *RHR for magnetic field around a current carrying wire*

This version of the RHR was explicitly stated 63% of responses on one item where it could be used. When stated explicitly, it was correct 95% of the time. Similarly to the other versions of the rule, it was applied unsuccessfully in 68% of cases where it was stated correctly (see Fig. 10 for an example). This finding further supports our finding that the ChatGPT-4o has difficulties working with three-dimensional representations and models of physics phenomena.

## VI. DISCUSSION

### A. Instructional implications

The analysis of the performance of ChatGPT-4 and 4o on BEMA revealed persistent difficulties in the visual interpretation of images. While ChatGPT-4o exhibited improvement over ChatGPT-4 – evidenced by the reduced performance gap between the two coding systems – our qualitative analysis shows that difficulties with physics representations still negatively impact its performance and consequently its potential for educational use.

The following are three examples of how the knowledge about the shortcomings of the studied models can inform educational efforts and practices:

1. The visual interpretation difficulties should be taken into account when considering using ChatGPT for assisting students who are blind or have low vision in interpreting tasks that contain images. This is true for both the difficulties that were revealed by the mismatch between the two coding systems, as well as for the difficulties in the interpretation of images containing physics representations. In our view, the prevalence of both types of visual interpretation errors is still too high for the models to be reliable accessibility tools in physics tasks containing graphical representations similar to those on BEMA.
2. The vision shortcomings often caused the chatbot to misinterpret the task and solve it incorrectly. The users should, therefore, be cautious and always critically assess the descriptions of situations on which the chatbot bases its answers.
3. On the other hand, the limited visual abilities can also be leveraged to design assessments that are inherently difficult for ChatGPT (and most likely also other similar LMM-based chatbots) to solve. Tasks that employ multiple representations can be a strategy to reduce the usefulness of chatbots when their use is not desired, such as during exams. Additionally, some characteristic errors made by ChatGPT can also be a telltale sign that it was used in answering a question.

Our qualitative analysis of ChatGPT-4o's difficulties has also revealed that it has difficulties not only in correctly "seeing" images, but also in correctly working with physics representations, even when it correctly visually interprets the input image. Tasks that require spatial coordination of multiple representations appear to be especially difficult for it. This finding suggests limited usability of ChatGPT-4o in personal tutoring applications, where the chatbot would walk a student through a concrete task involving the coordination of several representations.

One representation that was especially difficult for the chatbot to apply was the right-hand rule (RHR). The RHR is an embodied heuristic that allows humans to off-load to the body the spatial cognitive task of cross-multiplying vectors. However, for ChatGPT-4o the RHR does not seem to play the same role. This is not surprising, given that the processing of information by the chatbot happens on the level of language, and does not involve manipulating an actual three-dimensional model of the human hand. For humans, it is mostly trivial to tell where the fingers on one's hand are pointing once the hand is

physically positioned in space. However, ChatGPT-4o seemed to have a lot of difficulties inferring this information from its verbal descriptions of the RHR applied in concrete situations. We have also shown that in some cases, it even implied a model of the hand which is anatomically impossible. A disembodied model thus has difficulties in tasks that involve the use of embodied representations. This finding is relevant not only from a physics instructional perspective – one cannot rely on it in tasks involving the RHR – but also reveals an important underlying limitation of ChatGPT-4o to reason spatially.

We have also found that ChatGPT-4o stated different variants of the RHR, even when solving one and the same task. For example, sometimes the fingers stood for the direction of particle motion, the palm for the direction of the magnetic field, and the thumb for the direction of the force on a positively charged particle. Other times, the thumb stood for the direction of motion, the fingers for the direction of the magnetic field, and the palm for the direction of the force. While the different variants of the RHR were mostly correct, different students could, in the best-case scenario, come away from interacting with ChatGPT-4o with different RHRs. What we believe is more likely, is that students would come away confused about how to use the RHR. Teachers should be aware of the variety of ways in which ChatGPT-4o expresses the RHR and be prepared to assist their students in making sense of its output. In summary, we suggest students should be careful when letting ChatGPT-4o lend them a hand with tasks involving the use of the right-hand rule.

### **B. Limitations and future work**

The improvement in ChatGPT-4o over ChatGPT-4 illustrates the trend of ongoing development of the technology’s abilities. Against this background, our work should be seen as a momentary snapshot and a historical reference point. We have focused our attention only on OpenAI’s LMM-based chatbots, which were previously shown to outperform competitors on multimodal physics tasks [58]. However, we did not test other chatbots on BEMA and cannot compare their performance to that of ChatGPT. This work remains to be done.

Our findings are based on a specific type of assessment – a multiple-choice test on a particular topic. While the range of representations in electricity and magnetism is broad, the findings may not apply to other areas of physics and formats of assessment.

We did not use any specialized prompt-engineering techniques in the attempt to enhance chatbots’ performance. Directed prompting approaches (e.g., instructing the chatbot to describe the images in great detail before solving the accompanying task) may produce better outcomes. The area of prompt engineering in multimodal prompts has not yet received much attention and remains an exciting possible avenue for future work.

While we identified different categories of difficulties, we did not systematically investigate what visual features make an image especially difficult for the chatbot to interpret. To be able to predict which images will cause vision interpretation difficulties, more research is needed. One way of approaching this question is to test the performance of an LMM-based chatbot on image-based tasks, where visual features are deliberately and systematically varied. This applies to the visual features of both physics representations and to any other possible visual design decisions.

## **VII. CONCLUSION**

Our quantitative analysis of OpenAI’s two large multimodal models on BEMA showed that when coded by the selected letter option, ChatGPT-4’s (50.2%) and ChatGPT4o’s (59.8%) average performance across all items is similar to that of the average of a large sample of college students taking a calculus-based introductory course in electricity and magnetism (53.4%). However, we have also seen that both chatbots’ performance is better (60.7% and 67.0%, respectively) when coding their response by the word content of the final answer. The mismatch is mostly due to the difficulties that both versions of ChatGPT exhibit in correctly visually interpreting the area containing different answer options. Our

qualitative analysis of ChatGPT-4o's difficulties on BEMA reveals that in addition to inaccurate visual interpretation, a major difficulty was spatial coordination of different representations and physics principles. We found ChatGPT-4o's use of the right-hand rule to be especially problematic in this respect.

We suggest that educators should be cautious when using ChatGPT-4o for educational purposes especially when extensive use of graphical representations is involved. This includes using it as an accessibility tool for students who are blind or have low vision and in tutoring applications. On the other hand, the identified shortcomings provide opportunities to design chatbot-resistant assessments by leveraging the model's weaknesses in interpreting graphical representations and spatial reasoning.

## REFERENCES

- [1] C. McGrath, A. Farazouli, and T. Cerratto-Pargman, Generative AI chatbots in higher education: a review of an emerging research area, *High Educ* (2024).
- [2] A. M. Bettayeb, M. Abu Talib, A. Z. Sobhe Altayasinah, and F. Dakalbab, Exploring the impact of ChatGPT: conversational AI in education, *Front. Educ.* **9**, (2024).
- [3] S. S. Gill et al., Transformative effects of ChatGPT on modern education: Emerging Era of AI Chatbots, *Internet of Things and Cyber-Physical Systems* **4**, 19 (2024).
- [4] E. Kasneci et al., ChatGPT for good? On opportunities and challenges of large language models for education, *Learning and Individual Differences* **103**, 102274 (2023).
- [5] A. Van Heuvelen, Learning to think like a physicist: A review of research-based instructional strategies, *American Journal of Physics* **59**, 891 (1991).
- [6] E. Euler, E. Rådahl, and B. Gregorcic, Embodiment in physics learning: A social-semiotic look, *Phys. Rev. Phys. Educ. Res.* **15**, 010134 (2019).
- [7] R. E. Scherr, Gesture analysis for physics education researchers, *Phys. Rev. ST Phys. Educ. Res.* **4**, 010101 (2008).
- [8] G. Kortemeyer, *Tailoring Chatbots for Higher Education: Some Insights and Experiences*, arXiv:2409.06717.
- [9] G. Kortemeyer, Ethel: A virtual teaching assistant, *The Physics Teacher* **62**, 698 (2024).
- [10] S. Shetye, An Evaluation of Khanmigo, a Generative AI Tool, as a Computer-Assisted Language Learning App, *Studies in Applied Linguistics and TESOL* **24**, 1 (2024).
- [11] S. Steinert, K. E. Avila, J. Kuhn, and S. Küchemann, Using GPT-4 as a guide during inquiry-based learning, *The Physics Teacher* **62**, 618 (2024).
- [12] G. Polverini and B. Gregorcic, Performance of ChatGPT on the test of understanding graphs in kinematics, *Phys. Rev. Phys. Educ. Res.* **20**, 010109 (2024).
- [13] L. Ding, R. Chabay, B. Sherwood, and R. Beichner, Evaluating an electricity and magnetism assessment tool: Brief electricity and magnetism assessment, *Phys. Rev. ST Phys. Educ. Res.* **2**, 010105 (2006).
- [14] C. Wheatley, J. Wells, and J. Stewart, Applying module analysis to the Brief Electricity and Magnetism Assessment, *Phys. Rev. Phys. Educ. Res.* **20**, 010104 (2024).
- [15] G. Kortemeyer, Could an Artificial-Intelligence agent pass an introductory physics course?, *Phys. Rev. Phys. Educ. Res.* **19**, 010132 (2023).
- [16] C. G. West, *AI and the FCI: Can ChatGPT Project an Understanding of Introductory Physics?*, arXiv:2303.01067.
- [17] C. G. West, *Advances in Apparent Conceptual Physics Reasoning in GPT-4*, arXiv:2303.17012.
- [18] S. Wheeler and R. E. Scherr, *ChatGPT Reflects Student Misconceptions in Physics*, in *2023 Physics Education Research Conference Proceedings* (American Association of Physics Teachers, Sacramento, CA, 2023), pp. 386–390.
- [19] F. Kieser, P. Wulff, J. Kuhn, and S. Küchemann, Educational data augmentation in physics education research using ChatGPT, *Phys. Rev. Phys. Educ. Res.* **19**, 020150 (2023).
- [20] B. Gregorcic and A.-M. Pendrill, ChatGPT and the frustrated Socrates, *Phys. Educ.* **58**, 035021 (2023).

- [21] A. Sirnoorkar, D. Zollman, J. T. Lavery, A. J. Magana, S. Rebello, and L. A. Bryan, *Student and AI Responses to Physics Problems Examined through the Lenses of Sensemaking and Mechanistic Reasoning*, arXiv:2401.00627.
- [22] W. Yeadon, O.-O. Inyang, A. Mizouri, A. Peach, and C. P. Testrow, The death of the short-form physics essay in the coming AI revolution, *Phys. Educ.* **58**, 035027 (2023).
- [23] W. Yeadon, E. Agra, O.-O. Inyang, P. Mackay, and A. Mizouri, Evaluating AI and human authorship quality in academic writing through physics essays, *Eur. J. Phys.* **45**, 055703 (2024).
- [24] W. Yeadon, A. Peach, and C. Testrow, A comparison of human, GPT-3.5, and GPT-4 performance in a university-level coding course, *Sci Rep* **14**, 23285 (2024).
- [25] A. Low and Z. Y. Kalender, *Data Dialogue with ChatGPT: Using Code Interpreter to Simulate and Analyse Experimental Data*, arXiv:2311.12415.
- [26] W. Yeadon and T. Hardy, The impact of AI in physics education: a comprehensive review from GCSE to university levels, *Phys. Educ.* **59**, 025010 (2024).
- [27] M. Frenkel and H. Emara, *ChatGPT & Mechanical Engineering: Examining Performance on the FE Mechanical Engineering and Undergraduate Exams*, arXiv:2309.15866.
- [28] K. D. Wang, E. Burkholder, C. Wieman, S. Salehi, and N. Haber, Examining the potential and pitfalls of ChatGPT in science and engineering problem-solving, *Front. Educ.* **8**, (2024).
- [29] T. Kumar and M. A. Kats, ChatGPT-4 with Code Interpreter can be used to solve introductory college-level vector calculus and electromagnetism problems, *American Journal of Physics* **91**, 955 (2023).
- [30] P. Bitzenbauer, ChatGPT in physics education: A pilot study on easy-to-implement activities, *Cont Ed Technology* **15**, ep430 (2023).
- [31] M. N. Dahlkemper, S. Z. Lahme, and P. Klein, How do physics students evaluate artificial intelligence responses on comprehension questions? A study on the perceived scientific accuracy and linguistic quality of ChatGPT, *Phys. Rev. Phys. Educ. Res.* **19**, 010142 (2023).
- [32] M. A. R. Vasconcelos and R. P. Dos Santos, Enhancing STEM learning with ChatGPT and Bing Chat as objects to think with: A case study, *EURASIA J Math Sci Tech Ed* **19**, em2296 (2023).
- [33] S. Küchemann, S. Steinert, N. Revenga, M. Schweinberger, Y. Dinc, K. E. Avila, and J. Kuhn, Can ChatGPT support prospective teachers in physics task development?, *Phys. Rev. Phys. Educ. Res.* **19**, 020128 (2023).
- [34] B. Gregorcic, G. Polverini, and A. Sarlah, ChatGPT as a tool for honing teachers' Socratic dialogue skills, *Phys. Educ.* **59**, 045005 (2024).
- [35] L. Ding, T. Li, S. Jiang, and A. Gapud, Students' perceptions of using ChatGPT in a physics class as a virtual tutor, *Int J Educ Technol High Educ* **20**, 63 (2023).
- [36] A. Shoufan, Exploring Students' Perceptions of ChatGPT: Thematic Analysis and Follow-Up Survey, *IEEE Access* **11**, 38805 (2023).
- [37] H. Jang and H. Choi, A Double-Edged Sword: Physics Educators' Perspectives on Utilizing ChatGPT and Its Future in Classrooms, *J Sci Educ Technol* (2024).
- [38] M. F. Rezende Junior and V. López-Simó, What are the perceptions of physics teachers in Brazil about ChatGPT in school activities?, *J. Phys.: Conf. Ser.* **2693**, 012011 (2024).
- [39] G. Polverini and B. Gregorcic, How understanding large language models can inform the use of ChatGPT in physics education, *Eur. J. Phys.* **45**, 025701 (2024).
- [40] L. Krupp, S. Steinert, M. Kiefer-Emmanouilidis, K. E. Avila, P. Lukowicz, J. Kuhn, S. Küchemann, and J. Karolus, *Unreflected Acceptance -- Investigating the Negative Consequences of ChatGPT-Assisted Problem Solving in Physics Education*, arXiv:2309.03087.
- [41] I. O. Gallegos, R. A. Rossi, J. Barrow, M. M. Tanjim, S. Kim, F. Derroncourt, T. Yu, R. Zhang, and N. K. Ahmed, *Bias and Fairness in Large Language Models: A Survey*, arXiv:2309.00770.
- [42] M. Perkins and J. Roe, Decoding Academic Integrity Policies: A Corpus Linguistics Investigation of AI and Other Technological Threats, *High Educ Policy* **37**, 633 (2024).
- [43] M. Al-kfairy, D. Mustafa, N. Kshetri, M. Insiew, and O. Alfandi, Ethical Challenges and Solutions of Generative AI: An Interdisciplinary Perspective, *Informatics* **11**, 58 (2024).
- [44] R. T. Williams, The ethical implications of using generative chatbots in higher education, *Front. Educ.* **8**, 1331607 (2024).
- [45] *GPT-4o (Omni) Math Tutoring Demo on Khan Academy*, [https://www.youtube.com/watch?v=ivxxzocyu\\_m](https://www.youtube.com/watch?v=ivxxzocyu_m) (2024).

- [46] *Math & Physics with AI | Gemini*, <https://www.youtube.com/watch?v=k4px1vaxaai> (2023).
- [47] L. Krupp et al., *LLM-Generated Tips Rival Expert-Created Tips in Helping Students Answer Quantum-Computing Questions*, arXiv:2407.17024.
- [48] G. Kortemeyer, J. Nöhl, and D. Onishchuk, Grading assistance for a handwritten thermodynamics exam using artificial intelligence: An exploratory study, *Phys. Rev. Phys. Educ. Res.* **20**, 020144 (2024).
- [49] R. Mok, F. Akhtar, L. Clare, C. Li, J. Ida, L. Ross, and M. Campanelli, *Using AI Large Language Models for Grading in Education: A Hands-On Test for Physics*, arXiv:2411.13685.
- [50] S. Guo, E. Latif, Y. Zhou, X. Huang, and X. Zhai, *Using Generative AI and Multi-Agents to Provide Automatic Feedback*, arXiv:2411.07407.
- [51] C. Mulryan-Kyne, Teaching large classes at college and university level: challenges and opportunities, *Teaching in Higher Education* **15**, 175 (2010).
- [52] G. Kestin, K. Miller, A. Klales, T. Milbourne, and G. Ponti, *AI Tutoring Outperforms Active Learning*, 10.21203/rs.3.rs-4243877/v1.
- [53] S. El-Adawy, A. MacDonagh, and M. Abdelhafez, *Exploring Large Language Models as Formative Feedback Tools in Physics*, in *2024 Physics Education Research Conference Proceedings* (American Association of Physics Teachers, Boston, MA, 2024), pp. 126–131.
- [54] G. Kortemeyer and J. Nöhl, *Assessing Confidence in AI-Assisted Grading of Physics Exams through Psychometrics: An Exploratory Study*, arXiv:2410.19409.
- [55] R. Bhayana, *Chatbots and Large Language Models in Radiology: A Practical Primer for Clinical and Research Applications*, *Radiology* **310**, e232756 (2024).
- [56] A. Mihalache et al., *Interpretation of Clinical Retinal Images Using an Artificial Intelligence Chatbot*, *Ophthalmology Science* **4**, 100556 (2024).
- [57] B. Graefen and N. Fazal, *Chat bots to Virtual Tutors: An Overview of Chat GPT’s Role in the Future of Education*, *Arch Pharm Pract* **15**, 43 (2024).
- [58] G. Polverini and B. Gregorcic, *Evaluating vision-capable chatbots in interpreting kinematics graphs: a comparative study of free and subscription-based models*, *Front. Educ.* **9**, 1452414 (2024).
- [59] G. Polverini and B. Gregorcic, *Performance of Freely Available Vision-Capable Chatbots on the Test for Understanding Graphs in Kinematics*, in *2024 Physics Education Research Conference Proceedings* (American Association of Physics Teachers, Boston, MA, 2024), pp. 336–341.
- [60] S. Aldazarova, G. Issayeva, S. Maxutov, and N. Balta, *Assessing AI’s problem solving in physics: Analyzing reasoning, false positives and negatives through the force concept inventory*, *Cont Ed Technology* **16**, ep538 (2024).
- [61] K. A. Pimblet and L. Morrell, *Can ChatGPT pass a physics degree? Making a case for reformation of assessment of undergraduate degrees*, *Eur. J. Phys.* (2024).
- [62] Y. He, W. Yang, Y. Zheng, Y. Chen, W. Liu, and J. Wang, *Interpreting graphs using large language models in a middle school physics class*, *The Physics Teacher* **62**, 794 (2024).
- [63] S. Suhonen, *Navigating the AI Era: Analyzing the Impact of Artificial Intelligence on Learning and Teaching Engineering Physics*, in *Proceedings of the 12th International Conference on Physics Teaching in Engineering Education PTEE 2024*, edited by C. Schäfle, S. Stanzel, E. Junker, and C. Lux (2024), pp. 76–83.
- [64] T. Kojima, S. S. Gu, M. Reid, Y. Matsuo, and Y. Iwasawa, *Large Language Models Are Zero-Shot Reasoners*, arXiv:2205.11916.
- [65] J. Wei, X. Wang, D. Schuurmans, M. Bosma, B. Ichter, F. Xia, E. Chi, Q. Le, and D. Zhou, *Chain-of-Thought Prompting Elicits Reasoning in Large Language Models*, arXiv:2201.11903.
- [66] I. Mirzadeh, K. Alizadeh, H. Shahrokhi, O. Tuzel, S. Bengio, and M. Farajtabar, *GSM-Symbolic: Understanding the Limitations of Mathematical Reasoning in Large Language Models*, arXiv:2410.05229.
- [67] J. Airey and C. Linder, *A disciplinary discourse perspective on university science learning: Achieving fluency in a critical constellation of modes*, *Journal of Research in Science Teaching* **46**, 27 (2009).
- [68] P. B. Kohl and N. D. Finkelstein, *Effects of representation on students solving physics problems: A fine-grained characterization*, *Phys. Rev. ST Phys. Educ. Res.* **2**, 010106 (2006).

- [69] P. B. Kohl and N. D. Finkelstein, Patterns of multiple representation use by experts and novices during physics problem solving, *Phys. Rev. ST Phys. Educ. Res.* **4**, 010111 (2008).
- [70] S. B. McKagan, K. K. Perkins, and C. E. Wieman, Why we should teach the Bohr model and how to teach it effectively, *Phys. Rev. ST Phys. Educ. Res.* **4**, 010103 (2008).
- [71] J. Airey and C. Linder, *Social Semiotics in University Physics Education*, in *Multiple Representations in Physics Education*, edited by D. F. Treagust, R. Duit, and H. E. Fischer (Springer International Publishing, Cham, 2017), pp. 95–122.
- [72] D. F. Treagust, R. Duit, and H. E. Fischer, editors, *Multiple Representations in Physics Education*, Vol. 10 (Springer International Publishing, Cham, 2017).
- [73] B. Gregorcic, G. Planinsic, and E. Etkina, Doing science by waving hands: Talk, symbiotic gesture, and interaction with digital content as resources in student inquiry, *Phys. Rev. Phys. Educ. Res.* **13**, 020104 (2017).
- [74] W. Roth, From gesture to scientific language, *Journal of Pragmatics* **32**, 1683 (2000).
- [75] S. M. Scheuneman, V. J. Flood, and B. W. Harrer, *Characterizing Representational Gestures in Collaborative Sense-Making of Vectors in Introductory Physics*, in *2023 Physics Education Research Conference Proceedings* (American Association of Physics Teachers, Sacramento, CA, 2023), pp. 290–295.
- [76] PhysPort, *PhysPort Assessments: Brief Electricity and Magnetism Assessment*, <https://www.physport.org/assessments/assessment.cfm?A=BEMA>.
- [77] R. Chabay and B. Sherwood, Restructuring the introductory electricity and magnetism course, *American Journal of Physics* **74**, 329 (2006).
- [78] M. A. Kohlmyer, M. D. Caballero, R. Catrambone, R. W. Chabay, L. Ding, M. P. Haugan, M. J. Marr, B. A. Sherwood, and M. F. Schatz, Tale of two curricula: The performance of 2000 students in introductory electromagnetism, *Phys. Rev. ST Phys. Educ. Res.* **5**, 020105 (2009).
- [79] S. J. Pollock, Longitudinal study of student conceptual understanding in electricity and magnetism, *Phys. Rev. ST Phys. Educ. Res.* **5**, 020110 (2009).
- [80] G. Polverini, J. Melin, E. Önerud, and B. Gregorcic, *ChatGPT-4 and ChatGPT-4o Responses to Brief Electricity and Magnetism Assessment (BEMA), April & May 2024*, <https://doi.org/10.5281/zenodo.14354325>.
- [81] S. Goldin-Meadow, *Hearing Gesture: How Our Hands Help Us Think* (Harvard University Press, 2005).
- [82] M. Wilson, Six views of embodied cognition, *Psychonomic Bulletin & Review* **9**, 625 (2002).
- [83] M. B. Kustusich, Assessing the impact of representational and contextual problem features on student use of right-hand rules, *Phys. Rev. Phys. Educ. Res.* **12**, 010102 (2016).
- [84] A. Chemero, LLMs differ from human cognition because they are not embodied, *Nat Hum Behav* **7**, 1828 (2023).