

# Automatic Prediction of Stroke Treatment Outcomes: Latest Advances and Perspectives

Zeynel A. Samak<sup>1\*</sup>, Philip Clatworthy<sup>3,4</sup> and Majid Mirmehdi<sup>2</sup>

<sup>1</sup>\*Department of Computer Engineering, Adiyaman University, Adiyaman, 02040, Türkiye.

<sup>2</sup>School of Computer Science, University of Bristol, Bristol, BS8 1UB, UK.

<sup>3</sup>Translational Health Sciences, University of Bristol, Bristol, BS8 1UD, UK.

<sup>4</sup>Stroke Neurology, Southmead Hospital, North Bristol NHS Trust, Street, Bristol, BS8 1UD, UK.

\*Corresponding author(s). E-mail(s): [zsamak@adiyaman.edu.tr](mailto:zsamak@adiyaman.edu.tr);

Contributing authors: [phil.clatworthy@bristol.ac.uk](mailto:phil.clatworthy@bristol.ac.uk);

[m.mirmehdi@bristol.ac.uk](mailto:m.mirmehdi@bristol.ac.uk);

## Abstract

Stroke is a major global health problem that causes mortality and morbidity. Predicting the outcomes of stroke intervention can facilitate clinical decision-making and improve patient care. Engaging and developing deep learning techniques can help to analyse large and diverse medical data, including brain scans, medical reports and other sensor information, such as EEG, ECG, EMG and so on. Despite the common data standardisation challenge within medical image analysis domain, the future of deep learning in stroke outcome prediction lie in using multimodal information, including final infarct data, to achieve better prediction of long-term functional outcomes. This article provides a broad review of recent advances and applications of deep learning in the prediction of stroke outcomes, including (i) the data and models used, (ii) the prediction tasks and measures of success, (iii) the current challenges and limitations, and (iv) future directions and potential benefits. This comprehensive review aims to provide researchers, clinicians, and policy makers with an up-to-date understanding of this rapidly evolving and promising field.

**Keywords:** stroke , outcome prediction , treatment outcome , functional outcome , final infarct , deep learning , medical image analysis

# 1 Introduction

A stroke is a critical medical event that occurs when the blood supply to the brain is interrupted. This disrupts oxygen delivery, leading to tissue damage and neurological impairment. The lack of blood and oxygen damages brain cells, ultimately causing neuronal death. This can lead to permanent brain damage, long-term functional disability or even death. Several key factors increase the risk of stroke, including high blood pressure, diabetes, high cholesterol, smoking, heart disease, obesity and a family history of stroke. Age, gender and ethnicity can also contribute [1].

Stroke is the second leading cause of death and the third leading cause of disability worldwide, affecting approximately 15 million people annually [2], according to the World Health Organization [3]. The well-known phrase "time is brain" [4] highlights the critical importance of acting quickly in the assessment and treatment of stroke. Delays in treatment can lead to brain cell death from lack of blood flow and oxygen, and research suggests that approximately two million neurons die every minute an ischaemic stroke goes untreated [4]. A comprehensive analysis of registry data revealed that each minute delay in intravenous thrombolysis administration increases the risk of early post-treatment intracerebral hemorrhage, disability, and mortality [5]. Clinicians therefore aim to rapidly use all available data sources, including imaging and clinical information, to determine the most appropriate treatment option as quickly as possible.

The outcome for stroke patients is influenced by a number of factors, including the type, location and size of the stroke, the time elapsed before treatment and the rehabilitation interventions received [6]. Despite significant advances in understanding the mechanisms of stroke and developing effective treatments, like thrombectomy (mechanically removing blood clots, Endovascular Therapy (EVT)) and thrombolysis (dissolving blood clots with medication), predicting patient outcomes and selecting the most appropriate treatment remains challenging because it involves complex interactions between multiple variables that may change over time [7]. Consequently, developing an automated tool that uses available imaging and patient information to predict treatment outcomes would improve clinical decision-making and improve the efficacy of ischaemic stroke treatment.

The early prediction of stroke outcome and delivery of the appropriate treatment is critical since the ischaemic penumbra, the region of brain tissue surrounding the infarct that can still be saved, has a limited window for successful intervention [8]. To address this, researchers categorise stroke analysis into distinct phases and tasks (see also Figure 1) to guide treatment decisions [9, 10]. The initial assessment occurs upon hospital admission to identify brain tissue damage. Subsequent analyses are conducted to evaluate how the tissue is changing in response to treatment and determine longer-term functional outcomes, typically within the first week and at three months. Importantly, all predictions within these time-frames must be made after the initial hospital admission scan to help clinicians choose the most appropriate course of treatment.

To make accurate predictions within these time-frames, researchers use a variety of data sources: brain imaging techniques such as Computed Tomography (CT) scans (used for rapid stroke assessment), Magnetic Resonance Imaging (MRI) (providing

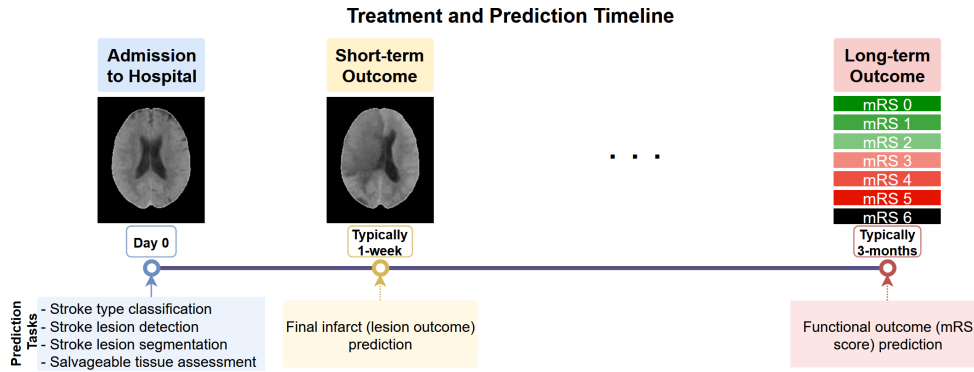

**Fig. 1** Analysis of stroke time frames and the predicted tasks at each time point. These predictions are based on initial scans performed upon hospital admission to aid physicians in their clinical decision-making process.

detailed anatomical information) and clinical data including patient demographics, blood biomarkers and neurological scores. Given the requirement of quick reactions to determine diagnosis and perform corrective procedures, clinical and radiological *reports* are either not available or feature less in such situations. Hence, there is also a lack of such data for researchers to apply today’s enhanced language models [11, 12] for outcome predictions. However, this is an important area which has scope for development.

Early attempts to automate stroke analysis relied on basic techniques such as thresholding and standard statistical methods. These methods included correlation-based analysis [13, 14], region growing [14, 15], and classical Machine Learning (ML) algorithms such as Random Forest (RF) [16, 17] and Support Vector Machine (SVM) [18]. In recent years, ML and Deep Learning (DL) methods have gained significant popularity due to their effectiveness in various image analysis tasks, such as object detection [19, 20], image segmentation [21, 22], and classification [23, 24]. DL, in particular via Convolutional Neural Network (CNN) [25–27] and recently Transformers [28–30], has been widely applied to medical image analysis tasks with superior results, including automated ischaemic stroke lesion classification [31, 32], detection/segmentation [25, 27] and prognosis [33–35]. Most Stroke Outcome Prediction (SOP) studies have focused on either predicting the final lesions or predicting functional outcome at 90-days. While Ernst et al. [36] demonstrated the 1-week follow-up scan containing final lesions has a positive impact on predicting the functional outcome, few studies have investigated integrating the final lesion and functional outcome prediction tasks [35, 37].

Several previous review papers (summarised in Table 1) have investigated the application of ML and DL techniques in the domain of brain stroke. While these prior reviews have comprehensively addressed stroke classification [38, 39], detection [8, 9], and segmentation [8, 42] and many have focused on classical ML methods [38, 39, 41], the application and progress of DL in SOP has not been coalesced and categorised.

**Table 1:** Recent review/survey articles that included Stroke Outcome Prediction (SOP), their coverage, topics reviewed, total number of papers reviewed, including total number of articles related to SOP.

Study	Year	Coverage	Reviewed Topics	#Papers	#DL in SOP
Sirsat et al. [38]	2020	2007-2019	ML in stroke identification, diagnosis, treatment & prognostication	39	1
Karthik et al. [8]	2020	to 2020	Stroke lesion detection and segmentation	113	7
Inamdar et al. [9]	2021	2010-2021	Detection and lesion segmentation of neuroimage	117	7
Mainali et al. [39]	2021	to 2021	ML in stroke diagnosis and outcome prediction	54	3
Zeng et al. [10]	2022	to early 2022	Functional outcome, reperfusion, and hemorrhagic transformation	16	4
Kremers et al. [40]	2022	to mid-2020	Functional Outcome after EVT and using MR CLEAN dataset	19	2
Wang et al. [41]	2022	to mid-2022	ML algorithms for final infarct prediction	11	7
Hilbert et al. [42]	2022	to mid-2022	AI applied in stroke decision support	65	11
<b>Our Review</b>	<b>2024</b>	<b>2015-2024</b>	<b>DL in SOP (final infarct &amp; functional outcome)</b>	<b>60</b>	<b>60</b>

In this paper, we present an overview of the different DL approaches that have been applied to predict the outcome of stroke treatment as the final lesion and functional outcome using only imaging and multimodal data. We discuss the strengths and limitations of these techniques and critically evaluate the current state of the field, identifying gaps and areas that require further investigation to improve the precision and reliability of SOP. Additionally, we consider the public datasets that are available for SOP applications, as well as list the works for which code (see Appendix A) and data are available.

The rest of paper is structured as follows. In Section 2, we consider existing, relevant datasets and score measures for stroke outcome prediction. Section 3 reviews articles in SOP using DL methods under two categories: final infarct and functional outcome prediction. In the Discussion in Section 4, we present our key observations and review current limitations. Then, in Section 5, we suggest avenues of further exploration for future directions of research for more efficient stroke outcome prediction. Finally, Section 6 concludes the paper.

## 2 Datasets & Scores

Publicly available datasets are scarce within the SOP domain, hence some studies use their own in-house collections. Table 2 lists only datasets that have been used in at least two studies of SOP research. While access to most of these datasets requires application and approval, the Ischemic Stroke Lesion Segmentation (ISLES) 2017 [43] dataset, released for a challenge at the MICCAI<sup>1</sup> conference, stands out as a publicly available resource, providing valuable data for developing SOP models and benchmarking for predicting stroke lesion outcome using MRI data.

The ISLES 2017 [43] dataset comprises MRI diffusion maps (Diffusion-weighted MRI (DWI), Apparent Diffusion Coefficient (ADC)) and perfusion maps (Cerebral Blood Volume (CBV), Cerebral Blood Flow (CBF), Mean Transit Time (MTT), Time To Peak (TTP), Time-to-Maximum (Tmax)) as well as clinical details, such as time since stroke onset, time to treatment, Thrombolysis in Cerebral Infarction (TICI) score, and modified Rankin Scale (mRS) score. Additionally, ground truth labels

<sup>1</sup>International Conference on Medical Image Computing and Computer Assisted Intervention - <https://miccai.org/>

**Table 2:** Chronological overview of datasets used for SOP. "On request" indicates that access to associated dataset is subject to a formal application process. N/A means that corresponding information was not available. \* First cohort of the registry.

Study	Year	Availability	Image Modality	Patients	Final Infarct	Functional Outcome	Articles Used
I-KNOW [44, 45]	2009	N/A	MRI	168	✓	✓	4
DEFUSE-2 [46]	2012	On Request	MRI	104	✓	✓	3
HERMES [47]	2016	On Request	NCCT,CTA	1287	✗	✓	2
ISLES 2017 [43]	2017	Public	MRI Sequences	75	✓	✗	6
CRISP [48]	2017	N/A	CTP	190	✓	✓	3
iCAS [49]	2019	On Request	CBF	77	✗	✓	3
ERASER [50]	2019	On Request	NCCT,CTP	80	✓	✓	4
MR CLEAN							
Trial [51]	2015	On Request	NCCT,CTA	500	✗	✓	5
Registry [52]	2018	Private	NCCT,CTA	1488*	✗	✓	2
NO IV [53]	2021	On Request	NCCT,CTA, DWI	539	✗	✓	1
HIBISCUS-STROKE [54]	Ongoing	On Request	MRI, CT	164	✓	✓	2

include segmentation maps acquired from follow-up stroke imaging are also available. The training dataset consists of 43 patients, with results assessed on a separate test set of 32 stroke patients.

The Highly Effective Reperfusion Evaluated in Multiple Endovascular Stroke Trials (HERMES) [47] collaboration was established to combine patient-level data from five key trials (MR CLEAN [51], ESCAPE [55], REVASCAT [56], SWIFT PRIME [57], and EXTEND IA [58]) totalling 1287 patients, admitted between late 2010 and late 2014 . The trial investigators aimed to answer outstanding questions about the effectiveness of thrombectomy in different groups of patients with large-vessel ischaemic stroke. The primary outcome of the trial was functional outcome at 90 days.

The Multicenter Randomized Clinical trial of Endovascular treatment for Acute ischemic stroke in the Netherlands (MR CLEAN) [51] dataset was collected as part of a randomised clinical trial that compared intra-arterial treatment to usual care for patients with proximal arterial occlusion in the anterior circulation, and includes data from 500 patients treated at 16 medical centres in the Netherlands. The dataset includes a baseline (*i.e.* the first scan when the patient was admitted to the hospital) Non-contrast Computed Tomography (NCCT) and CT Angiography (CTA) , 24-hour follow-up NCCT and CTA scans, and additionally a 1-week follow-up NCCT scan. Additionally, MR CLEAN contains clinical metadata information such as patient demographics (age, gender), medical history and stroke scores (*e.g.* National Institutes of Health Stroke Scale (NIHSS)), imaging biomarkers (*e.g.* Alberta Stroke Programme Early CT Score (ASPECTS)) and outcome data mRS.

**mRS Score** – the mRS score is used to assess the success rate and functional outcome of stroke treatment [59, 60] and is based on the degree of disability at 90 days after a patient received stroke treatment. It is assessed by an independent observer and scored on a standardised scale as seen in Table 3. Initially, mRS was a 5-point scale ranging from 1 to 5 [59], later becoming a 6-level scale by adding 0 for patients with no symptoms [60], and recently mRS has become a 7-point scale that varies from 0 (no symptoms) to 6 (death of patient) [61]. A mRS score between 0-2 indicates a good

outcome, characterised by functional independence, which means that a patient is able to perform daily activities without requiring assistance from another person. This also means they were favourable to treatment and that the treatment was successful. On the other hand, a mRS score between 3-6 represents a bad outcome and functional dependence.

**Table 3:** The modified Rankin Score - a basic explanation of each mRS score.

Score	Grade of Disability
0	No symptoms at all
1	No significant disability despite symptoms; able to carry out all usual duties and activities
2	Slight disability; unable to carry out all previous activities, but able to look after own affairs
3	Moderate disability; requires some help, but able to walk without assistance
4	Moderately severe disability; unable to walk and to attend to own bodily needs without assistance
5	Severe disability; bedridden, incontinent and requiring constant nursing care and attention
6	Dead

**National Institutes of Health Stroke Scale (NIHSS)** – the NIHSS is a standardised tool used by healthcare professionals to assess the severity of stroke by way of a 15-item examination that assesses a patient’s level of consciousness, speech, motor skills, vision, balance and sensory function. Each item is scored between 0 (normal) and a maximum depending on the specific function (e.g. 4 for worst motor strength), with higher total scores (0-42) indicating greater stroke severity. This score is used to guide treatment decisions, such as clot-busting medication or clot removal surgery, and to monitor a patient’s recovery. Importantly, the effectiveness of the NIHSS may be limited by the patient’s level of cooperation. As the scale relies on the patient’s ability to follow instructions and communicate, those with stroke-related impairments or pre-existing neurological conditions may not be accurately assessed on arrival at hospital or during subsequent assessments.

**Thrombolysis in Cerebral Infarction (TICI)** – the TICI scale provides a standardised method for grading blood vessel re-opening using digital subtraction angiography (DSA) imaging in interventional radiology following stroke treatment, particularly thrombectomy. This scale, ranging from 0 (no flow) to 3 (complete reperfusion), allows doctors to assess the success of clot removal based on the observed blood flow patterns. Higher scores ( 2b and 3) indicate a successful procedure and a greater likelihood of positive patient outcomes.

**Alberta Stroke Programme Early CT Score (ASPECTS)** – the ASPECTS score is a widely used tool for assessing the extent of early ischaemic changes in patients with Acute Ischaemic Stroke (AIS). This score is derived from NCCT scans and quantifies the volume of brain tissue affected by ischaemia. The score is determined by the presence or absence of ischaemic changes in specific brain regions, scales from 0 to 10. Higher score correlates with better functional outcomes, making it useful information for predicting immediate treatment response and short-term prognosis [62–64]. However, it is important to note that the primary purpose of ASPECTS is to evaluate initial brain damage and inform immediate treatment decisions, rather than evaluating long-term treatment effectiveness like mRS [65, 66].

### 3 Deep Learning for Stroke Outcome Prediction

In recent decades, a variety of techniques, from image thresholding [13] to DL [25, 31, 32], have been utilised for stroke lesion detection, segmentation, and classification. However, the focus has shifted now beyond segmenting lesions to using all available information to specifically predict stroke treatment outcomes [26, 34, 35].

Previous research on predicting treatment outcomes using patient imaging and/or clinical data concentrates on two main areas: (1) the evolution and final appearance of stroke lesion volume and (2) the prediction of mRS scores. This section reviews and summarises key contributions, methods, and applications from previous studies, categorised by their *prediction target* (lesion and functional outcome) and *data type* (imaging only and imaging with clinical information) used for estimating stroke treatment outcomes. Thus next, Section 3.1 addresses studies that assess stroke treatment success by predicting the final lesion and Section 3.2 then reviews studies that predict functional outcomes, mRS scores after stroke treatment.

#### 3.1 Final Infarct Prediction

This section focuses on predicting stroke treatment outcomes by estimating the final appearance of the stroke lesion on follow-up scans. While follow-up scans can be acquired within a broad time frame ranging from 1 hour to 90 days [41, 71, 91], most studies generally adopt a time point of one week (5-7 days) [76, 86, 87, 92, 93]. Researchers have mainly addressed this task by developing models trained on datasets of expert-annotated follow-up scans. These models analyse a patient’s initial scan and predict the final lesion segmentation map, which is essentially a visual representation of the extent of the stroke. This information provides physicians with a valuable tool to develop more effective treatment plans. Throughout this article, the terms “final infarct”, “tissue fate”, “follow-up lesion” and “final lesion” are used interchangeably to mean the same outcome and to remain consistent with terms used in the community.

An overview of various studies examined for final infarct prediction is presented in Table 4. Advanced imaging techniques, such as DWI, Perfusion-weighted Imaging (PWI), and CT Perfusion (CTP) provide valuable information to assess tissue viability and predict stroke outcomes. DL models have emerged as powerful tools in this domain, leveraging the ability to extract complex patterns and relationships from high-dimensional imaging data. Studies in this area have mainly used U-Net-like CNN network architectures and incorporated different training strategies and modules such as multi-scale input [54, 71], ensemble learning [68, 81], transformer [84] and attention modules [87, 88].

Stier et al. [67] presented a deep learning model trained on randomly sampled local patches extracted from Tmax feature maps of MRI scans acquired immediately after symptom onset. Their approach outperformed traditional single-voxel regression models, such as [94], in predicting tissue survival outcomes in acute ischaemic stroke patients. Similarly, Nielsen et al. [69] developed a generalised linear model, a shallow CNN and a deep CNN based on the SegNet [95] model, trained on MRI-based perfusion maps of 222 patients. Their results demonstrated that the deep CNN model outperformed other models in predicting final infarct volumes.

**Table 4: Overview of the studies that perform final infarct prediction as stroke treatment outcome.** Abbreviations are: Ischaemic Stroke (IS), Acute Ischaemic Stroke (AIS), Middle Cerebral Artery (MCA), Large Vessel Occlusion (LVO), Endovascular Therapy (EVT), recombinant tissue-type Plasminogen Activator (rtPA), tissue Plasminogen Activator (tPA), Convolutional Neural Network (CNN), Convolutional Auto Encoder (CAE), Conditional Generative Adversarial Network (CGAN), Principal Component Analysis (PCA), Restricted Boltzmann Machines (RBM), Magnetic Resonance Imaging (MRI), Time-to-Maximum (Tmax), CT Perfusion (CTP), Diffusion-weighted MRI (DWI), Perfusion-weighted Imaging (PWI), Fluid-attenuated Inversion Recover (FLAIR), Computed Tomography (CT), Non-contrast Computed Tomography (NCCT), CT Angiography (CTA), Apparent Diffusion Coefficient (ADC), Leave-One-Out Cross-Validation (LOOCV), Cross-Validation (cv), Area Under the Curve (AUC), Dice Similarity Coefficient (DSC), Intra-class Correlation Coefficient (ICC), Not Reported (N/R). \* indicates that the code used in the study is available.

Study	Year	Patient Subgroup	Treatment Type	Method	Input Modality	Number of Patients	Data Split	Best Result
Stier et al. [67]	2015	AIS	EVT	CNN	MRI, Tmax	19	LOOCV	AUC: 0.86
Choi et al. [68]	2016	AIS	N/R	U-Net	MRI Sequences	49	19 test cases	AUC: 0.74 DSC: 0.57
Nielsen et al. [69]	2018	AIS	rtPA	CNN	MRI	222	85:15	AUC: 0.88
Lucas et al. [70]*	2018	AIS	EVT	U-Net + CAE	CTP	29	5-fold cv	DSC: 0.46
Pinto et al. [71]	2018	AIS	EVT	multi U-Net + GRU	DWI PWI	75	32 test cases	DSC: 0.29
Ho et al. [72]	2019	MCA	EVT	CNN	MRI, PWI FLAIR	48	10-fold cv	AUC: 0.871
Debs et al. [73]	2019	Anterior circulation	tPA	CNN	Synthetic PWI	100 simulations	8 test cases	DSC: 0.45
Barros et al. [74]	2019	AIS	EVT	CNN	CT	1026	396 test cases	ICC: 0.88 DSC: 0.57
Debs et al. [75]	2020	Anterior circulation	tPA	CNN	PWI	125000 patches	8 test cases	DSC: 0.40
Yu et al. [76]	2020	Anterior circulation	EVT	CNN	MRI Sequences	182	5-fold cv	AUC: 0.92 DSC: 0.53
Lucas et al. [77]	2020	AIS	EVT	CNN + PCA	CTP	29	5-fold cv	F1: 0.74
Robben et al. [78]	2020	LVO	EVT	CNN DeepMedic	CTP	188	5-fold cv	DSC: 0.48
Pinto et al. [79]	2021	AIS	EVT	End2End CNN	DSC-MRI	75	32 test cases	DSC: 0.31
Debs et al. [54]	2021	LVO	EVT	Multi-scale U-Net	DWI PWI	109	5-fold cv	AUC: 0.87 DSC: 0.44
Hokkinen et al. [80]	2021	LVO	EVT	CNN	CTA	89	50 test cases	DSC: 0.60
Pinto et al. [27]*	2021	AIS	EVT	RBM CNN	MRI Sequences	75	32 test cases	DSC: 0.38
Chen et al. [81]	2021	AIS	tPA	Ensemble U-Net + ML	DWI	40	70:30	AUC: 0.898
Amador et al. [29]	2022	AIS	EVT	U-Net Temporal-CNN	4D CTP	147	10-fold cv	DSC: 0.45
He et al. [82]	2022	LVO	EVT	U-Net	CTP	110	60:20:20	AUC: 0.93 DSC: 0.67
Winder et al. [83]	2022	LVO	EVT tPA	U-Net	CTP	145	68:12:20	DSC: 0.289
Amador et al. [84]*	2022	AIS	EVT	CNN + Transformer	CTP	45	10-fold cv	DSC: 0.45
Wouters et al. [85]	2022	LVO	EVT	CNN DeepMedic	CTP	127	5-fold cv, 101 ext. val	AUC: 0.88
Lee et al. [86]*	2022	AIS	tPA	U-Net	DWI PWI	472	5-fold cv, 55 ext. test	DSC: 0.486
Nazari et al. [87]	2023	AIS	EVT tPA	Attention-gate U-Net	DWI ADC	445	5-fold cv	AUC: 0.91 DSC: 0.50
Amador et al. [88]	2024	AIS	EVT	CNN CrossAttention	CTP	70	10-fold cv	DSC: 0.26
Palsson et al. [89]	2024	AIS	EVT	U-Net	NCCT CTA	404	80:20 5-fold cv	DSC: 0.37
Gutierrez et al. [90]	2024	AIS	EVT tPA	CGAN	NCCT CTP	147	5-fold cv	DSC: 0.37



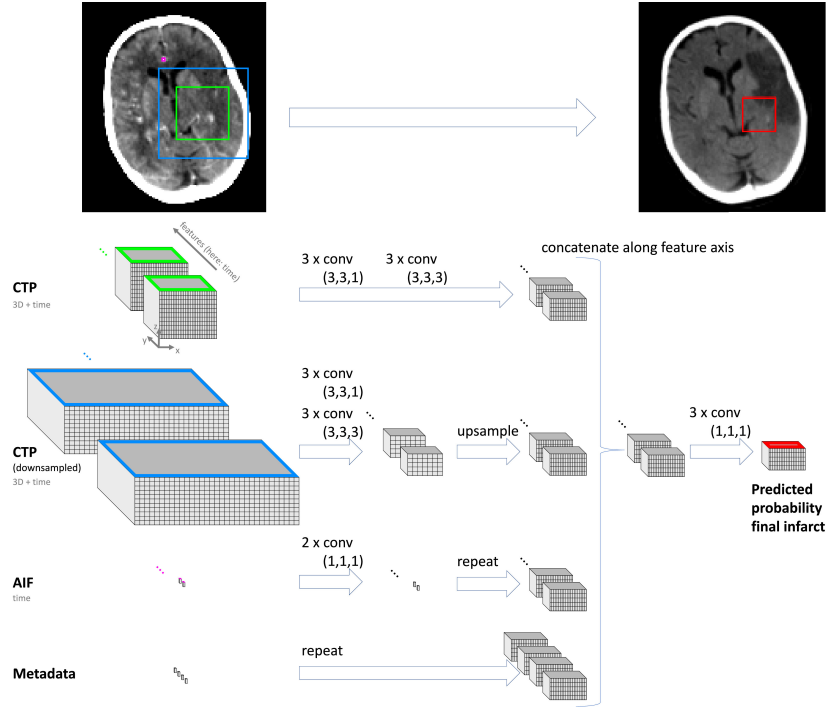

**Fig. 2** The multimodal architecture introduced in [78]. The network exploits imaging and clinical information to predict the follow-up stroke lesion. CTP: computed tomography perfusion, AIF: arterial input function which refers to the measure of blood concentration that enters the affected brain tissue after a stroke, Metadata: clinical information *e.g.* time to scanning, recanalization, completeness of recanalization. Yellow and blue rectangles represent patches extracted from CTP scan, purple rectangle represents AIF in the volume of interest and red rectangle is the target region of interest to segment lesion on follow-up NCCT scan. Figure from [78].

The integration of various data sources shows great potential for improving the performance of DL models. Pinto et al. [71] provided an example of this approach by proposing a method that used MRI maps and clinical data to predict the outcome of stroke lesions at a 3-month follow-up. The model achieved improved accuracy by incorporating clinical information at both the population and individual patient levels. Amador et al. [88] developed a novel DL model using cross-attention to incorporate the spatio-temporal nature of 4D CTP imaging and clinical variables to predict final infarct. Although their multimodal model performed slightly worse, with a Dice Similarity Coefficient (DSC) score of 0.25, compared to their unimodal model DSC score of 0.26, it significantly outperformed the unimodal approach in estimating lesion volume (mean error: 19 ml vs. 35 ml). In addition, the model generated attention maps and valuable information on how clinical variables influence stroke outcomes at individual patient level.

Robben et al. [78] developed a CNN model, based on DeepMedic [96], using spatio-temporal CTP data and clinical information to predict follow-up infarct lesions, as

shown in Fig. 2. The model architecture comprises four branches that extract the features of CTP images and their downsampled versions, arterial input function, and metadata. These features are concatenated and fed through three convolutional layers to generate the final infarct segmentation map. Debs et al. [54] investigated CNNs to predict stroke infarct volume, incorporating reperfusion status (successful or failed blood flow restoration) into the model. Their findings suggest that CNNs outperform the current clinical standard, the perfusion-diffusion mismatch model [97], in predicting infarct volume for both reperfused and non-reperfused patients (reperfused patients: Area Under the Curve (AUC) = 0.87 vs. 0.79; non-reperfused patients: AUC = 0.81 vs. 0.73, in CNN vs. perfusion-diffusion mismatch models, respectively). Pinto et al. [79] demonstrated the effectiveness of integrating information from perfusion dynamic susceptibility MRI (DSC-MRI) and parametric maps in predicting ischaemic stroke tissue outcomes. Their end-to-end architecture, which is based on U-Net and fully CNN, extracted features from raw perfusion DSC-MRI to complement standard parametric maps, achieving competitive results in ISLES 2017 competition [43] and reaching the second highest average DSC of 0.31.

To improve model performance, researchers have explored ensemble approaches that integrate several deep neural networks or different configurations within the same architecture. A key example was presented in [68], where an ensemble model of various configurations of a U-Net architecture, including different patch sizes (multi-scale image patches), number of patches, and number of convolutional filters with a multi-step training strategy was employed to overcome challenges of class imbalance due to lesion size compared to whole brain, and limited data of 30 training cases. This approach, utilised multi-scale image patches, and achieved outstanding performance in predicting both lesion outcome and clinical outcomes, ranking amongst the leaders in the ISLES 2016 Challenge [43]. Similarly, Chen et al. [81] introduced AUNet, an ensemble model that integrated DL and ML techniques. AUNet brought together an adaptive linear ensemble model (ALEM), incorporating RF, extremely randomised trees, and eXtreme Gradient Boosting (XGB), with a U-Net [98] to capture voxel-wise information and learn spatial relationships. Their method effectively predicted infarct volume in patients with acute ischaemic stroke under varying recanalization conditions, achieving an AUC of 0.898 on a dataset of 40 patients.

Recent research shows that DL models can directly analyse raw 4D CTP data to predict stroke lesion outcomes, removing post-processing steps to generate 3D perfusion parameter maps and potentially capturing spatio-temporal information more effectively [29, 84]. Amador et al. [29] demonstrated the benefit of using spatio-temporal information of raw 4D CTP by employing a U-Net-like architecture (see Fig. 3) with shared-weight encoders for spatial feature extraction, followed by a temporal convolutional network (TCN) to integrate temporal information. A decoder then generated a segmentation map which was then post-processed for refinement. Their 3D+time model, validated through a 10-fold cross-validation on 147 patients curated from ERASER [50] and custom data, obtained a notably higher mean DSC of 0.45 compared to both their 2D+time version (0.43 DSC) and the state-of-the-art method [69] based on perfusion maps (0.38 DSC).

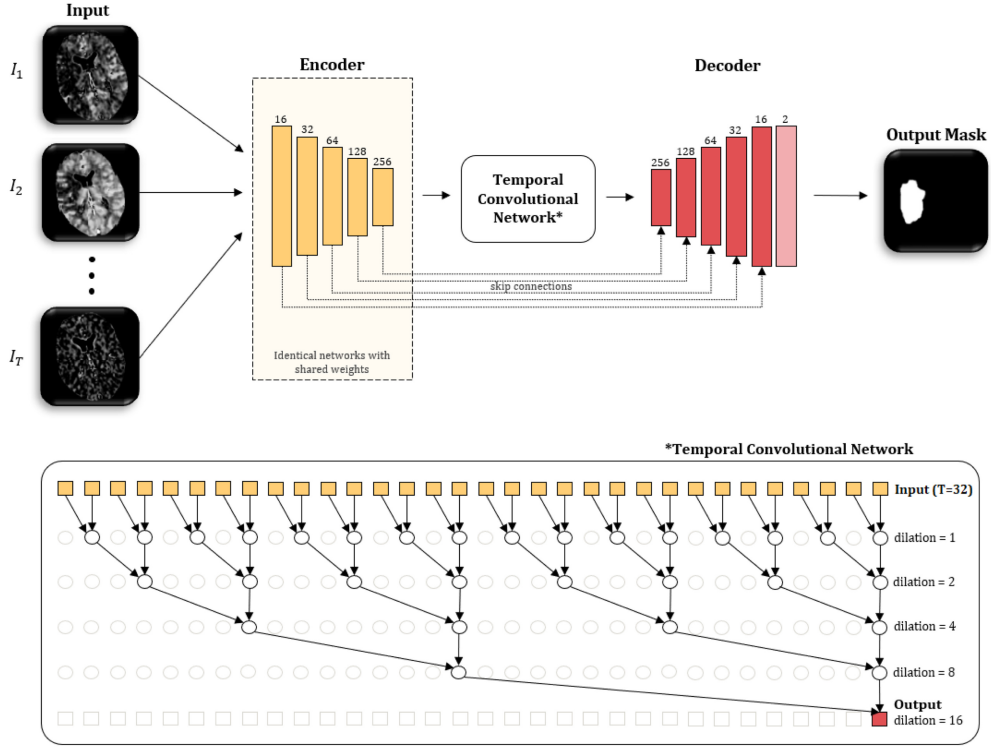

**Fig. 3** The overview of the temporal U-Net proposed by [29] to estimate the final lesion mask of stroke. Each CTP scan is fed separately into an encoder, and the temporal convolutional block encodes temporal information and pass the features to the decoder for the purpose of predicting the final lesion mask. Figure from [29].

Gutierrez et al. [90] introduced an annotation-free method that directly predicted follow-up NCCT images of acute ischaemic stroke patients from 4D CTP scans, bypassing the need for complex perfusion analysis or manual annotation of segmentation maps. Their proposed method first employed a temporal autoencoder network to extract features from CTP, followed by a Conditional Generative Adversarial Network (CGAN) that utilised these features to directly predict follow-up NCCT images. The model was trained and tested on the same dataset of 147 patients as in [29], with separate models for thrombolysis (45 patients) and thrombectomy (102 patients) treatments. Their findings showed that their approach produced realistic follow-up image predictions (also see Fig. 4) with a performance comparable to the previous state-of-the-art method [29] which relied on manual annotation. Specifically, the 3D-TCN method in Amador et al. [29] achieved DSC scores of 0.396 and 0.214 for thrombolysis and thrombectomy, respectively, while Gutierrez et al. [90]’s method achieved DSC scores of 0.375 and 0.214.

Some recent studies explored different techniques to improve model performance. For example, Yu et al. [76] integrated an attention gate into a U-Net network [99] to

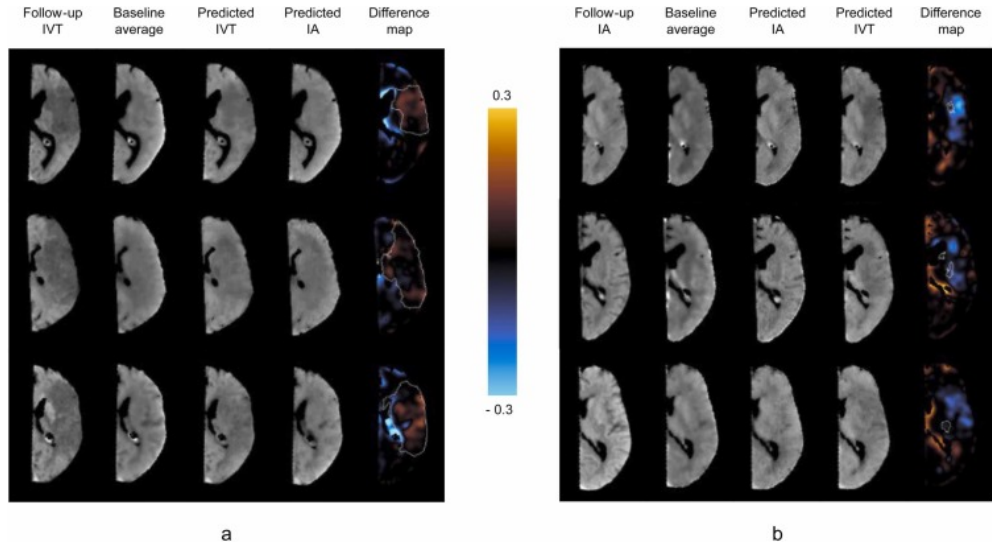

**Fig. 4** Sample results of [90] for three patients from each treatment group of (a) thrombolysis (IVT) and (b) thrombectomy (IA). Five columns for each patient: (1) the original follow-up CT image, (2) the baseline image average, (3) the CGAN prediction for the patient’s treatment group, (4) the CGAN prediction from the alternative treatment model, and (5) a difference map highlighting changes in intensity between predictions. The ground truth lesion mask is outlined in white within the difference map, with orange indicating increased intensity in the alternative treatment prediction (column 4) and blue indicating decreased intensity. Figure from [90].

predict tissue outcome from MRI perfusion maps and obtained AUC of 0.92 and DSC of 0.53 on a dataset consisting of iCAS [100] and DEFUSE-2 [46] data. Pinto et al. [27] achieved the best performance with DSC of 0.38 in the ISLES 2017 [43] dataset by employing a two-stage approach (see Fig. 5), initially using Restricted Boltzmann Machines (RBMs) in an unsupervised manner to identify lesion locations and blood flow characteristics, followed by a supervised stage where a CNN based on U-Net [98]

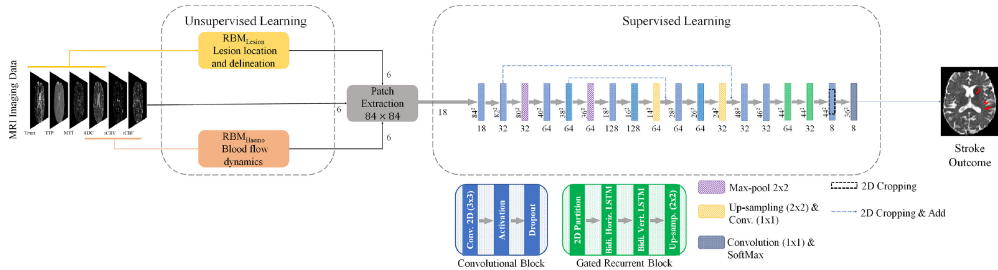

**Fig. 5** The architecture proposed by [27] to predict stroke outcome. The first part of the network includes unsupervised training that uses two Restricted Boltzmann Machines (RBM) and the second part of the network comprises of CNN and gated-Recurrent Neural Network (RNN)s for supervised training. Figure from [27].

and gated-RNNs were employed to extract spatial relationships and predict stroke lesions on follow-up scans.

Synthetic data has also emerged as a valuable tool for training models, especially when real-world data is scarce. Researchers have shown the potential of synthetic data in this context by using physically realistic simulated perfusion MRI data to train models for predicting final infarct lesions [73]. Furthermore, incorporating patient-specific details, such as arterial input functions, has demonstrably improved the accuracy of these predictions [75]. Generating synthesised data effectively addresses data limitations to potentially better integrate domain knowledge into DL models.

## 3.2 Functional Outcome (mRS) Prediction

The studies in this category aim to assess the functional abilities of stroke patients, following intervention, by analysing unimodal and multimodal data to estimate their mRS scores. These learn to establish the stroke treatment outcome as *dichotomous* (mRS scores 0-2 as favourable and mRS scores 3-6 as unfavourable) or as *individual* mRS scores (0-6). At the inference stage, the model predicts the functional outcome for a new patient using imaging and/or clinical data. Consequently, these models can help clinicians determine the most appropriate treatment.

### 3.2.1 Image Data Analysis

Predicting the functional outcome after stroke treatment is essential for guiding treatment decisions and patient management. Neuroimaging biomarkers and clinical information have commonly been used, but recent advances in DL have introduced new opportunities to use imaging data. When clinical health records are not accessible during hospital admission, the use of imaging data offers a viable alternative to evaluate stroke outcomes.

Table 5 shows the studies that leverage only imaging information to predict the functional outcome of stroke treatment. These studies employ various DL techniques, including CNN [33, 101], Siamese networks [102], and attention mechanisms [103]. The models are trained on CTA [26], NCCT [101, 104], MRI [105] (including multi-parametric MRI [102]), and diffusion-weighted imaging [33, 106] modalities.

Hilbert et al. [26] used a ResNet model with structured Receptive Field Networks (RFNNs) [107] which was trained on 2D images, to extract high-level features from a projection of the maximum intensity of a 3D CTA volume of the patient. Their model outperformed traditional biomarkers such as ASPECTS and ischaemic core volume to predict reperfusion (TICI) (AUC 0.65) and functional outcome (AUC 0.71) on the MR CLEAN registry [52] dataset. In addition, they used Gradient-weighted Class Activation Map (Grad-CAM) [108] to interpret their model result. Grad-CAM demonstrates the convolutional feature maps that contribute the most to prediction in input space. Nishi et al. [33] combined lesion segmentation and mRS score prediction tasks in a single U-Net model trained on DWI as seen in Fig. 6. Using the features at the U-Net bottleneck, they performed the classification task of mRS scores, and the output map of the U-Net decoder was used for the segmentation of the infarct core. Their model predicted functional outcome at 90 days, outperforming standard

biomarkers like the ASPECTS and ischaemic core volume by achieving an AUC of 0.81 in a derivation cohort of 250 patients and AUC of 0.73 in a validation cohort of 74 patients. Their dataset was collected from four hospitals in Japan and is available on request from the authors.

**Table 5:** Overview of the studies that use only imaging information to predict functional outcome (mRS scores) as stroke treatment outcome. The abbreviations are as follows; Acute Ischaemic Stroke (AIS), Large Vessel Occlusion (LVO), Endovascular Therapy (EVT), Symptomatic Intracerebral Haemorrhage (sICH), tissue Plasminogen Activator (tPA), recombinant tissue-type Plasminogen Activator (rtPA), Convolutional Neural Network (CNN), Convolutional Auto Encoder (CAE), Support Vector Machine (SVM), Denoising Diffusion Probabilistic Model (DDPM), CT Angiography (CTA), Diffusion-weighted MRI (DWI), Multiparametric MRI (mpMRI), Magnetic Resonance Imaging (MRI), Non-contrast Computed Tomography (NCCT), Computed Tomography (CT), Dynamic Susceptibility Contrast PWI (DSC-PWI), Leave-One-Out Cross-Validation (LOOCV), Cross-Validation (cv), Area Under the Curve (AUC), Accuracy (ACC), Not Reported (N/R).

Study	Year	Patient Subgroup	Treatment Type	Method	Input Modality	Number of Patients	Data Split	Best Result
Hilbert et al. [26]	2019	AIS	EVT	ResNet + RFNN	CTA	1301	4-fold cv	AUC: 0.71
Nishi et al. [33]	2020	LVO	EVT	U-Net + FC	DWI	250	5-fold cv 74 ext. val.	AUC: 0.81
Osama et al. [102]	2020	AIS	EVT	Siamese Network	mpMRI	43	70:30	ACC: 0.67
Lai et al. [105]	2022	N/R	N/R	CNN VGG16	MRI	44	90:10	ACC: 0.932
Fang et al. [104]	2022	Posterior Circulation	EVT rtPA	ResNet-18 SegNe	NCCT	31	5-fold cv	AUC: 0.74
Tolhuisen et al. [106]	2022	AIS	EVT tPA	CAE+ SVM	DWI	206	41 test cases	AUC: 0.88
Moulton et al. [103]	2022	LVO	EVT tPA	CNN + Attention	DWI	322	LOOCV	AUC: 0.83
Xia et al. [101]	2023	sICH	N/R	CNN	NCCT	377	91 ext. val	ACC: 0.706
Marcus et al. [109]	2023	AIS	N/R	ResNet DDPM	CT	3573	80:20 5-fold cv	ACC: 0.788
Yang et al. [110]	2024	AIS	EVT tPA	ResNet50	DWI ADC	3338	60:20:20	AUC: 0.788
Yang and Guo [111]	2024	AIS	N/R	CNN,LSTM RNN	DSC-PWI	88	10-fold cv	Mean Score: 0.971

Osama et al. [102] proposed a parallel multi-parametric feature embedded Siamese network (PMFE-SN) and achieved high accuracy even with a small number of samples (an accuracy of 0.67 with just two minority class samples for training data of the ISLES 2017 dataset [43]) and effectively handled class imbalance in their MRI data. Lai et al. [105] utilised a VGG-16 network trained on an MRI dataset of 44 patients, achieving an accuracy of 0.932 and 0.927 in the prediction of mRS and NIHSS respectively. Their dataset was collected from two hospitals in China and also available by request from the authors. Moulton et al. [103] demonstrated that a CNN with an attention mechanism, trained on 322 DWI scans of one day post-stroke patients, gathered from ASTER [112] and INSULINFARCT [113] trials and the Pitié-Salpêtrière registry [114],

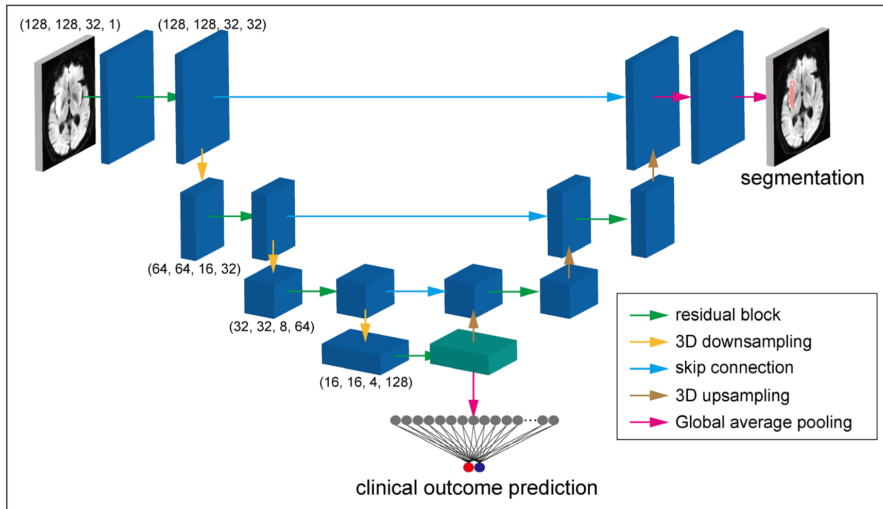

**Fig. 6** A multi-task model introduced by [33] for lesion segmentation and clinical outcome prediction. In the bottleneck of the U-Net model, binarised mRS scores are predicted and the output of the decoder is the lesion core (indicated in red). Figure from [33].

achieved better performance (AUC of 0.83) compared to Logistic Regression (LR) models using lesion volume (AUC of 0.78) or ASPECTS (AUC of 0.77) in predicting long-term functional outcomes at three months post-stroke.

Other researchers have explored DL to extract more nuanced information from imaging data. Tolhuisen et al. [106] investigated whether information beyond infarct volume from follow-up DWI could improve the prediction of the outcome in patients with acute ischaemic stroke. They found that classifiers using features extracted by a Convolutional Auto Encoder (CAE) or radiomics from follow-up DWI scans (extracted from HERMES [47], ISLES 2015 [115], and MR CLEAN-NO IV [53] datasets), achieved higher AUC values (0.88 and 0.81, respectively) compared to a model based solely on infarct volume (AUC of 0.79). Marcus et al. [109] introduced a new approach that utilised a Denoising Diffusion Probabilistic Model (DDPM) to capture the evolution of stroke for predicting mRS and NIHSS at discharge from CT images in a dataset<sup>2</sup> of 3573 AIS patients, based solely on initial patient scans. They also incorporated both longitudinal data and time since stroke onset and achieved AUC of 0.788 in mRS and AUC of 0.669 in next-day stroke severity (NIHSS).

### 3.2.2 Multimodal Data Analysis

Studies in the previous section have demonstrated the potential of using imaging data alone to predict stroke treatment outcomes. However, incorporating additional data of other modalities, such as neuroimaging data, imaging biomarkers and clinical information, has been shown to improve the accuracy of outcome prediction [116–118].

<sup>2</sup><https://www.hra.nhs.uk/planning-and-improving-research/application-summaries/research-summaries/prediction-of-stroke-outcome-using-brain-imaging-machine-learning/>

These multimodal (fusion) models capture complementary information from various data sources, that can potentially leading to better performance [93, 119, 120].

The outcome prediction studies using multimodal data are listed in Table 6. These studies employ various DL architectures, ranging from CNN, Long Short-Term Memory (LSTM) to Transformers. The models utilise diverse data sources, including imaging information (*e.g.* NCCT, CTA, CTP) and clinical variables (*e.g.* demographics of the patients such as age and sex, and medical records detailing specifying like diabetes, hypertension and medications, etc.).

Choi et al. [68] proposed an ensemble of deep neural networks that achieved AUC of 0.74 on ISLES 2016 [43] dataset in clinical outcomes after ischaemic stroke treatment. Samak et al. [116] used a multimodal CNN approach, incorporating an attention mechanism to capture inter-dependencies among features, to predict the success of endovascular treatment for ischaemic stroke patients from NCCT acquired at the hospital admission. Their model achieved AUC of 0.75 in dichotomised mRS scores and accuracy of 0.35 in individual mRS scores prediction on MR CLEAN dataset. Liu et al. [93] developed a fusion model that combined DWI and clinical features extracted using a ResNet and SVM model respectively, to predict 90-day functional outcomes. Their model achieved 0.92 AUC on a dataset of 640 patients that included four multi-centre trials (iCAS, DEFUSE-2, DEFUSE-3, CRISP) and two single center registries (University of California, Los Angeles stroke registry and Lausanne University Hospital stroke registry), demonstrating better performance than models based imaging features (AUC of 0.88) or solely on clinical (AUC of 0.88). Chen et al. [124] used a CNN which included five convolutional layers along with an efficient channel attention (ECA) layer [138] to encode features of CTP maps and combined them with demographic data features to improve post-thrombolysis functional outcome prediction. Their model was trained on 230 patients and validated on 129 patients, and achieved an AUC of 0.865 in a multimodal configuration, surpassing the performance of models that relied only on imaging data (AUC of 0.792) and clinical data (AUC of 0.670). No information is provided on the availability of their dataset.

In [34], Bacchi *et al.* used a dataset consisting of 204 patients with NCCT image volumes and relevant clinical information, such as age, gender, blood pressure, and NIHSS scores, to predict the binary outcomes of thrombolysis treatment with both mRS at 90 days and NIHSS at 24 hours. They found that their most successful model was a combination of a custom CNN comprising two 3D convolution layers followed by a maximum pooling layer and two Fully Connected (FC) layers and an Artificial Neural Network (ANN) based on 3 FC layers and ReLU activation function that were trained on both NCCT image volumes and clinical metadata. This model reached an AUC of 0.75 in mRS and 0.70 in NIHSS score prediction. Bacchi et al. [34] also did not make their data available.

Ramos et al. [122] investigated the use of ML and DL to predict clinical outcomes in stroke patients undergoing EVT. They used both imaging and clinical data from the MR CLEAN registry and explored two approaches: one using radiomics features extracted from specific brain regions and the other employing 3D DL models analysing whole brain images combined with clinical information by using ML (RF, SVM, XGB, ANN) and DL (ResNet10) respectively. Interestingly, contrary to other



**Table 6:** Overview of the studies that perform functional outcome as stroke treatment outcome and use imaging and clinical information. The abbreviations are as follows; Ischaemic Stroke (IS), Acute Ischaemic Stroke (AIS), Middle Cerebral Artery (MCA), Intracerebral Haemorrhage (ICH), Endovascular Therapy (EVT), tissue Plasminogen Activator (tPA), Deep Learning (DL), Machine Learning (ML), Convolutional Neural Network (CNN), Artificial Neural Network (ANN), Multi Layer Perceptron (MLP), Natural Language Processing (NLP), Long Short-Term Memory (LSTM), Magnetic Resonance Imaging (MRI), CT Perfusion (CTP), Diffusion-weighted MRI (DWI), Perfusion-weighted Imaging (PWI), Non-contrast Computed Tomography (NCCT), CT Angiography (CTA), Apparent Diffusion Coefficient (ADC), Electronic Health Records (EHR), Cross-Validation (cv), Area Under the Curve (AUC), Not Reported (N/R), Not Specified (N/S). \* indicates that the code used in the study is available.

Study	Year	Patient Subgroup	Treatment Type	Method	Image Modality	Clinical Features	Number of Patients	Data Split	Best Result
Choi et al. [68]	2016	AIS	N/R	U-Net + FC	MRI Sequences	3	49	19 test cases	AUC: 0.74
Bacchi et al. [119]	2020	AIS	tPA	CNN+ANN	NCCT	N/S	204	85:15	AUC: 0.75
Samak et al. [116]*	2020	IS	EVT	CNN+Attention	NCCT	27	500	80:20	AUC: 0.75
Heo et al. [121]	2020	AIS	N/R	CNN+NLP	Textual Features	MRI Reports	1840	70:30	AUC: 0.75
Zihni et al. [120]*	2020	Acute cerebrovascular	N/R	CNN+MLP	MRA	7	316	63 test cases	AUC: 0.76
Ding et al. [117]	2021	Acute Brainstem	Reperfusion Therapy	CNN	DWI ADC	N/S	1438	75:25	AUC: 0.975
Samak et al. [35]*	2022	AIS	EVT	CNN	NCCT	27	500	75:25	AUC: 0.82
Ramos et al. [122]*	2022	AIS	EVT	CNN (ResNet10)	CTA	50	3279	5-fold cv	AUC: 0.81
Hatami et al. [123]	2022	Proximal occlusion	EVT	CNN+LSTM	MRI Sequences	4	119	5-fold cv	AUC: 0.77
Liu et al. [93]	2023	AIS	EVT tPA	CNN	DWI	13	640	70:15:15 280 ext. val.	AUC: 0.92
Herzog et al. [118]*	2023	MCA	EVT	CNN+ANN	DWI PWI	32	222	50 test cases	AUC: 0.766
Chen et al. [124]*	2023	MCA	tPA	CNN+	CTP	10	230	80:20 patients	AUC: 0.865
Hung et al. [125]	2023	ICH	N/R	NLP DL, ML	EHR	N/S	1363	75:25	AUC: 0.914
Shen et al. [126]	2023	AIS	EVT	CNN	CTA	N/S	44	N/S	AUC: 0.874
Samak et al. [30]*	2023	AIS	EVT	Transformer, CNN	NCCT	27	500	75:25	AUC: 0.85
Zeng et al. [127]	2023	IS	EVT	CNN L2GAN	NCCT, CTA CTP	6	460	4-fold cv	AUC: 0.807
Oliveira et al. [128]*	2023	IS	EVT tPA	CNN Siamese	NCCT	8	743	10-folds cv	AUC: 0.806
Borsos et al. [129]	2023	AIS	N/R	ResNet, DAFT [130]	CTP	14	98	60:20:20	AUC: 0.75
Jo et al. [131]	2023	AIS	N/R	DenseNet	DWI ADC	3	4147	80:20 5-fold cv	AUC: 0.786
Jung et al. [132]	2024	AIS	N/R	ResNeXt + CBAM	DWI FLAIR	22	2606	5-fold cv	AUC: 0.83
Diprose et al. [133]*	2024	AIS	EVT	DenseNet121 LR	NCCT	26	975	80:20	AUC: 0.811
Liu et al. [134]	2024	AIS	N/R	DL	DWI	N/S	80	N/S	ACC: 0.36
Martín Vicario et al. [135]*	2024	AIS	EVT	GCN FCN	CTA CTP	81	220	5-fold cv	AUC: 0.87
Liu et al. [136]	2024	AIS	EVT	ResNet	NCCT	7	1335	6-fold cv	AUC: 0.91
Amador et al. [137]*	2024	AIS	EVT	CNN Cross-Attention	CTP	9	70	10-fold cv	AUC: 0.77

studies, incorporating imaging data did not significantly improve the performance of mRS prediction. Using only clinical data, AUC was 0.81 for ML and 0.77 for DL, while when using both imaging and clinical data, the AUC remained at 0.80 for ML and 0.77 for DL. However, for TICI score prediction, the inclusion of imaging data increased the AUC from 0.53 to 0.57 for ML and from 0.53 to 0.61 for DL.

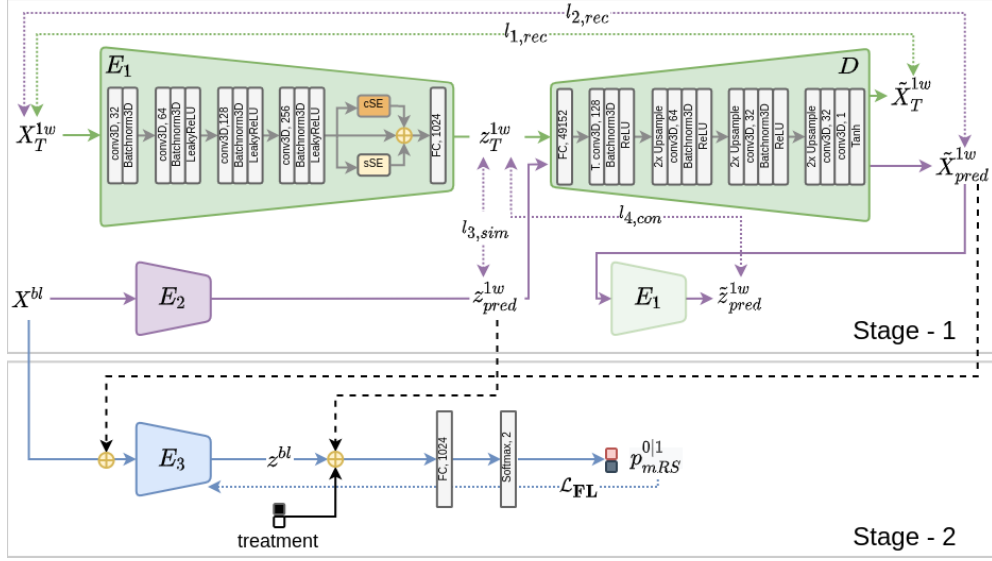

**Fig. 7** Overview of the FeMA network [35]. The model predicts the follow-up NCCT scan (1-week follow-up  $X_T^{1w}$ ) from the baseline scan  $X^{bl}$ . Then, it combines the baseline scan with the predicted follow-up scan  $X_{pred}^{1w}$  and 1-week follow-up scan features  $z_{pred}^{1w}$  to predict the functional outcome of the stroke treatment. Figure from [35].

Early prediction (at one week) of stroke evolution has been found to be critical for predicting the functional outcome after stroke treatment. Ernst et al. [36] highlighted this by demonstrating a correlation between the volume of lesions in 1-week follow-up NCCT scans with functional outcome. Building on this, Samak et al. [35] developed a model to predict mRS scores by incorporating follow-up scan data. Their approach, named Feature Matching Auto-encoder (FeMA) (see Fig 7), leveraged a self-supervised voxel-wise method based on a custom CNN model that consisted of three encoder and a decoder modules to predict follow-up scans in stroke patients from their baseline scan alone. In training their model, a two-step strategy was used where in the first stage a 1-week follow-up scan was reconstructed from a baseline scan to encode information about tissue changes over a week after treatment, and then in the second stage, the learnt features from the first stage and a baseline scan were combined to estimate mRS scores. The model was tested using the MR CLEAN trial dataset and obtained an AUC of 0.82.

Interpretable deep learning models have also been developed to improve the estimation of functional outcomes. Herzog et al. [118] used an interpretable DL model based on the study of [139] and demonstrated that utilising both imaging data (DWI) and clinical variables (*e.g.* age, systolic blood pressure, diabetes, hypertension, smoking). They collected a dataset of 222 patients from Inselspital Bern, Switzerland which is available by requests from the authors. Their model achieved an accuracy of 0.72, outperforming models based only on imaging data (accuracy of 0.614) or clinical data (accuracy of 0.60). The inclusion of imaging data allowed the model to significantly

outperform experienced stroke neurologists, who had an accuracy of 0.64 with imaging and clinical data, an accuracy of 0.55 with imaging data only and an accuracy of 0.60 with clinical data alone.

A recent study by Martín Vicario et al. [135] introduced an uncertainty-aware graph deep learning model to predict long-term functional outcomes and mortality rates in AIS patients following EVT. Their dataset was collected from the University Hospital of Erlangen, comprising 220 AIS patients, and is available by request from the authors. They employed Graph Convolutional Networks (GCNs) and Fully Connected Networks (FCNs) to predict the outcome at admission, post-EVT, and 24 hours after stroke. Their results demonstrated comparable performance across the algorithms including LR, RF, XGB and FCN, with a maximum AUC of 0.87 for the prediction of mRS using GCNs. The performance of the predictions increased when data from later time points were incorporated, rising from an AUC of 0.76 at admission to 0.84 post-EVT and to 0.87 at 24 hours post-stroke.

In addition to using imaging and clinical data, Natural Language Processing (NLP) has been used in several medical domains to analyse clinical narratives [140] and applied to treatment outcome prediction. By generating text-based markers from free-text MRI reports, NLP-based ML algorithms have demonstrated improved performance in predicting poor outcomes in AIS patients [121]. Similarly, NLP techniques have been applied to enhance the prediction of functional outcomes after Intracerebral Haemorrhage (ICH) [125].

## 4 Discussion

So far in this article, we have reviewed the current landscape of stroke outcome prediction methods that have explored deep learning to make estimates at various time-points following a stroke. Next, we present our key observations with respect to the major issues and challenges, and discuss current limitations.

**Use of Deep Learning** – A consistent feature across the reviewed studies is the dominance of using DL models based on CNNs, for example [29, 35, 69, 78, 89, 102, 109, 133], with U-Net variations commonly used for final infarct prediction [29, 54, 68, 70, 83, 89], due to their ability to handle segmentation tasks effectively, whereas ResNet-style architectures are preferred for predicting functional outcomes, such as [26, 104, 110, 122, 129]. Among imaging modalities, MRI is most used for both the prediction of the final infarct and functional outcome, as it provides detailed information about stroke tissue, *e.g.* [27, 67, 69, 87]. CTP is popular for final infarct prediction due to its ability to assess cerebral blood flow, a key factor in tissue infarction [70, 78, 83, 88]. NCCT is also frequently used for predicting functional outcomes, likely due to its greater availability and lower cost, *e.g.* [30, 34, 101, 116, 133].

A common trend in the reviewed studies is the development of novel implementations rather than investigation and validation of existing methods [141]. Furthermore, many studies lack sufficient detail regarding model building procedures, data processing steps and hyperparameter tuning. In addition to this problem, only a small proportion of studies (15 out of 60) analysed in this research share their code publicly, such as [27, 84, 116, 124, 133] as can be seen in Table A1. Consequently, ensuring

transparency and reproducibility remains a significant challenge. To address this, a commitment to open science practices is necessary.

Finally, while DL models have shown promising performance in predicting stroke outcomes, their lack of interpretability makes it difficult to assess their reliability and adoption in clinical settings [141]. Clinicians expect to better understand "black-box" DL models, so they can have confidence in and rely on their predictions [90, 118]. To address this critical gap, a few recent studies [90, 103, 118, 135] have explored interpretable DL models in the context of SOP.

**Multimodal Data** – The majority of studies, particularly the studies on functional outcome prediction, leverage multimodal data, combining imaging and clinical information to achieve superior performance compared to models that rely solely on unimodal information [30, 34, 93, 116, 118]. This approach acknowledges that the prediction of stroke outcomes depends not only on the extent of brain damage, but also on previous health conditions and other characteristics of the patient. Furthermore, incorporating follow-up (lesion outcome) information demonstrably improves the performance of models to predict mRS scores, such as [35, 106].

**Availability of Data & Benchmarks** – Although DL techniques such as CNNs, and more recently transformer-based architectures, hold significant promise for predicting stroke outcomes, several limitations need to be addressed. A significant challenge is the limited availability of large, all-encompassing, easily accessible and well-annotated datasets [8, 141] that can allow DL algorithms to learn complex patterns and ensure generalisability. The majority of the studies reviewed in this research use data sets consisting of fewer than 500 patients. This scarcity restricts the development of robust and generalisable models.

While significant efforts have been made to develop clinical trial datasets such as MR CLEAN [51], HERMES [47], ERASER [50] and DIFUSE-2 [46], are not structured as benchmarks for comparative evaluation of DL models. This lack of standardised benchmarking framework (datawise and processes) has led to various niche datasets, inconsistent evaluation metrics and experimental setups, hence making it challenging to assess relative strengths and weaknesses between different algorithms fairly and objectively. Even when employing the same clinical trial dataset, inconsistencies arise due to the incomparable use of data modalities and subsets for training and testing *e.g.* [26, 122]. Clearly, collaborative efforts are needed to establish comprehensive standardised public datasets and evaluation protocols that allow researchers to perform thorough comparisons and accelerate progress in model development.

Although some clinical trial datasets offer data from multiple centres, many single-centre studies rely on in-house datasets, such as [80, 82, 104, 111, 142], which often lack heterogeneity. Stroke presentation, imaging equipment and neuroimaging parameters vary considerably across healthcare institutions, and this in-house approach fails to capture this essential diversity. Such lack of diversity in single-centre training data limits the generalisability of models to real-world scenarios with broader patient characteristics and clinical practices. It also leads to limited or no means of external validation which creates a significant obstacle to clinical translation [141]. Such lack of external validation, which has been explored by only a few [33, 85, 101, 124], is cause for concern on the reliability of reported results.

## 5 Future Directions

There is scope for several promising areas of research to significantly improve prediction accuracy and robustness for stroke outcome using deep learning.

**Adaptive Multimodal Data Fusion** – Combining information from various data sources, consistently improves the predictive performance of models [34, 35, 132]. However, current methods often rely on naive fusion techniques, such as late fusion, which fail to explore the the complex relationships between different types of data [143, 144]. This suggests a critical need for the development of adaptive multimodal fusion methods that dynamically learn relationships and contextually integrate information, such as neuroimaging data and clinical records.

**Leveraging Final Infarct Information** – The information available in brain scans within post-treatment stroke lesions (final infarct) - specifically the size and location of the damaged area - is extremely valuable for predicting how well a patient will recover in the long term. While encoding final infarct information into models has shown promise for improving functional outcome prediction in some studies [35, 106], this area still requires further investigation. Therefore, developing models that can effectively encode such information, along with longitudinal lesion changes, could enhance prediction robustness.

**Federated Learning** – Federated learning presents a promising solution to the challenge of data heterogeneity in developing robust models for SOP. This decentralised approach allows for collaborative model training across multiple institutions without compromising patient privacy by avoiding sharing source data [145]. By enabling the training of models on larger and more diverse datasets, federated learning facilitates the development of more generalisable models capable of handling the variability encountered in real-world clinical settings [146]. Such collaborative approach holds significant potential for improving the performance and reliability of models in SOPs across diverse patient populations.

**Annotation-free Segmentation** – Currently, the reliance on manual lesion segmentation to generate ground truth labels in follow-up scans presents a major bottleneck due to its time-consuming and labour-intensive nature. The development of annotation-free models for final infarct segmentation offers a significant opportunity to improve efficiency and cost-effectiveness [90]. This would also allow researchers to access larger training datasets, leading to the development of more robust and accurate predictive models.

## 6 Conclusions

This paper has provided a review of deep learning approaches for stroke outcome prediction, encompassing both final infarct and functional outcomes, using imaging and multimodal data. We have presented the most recent techniques, datasets, evaluations, and code. While significant progress has been made, particularly in utilising multimodal data and advanced model architectures, specifically U-Net variations for lesion outcome segmentation and ResNet architectures for functional outcome prediction, several critical challenges remain. The scarcity of large, standardised benchmark

datasets and inherent data heterogeneity restrict the development of robust and generalisable models. Furthermore, the limited use of external validation, inconsistencies in reporting practices, and the lack of interpretable models raise concerns regarding the clinical translation and reliability of existing approaches.

Despite these challenges, several promising avenues for future research are: the development of adaptive multimodal fusion methods that effectively leverage the complementary nature of diverse data sources, the incorporation of longitudinal lesion features, the adoption of federated learning techniques for improved data utilisation, and the exploration of annotation-free lesion labelling methods.

## Declarations

- **Funding** Not applicable.
- **Conflict of interest** The authors declare no competing interests.
- **Ethics approval and consent to participate** Not applicable.

## Appendix A Studies with Code

**Table A1:** The list of the studies that have shared their code publicly.

Study	Task	Code Link
Lucas et al. [70]	Final Infarct	<a href="https://github.com/multimodallearning/stroke-prediction">https://github.com/multimodallearning/stroke-prediction</a>
Samak et al. [116]	Functional Outcome	<a href="https://github.com/zeynelsamak/Thrombectomy-Outcome">https://github.com/zeynelsamak/Thrombectomy-Outcome</a>
Zihni et al. [120]	Functional Outcome	<a href="https://github.com/prediction2020/multimodal-classification">https://github.com/prediction2020/multimodal-classification</a>
Pinto et al. [27]	Final Infarct	<a href="https://github.com/apint0/stroke_prediction">https://github.com/apint0/stroke_prediction</a>
Samak et al. [35]	Functional Outcome	<a href="https://github.com/zeynelsamak/FeMA">https://github.com/zeynelsamak/FeMA</a>
Ramos et al. [122]	Functional Outcome	<a href="https://github.com/L-Ramos/mrclean_combination">https://github.com/L-Ramos/mrclean_combination</a>
Amador et al. [84]	Final Infarct	<a href="https://github.com/kimberly-amador/Spatiotemporal-CNN-Transformer">https://github.com/kimberly-amador/Spatiotemporal-CNN-Transformer</a>
Lee et al. [86]	Final Infarct	<a href="https://github.com/sdlee087/deep_medical">https://github.com/sdlee087/deep_medical</a>
Herzog et al. [118]	Functional Outcome	<a href="https://github.com/liherz/functional_outcome_prediction_dl_vs_neurologists">https://github.com/liherz/functional_outcome_prediction_dl_vs_neurologists</a>
Chen et al. [124]	Functional Outcome	<a href="https://github.com/Yutong441/deepCTP">https://github.com/Yutong441/deepCTP</a>
Samak et al. [30]	Functional Outcome	<a href="https://github.com/zeynelsamak/TransSOP">https://github.com/zeynelsamak/TransSOP</a>
Oliveira et al. [128]	Functional Outcome	<a href="https://github.com/GravO8/mrs-dl">https://github.com/GravO8/mrs-dl</a>
Diprose et al. [133]	Functional Outcome	<a href="https://github.com/jdddog/deep-mt">https://github.com/jdddog/deep-mt</a>
Martín Vicario et al. [135]	Functional Outcome	<a href="https://gitlab.cs.fau.de/gu47bole/ais">https://gitlab.cs.fau.de/gu47bole/ais</a>
Amador et al. [137]	Functional Outcome	<a href="https://github.com/kimberly-amador/Multimodal-mRS90-Outcome-Prediction">https://github.com/kimberly-amador/Multimodal-mRS90-Outcome-Prediction</a>

## References

- [1] Boehme, A.K., Esenwa, C., Elkind, M.S.: Stroke risk factors, genetics, and prevention. *Circulation research* **120**(3), 472–495 (2017) [2](#)
- [2] Zhao, H.-L., Huang, Y.: Lifetime risk of stroke in the global burden of disease study. *The New England journal of medicine* **380**(14), 1377–1378 (2019) [2](#)
- [3] World Health Organization: The top 10 causes of death. Accessed on 21.05.2023 (2020). <https://www.who.int/news-room/fact-sheets/detail/the-top-10-causes-of-death> [2](#)

- [4] Saver, J.L.: Time is brain—quantified. *Stroke* **37**(1), 263–266 (2006) [2](#)
- [5] Darehed, D., Blom, M., Glader, E.-L., Niklasson, J., Norrving, B., Eriksson, M.: In-hospital delays in stroke thrombolysis: every minute counts. *Stroke* **51**(8), 2536–2539 (2020) [2](#)
- [6] Sacco, R.L., Kasner, S.E., Broderick, J.P., Caplan, L.R., Connors, J., Culebras, A., Elkind, M.S., George, M.G., Hamdan, A.D., Higashida, R.T., *et al.*: An updated definition of stroke for the 21st century: a statement for healthcare professionals from the american heart association/american stroke association. *Stroke* **44**(7), 2064–2089 (2013) [2](#)
- [7] Heo, J., Yoon, J.G., Park, H., Kim, Y.D., Nam, H.S., Heo, J.H.: Machine learning-based model for prediction of outcomes in acute stroke. *Stroke* **50**(5), 1263–1265 (2019) [2](#)
- [8] Karthik, R., Menaka, R., Johnson, A., Anand, S.: Neuroimaging and deep learning for brain stroke detection - a review of recent advancements and future prospects. *Computer Methods and Programs in Biomedicine* **197**, 105728 (2020) [2](#), [3](#), [4](#), [20](#)
- [9] Inamdar, M.A., Raghavendra, U., Gudigar, A., Chakole, Y., Hegde, A., Menon, G.R., Barua, P., Palmer, E.E., Cheong, K.H., Chan, W.Y., Ciaccio, E.J., Acharya, U.R.: A review on computer aided diagnosis of acute brain stroke. *Sensors* **21**(24), 8507 (2021) <https://doi.org/10.3390/s21248507> [2](#), [3](#), [4](#)
- [10] Zeng, M., Oakden-Rayner, L., Bird, A., Smith, L., Wu, Z., Scroop, R., Kleinig, T., Jannes, J., Jenkinson, M., Palmer, L.J.: Pre-thrombectomy prognostic prediction of large-vessel ischemic stroke using machine learning: A systematic review and meta-analysis. *Frontiers in Neurology* **13** (2022) <https://doi.org/10.3389/fneur.2022.945813> [2](#), [4](#)
- [11] Radford, A., Kim, J.W., Hallacy, C., Ramesh, A., Goh, G., Agarwal, S., Sastry, G., Askell, A., Mishkin, P., Clark, J., *et al.*: Learning transferable visual models from natural language supervision. In: *International Conference on Machine Learning*, pp. 8748–8763 (2021). PMLR [3](#)
- [12] Touvron, H., Lavril, T., Izacard, G., Martinet, X., Lachaux, M.-A., Lacroix, T., Rozière, B., Goyal, N., Hambro, E., Azhar, F., *et al.*: Llama: Open and efficient foundation language models. *arXiv preprint arXiv:2302.13971* (2023) [3](#)
- [13] Chawla, M., Sharma, S., Sivaswamy, J., Kishore, L.: A method for automatic detection and classification of stroke from brain ct images. In: *2009 Annual International Conference of the IEEE Engineering in Medicine and Biology Society*, pp. 3581–3584 (2009). IEEE [3](#), [7](#)
- [14] Rekik, I., Allasonnière, S., Carpenter, T.K., Wardlaw, J.M.: Medical image

- analysis methods in MR/CT-imaged acute-subacute ischemic stroke lesion: Segmentation, prediction and insights into dynamic evolution simulation models. A critical appraisal. *NeuroImage: Clinical* **1**(1), 164–178 (2012) [3](#)
- [15] Gupta, N., Mittal, A.: Brain ischemic stroke segmentation: a survey. *Journal of Multi Disciplinary Engineering Technologies Volume* **8**(1), 1 (2014) [3](#)
- [16] Mckinley, R., Häni, L., Gralla, J., El-Koussy, M., Bauer, S., Arnold, M., Fischer, U., Jung, S., Mattmann, K., Reyes, M., Wiest, R.: Fully automated stroke tissue estimation using random forest classifiers (FASTER). *Journal of Cerebral Blood Flow & Metabolism* **37**(8), 2728–2741 (2017) [3](#)
- [17] Böhme, L., Madesta, F., Sentker, T., Werner, R.: Combining good old random forest and deeplabv3+ for isles 2018 ct-based stroke segmentation. In: *International MICCAI Brainlesion Workshop*, pp. 335–342 (2018). Springer [3](#)
- [18] Maier, O., Wilms, M., Gablentz, J., Krämer, U., Handels, H.: Ischemic stroke lesion segmentation in multi-spectral MR images with support vector machine classifiers. In: *Medical Imaging 2014: Computer-Aided Diagnosis*, vol. 9035, p. 903504 (2014). ISOP [3](#)
- [19] Lin, T.-Y., Goyal, P., Girshick, R., He, K., Dollár, P.: Focal loss for dense object detection. In: *Proceedings of the IEEE Conference on Computer Vision and Pattern Recognition*, pp. 2980–2988 (2017) [3](#)
- [20] Cai, Z., Vasconcelos, N.: Cascade r-cnn: Delving into high quality object detection. In: *Proceedings of the IEEE Conference on Computer Vision and Pattern Recognition*, pp. 6154–6162 (2018) [3](#)
- [21] Isensee, F., Kickingereder, P., Wick, W., Bendszus, M., Maier-Hein, K.H.: Brain tumor segmentation and radiomics survival prediction: Contribution to the brats 2017 challenge. In: *International MICCAI Brainlesion Workshop*, pp. 287–297 (2017). Springer [3](#)
- [22] Li, X., Liu, Z., Luo, P., Change Loy, C., Tang, X.: Not all pixels are equal: Difficulty-aware semantic segmentation via deep layer cascade. In: *Proceedings of the IEEE Conference on Computer Vision and Pattern Recognition*, pp. 3193–3202 (2017) [3](#)
- [23] He, K., Zhang, X., Ren, S., Sun, J.: Deep residual learning for image recognition. In: *Proceedings of the IEEE Conference on Computer Vision and Pattern Recognition*, pp. 770–778 (2016) [3](#)
- [24] Hu, J., Shen, L., Sun, G.: Squeeze-and-excitation networks. In: *Proceedings of the IEEE Conference on Computer Vision and Pattern Recognition*, pp. 7132–7141 (2018) [3](#)



- [25] Kamnitsas, K., Bai, W., Ferrante, E., McDonagh, S., Sinclair, M., Pawlowski, N., Rajchl, M., Lee, M., Kainz, B., Rueckert, D., *et al.*: Ensembles of multiple models and architectures for robust brain tumour segmentation. In: International MICCAI Brainlesion Workshop, pp. 450–462 (2017). Springer **3, 7**
- [26] Hilbert, A., Ramos, L., Os, H., Olabarriaga, S., Tolhuisen, M., Wermer, M., Barros, R., Schaaf, I., Dippel, D., Roos, Y., *et al.*: Data-efficient deep learning of radiological image data for outcome prediction after endovascular treatment of patients with acute ischemic stroke. *Computers in Biology and Medicine*, 103516 (2019) **7, 13, 14, 19, 20**
- [27] Pinto, A., Pereira, S., Meier, R., Wiest, R., Alves, V., Reyes, M., Silva, C.A.: Combining unsupervised and supervised learning for predicting the final stroke lesion. *Medical Image Analysis* **69**, 101888 (2021) **3, 8, 12, 19, 22**
- [28] Hatamizadeh, A., Nath, V., Tang, Y., Yang, D., Roth, H.R., Xu, D.: Swin unetr: Swin transformers for semantic segmentation of brain tumors in mri images. In: International MICCAI Brainlesion Workshop, pp. 272–284 (2022). Springer **3**
- [29] Amador, K., Wilms, M., Winder, A., Fiehler, J., Forkert, N.D.: Predicting treatment-specific lesion outcomes in acute ischemic stroke from 4d CT perfusion imaging using spatio-temporal convolutional neural networks. *Medical Image Analysis*, 102610 (2022) <https://doi.org/10.1016/j.media.2022.102610> **8, 10, 11, 19**
- [30] Samak, Z.A., Clatworthy, P., Mirmehdi, M.: TranSOP: Transformer-based multimodal classification for stroke treatment outcome prediction. In: 2023 IEEE 20th International Symposium on Biomedical Imaging (ISBI). IEEE, ??? (2023). <https://doi.org/10.1109/isbi53787.2023.10230576> **3, 17, 19, 20, 22**
- [31] Gautam, A., Raman, B.: Towards effective classification of brain hemorrhagic and ischemic stroke using cnn. *Biomedical Signal Processing and Control* **63**, 102178 (2021) **3, 7**
- [32] Neethi, A., Niyas, S., Kannath, S.K., Mathew, J., Anzar, A.M., Rajan, J.: Stroke classification from computed tomography scans using 3d convolutional neural network. *Biomedical Signal Processing and Control* **76**, 103720 (2022) **3, 7**
- [33] Nishi, H., Oishi, N., Ishii, A., Ono, I., Ogura, T., Sunohara, T., Chihara, H., Fukumitsu, R., Okawa, M., Yamana, N., *et al.*: Deep learning–derived high-level neuroimaging features predict clinical outcomes for large vessel occlusion. *Stroke* **51**(5), 1484–1492 (2020) **3, 13, 14, 15, 20**
- [34] Bacchi, S., Zerner, T., Oakden-Rayner, L., Kleinig, T., Patel, S., Jannes, J.: Deep learning in the prediction of ischaemic stroke thrombolysis functional outcomes: A pilot study. *Academic Radiology* (2019) **7, 16, 19, 20, 21**

- [35] Samak, Z.A., Clatworthy, P., Mirmehdi, M.: FeMA: Feature matching auto-encoder for predicting ischaemic stroke evolution and treatment outcome. *Computerized Medical Imaging and Graphics* **99**, 102089 (2022) <https://doi.org/10.1016/j.compmedimag.2022.102089> 3, 7, 17, 18, 19, 20, 21, 22
- [36] Ernst, M., Boers, A.M., Aigner, A., Berkhemer, O.A., Yoo, A.J., Roos, Y.B., Dippel, D.W., Lugt, A., Oostenbrugge, R.J., Zwam, W.H., *et al.*: Association of computed tomography ischemic lesion location with functional outcome in acute large vessel occlusion ischemic stroke. *Stroke* **48**(9), 2426–2433 (2017) 3, 18
- [37] Nishi, H., Oishi, N., Ishii, A., Ono, I., Ogura, T., Sunohara, T., Chihara, H., Fukumitsu, R., Okawa, M., Yamana, N., *et al.*: Predicting clinical outcomes of large vessel occlusion before mechanical thrombectomy using machine learning. *Stroke* **50**(9), 2379–2388 (2019) 3
- [38] Sirsat, M.S., Fermé, E., Câmara, J.: Machine learning for brain stroke: A review. *Journal of Stroke and Cerebrovascular Diseases* **29**(10), 105162 (2020) <https://doi.org/10.1016/j.jstrokecerebrovasdis.2020.105162> 3, 4
- [39] Mainali, S., Darsie, M.E., Smetana, K.S.: Machine learning in action: Stroke diagnosis and outcome prediction. *Frontiers in Neurology* **12** (2021) 3, 4
- [40] Kremers, F., Venema, E., Duvekot, M., Yo, L., Bokkers, R., Lycklama À. Nijeholt, G., Es, A., Lugt, A., Majoie, C., Burke, J., Roozenbeek, B., Lingsma, H., Dippel, D.: Outcome prediction models for endovascular treatment of ischemic stroke: Systematic review and external validation. *Stroke* **53**(3), 825–836 (2022) <https://doi.org/10.1161/strokeaha.120.033445> 4
- [41] Wang, X., Fan, Y., Zhang, N., Li, J., Duan, Y., Yang, B.: Performance of machine learning for tissue outcome prediction in acute ischemic stroke: A systematic review and meta-analysis. *Frontiers in Neurology* **13** (2022) <https://doi.org/10.3389/fneur.2022.910259> 3, 4, 7
- [42] Hilbert, A., Akay, E.M., Carlisle, B.G., Madai, V.I., Mutke, M.A., Frey, D.: Artificial intelligence for clinical decision support in acute ischemic stroke care: A systematic review (2022) <https://doi.org/10.21203/rs.3.rs-1706474/v3> 3, 4
- [43] Winzeck, S., Hakim, A., McKinley, R., Pinto, J.A.A.D.S.R., Alves, V., Silva, C., Pisov, M., Krivov, E., Belyaev, M., Monteiro, M., Oliveira, A., Choi, Y., Paik, M.C., Kwon, Y., Lee, H., Kim, B.J., Won, J.-H., Islam, M., Ren, H., Robben, D., Suetens, P., Gong, E., Niu, Y., Xu, J., Pauly, J.M., Lucas, C., Heinrich, M.P., Rivera, L.C., Castillo, L.S., Daza, L.A., Beers, A.L., Arbelaezs, P., Maier, O., Chang, K., Brown, J.M., Kalpathy-Cramer, J., Zaharchuk, G., Wiest, R., Reyes, M.: ISLES 2016 and 2017-benchmarking ischemic stroke lesion outcome prediction based on multispectral MRI. *Frontiers in Neurology* **9** (2018) 4, 5, 10, 12, 14, 16

- [44] Alawneh, J.A., Jones, P.S., Mikkelsen, I.K., Cho, T.-H., Siemonsen, S., Mouridsen, K., Ribe, L., Morris, R.S., Hjort, N., Antoun, N., *et al.*: Infarction of ‘non-core–non-penumbra’ tissue after stroke: multivariate modelling of clinical impact. *Brain* **134**(6), 1765–1776 (2011) [5](#)
- [45] Cheng, B., Forkert, N.D., Zavaglia, M., Hilgetag, C.C., Golsari, A., Siemonsen, S., Fiehler, J., Pedraza, S., Puig, J., Cho, T.-H., *et al.*: Influence of stroke infarct location on functional outcome measured by the modified rankin scale. *Stroke* **45**(6), 1695–1702 (2014) [5](#)
- [46] Lansberg, M.G., Straka, M., Kemp, S., Mlynash, M., Wechsler, L.R., Jovin, T.G., Wilder, M.J., Lutsep, H.L., Czartoski, T.J., Bernstein, R.A., *et al.*: Mri profile and response to endovascular reperfusion after stroke (defuse 2): a prospective cohort study. *The Lancet Neurology* **11**(10), 860–867 (2012) [5](#), [12](#), [20](#)
- [47] Goyal, M., Menon, B.K., Van Zwam, W.H., Dippel, D.W., Mitchell, P.J., Demchuk, A.M., Dávalos, A., Majoie, C.B., Der Lugt, A., De Miquel, M.A., *et al.*: Endovascular thrombectomy after large-vessel ischaemic stroke: a meta-analysis of individual patient data from five randomised trials. *The Lancet* **387**(10029), 1723–1731 (2016) [5](#), [15](#), [20](#)
- [48] Lansberg, M.G., Christensen, S., Kemp, S., Mlynash, M., Mishra, N., Federau, C., Tsai, J.P., Kim, S., Nogueira, R.G., Jovin, T., *et al.*: Computed tomographic perfusion to predict response to recanalization in ischemic stroke. *Annals of Neurology* **81**(6), 849–856 (2017) [5](#)
- [49] Thamm, T., Guo, J., Rosenberg, J., Liang, T., Marks, M.P., Christensen, S., Do, H.M., Kemp, S.M., Adair, E., Eyngorn, I., *et al.*: Contralateral hemispheric cerebral blood flow measured with arterial spin labeling can predict outcome in acute stroke. *Stroke* **50**(12), 3408–3415 (2019) [5](#)
- [50] Fiehler, J., Thomalla, G., Bernhardt, M., Kniep, H., Berlis, A., Dorn, F., Eckert, B., Kemmling, A., Langner, S., Remonda, L., *et al.*: Eraser: a thrombectomy study with predictive analytics end point. *Stroke* **50**(5), 1275–1278 (2019) [5](#), [10](#), [20](#)
- [51] Berkhemer, O.A., Fransen, P.S.S., Beumer, D., Berg, L.A., Lingsma, H.F., Yoo, A.J., Schonewille, W.J., Vos, J.A., Nederkoorn, P.J., Wermer, M.J.H., Walderveen, M.A.A., Staals, J., Hofmeijer, J., Oostayen, J.A., Nijeholt, G.J., Boiten, J., Brouwer, P.A., Emmer, B.J., Bruijn, S.F., Dijk, L.C., Kappelle, L.J., Lo, R.H., Dijk, E.J., Vries, J., Kort, P.L.M., Rooij, W.J.J., Berg, J.S.P., Hasselt, B.A.A.M., Aerden, L.A.M., Dallinga, R.J., Visser, M.C., Bot, J.C.J., Vroomen, P.C., Eshghi, O., Schreuder, T.H.C.M.L., Heijboer, R.J.J., Keizer, K., Tielbeek, A.V., Hertog, H.M., Gerrits, D.G., Berg-Vos, R.M., Karas, G.B., Steyerberg, E.W., Flach, H.Z., Marquering, H.A., Sprengers, M.E.S., Jenniskens, S.F.M., Beenen, L.F.M., Berg, R., Koudstaal, P.J., Zwam, W.H., Roos, Y.B.W.E.M., der, A., Oostenbrugge, R.J., Majoie, C.B.L.M., Dippel, D.W.J.: A randomized

trial of intraarterial treatment for acute ischemic stroke. *New England Journal of Medicine* **372**(1), 11–20 (2015) [5](#), [20](#)

- [52] Compagne, K.C., Kappelhof, M., Hinsenveld, W.H., Brouwer, J., Goldhoorn, R.-J.B., Uyttenboogaart, M., Bokkers, R.P., Schonewille, W.J., Martens, J.M., Hofmeijer, J., *et al.*: Improvements in endovascular treatment for acute ischemic stroke: a longitudinal study in the mr clean registry. *Stroke* **53**(6), 1863–1872 (2022) [5](#), [13](#)
- [53] LeCouffe, N.E., Kappelhof, M., Treurniet, K.M., Rinkel, L.A., Bruggeman, A.E., Berkhemer, O.A., Wolff, L., Voorst, H., Tolhuisen, M.L., Dippel, D.W., *et al.*: A randomized trial of intravenous alteplase before endovascular treatment for stroke. *New England journal of medicine* **385**(20), 1833–1844 (2021) [5](#), [15](#)
- [54] Debs, N., Cho, T.-H., Rousseau, D., Berthezène, Y., Buisson, M., Eker, O., Mechtouff, L., Nighoghossian, N., Ovize, M., Frindel, C.: Impact of the reperfusion status for predicting the final stroke infarct using deep learning. *NeuroImage: Clinical* **29**, 102548 (2021) [5](#), [7](#), [8](#), [10](#), [19](#)
- [55] Goyal, M., Demchuk, A.M., Menon, B.K., Eesa, M., Rempel, J.L., Thornton, J., Roy, D., Jovin, T.G., Willinsky, R.A., Sapkota, B.L., *et al.*: Randomized assessment of rapid endovascular treatment of ischemic stroke. *New England Journal of Medicine* **372**(11), 1019–1030 (2015) [5](#)
- [56] Jovin, T.G., Chamorro, A., Cobo, E., Miquel, M.A., Molina, C.A., Rovira, A., San Román, L., Serena, J., Abilleira, S., Ribó, M., *et al.*: Thrombectomy within 8 hours after symptom onset in ischemic stroke. *New England Journal of Medicine* **372**(24), 2296–2306 (2015) [5](#)
- [57] Saver, J.L., Goyal, M., Bonafe, A., Diener, H.-C., Levy, E.I., Pereira, V.M., Albers, G.W., Cognard, C., Cohen, D.J., Hacke, W., *et al.*: Stent-retriever thrombectomy after intravenous t-pa vs. t-pa alone in stroke. *New England Journal of Medicine* **372**(24), 2285–2295 (2015) [5](#)
- [58] Campbell, B.C., Mitchell, P.J., Kleinig, T.J., Dewey, H.M., Churilov, L., Yassi, N., Yan, B., Dowling, R.J., Parsons, M.W., Oxley, T.J., *et al.*: Endovascular therapy for ischemic stroke with perfusion-imaging selection. *New England Journal of Medicine* **372**(11), 1009–1018 (2015) [5](#)
- [59] Rankin, J.: Cerebral vascular accidents in patients over the age of 60: II. prognosis. *Scottish medical journal* **2**(5), 200–215 (1957) [5](#)
- [60] Van Swieten, J., Koudstaal, P., Visser, M., Schouten, H., Van Gijn, J.: Interobserver agreement for the assessment of handicap in stroke patients. *Stroke* **19**(5), 604–607 (1988) [5](#)
- [61] Quinn, T.J., Dawson, J., Walters, M.R., Lees, K.R.: Reliability of the modified

- rankin scale: a systematic review. *Stroke* **40**(10), 3393–3395 (2009) **5**
- [62] Esmael, A., Elsherief, M., Eltoukhy, K.: Predictive value of the alberta stroke program early ct score (aspects) in the outcome of the acute ischemic stroke and its correlation with stroke subtypes, nihss, and cognitive impairment. *Stroke research and treatment* **2021**(1), 5935170 (2021) **6**
- [63] Deng, P.-P., Wu, N., Chen, X.-J., Chen, F.-L., Xu, H.-S., Bao, G.-S.: Nihss—the alberta stroke program early ct score mismatch in guiding thrombolysis in patients with acute ischemic stroke. *Journal of Neurology*, 1–7 (2022)
- [64] Han, B., Man, X., Ding, J., Li, Y., Tian, X., Zhu, X., Yu, J., Sun, J.: Subtyping treatment response of tirofiban in acute ischemic stroke based on neuroimaging features. *Clinical and Translational Science* **17**(1), 13686 (2024) **6**
- [65] Goyal, M., Menon, B.K., Coutts, S.B., Hill, M.D., Demchuk, A.M.: Effect of baseline ct scan appearance and time to recanalization on clinical outcomes in endovascular thrombectomy of acute ischemic strokes. *Stroke* **42**(1), 93–97 (2011) **6**
- [66] Demeestere, J., Scheldeman, L., Cornelissen, S.A., Heye, S., Wouters, A., Dupont, P., Christensen, S., Mlynash, M., Albers, G.W., Lansberg, M., *et al.*: Alberta stroke program early ct score versus computed tomographic perfusion to predict functional outcome after successful reperfusion in acute ischemic stroke. *Stroke* **49**(10), 2361–2367 (2018) **6**
- [67] Stier, N., Vincent, N., Liebeskind, D., Scalzo, F.: Deep learning of tissue fate features in acute ischemic stroke. In: 2015 IEEE International Conference on Bioinformatics and Biomedicine (BIBM), pp. 1316–1321 (2015). IEEE **7, 8, 19**
- [68] Choi, Y., Kwon, Y., Lee, H., Kim, B.J., Paik, M.C., Won, J.-H.: Ensemble of deep convolutional neural networks for prognosis of ischemic stroke. In: Crimi, A., Menze, B., Maier, O., Reyes, M., Winzeck, S., Handels, H. (eds.) *Brainlesion: Glioma, Multiple Sclerosis, Stroke and Traumatic Brain Injuries*, pp. 231–243. Springer, Cham (2016) **7, 8, 10, 16, 17, 19**
- [69] Nielsen, A., Hansen, M.B., Tietze, A., Mouridsen, K.: Prediction of tissue outcome and assessment of treatment effect in acute ischemic stroke using deep learning. *Stroke* **49**(6), 1394–1401 (2018) <https://doi.org/10.1161/strokeaha.117.019740> **7, 8, 10, 19**
- [70] Lucas, C., Kemmling, A., Bouteldja, N., Aulmann, L.F., Madany Mamlouk, A., Heinrich, M.P.: Learning to predict ischemic stroke growth on acute ct perfusion data by interpolating low-dimensional shape representations. *Frontiers in Neurology* **9**, 989 (2018) **8, 19, 22**
- [71] Pinto, A., Pereira, S., Meier, R., Alves, V., Wiest, R., Silva, C.A., Reyes,

- M.: Enhancing clinical MRI Perfusion maps with data-driven maps of complementary nature for lesion outcome prediction. In: International Conference on Medical Image Computing and Computer-Assisted Intervention, pp. 107–115 (2018). Springer [7](#), [8](#), [9](#)
- [72] Ho, K.C., Scalzo, F., Sarma, K.V., Speier, W., El-Saden, S., Arnold, C.: Predicting ischemic stroke tissue fate using a deep convolutional neural network on source magnetic resonance perfusion images. *Journal of Medical Imaging* **6**(2), 026001 (2019) [8](#)
- [73] Debs, N., Decroocq, M., Cho, T.-H., Rousseau, D., Frindel, C.: Evaluation of the realism of an MRI simulator for stroke lesion prediction using convolutional neural network. In: Simulation and Synthesis in Medical Imaging, pp. 151–160 (2019). [https://doi.org/10.1007/978-3-030-32778-1\\_16](https://doi.org/10.1007/978-3-030-32778-1_16) . Springer [8](#), [13](#)
- [74] Barros, R.S., Tolhuisen, M.L., Boers, A.M., Jansen, I., Ponomareva, E., Dippel, D.W.J., Lugt, A., Oostenbrugge, R.J., Zwam, W.H., Berkhemer, O.A., Goyal, M., Demchuk, A.M., Menon, B.K., Mitchell, P., Hill, M.D., Jovin, T.G., Davalos, A., Campbell, B.C.V., Saver, J.L., Roos, Y.B.W.E.M., Muir, K.W., White, P., Bracad, S., Guillemin, F., Olabariaga, S.D., Majoie, C.B.L.M., Marquering, H.A.: Automatic segmentation of cerebral infarcts in follow-up computed tomography images with convolutional neural networks. *Journal of NeuroInterventional Surgery* **12**(9), 848–852 (2019) <https://doi.org/10.1136/neurintsurg-2019-015471> [8](#)
- [75] Debs, N., Rasti, P., Victor, L., Cho, T.-H., Frindel, C., Rousseau, D.: Simulated perfusion MRI data to boost training of convolutional neural networks for lesion fate prediction in acute stroke. *Computers in Biology and Medicine* **116**, 103579 (2020) <https://doi.org/10.1016/j.combiomed.2019.103579> [8](#), [13](#)
- [76] Yu, Y., Xie, Y., Thamm, T., Gong, E., Ouyang, J., Huang, C., Christensen, S., Marks, M.P., Lansberg, M.G., Albers, G.W., *et al.*: Use of deep learning to predict final ischemic stroke lesions from initial magnetic resonance imaging. *JAMA network open* **3**(3), 200772–200772 (2020) [7](#), [8](#), [11](#)
- [77] Lucas, C., Aulmann, L.F., Kemmling, A., Mamlouk, A.M., Heinrich, M.P.: Estimation of the principal ischaemic stroke growth directions for predicting tissue outcomes. In: Brainlesion: Glioma, Multiple Sclerosis, Stroke and Traumatic Brain Injuries, pp. 69–79 (2020). [https://doi.org/10.1007/978-3-030-46640-4\\_7](https://doi.org/10.1007/978-3-030-46640-4_7) . Springer [8](#)
- [78] Robben, D., Boers, A.M., Marquering, H.A., Langezaal, L.L., Roos, Y.B., Oostenbrugge, R.J., Zwam, W.H., Dippel, D.W., Majoie, C.B., Lugt, A., *et al.*: Prediction of final infarct volume from native ct perfusion and treatment parameters using deep learning. *Medical Image Analysis* **59**, 101589 (2020) [8](#), [9](#), [19](#)

- [79] Pinto, A., Amorim, J., Hakim, A., Alves, V., Reyes, M., Silva, C.A.: Prediction of stroke lesion at 90-day follow-up by fusing raw DSC-MRI with parametric maps using deep learning. *IEEE Access* **9**, 26260–26270 (2021) <https://doi.org/10.1109/access.2021.3058297> 8, 10
- [80] Hokkinen, L., Mäkelä, T., Savolainen, S., Kangasniemi, M.: Computed tomography angiography-based deep learning method for treatment selection and infarct volume prediction in anterior cerebral circulation large vessel occlusion. *Acta Radiologica Open* **10**(11), 205846012110603 (2021) <https://doi.org/10.1177/20584601211060347> 8, 20
- [81] Chen, Z., Li, Q., Li, R., Zhao, H., Li, Z., Zhou, Y., Bian, R., Jin, X., Lou, M., Bai, R.: Ensemble learning accurately predicts the potential benefits of thrombolytic therapy in acute ischemic stroke. *Quantitative Imaging in Medicine and Surgery* **11**(9), 3978–3989 (2021) <https://doi.org/10.21037/qims-21-33> 7, 8, 10
- [82] He, Y., Luo, Z., Zhou, Y., Xue, R., Li, J., Hu, H., Yan, S., Chen, Z., Wang, J., Lou, M.: U-net models based on computed tomography perfusion predict tissue outcome in patients with different reperfusion patterns. *Translational Stroke Research* **13**(5), 707–715 (2022) <https://doi.org/10.1007/s12975-022-00986-w> 8, 20
- [83] Winder, A.J., Wilms, M., Amador, K., Flottmann, F., Fiehler, J., Forkert, N.D.: Predicting the tissue outcome of acute ischemic stroke from acute 4d computed tomography perfusion imaging using temporal features and deep learning. *Frontiers in Neuroscience* **16** (2022) <https://doi.org/10.3389/fnins.2022.1009654> 8, 19
- [84] Amador, K., Winder, A., Fiehler, J., Wilms, M., Forkert, N.D.: Hybrid spatio-temporal transformer network for predicting ischemic stroke lesion outcomes from 4d ct perfusion imaging. In: *International Conference on Medical Image Computing and Computer-Assisted Intervention*, pp. 644–654 (2022). Springer 7, 8, 10, 19, 22
- [85] Wouters, A., Robben, D., Christensen, S., Marquering, H.A., Roos, Y.B.W.E.M., Oostenbrugge, R.J., Zwam, W.H., Dippel, D.W.J., Majoie, C.B.L.M., Schonewille, W.J., Lugt, A., Lansberg, M., Albers, G.W., Suetens, P., Lemmens, R.: Prediction of stroke infarct growth rates by baseline perfusion imaging. *Stroke* **53**(2), 569–577 (2022) <https://doi.org/10.1161/strokeaha.121.034444> 8, 20
- [86] Lee, S., Sunwoo, L., Choi, Y., Jung, J.H., Jung, S.C., Won, J.-H.: Impact of diffusion–perfusion mismatch on predicting final infarction lesion using deep learning. *IEEE Access* **10**, 97879–97887 (2022) <https://doi.org/10.1109/access.2022.3204048> 7, 8, 22
- [87] Nazari-Farsani, S., Yu, Y., Armindo, R.D., Lansberg, M., Liebeskind, D.S.,

- Albers, G., Christensen, S., Levin, C.S., Zaharchuk, G.: Predicting final ischemic stroke lesions from initial diffusion-weighted images using a deep neural network. *NeuroImage: Clinical* **37**, 103278 (2023) <https://doi.org/10.1016/j.nicl.2022.103278> 7, 8, 19
- [88] Amador, K., Gutierrez, A., Winder, A., Fiehler, J., Wilms, M., Forkert, N.D.: Providing clinical context to the spatio-temporal analysis of 4d ct perfusion to predict acute ischemic stroke lesion outcomes. *Journal of Biomedical Informatics* **149**, 104567 (2024) <https://doi.org/10.1016/j.jbi.2023.104567> 7, 8, 9, 19
- [89] Palsson, F., Forkert, N.D., Meyer, L., Broocks, G., Flottmann, F., Maros, M.E., Bechstein, M., Winkelmeier, L., Schlemm, E., Fiehler, J., Gellißen, S., Kniep, H.C.: Prediction of tissue outcome in acute ischemic stroke based on single-phase ct angiography at admission. *Frontiers in Neurology* **15** (2024) <https://doi.org/10.3389/fneur.2024.1330497> 8, 19
- [90] Gutierrez, A., Amador, K., Winder, A., Wilms, M., Fiehler, J., Forkert, N.D.: Annotation-free prediction of treatment-specific tissue outcome from 4d ct perfusion imaging in acute ischemic stroke. *Computerized Medical Imaging and Graphics* **114**, 102376 (2024) <https://doi.org/10.1016/j.compmedimag.2024.102376> 8, 11, 12, 20, 21
- [91] Gaudinski, M.R., Henning, E.C., Miracle, A., Luby, M., Warach, S., Latour, L.L.: Establishing final infarct volume: stroke lesion evolution past 30 days is insignificant. *Stroke* **39**(10), 2765–2768 (2008) 7
- [92] Krongold, M., Almekhlafi, M.A., Demchuk, A.M., Coutts, S.B., Frayne, R., Eilaghi, A.: Final infarct volume estimation on 1-week follow-up mr imaging is feasible and is dependent on recanalization status. *NeuroImage: Clinical* **7**, 1–6 (2015) 7
- [93] Liu, Y., Yu, Y., Ouyang, J., Jiang, B., Yang, G., Ostmeier, S., Wintermark, M., Michel, P., Liebeskind, D.S., Lansberg, M.G., Albers, G.W., Zaharchuk, G.: Functional outcome prediction in acute ischemic stroke using a fused imaging and clinical deep learning model. *Stroke* **54**(9), 2316–2327 (2023) <https://doi.org/10.1161/strokeaha.123.044072> 7, 16, 17, 20
- [94] Nguyen, V., Pien, H., Menezes, N., Lopez, C., Melinosky, C., Wu, O., Sorensen, A., Cooperman, G., Ay, H., Koroshetz, W., *et al.*: Stroke tissue outcome prediction using a spatially-correlated model. *Program and Proceedings of PPIC* **8**, 238–241 (2008) 7
- [95] Badrinarayanan, V., Kendall, A., Cipolla, R.: Segnet: A deep convolutional encoder-decoder architecture for image segmentation. *IEEE transactions on pattern analysis and machine intelligence* **39**(12), 2481–2495 (2017) 7
- [96] Kamnitsas, K., Ledig, C., Newcombe, V.F.J., Simpson, J.P., Kane, A.D., Menon,



- D.K., Rueckert, D., Glocker, B.: Efficient multi-scale 3D CNN with fully connected CRF for accurate brain lesion segmentation. *Medical Image Analysis* **36**, 61–78 (2017) [9](#)
- [97] Davalos, A., Blanco, M., Pedraza, S., Leira, R., Castellanos, M., Pumar, J., Silva, Y., Serena, J., Castillo, J.: The clinical–dwi mismatch: a new diagnostic approach to the brain tissue at risk of infarction. *Neurology* **62**(12), 2187–2192 (2004) [10](#)
- [98] Ronneberger, O., Fischer, P., Brox, T.: U-net: Convolutional networks for biomedical image segmentation. In: *Medical Image Computing and Computer-assisted intervention–MICCAI 2015: 18th International Conference, Munich, Germany, October 5–9, 2015, Proceedings, Part III* 18, pp. 234–241 (2015). Springer [10](#), [12](#)
- [99] Oktay, O., Schlemper, J., Folgoc, L.L., Lee, M., Heinrich, M., Misawa, K., Mori, K., McDonagh, S., Hammerla, N.Y., Kainz, B., et al.: Attention u-net: Learning where to look for the pancreas. *arXiv preprint arXiv:1804.03999* (2018) [11](#)
- [100] Zaharchuk, G., Marks, M.P., Do, H.M., Bammer, R., Lansberg, M., Kemp, S., Albers, G.W., Investigators: Abstract w mp16: Introducing the imaging the collaterals in acute stroke (icas) multicenter mri trial. *Stroke* **46**(suppl.1), 16–16 (2015) [12](#)
- [101] Xia, X., Zhang, X., Cui, J., Jiang, Q., Guan, S., Liang, K., Wang, H., Wang, C., Huang, C., Dong, H., Han, K., Meng, X.: Difference of mean hounsfield units (dHU) between follow-up and initial noncontrast CT scan predicts 90-day poor outcome in spontaneous supratentorial acute intracerebral hemorrhage with deep convolutional neural networks. *NeuroImage: Clinical* **38**, 103378 (2023) <https://doi.org/10.1016/j.nicl.2023.103378> [13](#), [14](#), [19](#), [20](#)
- [102] Osama, S., Zafar, K., Sadiq, M.U.: Predicting clinical outcome in acute ischemic stroke using parallel multi-parametric feature embedded siamese network. *Diagnostics* **10**(11), 858 (2020) [13](#), [14](#), [19](#)
- [103] Moulton, E., Valabregue, R., Piotin, M., Marnat, G., Saleme, S., Lapergue, B., Lehericy, S., Clarencon, F., Rosso, C.: Interpretable deep learning for the prognosis of long-term functional outcome post-stroke using acute diffusion weighted imaging. *Journal of Cerebral Blood Flow & Metabolism* **43**(2), 198–209 (2022) <https://doi.org/10.1177/0271678x221129230> [13](#), [14](#), [20](#)
- [104] Fang, W.-H., Chen, Y.-C., Tsai, M.-C., Ko, P.-S., Wang, D.-L., Su, S.-L.: Novel and efficient quantitative posterior-circulation-structure-based scale via noncontrast CT to predict ischemic stroke prognosis: A retrospective study. *Journal of Personalized Medicine* **12**(2), 138 (2022) <https://doi.org/10.3390/jpm12020138> [13](#), [14](#), [19](#), [20](#)

- [105] Lai, Y.-L., Wu, Y.-D., Yeh, H.-J., Wu, Y.-T., Tsai, H.-Y., Chen, J.-C.: Using convolutional neural network to analyze brain mri images for predicting functional outcomes of stroke. *Medical & Biological Engineering & Computing* **60**(10), 2841–2849 (2022) <https://doi.org/10.1007/s11517-022-02636-7> 13, 14
- [106] Tolhuisen, M.L., Hoving, J.W., Koopman, M.S., Kappelhof, M., Voorst, H., Bruggeman, A.E., Demchuck, A.M., Dippel, D.W.J., Emmer, B.J., Bracard, S., Guillemin, F., Oostenbrugge, R.J., Mitchell, P.J., Zwam, W.H., Hill, M.D., Roos, Y.B.W.E.M., Jovin, T.G., Berkhemer, O.A., Campbell, B.C.V., Saver, J., White, P., Muir, K.W., Goyal, M., Marquering, H.A., Majoie, C.B., Caan, M.W.A.: Outcome prediction based on automatically extracted infarct core image features in patients with acute ischemic stroke. *Diagnostics* **12**(8), 1786 (2022) <https://doi.org/10.3390/diagnostics12081786> 13, 14, 15, 20, 21
- [107] Jacobsen, J.-H., Van Gemert, J., Lou, Z., Smeulders, A.W.: Structured receptive fields in cnns. In: *Proceedings of the IEEE Conference on Computer Vision and Pattern Recognition*, pp. 2610–2619 (2016) 13
- [108] Selvaraju, R.R., Cogswell, M., Das, A., Vedantam, R., Parikh, D., Batra, D.: Grad-cam: Visual explanations from deep networks via gradient-based localization. In: *Proceedings of the IEEE International Conference on Computer Vision*, pp. 618–626 (2017) 13
- [109] Marcus, A., Bentley, P., Rueckert, D.: Stroke outcome and evolution prediction from ct brain using a spatiotemporal diffusion autoencoder. In: *International Workshop on Machine Learning in Clinical Neuroimaging*, pp. 153–162 (2023). Springer 14, 15, 19
- [110] Yang, T.-H., Su, Y.-Y., Tsai, C.-L., Lin, K.-H., Lin, W.-Y., Sung, S.-F.: Magnetic resonance imaging-based deep learning imaging biomarker for predicting functional outcomes after acute ischemic stroke. *European Journal of Radiology* **174**, 111405 (2024) <https://doi.org/10.1016/j.ejrad.2024.111405> 14, 19
- [111] Yang, Y., Guo, Y.: Ischemic stroke outcome prediction with diversity features from whole brain tissue using deep learning network. *Frontiers in Neurology* **15**, 1394879 (2024) 14, 20
- [112] Lapergue, B., Blanc, R., Gory, B., Labreuche, J., Duhamel, A., Marnat, G., Saleme, S., Costalat, V., Bracard, S., Desal, H., *et al.*: Effect of endovascular contact aspiration vs stent retriever on revascularization in patients with acute ischemic stroke and large vessel occlusion: the aster randomized clinical trial. *Jama* **318**(5), 443–452 (2017) 14
- [113] Rosso, C., Corvol, J.-C., Pires, C., Crozier, S., Attal, Y., Jacqueminet, S., Deltour, S., Multlu, G., Leger, A., Meresse, I., *et al.*: Intensive versus subcutaneous insulin in patients with hyperacute stroke: results from the randomized insulininfarct trial. *Stroke* **43**(9), 2343–2349 (2012) 14

- [114] Rosso, C., Blanc, R., Ly, J., Samson, Y., Lehericy, S., Gory, B., Marnat, G., Mazighi, M., Consoli, A., Labreuche, J., *et al.*: Impact of infarct location on functional outcome following endovascular therapy for stroke. *Journal of Neurology, Neurosurgery & Psychiatry* **90**(3), 313–319 (2019) [14](#)
- [115] Maier, O., Menze, B.H., Gablentz, J., Häni, L., Heinrich, M.P., Liebrand, M., Winzeck, S., Basit, A., Bentley, P., Chen, L., *et al.*: Isles 2015-a public evaluation benchmark for ischemic stroke lesion segmentation from multispectral mri. *Medical Image Analysis* **35**, 250–269 (2017) [15](#)
- [116] Samak, Z.A., Clatworthy, P., Mirmehdi, M.: Prediction of thrombectomy functional outcomes using multimodal data. In: *Medical Image Understanding and Analysis*, pp. 267–279. Springer, Cham (2020) [15](#), [16](#), [17](#), [19](#), [20](#), [22](#)
- [117] Ding, L., Liu, Z., Mane, R., Wang, S., Jing, J., Fu, H., Wu, Z., Li, H., Jiang, Y., Meng, X., Zhao, X., Liu, T., Wang, Y., Li, Z.: Predicting functional outcome in patients with acute brainstem infarction using deep neuroimaging features. *European Journal of Neurology* **29**(3), 744–752 (2021) <https://doi.org/10.1111/ene.15181> [17](#)
- [118] Herzog, L., Kook, L., Hamann, J., Globas, C., Heldner, M.R., Seiffge, D., Antonenko, K., Dobrocky, T., Panos, L., Kaesmacher, J., Fischer, U., Gralla, J., Arnold, M., Wiest, R., Luft, A.R., Sick, B., Wegener, S.: Deep learning versus neurologists: Functional outcome prediction in LVO stroke patients undergoing mechanical thrombectomy. *Stroke* **54**(7), 1761–1769 (2023) <https://doi.org/10.1161/strokeaha.123.042496> [15](#), [17](#), [18](#), [20](#), [22](#)
- [119] Bacchi, S., Zerner, T., Oakden-Rayner, L., Kleinig, T., Patel, S., Jannes, J.: Deep learning in the prediction of ischaemic stroke thrombolysis functional outcomes: A pilot study. *Academic Radiology* **27**(2), 19–23 (2020) <https://doi.org/10.1016/j.acra.2019.03.015> [16](#), [17](#)
- [120] Zihni, E., Madai, V.I., Khalil, A.A., Galinovic, I., Fiebach, J.B., Kelleher, J.D., Frey, D., Livne, M.: Multimodal fusion strategies for outcome prediction in stroke. In: *HEALTHINF*, pp. 421–428 (2020) [16](#), [17](#), [22](#)
- [121] Heo, T.S., Kim, Y.S., Choi, J.M., Jeong, Y.S., Seo, S.Y., Lee, J.H., Jeon, J.P., Kim, C.: Prediction of stroke outcome using natural language processing-based machine learning of radiology report of brain MRI. *Journal of Personalized Medicine* **10**(4), 286 (2020) <https://doi.org/10.3390/jpm10040286> [17](#), [19](#)
- [122] Ramos, L.A., Os, H., Hilbert, A., Olabarriaga, S.D., Lugt, A., Roos, Y.B.W.E.M., Zwam, W.H., Walderveen, M.A.A., Ernst, M., Zwinderman, A.H., Strijkers, G.J., Majoie, C.B.L.M., Wermer, M.J.H., Marquering, H.A.: Combination of radiological and clinical baseline data for outcome prediction of patients with an acute ischemic stroke. *Frontiers in Neurology* **13** (2022) <https://doi.org/10.3389/fneur.2022.809343> [16](#), [17](#), [19](#), [20](#), [22](#)

- [123] Hatami, N., Cho, T.-H., Mechtouff, L., Eker, O.F., Rousseau, D., Frindel, C.: Cnn-lstm based multimodal mri and clinical data fusion for predicting functional outcome in stroke patients. In: 2022 44th Annual International Conference of the IEEE Engineering in Medicine & Biology Society (EMBC), pp. 3430–3434 (2022). IEEE [17](#)
- [124] Chen, Y., Tozer, D.J., Liu, W., Peake, E.J., Markus, H.S.: Prediction of response to thrombolysis in acute stroke using neural network analysis of CT perfusion imaging. *European Stroke Journal* **8**(3), 629–637 (2023) <https://doi.org/10.1177/23969873231183206> [16](#), [17](#), [19](#), [20](#), [22](#)
- [125] Hung, L.-C., Su, Y.-Y., Sun, J.-M., Huang, W.-T., Sung, S.-F.: Clinical narratives as a predictor for prognosticating functional outcomes after intracerebral hemorrhage. *Journal of the Neurological Sciences* **453**, 120807 (2023) <https://doi.org/10.1016/j.jns.2023.120807> [17](#), [19](#)
- [126] Shen, G.-C., Hang, Y., Ma, G., Lu, S.-S., Wang, C., Shi, H.-B., Wu, F.-Y., Xu, X.-Q., Liu, S.: Prognostic value of multiphase CT angiography: estimated infarct core volume in the patients with acute ischaemic stroke after mechanical thrombectomy. *Clinical Radiology* **78**(11), 815–822 (2023) <https://doi.org/10.1016/j.crad.2023.07.015> [17](#)
- [127] Zeng, M., Xie, Y., To, M.-S., Oakden-Rayner, L., Whitbread, L., Bacchi, S., Bird, A., Smith, L., Scroop, R., Kleinig, T., *et al.*: Improved flexibility and interpretability of large vessel stroke prognostication using image synthesis and multi-task learning. In: International Conference on Medical Image Computing and Computer-Assisted Intervention, pp. 696–705 (2023). Springer [17](#)
- [128] Oliveira, G., Fonseca, A.C., Ferro, J., Oliveira, A.L.: Deep learning-based extraction of biomarkers for the prediction of the functional outcome of ischemic stroke patients. *Diagnostics* **13**(24), 3604 (2023) <https://doi.org/10.3390/diagnostics13243604> [17](#), [22](#)
- [129] Borsos, B., Allaart, C.G., Halteren, A.: Predicting stroke outcome: A case for multimodal deep learning methods with tabular and ct perfusion data. *Artificial Intelligence in Medicine* **147**, 102719 (2024) <https://doi.org/10.1016/j.artmed.2023.102719> [17](#), [19](#)
- [130] Pölsterl, S., Wolf, T.N., Wachinger, C.: Combining 3d image and tabular data via the dynamic affine feature map transform. In: Medical Image Computing and Computer Assisted Intervention–MICCAI 2021: 24th International Conference, Strasbourg, France, September 27–October 1, 2021, Proceedings, Part V 24, pp. 688–698 (2021). Springer [17](#)
- [131] Jo, H., Kim, C., Gwon, D., Lee, J., Lee, J., Park, K.M., Park, S.: Combining clinical and imaging data for predicting functional outcomes after acute ischemic stroke: an automated machine learning approach. *Scientific Reports* **13**(1) (2023)

<https://doi.org/10.1038/s41598-023-44201-8> 17

- [132] Jung, H.-S., Lee, E.-J., Chang, D.-I., Cho, H.J., Lee, J., Cha, J.-K., Park, M.-S., Yu, K.H., Jung, J.-M., Ahn, S.H., *et al.*: A multimodal ensemble deep learning model for functional outcome prognosis of stroke patients. *Journal of Stroke* **26**(2), 312–320 (2024) 17, 21
- [133] Diprose, J.P., Diprose, W.K., Chien, T.-Y., Wang, M.T.M., McFetridge, A., Tarr, G.P., Ghate, K., Beharry, J., Hong, J., Wu, T., Campbell, D., Barber, P.A.: Deep learning on pre-procedural computed tomography and clinical data predicts outcome following stroke thrombectomy. *Journal of NeuroInterventional Surgery*, 2023–021154 (2024) <https://doi.org/10.1136/jnis-2023-021154> 17, 19, 22
- [134] Liu, Y., Shah, P., Yu, Y., Horsey, J., Ouyang, J., Jiang, B., Yang, G., Heit, J.J., McCullough-Hicks, M.E., Hugdal, S.M., Wintermark, M., Michel, P., Liebeskind, D.S., Lansberg, M.G., Albers, G.W., Zaharchuk, G.: A clinical and imaging fused deep learning model matches expert clinician prediction of 90-day stroke outcomes. *American Journal of Neuroradiology* **45**(4), 406–411 (2024) <https://doi.org/10.3174/ajnr.a8140> 17
- [135] Martín Vicario, C., Rodríguez Salas, D., Maier, A., Hock, S., Kuramatsu, J., Kallmuenzer, B., Thamm, F., Taubmann, O., Ditt, H., Schwab, S., Dörfler, A., Muehlen, I.: Uncertainty-aware deep learning for trustworthy prediction of long-term outcome after endovascular thrombectomy. *Scientific Reports* **14**(1) (2024) <https://doi.org/10.1038/s41598-024-55761-8> 17, 19, 20, 22
- [136] Liu, Y., Yu, Y., Ouyang, J., Jiang, B., Ostmeier, S., Wang, J., Lu-Liang, S., Yang, Y., Yang, G., Michel, P., *et al.*: Prediction of ischemic stroke functional outcomes from acute-phase noncontrast ct and clinical information. *Radiology* **313**(1), 240137 (2024) 17
- [137] Amador, K., Pinel, N., Winder, A., Fiehler, J., Wilms, M., Forkert, N.D.: A cross-attention-based deep learning approach for predicting functional stroke outcomes using 4d ctp imaging and clinical metadata. *Medical Image Analysis*, 103381 (2024) 17, 22
- [138] Wang, Q., Wu, B., Zhu, P., Li, P., Zuo, W., Hu, Q.: Eca-net: Efficient channel attention for deep convolutional neural networks. In: *Proceedings of the IEEE/CVF Conference on Computer Vision and Pattern Recognition*, pp. 11534–11542 (2020) 16
- [139] Kook, L., Herzog, L., Hothorn, T., Dürr, O., Sick, B.: Deep and interpretable regression models for ordinal outcomes. *Pattern Recognition* **122**, 108263 (2022) 18
- [140] Sloan, P., Clatworthy, P., Simpson, E., Mirmehdi, M.: Automated radiology

report generation: A review of recent advances. *IEEE Reviews in Biomedical Engineering* (2024) 19

- [141] Yeo, M., Kok, H.K., Kutaiba, N., Maingard, J., Thijs, V., Tahayori, B., Russell, J., Jhamb, A., Chandra, R.V., Brooks, M., Barras, C.D., Asadi, H.: Artificial intelligence in clinical decision support and outcome prediction – applications in stroke. *Journal of Medical Imaging and Radiation Oncology* **65**(5), 518–528 (2021) <https://doi.org/10.1111/1754-9485.13193> 19, 20
- [142] Chavva, I.R., Crawford, A.L., Mazurek, M.H., Yuen, M.M., Prabhat, A.M., Payabvash, S., Sze, G., Falcone, G.J., Matouk, C.C., Havenon, A., Kim, J.A., Sharma, R., Schiff, S.J., Rosen, M.S., Kalpathy-Cramer, J., Iglesias Gonzalez, J.E., Kimberly, W.T., Sheth, K.N.: Deep learning applications for acute stroke management. *Annals of Neurology* **92**(4), 574–587 (2022) <https://doi.org/10.1002/ana.26435> 20
- [143] Huang, S.-C., Pareek, A., Seyyedi, S., Banerjee, I., Lungren, M.P.: Fusion of medical imaging and electronic health records using deep learning: a systematic review and implementation guidelines. *NPJ digital medicine* **3**(1), 136 (2020) 21
- [144] Amador, K., Gutierrez, A., Winder, A., Fiehler, J., Wilms, M., Forkert, N.D.: Providing clinical context to the spatio-temporal analysis of 4d ct perfusion to predict acute ischemic stroke lesion outcomes. *Journal of Biomedical Informatics* **149**, 104567 (2024) 21
- [145] Guan, H., Yap, P.-T., Bozoki, A., Liu, M.: Federated learning for medical image analysis: A survey. *Pattern Recognition*, 110424 (2024) 21
- [146] Yan, R., Qu, L., Wei, Q., Huang, S.-C., Shen, L., Rubin, D.L., Xing, L., Zhou, Y.: Label-efficient self-supervised federated learning for tackling data heterogeneity in medical imaging. *IEEE Transactions on Medical Imaging* **42**(7), 1932–1943 (2023) 21