

Consistency of operator product expansions of Boundary 2d CFT and Swiss-cheese operad

Yuto Moriwaki *

Interdisciplinary Theoretical and Mathematical Science Program (iTHEMS)

Wako, Saitama 351-0198, Japan

Abstract

In this paper, we construct an action of the fundamental groupoid of the Swiss-cheese operad (the parenthesized permutation and braid operad) on C_1 -cofinite module categories of a vertex operator algebra. Based on this result, we show that when a boundary conformal field theory has locally C_1 -cofinite chiral symmetry, all operator product expansions converge absolutely on open regions in the configuration spaces of the upper half-plane and define real analytic functions (the correlation functions), independent of orders and parentheses of OPEs.

Contents

1. Vertex operator algebra and homotopy little 2-disk operad	9
1.1. Magma, trees and braids	9
1.2. Configuration space of \mathbb{C} and trees	11
1.3. Vertex operator algebra and trees	15
1.4. Conformal blocks on \mathbb{C}	19
1.5. Homotopy action of little 2-disk	22
2. Vertex operator algebra and Homotopy 2-Swiss-Cheese operad	24
2.1. 2-colored magma, trees and braids	24
2.2. Conformal block on $\overline{\mathbb{H}}$ and homotopy action of Swiss-Cheese operad .	26
3. Algebra of bulk-boundary 2d CFT and consistency	30
3.1. Bulk OPE algebra	31
3.2. Boundary OPE algebra	40
3.3. Bulk-boundary OPE algebra	44
Appendix A.	52
References	54

*email: moriwaki.yuto (at) gmail.com

Introduction

Conformal field theory can be defined using an algebraic structure on the state space F_{bulk} . This algebraic structure is called *the operator product expansion (OPE)* which in two dimensions defines infinitely many products of the following form:

$$(0.1) \quad a \cdot_z b = \sum_{r,s \in \mathbb{R}} a(r,s) b z^{-r-1} \bar{z}^{-s-1} \in F_{\text{bulk}}((z, \bar{z}, |z|^{\mathbb{R}})), \quad (a, b \in F_{\text{bulk}}).$$

Unlike ordinary algebra, (0.1) depends on the spacetime point $z \in \mathbb{C}^\times$, and the products have convergence regions where they are well-defined. The axioms of the algebra formed by the OPE on \mathbb{R}^d were proposed by Polyakov in physics and are called *the bootstrap equations* [Poly].

In two dimensions, conformal field theories with central charges smaller than 1 are classified using the bootstrap equation [BPZ, CIZ, Ka]. In three or more dimensions, numerical analysis based on the bootstrap equation also leads to the critical exponents of the Ising model with high accuracy [RRTV, EPPRSV]. In recent years, quantum field theories with higher structures, such as extended topological field theory and quantum field theory with boundaries and defects, have attracted much attention [BD, Lu, GKSW]. Among them, boundary conditions of a two-dimensional CFT correspond to D-branes in string theory, and it is important to mathematically consider them in order to understand the mirror symmetry [Kont, KO, Ploc2]. In physics, the bootstrap equations for boundary CFT are also known and are useful in construction and classification [Le].

Thus, the usefulness of the method of defining CFTs by the OPE and the bootstrap equation has been verified from various aspects. In the absence of boundaries (called a bulk CFT), the bootstrap equation is equivalent to the product \cdot_z being commutative and associative “in the sense of analytic continuation” [Mo2]. In the case of classical commutative associative algebra where the product does not depend on z , any r products is equal regardless of orders and parentheses (e.g. $(dc)(ab) = a(b(cd))$). Since the bootstrap equation is equivalent to being “commutative and associative”, one would expect the same to hold for the iterated compositions of OPEs. But in general, what radius of convergence do series such as $((a_1 \cdot_{z_1} a_2) \cdot_{z_2} a_3) \cdot_{z_3} a_4$ have? If convergent, does it depend on order and parenthesis? These questions are completely non-trivial [KQR]. We call this question the *consistency of OPEs*.

The purpose of this paper is to prove that for boundary 2d CFT and bulk 2d CFT “the bootstrap equations lead to the consistency” by giving the convergence regions of OPEs for all such ordering and parentheses under the assumption that the theory has a sufficiently large chiral symmetry (i.e., the state spaces are locally C_1 -cofinite modules of a vertex operator algebra).

Before going into more detail, we will briefly discuss boundary CFT. A boundary CFT is an algebra of OPEs on the upper half-plane:

$$\mathbb{H} = \{z \in \mathbb{C} \mid \text{Im } z > 0\} \quad \text{and} \quad \bar{\mathbb{H}} = \{z \in \mathbb{C} \mid \text{Im } z \geq 0\}.$$

operad	2d Conformal field theory		
E_2	$\cdot_z : F_{\text{bulk}} \otimes F_{\text{bulk}} \rightarrow F_{\text{bulk}}((z, \bar{z}, z ^{\mathbb{R}}))$	$z \in \mathbb{H}$	bulk OPE
E_1	$\cdot_x : F_{\text{bdy}} \otimes F_{\text{bdy}} \rightarrow F_{\text{bdy}}((x^{\mathbb{R}}))$	$x \in \mathbb{R}$	boundary OPE
SC_2	$\tau_y : F_{\text{bulk}} \rightarrow F_{\text{bdy}}((y^{\mathbb{R}}))$	$y = \text{Im } z \in \mathbb{R}_{>0}$	bulk-boundary OPE

TABLE 1. Algebras in two-dimension

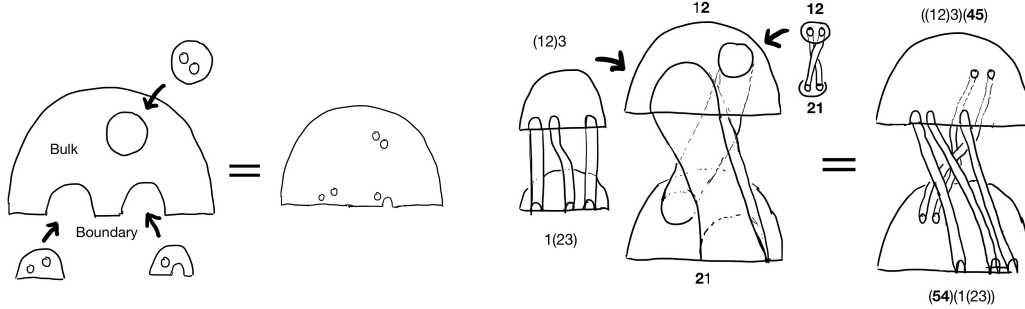

FIG. 1

FIG. 2

A 2d CFT without boundary is an analogue of an E_2 -algebra in topological field theory, and a 2d CFT with boundary is an analogue of an algebra of the Swiss-cheese operad [V] (Fig 1). Corresponding to the fact that the Swiss-cheese operad is a 2-colored operad, a boundary CFT is an algebra with two colors: boundary and interior (bulk). More specifically, it consists of two vector spaces F_{bulk} and F_{bdy} and two products (OPEs) \cdot_z and \cdot_x and one color-changing unary map τ_y (Table 1). The important observation is that the bootstrap equations of boundary CFT are exactly a generator, as a 2-colored operad, of the *parenthesized permutation and braid operad* $\underline{\text{PaPB}}$, which is the fundamental groupoid of the Swiss-cheese operad combinatorially introduced by Idrissi [Id] (Fig 2). Hence, the consistency follows from the bootstrap equations together with the $\underline{\text{PaPB}}$ action, which will be constructed in this paper.

Next, we mention the relation with the previous works on boundary 2d CFT. For bulk and boundary CFT with very large chiral symmetry, called regular vertex operator algebras, it is known that their construction and classification can be described in terms of modular tensor categories [MS, FFFS, FFRS, FRS]. Kong introduced an algebra called an *open-string field algebra* to directly define boundary CFT and constructed various examples using modular tensor categories [Ko1, Ko2, KR]. However, in considering the D-branes in string theory, it is necessary to consider a deformation family of boundary conditions (see [Moore]). Since boundary conditions with large symmetry, which can be described by the modular tensor category, cannot be deformed, to develop a foundation based on OPEs and the bootstrap equations is important to consider more general boundary conditions (see [Mo6] for a construction of boundary conditions that cannot be described by a modular tensor category based on the bootstrap equations). In the following, the bootstrap equations, the consistency of OPEs, and the chiral symmetry are explained in more detail.

0.1. Consistency of operator product expansion in bulk CFT

The most important physical quantities in two-dimensional conformal field theory (without boundary) are real analytic functions on the configuration space,

$$X_r(\mathbb{C}) = \{z_1, \dots, z_r \mid z_i \neq z_j\},$$

called the *correlation functions*. This is the probability amplitude of the state which $a_1, \dots, a_r \in F_{\text{bulk}}$ inserted at $(z_1, \dots, z_r) \in X_r(\mathbb{C})$ and a dual vector $u \in F_{\text{bulk}}^\vee$ inserted at $\infty \in \mathbb{C}P^1$. Mathematically, it defines the following linear map:

$$(0.2) \quad F_{\text{bulk}}^\vee \otimes F_{\text{bulk}}^{\otimes r} \rightarrow C^\omega(X_r(\mathbb{C})), \quad (u, a_1, \dots, a_r) \mapsto C_r(u, a_1, z_1, \dots, a_r, z_r),$$

where $C^\omega(X_r(\mathbb{C}))$ is the vector space of complex-valued real analytic functions on $X_r(\mathbb{C})$.

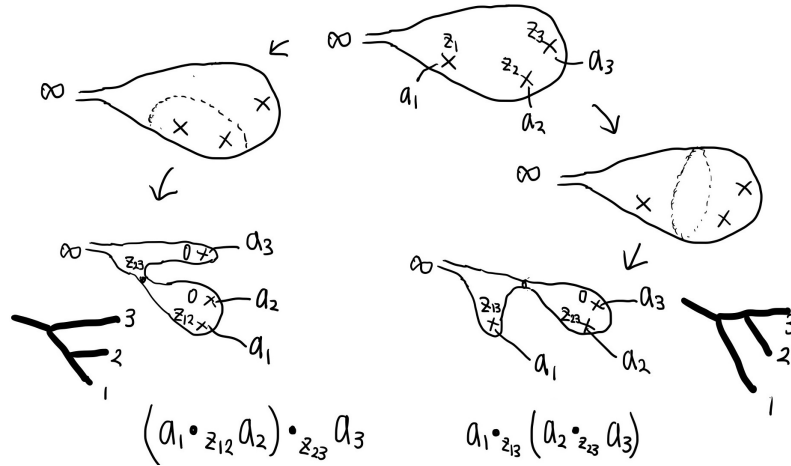

FIG. 3

From a standpoint of functorial quantum field theory, multi-point correlation functions should be able to be computed using a more fundamental piece,² the three-point correlation functions, by decomposing the Riemann surfaces into pants [Seg].

Note that the global conformal transformation $\text{PSL}_2\mathbb{C}$ acts 3-transitively on $\mathbb{C}P^1$, hence any three points (z_1, z_2, z_3) can be sent to $(\infty, z = \frac{z_2 - z_3}{z_1 - z_3}, 0)$. The parameter in the operator product expansion (0.1) corresponds exactly to this z -dependent fundamental piece. In particular, it is important to emphasize that for the OPE $a \cdot_z b$, a is placed at z and b is placed at 0 (see Fig 4).

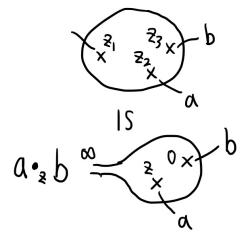

FIG. 4

As in Fig 3, the multipoint correlation functions can be calculated by the product of OPEs. Decompositions of the Riemann surface corresponds to binary trees in the case of

²The moduli of conformal structures of the pair of pants is parametrized by the radii of the three holes, but here we consider only the limit of radius 0 (see [Seg]). In the limit of radius 0, a partial operad of tubed Riemann surfaces of genus 0 was introduced by [Hu2].

genus 0, and corresponds to “orders and parentheses of OPEs”. From Fig 3, the OPE should satisfy the associativity:

$$(0.3) \quad (a_1 \cdot_{z_{12}} a_2) \cdot_{z_{23}} a_3 \stackrel{“=”}{=} a_1 \cdot_{z_{13}} (a_2 \cdot_{z_{23}} a_3),$$

where $z_{ij} = z_i - z_j$, and the reason why these variables appear is shown in Fig 4. From the permutation symmetry of the correlation functions (locality), the OPE should satisfy

$$(0.4) \quad \exp(L(-1)z_2 + \bar{L}(-1)\bar{z}_2)a_1 \cdot_{z_{12}} a_2 \stackrel{“=”}{=} \exp(L(-1)z_1 + \bar{L}(-1)\bar{z}_1)a_2 \cdot_{z_{21}} a_1,$$

where $L(-1)$ and $\bar{L}(-1)$ are the translation operators to place a_1 and a_2 at z_1 and z_2 instead of 0. (0.3) and (0.4) are equivalent to the bootstrap equation in physics [Mo2]. In [Mo1] we called the algebra satisfying (0.3) and (0.4) a *full vertex operator algebra* (see Section 3.1 for precise definitions, and see also [HK1, Theorem 2.11]). There are various examples of full vertex operator algebras [HK1, Mo1, Mo4, Mo3].

The left-hand-side of (0.3) corresponds to the left side of Fig 3, where a_1 and a_2 are close and a_3 are far apart, and converge absolutely to real analytic function in the open region of $X_3(\mathbb{C})$:

$$U_{(12)3} = \{(z_1, z_2, z_3) \in X_3(\mathbb{C}) \mid |z_1 - z_2| < |z_2 - z_3|\}.$$

Similarly, the right-hand side absolutely converges in $U_{1(23)} = \{(z_1, z_2, z_3) \in X_3(\mathbb{C}) \mid |z_2 - z_3| < |z_1 - z_3|\}$.

The consistency of the OPE of a CFT without boundary can be stated as follows: Let \mathcal{T}_r be the set of all binary trees with leaves labeled by $\{1, \dots, r\}$. In (0.3), the variables change according to the shapes of the trees. We give the rule of changes of variables in Section 1.3 for any $A \in \mathcal{T}_r$. The open polydisk region $U_A \subset X_r(\mathbb{C})$ in which the OPEs should absolutely converge is given in Section 1.3 and 2.2. A full vertex operator algebra $(F_{\text{bulk}}, \cdot_z)$ is *consistent* if there is a sequence of real analytic functions (0.2) and the following holds for any tree $A \in \mathcal{T}_r$:

$$(0.5) \quad C_r(a_1, z_1, \dots, a_r, z_r)|_{U_A} = \text{OPEs of } a_1, \dots, a_r \text{ of the form } A,$$

where the left-hand side is the restriction of C_r to the open region U_A (see Definition 3.7 for precise statement). This means that the correlation functions are well-defined from the OPE, independent of pants decompositions up to the analytic continuation. This is proved in Section 3.1 under an assumption on chiral symmetry (local C_1 -cofiniteness).

In [AMT], we show that if a full vertex algebra satisfies unitarity and certain growth conditions, then this sequence of correlation functions satisfies the *Osterwalder-Schrader axioms* [OS1, OS2], which is a mathematical definition of a general quantum field theory (not necessarily have conformal symmetry). Thus, the bootstrap equations gives examples of the axiomatic quantum field theory.

0.2. Consistency of operator product expansion in boundary CFT

In the case of conformal field theory with boundary, there is a vector space F_{bulk} for states at the interior (bulk) of the upper half-plane \mathbb{H} and another vector space for states at the boundary $\mathbb{R} = \overline{\mathbb{H}} \setminus \mathbb{H}$. The correlation function of the state which bulk states $a_1, \dots, a_r \in F_{\text{bulk}}$ inserted at $z_1, \dots, z_r \in \mathbb{H}$ and boundary states $b_1, \dots, b_s \in F_{\text{bdy}}$ inserted at $x_1, \dots, x_s \in \mathbb{R}$ is a real analytic function on:

$$X_{r,s}(\overline{\mathbb{H}}) = \{(z_1, \dots, z_r, x_1, \dots, x_s) \mid \mathbb{H}^r \times \mathbb{R}^s \mid z_i \neq z_j \text{ and } x_k > x_l \text{ for } k < l\},$$

which defines the following linear map:

$$(0.6) \quad C_{r,s} : F_{\text{bdy}}^{\vee} \otimes F_{\text{bulk}}^{\otimes r} \otimes F_{\text{bdy}}^{\otimes s} \rightarrow C^\omega(X_{r,s}(\overline{\mathbb{H}})).$$

The data defining a boundary CFT consists of three parts: an OPE \cdot^{bulk} on the bulk F_{bulk} and an OPE on the boundary F_{bdy} :

$$(0.7) \quad a \cdot_x^{\text{bdy}} b = \sum_{r \in \mathbb{R}} a(r) b x^{-r-1} \in F_{\text{bdy}}((x^{\mathbb{R}})), \quad (a, b \in F_{\text{bdy}})$$

for $x \in \mathbb{R}_{>0}$, and a linear map that associates a bulk state with a boundary state, called ³*bulk-boundary operator*:

$$(0.8) \quad \tau_y : F_{\text{bulk}} \rightarrow F_{\text{bdy}}((y^{\mathbb{R}})), \quad a \mapsto \sum_{r \in \mathbb{R}} \tau_r(a) y^r.$$

The parameter y in the bulk-boundary operator is the distance $y = \text{Im } z \in \mathbb{R}_{>0}$ between the bulk and the boundary (Fig 5).

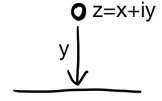

FIG. 5

On a straight line, \cdot^{bdy} is non-commutative, although it satisfies the associativity (0.3), since any attempt to swap the positions of two particles will result in a collision, which is known as non-commutativity in quantum mechanics. On the other hand, a bulk state and a boundary state can be exchanged without colliding with each other (Fig. 6). The following four conditions are the bootstrap equations for genus zero boundary CFT (see Definition 3.1, 3.15 and 3.25 for details):

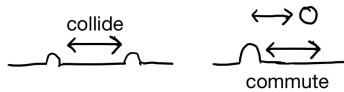

FIG. 6

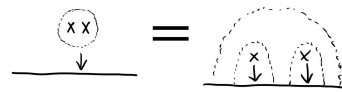

FIG. 7

- (1) Associativity (0.3) and Commutativity (0.4) of bulk OPE;
- (2) Associativity of boundary OPE;
- (3) Commutativity of bulk and boundary OPEs (Fig 6);
- (4) Compatibility of bulk and boundary OPEs (Fig 7).

³In [Ko1], $Y_{\text{bulk-bdy}}(\bullet, \underline{z}) : F_{\text{bulk}} \rightarrow \text{End} F_{\text{bdy}}[[z^{\mathbb{R}}, \bar{z}^{\mathbb{R}}]]$ is given as the defining data of the theory instead of τ_y . Under the assumptions of this paper, $Y_{\text{bulk-bdy}}$ can be recovered from τ_y . In particular, our results simplify Kong's results (see [Ko1, Theorem 1.28]).

The consistency of OPEs of boundary CFT can also be stated in the same way as in the bulk case, using trees. Let $\mathcal{T}_{r,s}^{\text{bdy}}$ be the set of all binary trees with leaves labeled with the 2-color labels $\{1, \dots, r\}$ and $\{1, \dots, s\}$. Note that $\mathcal{T}_{r,s}^{\text{bdy}}$ is isomorphic to a free 2-colored operad with three generators corresponding to $\cdot^{\text{bulk}}, \cdot^{\text{bdy}}, \tau$. As in the bulk theory, for each $E \in \mathcal{T}_{r,s}^{\text{bdy}}$, the corresponding OPE and the open polydisk region $U_E \subset X_{r,s}(\overline{\mathbb{H}})$ in which the OPE should converge are given in Section 2.2. We say the boundary CFT data $(F_{\text{bulk}}, F_{\text{bdy}}, \cdot^{\text{bulk}}, \cdot^{\text{bdy}}, \tau)$ is consistent if there is a sequence of real analytic functions (0.6) and the following holds for any tree $E \in \mathcal{T}_{r,s}^{\text{bdy}}$:

$$(0.9) \quad C_r(a_1, z_1, \dots, b_s, x_s)|_{U_E} = \text{OPE of } a_1, \dots, a_r, b_1, \dots, b_s \text{ of the form } E$$

(see Section 3.3 for precise statement). This will be proved under an assumption for chiral symmetry in Section 3.3. We remark that for CFTs with chiral symmetry of regular vertex operator algebras, which is a stronger condition than locally C_1 -cofinite, the existence of the bulk correlation functions were shown in [HK1] and the boundary correlation functions in [Ko1]. These papers, however, do not deal with general products parametrized by trees.

0.3. Chiral symmetry and conformal blocks

It is not known how to prove the convergence and consistency of OPEs in higher dimensions. Fortunately, in the case of two-dimensional conformal field theories, such analytic questions can be answered by representation theoretical methods. The Lie algebra of the two-dimensional conformal group $\text{SO}(3, 1) \cong \text{PSL}_2\mathbb{C}$ has an exceptional isomorphism $\mathfrak{so}(3, 1) \cong \mathfrak{sl}_2\mathbb{C} \oplus \mathfrak{sl}_2\mathbb{C}$. Let F_L (resp. F_R) be the subspace of F_{bulk} in which the right (resp. the left) $\mathfrak{sl}_2\mathbb{C}$ acts trivially. Then, F_L and F_R are closed under the OPE and define canonical subalgebras. Furthermore, the OPE of F_L is holomorphic and the OPE of F_R is anti-holomorphic [Mo1, Proposition 3.12]:

$$(0.10) \quad a \cdot_z b = \sum_{n \in \mathbb{Z}} a(n) b z^{-n-1} \in F_L((z)), \quad (a, b \in F_L).$$

Algebras with such holomorphic OPEs were formulated by Borchers and are called *vertex operator algebras (VOAs)* [Bo, FLM]. What is important is that any boundary CFT has the symmetry of the Virasoro VOA, often with a larger VOA symmetry.

Let V be a positive graded vertex operator algebra. When a boundary CFT has a symmetry of a VOA V , its correlation function is a solution of a system of differential equations called a *conformal block*. We showed in a previous paper that OPEs of the conformal block associated to C_1 -cofinite V -modules are absolutely convergent for all orders and parentheses [Mo5, Theorem 4.23]. This solves the problem of convergence of OPEs. On the other hand, the consistency question, (0.5) and (0.9), asks whether monodromies of the solution of the differential equation given by iterated products of OPEs are trivial? In [Mo5, Theorem 6.21], we showed that monodromies of OPEs are consistent with the operad structure of the fundamental groupoid $\Pi_1(X_r(\mathbb{C}))$ (parenthesized braid operad). In this paper, we extend this result to $\Pi_1(X_{r,s}(\overline{\mathbb{H}}))$ (parenthesized permutation and braid

oprad) (Fig. 2). (0.9) follows from the fact that the bootstrap equation is a generator of PaPB as a 2-colored operad.

Finally, we describe the organization of this paper. In Section 1, we review the result from [Mo5] that PaB acts on a representation category of a vertex operator algebra. We also define the convergence region $U_A \subset X_r(\mathbb{C})$ of OPEs and the change of variables in OPEs of the form $A \in \mathcal{T}_r$, and describe the consistency of a vertex operator algebra. In Section 2, we construct the action of the parenthesized permutation and braid operad PaPB $\subset \Pi_1(X_{r,s}(\overline{\mathbb{H}}))$ on representation categories of a vertex operator algebra and describe the convergence regions $U_E \subset X_{r,s}(\overline{\mathbb{H}})$ for $E \in \mathcal{T}_{r,s}^{\text{bdy}}$. In Section 3, we will formulate the bootstrap equations and show the consistency of the bulk and boundary OPEs based on them.

Acknowledgements

The author would like to thank Masahito Yamazaki, Yuji Tachikawa, Tomoyuki Arakawa, Mayuko Yamashita, Tomohiro Asano, Yoh Tanimoto, Maria Stella Adamo, Shuhei Ohyama and Kan Kitamura for valuable discussions. This work is supported by Grant-in Aid for Early-Career Scientists (24K16911) and FY2023 Incentive Research Projects (Riken).

Notations

We will use the following notations:

$$X_r(\mathbb{C}): = \{(z_1, \dots, z_r) \in \mathbb{C}^r \mid z_i \neq z_j \text{ for any } i \neq j\}$$

$$X_{r,s}(\overline{\mathbb{H}}): = \{(z_1, \dots, z_r, z_{r+1}, \dots, z_{r+s}) \in \mathbb{C}^{r+s} \mid \text{Im } z_i > 0 \text{ and } \text{Im } z_j = 0 \text{ for } i \leq r, j > r\}.$$

$$\Phi: X_{r,s}(\overline{\mathbb{H}}) \hookrightarrow X_{2r+s}(\mathbb{C}), \quad (z_1, \dots, z_r, z_{r+1}, \dots, z_{r+s}) \mapsto (z_1, \bar{z}_1, \dots, z_r, \bar{z}_r, z_{r+1}, \dots, z_{r+s})$$

$$[r]: = \{1, 2, \dots, r\}$$

\mathcal{T}_r : the set of all binary trees with r leaves labeled by $[r]$, §1.1

A : a binary tree in \mathcal{T}_r

$E(A)$: a set of all edges of A , §1.2

$\{z_A, x_A, \zeta_e\}_{e \in E(A)}$: a local coordinate of $X_r(\mathbb{C})$, §1.2

T_A : a space of formal power series in z_A, x_A, ζ_e , §1.2

U_A : a simply-connected open subset of $X_r(\mathbb{C})$ associated with A , §1.2

\overline{U}_A : an open subset of $X_r(\mathbb{C})$ without branch cut, §1.2

PaB: the parenthesized braid operad, §1.1

$\Omega\Omega$: the free 2-colored operad generated by the three elements, §2.1

$\mathcal{T}^c(r), \mathcal{T}^o(r, s)$: 2-colored operad of 2-colored trees, §2.1

$\tilde{\bullet}$: $\mathcal{T}^o(r, s) \rightarrow \mathcal{T}_{2r+s}$, $E \mapsto \tilde{E}$, embedding of trees §2.1

PaPB \bullet : the parenthesized permutation and braid operad, §2.1

U_A^c : an open subset of $X_r(\mathbb{C})$ associated with $A \in \mathcal{T}^c(r)$ §2.2

U_E^o : an open subset of $X_{r,s}(\overline{\mathbb{H}})$ associated with $E \in \mathcal{T}^o(r, s)$, §2.2

$\mathcal{P}\mathcal{E}\text{nd}_{C,D}^\bullet$: a 2-operad defined by coends associated with categories, §2.2

V : a (positive graded) vertex operator algebra, §1.3

$I_{\log} \begin{pmatrix} M_0 \\ M_1 M_2 \end{pmatrix}$: a vector space of logarithmic intertwining operators, §1.3

- $I_{(M_1 M_2)}^{(M_0)}$: a vector space of intertwining operators, §1.3
 $\underline{V\text{-mod}}_{f.g.}$: a category of all C_1 -cofinite V -modules, §1.3
 \mathcal{CB} : a chiral conformal block on $X_r(\mathbb{C})$ §1.4
 \mathcal{CB}^c : a full conformal block on $X_r(\mathbb{C}) \times X_r(\mathbb{C})$ §2.2
 \mathcal{CB}^o : a boundary conformal block on $X_{r,s}(\overline{\mathbb{H}})$, §2.2

1. VERTEX OPERATOR ALGEBRA AND HOMOTOPY LITTLE 2-DISK OPERAD

In this section, we review the result of [Mo5] that the fundamental groupoid of the little 2-disk operad (parenthesized braid operad) acts on conformal blocks of a vertex operator algebra. This result will be extended to conformal blocks defined on the upper-half plane in Section 2.1. In Section 1.1, we recall the definition of the parenthesized braid operad $\underline{\text{PaB}}$. In Section 1.2, we recall the open regions $U_A \subset X_r(\mathbb{C})$ associated with trees $A \in \mathcal{T}_r$. In Section 1.3, the consistency of operator product expansions of a vertex operator algebra is mathematically formulated. Section 1.4 and 1.5 recall the definition of conformal blocks, their glueings and the action of $\underline{\text{PaB}}$ on them.

1.1. Magma, trees and braids. Given a product (a binary operation), repeating them creates an n -ary operation. In general, n -ary operations depend on orders and parentheses of binary operations, and all possible n -ary operations have a one-to-one correspondence with binary trees (also known as magma operad). In this section, we first recall the magma operad, then impose it a two-dimensional/two-categorical commutativity, the parenthesized braid operad.

Let \mathcal{T}_r be the set of all binary trees whose leaves are labeled by $[r] = \{1, 2, \dots, r\}$. Each element in \mathcal{T}_r can be regarded as a parenthesized word of $\{1, 2, \dots, r\}$, that is, non-associative, non-commutative monomials on this set in which every letter appears exactly once. For example, $(5(23))((17)(64))$ corresponds to the tree in Fig. 8. Note that \mathcal{T}_0 consists of the empty word and \mathcal{T}_3 , for example, is a set of 12 elements

$$\mathcal{T}_0 = \{\emptyset\},$$

$$\mathcal{T}_3 = \{1(23), (12)3, 1(32), (13)2, 2(13), (21)3, 2(31), (23)1, 3(12), (31)2, 3(21), (32)1\}$$

and \mathcal{T}_4 consists of all permutations of 5 elements

$$\{(12)(34), 1(2(34)), 1((23)4), (1(23))4, ((12)3)4\}.$$

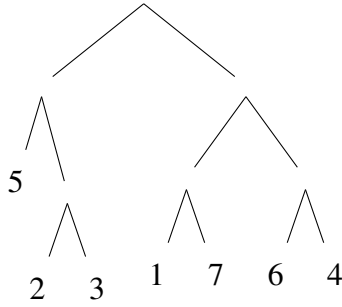

FIG. 8

Since binary trees describe the freest possible n -ary operations, it becomes a free operad generated from a single binary operation (the magma operad). More explicitly, its operad structure is described as follows:

Let $A \in \mathcal{T}_n$ and $B \in \mathcal{T}_m$ with $n > 0$ and $p \in [n]$. The partial composition of the operad is then defined as shown in Fig. 9. The figure shows the composition of $3((12)4) \circ_2 2(13)$. In general, $A \circ_p B$ is defined by inserting the tree B into the leaf labeled with p in A , adding $p - 1$ to labels of leaves in B , and adding $m - 1$ to the labels of leaves after $p + 1$ in A . If $B = \emptyset$, the p -th leaf in A is simply erased, and the numbers are shifted forward. For example,

$$3((12)4) \circ_2 \emptyset = 2(13).$$

The symmetric group S_r acts on \mathcal{T}_r by the permutation of labels, which satisfies the definition of a symmetric operad.

We next look back at the definition of the parenthesized braid operad $\underline{\text{PaB}}$ introduced in [Bar, Ta]. Let $\underline{\text{Cat}}_{\mathcal{C}}$ be the category of categories, i.e., objects are categories and morphisms are functors. By the direct product of categories, $\underline{\text{Cat}}_{\mathcal{C}}$ has a structure of a symmetric monoidal category. The notion of operad can be considered in any symmetric monoidal category, and $\underline{\text{PaB}}$ is an operad object in $\underline{\text{Cat}}_{\mathcal{C}}$.

For each $r \geq 1$, $\underline{\text{PaB}}(r)$ is the category defined as follows: The set of all objects in $\underline{\text{PaB}}(r)$ is the set of binary trees \mathcal{T}_r ,

$$\text{Ob}(\underline{\text{PaB}}(r)) = \mathcal{T}_r.$$

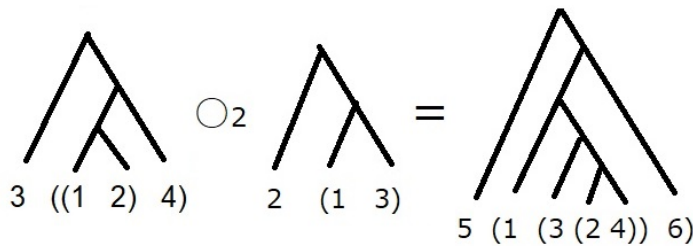
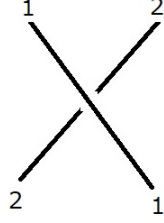
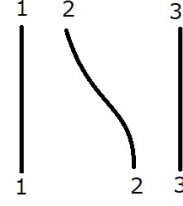
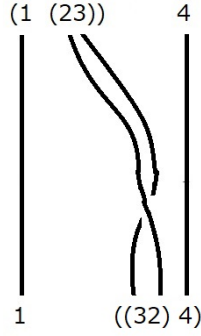
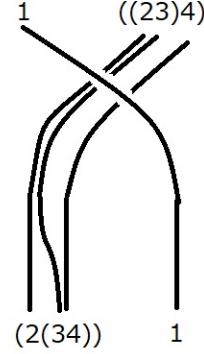

FIG. 9. $3((12)4) \circ_2 2(13)$

FIG. 10. morphism σ FIG. 11. morphism α FIG. 12. morphism $\alpha \circ_2 \sigma$ FIG. 13. morphism $\alpha \circ_2 \sigma$

Let $p : B_r \rightarrow S_r$ be the canonical projection from the braid group to the symmetric group whose kernel is the pure braid group PB_r . Let denote by $g : \mathcal{T}_r \rightarrow S_r$ the map given by forgetting the parenthesization and viewing trees as permutations. Then, for $A, B \in \mathcal{T}_r$, the space of homomorphisms is defined by

$$(1.1) \quad \text{Hom}_{\underline{\text{PaB}}(r)}(A, B) = \mathbb{C}p^{-1}(g_A^{-1}g_B),$$

where $\mathbb{C}p^{-1}(g_A^{-1}g_B)$ is a \mathbb{C} -linear space with a basis $p^{-1}(g_A^{-1}g_B)$. The composition law is induced from the one on B_r . The symmetric group S_r acts on $\underline{\text{PaB}}(r)$ via renumbering the objects \mathcal{T}_r and acts identically on morphisms. The composition

$$\circ_p : \underline{\text{PaB}}(n) \times \underline{\text{PaB}}(m) \rightarrow \underline{\text{PaB}}(n + m - 1)$$

is given by replacing the p -th strand of the first braid, by the second braid made very thin (see Fig. 10, 11, 12). This composition is consistent with the magma operad when restricted to objects.

For $r = 0$, $\underline{\text{PaB}}(0)$ is a category whose object is the only empty parenthesized word \emptyset and whose morphism consists only of the identity map $\text{Hom}(\emptyset, \emptyset) = \mathbb{C}\{\text{id}\}$. The composition

$$\circ_p : \underline{\text{PaB}}(n) \times \underline{\text{PaB}}(0) \rightarrow \underline{\text{PaB}}(n - 1)$$

is given by just erasing the p -th strand.

1.2. Configuration space of \mathbb{C} and trees. For $r \geq 1$, set

$$X_r(\mathbb{C}) = \{(z_1, \dots, z_r) \in \mathbb{C}^r \mid z_i \neq z_j \text{ for any } i \neq j\},$$

which is called *an r -point configuration space*. A chiral conformal block is a multi-valued holomorphic function on $X_r(\mathbb{C})$, which have a possible branch singularities along $\{z_i = z_j\}$. In this section, we recall the definition of simply-connected open domains $U_A \subset X_r(\mathbb{C})$ for each tree $A \in \mathcal{T}_r$. By considering conformal blocks on U_A , these open domains serve as a link between the parenthesized braid operad and operator product expansions of 2d conformal field theory (see [Mo5, Section 3] for more detail).

Let (z_1, \dots, z_r) be the standard coordinate of \mathbb{C}^r . In this section, we will define local coordinates associated with trees \mathcal{T}_r . Let $A \in \mathcal{T}_r$. For each edge $e \in E(A)$, let $u(e)$ denote the upper vertex and $d(e)$ denote the lower vertex. Define maps $L, R : V(A) \rightarrow \text{Leaf}(A)$ as follows: For each vertex $v \in V(A)$, $R(v)$ is defined by the rightmost leaf that is the descendant of v and $L(v)$ by the rightmost leaf among the leaves that are descendants of the child to the left of v . Let t_A be the uppermost vertex and r_A be the rightmost leaf among all leaves. Then, $r_A = R(t_A)$.

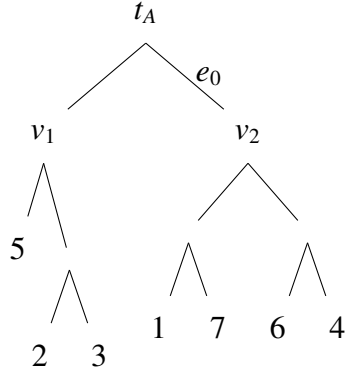

In the case of the left figure,

$$A = (5(23))((17)(64))$$

$$d(e_0) = v_2 \quad u(e_0) = t_A$$

$$L(v_1) = 5 \quad R(v_1) = 3$$

$$L(v_2) = 7 \quad R(v_2) = 4$$

$$r_A = 4.$$

The functions $\{z_v : X_r(\mathbb{C}) \rightarrow \mathbb{C}\}_{v \in V(A)}$ and $\{\zeta_e : X_r(\mathbb{C}) \rightarrow \mathbb{C}\}_{e \in E(A)}$ are defined by

$$(1.2) \quad z_v = z_{L(v)} - z_{R(v)},$$

$$(1.3) \quad \zeta_e = \frac{x_{d(e)}}{x_{u(e)}}$$

This gives the family of $r - 1$ functions $\{z_v : X_r(\mathbb{C}) \rightarrow \mathbb{C}\}_{v \in V(A)}$ and the family of $r - 2$ functions $\{\zeta_e : X_r(\mathbb{C}) \rightarrow \mathbb{C}\}_{e \in E(A)}$. Let $z_A : X_r(\mathbb{C}) \rightarrow \mathbb{C}$, $(z_1, \dots, z_r) \mapsto z_{r_A}$ be the projection onto the r_A -th component. Then,

$$(z_v)_{v \in V(A)} \times z_A : X_r(\mathbb{C}) \rightarrow \mathbb{C}^{r-1} \times \mathbb{C}$$

forms a local coordinate on $X_r(\mathbb{C})$.

To see this coordinate, it is easier to draw a tree with the function $z_v = z_{L(v)} - z_{R(v)}$ filled in at each vertex $v \in V(A)$. The right figure is an example for $(23)((15)4) \in P_5$.

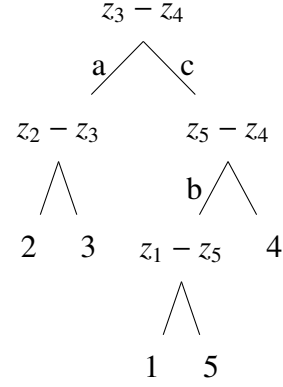

FIG. 14

The A -coordinate system is the system of functions

$$(1.4) \quad \Psi_A = z_A \times x_A \times (\zeta_e)_{e \in E(A)} : X_r(\mathbb{C}) \rightarrow \mathbb{C} \times \mathbb{C} \times \mathbb{C}^{r-2},$$

where $x_A = z_{r_A} : X_r(\mathbb{C}) \rightarrow \mathbb{C}$.

For $A = (23)((15)4) \in \mathcal{T}_5$, A -coordinate is given as:

$$(1.5) \quad \Psi_{(23)((15)4)} = (z_4, z_3 - z_4, \zeta_a = \frac{z_2 - z_3}{z_3 - z_4}, \zeta_b = \frac{z_1 - z_5}{z_5 - z_4}, \zeta_c = \frac{z_5 - z_4}{z_3 - z_4}),$$

where the labels $\{a, b, c\}$ of edges are given as in Fig. 14.

It is easy to see that the inverse function $\Psi_A^{-1} : \mathbb{C} \times \mathbb{C}^{E(A)} \rightarrow \mathbb{C}^r$ is a polynomial of $\{\zeta_e\}_{e \in E(A)}$ and x_A, z_A . For example,

$$\Psi_{(23)((15)4)}^{-1} = (z_1, z_2, z_3, z_4, z_5) = (x_A \zeta_c (1 + \zeta_b) + z_A, (1 + \zeta_a) x_A + z_A, x_A + z_A, z_A, \zeta_c x_A + z_A).$$

Thus, we have:

Proposition 1.1. *For any $A \in \mathcal{T}_r$, Ψ_A is a bi-holomorphic function from $X_r(\mathbb{C})$ onto the image in \mathbb{C}^r . Furthermore, Ψ_A^{-1} is a polynomial of $\{\zeta_e\}_{e \in E(A)}$ and x_A, z_A , and thus can be extended to a holomorphic function $\Psi_A^{-1} : \mathbb{C}^2 \times \mathbb{C}^{E(A)} \rightarrow \mathbb{C}^r$.*

Set

$$\mathcal{O}_{X_r(\mathbb{C})}^{\text{alg}} = \mathbb{C}[z_1, \dots, z_r, (z_i - z_j)^\pm],$$

a ring of regular functions on $X_r(\mathbb{C})$, and

$$T_A = \mathbb{C}[[\zeta_e \mid e \in E(A)]] [z_A, \log x_A, x_A^{\mathbb{C}}, \log \zeta_e, \zeta_e^{\mathbb{C}} \mid e \in E(A)],$$

which is a space of formal power series spanned by the finite sum of formal power series of the form:

$$z_A^n x_A^r (\log x_A)^k \prod_{e \in E(A)} \zeta_e^{r_e} (\log \zeta_e)^{k_e} F$$

with $F \in \mathbb{C}[[\zeta_e \mid e \in E(A)]]$, $n, k, k_e \in \mathbb{Z}_{\geq 0}$ and $r_e, r \in \mathbb{C}$ ($e \in E(A)$).

Any function of $\mathcal{O}_{X_r(\mathbb{C})}^{\text{alg}}$ can be expanded as a formal power series in T_A . For example, in the case of $A = (23)((15)4) \in \mathcal{T}_5$, we have:

$$\begin{aligned}
(z_2 - z_1)^{-1} &= ((z_2 - z_3) + (z_3 - z_4) - (z_5 - z_4) - (z_1 - z_5))^{-1} \\
&= (z_3 - z_4)^{-1} \left(1 + \frac{(z_2 - z_3)}{(z_3 - z_4)} - \frac{(z_5 - z_4)}{(z_3 - z_4)} - \frac{(z_1 - z_5)}{(z_3 - z_4)} \right)^{-1} \\
(1.6) \quad &= x_{(23)((15)4)}^{-1} (1 + \zeta_a - \zeta_c - \zeta_b \zeta_c)^{-1} \\
&= x_{(23)((15)4)}^{-1} \sum_{l=0}^{\infty} (-\zeta_a + \zeta_c + \zeta_b)^l \in \mathbb{C}[[\zeta_a, \zeta_b, \zeta_c]][x_{(23)((15)4)}^{-1}].
\end{aligned}$$

The series in T_A is called a *parenthesized formal power series*. It is noteworthy that T_A naturally inherits a $\mathcal{O}_{X_r(\mathbb{C})}^{\text{alg}}$ -algebra structure, by the \mathbb{C} -algebra homomorphism:

$$(1.7) \quad e_A : \mathcal{O}_{X_r(\mathbb{C})}^{\text{alg}} \rightarrow T_A$$

In particular, T_A is an $\mathcal{O}_{X_r(\mathbb{C})/\mathbb{C}}^{\text{alg}}$ -module.

Next, consider the radius of convergence of parenthesized formal power series. For $p > 0$, set

$$\begin{aligned}
\mathbb{D}_p &= \{\zeta \in \mathbb{C} \mid |\zeta| < p\}, \\
\mathbb{D}_p^\times &= \{\zeta \in \mathbb{C} \mid 0 < |\zeta| < p\}.
\end{aligned}$$

Let $\mathfrak{p} = (p_e)_{e \in E(A)} \in \mathbb{R}_{>0}^{E(A)}$. Let $\mathbb{C}[[\zeta_e \mid e \in E(A)]]_{\mathfrak{p}}^{\text{conv}}$ be a subspace of $\mathbb{C}[[\zeta_e \mid e \in E(A)]]$ consisting of formal power series which is absolutely convergent in $\prod_{e \in E(A)} \mathbb{D}_{p_e}$ and set

$$T_A^{\mathfrak{p}} = \mathbb{C}[[\zeta_e \mid e \in E(A)]]_{\mathfrak{p}}^{\text{conv}}[z_A, z_v^{\mathbb{C}}, \log z_v \mid v \in V(A)],$$

a subspace of T_A . It is important to note that the region of absolute convergence of $e_{(23)((15)4)}((z_2 - z_1)^{-1})$ in the example (1.6) is not $|\zeta_a| < 1, |\zeta_b| < 1, |\zeta_c| < 1$. Since $e_{(23)((15)4)}((z_2 - z_1)^{-1}) = x_{(23)((15)4)}^{-1} \sum_{l=0}^{\infty} (-\zeta_a + \zeta_c + \zeta_b)^l$, if $p_a + p_b + p_c < 1$, then $e_{(23)((15)4)}((z_2 - z_1)^{-1}) \in T_{(23)((15)4)}^{\mathfrak{p}}$.

Definition 1.2. A sequence of positive real numbers $(p_e)_{e \in E(A)} \in \mathbb{R}_{>0}^{E(A)}$ is called *A-admissible* if $\Psi_A^{-1}(\mathbb{C} \times \mathbb{C}^\times \times \prod_{e \in E(A)} \mathbb{D}_{p_e}^\times) \subset X_r(\mathbb{C})$, where Ψ_A^{-1} is the polynomials in Proposition 1.1.

A convergent series $f \in T_A^{\mathfrak{p}}$ is a multi-valued holomorphic function on $\Psi_A^{-1}(\mathbb{C} \times \mathbb{C}^\times \times \prod_{e \in E(A)} \mathbb{D}_{p_e}^\times)$ because it contains $\log(z_v)$ and z_v' . Below, we will fix the branch. For A-admissible numbers \mathfrak{p} , set

$$\begin{aligned}
U_A^{\mathfrak{p}} &= \Phi_A^{-1}(\mathbb{C} \times \mathbb{C}^{\text{cut}} \times \prod_{e \in E(A)} \mathbb{D}_{p_e}^{\text{cut}}), \\
\overline{U}_A^{\mathfrak{p}} &= \Phi_A^{-1}(\mathbb{C} \times \mathbb{C}^\times \times \prod_{e \in E(A)} \mathbb{D}_{p_e}^\times),
\end{aligned}$$

where

$$\begin{aligned}
\mathbb{R}_- &= \{r \in \mathbb{R} \mid r \leq 0\}, \\
\mathbb{C}^{\text{cut}} &= \mathbb{C} \setminus \mathbb{R}_-, \\
\mathbb{D}_p^{\text{cut}} &= \{\zeta \in \mathbb{C}^{\text{cut}} \mid |\zeta| < p\}.
\end{aligned}$$

Define the branch of $\text{Log} : \mathbb{C}^{\text{cut}} \rightarrow \mathbb{C}$ by

$$(1.8) \quad \text{Log}(\exp(\pi it)) = \pi it$$

for $t \in (-1, 1)$. In particular, $\text{Arg} = \text{Im Log}$ takes the values in $(-\pi, \pi)$.

Then, each formal power series in T_A^p can be regarded as a single-valued holomorphic function on U_A^p . Set

$$(1.9) \quad U_A = \cup_{p:A\text{-admissible}} U_A^p \subset X_r(\mathbb{C}),$$

$$(1.10) \quad \overline{U}_A = \cup_{p:A\text{-admissible}} \overline{U}_A^p \subset X_r(\mathbb{C}).$$

Note that U_A are connected simply-connected open subsets of $X_r(\mathbb{C})$. Set

$$T_A^{\text{conv}} = \cap_{p:A\text{-admissible}} T_A^p \subset T_A,$$

which is a linear space of convergent parenthesized formal power series. Then, by (1.7), we have a \mathbb{C} -algebra homomorphism

$$(1.11) \quad e_A : \mathcal{O}_{X_r(\mathbb{C})}^{\text{alg}} \rightarrow T_A^{\text{conv}}.$$

Set

$$\partial_i = \frac{d}{dz_i},$$

the partial differential operator on $X_r(\mathbb{C})$ with respect to the standard coordinate (z_1, \dots, z_r) , and

$$D_{X_r(\mathbb{C})} = \mathbb{C}[\partial_1, \dots, \partial_r, z_1, \dots, z_r, (z_i - z_j)^\pm \mid 1 \leq i < j \leq r],$$

a ring of differential operators on $X_r(\mathbb{C})$. Then, it is clear that T_A^{conv} and $\mathcal{O}_{X_r(\mathbb{C})}^{\text{alg}}$ are $D_{X_r(\mathbb{C})}$ -modules and e_A (1.11) is a $D_{X_r(\mathbb{C})}$ -module homomorphism.

1.3. Vertex operator algebra and trees. A vertex operator algebra (VOA) is roughly an algebra with infinitely many products depending on the complex parameter $z \in \mathbb{C}^\times$:

$$\cdot_z : V \otimes V \rightarrow V((z)),$$

which is called an *operator product expansion* in physics. By repeating the products, we can get n -ary operations, which depends on $(z_1, \dots, z_n) \in X_r(\mathbb{C})$. This physically corresponds to the probability amplitude of the state in which $a_1, \dots, a_n \in V$ are inserted at n points on the Riemann sphere (Fig 15).

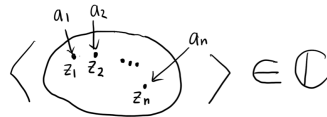

FIG. 15. state

No matter what order and parentheses we take (which correspond binary trees in Section 1.1), they should coincide as analytic functions on $X_r(\mathbb{C})$, since they correspond to the probability amplitudes of the same physical state in Fig 15. This will be mathematically

stated in Definition 1.6, which we call a consistency of operator product expansions. In this section, we review the basic definition of a VOA and describe its consistency.

We first recall the definition of a \mathbb{Z} -graded vertex algebra based on [FB, LL, Li2]:

Definition 1.3. A \mathbb{Z} -graded vertex algebra is a \mathbb{Z} -graded \mathbb{C} -vector space $V = \bigoplus_{n \in \mathbb{Z}} V_n$ equipped with a linear map

$$Y(-, z) : V \rightarrow \text{End}(V)[[z^\pm]], \quad a \mapsto Y(a, z) = \sum_{n \in \mathbb{Z}} a(n)z^{-n-1}$$

and an element $\mathbf{1} \in V_0$ satisfying the following conditions:

- V1) For any $a, b \in V$, $Y(a, z)b \in V((z))$;
- V2) For any $a \in V$, $Y(a, z)\mathbf{1} \in V[[z, \bar{z}]]$ and $\lim_{z \rightarrow 0} Y(a, z)\mathbf{1} = a(-1)\mathbf{1} = a$;
- V3) $Y(\mathbf{1}, z) = \text{id} \in \text{End}V$;
- V4) For any $a, b, c \in V$ and $u \in V^\vee$, there exists $\mu(z_1, z_2) \in \mathbb{C}[z_1^\pm, z_2^\pm, (z_1 - z_2)^\pm]$ such that

$$\begin{aligned} u(Y(a, z_1)Y(b, z_2)c) &= \mu|_{|z_1| > |z_2|}, \\ u(Y(Y(a, z_0)b, z_2)c) &= \mu|_{|z_2| > |z_1 - z_2|}, \\ u(Y(b, z_2)Y(a, z_1)c) &= \mu|_{|z_2| > |z_1|}, \end{aligned}$$

where $z_0 = z_1 - z_2$;

- V5) For any $a \in V$, $z \frac{d}{dz} Y(a, z) = [L(0), Y(a, z)] - Y(L(0)a, z)$.

Remark 1.4. The vertex operator $Y(-, z) : V \rightarrow \text{End}V[[z^\pm]]$ defines “a product” depending on z on V . For psychological reasons, in this section, we write $Y(a, z)b$ as follows:

$$a \cdot_z b = Y(a, z)b.$$

Then the axiom (V4) of vertex algebra is nothing but the following equality

$$\begin{aligned} a \cdot_{z_1} (b \cdot_{z_2} c) &=_{a.c.} (a \cdot_{z_1 - z_2} b) \cdot_{z_2} c \\ &=_{a.c.} b \cdot_{z_2} (a \cdot_{z_1} c). \end{aligned}$$

Note that $=_{a.c.}$ means “equal up to an analytic continuation”. This means that the product $\cdot_z : V \otimes V \rightarrow V((z))$ is associative and commutative.

Definition 1.5. A positive graded vertex operator algebra is a \mathbb{Z} -graded vertex algebra V with a distinguished element $\omega \in V_2$, called a conformal vector, such that:

- (1) There exists a scalar $c \in \mathbb{C}$ such that

$$[L(n), L(m)] = (n - m)L(n + m) + c\delta_{n+m,0} \frac{n^3 - n}{12},$$

where $L(n) = \omega(n + 1)$;

- (2) $\omega(0)a = a(-2)\mathbf{1}$ and $\omega(1)a = na$ for any $a \in V_n$;
- (3) $V_n = 0$ for $n < 0$, $\dim V_n < \infty$ and $V_0 = \mathbb{C}\mathbf{1}$.

Let $A \in \mathcal{T}_r$, which corresponds to the parenthesized product as in Section 1.1. As was mentioned in Remark 1.4, the vertex operator is a product depending on z , so we can consider the corresponding parenthesized product. For example, the product corresponding to $1(23), (12)3 \in \mathcal{T}_3$ is given by

$$\begin{aligned} a_1 \cdot_{z_{13}} (a_2 \cdot_{z_{23}} a_3) &= Y(a_1, z_{13})Y(a_2, z_{23})a_3 \\ (a_1 \cdot_{z_{12}} a_2) \cdot_{z_{23}} a_3 &= Y(Y(a_1, z_{12})a_2, z_{23})a_3. \end{aligned}$$

It is important to note that the variables of the vertex operator change depending on the shape of the tree (see introduction for why the change of variables is appeared). Note that each vertex operator corresponds a vertex of the tree, $v \in V(A)$, and the variables $\{z_v\}_{v \in V(A)}$, given in Section 1.2, give the correct ones (see Fig 16).

$$\begin{array}{c} z_3 - z_4 \\ \wedge \\ z_2 - z_3 \quad z_5 - z_4 \\ \wedge \quad \wedge \\ 2 \quad 3 \quad z_1 - z_5 \quad 4 \\ \wedge \\ 1 \quad 5 \end{array}$$

$$\begin{aligned} & (a_2 \cdot_{z_{23}} a_3) \cdot_{z_{34}} \left((a_1 \cdot_{z_{15}} a_5) \cdot_{z_{54}} a_4 \right) \\ (1.12) \quad & = Y(Y(a_2, z_{23})a_3, z_{34})Y(Y(a_1, z_{15})a_5, z_{54})a_4 \end{aligned}$$

FIG. 16

In general, for trees $A \in \mathcal{T}_r$ and $a_1, \dots, a_r \in V$, denote by $Y_A(a_1, \dots, a_r, z_1, \dots, z_r)$ the composition of vertex operators defined by (1.12), which we call a *parenthesized vertex operator*. For $u \in V^\vee$, $\langle u, \exp(L(-1)z_A)Y_A(a_1, \dots, a_r, z_1, \dots, z_r) \rangle$ is a formal power series in T_A .

Definition 1.6. A positive graded vertex operator algebra V is called consistent if the following properties hold for any $u \in V^\vee$ and $a_{[r]} \in V^{\otimes r}$ for $r \geq 2$:

- (1) For any tree $A \in \mathcal{T}_r$, the formal power series $\langle u, \exp(L(-1)z_A)Y_A(a_1, \dots, a_r, z_{[r]}) \rangle$ is in T_A^{conv} , i.e., is absolutely convergent in \overline{U}_A . Denote this holomorphic function on \overline{U}_A by $S_A(u, a_{[r]}, z_{[r]})$.
- (2) There exists a sequence of linear maps

$$S_r : V^\vee \otimes V^{\otimes r} \rightarrow \mathbb{C}[z_i, (z_i - z_j)^\pm \mid i \neq j], \quad r \geq 2.$$

such that $S_A(u, a_{[r]}, z_{[r]}) = S_r|_{U_A}$ for any tree $A \in \mathcal{T}_r$ as holomorphic functions.

This definition says that the product of a vertex operator algebra is consistent, i.e., it is uniquely determined regardless of the order and parentheses of the products. The following proposition can be proved by elementary and direct ways, but we omit the proof because we will give the proof in more non-trivial setting later (Theorem 3.9):

Proposition 1.7. *A positive graded vertex operator algebra is consistent.*

The following proposition gives the actual convergence region when taking special trees as an example. The second tree in this proposition is not needed in this paper, but will be used to prove the cluster decomposition property of correlation functions of bulk CFT in [AMT]:

Proposition 1.8. *For any $r > 0$,*

$$\overline{U}_{1(2(3(\dots(r-1,r)\dots))} = \{(z_1, \dots, z_r) \in \mathbb{C}^r \mid |z_1 - z_r| > |z_2 - z_r| > \dots > |z_{r-1} - z_r| > 0\}$$

and for any $m, n > 0$,

$$\begin{aligned} & \overline{U}_{1(2(3(\dots(m-1,m)\dots)))(m+1(m+2(m+3(\dots(m+n-1,m+n)\dots)))} \\ &= \{|z_{i+1m}| < |z_{im}|, |z_{j+1,n+m}| < |z_{j,n+m}|, |z_{1m}| + |z_{m+1,m+n}| < |z_{m,n+m}| \\ & \text{for } 1 \leq i \leq m-2, m+1 \leq j \leq m+n-2\}. \end{aligned}$$

Proof. In the case of $A = 1(2(3(\dots(r-1,r)\dots)) \in \mathcal{T}_r$, the A -coordinate is as follows:

$$\zeta_i = \frac{z_{i+1r}}{z_{ir}} \quad \text{for } i = 1, \dots, r-2.$$

Let $1 \leq i < j \leq r$. If $j \neq r$, then

$$z_{ij} = z_{ir} - z_{jr} = z_{ir}(1 - \zeta_i \zeta_{i+1} \dots \zeta_{j-1}).$$

Since $(1 - \zeta_i \zeta_{i+1} \dots \zeta_{j-1})^{-1}$ absolutely converges in $|\zeta_i \zeta_{i+1} \dots \zeta_{j-1}| < 1$. Hence, the assertion holds.

In the case of $A = (1(2(3(\dots(m-1,m)\dots)))(m+1(m+2(m+3(\dots(m+n-1,m+n)\dots))) \in \mathcal{T}_{n+m}$, the A -coordinate is as follows:

$$\zeta_l = \frac{z_{1m}}{z_{m,m+1}}, \quad \zeta_r = \frac{z_{m+1,m+r}}{z_{m,m+n}}, \quad \zeta_i = \frac{z_{i+1}}{z_i} \quad (i = 1, \dots, m-2, m+1, \dots, m+n-2).$$

Then, for $1 \leq i < j \leq n+m$, we have:

$$z_{ij} = \begin{cases} z_{im} - z_{jm} = z_{im}(1 - \zeta_i \zeta_{i+1} \dots \zeta_{j-1}) & \text{if } j \leq m \\ z_{i,m+n} - z_{j,m+n} = z_{i,m+n}(1 - \zeta_i \zeta_{i+1} \dots \zeta_{j-1}) & \text{if } i \geq m+1 \\ z_{ir} - z_{jr} = -z_{m,m+n}(1 - \zeta_l \zeta_1 \dots \zeta_{i-1} + \zeta_r \zeta_{m+1} \dots \zeta_{j-1}) & \text{if } i \leq m \text{ and } j \geq m, \end{cases}$$

which converge if $|\zeta_i| < 1$ for $i = 1, \dots, m-2, m+1, \dots, m+n-2$ and $|\zeta_l + \zeta_r| < 1$. \square

Let V be a positive graded vertex operator algebra. Throughout of this paper, we assume that V -module M satisfies the following conditions:

- (1) The action of $L(0)$ on M is locally finite;
Denote the generalized eigenspace by M_h for $h \in \mathbb{C}$.
- (2) $\dim M_h < \infty$;
- (3) There are finitely many $\Delta_i \in \mathbb{C}$ ($i = 1, \dots, N$) such that:

$$M = \bigoplus_{i=1}^N \bigoplus_{n \geq 0} M_{\Delta_i + n}.$$

Let M be a V -module. For any $n \in \mathbb{Z}_{>0}$, set

$$C_n(M) = \{a(-n)m \mid m \in M \text{ and } a \in \bigoplus_{k \geq 1} V_k\}.$$

Definition 1.9. A V -module M is called C_n -cofinite if $M/C_n(M)$ is a finite-dimensional vector space.

Since $(L(-1)a)(-n) = na(-n-1)$ for any $a \in V$ and $n \in \mathbb{Z}_{>0}$, $C_{n+1}(M) \subset C_n(M)$. Hence, if M is C_{n+1} -cofinite, then M is C_n -cofinite. Note that any vertex algebra is C_1 -cofinite by (V2). Denote by $\underline{V\text{-mod}}$ the category of all V -modules and $\underline{V\text{-mod}}_{f.g.}$ the full subcategory of $\underline{V\text{-mod}}$ consisting of all C_1 -cofinite V -modules M such that the dual module M^\vee is finitely generated.

We will recall the definition of a logarithmic intertwining operator of a vertex operator algebra from [Mi1, Mi2]. Let M_0, M_1, M_2 be V -modules.

Definition 1.10. A logarithmic intertwining operator of type $\binom{M_0}{M_1 M_2}$ is a linear map

$$\mathcal{Y}_1(\bullet, z) : M_1 \rightarrow \text{Hom}(M_2, M_0)[[z^{\mathbb{C}}]][\log z], \quad m \mapsto \mathcal{Y}_1(m, z) = \sum_{k \geq 0} \sum_{r \in \mathbb{C}} m(r; k) z^{-r-1} (\log z)^k$$

such that:

- I1) For any $m \in M_1$ and $m' \in M_2$, $\mathcal{Y}_1(m, z)m' \in M_3[[z]][[z^{\mathbb{C}}, \log z]$;
- I2) $[L(-1), \mathcal{Y}_1(m, z)] = \frac{d}{dz} \mathcal{Y}_1(m, z)$ for any $m \in M_1$;
- I3) For any $m \in M_1$, $a \in V$ and $n \in \mathbb{Z}$,

$$\begin{aligned} [a(n), \mathcal{Y}_1(m, z)] &= \sum_{k \geq 0} \binom{n}{k} \mathcal{Y}_1(a(k)m, z) z^{n-k} \\ \mathcal{Y}_1(a(n)m, z) &= \sum_{k \geq 0} \binom{n}{k} (a(n-k) \mathcal{Y}_1(m, z) (-z)^k - \mathcal{Y}_1(m, z) a(k) (-z)^{n-k}). \end{aligned}$$

The space of all logarithmic intertwining operators of type $\binom{M_0}{M_1 M_2}$ forms a vector space, which is denoted by $I_{\log} \binom{M_0}{M_1 M_2}$. If $\mathcal{Y}_1(\bullet, z) \in I_{\log} \binom{M_0}{M_1 M_2}$ does not contain any logarithmic term, i.e., $\mathcal{Y}_1(m, z) \in \text{Hom}(M_2, M_0)[[z]][[z^{\mathbb{C}}]$ for any $m \in M_1$, then $\mathcal{Y}_1(\bullet, z)$ is called an *intertwining operator* of type $\binom{M_0}{M_1 M_2}$ [FHL]. Denote by $I \binom{M_0}{M_1 M_2}$ the space of all intertwining operators of type $\binom{M_0}{M_1 M_2}$.

1.4. Conformal blocks on \mathbb{C} . Let V be a vertex operator algebra, $r \in \mathbb{Z}_{>0}$, and $\{M_i\}_{i=0,1,\dots,r}$ V -modules. Set

$$M_{[0;r]} = M_0^\vee \otimes M_1 \otimes \cdots \otimes M_r,$$

where $M_0^\vee = \bigoplus_{h \in \mathbb{C}} (M_0)_h^*$ is the dual module of M_0 . A conformal block is a sheaf of holomorphic solutions of a $D_{X_r(\mathbb{C})}$ -module, defined for a sequence of V -modules $\{M_i\}_{i=0,1,\dots,r}$ (see [FB, NT]). In this section, we will review conformal blocks and their operadic structures based on [Mo5].

For each $a \in V$, $i = 1, \dots, r$ and $n \in \mathbb{Z}$, define a linear map $a(n)_i : M_{[0;r]} \rightarrow M_{[r]}$ by the action of $a(n) : M_i \rightarrow M_i$ on the i -th component.

On the 0-th component, define $a(n)_0^* : M_{[0;r]} \rightarrow M_{[0;r]}$ by $a(n)^* : M_0^\vee \rightarrow M_0^\vee$ on the 0-th component, where

$$(a(n)^*u)(\bullet) = u(a(n)\bullet) \text{ for } u \in M_0^\vee.$$

Let $\mathcal{O}_{X_r(\mathbb{C})}^{\text{alg}} \otimes M_{[0;r]}$ be an $\mathcal{O}_{X_r(\mathbb{C})}^{\text{alg}}$ -module, where the $\mathcal{O}_{X_r(\mathbb{C})}^{\text{alg}}$ -module structure is defined by the multiplication on the left component. Define a $D_{X_r(\mathbb{C})}$ -module structure on $\mathcal{O}_{X_r(\mathbb{C})}^{\text{alg}} \otimes M_{[0;r]}$ by

$$(1.13) \quad \partial_i \cdot (f \otimes m_{[0;r]}) = (\partial_i f) \otimes m_{[0;r]} + f \otimes L(-1)_i m_{[0;r]}$$

for $i = 1, \dots, r$, $f \in \mathcal{O}_{X_r(\mathbb{C})}^{\text{alg}}$, $m_{[0;r]} \in M_{[0;r]}$.

Let $N_{M_{[0;r]}}$ be the $D_{X_r(\mathbb{C})}$ -submodule of $\mathcal{O}_{X_r(\mathbb{C})}^{\text{alg}} \otimes M_{[0;r]}$ generated by the following elements:

$$(1.14) \quad 1 \otimes a(n)_i m_{[0;r]} - \sum_{k \geq 0} \binom{n}{k} (-z_i)^k \otimes a(-k+n)_0^* m_{[0;r]} + \sum_{1 \leq s \leq r, s \neq i} \sum_{k \geq 0} \binom{n}{k} (z_s - z_i)^{n-k} \otimes a(k)_s m_{[0;r]},$$

for all $m_{[0;r]} \in M_{[0;r]}$, $a \in V$ and $i \in \{1, \dots, r\}$ and $n \in \mathbb{Z}$. Set

$$D_{M_{[0;r]}} = (\mathcal{O}_{X_r(\mathbb{C})}^{\text{alg}} \otimes M_{[0;r]}) / N_{M_{[0;r]}},$$

which is a $D_{X_r(\mathbb{C})}$ -module. The following lemma is clear:

Lemma 1.11. *The assignment of $M_{[0;r]}$ to $D_{M_{[0;r]}}$ determines the following \mathbb{C} -linear functor:*

$$D_\bullet : \underline{V\text{-mod}}^{\text{op}} \times \underline{V\text{-mod}} \rightarrow \underline{D_{X_r(\mathbb{C})}\text{-mod}},$$

$$(M_0, M_1, \dots, M_r) \mapsto D_{M_{[0;r]}}.$$

Let $\mathcal{O}_{X_r(\mathbb{C})}^{\text{an}}$ be the sheaf of holomorphic functions on $X_r(\mathbb{C})$. Set

$$\mathcal{CB}_{M_{[0;r]}} = \text{Hom}_{D_{X_r(\mathbb{C})}}(D_{M_{[0;r]}}, \mathcal{O}_{X_r(\mathbb{C})}^{\text{an}}),$$

the holomorphic solution sheaf, which is called a *chiral conformal block*.

Remark 1.12. *Let $U \subset X_r(\mathbb{C})$ be an open subset and $C \in \mathcal{CB}_{M_{[0;r]}}(U)$. Let $M_{[0;r]} \rightarrow \mathcal{O}_{X_r(\mathbb{C})}^{\text{alg}} \otimes M_{[0;r]}$ be the embedding defined by $m_{[0;r]} \mapsto 1 \otimes m_{[0;r]}$ for $m_{[0;r]} \in M_{[0;r]}$. Then, by $M_{[0;r]} \rightarrow \mathcal{O}_{X_r(\mathbb{C})}^{\text{alg}} \otimes M_{[0;r]} \rightarrow D_{M_{[0;r]}}$, C can be regarded as a linear map $M_{[0;r]} \rightarrow \mathcal{O}_{X_r(\mathbb{C})}^{\text{an}}(U)$, which assigns each vector in $M_{[0;r]}$ to a holomorphic function on U .*

The following result is obtained in [Mo5] by refining the idea in [Hu1]:

Proposition 1.13. *Let $M_0, M_1, \dots, M_r \in \underline{V\text{-mod}}$. Assume that M_1, \dots, M_r are C_1 -cofinite and M_0^\vee is finitely generated. Then, $D_{M_{[0;r]}}$ is a finitely generated $\mathcal{O}_{X_r(\mathbb{C})}^{\text{alg}}$ -module. In particular, $D_{M_{[0;r]}}$ is holonomic on $X_r(\mathbb{C})$ and the holomorphic solution sheaf $\text{Hom}(D_{M_{[0;r]}}, \mathcal{O}_{X_r(\mathbb{C})}^{\text{an}})$ is a locally constant sheaf of finite rank on $X_r(\mathbb{C})$.*

For a locally constant sheaf, we can define the monodromy representation of the fundamental groupoid $\Pi_1(X_r(\mathbb{C}))$, which plays an essential role in our construction of an action of PaB , which is natural with respect to $M_0, M_1, \dots, M_r \in \underline{V\text{-mod}}_{f.g.}$.

Let $A \in \mathcal{T}_r$. In Section 1.2, we introduced $D_{X_r(\mathbb{C})}$ -modules

$$T_A^{\text{conv}} = \mathbb{C}[[\zeta_e \mid e \in E(A)]]^{\text{conv}}[z_A, x_A^{\mathbb{C}}, \log x_A, \zeta_e^{\mathbb{C}}, \log \zeta_e \mid e \in E(A)].$$

Since we impose the convergence in U_A on the formal power series and U_A is simply-connected, any formal solutions

$$\text{Hom}_{D_{X_r(\mathbb{C})}}(D_{M_{[0;r]}}, T_A^{\text{conv}})$$

define a well-defined section of $\mathcal{CB}_{M_{[0;r]}}(U_A)$. This gives a linear map

$$s_A : \text{Hom}_{D_{X_r(\mathbb{C})}}(D_{M_{[0;r]}}, T_A^{\text{conv}}) \rightarrow \text{Hom}_{D_{X_r(\mathbb{C})}}(D_{M_{[0;r]}}, \mathcal{O}_{X_r(\mathbb{C})}^{\text{an}}(U_A)).$$

Conversely, we showed that any conformal block has an expansion of the form in T_A^{conv} .

Theorem 1.14. [Mo5, Theorem 4.23] *Let $M_0, M_1, \dots, M_r \in \underline{V\text{-mod}}_{f.g.}$. For $A \in \mathcal{T}_r$, s_A is isomorphism of vector spaces. The inverse map, which is defined by the series expansion, is denoted by*

$$e_A : \mathcal{CB}_{M_{[0;r]}}(U_A) \rightarrow \text{Hom}_{D_{X_r(\mathbb{C})}}(D_{M_{[0;r]}}, T_A^{\text{conv}}).$$

Let us consider the simplest tree $(12) \in \mathcal{T}_2$. Note that, in this case,

$$T_{12} = \mathbb{C}[z_2, z_{12}^{\mathbb{C}}, \log(z_{12})] = T_{12}^{\text{conv}}$$

is just a polynomial and does not contain any infinite series, since the set of all edges $E(12)$ is empty. Let $M_i \in \underline{V\text{-mod}}$ ($i = 0, 1, 2$). For $I(\bullet, z) \in I_{\log} \binom{M_0}{M_1 M_2}$ and $u \in M_0^{\vee}$, $m_i \in M_i$,

$$\langle u, \exp(L(-1)z_2)I(m_1, z_{12})m_2 \rangle \in \mathbb{C}[z_2, z_{12}^{\mathbb{C}}, \log(z_{12})] = T_{12}^{\text{conv}}$$

and it is easy to show that this is an element of $\text{Hom}_{D_{X_2(\mathbb{C})}}(D_{M_{[0;2]}}, T_{(12)}^{\text{conv}})$. Then, we have (see [Mo5, Proposition 5.6]):

Proposition 1.15. *The above map $I_{\log} \binom{M_0}{M_1 M_2} \rightarrow \mathcal{CB}_{M_{[0;2]}}(U_{12})$ is isomorphism.*

Let $A \in \mathcal{T}_r$, $B \in \mathcal{T}_s$ and $p \in [r]$. Then, $A \circ_p B \in \mathcal{T}_{r+s-1}$. Let M_0, M_1^A, \dots, M_r^A and M_1^B, \dots, M_s^B be V -modules in $\underline{V\text{-mod}}_{f.g.}$. Set

$$M_{r \circ_p s}^{A,B} = M_0^{\vee} \otimes M_1^A \otimes M_2^A \otimes \cdots \otimes M_{p-1}^A \otimes M_1^B \otimes \cdots \otimes M_s^B \otimes M_{p+1}^A \otimes \cdots \otimes M_r^A$$

and let

$$C_A \in \mathcal{CB}_{M_0; M_1^A, \dots, M_r^A}(U_A) \text{ and } C_B \in \mathcal{CB}_{M_p^A; M_1^B, \dots, M_s^B}(U_B).$$

We finally recall the operadic composition (the glueing of solutions) of C_A and C_B , which defines a new conformal block

$$C_A \circ_p C_B \in \mathcal{CB}_{M_{r \circ_p s}^{A,B}}(U_{A \circ_p B})$$

(see [Mo5, Section 5.3]).

By Remark 1.12 and Theorem 1.14, we regard the conformal blocks as the (convergent) formal power series valued linear map on the tensor product of modules. For $m_{r \circ_p s}^{A,B} = u \otimes m_1^A \otimes m_2^A \otimes \cdots \otimes m_{p-1}^A \otimes m_1^B \otimes \cdots \otimes m_s^B \otimes m_{p+1}^A \otimes \cdots \otimes m_r^A \in M_{r \circ_p s}^{A,B}$, define the operadic composition by

(1.15)

$$\begin{aligned} & (C_A \circ_p C_B)(m_{[r \circ_p r']}) \\ &= \sum_{h \in \mathbb{C}} \left(\sum_{i \in I_h} e_A(C_A)(u, m_1^A, \dots, m_{p-1}^A, e_i^h, m_{p+1}^A, \dots, m_r^A) e_B(C_B)(\exp(-L(-1)^* z_{r_B}) e_h^i, m_1^B, \dots, m_s^B) \right) \\ & \in \mathbb{C}[[\zeta_e \mid e \in E(A \circ_p B)]] [z_{A \circ_p B}, x_{A \circ_p B}^{\mathbb{C}}, \log x_{A \circ_p B}, \zeta_e^{\mathbb{C}}, \log \zeta_e \mid e \in E(A \circ_p B)]. \end{aligned}$$

Here, $\{e_i^h\}_{i \in I_h}$ is a basis of $(M_p^A)_h$ and $\{e_h^i\}_{i \in I_h}$ is the dual basis of $(M_p^A)_h^*$. This infinite sum is well-defined as formal power series, i.e., each coefficient of formal variables is a finite sum. It is non-trivial that the right-hand-side of (1.15) is in $T_{A \circ_p B}^{\text{conv}}$, that is, absolutely convergent in $U_{A \circ_p B}$. This result is obtained in [Mo5, Theorem 5.11]. Hence, (1.15) gives a section of $\text{Hom}_{D_{X_{r+s}}} (D_{M_{r \circ_p s}^{A,B}}, T_{A \circ_p B}^{\text{conv}})$, and thus, $\mathcal{CB}_{M_{r \circ_p s}^{A,B}}(U_{A \circ_p B})$.

To summarize, we have the following result:

Theorem 1.16. *The following sum is locally uniformly convergent in $U_{A \circ_p B}$*

$$\sum_{h \in \mathbb{C}} \left| \sum_{i \in I_h} e_A(C_A)(u, m_1^A, \dots, m_{p-1}^A, e_i^h, m_{p+1}^A, \dots, m_r^A) e_B(C_B)(\exp(-L(-1)^* z_{r_B}) e_h^i, m_1^B, \dots, m_s^B) \right|,$$

where the absolute values are taken for the sum over the conformal weights $h \in \mathbb{C}$. In particular, (1.15) defines the linear map:

$$(1.16) \quad \text{glue}_p : \mathcal{CB}_{M_0; M_1^A, \dots, M_r^A}(U_A) \otimes \mathcal{CB}_{M_p^A; M_1^B, \dots, M_s^B}(U_B) \rightarrow \mathcal{CB}_{M_{r \circ_p s}^{A,B}}(U_{A \circ_p B}).$$

1.5. Homotopy action of little 2-disk. Let $r \geq 1$ and set

$$X_r(\mathbb{R}) = \{(z_1, \dots, z_r) \in \mathbb{R}^r \mid z_i \neq z_j \text{ for any } i \neq j\}.$$

Definition 1.17. *Let $A \in \mathcal{T}_r$ and $Q \in X_r(\mathbb{R})$. The order of Q and A is said to be equal if the following conditions are satisfied: For any $i, j \in \{1, \dots, r\}$ with $i \neq j$, $z_i < z_j$ if and only if the leaf i is to the right of the leaf j in A .*

Let $Q : \mathcal{T}_r \rightarrow X_r(\mathbb{R}) \subset X_r(\mathbb{C})$ satisfy the following conditions:

- Q1) The order of $Q(A)$ and A is equal,
- Q2) $Q(A) \in U_A$ for $A \in \mathcal{T}_r$.

Recall that the maps of $\underline{\text{PaB}}(r)$ are defined using the pure braid group PB_r . The pure braid group can be regarded as the homotopy classes of paths in the complex plane from different n points to different n points on the real line \mathbb{R} . Therefore, since the order is correct, for $g \in \text{Hom}_{\underline{\text{PaB}}(r)}(A, A')$, a corresponding path $\gamma(g) : [0, 1] \rightarrow X_r(\mathbb{C})$ with $\gamma(g)(0) = Q(A)$ and $\gamma(g)(1) = Q(A')$ can be defined up to homotopy. The homotopy class of this path is written as $[g]_Q$.

Remark 1.18. For example, for $((12)3)(45)$, we can consider $Q = (z_1, z_2, z_3, z_4, z_5) \in X_5(\mathbb{R})$ as in the figure below.

$$\begin{array}{ccc} \bullet & \bullet & \\ (5 & 4) & \end{array} \quad \begin{array}{ccc} \bullet & \bullet & \bullet \\ (3 & (2 & 1)) \end{array}$$

Define a functor $\mathcal{CB}_Q : \underline{\text{PaB}} \rightarrow \mathcal{P}\text{End}_{\underline{V\text{-mod}}_{f,g}}$ as follows: For an object $A \in \mathcal{T}_r$ with $r \geq 1$,

$$\mathcal{CB}_Q(A) : \underline{V\text{-mod}}_{f,g} \times (\underline{V\text{-mod}}_{f,g}^{\text{op}})^r \rightarrow \underline{\text{Vect}}_{\mathbb{C}}, \quad M_{[0;r]} \mapsto \mathcal{CB}_{M_{[0;r]}}(U_A).$$

For $r = 0$, recall \mathcal{T}_0 consists of the empty word \emptyset . Define $\mathcal{CB}(\emptyset) \in \mathcal{P}\text{End}_{\underline{V\text{-mod}}_{f,g}}(\emptyset) = \text{Func}(\underline{V\text{-mod}}_{f,g}, \underline{\text{Vect}}_{\mathbb{C}})$ by

$$\mathcal{CB}_Q(\emptyset) = \text{Hom}(V, \bullet) : \underline{V\text{-mod}}_{f,g} \rightarrow \underline{\text{Vect}}_{\mathbb{C}}, \quad M \mapsto \text{Hom}(V, M).$$

For a morphism $g : A \rightarrow A'$ in $\underline{\text{PaB}}(r)$, let $\gamma \in [g]_Q$ and define a linear map $A_\gamma(Q) : \mathcal{CB}_{M_{[0;r]}}(U_A) \rightarrow \mathcal{CB}_{M_{[0;r]}}(U_{A'})$ by the analytic continuation along the path γ , which is natural with respect to V -module homomorphisms $f_i : N_i \rightarrow M_i$ and $g : M_0 \rightarrow N_0$ (see [Mo5]). Since \mathcal{CB} is a locally constant sheaf, A_γ is well-defined and independent of the choice of $\gamma \in [g]_Q$. Moreover, if $Q_0, Q_1 : \mathcal{T}_r \rightarrow X_r(\mathbb{C})$ satisfy (Q1) and (Q2), then $\mathcal{CB}_{Q_0} = \mathcal{CB}_{Q_1}$ as functors. Thus, we simply denote \mathcal{CB}_Q by \mathcal{CB} , which we call a chiral conformal block.

Now we have:

Theorem 1.19. [Mo5, Proposition 6.19 and Proposition 6.20] *Let $n \geq 1$ and $m \geq 0$, $A, A' \in \mathcal{T}_n$, $B \in \mathcal{T}_m$ and $\underline{\text{PaB}}$ -morphisms $g : A \rightarrow A'$, $g_B : B \rightarrow B'$ and $p \in \{1, \dots, n\}$. Then, the following diagram commutes:*

$$(1.17) \quad \begin{array}{ccc} \mathcal{CB}_{M_{[0;r]}}(U_A) \otimes \mathcal{CB}_{M_{[0;s]}}(U_B) & \xrightarrow{\text{glue}_p} & \mathcal{CB}_{M_{[r+s-1]}^{A,B}}(U_{A \circ_p B}) \\ \rho(g_A) \otimes \rho(g_B) \downarrow & & \downarrow \rho(g_A \circ_i g_B) \\ \mathcal{CB}_{M_{[0;r]}}(U_{A'}) \otimes \mathcal{CB}_{M_{[0;s]}}(U_{B'}) & \xrightarrow{\text{glue}_p} & \mathcal{CB}_{M_{[r+s-1]}^{A',B'}}(U_{A' \circ_p B'}) \end{array}$$

To formulate the above theorem, in terms of operads, we recall the notion of proend-morphism operad from [Mo5]. Let C be a small \mathbb{C} -linear category. Then, the proend-morphism operad is the sequence

$$(1.18) \quad \mathcal{P}\text{End}_C(n) = \text{Func}(C \times (C^{\text{op}})^n, \underline{\text{Vect}}_{\mathbb{C}})$$

with the composition is defined by the coend of functors, \int_C (for the definition and properties of coends see [Mac]),

$$(1.19)$$

$$F \circ_p G = \int_{N \in C} F(\bullet_0; \bullet_1, \dots, \bullet_{p-1}, N, \bullet_{p+1}, \dots, \bullet_n) \otimes G(N; \bullet_n, \dots, \bullet_{n+m-1}) \in \mathcal{P}\text{End}(n+m-1).$$

for $F \in \mathcal{P}\text{End}_C(n)$ and $G \in \mathcal{P}\text{End}_C(m)$ with $p \in [n]$. Then, $\{\mathcal{P}\text{End}_C(n)\}_{n \geq 0}$ is a 2-operad with the associative isomorphism is defined by the universality of the coend (for more detail see [Mo5, Section 2.2]).

A conformal block is a functor

$$\mathcal{CB}_{\bullet_0; \bullet_1, \dots, \bullet_r}(U_A) : \underline{V\text{-mod}}_{f.g.} \times (\underline{V\text{-mod}}_{f.g.}^{\text{op}})^r \rightarrow \underline{\text{Vect}}_{\mathbb{C}}$$

for $A \in \mathcal{T}_{[r]}$. Hence, we can define a functor

$$(1.20) \quad \mathcal{CB} : \underline{\text{PaB}}(n) \rightarrow \mathcal{P}\text{End}(n)$$

$$(1.21) \quad A \mapsto \mathcal{CB}_{\bullet_0; \bullet_{[r]}}(U_A) \quad \text{and} \quad \gamma : A \rightarrow A' \mapsto A(\gamma)$$

and, by Theorem 1.19 and the universality of the coend [Mac], we have a linear map:

$$(1.22) \quad \text{glue}_p : \int_{N \in \underline{V\text{-mod}}_{f.g.}} \mathcal{CB}_{M_{[0;r]}}(U_A) \otimes \mathcal{CB}_{M_{[0;s]}}(U_B) \longrightarrow \mathcal{CB}_{M_{[r+s-1]}^{A,B}}(U_{A \circ_p B}).$$

Thus, we have:

Theorem 1.20. [Mo5, Theorem A] *Let V be a positive graded vertex operator algebra. Then, the pair of the functors $\mathcal{CB} : \underline{\text{PaB}} \rightarrow \mathcal{P}\text{End}_{\underline{V\text{-mod}}_{f.g.}}$ and the natural transformations $\text{glue}_p : \mathcal{CB}_A \circ_p \mathcal{CB}_B \rightarrow \mathcal{CB}_{A \circ_p B}$ ($A, B \in \mathcal{T}_*$) is a lax 2-morphism of 2-operads.*

2. VERTEX OPERATOR ALGEBRA AND HOMOTOPY 2-SWISS-CHEESE OPERAD

In this section, we consider 2-colored operads colored by $\{c, o\}$, where c (resp. o) stands for ‘‘closed’’ (resp. ‘‘open’’). In Section 2.1, we will recall the definition of the parenthesized permutation and braid operad $\underline{\text{PaPB}}$ which is introduced by Idrissi [Id]. In Section 2.2, we will construct an action of the 2-colored operad $\underline{\text{PaPB}}$ on the representation category of a vertex operator algebra $\underline{V\text{-mod}}_{f.g.}$.

2.1. 2-colored magma, trees and braids. Here, we review the definition of 2-colored operads $\Omega\Omega$ and $\underline{\text{PaPB}}$ from [Id] and give an explicit description of $\Omega\Omega$ by trees as in Section 1.1 (see [Id] for more details).

A colored operad or a symmetric multicategory was introduced in [La]. An element of a colored operad \mathcal{O} with the colors $\{c, o\}$ of (r, s) -array operation has inputs labeled with r c 's and s o 's and the output labeled with c or o . We denote the set of such operations with output labeled by $x \in \{c, o\}$ by:

$$\mathcal{O}^x(r, s) = \mathcal{O}(\underbrace{c, \dots, c}_r, \underbrace{o, \dots, o}_s; x).$$

Let V_c, V_o be vector spaces. Then, the endmorphism 2-colored operad is given by

$$(2.1) \quad \text{End}^c(r, s) = \text{Hom}(V_c^{\otimes r} \otimes V_o^{\otimes s}, V_c)$$

$$(2.2) \quad \text{End}^o(r, s) = \text{Hom}(V_c^{\otimes r} \otimes V_o^{\otimes s}, V_o)$$

with obvious compositions.

In [Id], $\Omega\Omega$ is introduced as the free colored operad $\mathcal{O}(\mu_c, \iota, \mu_o)$ on the three generators $\cdot_c \in \Omega\Omega(c, c; c)$, $\iota \in \Omega\Omega(c; o)$ and $\cdot_o \in \Omega\Omega(o, o; o)$. An algebra over $\Omega\Omega$ in $\underline{\text{Set}}$ is the data of

- Sets S_c and S_o with maps $\cdot_c : S_c \times S_c \rightarrow S_c$ and $\cdot_o : S_o \times S_o \rightarrow S_o$, i.e., a pair of magmas;

- A map $\iota : M_c \rightarrow M_o$ (not necessarily compatible with the products).

An element of $\Omega\Omega$ has, for example, the following form:

$$(\tau(\mathbf{2}) \cdot_o 4) \cdot_o (\tau(\mathbf{3} \cdot_c \mathbf{1}) \cdot_o 5),$$

where the bold numbers correspond to the color ‘‘c’’ and the normal numbers corresponds to the color ‘‘o’’. We can naturally associate a tree with leaves labeled by bold and normal numbers as in Fig 17.

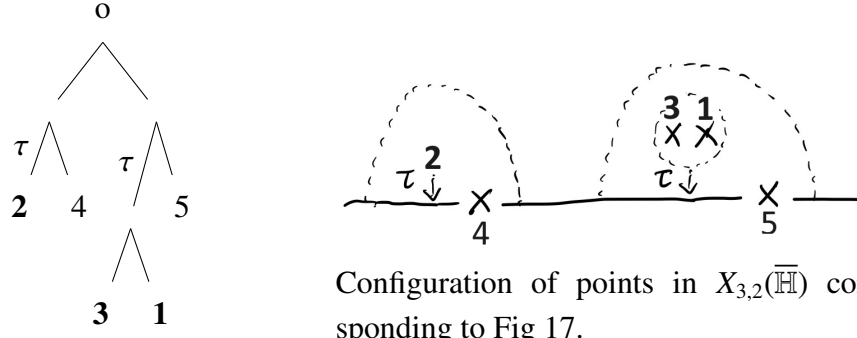

Configuration of points in $X_{3,2}(\overline{\mathbb{H}})$ corresponding to Fig 17.

FIG. 17

- $\mathcal{T}^c(r)$ is a set of all binary trees whose leaves are labeled by bold numbers $\{\mathbf{1}, \mathbf{2}, \dots, \mathbf{r}\}$.
- $\mathcal{T}^o(r, s)$ is a set of all binary trees whose leaves are labeled by bold numbers $\{\mathbf{1}, \mathbf{2}, \dots, \mathbf{r}\}$ and normal numbers $\{r+1, \dots, r+s\}$ such that the labels on normal (open) leaves are arranged so that the numbers increase from left to right.
- We also consider the map corresponds to τ by the natural embedding:

$$(2.3) \quad \mathcal{T}^c(r) \rightarrow \mathcal{T}^o(r, 0).$$

Then, $\{\mathcal{T}^c(r), \mathcal{T}^o(r, s)\}_{r,s \geq 0}$ are 2-colored operad with obvious composition of trees, which is symmetric in c -label’s and not symmetric in o label’s. The following proposition is clear:

Proposition 2.1. *The colored operad $\{\mathcal{T}^c(r), \mathcal{T}^o(r, s)\}_{r,s \geq 0}$ is isomorphic to $\Omega\Omega$ as a 2-colored operad.*

Set

$$(2.4)$$

$$X_{r,s}(\overline{\mathbb{H}}) = \{(z_1, \dots, z_r, z_{r+1}, \dots, z_{r+s}) \in \mathbb{C}^{r+s} \mid \text{Im } z_i > 0 \text{ and } \text{Im } z_j = 0 \text{ for } i \leq r, j > r\}.$$

The operad of *parenthesized permutations and braids* PaPB introduced in [Id] is a 2-colored operad in the category of categories, which is defined as follows: As in Section 1.5, consider maps

$$Q^c : \mathcal{T}^c(r) \rightarrow X_r(\mathbb{R}) \quad \text{and} \quad Q^o : \mathcal{T}^o(r, s) \rightarrow X_{r,s}(\overline{\mathbb{H}})$$

such that:

- QB1) The order of $Q^c(A)$ and A is equal for all $A \in \mathcal{T}^c$;
- QB2) The order of real parts of $Q^o(E)$ and E is equal.

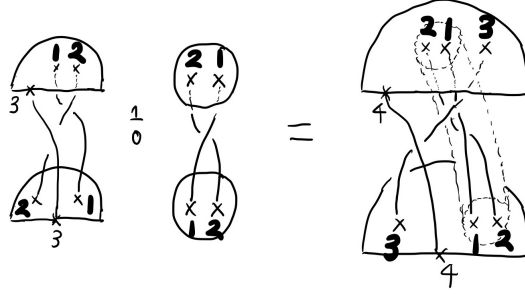

FIG. 18. operad structure

Then, $\underline{\text{PaPB}}^c(r)$ is a full subcategory of $\Pi_1(X_r(\mathbb{C}))$ whose objects are $\{Q^c(A)\}_{A \in \mathcal{T}^c(r)}$ and $\underline{\text{PaPB}}^o(r, s)$ is a full subcategory of $\Pi_1(X_{r,s}(\overline{\mathbb{H}}))$ whose objects are $\{Q^o(E)\}_{E \in \mathcal{T}^o(r,s)}$ which equipped with functors

$$(2.5) \quad \tau(r) : \underline{\text{PaPB}}^c(r) \rightarrow \underline{\text{PaPB}}^o(r, 0).$$

Here, the functor $\tau(r)$ sends objects by (2.3). By (QB1) and (QB2), morphisms of $\underline{\text{PaB}}^c(r) = \underline{\text{PaB}}(r)$ canonically corresponds to morphisms of $\underline{\text{PaPB}}^o(r, 0)$.

An example of a composition of $\underline{\text{PaPB}}^o$ is given in Fig 18, which is compatible with (2.5) and the operad structure on $\underline{\text{PaPB}}^c = \underline{\text{PaB}}$. Thus, $\underline{\text{PaPB}}$ is 2-colored operad (see [Id] for more details). It is noteworthy that $\underline{\text{PaPB}}$ is equivalent to the fundamental groupoid of the Swiss-Cheese operad $\Pi_1(\text{SC}_2)$ [Id, Theorem 3.10] (see also [Fr]).

2.2. Conformal block on $\overline{\mathbb{H}}$ and homotopy action of Swiss-Cheese operad. Let C, D be small \mathbb{C} -linear categories. The definition of a proendmorphism operad can be generalized to the colored case;

$$\mathcal{P}\text{End}^o(r, s) = \text{Func}(C \times (D^{\text{op}})^r \times (C^{\text{op}})^s, \underline{\text{Vect}}_{\mathbb{C}})$$

$$\mathcal{P}\text{End}^c(r, s) = \text{Func}(D \times (D^{\text{op}})^r \times (C^{\text{op}})^s, \underline{\text{Vect}}_{\mathbb{C}}),$$

which is a 2-colored 2-operad similarly to (1.18) and (1.19).

We consider the case of $C = \underline{V\text{-mod}}_{f,g}$ (resp. $D = \underline{V\text{-mod}}_{f,g}^2$), which corresponds to “open strings / boundary states” (resp. closed strings/ bulk states) and construct functors

$$C\mathcal{B}^c : \underline{\text{PaB}}(r) \rightarrow \mathcal{P}\text{End}_D^c(r),$$

$$C\mathcal{B}^o : \underline{\text{PaPB}}^o(r, s) \rightarrow \mathcal{P}\text{End}_{C,D}^o(r, s),$$

which are shown to be a lax 2-morphism of colored 2-operads.

(Definition of functors)

Let $\Phi : X_{r,s}(\overline{\mathbb{H}}) \rightarrow X_{2r+s}(\mathbb{C})$ be a continuous embedding given by

$$\Phi : X_{r,s}(\overline{\mathbb{H}}) \rightarrow X_{2r+s}(\mathbb{C}), \quad (z_1, \dots, z_r, z_{r+1}, \dots, z_{r+s}) \mapsto (z_1, \bar{z}_1, \dots, z_r, \bar{z}_r, z_{r+1}, \dots, z_{r+s}).$$

Correspondingly, we define the following map that embeds $\mathcal{T}^o(r, s)$ into \mathcal{T}_{2r+s} as follows:

$$\tilde{\bullet} : \mathcal{T}^o(r, s) \rightarrow \mathcal{T}_{2r+s}, \quad E \mapsto \tilde{E}.$$

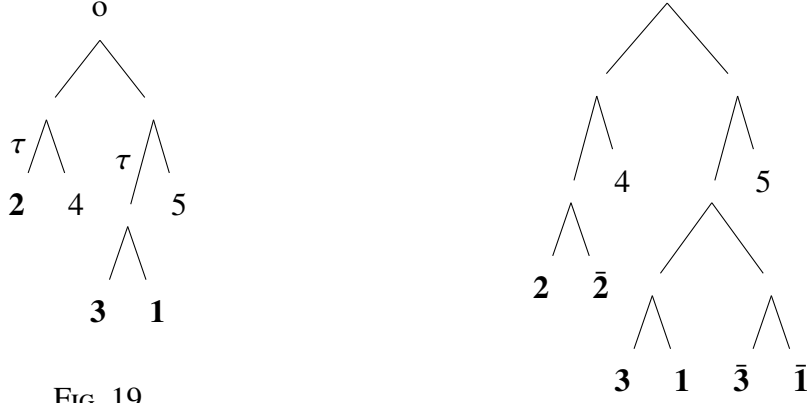

FIG. 19

For a tree $E \in \mathcal{T}^o(r, s)$, consider double copies of the bottoms of all the edges labeled with τ . The label of the leaf of each double-copy is \mathbf{n} on the left side and $\bar{\mathbf{n}}$ on the right side if the original label is \mathbf{n} (see Fig. 19).

For $A \in \mathcal{T}^c(r)$, define $\mathcal{CB}^c(A) \in \mathcal{PEnd}_D^c(r)$ by

$$\begin{aligned} \mathcal{CB}^c(A) : D \times (D^{\text{op}})^r &\rightarrow \underline{\text{Vect}}_{\mathbb{C}} \\ (M_0, \bar{M}_0, M_1, \bar{M}_1, \dots, M_r, \bar{M}_r) &\mapsto \mathcal{CB}_{M_{[0,r]}}(U_A) \otimes \mathcal{CB}_{\bar{M}_{[0,r]}}(U_A) \end{aligned}$$

and for $E \in \mathcal{T}^o(r, s)$,

$$\begin{aligned} \mathcal{CB}^o(E) : C \times (D^{\text{op}})^r \times (C^{\text{op}})^s &\rightarrow \underline{\text{Vect}}_{\mathbb{C}} \\ (N, M_1, \bar{M}_1, \dots, M_r, \bar{M}_r, M_{r+1}, \dots, M_{r+s}) &\mapsto \mathcal{CB}_{M_{[0,r,s]}}(U_{\tilde{E}}), \end{aligned}$$

where \mathcal{CB} are the chiral conformal blocks in section 1.4 and $\mathcal{CB}_{M_{[0,r,s]}}(U_{\tilde{E}})$ is the chiral conformal block with N covariantly inserted at the infinity and M_i, \bar{M}_i, M_{r+j} contravariantly inserted at the corresponding $2r + s$ leaves of $\tilde{E} \in \mathcal{T}_{2r+s}$. Note that elements of $\mathcal{CB}_{M_{[0,r]}}(U_A) \otimes \mathcal{CB}_{\bar{M}_{[0,r]}}(U_A)$ are multivalued holomorphic functions on $X_r(\mathbb{C}) \times X_r(\mathbb{C})$ and $\mathcal{CB}_{M_{[0,r,s]}}(U_{\tilde{E}})$ are multivalued holomorphic functions on $X_{2r+s}(\mathbb{C})$.

$\mathcal{CB}^c : \underline{\text{PaPB}}^c(r) \rightarrow \mathcal{PEnd}_D^c(r)$	$\mathcal{CB}^o : \underline{\text{PaPB}}^o(r, s) \rightarrow \mathcal{PEnd}_{C,D}^o(r, s)$
.....
$A \quad \mathcal{CB}_{\bullet}(U_A) \otimes \mathcal{CB}_{\bullet}(U_A)$	$E \quad \mathcal{CB}_{\bullet}(U_{\tilde{E}})$
$\downarrow^{\gamma} \mapsto \quad \downarrow_{A(\gamma) \otimes A(\bar{\gamma})}$	$\downarrow^{\mu} \mapsto \quad \downarrow_{A(\Phi_*\mu)}$
$A' \quad \mathcal{CB}_{\bullet}(U_{A'}) \otimes \mathcal{CB}_{\bullet}(U_{A'})$	$E' \quad \mathcal{CB}_{\bullet}(U_{\tilde{E}'})$

For $A, A' \in \mathcal{T}^c(r)$ and a path $\gamma : A \rightarrow A'$ in $\underline{\text{PaPB}}^c(r) = \underline{\text{PaB}}(r)$, let $\bar{\gamma}$ be the complex conjugate of γ in $X_r(\mathbb{C}) \subset \mathbb{C}^r$. Since we take the base points $Q(A)$ in $X_r(\mathbb{R})$, $\bar{\gamma}$ is again a path in $\underline{\text{PaB}}(r)$. Define a map $\mathcal{CB}^c(A) \rightarrow \mathcal{CB}^c(A')$ by the analytic continuation along the path $\gamma \times \bar{\gamma}$ in $X_r(\mathbb{C}) \times X_r(\mathbb{C})$.

Let $E, E' \in \mathcal{T}^o(r, s)$ and $\mu : E \rightarrow E'$ be a path in $\underline{\text{PaPB}}^o(r, s)$. Then, $\Phi_*(\mu)$, the pushforward of the path by $\Phi : X_{r,s}(\overline{\mathbb{H}}) \rightarrow X_{2r+s}(\mathbb{C})$, is a path in $X_{2r+s}(\mathbb{C})$. Define a map $\mathcal{CB}^o(E) \rightarrow \mathcal{CB}^o(E')$ by the analytic continuation along the path $\Phi_*\mu$ in $X_{2r+s}(\mathbb{C})$.

Note that for $\iota \in \Omega\Omega(c; o) = \mathcal{T}^o(1, 0)$,

$$\mathcal{CB}(\iota) : C \times D^{\text{op}} \rightarrow \underline{\text{Vect}}_{\mathbb{C}}, \quad (M_0, M_1, \bar{M}_1) \mapsto I_{\log} \begin{pmatrix} M_0 \\ M_1 \bar{M}_1 \end{pmatrix},$$

the space of intertwining operators by Proposition 1.15.

(Definition of compositions)

We will define the compositions of 2-colored operad on \mathcal{CB}^* . There are three types of composites, closed-closed, open-open, and open-closed, which are defined as follows:

closed-closed): $\circ_p : \underline{\text{PaPB}}^c(r) \times \underline{\text{PaPB}}^c(t) \rightarrow \underline{\text{PaPB}}^c(r+t-1)$, $(A, B) \mapsto A \circ_p B$ is given by

(2.6)

$$\text{glue}_p \times \text{glue}_p : \mathcal{CB}(U_A) \otimes \mathcal{CB}(U_A) \times \mathcal{CB}(U_B) \otimes \mathcal{CB}(U_B) \rightarrow \mathcal{CB}(U_{A \circ_p B}) \otimes \mathcal{CB}(U_{A \circ_p B}),$$

where glue_p is the glueing map of chiral conformal blocks given in (1.22), and we glued the right and left conformal blocks independently.

open-open): $\circ_p : \underline{\text{PaPB}}^o(r, s) \times \underline{\text{PaPB}}^o(t, u) \rightarrow \underline{\text{PaPB}}^o(r+t, s+u-1)$, $(E, F) \mapsto E \circ_p F$ with an open leaf p of $E \in \mathcal{T}^o(r, s)$ is given by

(2.7)

$$\text{glue}_p : \mathcal{CB}(U_{\tilde{E}}) \times \mathcal{CB}(U_{\tilde{F}}) \rightarrow \mathcal{CB}(U_{\tilde{E} \circ_p \tilde{F}}) = \mathcal{CB}(U_{\widetilde{E \circ_p F}}).$$

Here, $\tilde{E} \circ_p \tilde{F}$ is a binary tree in $\mathcal{T}_{(2r+s)+(2t+u)-1}$ and $E \circ_p F$ is a colored tree in $\mathcal{T}^o(r+t, s+u-1)$. It is clear that

$$\tilde{E} \circ_p \tilde{F} = \widetilde{E \circ_p F}.$$

holds in $\mathcal{T}_{(2r+s)+(2t+u)-1}$.

open-closed): $\circ_p : \underline{\text{PaPB}}^o(r, s) \times \underline{\text{PaPB}}^c(t) \rightarrow \underline{\text{PaPB}}^o(r+t-1, s)$, $(E, A) \mapsto E \circ_p A$ with a closed leaf p of $E \in \mathcal{T}^o(r, s)$ is given by

$$\text{glue}_p \circ \text{glue}_{\bar{p}} : \mathcal{CB}(U_{\tilde{E}}) \times \mathcal{CB}(U_A) \otimes \mathcal{CB}(U_A) \rightarrow \mathcal{CB}(U_{\tilde{E} \circ_{(p, \bar{p})} (A, A)}) = \mathcal{CB}(U_{\widetilde{E \circ_p A}}).$$

The closed leaves are always in pairs of (p, \bar{p}) . We denote the closed leaf on the left side p . We insert the same tree A at p, \bar{p} of the tree $\tilde{E} \in \mathcal{T}_{2r+s}$, which is denoted by $\tilde{E} \circ_{(p, \bar{p})} (A, A) \in \mathcal{T}_{2r+s+2t-2}$. For example, $(\tau(\overline{2}) \circ_o 1) \circ_{2, \bar{2}} ((2 \circ_c 1), (2 \circ_c 1))$ in \mathcal{T}_5 is describe in Fig. 20.

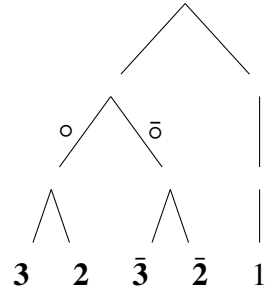

FIG. 20

It is clear that

$$\tilde{E} \circ_{(p,\bar{p})} (A, A) = \widetilde{E \circ_p^c A}$$

holds in $\mathcal{T}_{2r+s+2t-2}$.

Then, we have the following theorem (see [Mo5, Section 2] for the definition of lax 2-morphism).

Theorem 2.2. *Let V be a positive graded vertex operator algebra. Then,*

$$CB : \underline{PaPB}^*(r, s) \rightarrow \mathcal{P}\text{End}^*(r, s), \quad \bullet \in \{c, o\}, r, s \geq 0$$

is a lax 2-morphism of colored 2-operads.

Proof. It suffices to show that the above three compositions are compatible with analytic continuations along the paths, i.e., the diagrams in Theorem 1.19 for \underline{PaPB} commute. In the closed-closed case, it follows immediately from Theorem 1.19.

In the open-open case, for paths $\mu : E \rightarrow E'$ in $\underline{PaPB}^o(r, s)$ and $\nu : F \rightarrow F'$ in $\underline{PaPB}^o(t, u)$, by Theorem 1.19, the following diagram commutes:

$$\begin{array}{ccc} CB(U_{\tilde{E}}) \times CB(U_{\tilde{F}}) & \xrightarrow{\text{glue}_p} & CB(U_{\tilde{E} \circ_p \tilde{F}}) \\ \downarrow_{A(\Phi_*\mu) \otimes A(\Phi_*\nu)} & & \downarrow_{A(\Phi_*\mu \circ_p \Phi_*\nu)} \\ CB(U_{\tilde{E}'}) \times CB(U_{\tilde{F}'}) & \xrightarrow{\text{glue}_p} & CB(U_{\tilde{E}' \circ_p \tilde{F}'}) \end{array}$$

Since

$$\Phi_*\mu \circ_p \Phi_*\nu = \Phi_*(\mu \circ_p^o \nu)$$

up to homotopy in $X_{(2r+s)+(2t+u)-1}(\mathbb{C})$, where $\Phi_*\mu \circ_p \Phi_*\nu$ is the composition in \underline{PaB} and $\mu \circ_p^o \nu$ is the composition in \underline{PaPB} , the assertion holds.

In the open-closed case, for paths $\mu : E \rightarrow E'$ in $\underline{PaPB}^o(r, s)$ and $\gamma : A \rightarrow A'$ in $\underline{PaPB}^c(t)$, by Theorem 1.19, the following diagram commutes:

$$\begin{array}{ccc} CB(U_{\tilde{E}}) \times (CB(U_A) \otimes CB(U_A)) & \xrightarrow{\text{glue}_p} & CB(U_{\tilde{E} \circ_{p,\bar{p}}(A,A)}) \\ \downarrow_{A(\Phi_*\mu) \otimes A(\gamma) \otimes A(\bar{\gamma})} & & \downarrow_{A(\Phi_*\mu \circ_{p,\bar{p}}(\gamma, \bar{\gamma}))} \\ CB(U_{\tilde{E}'}) \times (CB(U_{A'}) \otimes CB(U_{A'})) & \xrightarrow{\text{glue}_p} & CB(U_{\tilde{E}' \circ_{p,\bar{p}}(A',A')}) \end{array}$$

Since

$$\Phi_*\mu \circ_{p,\bar{p}}(\gamma, \bar{\gamma}) = \Phi_*(\mu \circ_p^o \gamma)$$

up to homotopy in $X_{(2r+s)+2t-2}(\mathbb{C})$, and $\mu \circ_p^o \gamma$ is the composition in \underline{PaPB} , the assertion holds. \square

We have given conformal blocks as a function on open regions $U_{\tilde{E}}$ in $X_{2r+s}(\mathbb{C})$. As we will see in the next section, the correlation functions of conformal field theory are single valued function on $X_{r,s}(\overline{\mathbb{H}})$ and not $X_{2r+s}(\mathbb{C})$. We end this section by defining the open regions where correlation functions are actually defined.

For $A \in \mathcal{T}^c(r)$, set $U_A^c = \overline{U}_A$, where \overline{U}_A is the open region without branch cut at the origins defined in (1.10). We regard U_A^c as a subset of $\overline{U}_A \times \overline{U}_A \subset X_r(\mathbb{C}) \times X_r(\mathbb{C})$ by

$$(2.8) \quad U_A^c \hookrightarrow \overline{U}_A \times \overline{U}_A, \quad z_{[r]} \mapsto (z_{[r]}, \bar{z}_{[r]}).$$

For an open tree $E \in \mathcal{T}^o(r, s)$, set

$$(2.9) \quad \begin{aligned} U_E^o &= \Psi^{-1}(\overline{U}_{\bar{E}}) \cap X_{r,s}(\overline{\mathbb{H}}) \\ &= \{w = (z_1, \dots, z_r, z_{r+1}, \dots, z_{s+1}) \in X_{r,s}(\overline{\mathbb{H}}) \mid \Psi(w) \in \overline{U}_{\bar{E}}\}, \end{aligned}$$

which is a closed subset of $\overline{U}_{\bar{E}}$.

3. ALGEBRA OF BULK-BOUNDARY 2D CFT AND CONSISTENCY

The bulk OPE algebra of 2d conformal field theory was introduced by Huang and Kong [HK1]. Later, it is generalized into the bulk-boundary OPE algebra by Kong in [Ko1, Ko2]. The following is different from the data originally given by Kong, but is equivalent under the assumption of local C_1 -cofiniteness as we will see in this paper. In Kong's definition, the open-closed operator is replaced by a linear map $Y_{\text{bulk-bdy}}(\bullet, \underline{z}) : F^c \rightarrow \text{End}F^o[[z, \bar{z}]]$. In this paper, boundary conformal field theory is given by the following data:

state space): An \mathbb{R}^2 -graded vector space $F^c = \bigoplus_{h, \bar{h} \in \mathbb{R}} F_{h, \bar{h}}^c$ and an \mathbb{R} -graded vector space $F^o = \bigoplus_{h \in \mathbb{R}} F_h^o$;

closed-closed operator): A linear map with formal variables z, \bar{z}

$$Y^c(\bullet, \underline{z}) : F^c \rightarrow \text{End}F^c[[z, \bar{z}, |z|^{\mathbb{R}}]], \quad a \mapsto Y(a, \underline{z}) = \sum_{r, s \in \mathbb{R}} a(r, s) z^{-r-1} \bar{z}^{-s-1};$$

open-open operator): A linear map with a formal variable x

$$Y^o(\bullet, z) : F^o \rightarrow \text{End}F^o[[z^{\mathbb{R}}]], \quad v \mapsto Y(v, z) = \sum_{r \in \mathbb{R}} v(r) z^{-r-1};$$

open-closed operator): A linear map with a formal variable z

$$Y^b(\bullet, z) : F^c \rightarrow F^o[[z^{\mathbb{R}}]], \quad a \mapsto Y^b(a, z) = \sum_{r \in \mathbb{R}} B_r(a) z^{-r-1};$$

vacuum vector): $\mathbf{1}^c \in F_{0,0}^c$ and $\mathbf{1}^o \in F_0^o$;

Virasoro elements): $\omega \in F_{2,0}^c$, $\bar{\omega} \in F_{0,2}^c$ and $\nu \in F_2^o$.

Those three OPEs Y^c, Y^o, Y^b classically correspond to the three generators of 2-colored magma in Section 2.1.

Using the action of PaPB on conformal blocks, this section shows that for any 2-colored tree $E \in \mathcal{T}^o(r, s)$, the three OPEs converge in the corresponding open region in the upper half-plane $U_E^o \subset X_{r,s}(\overline{\mathbb{H}})$ and defines the correlation functions which are independent of orders and parentheses of OPEs.

In Section 3.1, we will study the consistency of a bulk algebra $(F^c, Y^c, \mathbf{1}^c)$ for any binary tree \mathcal{T}^c . In section 3.2 and section 3.3, the consistency of a boundary algebra $(F^o, Y^o, \mathbf{1}^o)$ and a bulk-boundary algebra $(F^c, F^o, Y^c, Y^o, Y^b)$ will be studied.

3.1. Bulk OPE algebra. A mathematical formulation of the OPE algebra in a 2d conformal field theory without boundary was introduced in [HK1]. Our study focus on the consistency of OPEs from the bootstrap equation. We will look back at a slightly different reformulation given in [Mo1] based on the bootstrap equation and formulate and prove the consistency of a bulk conformal field theory based on Section 2.

A full vertex operator algebra is a generalization of a vertex operator algebra as in the following table: Since the full conformal field theory has two mutually commuting

	chiral vertex algebra	full vertex algebra
symmetry	Vir_c	$\text{Vir}_c \oplus \text{Vir}_{\bar{c}}$
vector space	$V = \bigoplus_{n \in \mathbb{Z}} V_n$	$F = \bigoplus_{h, \bar{h} \in \mathbb{R}^2} F_{h, \bar{h}}$
vertex operator	$\text{End}V[[z^{\pm}]]$	$\text{End}F[[z, \bar{z}, z ^{\mathbb{R}}]]$
pole	$\mathbb{C}((z))$	$\mathbb{C}((z, \bar{z}, z ^{\mathbb{R}}))$

TABLE 2. Comparison of chiral and full vertex algebras

Virasoro algebras acting on it, it has \mathbb{R}^2 -grading by $L(0), \overline{L(0)}$.

Let $F = \bigoplus_{h, \bar{h} \in \mathbb{R}} F_{h, \bar{h}}$ be an \mathbb{R}^2 -graded vector space and $L(0), \overline{L(0)} : F \rightarrow F$ linear maps defined by $L(0)|_{F_{h, \bar{h}}} = h \text{id}_{F_{h, \bar{h}}}$ and $\overline{L(0)}|_{F_{h, \bar{h}}} = \bar{h} \text{id}_{F_{h, \bar{h}}}$ for any $h, \bar{h} \in \mathbb{R}$. We assume that:

- FO1) $F_{h, \bar{h}} = 0$ unless $h - \bar{h} \in \mathbb{Z}$;
- FO2) There exists $N \in \mathbb{R}$ such that $F_{h, \bar{h}} = 0$ unless $h \geq N$ and $\bar{h} \geq N$;
- FO3) For any $H \in \mathbb{R}$, $\bigoplus_{h + \bar{h} \leq H} F_{h, \bar{h}}$ is finite-dimensional.

Set

$$F^{\vee} = \bigoplus_{h, \bar{h} \in \mathbb{R}} F_{h, \bar{h}}^*$$

where $F_{h, \bar{h}}^*$ is the dual vector space.

We will use the notation \underline{z} for the pair (z, \bar{z}) and $|z|^2$ for $z\bar{z}$. For a vector space V , we denote by $V[[z^{\mathbb{R}}, \bar{z}^{\mathbb{R}}]]$ the set of formal sums

$$\sum_{r, s \in \mathbb{R}} a_{r, s} z^r \bar{z}^s,$$

and by $V[[z, \bar{z}, |z|^{\mathbb{R}}]]$ the subspace of $V[[z^{\mathbb{R}}, \bar{z}^{\mathbb{R}}]]$ such that

- $a_{r, s} = 0$ unless $r - s \in \mathbb{Z}$.

We also denote by $V((z, \bar{z}, |z|^{\mathbb{R}}))$ the subspace of $V[[z, \bar{z}, |z|^{\mathbb{R}}]]$ spanned by the series satisfying

- There exists $N \in \mathbb{R}$ such that $a_{r, s} = 0$ unless $r, s \geq N$;
- For any $H \in \mathbb{R}$,

$$\{(r, s) \mid a_{r, s} \neq 0 \text{ and } r + s \leq H\}$$

is a finite set.

The formal power series $\mathbb{C}((z, \bar{z}, |z|^{\mathbb{R}}))$ is a generalization of the Laurent series bounded below into two variables, which describes singularities of correlation functions in 2d compact conformal field theory.

A *full vertex operator* on F is a linear map

$$Y(\bullet, z, \bar{z}) : F \rightarrow \text{End}(F)[[z, \bar{z}, |z|^{\mathbb{R}}]], \quad a \mapsto Y(a, z, \bar{z}) = \sum_{r, s \in \mathbb{R}} a(r, s) z^{-r-1} \bar{z}^{-s-1}$$

such that:

$$(3.1) \quad \begin{aligned} [L(0), Y(a, \underline{z})] &= z \frac{d}{dz} Y(a, \underline{z}) + Y(L(0)a, \underline{z}), \\ [\bar{L}(0), Y(a, \underline{z})] &= \bar{z} \frac{d}{d\bar{z}} Y(a, \underline{z}) + Y(\bar{L}(0)a, \underline{z}). \end{aligned}$$

Then, by (FO1), (FO2) and (FO3), $Y(a, \underline{z})b \in F((z, \bar{z}, |z|^{\mathbb{R}}))$ (see [Mo1, Proposition 1.5]).

By (3.1) (for more detail, see [Mo1, Lemma 1.6]), for $u \in F_{h_0, \bar{h}_0}^{\vee}$ and $a_i \in F_{h_i, \bar{h}_i}$ we have

$$(3.2) \quad u(Y(a_1, \underline{z}_1)Y(a_2, \underline{z}_2)a_3) \in z_2^{h_0-h_1-h_2-h_3} \bar{z}_2^{\bar{h}_0-\bar{h}_1-\bar{h}_2-\bar{h}_3} \mathbb{C}\left(\left(\frac{z_2}{z_1}, \frac{\bar{z}_2}{\bar{z}_1}, \left|\frac{z_2}{z_1}\right|^{\mathbb{R}}\right)\right),$$

$$(3.3) \quad u(Y(Y(a_1, \underline{z}_0)a_2, \underline{z}_2)a_3) \in z_2^{h_0-h_1-h_2-h_3} \bar{z}_2^{\bar{h}_0-\bar{h}_1-\bar{h}_2-\bar{h}_3} \mathbb{C}\left(\left(\frac{z_0}{z_2}, \frac{\bar{z}_0}{\bar{z}_2}, \left|\frac{z_0}{z_2}\right|^{\mathbb{R}}\right)\right),$$

where the left-hand side of (3.3) is a formal series in $z_0, \bar{z}_0, |z_0|^{\mathbb{R}}, z_2, \bar{z}_2, |z_2|^{\mathbb{R}}$ but contains only ratios $\left(\frac{z_0}{z_2}\right)^n, \left(\frac{\bar{z}_0}{\bar{z}_2}\right)^m, \left|\frac{z_0}{z_2}\right|^s$ with $n, m \in \mathbb{Z}$ and $s \in \mathbb{R}$ up to the factor in front.

Definition 3.1. A *full vertex algebra* is an \mathbb{R}^2 -graded \mathbb{C} -vector space $F = \bigoplus_{h, \bar{h} \in \mathbb{R}^2} F_{h, \bar{h}}$ equipped with a full vertex operator $Y(\bullet, \underline{z}) : F \rightarrow \text{End}(F)[[z, \bar{z}, |z|^{\mathbb{R}}]]$ and an element $\mathbf{1} \in F_{0,0}$ satisfying the following conditions:

FV1) For any $a \in F$, $Y(a, \underline{z})\mathbf{1} \in F[[z, \bar{z}]]$ and $\lim_{\underline{z} \rightarrow 0} Y(a, \underline{z})\mathbf{1} = a(-1, -1)\mathbf{1} = a$.

FV2) $Y(\mathbf{1}, \underline{z}) = \text{id}_F \in \text{End}F$;

FV3) For any $a_i \in F_{h_i, \bar{h}_i}$ and $u \in F_{h_0, \bar{h}_0}^*$, (3.2) and (3.3) are absolutely convergent in $\{|z_1| > |z_2|\}$ and $\{|z_0| < |z_2|\}$, respectively, and there exists a real analytic function $\mu : Y_2(\mathbb{C}) \rightarrow \mathbb{C}$ such that:

$$\begin{aligned} u(Y(a_1, \underline{z}_1)Y(a_2, \underline{z}_2)a_3) &= \mu(z_1, z_2)|_{|z_1| > |z_2|}, \\ u(Y(Y(a_1, \underline{z}_0)a_2, \underline{z}_2)a_3) &= \mu(z_0 + z_2, z_2)|_{|z_2| > |z_0|}, \\ u(Y(a_2, \underline{z}_2)Y(a_1, \underline{z}_1)a_3) &= \mu(z_1, z_2)|_{|z_2| > |z_1|} \end{aligned}$$

where $Y_2(\mathbb{C}) = \{(z_1, z_2) \in \mathbb{C}^2 \mid z_1 \neq z_2, z_1 \neq 0, z_2 \neq 0\}$.

Remark 3.2. Left-hand-sides of (FV3) coincide under conformal transformations with what is called the *s, t, u-channels* in physics [Mo2]. Thus, a full vertex algebra is a formulation of conformal field theory by the bootstrap equation.

Let F be a full vertex algebra and D and \bar{D} denote the endomorphism of F defined by $Da = a(-2, -1)\mathbf{1}$ and $\bar{D}a = a(-1, -2)\mathbf{1}$ for $a \in F$, i.e.,

$$Y(a, z)\mathbf{1} = a + Daz + \bar{D}a\bar{z} + \dots$$

Then, similarly to the vertex algebra, we have (see [Mo1, Proposition 3.7, Lemma 3.11, Lemma 3.13]):

Proposition 3.3. *Let F be a full vertex algebra. Then, the following properties hold:*

translation invariance): For any $a \in F$,

$$[D, Y(a, \underline{z})] = Y(Da, \underline{z}) = \frac{d}{dz} Y(a, \underline{z}),$$

$$[\bar{D}, Y(a, \underline{z})] = Y(\bar{D}a, \underline{z}) = \frac{d}{d\bar{z}} Y(a, \underline{z}).$$

skew-symmetry): For any $a, b \in F$,

$$Y(a, \underline{z})b = \exp(zD + \bar{z}\bar{D})Y(b, -\underline{z})a.$$

Moreover, if $\bar{D}a = 0$, then for any $n \in \mathbb{Z}$ and $b \in F$,

$$[a(n, -1), Y(b, \underline{z})] = \sum_{j \geq 0} \binom{n}{j} Y(a(j, -1)b, \underline{z})z^{n-j},$$

$$Y(a(n, -1)b, \underline{z}) = \sum_{j \geq 0} \binom{n}{j} (-1)^j a(n-j, -1)z^j Y(b, \underline{z})$$

$$- Y(b, \underline{z}) \sum_{j \geq 0} \binom{n}{j} (-1)^{j+n} a(j, -1)z^{n-j}.$$

Furthermore, if $\bar{D}a = 0$ and $Db = 0$, then $[Y(a, \underline{z}), Y(b, \underline{z})] = 0$.

Remark 3.4. By (FV2) and (FV6), $a(r, s) = 0$ if $r - s \notin \mathbb{Z}$. Thus, $Y(a, \underline{z})$ consists of $z^n \bar{z}^m |z|^r$ with $n, m \in \mathbb{Z}$ and $r \in \mathbb{R}$. Hence, $Y(a, \underline{z})$ does not have the monodromy around $z = 0$. In particular, $Y(a, -\underline{z})$ is well-defined.

An energy-momentum tensor of a full vertex algebra is a pair of vectors $\omega \in F_{2,0}$ and $\bar{\omega} \in F_{0,2}$ such that

- (1) $\bar{D}\omega = 0$ and $D\bar{\omega} = 0$;
- (2) There exist scalars $c, \bar{c} \in \mathbb{C}$ such that $\omega(3, -1)\omega = \frac{c}{2}\mathbf{1}$, $\bar{\omega}(-1, 3)\bar{\omega} = \frac{\bar{c}}{2}\mathbf{1}$ and $\omega(k, -1)\omega = \bar{\omega}(-1, k)\bar{\omega} = 0$ for any $k = 2$ or $k \in \mathbb{Z}_{\geq 4}$.
- (3) $\omega(0, -1) = D$ and $\bar{\omega}(-1, 0) = \bar{D}$;
- (4) $\omega(1, -1)|_{F_{h,\bar{h}}} = h$ and $\bar{\omega}(-1, 1)|_{F_{h,\bar{h}}} = \bar{h}$ for any $h, \bar{h} \in \mathbb{R}$.
- (5) There is $N \in \mathbb{R}$ such that $F_{h,\bar{h}} = 0$ for any $h < N$ or $\bar{h} < N$;
- (6) For any $H > 0$, $\sum_{h+\bar{h} < H} \dim F_{h,\bar{h}} < \infty$.

Set

$$L(n) = \omega(n, -1) \quad \text{and} \quad \bar{L}(n) = \bar{\omega}(-1, n).$$

We remark that $\{L(n)\}_{n \in \mathbb{Z}}$ and $\{\bar{L}(n)\}_{n \in \mathbb{Z}}$ satisfy the commutation relation of the Virasoro algebra and are mutually commute by Proposition 3.3. A *full vertex operator algebra* is a pair of a full vertex algebra and its energy momentum tensor.

Proposition 3.5. [Mo1, Proposition 3.18] *Let $(F, \omega, \bar{\omega})$ be a full vertex operator algebra. Then, $\ker \bar{L}(-1)$ and $\ker L(-1)$ are subalgebra of F and*

$$\ker \bar{L}(-1) \otimes \ker L(-1) \rightarrow F, \quad a \otimes b \mapsto a(-1, -1)b$$

is a full vertex algebra homomorphism. Moreover, $(\ker \bar{L}(-1), \omega)$ and $(\ker L(-1), \bar{\omega})$ are vertex operator algebras.

Let V be a positive graded vertex operator algebra.

Definition 3.6. *We call a full vertex operator algebra F locally C_1 -cofinite over V if there are $M_i, \bar{M}_i \in \underline{V\text{-mod}}_{f.g.}$ indexed by some countable set I_c such that:*

LC1) V is a subalgebra of $\ker L(-1)$ and $\ker \bar{L}(-1)$;

LC2) F is isomorphic to $\bigoplus_{i \in I_c} M_i \otimes \bar{M}_i$ as a $V \otimes V$ -module;

LC3) For any $i, j \in I_c$, there exists finite subset $I_c(i, j) \subset I_c$ such that:

$$Y(\bullet, \underline{z})\bullet \in \bigoplus_{i, j \in I_c} \bigoplus_{k \in I_c(i, j)} I \begin{pmatrix} M_k \\ M_i M_j \end{pmatrix} \otimes I \begin{pmatrix} \bar{M}_k \\ \bar{M}_i \bar{M}_j \end{pmatrix},$$

where $I \begin{pmatrix} M_k \\ M_i M_j \end{pmatrix}$ and $I \begin{pmatrix} \bar{M}_k \\ \bar{M}_i \bar{M}_j \end{pmatrix}$ are the space of intertwining operators of V .

Note that (LC2) implies that

$$Y(a, \underline{z})b \in \bigoplus_{k \in I_c(i, j)} M_k \otimes \bar{M}_k((z, \bar{z}, |z|^{\mathbb{R}}))$$

for any $a \in M_i \otimes \bar{M}_i$ and $b \in M_j \otimes \bar{M}_j$.

Assume that (F, Y) is a locally C_1 -cofinite full vertex operator algebra. For each $r \geq 2$ and $A \in \mathcal{T}_r^c$, we can define a parenthesized composition of the full vertex operator $Y_A(\bullet, \underline{z})$, similarly to Section 1.3. For any $a_{[r]} \in F^{\otimes r}$ and $u \in F^\vee$,

$$(3.4) \quad \langle u, \exp(L(-1)z_A + \bar{L}(-1)\bar{z}_A)Y_A(a_{[r]}, \underline{z}_{[r]}) \rangle,$$

is a formal power series. By local C_1 -cofiniteness and Theorem 1.19, (3.4) is absolutely convergent to a holomorphic function on $U_A \times U_A \subset X_r(\mathbb{C})$. By (L2), z and \bar{z} in (3.4) are of the form $z^n \bar{z}^m (z\bar{z})^r$ with $n, m \in \mathbb{Z}$ and $r \in \mathbb{R}$. Hence, the restriction of (3.4) on (2.8),

$$U_A^c \hookrightarrow \bar{U}_A \times \bar{U}_A, \quad z_{[r]} \mapsto (z_{[r]}, \bar{z}_{[r]}),$$

is a single-valued real analytic function.

Definition 3.7. *A full vertex operator algebra F is said to be consistent if the following conditions hold:*

Convergence: *For any $u \in F^\vee$ and $a_{[r]} \in F^{\otimes r}$, $\langle u, \exp(L(-1)z_A + \bar{L}(-1)\bar{z}_A)Y_A(a_{[r]}, \underline{z}_{[r]}) \rangle$ is absolutely locally uniformly convergent to a holomorphic function on $U_A \times U_A \subset X_r(\mathbb{C}) \times X_r(\mathbb{C})$. Denote the restriction of this real analytic function on U_A^c by $C_A(u, a_{[r]}; \underline{z}_{[r]})$, which is a real analytic function on $X_r(\mathbb{C})$.*

Compatibility: *There exists a family of linear maps*

$$C_r : F^\vee \otimes F^{\otimes r} \rightarrow C^\omega(X_r(\mathbb{C})), \quad \text{for } r \geq 2$$

where $C^\omega(X_r(\mathbb{C}))$ is the vector space of real analytic functions on $X_r(\mathbb{C})$, such that:

$$(3.5) \quad C_r(u, a_{[r]}; z_{[r]}) \Big|_{U_A^c} = C_A(u, a_{[r]}; z_{[r]})$$

for any $a_{[r]}$ as real analytic functions on U_A^c .

Remark 3.8. *It is natural to extend the definition of $C_r : F^\vee \otimes F^{\otimes r} \rightarrow C^\omega(X_r(\mathbb{C}))$ to $r = 0, 1$ by*

$$C_0 : F^\vee \rightarrow \mathbb{C}, \quad u \mapsto \langle u, \mathbf{1} \rangle$$

and

$$C_1 : F^\vee \otimes F \rightarrow C^\omega(X_1(\mathbb{C})), \quad u \mapsto \langle u, \exp(L(-1)z + \bar{L}(-1)\bar{z})a \rangle,$$

where we think z as the standard coordinate of $\mathbb{C} = X_1(\mathbb{C})$.

$\{C_r\}_{r \geq 0}$ are called *correlation functions* in physics and is the most important physical quantity in quantum field theory.

Theorem 3.9. *A locally C_1 -cofinite full vertex operator algebra is consistent. Moreover, the sequence of linear maps $\{C_r : F^\vee \otimes F^{\otimes r} \rightarrow C^\omega(X_r(\mathbb{C}))\}_{r=0,1,\dots}$ in (3.5) and Remark 3.8 satisfy the following conditions:*

(Symmetry): *For any $\sigma \in S_r$, $u \in F^\vee$ and $a_1, \dots, a_r \in F$,*

$$C_r(u, a_1, \dots, a_r; z_1, \dots, z_r) = C_r(u, a_{\sigma(1)}, \dots, a_{\sigma(r)}; z_{\sigma(1)}, \dots, z_{\sigma(r)}),$$

where S_r is the symmetric group.

(Conformal covariance):

$$\begin{aligned}
C_r(u, L(-1)_i a_{[r]}; z_{[r]}) &= \frac{d}{dz_i} C_r(u, a_{[r]}; z_{[r]}) \\
C_r(u, \bar{L}(-1)_i a_{[r]}; z_{[r]}) &= \frac{d}{d\bar{z}_i} C_r(u, a_{[r]}; z_{[r]}) \\
C_r(L(-1)^* u, a_{[r]}; z_{[r]}) &= \sum_{i=1}^r C_r(u, L(-1)_i a_{[r]}; z_{[r]}) \\
C_r(\bar{L}(-1)^* u, a_{[r]}; z_{[r]}) &= \sum_{i=1}^r C_r(u, \bar{L}(-1)_i a_{[r]}; z_{[r]}) \\
C_r(L(0)^* u, a_{[r]}; z_{[r]}) &= \sum_{i=1}^r C_r(u, (z_i \frac{d}{dz_i} + L(0)_i) a_{[r]}; z_{[r]}) \\
C_r(\bar{L}(0)^* u, a_{[r]}; z_{[r]}) &= \sum_{i=1}^r C_r(u, (z_i \frac{d}{d\bar{z}_i} + \bar{L}(0)_i) a_{[r]}; z_{[r]}) \\
C_r(L(1)^* u, a_{[r]}; z_{[r]}) &= \sum_{i=1}^r C_r(u, (z_i^2 \frac{d}{dz_i} + z_i L(0)_i + L(1)_i) a_{[r]}; z_{[r]}) \\
C_r(\bar{L}(1)^* u, a_{[r]}; z_{[r]}) &= \sum_{i=1}^r C_r(u, (\bar{z}_i^2 \frac{d}{d\bar{z}_i} + \bar{z}_i \bar{L}(0)_i + \bar{L}(1)_i) a_{[r]}; z_{[r]})
\end{aligned}$$

(Vacuum property): For any $u \in F^\vee$ and $a_1, \dots, a_{r-1} \in F$,

$$C_r(u, a_1, \dots, a_{r-1}, \mathbf{1}; z_1, \dots, z_r) = C_{r-1}(u, a_1, \dots, a_{r-1}; z_1, \dots, z_{r-1}).$$

Proof. We will show this in the case that the index set I in the definition of local C_1 -cofiniteness is finite. The general case can be shown in a similar way by (LC3). Then, $F \in D = \underline{V\text{-mod}}_{f.g.} \boxtimes \underline{V\text{-mod}}_{f.g.}$. By (LC3) and Proposition 1.15, we can identify the full vertex operator as a full conformal block:

$$s_{12}(\langle \bullet, \exp(L(-1)z_2 + \bar{L}(-1)\bar{z}_2)Y(\bullet, \underline{z}) \rangle) \in \mathcal{CB}_{F,F,F}^c(12).$$

By Theorem 1.19, for any $A \in \mathcal{T}_r^c$, the composite full vertex operator defines a section

$$s_A(\langle \bullet, \exp(L(-1)z_A + \bar{L}(-1)\bar{z}_A)Y_A(\bullet, \underline{z}_{[r]}) \rangle) \in \mathcal{CB}_{F,F^{\otimes r}}^c(U_A^c).$$

In particular, for any $u \in F^\vee$, $\langle u, \exp(L(-1)z_A + \bar{L}(-1)\bar{z}_A)Y_A(a_{[r]}, \underline{z}_{[r]}) \rangle$ absolutely convergent on $U_A \times U_A$, and thus U_A^c , and has analytic continuation to the possibly multi-valued real analytic function on $X_r(\mathbb{C})$. To prove the single-valuedness, it suffices to show that for any path $\gamma : A \rightarrow B$ in $\underline{\text{PaB}}(r)$,

$$(3.6) \quad A(\gamma) \left(C_A(u, a_{[r]}, \underline{z}_{[r]}) \right) = C_B(u, a_{[r]}, \underline{z}_{[r]}).$$

In the case of $r = 2$, by the definition of a full vertex algebra, $\langle u, \exp(L(-1)z_2 + \bar{L}(-1)\bar{z}_2)Y(a_1, \underline{z}_{12})a_2 \rangle$ is in $\mathbb{C}[z_1, z_2, \bar{z}_1, \bar{z}_2, |z_1 - z_2|^{\mathbb{R}}]$. In particular, it is a single-valued real analytic function. Hence, it suffices to show that (3.6) holds for the path $\sigma : (12) \rightarrow (21)$ in $\underline{\text{PaB}}(2)$ (see Fig 10).

By Proposition 3.3, we have:

$$\langle u, Y(a_1, \underline{z}_{12})a_2 \rangle = \langle u, \exp(L(-1)z_{12} + \bar{L}(-1)\bar{z}_{12})Y(a_2, -\underline{z}_{12})a_1 \rangle.$$

Since the conformal weights of F is bounded below, $\exp(L(-1)z_{12} + \bar{L}(-1)\bar{z}_{12})\langle u \mid$ is a finite sum. By setting $u = \exp(L(-1)z_2 + \bar{L}(-1)\bar{z}_2)u'$, we have:

$$\langle u', \exp(L(-1)z_2 + \bar{L}(-1)\bar{z}_2)Y(a_1, \underline{z}_{12})a_2 \rangle = \langle u', \exp(L(-1)z_1 + \bar{L}(-1)\bar{z}_1)Y(a_2, -\underline{z}_{12})a_1 \rangle.$$

Hence, we have:

$$(3.7) \quad A(\sigma) \left(C_{12}(u, a_{[2]}, \underline{z}_{[2]}) \right) = C_{21}(u, a_{[2]}, \underline{z}_{[2]})$$

and thus (3.6) hold for all the paths in $\underline{\text{PaB}}(2)$ (see also Remark 3.4).

In the case of $r = 3$, by the definition of a full vertex algebra, all of the following functions have analytic continuation to $X_3(\mathbb{C})$ and coincide with each others;

$$\begin{aligned} s_{1(23)} & \left(\langle u, \exp(L(-1)z_3 + \bar{L}(-1)\bar{z}_3)Y(a_1, \underline{z}_{13})Y(a_2, \underline{z}_{23})a_3 \rangle \right) \\ s_{2(13)} & \left(\langle u, \exp(L(-1)z_3 + \bar{L}(-1)\bar{z}_3)Y(a_2, \underline{z}_{23})Y(a_1, \underline{z}_{13})a_3 \rangle \right) \\ s_{(12)3} & \left(\langle u, \exp(L(-1)z_3 + \bar{L}(-1)\bar{z}_3)Y(Y(a_1, \underline{z}_{12})a_2, \underline{z}_{23})a_3 \rangle \right). \end{aligned}$$

In particular, for $\alpha : (12)3 \rightarrow 1(23)$ in $\underline{\text{PaB}}(3)$ in Fig. 11,

$$(3.8) \quad A(\alpha) \left(C_{(12)3}(u, a_{[3]}, \underline{z}_{[3]}) \right) = C_{1(23)}(u, a_{[3]}, \underline{z}_{[3]}).$$

Let us consider the general case: By definition of C_A and the glueing of conformal blocks,

$$\text{glue}_p(C_A, C_B) = C_{A \circ_p B}.$$

Since $\underline{\text{PaB}}$ is generated by $\alpha : (12)3 \rightarrow 1(23)$ and $\sigma : 12 \rightarrow 21$ as an operad, by Theorem 2.2 and (3.7) and (3.8), (3.6) hold for all paths.

(Symmetry) is obvious by the construction of C_r 's. For $i = 1, \dots, r-1$,

$$\begin{aligned} C_r(u, L(-1)_i a_{[r]}, \underline{z}_{[r]}) &= \frac{d}{dz_i} C_r(u, a_{[r]}, \underline{z}_{[r]}) \\ C_r(u, \bar{L}(-1)_i a_{[r]}, \underline{z}_{[r]}) &= \frac{d}{d\bar{z}_i} C_r(u, a_{[r]}, \underline{z}_{[r]}) \end{aligned}$$

follows from Proposition 3.3. Since

$$\begin{aligned}
& \frac{d}{dz_r} C_r(u, a_{[r]}; z_{[r]}) \\
&= \frac{d}{dz_r} \langle u, \exp(L(-1)z_r + \bar{L}(-1)\bar{z}_r) Y(a_1, \underline{z}_{1r}) Y(a_2, \underline{z}_{2r}) \dots Y(a_{r-1} z_{r-1,r}) a_r \rangle \\
&= \langle u, \exp(L(-1)z_r + \bar{L}(-1)\bar{z}_r) L(-1) Y(a_1, \underline{z}_{1r}) Y(a_2, \underline{z}_{2r}) \dots Y(a_{r-1} z_{r-1,r}) a_r \rangle \\
&\quad - \sum_{i=1}^{r-1} \frac{d}{dz_i} \langle u, \exp(L(-1)z_r + \bar{L}(-1)\bar{z}_r) Y(a_1, \underline{z}_{1r}) Y(a_2, \underline{z}_{2r}) \dots Y(a_{r-1} z_{r-1,r}) a_r \rangle \\
&= \langle u, \exp(L(-1)z_r + \bar{L}(-1)\bar{z}_r) L(-1) Y(a_1, \underline{z}_{1r}) Y(a_2, \underline{z}_{2r}) \dots Y(a_{r-1} z_{r-1,r}) a_r \rangle \\
&\quad - \sum_{i=1}^{r-1} \langle u, \exp(L(-1)z_r + \bar{L}(-1)\bar{z}_r) Y(a_1, \underline{z}_{1r}) \dots [L(-1), Y(a_i, \underline{z}_{ir})] \dots Y(a_{r-1} z_{r-1,r}) a_r \rangle \\
&= \langle u, \exp(L(-1)z_r + \bar{L}(-1)\bar{z}_r) Y(a_1, \underline{z}_{1r}) Y(a_2, \underline{z}_{2r}) \dots Y(a_{r-1} z_{r-1,r}) L(-1) a_r \rangle \\
&= C_r(u, L(-1)_r a_{[r]}; z_{[r]}).
\end{aligned}$$

Similarly, we have

$$\begin{aligned}
& C_r(L(-1)^* u, a_{[r]}; z_{[r]}) \\
&= \langle u, L(-1) \exp(L(-1)z_r + \bar{L}(-1)\bar{z}_r) Y(a_1, \underline{z}_{1r}) Y(a_2, \underline{z}_{2r}) \dots Y(a_{r-1} z_{r-1,r}) a_r \rangle \\
&= \sum_{k=1}^{r-1} \langle u, \exp(L(-1)z_r + \bar{L}(-1)\bar{z}_r) Y(a_1, \underline{z}_{1r}) \dots [L(-1), Y(a_k, \underline{z}_{kr})] \dots Y(a_{r-1} z_{r-1,r}) a_r \rangle \\
&\quad + \langle u, \exp(L(-1)z_r + \bar{L}(-1)\bar{z}_r) Y(a_1, \underline{z}_{1r}) Y(a_2, \underline{z}_{2r}) \dots Y(a_{r-1} z_{r-1,r}) L(-1) a_r \rangle \\
&= \sum_{i=1}^r C_r(u, L(-1)_i a_{[r]}; z_{[r]}).
\end{aligned}$$

Before showing the other covariance, we will see (Vaccum). Since $Y(\mathbf{1}, \underline{z}) = \text{id}_F$, we have:

$$\begin{aligned}
& C_{r+1}(u, \mathbf{1}, a_1, \dots, a_r; z_0, z_1, \dots, z_r) |_{U_{0(1 \dots (r-1r))}^c} \\
&= \langle u, \exp(L(-1)z_r + \bar{L}(-1)\bar{z}_r) Y(\mathbf{1}, \underline{z}_{0r}) Y(a_1, \underline{z}_{1r}) \dots Y(a_{r-1}, \underline{z}_{r-1r}) a_r \rangle \\
&= \langle u, \exp(L(-1)z_r + \bar{L}(-1)\bar{z}_r) Y(a_1, \underline{z}_{1r}) \dots Y(a_{r-1}, \underline{z}_{r-1r}) a_r \rangle \\
&= C_r(u, a_1, \dots, a_r; z_1, \dots, z_r) |_{U_{1 \dots (r-1r))}^c}
\end{aligned}$$

Hence, (Vacuum) holds. We remark that, by (Vacuum),

$$C_{r+1}(a_1, \dots, a_r, \mathbf{1}; z_{[r+1]}) |_{U_{1(2 \dots (rr+1))}} = \langle u, \exp(L(-1)z_{r+1} + \bar{L}(-1)\bar{z}_{r+1}) Y(a_1, \underline{z}_1) Y(a_2, \underline{z}_2) \dots Y(a_r, \underline{z}_r) \mathbf{1} \rangle,$$

is independent of z_{r+1} . Therefore, we can set $z_{r+1} = 0$ and obtain

$$(3.9) \quad \langle u, Y(a_1, \underline{z}_1) Y(a_2, \underline{z}_2) \dots Y(a_r, \underline{z}_r) \mathbf{1} \rangle = C_r(a_1, \dots, a_r; z_{[r]}) |_{|z_1| > \dots > |z_r|}$$

by Proposition 1.8. (3.9) is more symmetric with respect to the indexes from 1 to r and is often computationally convenient. By using (3.9), we can similarly obtain the conformal

covariance by

$$[L(1), Y(a, \underline{z})] = Y((z^2 L(-1) + L(0)z + L(1))a, \underline{z})$$

$$[L(1), Y(a, \underline{z})] = Y((\bar{z}^2 \bar{L}(-1) + \bar{L}(0)\bar{z} + \bar{L}(1))a, \underline{z})$$

and

$$[L(0), Y(a, \underline{z})] = Y((zL(-1) + L(0))a, \underline{z})$$

$$[L(0), Y(a, \underline{z})] = Y((\bar{z}\bar{L}(-1) + \bar{L}(0))a, \underline{z})$$

and $L(0)\mathbf{1} = \bar{L}(0)\mathbf{1} = L(1)\mathbf{1} = \bar{L}(1)\mathbf{1} = 0$ (see [Mo1, Lemma 3.11]). \square

Remark 3.10. *Part of this theorem is first obtained by Huang and Kong [HK1] based on the representation theory of a rational C_2 -cofinite vertex operator algebra developed by Huang and Lepowsky (see [HL]). They showed the above theorem for special trees in \mathcal{T}^c when V is a rational C_2 -cofinite VOA.*

The following corollary follows from the argument in the above proof (3.9):

Corollary 3.11. *under the assumption of Theorem 3.9, for any $u \in F^\vee$ and $a_i \in F$,*

$$\langle u, Y(a_1, \underline{z}_1)Y(a_2, \underline{z}_2) \dots Y(a_r, \underline{z}_r)\mathbf{1} \rangle$$

is absolutely convergent in $|z_1| > |z_2| > \dots > |z_r|$ to $C_r(a_1, \dots, a_r; \underline{z}_{[r]})$.

Remark 3.12. *Since $Y(a, \underline{z})\mathbf{1} = \exp(L(-1)z + \bar{L}(-1)\bar{z})a$,*

$$\begin{aligned} & \langle u, Y(a_1, \underline{z}_1)Y(a_2, \underline{z}_2) \dots Y(a_{r-1}, \underline{z}_{r-1})Y(a_r, \underline{z}_r)\mathbf{1} \rangle \\ &= \langle u, Y(a_1, \underline{z}_1)Y(a_2, \underline{z}_2) \dots Y(a_{r-1}, \underline{z}_{r-1}) \exp(L(-1)z_r + \bar{L}(-1)\bar{z}_r)a_r \rangle \\ &= \langle u, \exp(L(-1)z_r + \bar{L}(-1)\bar{z}_r)Y(a_1, \underline{z}_1 - \underline{z}_r)Y(a_2, \underline{z}_2 - \underline{z}_r) \dots Y(a_{r-1}, \underline{z}_{r-1} - \underline{z}_r)a_r \rangle, \end{aligned}$$

which is equal to $\langle u, \exp(L(-1)z_r + \bar{L}(-1)\bar{z}_r)Y(a_1, \underline{z}_{1r})Y(a_2, \underline{z}_{2r}) \dots Y(a_{r-1}, \underline{z}_{r-1,r})a_r \rangle$ after the change of variables. However, formal calculus alone cannot yield the convergence region in Corollary 3.11.

Remark 3.13. *The Osterwalder-Schrader axioms (OS axioms) are axioms that characterizes quantum field theory using correlation functions [OS1, OS2]. Since $z \frac{d}{dz} - \bar{z} \frac{d}{d\bar{z}}$ generates the rotation of the complex plane \mathbb{C} , the first and the second equations in (Conformal covariance) imply the Poincare invariance $\mathbb{R}^2 \rtimes \text{SO}(2)$. The orthogonal group $\text{SO}(2)$ appears here since $h_i - \bar{h}_i \in \mathbb{Z}$. If we consider a full vertex operator superalgebra, i.e., $h_i - \bar{h}_i \in \frac{1}{2}\mathbb{Z}$, then $\text{SO}(2)$ should be changed by $\text{Spin}(2)$. Those invariance is nothing but the part of the OS axioms. The commutativity of a full vertex operator algebra corresponds to (Symmetry) which is the locality condition of the OS axioms. It is noteworthy that we do not assume any unitarity condition, while the OS axioms does, the Reflection positivity. Thus, to prove that $\{C_r\}_{r \geq 0}$ satisfy the OS axioms, it is obvious that we need to assume unitarity on F .*

Another point to note is that in the OS axioms $\{C_r\}_{r \geq 0}$ are tempered distributions (with the linear growth condition), not real analytic functions. Once these three, (Temperedness), (Reflection positivity) and (Linear growth) are shown, the Wightman field (quantum field on the Minkowski space $\mathbb{R}^{1,1}$) can be obtained. Those are discussed in a joint work with M.S. Adamo and Y. Tanimoto in [AMT].

We note that Theorem 3.9 is easily extended to the case where the VOAs appearing in the chiral and anti-chiral parts do not coincide. We will state the precise statement here. The proof is completely parallel.

Theorem 3.14. *Let F be a full vertex operator algebra and V, W positive graded vertex operator algebras. Assume that there are C_1 -cofinite V -modules M_i and C_1 -cofinite W -modules \overline{M}_i indexed by some countable set I such that:*

- (1) V is a subalgebra of $\ker L(-1)$ and W is a subalgebra of $\ker \overline{L}(-1)$;
- (2) F is isomorphic to $\bigoplus_{i \in I} M_i \otimes \overline{M}_i$ as a $V \otimes W$ -module;
- (3) For any $i, j \in I$, there exists finite subset $I(i, j) \subset I$ such that:

$$Y(\bullet, \underline{z})\bullet \in \bigoplus_{i, j \in I} \bigoplus_{k \in I(i, j)} I\left(\begin{matrix} M_k \\ M_i M_j \end{matrix}\right) \otimes I\left(\begin{matrix} \overline{M}_k \\ \overline{M}_i \overline{M}_j \end{matrix}\right),$$

where $I\left(\begin{matrix} M_k \\ M_i M_j \end{matrix}\right)$ and $I\left(\begin{matrix} \overline{M}_k \\ \overline{M}_i \overline{M}_j \end{matrix}\right)$ are the space of intertwining operators of V and W , respectively.

Then, F is consistent and C_r 's satisfy the properties in Theorem 3.9.

3.2. Boundary OPE algebra. The algebra appearing on the boundary of 2d CFT is mathematically formulated in [HK2], which is called an *open-string vertex algebra*. The necessary and sufficient conditions for constructing an open-string vertex algebra are described in [HK2, Proposition 2.7] under assumptions similar to (but slightly stronger) the local C_1 -cofiniteness in the previous section.

In this section, we will introduce the boundary OPE algebra based on the bootstrap equation (see also [HK2, Proposition 2.7]). Then, we state and prove the consistency of the OPEs with respect to all trees $\mathcal{T}^o(0, s)$.

Let V be a positively graded vertex operator algebra with the conformal vector $\omega^o \in V_2$. Let $F^o = \bigoplus_{h \in \mathbb{R}} F_h^o$ be a V -module such that $L^o(0)|_{F_h^o} = h \text{id}_{F_h^o}$ for any $h \in \mathbb{R}$, where

$$Y(\omega^o, z) = \sum_{n \in \mathbb{Z}} L^o(n) z^{-n-1}.$$

We assume that:

- For any $H \in \mathbb{R}$, $\bigoplus_{h \leq H} F_h^o$ is finite-dimensional.

Set

$$(F^o)^\vee = \bigoplus_{h \in \mathbb{R}} (F_h^o)^*,$$

where $(F_h^o)^*$ is the dual vector space.

For a vector space W , we denote by $W((z^{\mathbb{R}}))$ the subspace of $W[[z^{\mathbb{R}}]]$ spanned by the series $\sum_{r \in \mathbb{R}} a_r z^r$ satisfying

- For any $H \in \mathbb{R}$,

$$\{r \in \mathbb{R} \mid a_r \neq 0 \text{ and } r \leq H\}$$

is a finite set.

A boundary vertex operator on F^o with the chiral symmetry V is a linear map

$$Y^o(\bullet, z) : F^o \rightarrow \text{End}(F^o)[[z^{\mathbb{R}}]], \quad a \mapsto Y^o(a, z) = \sum_{r \in \mathbb{R}} a(r) z^{-r-1}$$

such that:

$$(3.10) \quad \begin{aligned} [L^o(-1), Y^o(v, z)] &= \frac{d}{dz} Y^o(v, z) \\ [a(n), Y^o(v, z)] &= \sum_{k \geq 0} \binom{n}{k} Y^o(a(k)v, z) z^{n-k} \\ Y^o(a(n)v, z) &= \sum_{k \geq 0} \binom{n}{k} (a(n-k) Y^o(v, z) (-z)^k - Y^o(v, z) a(k) (-z)^{n-k}) \end{aligned}$$

for any $a \in V$ and $v \in F^o$, i.e., $Y^o(\bullet, z)$ is an intertwining operator of type $\begin{pmatrix} V \\ VV \end{pmatrix}$. Applying $a = \omega^o$ and $n = 1$, we have:

$$[L^o(0), Y^o(v, z)] = z \frac{d}{dz} Y^o(v, z) + Y^o(L^o(0)a, z).$$

Hence, similarly to the bulk case, $Y(a, z)b \in F^o((z^{\mathbb{R}}))$ and for $u \in (F_h^o)^*$ and $a_i \in F_{h_i}^o$ we have

$$(3.11) \quad u(Y^o(a_1, z_1) Y^o(a_2, z_2) a_3) \in z_2^{h_0 - h_1 - h_2 - h_3} \mathbb{C} \left(\left(\left(\frac{z_2}{z_1} \right)^{\mathbb{R}} \right) \right),$$

$$(3.12) \quad u(Y^o(Y^o(a_1, z_0) a_2, z_2) a_3) \in z_2^{h_0 - h_1 - h_2 - h_3} \mathbb{C} \left(\left(\left(\frac{z_0}{z_2} \right)^{\mathbb{R}} \right) \right).$$

We consider the following assumptions (see [HK2]):

Definition 3.15. Assume that the boundary vertex operator (F^o, Y^o) with the chiral symmetry V together with a distinguished vector $\mathbf{1}^o \in F_0^o$ satisfying the following conditions:

bFV1) For any $a \in F^o$, $Y^o(a, z)\mathbf{1}^o \in F^o[[z]]$ and $\lim_{z \rightarrow 0} Y^o(a, z)\mathbf{1} = a(-1)\mathbf{1} = a$, $Y^o(\mathbf{1}, z) = \text{id}_{F^o} \in \text{End} F^o$;

bFV2) For any $a_1, a_2, a_3 \in F^o$ and $u \in (F^o)^\vee$, (3.11) and (3.12) are absolutely convergent in $\{|z_1| > |z_2|\}$ and $\{|z_0| < |z_2|\}$, respectively, and there exists a real analytic function $\mu(z_1, z_2)$ on $\{(z_1, z_2) \in \mathbb{R}^2 \mid z_1 > z_2 > 0\}$ such that

$$(3.13) \quad \begin{aligned} u(Y^o(a_1, z_1) Y^o(a_2, z_2) a_3) &= \mu(z_1, z_2)|_{z_1 > z_2 > 0}, \\ u(Y^o(Y^o(a_1, z_0) a_2, z_2) a_3) &= \mu(z_1, z_2)|_{z_2 > z_1 - z_2 > 0}, \end{aligned}$$

where we set $z_0 = z_1 - z_2$.

Proposition 3.16. *Let $(F^\circ, Y^\circ, \mathbf{1}^\circ)$ satisfy Definition 3.15. Then, for any $a \in V$, the vertex operator $Y^\circ(a(-1)\mathbf{1}^\circ, z)$ coincides with the vertex operator which gives the V -module structure on F° . In particular, $Y^\circ(a(-1)\mathbf{1}^\circ, z) = \sum_{n \in \mathbb{Z}} a(n)z^{-n-1}$ and*

$$i_o : V \rightarrow F^\circ, \quad a \mapsto a(-1)\mathbf{1}^\circ$$

satisfies $i_o(a(n)b) = i_o(a)(n)i_o(b)$ for any $a, b \in V$ and $n \in \mathbb{Z}$.

Proof. By (3.10) and (bFV1), we have

$$\begin{aligned} Y^\circ(a(-1)\mathbf{1}^\circ, z) &= \sum_{k \geq 0} (-1)^k \left(a(-1-k)Y^\circ(\mathbf{1}^\circ, z)(-z)^k - Y^\circ(\mathbf{1}^\circ, z)a(k)(-z)^{-1-k} \right) \\ &= \sum_{n \in \mathbb{Z}} a(n)z^{-n-1}. \end{aligned}$$

Hence, for any $a, b \in V$ and $n \in \mathbb{Z}$, $i_o(a)(n)i_o(b) = (a(-1)\mathbf{1}^\circ)(n)(b(-1)\mathbf{1}^\circ) = a(n)b(-1)\mathbf{1}^\circ$. By the Borcherds identity as V -module and (bFV1),

$$\begin{aligned} (a(n)b)(-1)\mathbf{1}^\circ &= \sum_{k \geq 0} (-1)^k \binom{n}{k} (a(n-k)b(-1+k)\mathbf{1}^\circ - (-1)^n b(-1-k)a(k)\mathbf{1}^\circ) \\ &= a(n)b(-1)\mathbf{1}^\circ. \end{aligned}$$

□

By the above proposition, we can identify V as a subalgebra of F° . The following proposition is analogous to [LL, Proposition 3.1.19]:

Proposition 3.17. *Let $(F^\circ, Y^\circ, \mathbf{1}^\circ)$ satisfy Definition 3.15. Then,*

$$Y^\circ(v, z)a = \exp(L(-1)^\circ z)Y^\circ(a, -z)v$$

for any $v \in F^\circ$ and $a \in V \subset F^\circ$.

Proof. We first show the case of $a = \mathbf{1}^\circ$. By (bFV1), $Y^\circ(\omega^\circ, z)\mathbf{1}^\circ \in F^\circ[[z]]$, which implies $L^\circ(n-1)\mathbf{1}^\circ = 0$ for any $n \geq 0$. By (3.10),

$$L(-1)^\circ Y^\circ(v, z)\mathbf{1}^\circ = \frac{d}{dz} Y^\circ(v, z)\mathbf{1}^\circ.$$

Since $\lim_{z \rightarrow 0} Y^\circ(v, z)\mathbf{1}^\circ = v$, we can solve this differential equation inductively and get

$$Y^\circ(v, z)\mathbf{1}^\circ = \exp(L^\circ(-1)z)v.$$

By (3.10), we have:

$$\begin{aligned} Y^\circ(v, z)a(-1)\mathbf{1}^\circ &= -[a(-1), Y^\circ(v, z)]\mathbf{1}^\circ + a(-1)Y^\circ(v, z)\mathbf{1}^\circ \\ &= -[a(-1), Y^\circ(v, z)]\mathbf{1}^\circ + a(-1)\exp(L(-1)^\circ z)v \\ &= -\sum_{k \geq 0} \binom{-1}{k} Y^\circ(a(k)v, z)\mathbf{1}^\circ z^{-1-k} + \exp(L^\circ(-1)z) \sum_{k \geq 0} a(-k-1)v(-z)^k \\ &= \sum_{k \geq 0} \exp(L^\circ(-1)z)a(k)v(-z)^{-1-k} + \exp(L^\circ(-1)z) \sum_{k \geq 0} a(-k-1)v(-z)^k \\ &= \exp(L^\circ(-1)z)Y^\circ(a, -z)v \end{aligned}$$

where we use $[L^o(-1), a(n)] = -na(n-1)$ for any $n \in \mathbb{Z}$. \square

Remark 3.18. *Set*

$$Z(F^o) = \{v \in \bigoplus_{n \in \mathbb{Z}} F_n^o \mid Y^o(v, z) \in \text{End} F^o[[z^\pm]]\},$$

$$Y^o(v', z)v = \exp(L(-1)^o z)Y^o(v, -z)v' \text{ for any } v' \in F^o\},$$

which is called a meromorphic center of F^o in [HK2]. Without a priori assuming the existence of VOA, Huang and Kong showed from (bFV2) together with some assumptions on $Y^o(\bullet, z) : F^o \rightarrow \text{End} F^o[[z^\mathbb{R}]]$ that $Z(F^o)$ is a vertex algebra [HK2, Theorem 2.3].

Definition 3.19. *We call $(F^o, Y^o, \mathbf{1}^o)$ with the chiral symmetry V locally C_1 -cofinite if there are $N_i \in \underline{V\text{-mod}}_{f.g.}$ indexed by some countable set I_o such that:*

bLC1) F^o is isomorphic to $\bigoplus_{i \in I_o} N_i$ as a V -module;

bLC2) For any $i, j \in I_o$, there exists finite subset $I_o(i, j) \subset I_o$ such that:

$$Y(\bullet, \underline{z})\bullet \in \bigoplus_{i, j \in I_o} \bigoplus_{k \in I_o(i, j)} I \begin{pmatrix} N_k \\ N_i N_j \end{pmatrix}.$$

Recall that open leaves of a tree $E \in \mathcal{T}^o(0, s)$ are assumed to be ordered and

$$X_{0,s}(\overline{\mathbb{H}}) = \{z_1, \dots, z_s \in \mathbb{R}^s \mid z_1 > z_2 > \dots > z_s\}.$$

We can define the iterated vertex operator $Y_E^o(a_{[0,s]}, z_{[0,s]})$ for $a_{[0,s]} \in (F^o)^{\otimes s}$ and each $E \in \mathcal{T}^o(0, s)$ exactly as in Section 3.1.

Definition 3.20. *Let $(F^o, Y^o, \mathbf{1}^o)$ be the triple in Definition 3.15 with a chiral symmetry V . We call it consistent if the following properties are satisfied:*

Convergence: *For any $u \in (F^o)^\vee$ and $a_{[0,s]} \in (F^o)^{\otimes s}$ and $E \in \mathcal{T}^o(0, s)$,*

$$\langle u, \exp(L(-1)^o z_r)Y_E^o(a_{[0,s]}, z_{[0,s]}) \rangle,$$

is absolutely locally uniformly convergent to a holomorphic function on $U_{\bar{E}} \subset$

$X_s(\mathbb{C})$. Denote the restriction of this analytic function on $U_{\bar{E}} \subset X_{0,s}(\overline{\mathbb{H}})$ by $C_E(u, a_{[0,s]}; z_{[0,s]})$.

Compatibility: *There exists a family of linear maps*

$$C_{0,s} : (F^o)^\vee \otimes (F^o)^{\otimes s} \rightarrow C^\omega(X_{0,s}(\overline{\mathbb{H}})) \quad \text{for } s \geq 2$$

such that:

$$(3.14) \quad C_s(u, a_{[0,s]}; z_{[0,s]}) \Big|_{U_{\bar{E}}} = C_E(u, a_{[0,s]}; z_{[0,s]})$$

for any $a_{[0,s]} \in (F^o)^{\otimes s}$, $u \in (F^o)^\vee$ and $E \in \mathcal{T}^o(0, s)$ as real analytic functions.

The following theorem follows from the same argument as in Theorem 3.9:

Theorem 3.21. *Let $(F^o, Y^o, \mathbf{1}^o)$ with a chiral symmetry V be locally C_1 -cofinite. Then, F^o is consistent.*

Note that C_s does not have the symmetry of the permutation group S_s .

3.3. Bulk-boundary OPE algebra. The algebra appearing on the bulk-boundary of 2d CFT is mathematically formulated in [Ko1], which is called an *open-closed field algebra*. The necessary and sufficient conditions for constructing an open-closed algebra are described in [Ko1, Theorem 1.28] under assumptions similar to (but slightly stronger) the local C_1 -cofiniteness in the previous section.

We reformulate Kong's approach in the following two respects: Kong considered the vertex operator $Y_{\text{cl-op}}(\bullet, z, \bar{z}) : F^c \otimes F^o \rightarrow F^o[[z^{\mathbb{R}}, \bar{z}^{\mathbb{R}}]]$ as the basic building block of the theory, but it is actually sufficient to give a bulk-boundary operator $\tau_y : F^c \rightarrow F^o[[y^{\mathbb{R}}]]$. In Theorem [Ko1, Theorem 1.28], six conditions were assumed as sufficient conditions to construct an open-closed field algebra, but in this section we will see that five are sufficient, and that they correspond exactly to the generator of PaPB as a 2-operad. This five conditions are known as genus 0 boundary bootstrap equations in physics⁴[Le, Conditions (a), (c), (d), (e) in Fig. 9].

Then, we state and prove the consistency of the OPEs with respect to all trees $\mathcal{T}^o(r, s)$ by using the result in Section 2.

Let V be a positive graded vertex operator algebra. Let $(F^o, Y^o, \mathbf{1}^o)$ be the triple in Definition 3.15 with the V -chiral symmetry and $(F^c, Y^c, \mathbf{1}^c, \omega, \bar{\omega})$ a full vertex operator algebra. A V -chiral symmetry on F^c is a vertex algebra homomorphism preserving the conformal vectors $i_r : V \hookrightarrow \ker L^c(-1)$ and $i_l : V \hookrightarrow \ker \bar{L}^c(-1)$. Note that for the chiral symmetry we specify the three embeddings of V into F^o, F^c . Hence, for a vertex operator algebra automorphism $g \in \text{Aut } V$, we think the twisted V -chiral symmetry, e.g., $i_r \circ g : V \hookrightarrow \ker L(-1)$, as different ones, which is important when one considers D branes [Mo6].

To distinguish the three actions of V , set

$$a^l(n) = i_l(a)(n, -1), \quad a^r(n) = i_r(a)(-1, n), \quad a^o(n) = i_o(a)(n)$$

for $a \in V$ and $n \in \mathbb{Z}$ (see also Proposition 3.3 and Proposition 3.16). We also denote $\omega(n+1, -1)_l, \bar{\omega}(-1, n+1)_r$ by $L^l(n), L^r(n)$, respectively.

Definition 3.22. A bulk-boundary vertex operator on (F^c, F^o) with the chiral symmetry V is a linear map

$$Y^b(\bullet, z) : F^c \rightarrow F^o[[z^{\mathbb{R}}]], \quad v \mapsto Y^b(v, z) = \sum_{r \in \mathbb{R}} B_r(v) z^{-r-1}$$

such that:

$$\text{BBC1) For any } v \in F^c, \quad Y^b(L^l(-1)v, z) = \frac{d}{dz} Y^b(v, z);$$

⁴Fig. (9.a) in [Le] corresponds to both the bulk commutativity and associativity, which we count as two.

BBC2) For any $a \in V$, $v \in F^c$ and $n \in \mathbb{Z}$,

$$(3.15) \quad \begin{aligned} a^o(n)Y^b(v, z) &= Y^b(a^r(n)v, z) + \sum_{k \geq 0} \binom{n}{k} Y^b(a^l(k)v, z)z^{n-k} \\ Y^b(a^l(n)v, z) &= \sum_{k \geq 0} \binom{n}{k} (a^o(n-k)Y^b(v, z)(-z)^k - Y^b(a^r(k)v, z)(-z)^{n-k}) \end{aligned}$$

Let $Y(\bullet, z) : F^c \rightarrow F^o[[z^{\mathbb{R}}]]$ be a bulk-boundary vertex operator on (F^c, F^o) with the chiral symmetry V . Applying $a = \omega^o$ and $n = 1$, we have:

$$L^o(0)Y^b(v, z) = z \frac{d}{dz} Y^b(v, z) + Y^b((L^l(0) + L^r(0))v, z),$$

which implies that

$$B_r(v) \in (F^o)_{h+\bar{h}-r-1}$$

for $v \in F_{h, \bar{h}}$ and $r \in \mathbb{R}$. Hence, $Y^b(v, z) \in F^o((z^{\mathbb{R}}))$. Note that if F^c is a direct sum of tensor products of V -modules then the above condition is equivalent to saying that $Y^b(\bullet, z)$ is a V -module intertwining operator.

In the above definition, the holomorphic and anti-holomorphic parts of F^c are treated asymmetrically. However, making them asymmetric is inherently unnatural. Therefore, we introduce a bulk-boundary operator

$$\tau_y : F^c \rightarrow F^o[[y^{\mathbb{R}}]]$$

to treat them symmetrically. As we will see in the next proposition, these concepts are equivalent, and from the standpoint of dealing with vertex operators, $Y^b(\bullet, z)$ is more convenient.

Let $\tau_y : F^c \rightarrow F^o[[y^{\mathbb{R}}]]$ be a linear map defined by

$$(3.16) \quad \tau_y(v) = \exp(-iyL(-1)^o)Y^b(v, 2iy), \quad (v \in F^c)$$

where y is a formal variable and $Y^b(v, 2iy)$ is defined as

$$Y^b(v, 2iy) = \sum_{r \in \mathbb{R}} 2^r \exp\left(\frac{\pi ir}{2}\right) B_r(v) y^r,$$

i.e., we choose the branch of $\log(i)$ as $\frac{\pi i}{2}$. Since $Y^b(v, z) \in F^o((z^{\mathbb{R}}))$, (3.16) is well-defined, that is, each coefficient of y is a finite sum.

Proposition 3.23. *Let $Y^b(\bullet, z) : F^c \rightarrow F^o[[z^{\mathbb{R}}]]$ be a linear map. Then, $Y^b(\bullet, z)$ satisfies Definition 3.22 if and only if the associated map τ_y in (3.16) satisfies the following conditions:*

$$(1) \text{ For any } v \in F^c, \frac{d}{dy} \tau_y(v) = i\tau_y((L^l(-1) - L^r(-1))v)$$

(2) For any $a \in V$, $v \in F^c$ and $n \in \mathbb{Z}$, $m \in \mathbb{Z}_{\geq 0}$

$$\begin{aligned} a^o(m)\tau_y(v) &= \sum_{k \geq 0} \binom{m}{k} \tau_y(a^l(k)(iy)^{m-k} + a^r(k)(-iy)^{m-k}v) \\ \tau_y(a^l(n)v) &= \sum_{k \geq 0} \binom{n}{k} (a^o(n-k)\tau_y(a)(-iy)^{n-k} - \tau_y(a^r(k)a)(-2iy)^{n-k}) \\ \tau_y(a^r(n)v) &= \sum_{k \geq 0} \binom{n}{k} (a^o(n-k)\tau_y(v)(+iy)^{n-k} - \tau_y(a^l(k)v)(+2iy)^{n-k}). \end{aligned}$$

Proof. Let $Y^b(\bullet, z) : F^c \rightarrow F^o[[z^{\mathbb{R}}]]$ be a bulk-boundary vertex operator on (F^c, F^o) with the chiral symmetry V . By (BBC1) and (BBC2), we have

$$\begin{aligned} \frac{d}{dy}\tau_y(v) &= \frac{d}{dy} \exp(-iyL(-1)^o)Y^b(v, 2iy) \\ &= -i \exp(-iyL(-1)^o)L(-1)^oY^b(v, 2iy) + \exp(-iyL(-1)^o)\frac{d}{dy}Y^b(v, 2iy) \\ &= -i \exp(-iyL(-1)^o)Y^b((L(-1)^l + L(-1)^r)v, 2iy) + \exp(-iyL(-1)^o)2iY^b(L(-1)^l v, 2iy) \\ &= i \exp(-iyL(-1)^o)Y^b((L(-1)^l - L(-1)^r)v, 2iy) \\ &= i\tau_y((L(-1)^l - L(-1)^r)v). \end{aligned}$$

Recall that

$$(3.17) \quad \exp(L(-1)z)a^o(n)\exp(-L(-1)z) = \sum_{k \geq 0} \binom{n}{k} a^o(k)(-z)^{n-k}$$

$$(3.18) \quad \exp(L(-1)z)a^o(-n-1)\exp(-L(-1)z) = \sum_{k \geq 0} \binom{k}{n} a^o(-k-1)z^{k-n},$$

for any $a \in V$ and $n \geq 0$ [Mo5, Lemma 1.11]. Hence, for $a \in V$ and $n \geq 0$, by (BBC2) and (3.17), we have

$$\begin{aligned} \tau_y(a^l(n)v) &= \exp(-iyL(-1)^o)Y^b(a^l(n)v, 2iy) \\ &= \exp(-iyL(-1)^o) \sum_{k \geq 0} \binom{n}{k} (a^o(n-k)Y^b(v, 2iy)(-2iy)^k - Y(a^r(k)v, 2iy)(-2iy)^{n-k}) \\ &= \exp(-iyL(-1)^o) \sum_{k \geq 0} \binom{n}{k} (a^o(n-k)Y^b(v, 2iy)(-2iy)^k - Y(a^r(k)v, 2iy)(-2iy)^{n-k}) \\ &= \exp(iyL^o(-1))a^o(n)\exp(-2iyL^o(-1))Y^b(v, 2iy) - \sum_{k \geq 0} \binom{n}{k} \tau_y(a^r(k)v)(-2iy)^{n-k} \\ &= \sum_{k \geq 0} \binom{n}{k} a^o(k)\tau_y(v)(-iy)^{n-k} - \tau_y(a^r(k)v)(-2iy)^{n-k}. \end{aligned}$$

Similarly, by (3.18) and $\binom{k+n}{n} = (-1)^k \binom{-n-1}{k}$, we have

$$\begin{aligned}
& \tau_y(a^l(-n-1)v) \\
&= \exp(-iyL(-1)^o)Y^b(a^l(-n-1)v, 2iy) \\
&= \exp(-iyL(-1)^o) \sum_{k \geq 0} \binom{-n-1}{k} \left(a^o(-n-1-k)Y^b(v, 2iy)(-2iy)^k - Y(a^r(k)v, 2iy)(-2iy)^{-n-1-k} \right) \\
&= \exp(iyL(-1)^o)a^o(-n-1) \exp(-2iyL^o(-1))Y^b(v, 2iy) \\
&\quad - \sum_{k \geq 0} \binom{-n-1}{k} \exp(-iyL(-1)^o)Y(a^r(k)v, 2iy)(-2iy)^{-n-1-k} \\
&= \sum_{k \geq 0} \binom{-n-1}{k} \left(a^o(-n-1-k)\tau_y(v)(-iy)^k - \tau_y(a^r(k)v)(-2iy)^{-n-1-k} \right).
\end{aligned}$$

Hence, we have the second equality in (2). The last equality follows similarly. Finally, for any $m \geq 0$, we have

$$\begin{aligned}
a^o(m)\tau_y(v) &= a^o(m) \exp(-iyL(-1)^o)Y^b(v, 2iy) \\
&= \exp(-iyL(-1)^o) \sum_{k \geq 0} \binom{m}{k} a^o(k)(-iy)^{m-k} Y^b(v, 2iy) \\
&= \exp(-iyL(-1)^o) \sum_{k \geq 0} \binom{m}{k} (-iy)^{m-k} \left(Y^b(a^r(k)v, 2iy) + \sum_{l \geq 0} \binom{k}{l} Y^b(a^l(l)v, 2iy)(2iy)^{k-l} \right).
\end{aligned}$$

Since for formal variable x, y

$$\sum_{k, l \geq 0} \binom{m}{k} \binom{k}{l} x^{m-k} y^{k-l} = (1+x+y)^m,$$

we have

$$\begin{aligned}
& \sum_{k \geq 0} \sum_{l \geq 0} \binom{m}{k} \binom{k}{l} Y^b(a^l(l)v, 2iy)(-iy)^{m-k} (2iy)^{k-l} \\
&= \sum_{l \geq 0} \binom{m}{l} Y^b(a^l(l)v, 2iy)(iy)^{m-l}.
\end{aligned}$$

Hence, $a^o(m)\tau_y(v) = \sum_{k \geq 0} \binom{m}{k} \tau_y(a^l(k)(iy)^{m-k} + a^r(k)(-iy)^{m-k}v)$. The same can be equally verified for the opposite direction. \square

Remark 3.24. *The above recursive relation is nothing but the defining formula of conformal block (1.14) when the chiral module is inserted at the point iy in the upper half-plane and the anti-chiral is at $-iy$ in the lower half-plane.*

Let $u \in (F^o)^*$, $a \in F^c$ and $b \in F^o$. We will consider a correlation function with a inserted at a point $z_1 \in \mathbb{H}$ and b inserted at a point $z_2 \in \mathbb{R}$ (see Fig 21 and 22).

This correlation function is a single-valued real analytic function on $(z_1, z_2) \in \mathbb{H} \times \mathbb{R}$. Roughly speaking, the expansion of this correlation function in the domain $\{(z_1, z_2) \in$

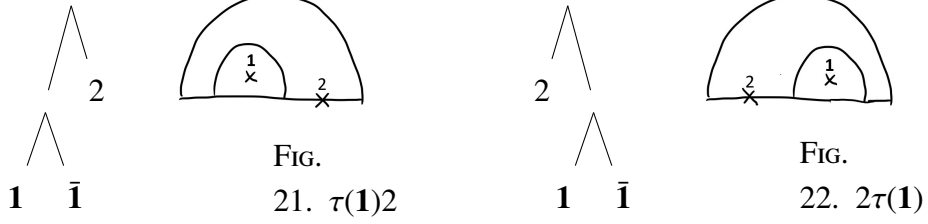

$\mathbb{H} \times \mathbb{R} \mid \operatorname{Re} z_1 > z_2 \text{ and } |z_1 - \bar{z}_1| < |\bar{z}_1 - z_2|$ (Fig 21) is given by

$$(3.19) \quad \langle u, \exp(z_2 L^o(-1)) Y^o(Y^b(a, z_{1\bar{1}}), z_{\bar{1}2}) b \rangle \in \mathbb{C} \left(\left(\frac{z_{1\bar{1}}}{z_{\bar{1}2}} \right)^{\mathbb{R}} \right) [z_2, z_{\bar{1}2}^{\mathbb{R}}],$$

and in the domain $\{(z_1, z_2) \in \mathbb{H} \times \mathbb{R} \mid z_2 > \operatorname{Re} z_1 \text{ and } |z_1 - \bar{z}_1| < |\bar{z}_1 - z_2|\}$ (Fig 22) is

$$(3.20) \quad \langle u, \exp(\bar{z}_1 L^o(-1)) Y^o(b, z_{2\bar{1}}) Y^b(a, z_{1\bar{1}}) \rangle \in \mathbb{C} \left(\left(\frac{z_{1\bar{1}}}{z_{2\bar{1}}} \right)^{\mathbb{R}} \right) [\bar{z}_1, z_{2\bar{1}}^{\mathbb{R}}].$$

In order to consider them as analytic functions, the branch of $z^r = \exp(r \operatorname{Log} z)$ must be determined. Recall that the branch of

$$\operatorname{Log} : \mathbb{C}^{\text{cut}} = \mathbb{C} \setminus \mathbb{R}_- \rightarrow \mathbb{C}$$

is taken so that $-\pi < \operatorname{Arg}(z) < \pi$.

(3.19) and (3.20) are just formal series. We assume that they converge absolutely in $|z_{1\bar{1}}| < |z_{\bar{1}2}|$. Then, we obtain holomorphic functions on $U_{\tau(1)2}, U_{2\tau(1)} \subset X_3(\mathbb{C})$, respectively. Following (2.9), we substitute the complex number $z_1 - z_{\bar{1}}$ to the variable $z_{1\bar{1}}$ and think of the vertex operator $Y^b(\bullet, z_{1\bar{1}})$ as follows:

$$(3.21) \quad Y^b(a, z_{1\bar{1}}) = \sum_{r \in \mathbb{R}} B_r(b) \exp(-(r+1) \operatorname{Log}(z_1 - \bar{z}_1))$$

$$(3.22) \quad = \sum_{r \in \mathbb{R}} B_r(b) (2 \operatorname{Im} z_1)^{-r-1} \exp\left(-\frac{(r+1)\pi i}{2}\right)$$

and similar to $Y^o(\bullet, z_{\bar{1}2})$, which uniquely determine the branches of (3.19) and (3.20). Hence, we obtain real analytic functions on $U_{\tau(1)2}^o, U_{2\tau(1)}^o \subset X_{1,1}(\overline{\mathbb{H}})$.

Note that when taking the product of the boundary states, it is possible to get into the region $\mathbb{R}_- \subset \mathbb{C}$ which we cut for taking the branch, but this does not happen because we are taking the product and variables in the correct order when we expand the correlation function with respect to trees.

To state the definition of boundary bootstrap equation, we need to consider one more correlation function.

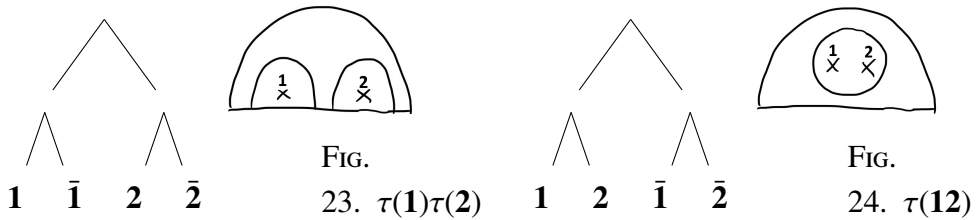

Let $u \in (F^o)^*$, $a_1, a_2 \in F^c$. Fig 23 corresponds to the domain $\left| \frac{z_{1\bar{1}}}{z_{1\bar{2}}} \right| + \left| \frac{z_{2\bar{2}}}{z_{1\bar{2}}} \right| < 1$ and $\text{Re } z_1 > \text{Re } z_2$, and the expansion is

$$(3.23) \quad \langle u, \exp(\bar{z}_2 L^o(-1)) Y^o(Y^b(a_1, z_{1\bar{1}}), z_{1\bar{2}}) Y^b(a_2, z_{2\bar{2}})) \rangle \in \mathbb{C} \left(\left(\left(\frac{z_{1\bar{1}}}{z_{1\bar{2}}} \right)^{\mathbb{R}}, \left(\frac{z_{2\bar{2}}}{z_{1\bar{2}}} \right)^{\mathbb{R}} \right) \right) [\bar{z}_2, z_{1\bar{2}}^{\mathbb{R}}],$$

and Fig 24 corresponds to the domain $\left| \frac{z_{1\bar{2}}}{z_{2\bar{2}}} \right| + \left| \frac{\bar{z}_{1\bar{2}}}{z_{2\bar{2}}} \right| < 1$ and $\text{Re } z_1 > \text{Re } z_2$, and the expansion is

$$(3.24) \quad \langle u, \exp(\bar{z}_2 L^o(-1)) Y^b(Y^c(a_1, z_{1\bar{2}}, \bar{z}_{1\bar{2}}) a_2, z_{2\bar{2}})) \rangle \in \mathbb{C} \left(\left(\left(\frac{z_{1\bar{2}}}{z_{2\bar{2}}} \right)^{\mathbb{R}}, \left(\frac{\bar{z}_{1\bar{2}}}{z_{2\bar{2}}} \right)^{\mathbb{R}} \right) \right) [\bar{z}_2, z_{2\bar{2}}^{\mathbb{R}}].$$

We assume that (3.23) converges absolutely in $\left| \frac{z_{1\bar{1}}}{z_{1\bar{2}}} \right| + \left| \frac{z_{2\bar{2}}}{z_{1\bar{2}}} \right| < 1$ and (3.24) converges absolutely in $\left| \frac{z_{1\bar{2}}}{z_{2\bar{2}}} \right| + \left| \frac{\bar{z}_{1\bar{2}}}{z_{2\bar{2}}} \right| < 1$. Thus, we obtain holomorphic functions on $U_{\tau(1)\tau(2)}, U_{\tau(12)} \subset X_4(\mathbb{C})$, respectively. By the restriction (2.9), we also obtain real analytic functions on $U_{\tau(1)\tau(2)}^o, U_{\tau(12)}^o \subset X_{2,0}(\overline{\mathbb{H}})$. By Fig 23 and 24, it is clear that $U_{\tau(1)\tau(2)}^o \cap U_{\tau(12)}^o \neq \emptyset$.

The following assumption is called a (*boundary*) *bootstrap equation* in physics (see also [Ko1, Theorem 1.28] and Remark 3.23):

Definition 3.25. We say that the bulk-boundary vertex operator $Y^b(\bullet, z)$ on (F^c, F^o) with the chiral symmetry V satisfies the bootstrap equation when it satisfies the following conditions:

BB1) $Y^b(\mathbf{1}^c, z) = \mathbf{1}^o$.

BB2) For any $u \in (F^o)^*$, $a_1, a_2 \in F^c$, (3.23) converges absolutely in $\left| \frac{z_{1\bar{1}}}{z_{1\bar{2}}} \right| + \left| \frac{z_{2\bar{2}}}{z_{1\bar{2}}} \right| < 1$ and (3.24) converges absolutely in $\left| \frac{z_{1\bar{2}}}{z_{2\bar{2}}} \right| + \left| \frac{\bar{z}_{1\bar{2}}}{z_{2\bar{2}}} \right| < 1$, and thus, define holomorphic functions on $U_{\tau(1)\tau(2)}, U_{\tau(12)} \subset X_4(\mathbb{C})$, respectively. Moreover, there is a single valued real analytic function $C_{2,0}(u, a_1, a_2)$ on $X_{2,0}(\overline{\mathbb{H}})$ such that the restriction of $C_{2,0}(u, a_1, a_2)$ on $U_{\tau(1)\tau(2)}^o \subset X_{2,0}(\overline{\mathbb{H}})$ (resp. $U_{\tau(12)}^o \subset X_{2,0}(\overline{\mathbb{H}})$) coincides with (3.23) (resp. (3.24)) for the branch specified above.

BB3) For any $u \in (F^o)^*$, $a \in F^c$ and $b \in F^o$, (3.19) and (3.20) converge absolutely in $|z_{1\bar{1}}| < |z_{1\bar{2}}|$, and thus, define holomorphic functions on $U_{\tau(1)2}, U_{2\tau(1)} \subset X_3(\mathbb{C})$, respectively. Moreover, there is a single valued real analytic function $C_{1,1}(u, a, b)$ on $X_{1,1}(\overline{\mathbb{H}})$ such that the restriction of $C_{1,1}(u, a, b)$ on $U_{\tau(1)2}^o \subset X_{1,1}(\overline{\mathbb{H}})$ (resp. $U_{2\tau(1)}^o \subset X_{1,1}(\overline{\mathbb{H}})$) coincides with (3.19) (resp. (3.20)).

Remark 3.26. (BB2) corresponds to Associativity II in [Ko1, (1.56)], and (BB3) corresponds to Commutativity I in [Ko1, Proposition 1.18]. Associativity I in [Ko1, (1.52)] follows from (BB2) and (BB3) under the assumption that the chiral symmetry is locally C_1 cofinite, as we will see below.

Remark 3.27. It is important to note that condition (BB3) does not necessarily mean that the image of $Y^b(\bullet, z)$ in F^o is commutative. The state of the image is commutative only when it goes around the upper half-plane, otherwise it would not be interchangeable. In a categorical-theoretic setting, this corresponds to considering the left / full center instead

of the usual center of the algebra in the modular tensor category (see [FFRS, KR]). We can also see it explicitly in our next paper, which constructs the bulk-boundary operator of the Narain CFTs [Mo6].

Let (F^o, F^c) possesses a V -chiral symmetry. Let M, \bar{M} be V -modules and $M \otimes \bar{M} \hookrightarrow F^c$ a $V \otimes V$ -module homomorphism. Then, it is clear that the restriction of $Y^b(\bullet, z)$ on $M \otimes \bar{M}$ is an intertwining operator of type $\begin{pmatrix} F^o \\ M\bar{M} \end{pmatrix}$.

Definition 3.28. We call a bulk-boundary vertex operator on (F^c, F^o) with the chiral symmetry V is locally C_1 -cofinite if both $(F^c, Y^c, \mathbf{1}^c)$ and $(F^o, Y^o, \mathbf{1}^o)$ are locally C_1 -cofinite over V (Definition 3.6 and 3.19) such that:

bbLC) For each $i \in I_c$ in (3.6), there is a finite subset $B(i) \subset I_o$ such that:

$$Y^b(m_i \otimes \bar{m}_i, z) \in \bigoplus_{j \in B(i)} N_j((z^{\mathbb{R}}))$$

with I_o and N_j in (3.19).

Let $(F^o, F^c, Y^o, Y^c, Y^b)$ be a bulk-boundary operator which is C_1 -cofinite over V and satisfies the boundary bootstrap equation (Definition 3.25). We will explain how to assign the iterated vertex operators Y_E for a tree $E \in \mathcal{T}^o(r, s)$. Let $a_{[r,s]} \in (F^c)^{\otimes r} \otimes (F^o)^{\otimes s}$. As an example, we will consider the case where the tree is Fig 25:

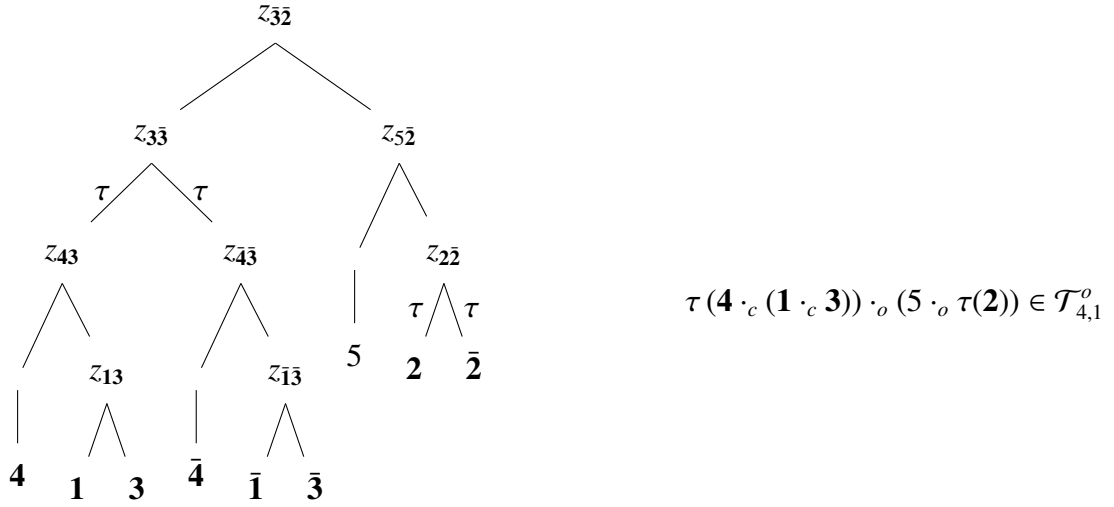

FIG. 25

We may assume that $a_i = a_i \otimes \bar{a}_i \in F^c$, where $a_i \otimes \bar{a}_i$ is taken from a direct summand of (LC2). By assumption, we can locally decompose $Y^c = Y^l \otimes Y^r$ by (LC3), and we can denote $Y^b(a \otimes \bar{a}, z)$ by $Y^b(a, z)\bar{a}$. Then, for any $u \in (F^o)^\vee$,

(3.25)

$$\langle u, e^{L_o(-1)\bar{z}_2} Y^o \left(Y^b \left(Y^c(a_4 \otimes \bar{a}_4, z_{43}) Y^c(a_1 \otimes \bar{a}_1, z_{13}) a_3 \otimes \bar{a}_3, z_{33} \right), z_{32} \right) Y^o(a_5, z_{52}) Y^b(a_2 \otimes \bar{a}_2, z_{22}) \rangle$$

(3.26)

$$= \langle u, e^{L_o(-1)\bar{z}_2} Y^o \left(Y^b \left(Y^l(a_4, z_{43}) Y^l(a_1, z_{13}) a_3, z_{33} \right) Y^r(\bar{a}_4, z_{43}) Y^r(\bar{a}_1, z_{13}) \bar{a}_3, z_{32} \right)$$

$$Y^o(a_5, z_{52}) Y^b(a_2, z_{22}) \bar{a}_2 \rangle.$$

The right-hand-side (3.26) is a formal power series in $T_{\bar{E}}$ and is absolutely convergent to a holomorphic function in $U_{\bar{E}}$ by the assumption of local C_1 -cofiniteness. Then, the restriction of (3.26) onto

$$U_E^o = \Phi^{-1}(\bar{U}_{\bar{E}}) \cap X_{r,s}(\bar{\mathbb{H}})$$

is a well-defined real analytic function. Denote the compositions of vertex operators (3.25) by Y_E , which in itself makes sense even if the vertex operator is not locally C_1 cofinite and does not decompose into chiral / anti-chiral parts by (3.25).

Definition 3.29. Let $(F^c, F^o, Y^c, Y^o, Y^b, \mathbf{1}^c, \mathbf{1}^o)$ be in Definition 3.25 with a chiral symmetry V . We call it consistent if the following properties are satisfied:

Convergence: For any $u \in (F^o)^\vee$ and $a_{[r,s]} \in (F^c)^{\otimes r} \otimes (F^o)^{\otimes s}$ and $E \in \mathcal{T}^o(r, s)$,

$$\langle u, \exp(L^o(-1)z_E)Y_E(a_{[r,s]}; z_{[r,s]}) \rangle,$$

is absolutely locally uniformly convergent to a holomorphic function on $U_{\bar{E}} \subset X_{2r+s}(\mathbb{C})$. Denote the restriction of this analytic function on U_E^o by $C_E(u, a_{[r,s]}; z_{[r,s]})$.

Compatibility: There exists a family of linear maps

$$C_r^c : (F_c)^\vee \otimes (F_c)^{\otimes r} \rightarrow C^\omega(X_r(\mathbb{C}))$$

and

$$C_{r,s}^o : (F_o)^\vee \otimes (F_c)^{\otimes r} \otimes (F_o)^{\otimes s} \rightarrow C^\omega(X_{r,s}(\bar{\mathbb{H}}))$$

such that:

$$C_r^c(u, a_{[r]}; z_{[r]}) \Big|_{U_A^c} = C_A(u, a_{[r]}; z_{[r]})$$

and

$$(3.27) \quad C_{r,s}^o(u, a_{[r,s]}; z_{[r,s]}) \Big|_{U_E^o} = C_E(u, a_{[r,s]}; z_{[r,s]})$$

for any $A \in \mathcal{T}^c(r)$ and $E \in \mathcal{T}^o(r, s)$ as real analytic functions.

Theorem 3.30. Let $(F^c, F^o, Y^c, Y^o, Y^b, \mathbf{1}^c, \mathbf{1}^o)$ be in Definition 3.25 which is locally C_1 -cofinite over a positive graded vertex operator algebra. Then, it is consistent.

Proof. By Theorem 2.2, similarly to the proof of Theorem 3.9, it suffices to show that (Compatibility) holds on the generator of PaPB as a 2-colored operad.

In the proof of Theorem 4.2 in [Id], it was shown that PaPB is generated by the following five paths as a 2-colored operad:

$$\alpha_o : (1 \cdot_o 2) \cdot_o 3 \rightarrow 1 \cdot_o (2 \cdot_c 3)$$

$$\alpha_c : (\mathbf{1} \cdot_c \mathbf{2}) \cdot_c \mathbf{3} \rightarrow \mathbf{1} \cdot_c (\mathbf{2} \cdot_c \mathbf{3})$$

$$\sigma : \mathbf{1} \cdot_c \mathbf{2} \rightarrow \mathbf{2} \cdot_c \mathbf{1}$$

$$p : \tau(\mathbf{1}) \cdot_o 2 \rightarrow 2 \cdot_o \tau(\mathbf{1})$$

$$q : \tau(\mathbf{1} \cdot_c \mathbf{2}) \rightarrow \tau(\mathbf{1}) \cdot_o \tau(\mathbf{2}),$$



FIG.
26. Path
 α_o



FIG.
27. Path α_c



FIG.
28. Path σ



FIG.
29. Path p



FIG.
30. Path q

which are given in Fig 26 - 30. By the bootstrap equations, the vertex operators (Y^c, Y^o, Y^b) are invariant with respect to the analytic continuation along these paths. Hence, by Theorem 2.2, the assertion holds. \square

APPENDIX A.

Exactly marginal deformations of rational conformal field theories are generally not rational at all. However, in Appendix, we will show that the current-current deformations of rational (bulk) conformal field theories always satisfy the local C_1 -cofiniteness condition, and thus, are consistent.

We call a full VOA F *strongly rational* if $\ker \bar{L}(-1)$ and $\ker L(-1)$ are simple self-dual rational C_2 -cofinite VOAs. Assume in this section that F is a strongly rational full VOA. Then, by [DM], the degree one subspaces of $\ker \bar{L}(-1)$ and $\ker L(-1)$ are reductive Lie algebras. Let

$$H_l \subset \ker \bar{L}(-1) \text{ and } H_r \subset \ker L(-1)$$

be Cartan subalgebras and set $n_l = \dim H_l$ and $n_r = \dim H_r$, the ranks of the Lie algebras. We think H_l (resp. H_r) inherits a bilinear form $(-, -)$ by $h(1, -)h' = (h, h')\mathbf{1}$ (resp. $h(-1, 1)h' = (h, h')\mathbf{1}$).

Then, in [Mo1], we construct a deformation family of a full vertex operator algebra parametrized by a quotient of the orthogonal Grassmannian:

$$(A.1) \quad D_F \backslash O(n_l, n_r; \mathbb{R}) / O(n_l; \mathbb{R}) \times O(n_r; \mathbb{R}),$$

where $O(n_l, n_r; \mathbb{R})$ is the real orthogonal group with signature (n_l, n_r) . The subgroup $D_F \subset O(n_L, n_R; \mathbb{R})$ is defined in [Mo1] as an automorphism group of a generalized full VOA, which corresponds to the T-duality of string theory in the case of Narain CFTs [Ploc1]. In this section, we will briefly review this result and show that they are locally C_1 -cofinite while at a general point in (A.1), the full VOA is not a rational CFT, i.e., $\ker \bar{L}(-1)$ and $\ker L(-1)$ are not rational VOAs.

Recall that for a VOA V and a subset $S \subset V$, set

$$\text{Com}_V(S) = \{a \in V \mid s(n)a = 0 \text{ for any } s \in S, n \geq 0\},$$

which is called a *commutant* vertex algebra.

Let $M_{n_l}(0)$ and $M_{n_r}(0)$ be the subVOAs of $\ker \bar{L}(-1)$ and $\ker L(-1)$ generated by the Cartan subalgebras. Set

$$(A.2) \quad W = \text{Com}_{\ker \bar{L}(-1)}(M_{n_l}(0)), \quad W' = \text{Com}_{\ker \bar{L}(-1)}(W)$$

$$(A.3) \quad \bar{W} = \text{Com}_{\ker L(-1)}(M_{n_r}(0)), \quad \bar{W}' = \text{Com}_{\ker L(-1)}(\bar{W}).$$

Then, combining theorems on the structure of strongly rational vertex operator algebras [Mas, Theorem 1] and results from representation theory [CKLR, CKM], the following proposition is obtained in [HM]:

Proposition A.1 (Proposition 4.3 in [HM] and Theorem 1 in [Mas]). *Suppose F is strongly rational full VOA. Then, the following properties are hold:*

- (1) *There are positive-definite even lattices L_l of rank n_l (resp. L_r of rank n_r) such that $W' \cong V_{L_l}$ and $\bar{W}' \cong V_{L_r}$ as VOAs.*
- (2) *W and \bar{W} are also strongly rational and $\ker \bar{L}(-1)$ and $\ker L(-1)$ are simple-current extensions of the strongly rational VOAs $W \otimes V_{L_l}$ and $\bar{W} \otimes V_{L_r}$:*

$$\ker \bar{L}(-1) = \bigoplus_{\alpha \in A_l} W^\alpha \otimes V_{\alpha+L_l}$$

$$\ker L(-1) = \bigoplus_{\beta \in A_r} \bar{W}^\beta \otimes \overline{V_{\beta+L_r}},$$

for some subgroup $A_l \subset L_l^\vee/L_l$ and $A_r \subset L_r^\vee/L_r$.

For $\gamma \in H_l \oplus H_r$, set

$$\Omega_F^\gamma = \{v \in F \mid h_l(n, -1)v = 0, h_r(-1, n)v = 0,$$

$$h_l(0, -1)v = (h_l, \gamma)v, h_r(-1, 0)v = (h_r, \gamma)v \text{ for any } h_l \in H_l, h_r \in H_r, n \geq 1\},$$

the lowest weight space of the affine Heisenberg Lie algebra. Then, by [Mo1, Theorem 5.3], $\Omega_F = \bigoplus_{\gamma \in H_l \oplus H_r} \Omega^\gamma$ inherits a structure of a generalized full VOA, Let $D_F \subset O(H_l \oplus -H_r) \cong O(n_l, n_r; \mathbb{R})$ denote the automorphism group of the generalized full VOA Ω , where $O(n_l, n_r; \mathbb{R})$. Then, we construct a family of full VOAs that continuously deforms the eigenvalues γ (called charges) parametrized by (A.1) (for more precise statement, see [Mo1, Section 6.2]). This family is called a *current-current deformation* of conformal field theory in physics.

Theorem A.2. *Let F be a strongly rational full VOA. Then, at any point in the current-current deformations of F parametrized by*

$$D_F \backslash \mathcal{O}(n_l, n_r; \mathbb{R}) / \mathcal{O}(n_l; \mathbb{R}) \times \mathcal{O}(n_r; \mathbb{R}),$$

the full VOA is locally C_1 -cofinite. In particular, it is consistent.

Proof. Let $\tau \in D_F \backslash \mathcal{O}(n_l, n_r; \mathbb{R}) / \mathcal{O}(n_l; \mathbb{R}) \times \mathcal{O}(n_r; \mathbb{R})$ and F_τ be the corresponding full VOA. In general, $\ker \bar{L}(-1)|_{F_\tau}$ and $\ker L(-1)|_{F_\tau}$ are no longer strongly rational VOA, however, they always contain subVOAs

$$\begin{aligned} V &= M_{n_l}(0) \otimes W \subset \ker \bar{L}(-1)|_{F_\tau} \\ \bar{V} &= \overline{M_{n_r}(0)} \otimes \bar{W} \subset \ker L(-1)|_{F_\tau}. \end{aligned}$$

By construction, F_τ is the direct sum of the C_1 -cofinite modules of $V \otimes \bar{V}$ since W and \bar{W} are strongly rational by Proposition A.1. Since the deformation modifies the intertwining operators of Heisenberg VOAs, (LC3) holds. \square

REFERENCES

- [ABD] T. Abe, G. Buhl and C. Dong, Rationality, regularity, and C_2 -cofiniteness, *Trans. Amer. Math. Soc.*, **356**, 2004, (8).
- [AMT] M.S. Adamo, Y. Moriwaki and Y. Tanimoto, Osterwalder-Schrader axioms for unitary full vertex operator algebras, arXiv:2407.18222.
- [BD] J. Baez and J. Dolan, Higher dimensional algebra and Topological Quantum Field Theory *J. Math. Phys.* **36** (1995).
- [Bar] D. Bar-Natan, On associators and the Grothendieck-Teichmuller group. I, *Selecta Math. (N.S.)*, **4**, 1998, (2), 183–212.
- [Bo] R.E. Borcherds, Vertex algebras, Kac-Moody algebras, and the Monster, *Proc. Nat. Acad. Sci. U.S.A.*, **83**, 1986, (10), 3068–3071.
- [BPZ] A. A. Belavin, A. M. Polyakov, A. B. Zamolodchikov, Infinite conformal symmetry in two-dimensional quantum field theory, *Nuclear Phys. B*, **241**, 1984, (2), 333–380.
- [CIZ] A. Cappelli, C. Itzykson and J.B. Zuber, Modular invariant partition functions in two dimensions, *Nucl. Phys. B*, **280**, (445), 1987.
- [CKLR] T. Creutzig, S. Kanade, A.R. Linshaw and D. Ridout, Schur-Weyl duality for Heisenberg cosets. *Transform. Groups*, **24** (2) 2019, 301–354.
- [CKM] T. Creutzig, S. Kanade and R. McRae. Gluing vertex algebras, *Adv. Math.*, 396:108174, 2022.
- [DM] C. Dong and G. Mason, Rational vertex operator algebras and the effective central charge. *Int. Math. Res. Not.*, (56), 2004, 2989–3008.
- [EPPRSV] S. El-Showk, M.F. Paulos, D. Poland, S. Rychkov, D. Simmons-Duffin and A. Vichi, Solving the 3d Ising model with the conformal bootstrap II. c -minimization and precise critical exponents, *J. Stat. Phys.*, **157**, 2014, (4)-(5), 869–914.
- [Fr] B. Fresse, Homotopy of operads and Grothendieck-Teichmuller groups. Part 1, *Mathematical Surveys and Monographs*, 217, American Mathematical Society, Providence, RI, 2017.
- [FB] E. Frenkel and D. Ben-Zvi, Vertex algebras and algebraic curves, *Mathematical Surveys and Monographs*, **88**, Second, American Mathematical Society, Providence, RI, 2004.
- [FFFS] G. Felder, J. Fröhlich, J. Fuchs and C. Schweigert, Correlation functions and boundary conditions in rational conformal field theory and three-dimensional topology, *Compositio Math.* **131**, 2002, 189–237.

- [FFRS] J. Fjelstad, J. Fuchs, I. Runkel and C. Schweigert, Uniqueness of open/closed rational CFT with given algebra of open states, *Adv. Theor. Math. Phys.* **12** (2008) 1283–1375.
- [FLM] I. Frenkel, J. Lepowsky, and A. Meurman, *Vertex operator algebras and the Monster*, Pure and Applied Mathematics, **134**, Academic Press, Inc., Boston, MA, 1988.
- [FHL] I. Frenkel, Y. Huang and J. Lepowsky, On axiomatic approaches to vertex operator algebras and modules, *Mem. Amer. Math. Soc.*, **104**, 1993, (494).
- [FMS] P. Di Francesco, P. Mathieu and D. Sénéchal, *Conformal field theory*, Graduate Texts in Contemporary Physics, Springer-Verlag, New York, 1997.
- [FRS] J. Fuchs, I. Runkel and C. Schweigert, Conformal correlation functions, Frobenius algebras and triangulations, *Nucl. Phys.* **624** 2002, 452–468.
- [Go] P. Goddard, Meromorphic conformal field theory, Infinite-dimensional Lie algebras and groups (Luminy-Marseille, 1988), *Adv. Ser. Math. Phys.*, **7**, 556–587, 1989.
- [GKSW] D. Gaiotto, A. Kapustin, N. Seiberg, and B. Willett, Generalized Global Symmetries, *JHEP* **02**, 172.
- [Hu1] Y.-Z. Huang, Differential equations and intertwining operators, *Commun. Contemp. Math.*, **7**, 2005, (3), 375–400.
- [Hu2] Y.-Z. Huang, Two-dimensional conformal geometry and vertex operator algebras, *Progress in Mathematics*, **148**, Birkhauser Boston, Inc., Boston, MA, 1997, xiv+280.
- [HK1] Y.-Z. Huang, L. Kong, Full field algebras, *Comm. Math. Phys.*, **272**, 2007, (2), 345–396.
- [HK2] Y.-Z. Huang, L. Kong, Open-string vertex algebra, category and operad. *Commun. Math. Phys.*, **250**, 2004, 433–471.
- [HL] Y.Z. Huang and J. Lepowsky, Tensor products of modules for a vertex operator algebra and vertex tensor categories, *Progr. Math.*, **123**, 349–383.
- [HM] G. Höhn, S. Möller, Classification of Self-Dual Vertex Operator Superalgebras of Central Charge at Most 24, arXiv:2303.17190 [math.QA].
- [Id] N. Idrissi, Swiss-cheese operad and Drinfeld center, *Israel J. Math.*, **221**, 2017, (2), 941–972.
- [Ka] A. Kato, Classification of modular invariant partition functions in two dimensions, *Modern Physics Letters A*, **02**, (08), 1987, 585-600.
- [Ko1] L. Kong, Open-closed field algebras, *Comm. Math. Phys.*, **280**, 2008, (1), 207–261.
- [Ko2] L. Kong, Cardy condition for open-closed field algebras, *Comm. Math. Phys.*, **283**, 2008, 25–92.
- [Kont] M. Kontsevich, Homological algebra of mirror symmetry, alg-geom/9411018.
- [KO] A. Kapustin and D. Orlov, Vertex algebras, mirror symmetry, and D-branes: The case of complex tori, *Commun. Math. Phys.* **233**, 2003, 79–136.
- [KQR] P. Kravchuk, J. Qiao, and S. Rychkov. Distributions in CFT. Part II. Minkowski space. *J. High Energy Phys.*, **8**, 094, (129), 2021.
- [KR] L. Kong and I. Runkel, Cardy Algebras and Sewing Constraints, I. *Commun. Math. Phys.* **292**, (2009) 871–912.
- [KS1] H. Kajiura and J. Stasheff, Homotopy algebras inspired by classical open-closed string field theory, *Comm. Math. Phys.*, **263**, 2006, (3), 553–581.
- [KS2] H. Kajiura and J. Stasheff, Open-closed homotopy algebra in mathematical physics, *J. Math. Phys.*, **47**, 2006, (2).
- [La] J. Lambek, *Deductive systems and categories. II. Standard constructions and closed categories*, *Category Theory, Homology Theory and their Applications, I* (Battelle Institute Conference, Seattle, Wash., 1968, Vol. One), *Lecture Notes in Math.*, **86**, 1969, 76–122.
- [Le] D.C. Lewellen, Sewing constraints for conformal field theories on surfaces with boundaries, *Nucl. Phys. B*, **372** (1992) 654–682.

- [Li2] H. Li,, Local systems of vertex operators, vertex superalgebras and modules, *J. Pure Appl. Algebra*, **109**, 1996, (2), 143–195.
- [Lu] J. Lurie, On the Classification of Topological Field Theories, *Current Developments in Mathematics*, **2008**, 2009 129–280.
- [LL] J. Lepowsky and H. Li, Introduction to vertex operator algebras and their representations, *Progress in Mathematics*, **227**, Birkhäuser Boston, Inc., Boston, MA, 2004.
- [Mac] S. MacLane, Categories for the working mathematician, *Graduate Texts in Mathematics*, Vol. 5, Springer-Verlag, New York-Berlin, 1971, ix+262.
- [Mas] G. Mason, Lattice subalgebras of strongly regular vertex operator algebras, *Conformal Field Theory, Automorphic Forms and Related Topics*, Springer, 2014, 31–53.
- [Mi1] A. Milas, Weak modules and logarithmic intertwining operators for vertex operator algebras, *Contemp. Math.*, 297, 201–225.
- [Mi2] A. Milas, Logarithmic intertwining operators and vertex operators, *Comm. Math. Phys.*, 277, 2008, (2), 497–529.
- [Moore] G. Moore, K theory from a physical perspective, *Symposium on Topology, Geometry and Quantum Field Theory, RUNHETC-2003-02*, 2003, 194–234.
- [Mo1] Y. Moriwaki, Two-dimensional conformal field theory, full vertex algebra and current-current deformation, *Adv. Math*, 427, (2023).
- [Mo2] Y. Moriwaki, Full vertex algebra and bootstrap – consistency of four point functions in 2d CFT, arXiv:2006.15859 [math.QA].
- [Mo3] Y. Moriwaki, Quantum coordinate ring in WZW model and affine vertex algebra extensions, *Selecta Math. (N.S.)*, **28**, 2022, (4), Paper No. 68, 49.
- [Mo4] Y. Moriwaki, Code conformal field theory and framed algebra, arXiv:2104.10094.
- [Mo5] Y. Moriwaki, Vertex operator algebra and parenthesized braid operad, arXiv:2209.10443.
- [Mo6] Y. Moriwaki, Construction of boundary conditions for Narain CFT with twisted affine Heisenberg symmetry, in preparation.
- [MS] G. Moore and N. Seiberg, Classical and quantum conformal field theory, *Comm. Math. Phys.* **123**, 1989, 177–254.
- [NT] K. Nagatomo and A. Tsuchiya, Conformal field theories associated to regular chiral vertex operator algebras. I. Theories over the projective line, *Duke Math. J.*, 128, 2005, (3), 393–471.
- [OS1] K. Osterwalder and R. Schrader, Axioms for Euclidean Green’s functions, *Comm. Math. Phys.*, **31**, 1973, 83–112.
- [OS2] K. Osterwalder and R. Schrader, Axioms for Euclidean Green’s functions. II. *Comm. Math. Phys.*, **42**, 1975, 281–305.
- [Poly] A. M. Polyakov, Non-Hamiltonian approach to conformal quantum field theory, *Ž. Eksper. Teoret. ‘ Fiz.*, 66, 1974, 23–42
- [Ploc1] J. Polchinski, *String theory. Vol. I*, Cambridge Monographs on Mathematical Physics, Cambridge University Press, Cambridge, 1998.
- [Ploc2] J. Polchinski, *String theory. Vol. II*, Cambridge Monographs on Mathematical Physics, Cambridge University Press, Cambridge, 2005.
- [Seg] G. Segal. The definition of conformal field theory, *Topology, geometry and quantum field theory*, London Math. Soc. Lecture Note Ser. **308**, 2004, 421–577.
- [Ta] D. E. Tamarkin, Formality of chain operad of little discs, *Lett. Math. Phys.*, 66, 2003, (1-2), 65–72.
- [RRTV] R. Rattazzi, V.S. Rychkov, E. Tonni and A. Vichi, Bounding scalar operator dimensions in 4D CFT, *J. High Energy Phys.*, 2008, **12**.
- [V] A. A. Voronov, The Swiss-cheese operad, *Contemp. Math.* **239**, 1999, 365–373.