

Conditional Nested Pattern Matching in Interaction Nets

Shinya Sato

Institute for Liberal Arts Education
Ibaraki University, Ibaraki, Japan

Interaction nets are a form of restricted graph rewrite system that can serve as a graphical or textual programming language. As such, benefits include one-step confluence, ease of parallelism and explicit garbage collection. However, some of these restrictions burden the programmer, so they have been extended in several ways, notably to include data types and conditional rules. This paper introduces a further extension to allow nested pattern matching and to do so in a way that preserves these benefits and fundamental properties of interaction nets. We also show that by introducing a translation to non-nested matching, this extension is conservative in rewriting. In addition, we propose a new notation to express this pattern matching.

1 Introduction

Interaction nets, proposed by Lafont [6], can be considered as an execution model of programming languages, where programs are described as graphs and computation is realised by graph reduction. They have been used for optimal reduction [7, 3] and other efficient implementations [8] of λ -calculus, the basis of functional programming languages. Indeed, as a programming language, interaction nets have several attractive features:

- A simple graph rewriting semantics;
- A complete symmetry between constructors and destructors;
- They are Turing complete;
- Reduction steps are local, lending them to parallel execution without amending the algorithm being executed;
- Memory management, including garbage collection, is explicitly part of the execution, improving speed and, again, not requiring any changes in a parallel environment.

When writing programs in interaction nets, it is useful to have some extensions to the basic net structure, to facilitate the process. It is analogous to PCF [11], which is an extension of the pure typed λ -calculus obtained by adding some constants. For example, “pure” interaction nets do not have built-in constants, data types or conditional branching. Data types, such as integers, were introduced in [2], and conditional rewriting rules on values were introduced in [12].

Although net reduction rules have a basic, depth-one pattern matching, a nested version has been introduced in [4] as a conservative extension, *i.e.* although it provides a new feature to the programmer, it can be implemented using pure interaction nets and thus retains fundamental properties of interaction nets such as the one-step confluence property (defined in Section 2.1).

The aim of this paper is to introduce conditional nested pattern matching on values, as a further extension of [4], whilst preserving one-step confluence. We show that this extension is conservative by introducing a translation that maps the nested pattern matching back to pure nets. We also propose a new

notation for the pattern matching. This notation is similar to the well-known case expressions in many programming languages.

One of the goals of this work is to show how to represent functional programs (and more generally term rewriting systems) that contain nested pattern matching in interaction nets. This is part of ongoing work to demonstrate a real-world functional programming language that can take full advantage of interaction nets' built-in parallelism.

This paper is structured as follows. In the next section we give an overview of interaction nets and the extension for values. In Section 3 we introduce the conditional nested pattern matching. Section 4 introduces a translation that removes the nested pattern matching and shows that this extended matching is a conservative extension. Then Section 5 proposes a notation to easily express the matching and Section 6 discusses some implementation issues. The paper concludes in Section 7 with an outlook for the future.

2 Background

In this section we review the interaction net paradigm, and describe some known extensions to it.

2.1 Interaction nets

Interaction nets are graph rewriting systems [6]. Each node has a name α and one or more *ports* which can be connected to ports of other nodes. The number of ports is determined by the node name α and is called the node's *arity*, written as $\text{ar}(\alpha)$. When $\text{ar}(\alpha) = n$, then the node α has $n + 1$ ports: n *auxiliary* ports and a distinguished one called the *principal* port, labelled with an arrow. Nodes are drawn as follows:

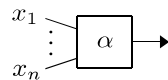

We may put different labels on the ports to distinguish them.

We have a set Σ of *symbols*, which are the names of nodes. A *net* built on Σ is an undirected graph: the vertices are nodes, and the edges connect nodes at the ports. There is at most one edge at every port. A port which is not connected is called a *free* port. A pair of nodes $(\alpha, \beta) \in \Sigma \times \Sigma$ connected via their principal ports forms an *active* pair, which is the interaction nets analogue of a redex pattern. We refer to such a connected pair (α, β) as $\alpha \bowtie \beta$. A rule $((\alpha, \beta) \Rightarrow N)$ describes how to replace the pair (α, β) with the net N . N can be any net as long as the set of free ports are preserved during the reduction. The following diagram illustrates the idea:

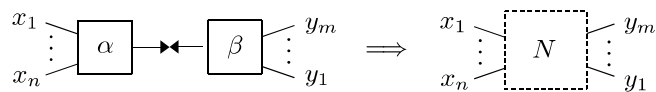

There is at most one rule for each pair of nodes, and the pairs are matched symmetrically, that is to say, (β, α) is also replaced by N by a rule $((\alpha, \beta) \Rightarrow N)$. If the pair is symmetric, such as (α, α) , then N must be symmetric. We write $N_1 \rightarrow N_2$ when a net N_1 is reduced to N_2 by a rule. One of the most powerful properties of this graph rewriting system is that it is one-step confluent; if $N \rightarrow N_1$ and $N \rightarrow N_2$ ($N_1 \neq N_2$), then there exists a net N' such that $N_1 \rightarrow N'$ and $N_2 \rightarrow N'$. Therefore, if a normal form exists, it is uniquely determined and any reduction path to the normal form has the same number of steps.

Here, as shown in Figure 1, we give an example of the interaction net system for unary number multiplication, represented by the following term rewriting system:

- $\text{Mult}(Z, y) = y$
- $\text{Mult}(S(x), y) = \text{Add}(y, \text{Mult}(x, y))$

This system has nodes Z , S , Add and Mult for arithmetic expressions and δ , ε for duplication and elimination where the α in the δ and ε rules stands for either Z or S . This rewrites $\text{Mult}(S(S(Z)), S(S(S(Z))))$ to $\text{Add}(S(S(S(Z))), \text{Add}(S(S(S(Z))), Z))$. Whilst in term rewriting systems $\text{Mult}(S(x), A)$ can be rewritten as $\text{Add}(A, \text{Mult}(x, A))$ even if the A has redexes, in this system the duplications are performed only for nets that have no active pairs, *i.e.* nets that are built from S and Z . We use δ to explicitly duplicate terms and ε to remove them when not needed in the result—an example of the explicit memory management. In addition, evaluated results in the interaction net can be quickly used for other computations without waiting for the whole computation to finish, *i.e.* as a *wait-free* algorithm. This is called a *stream operation* [9], and Figure 1 shows that in the second rewrite step, the S duplicated by $\delta \bowtie S$ can be used with Add .

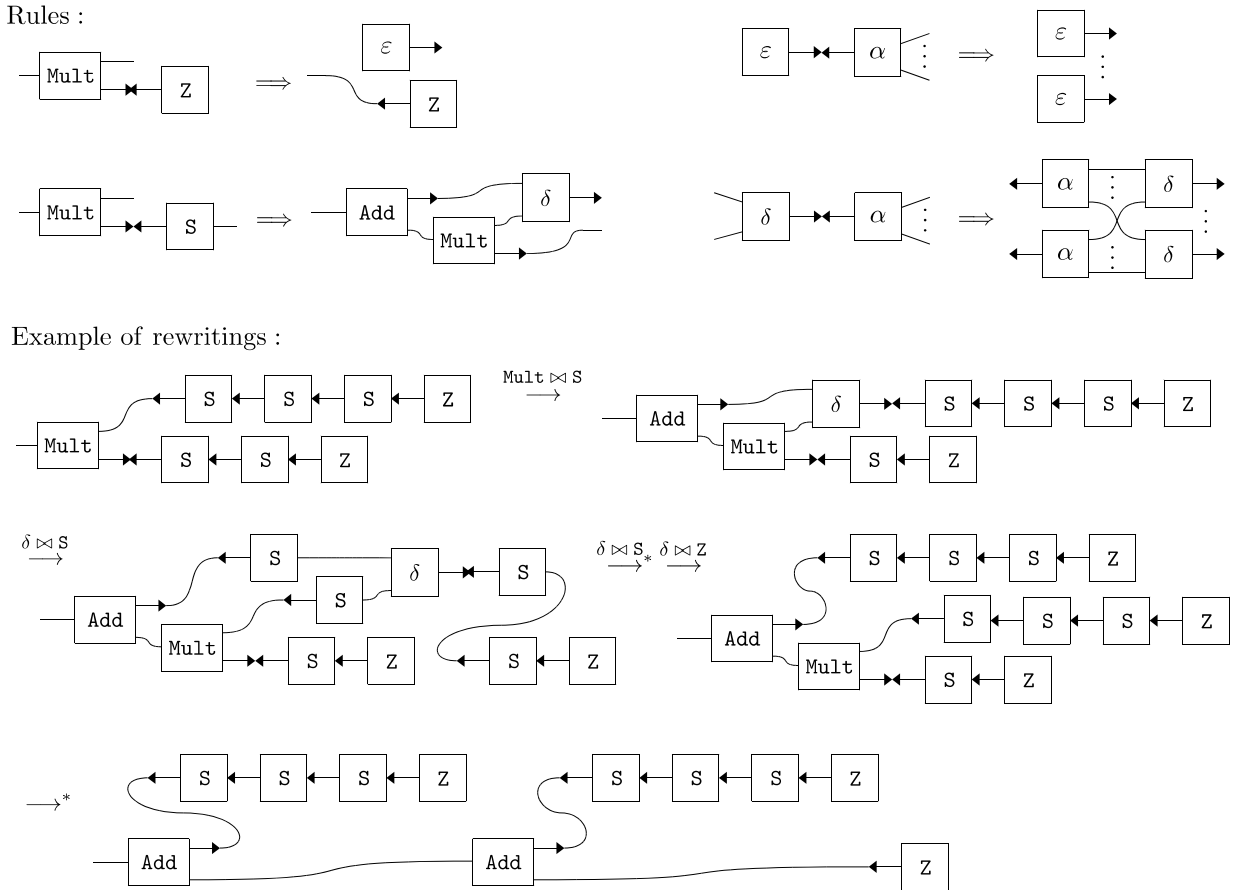
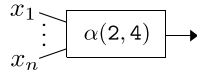

Figure 1: An example of rules and rewritings of interaction nets

We call the system *pure* to mean that no extensions are applied. From here, we show some extensions to the pure interaction nets system.

2.2 Attributes

Nodes can be extended to contain additional information [2, 12], and here we review an extension called *attributes* [12]. This extension is considered as an analogue of PCF obtained by adding some constants to the pure typed λ -calculus. Attribute values are integers and are written in parentheses following agent symbols. For instance, $\alpha(2,4)$ is a node which holds 2 and 4 as attribute values, and is drawn as follows:



Integers and their lists are represented using built-in nodes $\text{Int}(i)$, $\text{Cons}(j)$ and Nil where i, j are integer numbers, and are drawn as follows:

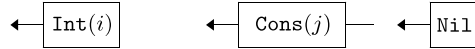

To simplify the diagram, the nodes $\text{Int}(i)$ and $\text{Cons}(j)$ are often drawn without the symbols when no confusion will happen. For instance, an integer 1 and a list of 2, 4, 3 are written in the following way:

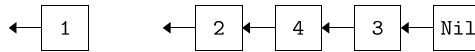

Rewriting rules are also extended to deal with attributes by considering a node name with attribute values as one symbol. For instance, the name of the node $\alpha(2,4)$, which holds attribute values 2 and 4, is considered as a symbol “ $\alpha(2,4)$ ”. We soon see that we need to add extra power to this system. For example, the increment operator for integer numbers can be defined by the following rules between a node Inc and each integer number:

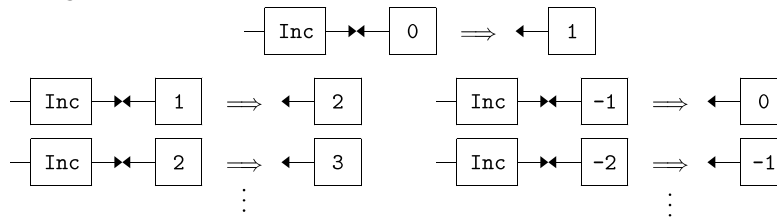

This demonstrates an obvious problem in practical using—if we want to define the increment for any integer, we need not only an infinite set of symbols such as $\text{Int}(0)$, $\text{Int}(1)$, $\text{Int}(-1)$, $\text{Int}(2)$, ..., but also an infinite number of rules. To deal with these in finite schemes, we introduce meta variables v for them, called *attribute variables* and *expressions* e on attribute variables as follows:

$$e ::= v \mid i \mid -e \mid \text{not } e \mid e \text{ op } e \mid (e)$$

where v is an attribute variable, i is an integer number, e is an expression, and op is defined as follows:

$$\text{op} ::= + \mid - \mid * \mid / \mid \text{mod} \mid == \mid != \mid < \mid <= \mid > \mid >= \mid \text{and} \mid \text{or}.$$

The definition of expressions may be extended as long as the computation is decidable. We will abbreviate in the following the left- and right-hand sides of a rule by LHS and RHS, respectively. Attribute variables can be placed on the LHS nodes, expressions on the variables can be placed on the RHS nodes, just like attributes. The LHS nodes do not have the same attribute variables to ensure that each variable matches any attribute value; for example, $\alpha(i,i)$ is not allowed as the name of the LHS node because it has the same variable as i , whereas $\alpha(i,j)$ is allowed. Now the increment operator is represented as the following one rule, in which an attribute value v is replaced by a value obtained by executing $v+1$:

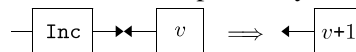

Addition of integers on two node attributes is represented as the following two rules:



2.2.1 Conditional rules on attributes

Conditional rules were proposed in [12], and here we introduce a refined version. We write conditional rules as $((\alpha, \beta) \text{ if } c \Rightarrow N)$, where the c is an expression on attribute variables of α, β . The c is called the *conditional expression* of a rule, and the rule becomes available to be applied if c is calculated to true, where false is represented by 0 and true by any other value. We also refer to the active pair with a conditional expression as $(\alpha \bowtie \beta \text{ if } c)$, and call it a *conditional active pair*. The rule is drawn as follows:

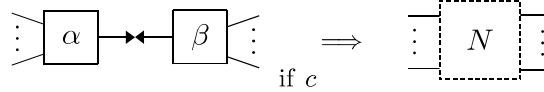

There may exist several conditional rules for the same active pair, but they must be *disjoint*, *i.e.* only at most one condition among the rules must be true. This can be realised by introducing a decidable evaluation strategy for the conditions. We use `true` and `false` that are evaluated as true and false, respectively. In addition, as a refined version, we introduce a special conditional rule $((\alpha, \beta) \text{ if otherwise } \Rightarrow N)$ which becomes available if any other conditional expressions for the $\alpha \bowtie \beta$ become false. We may write “if otherwise” as just “otherwise” and omit “if true” when no confusion will arise.

For instance, a function `sumup` that takes a natural number and computes the sum up to the number can be realised by the following conditional rules:

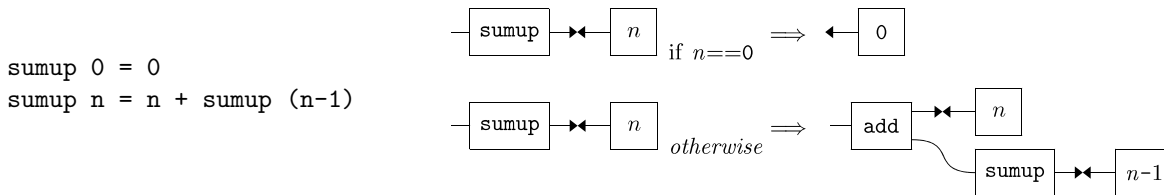

Conditional rules are disjoint for the same active pairs, therefore the one-step confluence property is preserved.

3 Conditional Nested Pattern Matching

In this section we introduce conditional nested pattern matching on attributes, as an extension of the nested matching introduced in [4], so that we can put a condition on each nested pattern. We write NAP as an abbreviation of “nested active pair”.

Attribute values can be considered as parts of symbols, so nested pattern matching can also manage attributes values. Here, we extend the NAP to conditional ones. For simplicity, we consider all rules $((\alpha, \beta) \Rightarrow N)$ in the pure system as conditional rules with the `true` expression such as $((\alpha, \beta) \text{ if true } \Rightarrow N)$.

Definition 3.1 (Conditional NAPs). *Conditional NAPs* $\langle P_{if} \rangle$ are inductively defined as follows:

Base: Every conditional active pair $(\alpha \bowtie \beta \text{ if } c)$ is a conditional NAP. We write this as:

$$\langle \alpha(\vec{x}) \bowtie \beta(\vec{y}) \text{ if } c \rangle$$

where \vec{x}, \vec{y} are distinct names, corresponding to the occurrences of the auxiliary ports of α and β , respectively.

Step: We assume that $\langle P_{if} \rangle$ is a conditional NAP, γ is an agent, c is an expression on attribute variables of agents occurring in $\langle P_{if} \rangle$ and a free port in $\langle P_{if} \rangle$ has a name z . A net obtained by connecting the principal port of γ with the expression c to the free port z is also a conditional NAP.

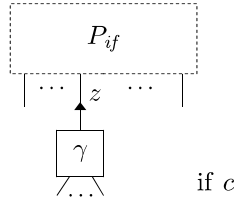

We write this as:

$$\langle P_{if}, z - \gamma(\vec{w}) \text{ if } c \rangle$$

where \vec{w} are distinct names and fresh for $\langle P_{if} \rangle$, corresponding to the occurrences of the auxiliary ports of γ .

We call the form “ $z - \gamma(\vec{w}) \text{ if } c$ ” a *connection* in a conditional NAP. We use u to range over connections.

Expressions that occur as “if c ” in conditional NAPs are also called *conditional expressions*. If all conditional expressions in a conditional NAP evaluate to true, the NAP is called *available*.

We build just a NAP from a conditional NAP by removing all conditional expressions. For a conditional NAP $\langle P_{if} \rangle$, we write the (non-conditional) $\langle P \rangle$ as the *condition dropped* NAP for $\langle P_{if} \rangle$. A rewriting rule on a conditional NAP ($\langle P_{if} \rangle \Rightarrow N$) replaces a matched net by the condition dropped $\langle P \rangle$ to the net N if $\langle P_{if} \rangle$ is available. Nested nets are also symmetrically matched and replaced.

Example 3.2. We take the following program gcd' which obtains the greatest common divisor of two given natural numbers:

```
gcd' (a,b) = if b==0 then a
           else gcd' (b, a 'mod' b)
```

This is written as the following rewriting rules on conditional NAPs:

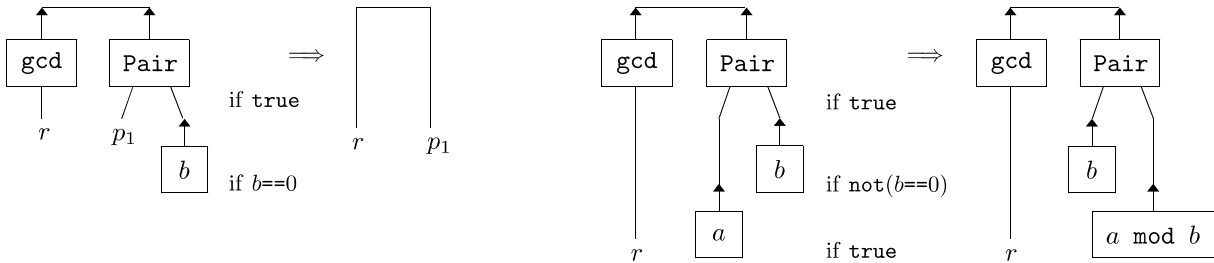

The following is an example of rewritings for gcd' (21, 14):

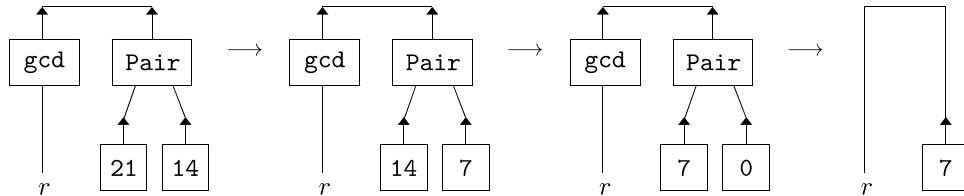

Of course, we can realise the same computation for the gcd' without conditional NAPs, but this requires several additional rules that obscure the overall meaning:

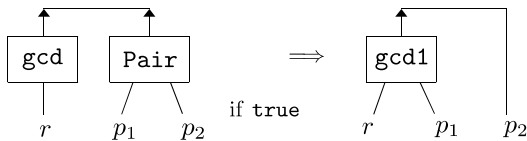

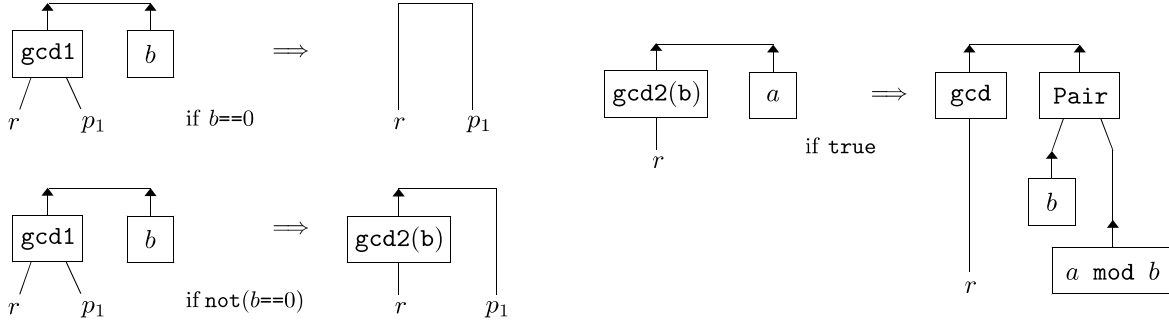

Example 3.3. Consider the following non-confluent map: $f(0, y)=0$, $f(x, 0)=1$.

This map is encoded as the following rules where the agent `del` deletes built-in nodes $\text{Int}(i)$:

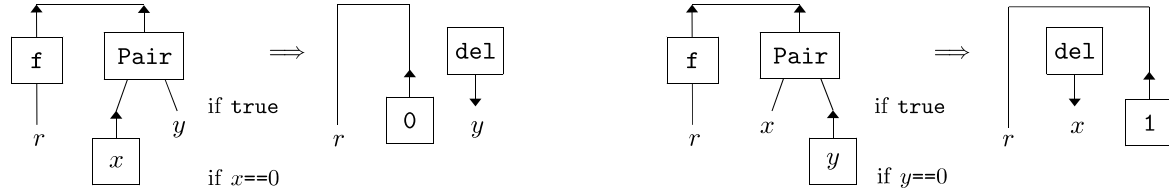

As shown below, the two rewriting paths from $f(0, 0)$ are not confluent:

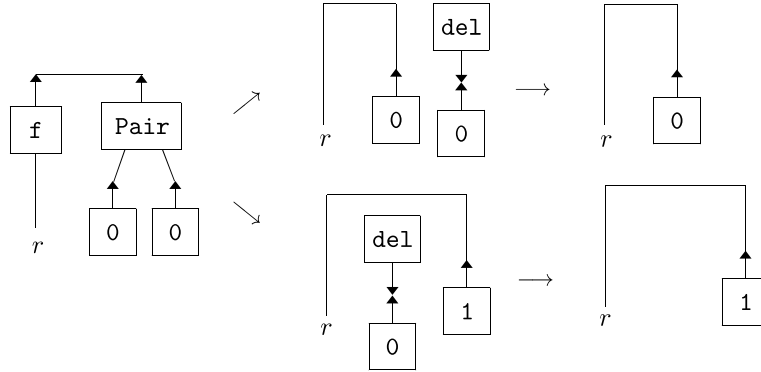

To preserve the one-step confluence property, it is sufficient to introduce *local sequentiality* [6], *i.e.* which port is looked first. We extend several properties in [4]. First, we instantiate the sequentiality to sets of conditional NAPs:

Definition 3.4 (Local sequentiality). Let \mathcal{P}_{if} be a set of conditional NAPs. \mathcal{P}_{if} is *local sequential* if:

(1) If $\langle \alpha(\vec{x}) \bowtie \beta(\vec{y}) \text{ if } c \rangle \in \mathcal{P}_{if}$:

(1a) All conditional expressions c_k such that $\langle \alpha(\vec{x}) \bowtie \beta(\vec{y}) \text{ if } c_k \rangle \in \mathcal{P}_{if}$ are disjoint, *i.e.* only at most one conditional expression must be true.

(2) If $\langle P_{if}, z - \gamma(\vec{w}) \text{ if } c \rangle \in \mathcal{P}_{if}$:

(2a) All conditional expressions c_k such that $\langle P_{if}, z - \gamma(\vec{w}) \text{ if } c_k \rangle \in \mathcal{P}_{if}$ are disjoint,

(2b) $\langle P_{if} \rangle \in \mathcal{P}_{if}$,

(2c) $\langle P_{if}, z_j - \gamma_j(\vec{w}_j) \text{ if } c_j \rangle \notin \mathcal{P}_{if}$ for any free port z_j in the $\langle P_{if} \rangle$ except the z , where γ_j is an agent, c_j is a conditional expression.

We may write “local sequential” as just “sequential” when no confusion will arise. If a local sequential set has an element $\langle \alpha(\vec{x}) \bowtie \beta(\vec{y}) \text{ if } c, \vec{u}, z - \gamma(\vec{w}) \text{ if } c \rangle$ where \vec{u} is a sequence of connections, then every element started from the origin pair $\alpha \bowtie \beta$ is along the path to the z . For clarity, we draw triangles on auxiliary ports connected to agents, and horizontal dotted lines for the sequential order. As an example, we depict a NAP which is textually represented $\langle \alpha(\vec{x}) \bowtie \beta(\vec{y}) \text{ if } c_1, z_k - \kappa(\vec{w}) \text{ if } c_2, z_1 - \gamma(\vec{z}) \text{ if } c_3 \rangle$ as follows:

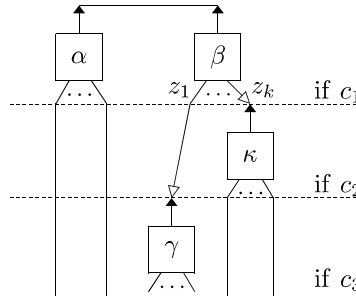

Example 3.5. The following program `lastElt` returns the last element of a given non-empty list:

```
lastElt ([x]) = x
lastElt (x:y:ys) = lastElt (y:ys)
```

This is written as the following rewriting rules on (non-conditional) NAPs where `del` erases any agent:

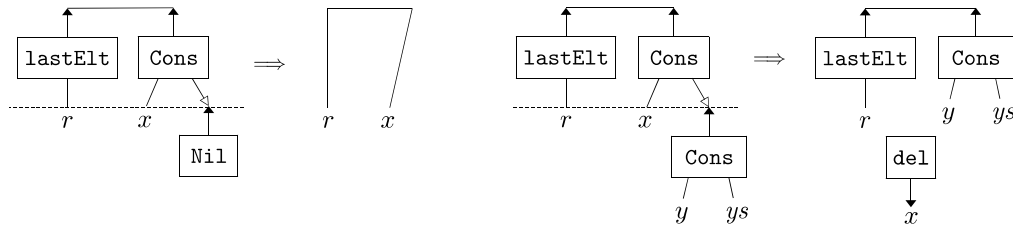

These are written as follows (omitting “if true”) and the set of the LHS nodes of the rules is sequential:

- $\langle \langle \text{lastElt}(r) \bowtie \text{Cons}(x, xs), xs - \text{Nil} \rangle \Rightarrow N_1 \rangle$,
- $\langle \langle \text{lastElt}(r) \bowtie \text{Cons}(x, xs), xs - \text{Cons}(y, ys) \rangle \Rightarrow N_2 \rangle$.

Example 3.6. The rewriting rules in Example 3.2 are textually written and graphically drawn as follows and the set of the LHS nodes of the rules is also sequential:

- $\langle \langle \text{gcd}(r) \bowtie \text{Pair}(p_1, p_2) \text{ if true}, p_2 - \text{Int}(b) \text{ if } b==0 \rangle \Rightarrow N_1 \rangle$,
- $\langle \langle \text{gcd}(r) \bowtie \text{Pair}(p_1, p_2) \text{ if true}, p_2 - \text{Int}(b) \text{ if not}(b==0), p_1 - \text{Int}(a) \text{ if true} \rangle \Rightarrow N_2 \rangle$.

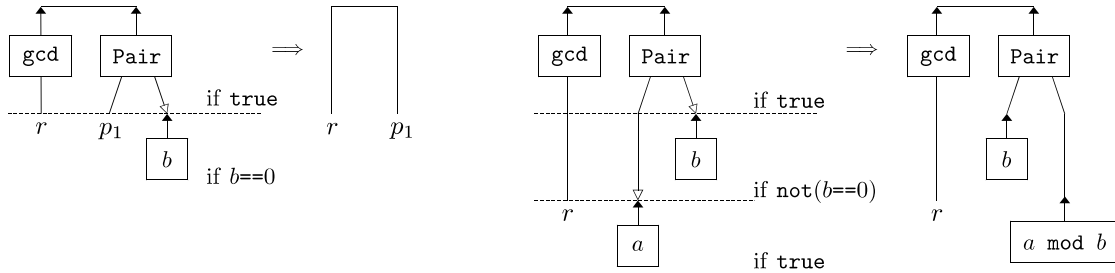

Next, we extend well-formed rule sets [4] as sets of pairwise distinct rules on conditional NAPs:

Definition 3.7 (Subnets of conditional NAPs). Let $\langle P_{if} \rangle$ and $\langle P'_{if} \rangle$ be conditional NAPs. $\langle P_{if} \rangle$ is a *subnet* of $\langle P'_{if} \rangle$ if:

- $\langle P \rangle$ is a subnet of $\langle P' \rangle$, where $\langle P \rangle$ and $\langle P' \rangle$ are condition dropped NAPs for $\langle P_{if} \rangle$ and $\langle P'_{if} \rangle$, respectively.
- $\langle P_{if} \rangle$ is available if $\langle P'_{if} \rangle$ is available.

Definition 3.8 (Sets of pairwise distinct rules). A set of *pairwise distinct* rules on conditional NAPs \mathcal{R}_{if} is defined if:

- There is a local sequential set which contains every conditional NAP $\langle P_{if} \rangle$ such that $(\langle P_{if} \rangle \Rightarrow N) \in \mathcal{R}_{if}$,
- For any $(\langle P_{if} \rangle \Rightarrow N) \in \mathcal{R}_{if}$, \mathcal{R}_{if} has no $(\langle P'_{if} \rangle \Rightarrow N')$ where $\langle P'_{if} \rangle$ is a subnet of $\langle P_{if} \rangle$.

We call a rule set *pairwise distinct* if the set satisfies conditions in Definition 3.8. We also call rules *pairwise distinct* if there is a set of pairwise distinct rules containing them.

As long as a rule set is pairwise distinct, one-step confluence property is preserved as follows:

Proposition 3.9 (One-step confluent). *When a given set of rules on conditional NAPs \mathcal{R}_{if} is pairwise distinct, then all reductions using rules in \mathcal{R}_{if} are confluent in one step.*

Proof. We assume that \mathcal{R}_{if} has two rules $(\langle P_{if} \rangle \Rightarrow N)$ and $(\langle P'_{if} \rangle \Rightarrow N')$ which rewrite the same NAP into different nets N and N' . Let $\langle P \rangle$ and $\langle P' \rangle$ be condition dropped NAPs for $\langle P_{if} \rangle$ and $\langle P'_{if} \rangle$, respectively.

First, we suppose that $\langle P \rangle$ and $\langle P' \rangle$ are the same. If both $\langle P_{if} \rangle$ and $\langle P'_{if} \rangle$ are available, then conditional expressions in $\langle P_{if} \rangle$ and $\langle P'_{if} \rangle$ are not disjoint, and this contradicts that $\langle P_{if} \rangle$ and $\langle P'_{if} \rangle$ are elements of the same sequential set. Otherwise, at most only one rule can be applied to the $\langle P \rangle$, and thus no critical pairs will be created by using both rules.

Next, we suppose that the $\langle P \rangle$ is a subnet of $\langle P' \rangle$. If both $\langle P_{if} \rangle$ and $\langle P'_{if} \rangle$ are available, then $\langle P_{if} \rangle$ is a subnet of $\langle P'_{if} \rangle$, and it contradicts that the \mathcal{R}_{if} is well-formed. Otherwise, there is at most only one rule that can be applied to both $\langle P \rangle$ and $\langle P' \rangle$. As a result, there are no critical pairs by using both rules. \square

4 Translation of nested conditional rules into non-nested ones

In this section we introduce a translation \mathbf{T} of a rewriting rule on a conditional NAP $(\langle P_{if} \rangle \Rightarrow N)$ into non-nested conditional rules and show properties of the translation \mathbf{T} . Generally nested pattern matching can be unfolded by introducing fresh symbols into less nested ones [5]. In NAPs each nested agent is inductively connected, and thus by considering such induction steps as the local sequential order, we realise the nested matching as non-nested ones by introducing fresh agents.

Definition 4.1. We define a translation \mathbf{T} of a rewriting rule on a conditional NAP $(\langle P_{if} \rangle \Rightarrow N)$ into non-nested conditional rules by structural induction on conditional NAPs:

Base case: If the $\langle P_{if} \rangle$ is $\langle \alpha(\vec{x}) \bowtie \beta(\vec{y}) \text{ if } c \rangle$, then the translation \mathbf{T} works as the identity function.

Step case: If the $\langle P_{if} \rangle$ is $\langle \alpha(\vec{x}) \bowtie \beta(\vec{y}) \text{ if } c, z - \gamma(\vec{w}) \text{ if } c_z, \vec{u} \rangle$ where z is an auxiliary port in $\alpha(\vec{x}) \bowtie \beta(\vec{y})$ and \vec{u} is a sequence of connections such as “ $z_1 - \gamma(\vec{w}_1) \text{ if } c_1, z_2 - \gamma(\vec{w}_2) \text{ if } c_2, \dots$ ”.

To draw graphs simply, we suppose that \vec{y} is y_1, \dots, y_m, y_{m+1} and the z is y_{m+1} . Other cases can be defined in a similar way. We also write the α and β as $\alpha'(\vec{a})$ and $\beta'(\vec{b})$, respectively, in order to show the attribute variables explicitly.

The \mathbf{T} generates the following rules:

- $(\alpha'(\vec{a})(\vec{x}) \bowtie \beta'(\vec{b})(\vec{y}) \text{ if } c \Rightarrow M)$ where M is a net obtained by connecting the y_{m+1} to the principal port of an agent $\kappa(\vec{a}, \vec{b})(\vec{x}, y_1, \dots, y_m)$ and the κ is fresh for Σ and the previous occurring symbols and depending uniquely on the symbols α', β' and the conditional expression c ,

- $\mathbf{T}[(\langle \kappa(\vec{a}, \vec{b})(\vec{x}, y_1, \dots, y_m) \bowtie \gamma(\vec{w}) \text{ if } c_z, \vec{u} \rangle \Rightarrow N)]$.

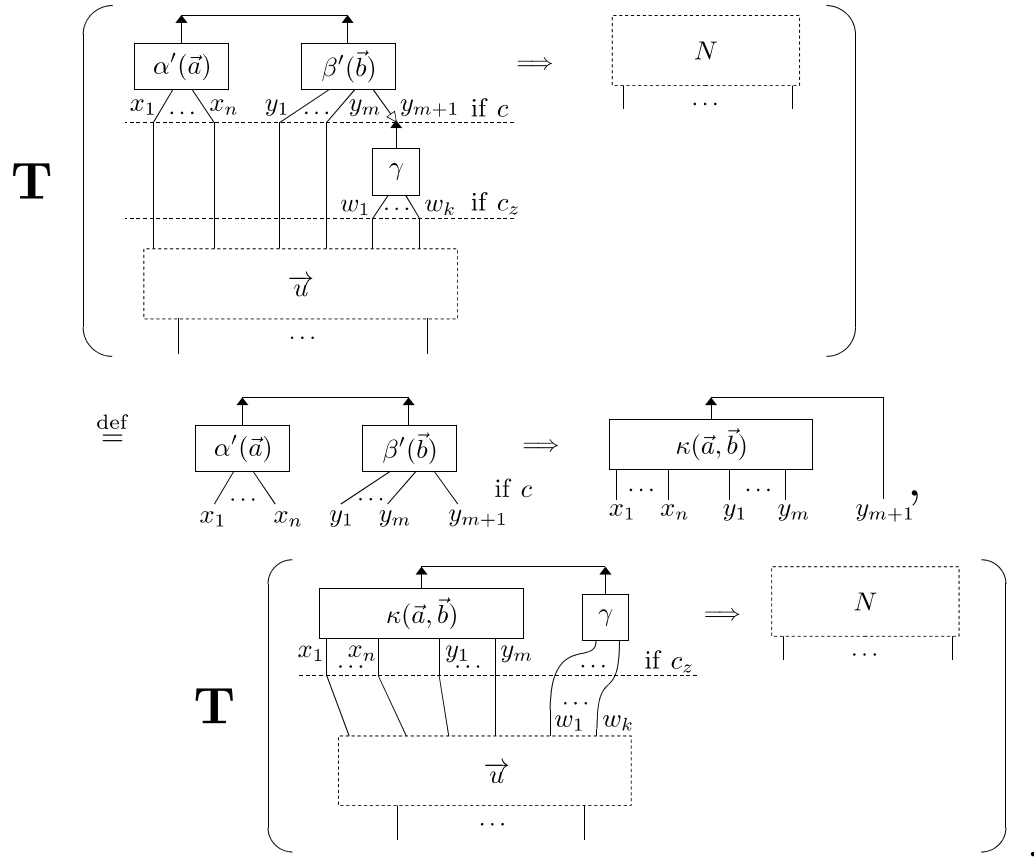

Example 4.2. We show the translation of the rules for $\text{gcd} \bowtie \text{Pair}$ in Example 3.2. First, we take the following rule: $(\langle \text{gcd}(r) \bowtie \text{Pair}(p_1, p_2) \text{ if true}, p_2 - \text{Int}(b) \text{ if } b=0 \rangle \Rightarrow N_1)$. By applying the translation to the rule, we have the following rule and translation:

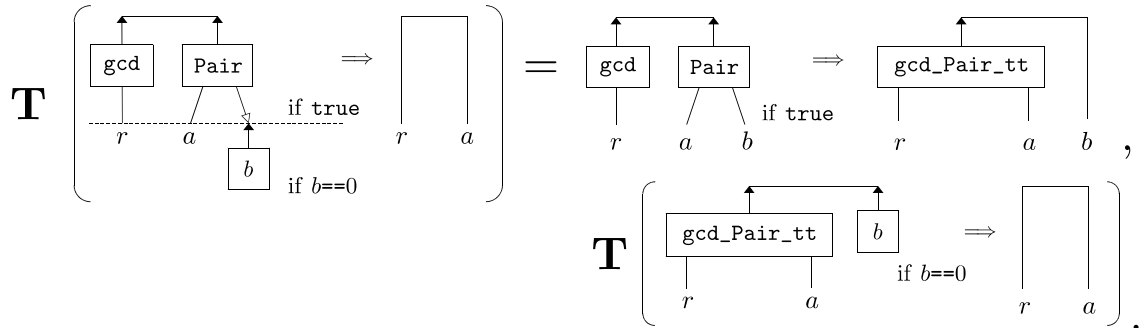

\mathbf{T} works for $(\langle \text{gcd_Pair_tt} \bowtie \text{Int}(b) \text{ if true} \rangle)$ as the identity function, so we obtain the following rules as the result:

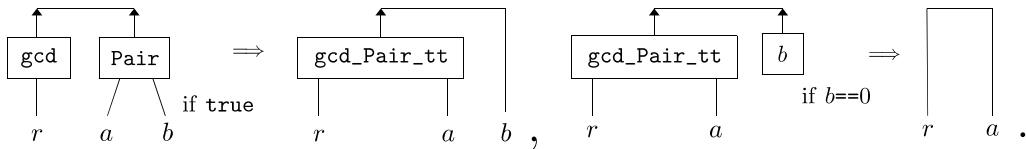

The other rule for $\text{gcd} \bowtie \text{Pair}$ is similarly translated as follows:

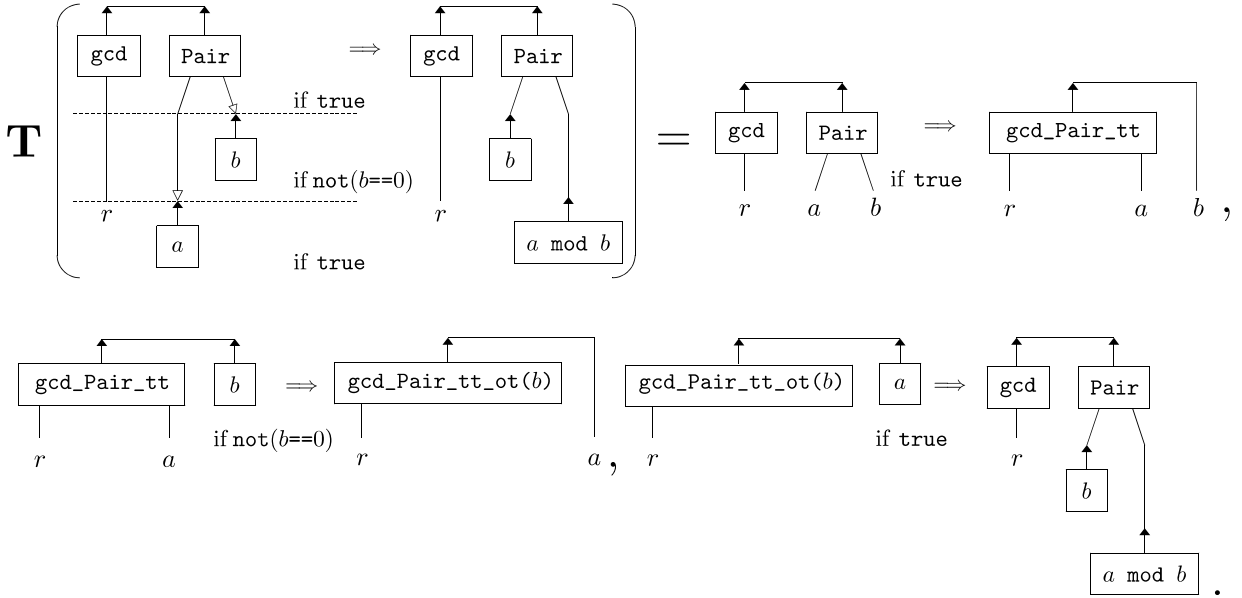

By the obtained conditional rules for $\text{gcd_Pair_tt} \bowtie \text{Int}(b)$, we have two branches according to the value of b —return the result a if b is 0, otherwise proceed to the calculation. We note the four rules obtained are the same as the non-nested rules in Example 3.2, by changing gcd_Pair_tt and gcd_Pair_tt_ot into gcd1 and gcd2 , respectively.

For each connection of a conditional NAP, the translation T introduces a rule in which one of the active pair agents has a fresh symbol for Σ and the previous occurring ones. Therefore, the following holds:

Lemma 4.3. *Let R_{if} be a rule on a conditional NAP. $T[R_{if}]$ does not have two rules for the same active pair P such that $(P \text{ if } c_1 \Rightarrow N_1)$ and $(P \text{ if } c_2 \Rightarrow N_2)$.* \square

Lemma 4.4. *Let R_1, R_2 be pairwise distinct rules on conditional NAPs. When for the same active pair P , $(P \text{ if } c_1 \Rightarrow N_1)$ and $(P \text{ if } c_2 \Rightarrow N_2)$ are introduced by $T[R_1]$ and $T[R_2]$, then c_1, c_2 are disjoint or $N_1 = N_2$.* \square

We suppose an interaction net that has a symbol set Σ and a set of pairwise distinct rules on conditional NAPs \mathcal{R}_{if} . By applying the translation T to each rule in \mathcal{R}_{if} , we obtain two sets \mathcal{R}'_{if} and Σ' —a set of (non-nested) conditional rules and a set of symbol introduced during the translation, respectively. The system with a symbol set $\Sigma \cup \Sigma'$ and a rule set \mathcal{R}'_{if} is also an interaction net by Lemma 4.3 and 4.4. In addition, the following proposition shows that the conditional NAP extension is conservative, *i.e.* an interaction net with $\Sigma \cup \Sigma'$ and \mathcal{R}_{if} is realised without the extension, thus as an interaction net with $\Sigma \cup \Sigma'$ and \mathcal{R}'_{if} .

Proposition 4.5. *Let $(\langle P_{if} \rangle \Rightarrow N)$ be a rule on conditional NAPs and $\langle P \rangle$ be the condition dropped NAP for $\langle P_{if} \rangle$. If $\langle P \rangle$ is reduced to N by using this rule, $\langle P \rangle$ is also reduced to N by using only rules obtained from $T[(\langle P_{if} \rangle \Rightarrow N)]$.*

Proof. By structural induction on conditional NAPs.

Base case: The translation T works as the identity function, so the $\langle P \rangle$ is reduced to N by using rules obtained from the translation.

Step case: We assume that $\langle P_{if} \rangle$ is $\langle P_1 \text{ if } c_1, z - \gamma(\vec{w}) \text{ if } c, \vec{u} \rangle$ and the condition dropped NAP $\langle P \rangle$ is reduced to N by the rule $(\langle P_{if} \rangle \Rightarrow N)$. T generates the following rules:

- (1) $(P_1 \text{ if } c_1 \Rightarrow M)$ where M is a net obtained by connecting the z to the principal port of an agent $\kappa(\vec{z})$, where the symbol κ is a fresh and uniquely depending on the agents symbols in P_1 and the c_1 .
- (2) $T[\langle \kappa(\vec{z}) \bowtie \gamma(\vec{w}) \text{ if } c, \vec{u} \rangle \Rightarrow N]$.

By the rule of (1), P_1 is reduced to an active pair (κ, γ) , and it is iteratively reduced to N by the induction hypothesis. \square

5 A notation for rules on conditional NAPs

In this section, we introduce a notation to facilitate expressing sets of pairwise distinct rules.

It is practical to write rules for an active pair $\alpha \bowtie \beta$ with conditional expressions c_1, \dots, c_n as *guards* like in Haskell [10], which are evaluated one at a time from c_1 to c_n , as follows:

$$\begin{array}{l} \alpha(\vec{x}) \bowtie \beta(\vec{y}) \\ | c_1 \Rightarrow N_1 \\ | c_2 \Rightarrow N_2 \\ \vdots \\ | c_n \Rightarrow N_n. \end{array}$$

The last placed “*otherwise*” is evaluated as true. We can suppose that this is translated into the following rules where the conditional expressions do not overlap:

$$\begin{array}{l} ((\alpha, \beta) \text{ if } c_1 \Rightarrow N_1), \\ ((\alpha, \beta) \text{ if not}(c_1) \text{ and } c_2 \Rightarrow N_2), \dots, \\ ((\alpha, \beta) \text{ if not}(c_1 \text{ or } c_2 \text{ or } \dots \text{ or } c_{n-1}) \text{ and } c_n \Rightarrow N_n). \end{array}$$

As another example, we take the following two rules whose bases of conditional NAPs are the same ones which are followed by connections to the same port:

$$\begin{array}{l} (\langle \alpha(\vec{x}) \bowtie \beta(\vec{y}) \text{ if } c, z - \gamma(\vec{z}_1) \text{ if } c_1 \rangle \Rightarrow N_1), \\ (\langle \alpha(\vec{x}) \bowtie \beta(\vec{y}) \text{ if } c, z - \kappa(\vec{z}_2) \text{ if } c_2 \rangle \Rightarrow N_2) \end{array}$$

It is also convenient to group these connections by the same port z with guards and a case-expression as follows:

$$\begin{array}{l} \alpha(\vec{x}) \bowtie \beta(\vec{y}) \\ | c \rightarrow \text{case of } z \\ \quad \gamma(\vec{z}_1) \quad | c_1 \Rightarrow N_1 \\ \quad \kappa(\vec{z}_2) \quad | c_2 \Rightarrow N_2. \end{array}$$

We may omit the guards if there is only one condition true.

Example 5.1. By using this notation, the rules for $\text{gcd} \bowtie \text{Pair}$ in Example 3.2 is written in the following single sentence:

$$\begin{array}{l} \text{gcd}(r) \bowtie \text{Pair}(p_1, p_2) \\ \rightarrow \text{case of } p_2 \\ \quad \text{Int}(b) \quad | b==0 \Rightarrow N_1 \\ \quad | \text{otherwise} \rightarrow \text{case of } p_1 \\ \quad \quad \text{Int}(a) \Rightarrow N_2. \end{array}$$

5.1 Definition and translations of the notation

First, we define the rule notation by the following *Rule* with *Sprays*, which are branches connected to nets:

$$\begin{array}{l}
 \text{Rule} ::= \alpha(\vec{x}) \bowtie \beta(\vec{y}) \mid c_1 \text{ Spray}_1 \\
 \qquad \qquad \qquad \mid c_2 \text{ Spray}_2 \\
 \qquad \qquad \qquad \vdots \\
 \qquad \qquad \qquad \mid c_m \text{ Spray}_m
 \end{array}
 \qquad
 \begin{array}{l}
 \text{Spray} ::= \Rightarrow N \\
 \qquad \qquad \mid \rightarrow \text{case } z \text{ of} \\
 \qquad \qquad \qquad \gamma_1(\vec{w}_1) \mid c_{11} \text{ Spray}_{11} \\
 \qquad \qquad \qquad \vdots \\
 \qquad \qquad \qquad \mid c_{1m_1} \text{ Spray}_{1m_1} \\
 \qquad \qquad \qquad \vdots \\
 \qquad \qquad \qquad \gamma_n(\vec{w}_n) \mid c_{n1} \text{ Spray}_{n1} \\
 \qquad \qquad \qquad \vdots \\
 \qquad \qquad \qquad \mid c_{nm_n} \text{ Spray}_{nm_n}
 \end{array}$$

where $\alpha(\vec{x})$, $\beta(\vec{y})$ are agents, c_i is a conditional expression, N is a net, z is a free port, $\gamma_1(\vec{w}_1), \dots, \gamma_n(\vec{w}_n)$ are distinct agents, and the conditional expression “otherwise” can appear last. We may write *Spray* as S when there is no confusion.

Translation of the rule notation to rules on conditional NAPs: We define the following translations of the rule notation to obtain rules on conditional NAPs:

$$\text{T}_R : \text{Rule} \mapsto \overrightarrow{\text{T}_S[\langle P_{if} \rangle, \text{Spray}]}, \quad \text{T}_S : (\langle P_{if} \rangle, \text{Spray}) \mapsto \vec{r}$$

where $\langle P_{if} \rangle$ is a conditional NAP, \vec{r} is a rule sequence. If the $\langle P_{if} \rangle$ obtained during translation do not satisfy the conditions of given in Definition 3.1, then the translation will fail.

We may write “not(c_1 or c_2 or \dots or c_{n-1}) and c_n ” as “not(c_1, c_2, \dots, c_{n-1}) & c_n ” to save space. In addition, we may write “not(c_1, c_2, \dots, c_{n-1}) & otherwise” just as “otherwise”.

$$\text{T}_R \left[\begin{array}{l} \alpha(\vec{x}) \bowtie \beta(\vec{y}) \mid c_1 S_1 \\ \qquad \qquad \qquad \mid c_2 S_2 \\ \qquad \qquad \qquad \vdots \\ \qquad \qquad \qquad \mid c_n S_n \end{array} \right] \stackrel{\text{def}}{=} \begin{array}{l} \text{T}_S[\langle \alpha(\vec{x}) \bowtie \beta(\vec{y}) \text{ if } c_1 \rangle, S_1], \\ \text{T}_S[\langle \alpha(\vec{x}) \bowtie \beta(\vec{y}) \text{ if not}(c_1) \& c_2 \rangle, S_2] \\ \qquad \qquad \qquad \vdots \\ \text{T}_S[\langle \alpha(\vec{x}) \bowtie \beta(\vec{y}) \text{ if not}(c_1, c_2, \dots, c_{n-1}) \& c_n \rangle, S_n]. \end{array}$$

$$\text{T}_S [\langle P_{if} \rangle, \Rightarrow N] \stackrel{\text{def}}{=} (\langle P_{if} \rangle \Rightarrow N),$$

$$\text{T}_S \left[\langle P_{if} \rangle, \begin{array}{l} \rightarrow \text{case } z \text{ of} \\ \qquad \gamma_1(\vec{w}_1) \mid c_{11} S_{11} \\ \qquad \qquad \qquad \vdots \\ \qquad \qquad \qquad \mid c_{1m_1} S_{1m_1} \\ \qquad \qquad \qquad \vdots \\ \qquad \gamma_n(\vec{w}_n) \mid c_{n1} S_{n1} \\ \qquad \qquad \qquad \vdots \\ \qquad \qquad \qquad \mid c_{nm_n} S_{nm_n} \end{array} \right] \stackrel{\text{def}}{=} \begin{array}{l} \text{T}_S[\langle P_{if}, z - \gamma_1(\vec{w}_1) \text{ if } c_{11} \rangle, S_{11}], \\ \qquad \qquad \qquad \vdots \\ \text{T}_S[\langle P_{if}, z - \gamma_1(\vec{w}_1) \text{ if not}(c_{11}, \dots, c_{1m_1-1}) \& c_{1m_1} \rangle, S_{1m_1}], \\ \qquad \qquad \qquad \vdots \\ \text{T}_S[\langle P_{if}, z - \gamma_n(\vec{w}_n) \text{ if } c_{n1} \rangle, S_{n1}], \\ \qquad \qquad \qquad \vdots \\ \text{T}_S[\langle P_{if}, z - \gamma_1(\vec{w}_n) \text{ if not}(c_{n1}, \dots, c_{nm_n-1}) \& c_{nm_n} \rangle, S_{nm_n}]. \end{array}$$

Example 5.2. The following is a translation of the rule notation in Example 5.1:

$$\begin{aligned}
& T_R \left[\begin{array}{l} \text{gcd}(r) \bowtie \text{Pair}(p_1, p_2) \\ | \text{ true } \rightarrow \text{ case of } p_2 \\ \quad \text{Int}(b) \mid b==0 \Rightarrow N_1 \\ | \text{ otherwise } \rightarrow \text{ case of } p_1 \\ \quad \text{Int}(a) \mid \text{ true } \Rightarrow N_2 \end{array} \right] \\
&= T_S \left[\begin{array}{l} \langle \text{gcd}(r) \bowtie \text{Pair}(p_1, p_2) \text{ if true} \rangle, \quad \begin{array}{l} \rightarrow \text{ case of } p_2 \\ \text{Int}(b) \mid b==0 \Rightarrow N_1 \\ | \text{ otherwise } \rightarrow \text{ case of } p_1 \\ \text{Int}(a) \mid \text{ true } \Rightarrow N_2 \end{array} \end{array} \right] \\
&= T_S [\langle \text{gcd}(r) \bowtie \text{Pair}(p_1, p_2) \text{ if true}, p_2 - \text{Int}(b) \text{ if } b==0 \rangle, \Rightarrow N_1], \\
& \quad T_S \left[\langle \text{gcd}(r) \bowtie \text{Pair}(p_1, p_2) \text{ if true}, p_2 - \text{Int}(b) \text{ if } \textit{otherwise} \rangle, \begin{array}{l} \rightarrow \text{ case of } p_1 \\ \text{Int}(a) \mid \text{ true } \Rightarrow N_2 \end{array} \right] \\
&= (\langle \text{gcd}(r) \bowtie \text{Pair}(p_1, p_2) \text{ if true}, p_2 - \text{Int}(b) \text{ if } b==0 \rangle \Rightarrow N_1), \\
& \quad T_S [\langle \text{gcd}(r) \bowtie \text{Pair}(p_1, p_2) \text{ if true}, p_2 - \text{Int}(b) \text{ if } \textit{otherwise}, p_1 - \text{Int}(a) \text{ if true} \rangle, \Rightarrow N_2] \\
&= (\langle \text{gcd}(r) \bowtie \text{Pair}(p_1, p_2) \text{ if true}, p_2 - \text{Int}(b) \text{ if } b==0 \rangle \Rightarrow N_1), \\
& \quad (\langle \text{gcd}(r) \bowtie \text{Pair}(p_1, p_2) \text{ if true}, p_2 - \text{Int}(b) \text{ if } \textit{otherwise}, p_1 - \text{Int}(a) \text{ if true} \rangle \Rightarrow N_2).
\end{aligned}$$

Thus, we derive the same rules as in Example 3.2.

5.2 Properties of the rule notation

In this section we show properties of the notation. First, we show that the translation T_R is a function if T_R does not fail, thus we have the same result for the same rule notation.

Lemma 5.3. *Let Rule be a string accepted by the rule notation, and let $T_R[\text{Rule}]$ not fail. If during expansions of $T_R[\text{Rule}]$ to rules, the followings occur for the same conditional NAP $\langle P_{if} \rangle$, then S_1 and S_2 are the same spray:*

- $T_S[\langle P_{if} \rangle, S_1]$,
- $T_S[\langle P_{if} \rangle, S_2]$.

Proof. By structural induction on the conditional NAPs $\langle P_{if} \rangle$. □

From now on, we will only consider the case where the translation T_R does not fail. By Lemma 5.3, we can show the property more precisely:

Lemma 5.4. *Let Rule be a string accepted by the rule notation. If during expansions of $T_R[\text{Rule}]$ to rules, the followings occur for the same conditional NAP $\langle P_{if} \rangle$, then y_1 and y_2 are the same:*

- $T_S[\langle P_{if}, y_1 - \gamma_1(\vec{w}_1) \text{ if } c_1 \rangle, S_1]$,

- $T_S[\langle P_{if}, y_2 - \gamma_2(\vec{w}_2) \text{ if } c_2 \rangle, S_2]$.

In addition, when $\gamma_1(\vec{w}_1)$ and $\gamma_2(\vec{w}_2)$ are the same, c_1 and c_2 are not overlapped.

Proof. By the definition of T_S , $T_S[\langle P_{if}, y_1 - \gamma_1(\vec{w}_1) \text{ if } c_1 \rangle, S_1]$ and $T_S[\langle P_{if}, y_2 - \gamma_2(\vec{w}_2) \text{ if } c_2 \rangle, S_2]$ are directly derived from $T_S[\langle P_{if} \rangle, S'_1]$ and $T_S[\langle P_{if} \rangle, S'_2]$ for some S'_1 and S'_2 , respectively. By Lemma 5.3, $S'_1 = S'_2$, and therefore this lemma holds. \square

Here we form a set whose elements are conditional NAPs that appear during expansions of T_R to rules, and show that the set is sequential.

Definition 5.5. For conditional NAPs $\langle P_{if} \rangle$ and $\langle P_{if}, \vec{u} \rangle$ for any sequence of connections \vec{u} (which may be empty), we write $\langle P_{if} \rangle \subseteq \langle P_{if}, \vec{u} \rangle$. We use $\text{AllSub}(\langle P_{if} \rangle)$ as a set $\{P'_{if} \mid P'_{if} \subseteq P_{if}\}$.

Example 5.6. The followings are the results of applying AllSub to rules obtained in Example 5.2:

- Elements of $\text{AllSub}(\langle \text{gcd}(r) \bowtie \text{Pair}(p_1, p_2) \text{ if true}, p_2 - \text{Int}(b) \text{ if } b=0 \rangle)$:
 - $\langle \text{gcd}(r) \bowtie \text{Pair}(p_1, p_2) \text{ if true} \rangle$,
 - $\langle \text{gcd}(r) \bowtie \text{Pair}(p_1, p_2) \text{ if true}, p_2 - \text{Int}(b) \text{ if } b=0 \rangle$.
- Elements of $\text{AllSub}(\langle \text{gcd}(r) \bowtie \text{Pair}(p_1, p_2) \text{ if true}, p_2 - \text{Int}(b) \text{ if otherwise}, p_1 - \text{Int}(a) \text{ if true} \rangle)$:
 - $\langle \text{gcd}(r) \bowtie \text{Pair}(p_1, p_2) \text{ if true} \rangle$,
 - $\langle \text{gcd}(r) \bowtie \text{Pair}(p_1, p_2) \text{ if true}, p_2 - \text{Int}(b) \text{ if otherwise} \rangle$,
 - $\langle \text{gcd}(r) \bowtie \text{Pair}(p_1, p_2) \text{ if true}, p_2 - \text{Int}(b) \text{ if otherwise}, p_1 - \text{Int}(a) \text{ if true} \rangle$.

Proposition 5.7. Let Rule be a string accepted by the rule notation. When we obtain rules $(\langle P_{if_1} \rangle \Rightarrow N_1), \dots, (\langle P_{if_m} \rangle \Rightarrow N_m)$ from $T_R[\text{Rule}]$, then $\text{AllSub}(\langle P_{if_1} \rangle) \cup \dots \cup \text{AllSub}(\langle P_{if_m} \rangle)$ is sequential.

Proof. We examine whether the set $\mathcal{A} = \text{AllSub}(\langle P_{if_1} \rangle) \cup \dots \cup \text{AllSub}(\langle P_{if_m} \rangle)$ satisfies sequentiality conditions in Definition 3.4.

First, we check the condition (1a). Each $\langle P_{if_i} \rangle$ is obtained from the same rule notation Rule by using the translation of T_R . Therefore, when $\langle \alpha(\vec{x}) \bowtie \beta(\vec{y}) \text{ if } c_1 \rangle, \langle \alpha(\vec{x}) \bowtie \beta(\vec{y}) \text{ if } c_2 \rangle \in \mathcal{A}$, c_1 and c_2 are disjoint, by the definition of T_R .

Next, we verify conditions in (2). We suppose that $(\langle \alpha(\vec{x}) \bowtie \beta(\vec{y}) \text{ if } c, u_1, u_2, \dots, u_n \rangle \Rightarrow N)$ is derived from $T_R[\text{Rule}]$. All elements of $\text{AllSub}(\langle \alpha(\vec{x}) \bowtie \beta(\vec{y}) \text{ if } c, u_1, u_2, \dots, u_n \rangle)$ are related by \subseteq as follows:

$$\langle \alpha(\vec{x}) \bowtie \beta(\vec{y}) \text{ if } c \rangle \subseteq \langle \alpha(\vec{x}) \bowtie \beta(\vec{y}) \text{ if } c, u_1 \rangle \subseteq \dots \subseteq \langle \alpha(\vec{x}) \bowtie \beta(\vec{y}) \text{ if } c, u_1, u_2, \dots, u_n \rangle.$$

By the definition of T_R , for each two elements such that $\langle P_{if} \rangle \subseteq \langle P_{if}, u \rangle$ in the AllSub , there is the following expansion:

$$T_S[\langle P_{if} \rangle, S] = \dots, T_S[\langle P_{if}, u \rangle, S'], \dots$$

Thus every element must occur as the first argument of T_S during the applications of T_R . Therefore, by Lemma 5.4, each $\text{AllSub}(\langle P_{if_i} \rangle)$ satisfies (2a) and (2c). (2b) also is satisfied by the definition of AllSub . $\text{AllSub}(\langle P_{if_i} \rangle)$ and $\text{AllSub}(\langle P_{if_j} \rangle)$ are disjoint because these are derived for the same Rule by $T_R[\text{Rule}]$. Therefore, \mathcal{A} also satisfies all these conditions. \square

We suppose that \mathcal{R}_{if} is a rule set whose elements are obtained from the same rule notation Rule by using $T_R[\text{Rule}]$. Rules in \mathcal{R}_{if} do not have any overlapped conditions, and thus there are not any rules $(\langle P_{if} \rangle \Rightarrow N)$ such that the $\langle P_{if} \rangle$ is a subnet of $\langle P'_{if} \rangle$ for other rules $(\langle P'_{if} \rangle \Rightarrow N')$ in \mathcal{R}_{if} . Therefore, as long as we use the rule notation, the rule set derived from \mathcal{R}_{if} will be pairwise distinct.

Proposition 5.8. Let Rule be a string accepted by the rule notation, and \mathcal{R}_{if} a set whose elements are obtained from $T_R[\text{Rule}]$. Then, \mathcal{R}_{if} is pairwise distinct. \square

6 Discussion

Implementation: Using rules on conditional NAPs allows us to write algorithms naturally and reduces the number of reduction steps in comparison with using non-nested ones. However, when it comes to the implementation of these rules, we need an efficient matching mechanism so that the rule application waits until each nested agent is connected to all its ports and avoids repeatedly checking that these connections have been made. This method can be realised by the T translation, since it ensures that the nested agents are connected. Given this, the matching can then be performed by the net evaluator. Another advantage of using the T translation is that it is then possible to perform some rule optimisation, by combining rules. For instance, we take the translated rules in Example 4.2. The RHS of the rule $\text{gcd_Pair_tt_ot}(b) \bowtie \text{Int}(a)$ has an agent pair $\text{gcd} \bowtie \text{Pair}$. Thus, by applying a rule for $\text{gcd} \bowtie \text{Pair}$ to the RHS, we can have a one-step reduced optimisation rule as follows:

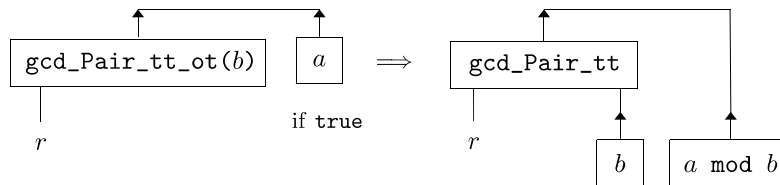

Therefore we can say that by using the translation T, conditional NAPs can be realised, taking advantage of the expressiveness of the case notation and the already implemented evaluator such as Inpla [12]¹.

Related work: It is also possible to realise nested pattern matching for pure interaction nets by using other approaches [1, 13] where agents are allowed to have more than one principal port. However, there are some limitations, as discussed in [4]. For example, there is no natural way to express the function `lastElt`, which returns the last element of a list. The last element of a list $[x]$ is matched by using a pattern, which is the LHS of a rule, with `Cons` agent having two principal ports and `Nil` agent. However, to keep the one-step confluence, the patterns must be such that every principal port is connected to the principal port of another agent. Thus, because two principal ports of `Cons` cannot be free, we need to have every pattern for lists such as $[y_1, x]$, $[y_1, y_2, x]$, \dots

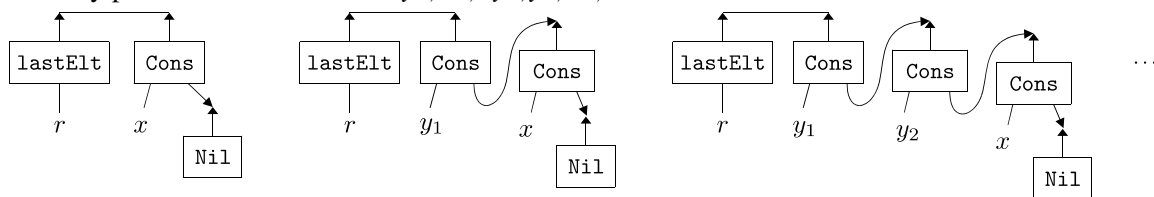

7 Conclusion

In this paper we introduced conditional nested pattern matching as an extension of [4], and showed that as long as a rule set is pairwise distinct, the rewritings can continue to be one-step confluent. This not only allows programs to be more easily written in interaction net form, but also allows the execution to be performed by existing evaluators. Most well-known algorithms contain computations of conditional nested pattern matching, and these can now be realised in interaction nets. We expect this will contribute to finding new ways of implementing such algorithms, taking advantage of the benefits of interaction nets, such as built-in parallelism and internal garbage collection.

¹An up-to-date implementation is available from <https://github.com/inpla/inpla>

References

- [1] Denis Béchet (1992): *Partial Evaluation of Interaction Nets*. In: *Actes WSA'92 Workshop on Static Analysis, Series Bigre 81-82*, Atelier IriSa, IRISA, Campus de Beaulieu, pp. 331–338.
- [2] M. Fernández, I. Mackie & J. Sousa Pinto (2001): *Combining interaction nets with externally defined programs*. In: *Electronic proceedings of the APPIA-GULP-PRODE Joint Conference on Declarative Programming*, pp. 297–312. Available at <http://hdl.handle.net/1822/776>.
- [3] G. Gonthier, M. Abadi & J.-J. Lévy (1992): *The Geometry of Optimal Lambda Reduction*. In: *Proceedings of the 19th ACM Symposium on Principles of Programming Languages (POPL'92)*, ACM Press, pp. 15–26, doi:10.1145/143165.143172.
- [4] Abubakar Hassan & Shinya Sato (2007): *Interaction Nets With Nested Pattern Matching*. In: *Proceedings of the Fourth International Workshop on Computing with Terms and Graphs, TERMGRAPH 2007, Electronic Notes in Theoretical Computer Science 203*, Elsevier, pp. 79–92, doi:10.1016/J.ENTCS.2008.03.035.
- [5] J. R. Kennaway (1988): *Implementing term rewrite languages in Dactl*. In M. Dauchet & M. Nivat, editors: *CAAP '88*, Springer Berlin Heidelberg, Berlin, Heidelberg, pp. 102–116, doi:10.1007/BFb0026099.
- [6] Y. Lafont (1990): *Interaction Nets*. In: *Proceedings of the 17th ACM Symposium on Principles of Programming Languages (POPL'90)*, ACM Press, pp. 95–108, doi:10.1145/96709.96718.
- [7] J. Lamping (1990): *An Algorithm for Optimal Lambda Calculus Reduction*. In: *Proceedings of the 17th ACM Symposium on Principles of Programming Languages (POPL'90)*, ACM Press, pp. 16–30, doi:10.1145/96709.96711.
- [8] I. Mackie (1998): *YALE: Yet Another Lambda Evaluator Based on Interaction Nets*. In: *Proceedings of the 3rd ACM SIGPLAN International Conference on Functional Programming (ICFP'98)*, ACM Press, pp. 117–128, doi:10.1145/291251.289434.
- [9] I. Mackie & S. Sato (2015): *Parallel Evaluation of Interaction Nets: Case Studies and Experiments*. *Electronic Communications of the EASST 73*, doi:10.14279/tuj.eceasst.73.1034.
- [10] Simon Marlow et al. (2010): *Haskell 2010 language report*. Available at <https://www.haskell.org/onlinereport/haskell2010/>.
- [11] Gordon D. Plotkin (1977): *LCF Considered as a Programming Language*. *Theoretical Computer Science 5*, pp. 223–255, doi:10.1016/0304-3975(77)90044-5.
- [12] S. Sato (2015): *Design and implementation of a low-level language for interaction nets*. Ph.D. thesis, University of Sussex, UK. Available at <https://hdl.handle.net/10779/uos.23417312.v1>.
- [13] François-Régis Sinot & Ian Mackie (2004): *Macros for Interaction Nets: A Conservative Extension of Interaction Nets*. In: *Proceedings of the 2nd International Workshop on Term Graph Rewriting, TERMGRAPH 2004, Electronic Notes in Theoretical Computer Science 127*, Elsevier, pp. 153–169, doi:10.1016/j.entcs.2005.02.016.