

A Jammer-Mitigating 267 Mb/s 3.78 mm² 583 mW 32×8 Multi-User MIMO Receiver in 22FDX

Florian Bucheli, Oscar Castañeda, Gian Marti, and Christoph Studer

Dept. of Information Technology and Electrical Engineering, ETH Zurich, Switzerland; email: studer@ethz.ch

Abstract

We present the first multi-user (MU) multiple-input multiple-output (MIMO) receiver ASIC that mitigates jamming attacks. The ASIC implements a recent nonlinear algorithm that performs joint jammer mitigation (via spatial filtering) and data detection (using a box prior on the data symbols). Our design supports 8 user equipments (UEs) and 32 basestation (BS) antennas, QPSK and 16-QAM with soft-outputs, and enables the mitigation of single-antenna barrage jammers *and* smart jammers. The fabricated 22 nm FD-SOI ASIC includes preprocessing, has a core area of 3.78 mm², achieves a throughput of 267 Mb/s while consuming 583 mW, and is the only existing design that enables reliable data detection under jamming attacks.

Introduction

Jammer-resistant wireless systems are urgently needed in a world where critical infrastructure increasingly depends on wireless communications. MIMO technology enables jammer mitigation through spatial filtering [1]. For the mitigation of smart jammers that only jam certain signal parts (e.g., the pilot or data phase), such spatial filters must rely on nonlinear methods [2]. Moreover, these spatial filters need to be implemented in hardware to support the high throughputs required in modern wireless systems. To this day, however, there are *no* hardware implementations of such jammer-resistant wireless receivers.

We present the first jammer-mitigating MU-MIMO receiver ASIC. Our ASIC implements a variant of the nonlinear algorithm SANDMAN from [2] to enable the mitigation of barrage jammers *and* smart jammers against which linear methods fail. SANDMAN processes the receive data in blocks that consist of multiple pilot and data symbols; see Fig. 1 for the system model. Using a linear estimate of the UEs' channel matrix, SANDMAN approximately solves the non-convex optimization problem outlined in Fig. 2 to estimate and null the jammer subspace, while simultaneously detecting the UE transmit data of the entire block. SANDMAN achieves this by using an iterative algorithm based on projected gradient descent, shown in Fig. 3.

Our ASIC supports a 32 × 8 MU-MIMO system, where 32 is the number of BS antennas and 8 is the number of simultaneously transmitting UEs. The data is processed in blocks of 64 symbols (16 pilot symbols and 48 data symbols). The single-antenna jammer may jam continuously (barrage), or only during the pilot symbols, or only during the data symbols. The ASIC performs channel estimation (CHEST) and produces soft-outputs for the data bits that can be used for decoding. QPSK and 16-QAM are supported as transmit constellations.

Architecture and Operation

Fig. 3 shows the SANDMAN algorithm [2] for single antenna jammers, reorganized into a hardware-efficient schedule. This implementation of SANDMAN involves complex-valued matrix-matrix products (1, 7) and additions/subtractions (1, 6, 8), matrix-vector products (2, 3, 5), and scalar operations (4, 6, 8). To minimize latency, we employ the highly parallel spatial architecture illustrated in Fig. 4. The architecture is mainly composed of a 2D array of 32 × 8 processing elements (PEs), where each PE consists of a highly reconfigurable multiply-accumulate (MAC) unit, a “prox” unit for thresholding, and flip-flop (FF) arrays for local storage. The size of the 2D array was chosen to match that of the channel matrix estimate $\hat{\mathbf{H}}$ to facilitate the computationally demanding matrix multiplications involving $\hat{\mathbf{H}}$ (1) and $\hat{\mathbf{H}}^H$ (7). The 32 × 8 array is divided into four 8 × 8 PE slices connected column-wise. Each PE slice enables (through circular shifting of the input values) the application of Cannon's algorithm for multiplication

by an 8 × 8 matrix and subsequently by its Hermitian, without having to explicitly transpose the matrix in memory. Matrix multiplications involving larger outer dimensions (as in 1, 7) are executed and stored in 8 × 8-sized blocks. To engage all PEs simultaneously when computing matrix-vector products (2, 3, 5), entries can be broadcasted to a whole column or row. Since these matrix-vector products have an inner dimension larger than 8, the partial sums of the 8 × 8 PE slices need to be summed up row- or column-wise. For this, we support the reconfiguration of PEs on a row/column into row/column adders (see bottom of Fig. 4). Jammer renormalization (4) requires high numerical precision due to the jammer's large dynamic range. To preserve energy efficiency, we use a specialized set of extended PEs (PE+) with larger bitwidths for this step. The renormalization also uses a look-up-table-based inverse square root unit. We implement the pseudorandom vector \mathbf{x} (2) with a circular shift register. After $t_{\max} = 10$ algorithm iterations, a soft-output/LLR unit converts the two dimensions of a complex-valued scalar symbol estimate into two/four LLRs. These LLRs correspond to the two/four bits of a Gray-mapped QPSK/16-QAM constellation with a box size of $1/\sqrt{2}$. The resulting LLRs are stored in the S FF array (see Fig. 4). Fig. 6 shows how the PEs are configured at the start of each operation (1–8) and which hardware elements are used in that operation.

Results and Conclusion

Fig. 5 shows the bit error-rate (BER) vs. SNR performance of different jammers and different constellations for the hardware implementation of SANDMAN compared to linear minimum-mean squared-error (LMMSE), channel hardening-exploiting message passing (CHEMP) [3], and approximate message passing (LAMA) [4]. All jammers in Fig. 5 transmit at 30 dB higher receive power than the average UE. SANDMAN significantly outperforms the other receivers for all jammers/constellations since it is the only implemented MU-MIMO receiver that can mitigate jammers (and in particular, smart jammers). The fixed-point performance of the SANDMAN ASIC follows closely the performance of double-precision floating point (see Fig. 5).

Fig. 7 shows a micrograph of the ASIC fabricated in 22 nm FD-SOI with the main blocks highlighted. The core occupies 3.78 mm² of a total chip area of 5 mm². Fig. 8 shows voltage-frequency scaling results for different body biases. As expected, the maximum clock frequency increases with the core supply, until at some point it drops rapidly due to signal integrity issues related to the used QFN56 package. At 0.78 V core supply, zero body biasing, 300 K, 16-QAM and $t_{\max} = 10$ algorithm iterations, the ASIC reaches a clock frequency of 320 MHz and a throughput of 267 Mb/s while consuming 583 mW.

Table I compares our ASIC to state-of-the-art MU-MIMO detectors. Our design is the only one that enables data detection under jamming attacks; all other designs would completely fail in that scenario, see Fig. 5. This jammer resilience comes at the cost of lower throughput and efficiency, a price worth paying in mission-critical applications where a robust link is paramount.

Acknowledgments

The authors would like to thank GlobalFoundries for providing silicon fabrication through the 22FDX university program.

References

- [1] H. Pirayesh and H. Zeng, *IEEE Commun. Surveys Tuts.*, 2022.
- [2] G. Marti and C. Studer, *IEEE Int. Conf. Commun. (ICC)*, 2023.
- [3] T. L. Narasimhan *et al.*, *IEEE J. Sel. Topics. Signal Process.*, 2014.
- [4] J. Jeon *et al.*, *IEEE Solid-State Circuit Lett.*, 2019.
- [5] W. Tang *et al.*, *IEEE J. Solid-State Circuits*, 2021.
- [6] H. Prabhu *et al.*, *IEEE Int. Solid-State Circ. Conf. (ISSCC)*, 2017.

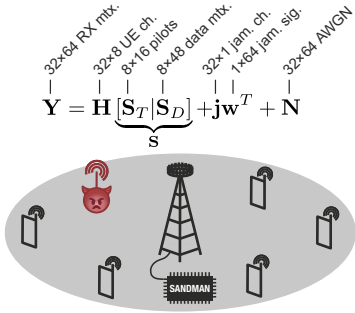

Fig. 1. System model of the jammed multi-user (MU) MIMO uplink.

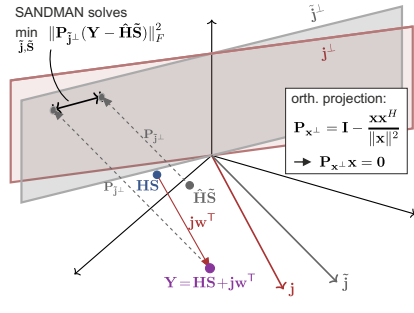

Fig. 2. SANDMAN approximately solves a non-convex optimization problem.

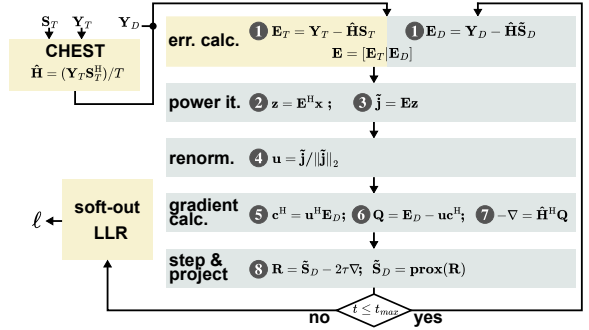

Fig. 3. Outline of the SANDMAN algorithm, which runs for t_{\max} iterations. Steps only executed once are in yellow.

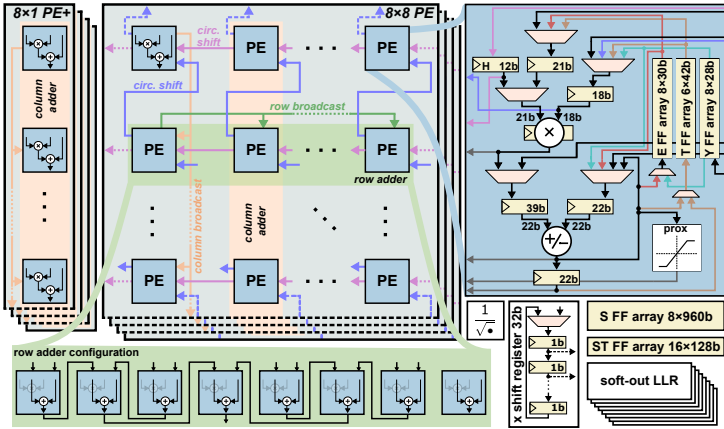

Fig. 4. Overview of the SANDMAN architecture and implementation details of the processing elements (PEs). The control module is not shown. Rows and columns of PEs can be reconfigured into row adders and column adders.

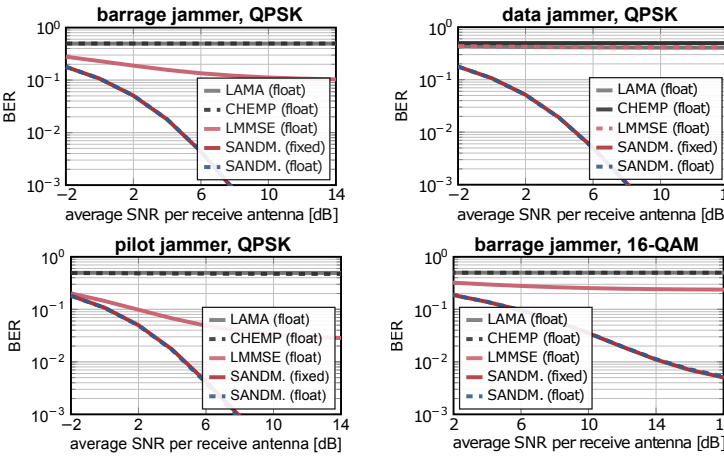

Fig. 5. Performance for 32×8 MIMO with different jammers/constellations.

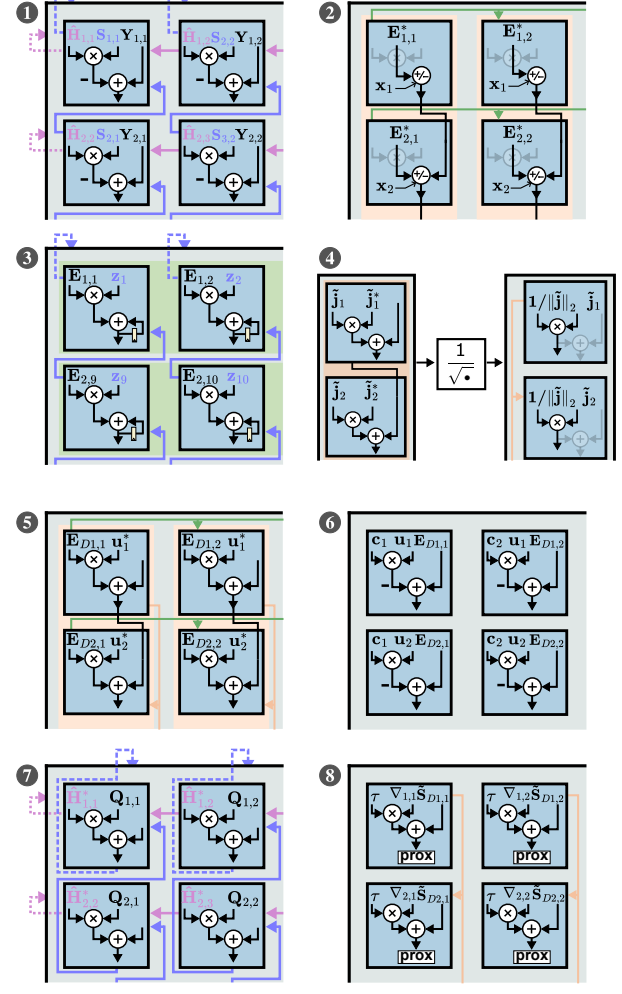

Fig. 6. Different configurations of the PE array used to execute the operations in Fig. 3; operation 4 relies on the PE+ array.

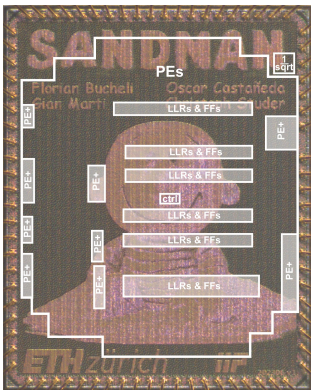

Fig. 7. Chip micrograph with highlighted modules.

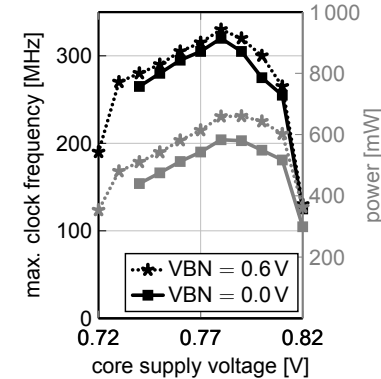

Fig. 8. Measured frequency (black) and power (gray) vs. core and body voltages.

TABLE I
Measurement results and ASIC comparison

	This work	Jeon [4]	Tang [5]	Prabhu [6]
Max. BS antennas	32	256	128	128
Max. UEs	8	32	32	8
Modulation [QAM]	16	256	256	256
Soft-outputs	yes	yes	yes	no
Algorithm	SANDMAN	LAMA	CHEMP	LMMSE
CHEST & preproc. incl.	yes	no	no	yes
Jammer mitigation	yes	no	no	no
Technology [nm]	22	28	40	28
Core supply [V]	0.78	0.9	0.9	0.9
Core area [mm ²]	3.78	0.37	0.58	—
Max. frequency [MHz]	320	400	425	300
Power [mW]	583	151	221	18
Throughput [Mb/s]	267	354	2760	300
Area eff. ^a [Mb/s/mm ²]	70	1974	28602	—
Energy ^a [pJ/b]	2187	252	33	35

^aTechnology normalized to 22 nm and 0.78 V core supply.