

Measurement and Control of Solenoid Stroke using Its Electrical Characteristics

Junichi Akita^{*a)} Non-member

In this paper, we describe the algorithm to measure the stroke of solenoid using the electric characteristics of the solenoid, without mechanical attachments. We also describe the experimental results of controlling the solenoid stroke at intermediate position.

Keywords: Solenoid, Inductance, Stroke Measurement, Stroke Control



Fig. 1. Solenoid (Takaha's CBS07300580)

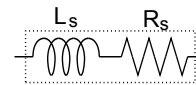

Fig. 2. Equivalent circuit of solenoid

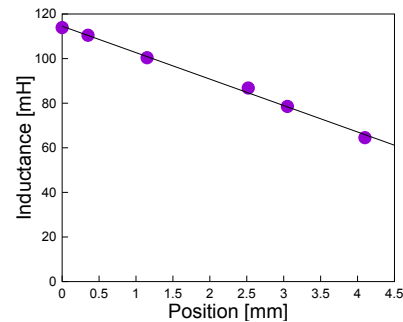

Fig. 3. Measured inductance and plunger position

1. Introduction

Solenoid is the actuator composed of the coil and the plunger. Solenoid is used to push or pull the object, and the stroke is controlled in two states; ON and OFF, in usual cases. There are also some researches to control the solenoid stroke at intermediate positions between ON and OFF positions, by controlling the current of the coil to keep the target position of the plunger, where plunger position is measured by external mechanical sensor⁽¹⁾.

From the viewpoint of electrical characteristics of the solenoid, its inductance changes according to the plunger position, and we basically measure the plunger position with electrical characteristics of the solenoid⁽²⁾⁽³⁾. Thus, we can measure and control the solenoid's plunger position without mechanical attachments. In this paper, we describe the theoretical and experimental analysis of the solenoid's electrical characteristics, and measuring algorithm of the plunger's position. We also describe the experimental results of the plunger's position control without mechanical attachments.

2. Electrical Characteristics of Solenoid and Its Driving Circuit

Solenoid is the actuator composed of the coil and the plunger, as shown in Fig.2. From the viewpoint of electrical characteristics of the solenoid, it is a simple inductor, whose equivalent electrical circuit is described as shown in Fig.2.

a) Correspondence to: akita@is.t.kanazawa-u.ac.jp
 * Kanazawa University
 Kakuma, Kanazawa, 920-1192 Japan

The plunger in the solenoid is a magnetic material, and it affects the inductance of solenoid, and the position of the plunger also affects the inductance of the solenoid. Figure 3 shows the measured inductance against the position of the plunger for the solenoid of Takaha's CBS07300580⁽⁴⁾ at the frequency of 100[Hz], with LCR meter (????). We can derive the position of the plunger, x_P , as follows.

$$x_P = -0.0843L + 9.656 \dots \dots \dots (1)$$

Thus, we can measure the position of the plunger by measuring the inductance of the solenoid.

The typical driving circuit of the solenoid is shown in Fig.4. Here we define two status of the drive.

- ON: giving a high voltage to G (gate) to turn the nMOSFET on, where the current flows to make the plunger pulled.
- OFF: giving a low voltage to G to turn the nMOSFET off, where the current stops to make the plunger released.

The transitional phenomenon occurs between switching OFF-to-ON and ON-to-OFF.

At OFF-to-ON transition, the current from the power source gradually increase by the back electromotive force of the inductor, who speed is determined by the time constant of the L_s/R_s , as shown in Fig.ref:OFF-to-ON. The current of OFF-

arXiv:2405.11721v1 [eess.SY] 20 May 2024

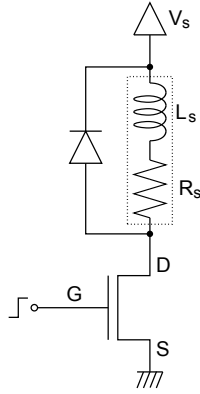

Fig. 4. Driving circuit of solenoid

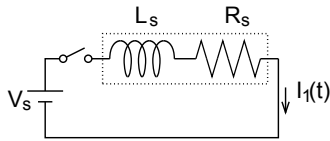

Fig. 5. Equivalent Circuit for OFF-to-ON transition

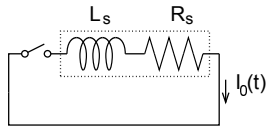

Fig. 6. Equivalent Circuit for ON-to-OFF transition

to-ON transition, $I_1(t)$, the circuit equations is follows.

$$L_s \frac{dI_1(t)}{dt} + R_s I_1(t) = V_s$$

We obtain $I_1(t)$ as follows, with the initial current of $I_1(0) = I_1^S$.

$$I_1(t) = \frac{V_s}{R_s} - \left(\frac{V_s}{R_s} - I_1^S \right) \exp(-R_s/L_s t) \dots \dots \dots (2)$$

At ON-to-OFF transition, the current from the power source stops, and the current gradually decrease by the closed loop by the flywheel diode, as shown in Fig.6. The current of ON-to-OFF transition, $I_0(t)$, the circuit equations as follows, with assuming the flywheel diode to be a ideal diode, whose equivalent resistance is zero.

$$L_s \frac{dI_0(t)}{dt} + R_s I_0(t) = 0$$

We obtain $I_0(t)$ as follows, with the initial current of $I_0(0) = I_0^S$.

$$I_0(t) = I_0^E \exp(-R_s/L_s t)$$

3. Measurement Method of Solenoid Inductance: ON-to-OFF transition

At ON-to-OFF transition, the voltage at D (drain) of the nMOSFET, V_{DS} changes from almost zero (ON reistance of nMOSFET) to $V_s + V_F$, where V_D is the forward voltage of the flywheel diode during the charged energy in the inductor remains. After the charged energy consumed, the V_{DS} goes V_s . Figure 7 shows the calculated waveform of V_{DS} by LTspice, for the circuit of Fig.8, with three variations of the

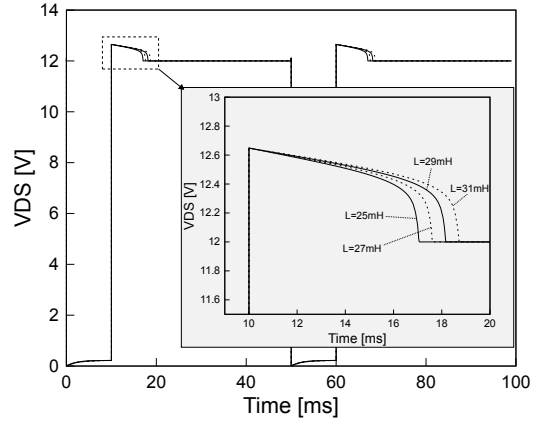
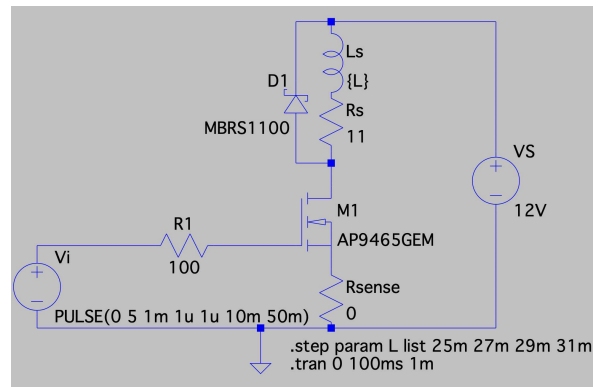

 Fig. 7. Simulated waveforms V_{DS} for ON-to-OFF transition

Fig. 8. Simulation circuit for ON-to-OFF transition

inductance. The time of V_{DS} goes from $V_s + V_F$ to V_s is proportional to the inductance, hence the position of the plunger. However, this time is 10[ms] at least. It means that we have to make the solenoid OFF at least 10[ms], which makes the plunger at the released state. The mechanical time constant of the plunger is defined by the mechanical structure of the solenoid, which is at the order of 10[ms]. It is impossible to keep the plunger at ON or the intermediate position between ON and OFF with having this “measurement” period of the ON-to-OFF transition.

4. Measurement Method of Solenoid Inductance: OFF-to-ON transition

At OFF-to-ON transition, the current of the nMOSFETf at S (source) or D changes as $I_1(t)$ in Eq.(2). From the viewpoint of controlling the solenoid stroke, the duty ratio of PWM (pulse width modulation) signal at nMOSFET’s G is 0[%] to 100[%], and the small duty ratio, such as 5[%] makes no effect to make the pull operation for the plunger. We can measure the inductance by the transitional phenomenon at OFF-to-ON transition, with controlling the position of the plunger by controlling PWM duty ratio.

4.1 Theoretical analysis of PWM drive Under PWM control of the solenoid, OFF state starts at the end status of the previous ON state, and next ON state starts at the end status of the previous OFF state, as shown in Fig.9. Here we define I_1^S and I_1^E as the initial and the final current during ON state, respectively, and I_0^S and I_0^E as the initial and the

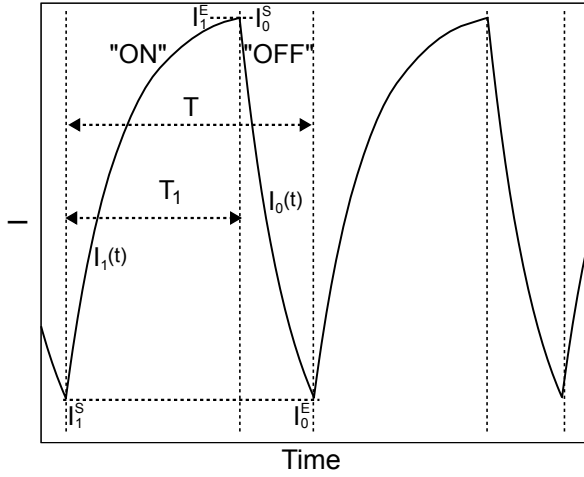

Fig. 9. Current waveform for PWM drive

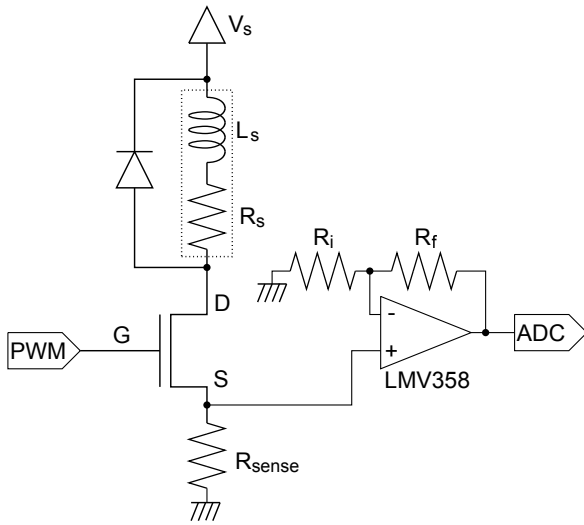

Fig. 10. Circuit of measurement & control experiment

final current during OFF state, respectively. Since the PWM wave is periodical, the initial current of each state equals the final current of previous state, which is expressed as $I_1^S = I_0^E$ and $I_0^S = I_1^E$. We define the cycle and ON time of PWM wave as T and T_1 , respectively. We can calculate the I_1^S and I_0^S as follows from Eqs (2) and (2).

$$I_1^E = I_1(T_1) = \frac{V_s}{R_s} - \left(\frac{V_s}{R_s} - I_1^S \right) \exp(-R_s/L_s T_1)$$

$$I_1^S = I_0(T - T_1) = I_1^E \exp(-R_s/L_s (T - T_1))$$

We finally obtain I_1^E and I_1^S as follows, as the function of R_s , L_s , V_s , T , and T_1 .

$$I_1^E = \frac{1 - \exp(-R_s/L_s T_1)}{1 - \exp(-R_s/L_s T)} \frac{V_s}{R_s}$$

$$I_1^S = I_1^E \exp(-R_s/L_s (T - T_1))$$

We can also calculate the current at any point during ON (and OFF) state by Eqs (2) and (2).

4.2 Experimental results and theoretical results We carried out the experimental measurement of I_1^E and I_1^S , to find the inductance, L_s or the position of the plunger, from the current and PWM ON time. Figure 10 shows the circuit

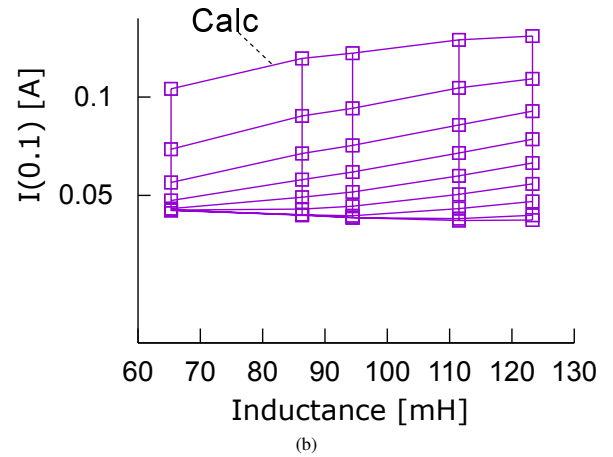
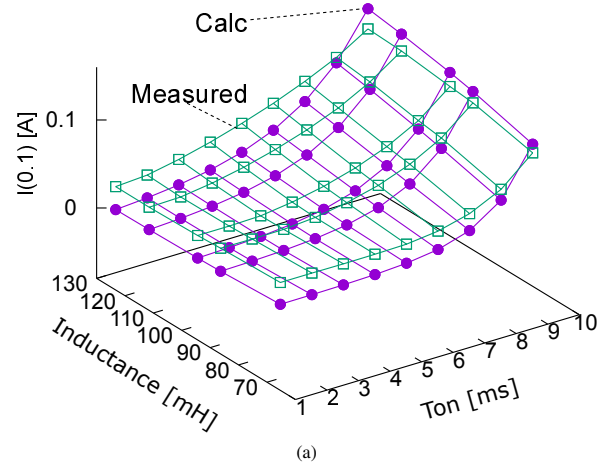
 Fig. 11. Measured current at 0.1[ms], $I_{0.1}$ (a), and its trend against L (b)

of the experimental setup. The current of the nMOSFET during ON state is measured as the voltage of $R_{sense} = 0.2[\Omega]$, which is set small so as not to effect the nMOSFET state. The voltage of R_{sense} is magnified by 101 by the non-inverting amplifier, where R_i and R_f are $1[\text{k}\Omega]$ and $100[\text{k}\Omega]$, respectively.

We used Arduino UNO⁽⁵⁾ for measure and control. PWM signal is generated using Timer1, and fed to nMOSFET's gate. I is measured by internal ADC (10bit) every each PWM cycle at 0.1[ms] and 0.5[ms] after the OFF-to-ON transition, by using Timer1's overflow and compare match interrupt. We set $T = 10[\text{ms}]$ (PWM frequency of 100[Hz]), and measured the currents at T of 0.1[ms] and 0.5[ms], $I_{0.1}(T_1, L_s)$ and $I_{0.5}(T_1, L_s)$, respectively, where T_1 is ON time of PWM waveform and L_s is the inductance of the solenoid.

Figure 11, 12 and 13 shows measured and calculated $I_{0.1}(T_1, L_s)$, $I_{0.5}(T_1, L_s)$, and $I_{0.5}(T_1, L_s) - I_{0.1}(T_1, L_s)$, respectively, for five variations of L_s , and T_1 from 1[ms] to 9[ms] with step of 1[ms].

Since the calculated currents by Eqs (2) and (2) assumes the ideal flywheel diode, we can see the difference to the measured current, especially for large T_1 , where the charged energy at the inductor is large.

From Fig.11 and Fig.12, the changes of the current at 0.1[ms] and 0.5[ms] over L_s becomes almost flat for some T_1 . This means that we can't determine L_s from the measured current at each point.

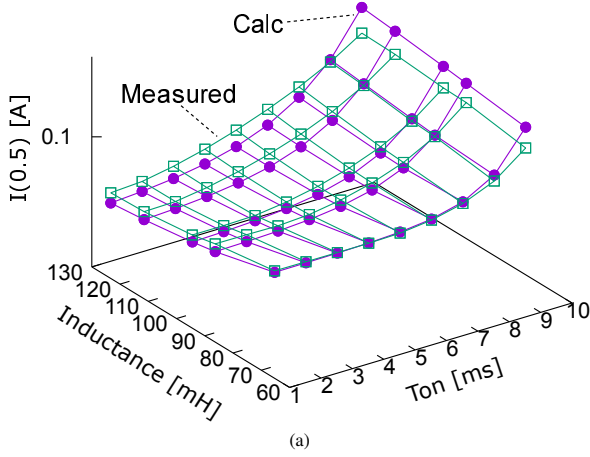

(a)

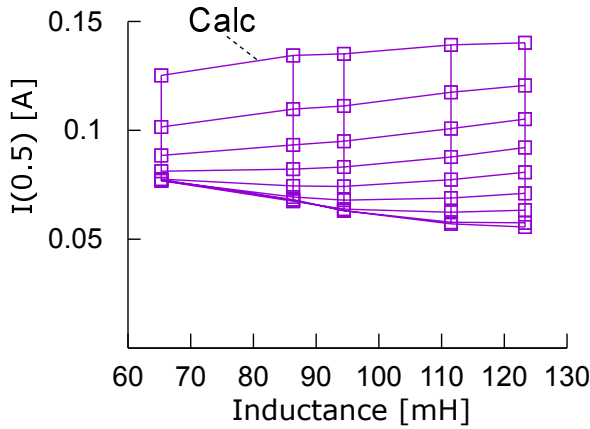

(b)

 Fig. 12. Measured current at 0.1[ms], $I_{0.5}$ (a), and its trend against L (b)

From Fig.13, the current changes as L_s changes. This means that we can determine L_s from the measured current at each point, with the control value of T_1 .

4.3 Interpolating inductance Since these phenomena are non-linear, we can't analytically derive the currents for given L_s and T_1 . For the practical applications, we can generate the table of the measured current, $I = I_{0.5} - I_{0.1}$ for variations of L_s and T_1 in advance. Here we assume T_1 and L_s changes independently, and obtain the measured current for each T_1 and L_s , $I(T_1, L_s)$, as shown in Fig.14.

We assume that we can set T_1 as a control parameter. The purpose of this measurement is to calculate L_s from the measured I and the controlled T_1 from $I(T_1, L_s)$.

Here, set (controlled) T_1 exists in the range of (T_1^0, T_1^1) , where T_1^0 and T_1^1 are in the table of $I(T_1, L_s)$. We can also find the pair of I in the table of $I(T_1, L_s)$ which covers the measured value of I . Thus, we can define the following four points, (T_1^0, I_{00}) , (T_1^1, I_{10}) , (T_1^0, I_{01}) and (T_1^1, I_{11}) , which covers the point of (T_1, I) , as shown in Fig.15. Each point has the value of L_s from the table of $I(T_1, L_s)$, as described as L_{00} , L_{10} , L_{01} , and L_{11} , respectively. The problem to solve is to calculate L_s from these four points for measured I and controlled T_1 . By using the bilinear interpolation, we obtain the interpolation parameter t and s and the interpolated I in Fig.15 as follows.

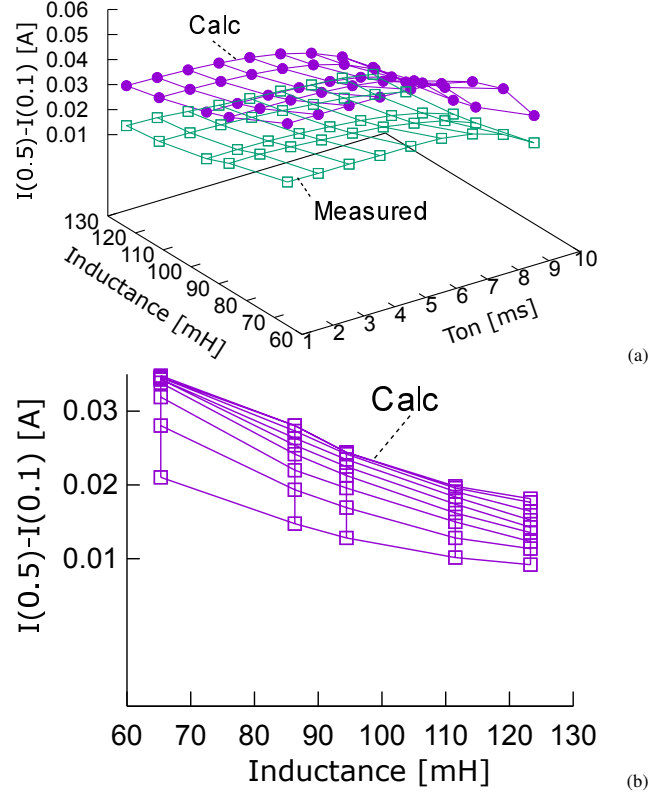
 Fig. 13. Measured current difference, $I_{0.5} - I_{0.1}$ (a), and its trend against L (b)

$L_s \backslash T_1$	T_1	T_2	T_3	...
L1	I11	I21	I31	
L2	I12	I22	I32	
L3	I13	I23	I33	
⋮				

 Fig. 14. Table of current I for T_{ON} and inductance L_s

Fig. 15. Interpolation algorithm

$$t = \frac{T_1 - T_1^0}{T_1^1 - T_1^0}$$

$$I_{x0} = I_{00} + t(I_{10} - I_{00})$$

$$I_{x1} = I_{01} + t(I_{11} - I_{01})$$

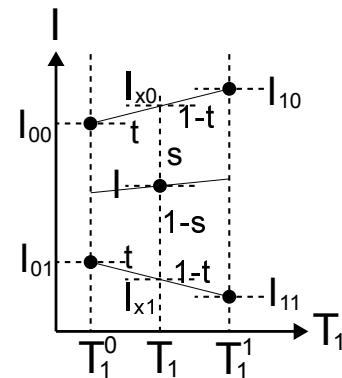
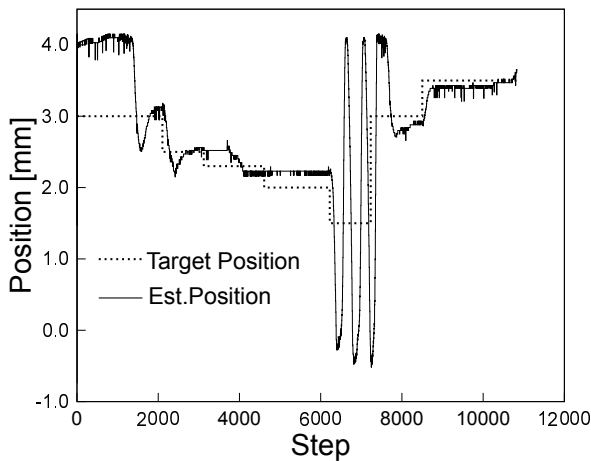

Fig. 16. Experimental result of solenoid position control

$$L_{x0} = L_{00} + t(L_{10} - L_{00})$$

$$L_{x1} = L_{01} + t(L_{11} - L_{01})$$

$$s = \frac{I - I_{x0}}{I_{x1} - I_{x0}}$$

Finally, we obtain the interpolated value of the inductance, \hat{L} from the measured I and the controlled T_1 as follows.

$$\hat{L} = L_{x0} + s(L_{x1} - L_{x0})$$

We can calculate the position of the plunger, x_P , by Eq.(1) as follows.

$$x_P = -0.0843\hat{L} + +9.656$$

5. Control of Solenoid Stroke using Electrical Characteristics

We carried out the experiment of controlling the solenoid stroke based on the calculated position of the plunger, x_P from the measured I and controlled T_1 . We used Arduino UNO as in section sec:exp. The x_P is measured at `loop()` function from the measured I , and the PWM duty, next step's T_1 , T_1' is calculated as follows based on simple PID control, with the target position of i

$$T_1' = T_1 + K_i(x_P - x_T)$$

We set the PID gain of K_i as 4.0 from some experimental trials. Figure 16 shows the measured (calculated) position of the plunger, with the target position of the plunger, where t is the number of steps of control loop. We can find some overshoots at the target position change of around $t = 1800$ and $t = 2200$. We can also find an oscillation between around $t = 6200$ and $t = 7500$, where the target position is close to the “pulled” state of the plunger. Solenoid itself has the mechanical characteristics that the plunger is rapidly ‘pulled’ at close position of “pulled” state, and it affects the PID control gains, and makes the position control more sensitive.

6. Conclusion and Future Works

In this paper, we described the algorithm to measure the stroke of solenoid using the electric characteristics of the solenoid, without mechanical attachments. We also indicated

that this measurement algorithm can be used with conjunction of the stroke PWM control, and demonstrated the experimental results of controlling the solenoid stroke at intermediate position.

The precise measurement of the inductance and the positions the plunger, as well as the current for each position of the plunger, will be our future works to realize more accurate and stable measurement and control of the solenoid stroke. The precise evaluation of the calculated position of the plunger against the measured one are also reported in our future works.

The temperature dependency of the inductance and the resistance are also the parameters to consider, and will be discussed in our future works.

References

- (1) P.Mahajan, P.Kalkundri and A.Sultana Shaikh, “Precision Actuator Control for on/off Type Solenoid Valves using Pid Control Loop,” 2019 IEEE 5th International Conference for Convergence in Technology (I2CT), pp.1-4, doi: 10.1109/I2CT45611.2019.9033834, 2019.
- (2) K.Harmer, G.W.Jewell and D.Howe, “Transient performance of a short-stroke linear solenoid actuator,” IEE Proceedings - Electric Power Applications, Vol.149, No.5, pp.379–384, doi: 10.1049/ip-epa:20020472, 2002.
- (3) M.Ruderman and A.Gadyuchko, “Phenomenological modeling and measurement of proportional solenoid with stroke-dependent magnetic hysteresis characteristics,” 2013 IEEE International Conference on Mechatronics (ICM), pp.180-185, doi: 10.1109/ICMECH.2013.6518532, 2013.
- (4) <https://www.takaha-japan.com/product/cbs0730/>
- (5) <https://arduino.cc/>

Junichi Akita (Non-member) He received B.S., M.S. and Ph.D. degrees in electronics engineering from the University of Tokyo, Japan in 1993, 1995 and 1998 respectively. He joined the Department of Computer and Electrical Engineering, Kanazawa University as a research associate in 1998. He moved to the Department of Media Architecture, Future University Hakodate as an assistant professor in 2000. He moved to the Department of Information and Systems Engineering, Kanazawa University as an assistant professor in 2004. From 2022, he is a professor at School of Transdisciplinary Science for Innovation, Kanazawa University. He is also interested in electronics systems including VLSI systems in the applications of human-machine interaction and human interface. He is a member of the Institute of Electronics, Information and Communication Engineers of Japan, Information Processing Society of Japan, and the Institute of Image Information and Television Engineering.