

Opinion Dynamics in Social Multiplex Networks with Mono and Bi-directional Interactions in the Presence of Leaders

Amirreza Talebi^a, Sayed Pedram Haeri Boroujeni^b, Abolfazl Razi^c

^a*Department of Integrated Systems Engineering, Ohio State University, Columbus, 43210, OH, USA*
Email: talebi.14@osu.edu

^b*School of Computing, Clemson University, Clemson, 29632, SC, USA*
Email: shaerib@g.clemson.edu

^c*School of Computing, Clemson University, Clemson, 29632, SC, USA*
Email: arazi@clemson.edu

Abstract

We delve into the dynamics of opinions within a multiplex network using coordination games, where agents communicate either in a one-way or two-way interactions, and where a designated leader may be present. By employing graph theory and Markov chains, we illustrate that despite non-positive diagonal elements in transition probability matrices or decomposable layers, opinions generally converge under specific conditions, leading to a consensus. We further scrutinize the convergence rates of opinion dynamics in networks with one-way versus two-way interactions. We find that in networks with a designated leader, opinions converge towards the initial opinion of the leader, whereas in networks without a designated leader, opinions converge to a convex combination of the opinions of agents. Moreover, we emphasize the crucial role of designated leaders in steering opinion convergence within the network. Our experimental findings corroborate that the presence of leaders expedites convergence, with mono-directional interactions exhibiting notably faster convergence rates compared to bidirectional interactions.

Keywords: Network optimization, Multiplex networks, Coordination games, Markov chains, Opinion dynamics, Graph theory.

1. Introduction

1.1. Introduction

Social networks play a crucial role in disseminating various types of information, including (mis)information, rumors, new technologies, and diseases [1]. Extensive research has focused on understanding opinion dynamics in single-layer networks, as evidenced by studies such as [2, 3, 4, 5, 6, 7].

In real-world scenarios, people engage across multiple communication platforms like Twitter, Facebook, Instagram, face-to-face interactions, among others. Each of these platforms can be viewed as a single-layer network or graph, where nodes represent individuals, and edges denote connections with varying weights reflecting the influence one places on the opinions of others. However, studying each isolated network fails to capture the true underlying network, comprised of multiple mono-layer networks and their inter-layer interactions, resulting in a loss of valuable information [8].

Therefore, for a comprehensive understanding of social networks, it is essential to consider their multi-layer nature [8]. Multiplex networks, a subset of multi-layer networks, are characterized by nodes existing in multiple layers concurrently [9].

The dynamics of opinions within multi-layer networks can be viewed as coordination games. In this context, agents seek to optimize their payoffs, defined as minimizing the deviation from their opinions, by strategically selecting the best responses. The exploration of coordination games on single-layer networks is well-documented in the literature, as seen in [1, 4, 10]. Additionally, research has delved into coordination games on multi-layer networks, as evidenced by studies like [11, 12, 13], with a comprehensive literature review available in [9, p. 70].

These problems are also intricately linked to consensus problems where the agents need to agree on a common decision (opinion in this paper) with a rich body of literature such as [3, 14, 7, 15, 16].

Furthermore, certain studies have delved into the notion of on and off layers within multi-layer networks, where specific layers are active during certain time steps while others remain inactive, as demonstrated in [17, 18].

In our paper, we formulated a model for coordination games on a two-layer multiplex network, incorporating the on and off layers concepts based on models from [4, 17, 18] designed for single-layer networks. We further examined the convergence and convergence rate of the model, considering the mono or bidirectional interactions between agents. This problem exhibits a myriad of applications across diverse fields, including medical networks (e.g., [19, 20]), neural networks (e.g., [21, 22, 23, 24, 25]), meta-heuristic algorithms (e.g., [26, 27, 28, 29, 30]), control theory and reinforcement learning (e.g., [31, 32, 33, 34]), etc.

The remainder of the paper is organized as follows: a comprehensive literature review is presented first. Then, Section 2 introduces the model and preliminaries, followed by Section 3, which offers an analytical analysis of the convergence of the model to the equilibrium. Section 4 explores the convergence rate of the model, section 5 explains the numerical results, and the concluding section summarizes the findings.

1.2. Related Work

In the domain of game-theoretic models, networked-coordination games [1] play a crucial role in elucidating how individuals in online settings become informed about new technologies, opinions, and rumors. While addressing the seeding problem, crucial in viral marketing [10], [1] did not explore the convergence rate of information evolution. This aspect was later addressed by [35] in the context of a single-layer network, noting slow convergence in well-connected networks and faster convergence in smaller networks with poor connectivity. In contrast, [4] presented different results, revealing faster convergence in complete graphs compared to poorly connected graphs like rings.

In the multi-layer context, [11] delved into the dynamics of a coordination game on multiplex networks, highlighting enhanced resilience of cooperative behaviors compared to single-layer settings. Their investigation into a coordination game (prisoner's dilemma) on multiplex networks indicated that the reward for defecting influences cooperative behaviors differently than in single-layer settings. The reference [12] explored the influence of multi-layer networks on opinion diffusion with and without stubborn agents, placing emphasis on strongly connected and closed agent sets leading to opinion convergence. Stubborn agents are those who never or hardly change their opinions.

Consensus problems, dealing with group agreement, have undergone extensive scrutiny [5,

36]. The reference [36] delved into dynamic agent consensus under various assumptions for directed and undirected graphs. The reference [5] demonstrated consensus in a single directed network under network topology switching, provided the union of network topologies forms a spanning tree. References [14] and [7] scrutinized convergence rates of bidirectional equal neighbor models, in which agents in the underlying communication graph put equal weights on their neighboring agents' opinions, and infinite products of type symmetric stochastic matrices with positive diagonals.

In the context of consensus problems, the study often involves products of stochastic matrices, tracing back to the works of [37] and [38]. The reference [39] underscored that achieving consensus necessitates the left-sided product sequence of stochastic matrices to converge to a rank one matrix. Recent work by [40] introduced type-1 and type-2 generalized Sarymsakov matrices, sets of stochastic matrices whose product of compact subsets results in a rank one matrix. Our unique contribution lies in demonstrating the convergence rate of these matrix multiplications under specific circumstances. Our methodology is rooted in a coordination game-based model within the realm of multi-layered networked systems and Markov chains.

In this paper, we are constructing a two-layer multiplex network where agents engage in interactions solely on one layer during odd time steps and on both layers during even time steps. Our findings indicate that consensus will eventually be achieved in the network. It is crucial to note the distinction between the convergence of opinions and consensus – while in consensus, all agents ultimately adopt the same opinion, convergence allows for the possibility that some agents may maintain different opinions.

In our model, we introduce a leader-follower structure, where an agent without influencers but influencing others is deemed a leader, and a follower is an agent influenced by the leader. Furthermore, we explore the convergence rates of networks with mono-directional or bidirectional interactions, both with and without leaders. To our knowledge, the model incorporating these specific elements and assumptions is unprecedented, and there is no well-established body of work studying such settings.

2. Model and Preliminaries

2.1. The multiplex network

We examine the convergence of opinions within a two-layer multiplex network consisting of n agents present on both layers. The multiplex network is denoted as $\mathcal{M} = \{\mathcal{V}, \mathcal{G}\}$, where $\mathcal{V} = \{v_1, \dots, v_n\}$ represents the set of agents, and $v_i \in \mathcal{V}, i \in \mathcal{I} = \{1, \dots, n\}$ denotes agent i . The network's layers are represented by the set of weighted, directed graphs $\mathcal{G} = \{\mathcal{G}_\alpha = (\mathcal{V}, \mathcal{E}_\alpha, \mathcal{W}_\alpha) | \mathcal{E}_\alpha \subseteq \mathcal{V} \times \mathcal{V}, \mathcal{W}_\alpha : \mathcal{E}_\alpha \rightarrow \mathbb{R}_{\geq 0}\}, \forall \alpha \in \{1, 2\}$.

Additionally, the set of neighbors of agent i in layer α is denoted as $\delta_{i\alpha} = \{v_j | (v_j, v_i) \in \mathcal{E}_\alpha, j \in \mathcal{I}\}$, indicating that an edge (v_j, v_i) implies agent i 's opinion is influenced by agent j 's opinion. Thus, the set of neighbors for an agent encompasses all agents influencing the opinion of that specific agent. Moreover, in our model, the interactions between agents can be mono or bi-directional. In the case of mono-directional interactions, an agent's opinion is influenced by its neighbors, but it may not necessarily affect the opinions of its neighbors.

On a layer α , a leader is identified as the agent i for whom $\delta_{i\alpha} = \{v_i\}$, meaning the leader has no neighbors other than itself. It's noteworthy that a leader in one layer may act as a follower in another layer. For example in Figure 1, agent A is the leader on the first layer, perhaps

serving as the administrator of a channel on a social platform, while concurrently acting as a follower on the second layer.

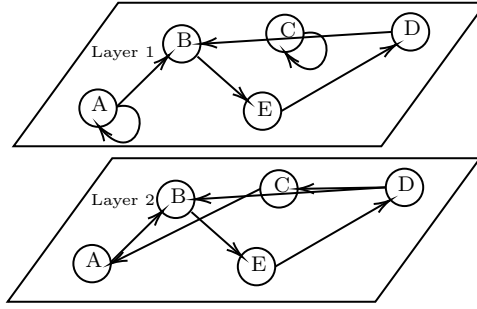

Figure 1: An example of a two-layer multiplex network: Agent A assumes a leadership role on Layer 1 but not on Layer 2. The neighbors of agent B include agents A and D on both layers.

2.2. The adjacency matrices

In this paper, agents participate in interactions over an infinite, discrete time horizon indexed by t . We assume that layer 1 is consistently active, implying continuous influence among agents at every time step. In contrast, layer 2 becomes active exclusively during even time steps, precisely at instances where $t \in \{2, 4, 6, \dots\}$. This modeling decision allows for the depiction of scenarios where an agent frequently communicates with friends, while interactions with their superior occur infrequently. This situation is analogous to cases where network topology experiences temporal changes.

We demonstrate the weighted adjacency matrix \mathcal{A}_α of a single layer α by

$$\mathcal{A}_\alpha = \begin{cases} [\mathcal{A}_\alpha]_{ij} = \frac{1}{|\delta_{i\alpha}|}, & \forall j \in \delta_{i\alpha}, \forall i \in \mathcal{I}, \\ [\mathcal{A}_\alpha]_{ij} = 0, & \forall j \notin \delta_{i\alpha}, \forall i \in \mathcal{I} \end{cases} \quad (1)$$

where $[\mathcal{A}_\alpha]_{ij}$ is the ij^{th} element of matrix \mathcal{A}_α . To clarify, all the neighbors of an agent exert equal influence on the agent's opinion. Additionally, an agent with only a self-loop in the network indicates that the agent is both its own neighbor and a leader, influencing only its own opinion.

The adjacency matrix of the Multiplex network will be defined as follows:

$$A(t) = \begin{cases} \frac{1}{2}(\mathcal{A}_1 + \mathcal{A}_2), & \text{if } t \equiv 0 \pmod{2} \\ \mathcal{A}_1, & \text{Otherwise.} \end{cases} \quad (2)$$

In words, the agent puts equal weight on the importance of both layers when they are both active. Moreover, matrices \mathcal{A}_1 , \mathcal{A}_2 and $A(t)$, are row stochastic matrices i.e., $\sum_j [\mathcal{A}_1]_{ij} = \sum_j [\mathcal{A}_2]_{ij} = \sum_j [A(t)]_{ij} = 1$, $\forall i, t$.

2.3. Agents' opinion dynamics

We represent the opinion of agent i at time step t as $x_i(t) \in [0, 10]$, and denote the vector of opinions of all agents at time step t as $\mathbf{x}(t) = [x_1(t), \dots, x_n(t)]^\top$. The initial opinions profile of the agents is denoted by $\mathbf{x}(0)$.

We extend the coordination game proposed in [4] for single-layer networks to a multiplex network. In this game, an agent updates its opinion at time t to minimize the following cost function:

$$J_i(\mathbf{x}(t)) = \begin{cases} \frac{1}{2} \sum_{j \in \delta_{i\alpha}} (x_i(t) - x_j(t))^2, \forall \alpha \in \{1, 2\}, \text{ if } t \equiv 0 \pmod{k} \\ \frac{1}{2} \sum_{j \in \delta_{i1}} (x_i(t) - x_j(t))^2, \text{ Otherwise.} \end{cases} \quad (3)$$

In simple terms, agent i seeks to minimize the difference between its opinion and that of its neighbors. The provided cost function reflects how this set of neighbors changes based on the active layers.

By employing the first-order condition $\frac{dJ_i(\mathbf{x}(t))}{dx_i} = 0$, the best response strategy of agent i at time $t + 1$ is given by:

$$\mathbf{x}(t + 1) = A(t)\mathbf{x}(t) \quad (4)$$

Note that this model is very well-known in the literature (e.g., see [3, 5, 7, 16]). Mostly it is called the linearized version of the Vicsek model, [41]. However, we study this model under special settings. We make the following assumptions for our Multiplex network.

- Assumption 1.**
1. *When both layers of the multiplex network are active, there is at most one leader, and the union of both layers forms a rooted directed spanning tree, where the leader serves as the root. If the multiplex network has no leader, every communication class in the first layer contains at least one node with a self-loop, and there is a spanning tree rooted in a node.*
 2. *Every isolated agent, meaning every agent without any neighbors, possesses a self-loop in the multiplex network.*

In graph theory, a directed spanning tree rooted in a vertex of a directed graph is a directed tree where all the vertices are reachable from the root vertex (see [42]). Furthermore, we define a communication class as a set of agents in which a directed path exists from each agent to any other within the set. This consideration is based on the underlying subgraph of the respective layer in the multiplex network, where the set of agents comprises the set of nodes of the subgraph.

It is worth noting that [5] assumed that the union of the graphs contains a spanning tree. In our work, we relax this condition by allowing layer 1 to be decomposable, and the presence of self-loops is only mandatory under specific conditions. In contrast, [5] assumed that all nodes in a graph must have a self-loop. The absence of a self-loop for a node allows for the possibility of fully open-minded or fully submissive agents, meaning the agent places no weight on its opinion. Additionally, they established convergence under the assumption that the left matrix production sequence, i.e., the production of adjacency matrices of switching layers, corresponds to a stochastic, irreducible, and indecomposable matrix (SIA), whereas our work considers decomposable structures. Furthermore, the (row) stochastic matrix A is defined by [37] to be *SIA* if there exists a rank one matrix B such that:

$$B = \lim_{n \rightarrow \infty} A^n .$$

3. Convergence of the Opinion Profile

In this section, we demonstrate that the opinion dynamics described by (4) will lead to convergence and consensus. We establish the convergence for two scenarios: one where there is

one leader in the union of both layers, and another where there are no leaders in the union of both layers. It's important to note that each layer can have multiple leaders, but our analysis is conditioned on the union of both layers due to Assumption 1. It is impossible to have several leaders on the union of both layers, as an agent cannot hold multiple opinions simultaneously. Consequently, consensus will not be reached in such a scenario.

We begin by considering the case where there is a leader in the union of the layers.

Proof. Firstly, we show that $A(2)\mathcal{A}_1$ contains a directed spanning tree rooted in the leader. In the context of our Multiplex network, $A(2)$ is the adjacency matrix at time step 2 when both layers are active, representing the connections between agents. This implies the existence of a leader at $t = 2$. The matrix $A(2)\mathcal{A}_1$ maintains a record of walks of length two. This entails starting from a node in the graph associated with the adjacency matrix $A(2)$, traversing an edge, and then, from the subsequent node on that edge, traversing another edge on the underlying graph of \mathcal{A}_1 . The walk concludes at a node from the underlying graph of the adjacency matrix \mathcal{A}_1 .

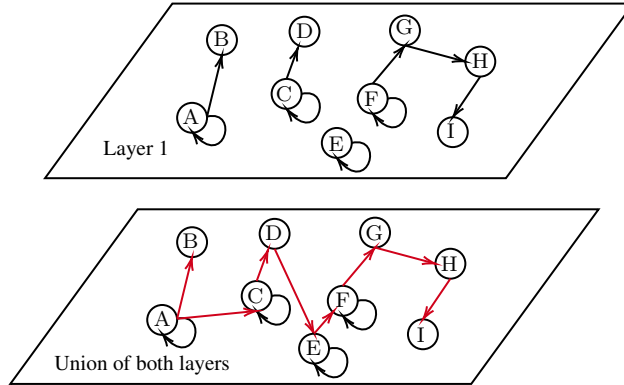

Figure 2: An example of a two-layer multiplex network at $t = 2$ when there is a leader in the union of layers.

Without loss of generality, the example in Figure 2 encompasses all possible scenarios for the first layer. The nodes A , C , and F act as leaders, node E is isolated, and there are disconnected components. Let us focus on node A in the union layer as we want to show there is a directed spanning tree rooted in the leader, A . The first walk could be $A \rightarrow A$ in the union layer, followed by $A \rightarrow B$ in the first layer. This establishes a walk of length two from A to B . In the next walk, $A \rightarrow A$ in the union layer is followed by $A \rightarrow C$ in the first layer, which connects A to C . Subsequently, $C \rightarrow C$ in the union layer, and then $C \rightarrow D$ in the first layer connects C to D . This indeed connects A to D as well. Employing similar reasoning, D is connected to F , F to H and G , C to E , E to G and F , and G to I . Thus, a spanning tree rooted in A exists for the underlying graph of $A(2)\mathcal{A}_1$. Notably, since the sole leader always has a self-loop per the first assumption, there is no possibility of a bipartite structure, i.e., nodes cannot be separated into two disjoint sets. For example, having $\{A, D, F, H\}$ and $\{C, E, G, I, B\}$ such that there is no path from the first set to the other is not feasible due to the self-loop of the leader, not to mention other self-loops. From the standpoint of Markov chains, A represents the only absorbing state, meaning it is a state in the Markov chain from which one cannot transition to another state (see [43]). All other states are transient. To illustrate the transition diagram, one simply needs to reverse all the arrows. This implies that the final opinions of all agents should converge to that of the leader.

Continuing with the scenario where there is no leader in the union of the layers, Figure 3 illustrates an example of this case.

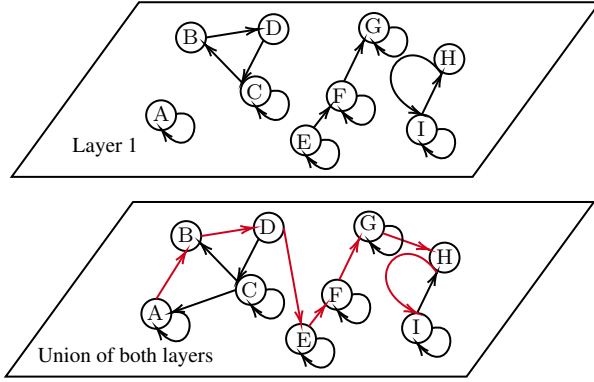

Figure 3: An example of a two-layer multiplex network at $t = 2$ without any leader in the network.

In this scenario, we encounter a directed cycle instead of a leader. For instance, in Figure 3, observe the cycle $A \rightarrow B \rightarrow D \rightarrow C \rightarrow A$. The leader's role in the previous case was crucial as its self-loop allowed us to reach nodes with both odd and even distances (odd or even numbers of edges to be traversed) from the leader, thereby avoiding a bipartite structure and ensuring that there is a directed spanning tree rooted in the leader. When there is no leader in the union of both layers, we are compelled to have a directed cycle passing through all the nodes of the communication class of the underlying graph of the union of both layers. Otherwise, it implies that there is a node without an inward edge from another node, suggesting that the agent is a leader leading to a contradiction.

In case there is a node with no neighbors, it has a self-loop due to the Assumption 1. A directed cycle with at least one node having a self-loop ensures the existence of walks of both odd and even lengths from a node to any other node in the cycle, or the communication class, exemplified by the $A \rightarrow B \rightarrow D \rightarrow C \rightarrow A$ cycle in the above figure. Assumption 1 necessitates such settings.

Assuming this directed cycle is a leader node (it functions like a leader node), the rest of the proof follows the pattern established in the previous case. Previously, we demonstrated that the Markov chain associated with $A(2)\mathcal{A}_1$ for the example in Figure 2 (when the orientation of the edges is flipped to the opposite direction, note that we do not transpose this matrix since it would not be a transition matrix; the flipping of the edges' direction is due to the definition of neighbors) has a sink, an absorbing state which is the leader. Additionally, in the example of Figure 3, we will have only one absorbing communication class, i.e., if we flip the direction of the edges in the union of layers, $\{A, B, C, D\}$ would be the absorbing class. Otherwise, it would be a contradiction since there is a directed spanning tree in the underlying Markov Chain of $A(2)\mathcal{A}_1$, implying that there is a path from one absorbing class to another.

Formally, we denote the final profile of opinions as follows using Markov chain techniques (see [42, 43]):

When there is a leader, the transition probability matrix of the underlying $A(2)\mathcal{A}_1$ Markov chain in a canonical shape, partitioning and rearranging the transition probability matrix to four sub-matrices, is:

$$T_1 = \left(\begin{array}{c|c} 1 & \mathbf{0} \\ \mathbf{R} & \mathbf{Q} \end{array} \right) \quad (5)$$

Where \mathbf{R} corresponds to the transitions toward the absorption state, the leader's state; \mathbf{Q} is the transitions of the transient states; 1 corresponds to the leader's transition to itself, and $\mathbf{0}$ is an

all-zero row vector compatible with the dimension of \mathbf{Q} . Obviously, \mathbf{Q} is a substochastic matrix as T_1 is a transition probability matrix. Hence, if $\mathbf{1}$ is a column vector of all ones compatible with the dimension of \mathbf{R} , we will have:

$$\lim_{t \rightarrow \infty} (A(2)\mathcal{A}_1)^t \mathbf{x}(0) = \lim_{t \rightarrow \infty} T_1^t \mathbf{x}(0) = \left(\begin{array}{c|c} 1 & \mathbf{0} \\ \mathbf{R}_t & \mathbf{Q}^t \end{array} \right) \mathbf{x}(0) \quad (6)$$

However, since \mathbf{Q} corresponds to the transient states and is a substochastic matrix, $\lim_{t \rightarrow \infty} \mathbf{Q}^t = 0$. Also, since T_1 is a stochastic matrix, its powers also correspond to stochastic matrices. Thus, $\lim_{t \rightarrow \infty} \mathbf{R}_t = \mathbf{1}$ implying that all agents will have the initial opinion of the leader.

As for the second case, instead of the leader, we have a communication class of size greater than one with sub-matrix \mathbf{P} and the canonical form of the transition matrix is as follows:

$$T_2 = \left(\begin{array}{c|c} \mathbf{P} & \mathbf{0} \\ \mathbf{R} & \mathbf{Q} \end{array} \right) \quad (7)$$

Matrix \mathbf{P} corresponds to an SIA matrix since it is associated with a strongly connected sub-graph or a communication class, making it an ergodic chain per se [38], and there is a self-loop in the sub-graph due to Assumption 1. It turns out that the limit of higher powers of this matrix is of the below form (see [43]):

$$\lim_{t \rightarrow \infty} \mathbf{P}^t = \mathbf{1}\pi^\top \quad (8)$$

Where π is the associated limiting distribution of the Markov chain with transition probability matrix \mathbf{P} .

Also, $\lim_{t \rightarrow \infty} \mathbf{Q}^t = \mathbf{0}_Q$ since \mathbf{Q} is a substochastic matrix corresponding to transient states transitions and $\mathbf{0}_Q$ is a matrix of all-zero elements compatible with the size of sub-matrix \mathbf{Q} . Since there is only one absorbing class, the probability of ending up in the absorbing class from any transient state will be one. Hence, the probability of ending up in a specific state of the absorbing class is its corresponding stationary distribution element, denoted as $[\pi]_i$. Thus, if matrix \mathbf{R} has dimensions $m \times n$, where m is the number of transient states and n is the number of absorbing states, we can express the convergence as follows:

$$\lim_{t \rightarrow \infty} (A(2)\mathcal{A}_1)^t \mathbf{x}(0) = \left(\begin{array}{c|c} \mathbf{1}\pi^\top & \mathbf{0} \\ \mathbf{1}^{m \times 1} \pi^\top & \mathbf{0}_Q \end{array} \right) \mathbf{x}(0) \quad (9)$$

This means that opinions of all the agents will finally converge to a convex combination of opinions of agents in the absorbing class of the Markov chain associated with transition probability matrix T_2 . It is worth mentioning that these proofs also stand for the case when we have bi-directional interactions

□

4. Convergence Rate

In this section, we delve into the analysis of the convergence rate of the opinion dynamics model given by Equation (4), with a primary focus on insights from [14, 16].

Lemma 1 ([14]). *The convergence rate of the opinion dynamics, characterized by the weighted adjacency matrix C , can be described as follows:*

$$\|\mathbf{x}(t) - \bar{\mathbf{x}}\|_\infty \leq 2Uq^t \|\mathbf{x}(0)\|_2$$

Here, $\bar{\mathbf{x}}$ is the final converged opinion profile, $U > 0$ is a constant, and q represents the joint spectral radius of the multiplication of adjacency matrices of the layers at different time steps.

However, Lemma 1 provides effective bounds when the multiplication of the adjacency matrices corresponds to a SIA matrix. This scenario does not align with our examples, and our goal is to refine the bounds for cases where the multiplication does not correspond to an SIA matrix. When expressing $A(2)\mathcal{A}_1$ in canonical form, the convergence rate is constrained by the convergence rate of the corresponding Q component matrix in the presence of a leader in the union of layers. As matrix Q converges to an all-zero matrix due to transient transitions, the convergence rate of $A(2)\mathcal{A}_1$ is analogous to the convergence rate of matrix Q towards an all-zero matrix. According to the Perron-Frobenius theorem, the spectral radius (ρ) of a strictly sub-stochastic matrix is less than one. We define matrix A as a strictly sub-stochastic matrix if $\sum_j [A]_{ij} < 1$ for all j , and $[A]_{ij} \geq 0$ for all i and j .

Therefore, the convergence rate in this case is defined as follows, drawing on [14, 16], [44, p. 341], with some necessary modifications:

Proposition 1. *The convergence rate of the opinion dynamics (4) is as follows:*

$$\|\mathbf{x}(t) - \bar{\mathbf{x}}\|_\infty \leq 2U \|\mathcal{A}_1^{t-2\lfloor \frac{t}{2} \rfloor}\|_1 q^{\lfloor \frac{t}{2} \rfloor} \|x(0)\|_2 \quad (10)$$

Proof.

$$\begin{aligned} \|\mathbf{x}(t) - \bar{\mathbf{x}}\|_\infty &= \\ \|A(t)\dots A(1)\mathbf{x}(0) - \mathbf{1}\pi^\top \mathbf{x}(0)\|_\infty &= \\ \|\mathcal{A}_1^{t-2\lfloor \frac{t}{2} \rfloor} (A(2)\mathcal{A}_1)^{\lfloor \frac{t}{2} \rfloor} \mathbf{x}(0) - \mathcal{A}_1^{t-2\lfloor \frac{t}{2} \rfloor} \mathbf{1}\pi^\top \mathbf{x}(0)\|_\infty &\leq \\ \|\mathcal{A}_1^{t-2\lfloor \frac{t}{2} \rfloor}\|_1 \| (A(2)\mathcal{A}_1)^{\lfloor \frac{t}{2} \rfloor} \mathbf{x}(0) - \mathbf{1}\pi^\top \mathbf{x}(0) \|_\infty &\leq \\ 2U \|\mathcal{A}_1^{t-2\lfloor \frac{t}{2} \rfloor}\|_1 q^{\lfloor \frac{t}{2} \rfloor} \|x(0)\|_2 & \end{aligned} \quad (11)$$

Where $\|\cdot\|_1$, $\|\cdot\|_2$ and $\|\cdot\|_\infty$ shows the ℓ^1 -norm, ℓ^2 -norm and ∞ -norm of a matrix respectively (see [44]), U is a positive constant, q is the largest eigenvalue in the modulus of matrix Q other than one. Also, $\bar{\mathbf{x}}$ is the ultimate profile of opinions. Note that in the proof we can write $\lim_{t \rightarrow \infty} A(t)\dots A(1) = \mathbf{1}\pi^\top$ as finally, we will have a matrix of rank one from the left production of the adjacency matrices.

The aforementioned rationale applies similarly to the scenario where there is no leader, with the addition that matrix associated with component P must also converge. In this case, q would be the maximum of the largest eigenvalues of both matrices P and Q other than one. \square

5. Numerical Results

In this section, we will simulate the opinion dynamics for the examples depicted in Figure 2 and Figure 3, analyzing their convergence rate and final opinion profiles. Additionally, we will compare the convergence rates with their fully bidirectional counterparts. In both examples,

we consider the initial opinion profile $\mathbf{x}(0) = [4.74, 0.11, 1.14, 3.39, 1.16, 2.36, 0.47, 2.23, 4.92]$, randomly generated from a uniform distribution.

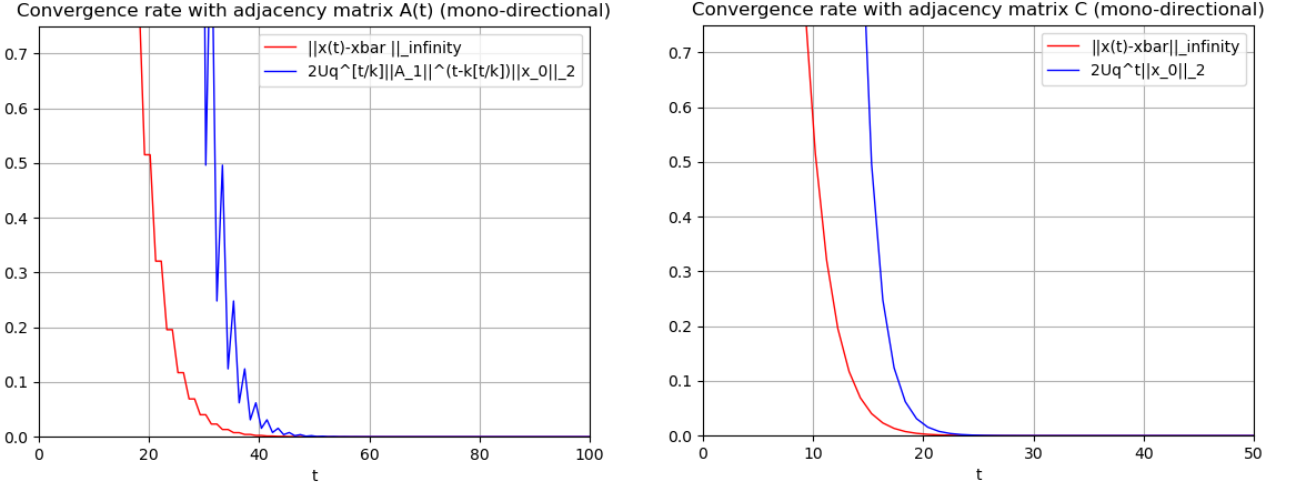

Figure 4: Convergence rate for example 1 network topology with mono-directional interactions

In Figure 4, the leftmost diagram corresponds to the network in example one with the adjacency matrix $A(t)$. On the right side, the diagram represents the same network but with a time-invariant adjacency matrix $C = A(2)\mathcal{A}_1$. By considering this time-invariant matrix, we can observe the changes influenced by the concept of active and inactive layers. Both diagrams indicate that after 40 iterations, the gap between the upper bound and the actual opinion profile difference in the final opinion profile is negligible. It's important to note that C itself corresponds to two iterations. Furthermore, all agents' opinions have converged to 4.74, which is the initial opinion of the leader, aligning with our previous analysis.

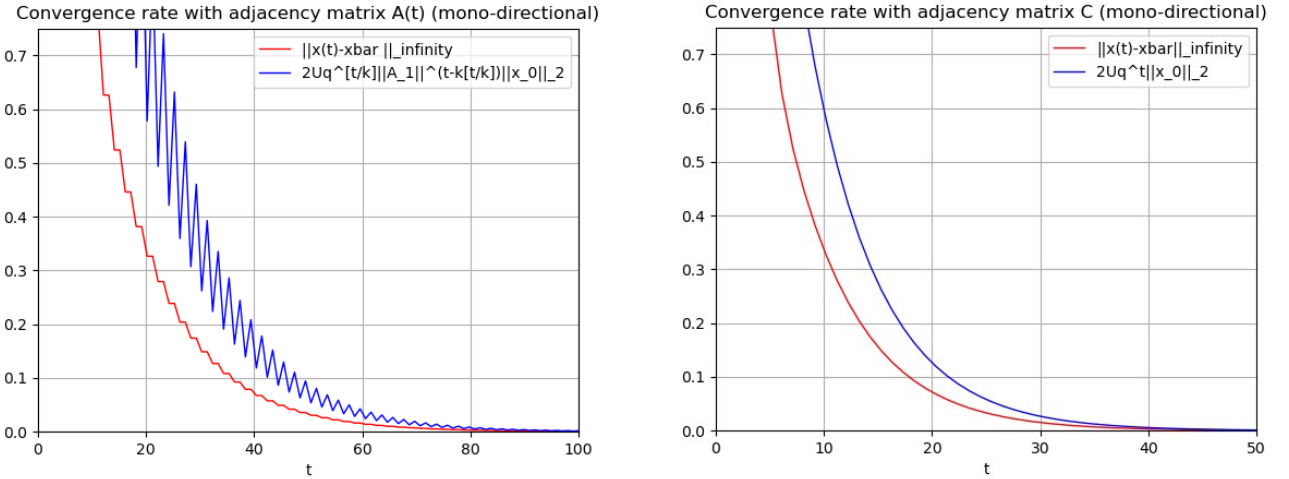

Figure 5: Convergence rate for example 2 network topology with mono-directional interactions

In Figure 5, a notable observation is that it takes longer to converge compared to the previous case where we had a leader in the network. However, it's important to note that we cannot definitively conclude this, as the network topologies differ. Factors such as connectivity play a pivotal role in determining the convergence rate. Additionally, the opinions of all agents converge to 2.1, and consensus has been reached. From this figure and the previous one, we observe that our upper bounds are, at the very least, successful in approximating the actual patterns.

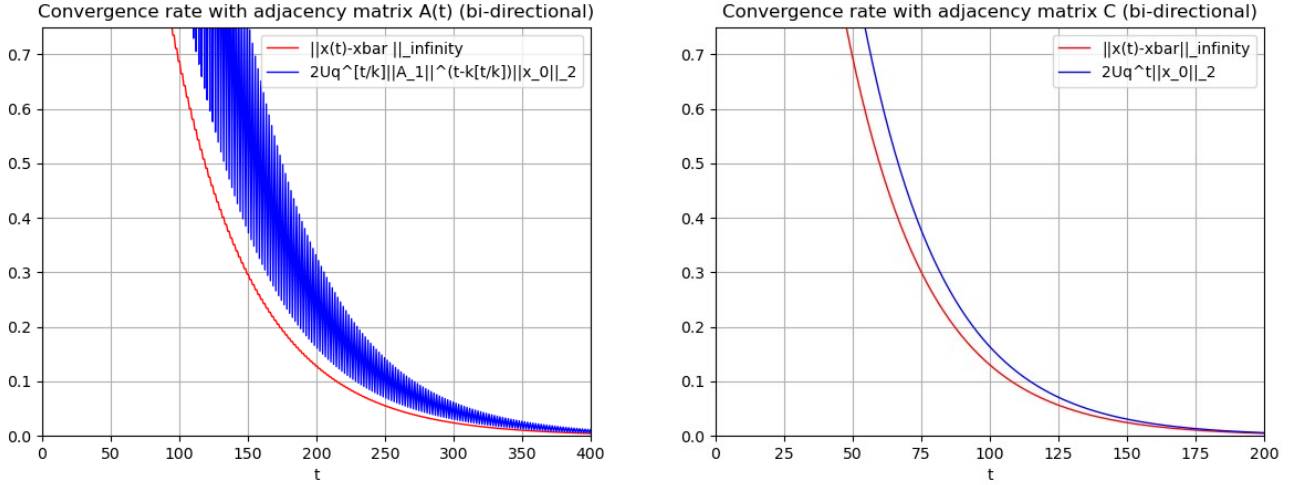

Figure 6: Convergence rate for example 1 network topology with bi-directional interactions

As evident from the diagrams in Figure 6, the convergence time for the bidirectional counterpart of example 1 is longer compared to its one-directional counterparts. This could be logical in some sense since, in the bidirectional version, each agent's opinion affects its neighbors' opinions, leading to consensus over an extended period with more communications between agents. It's worth noting that the communications were not bidirectional with the leader. Additionally, all the agents' opinions converged to that of the leader, 4.74.

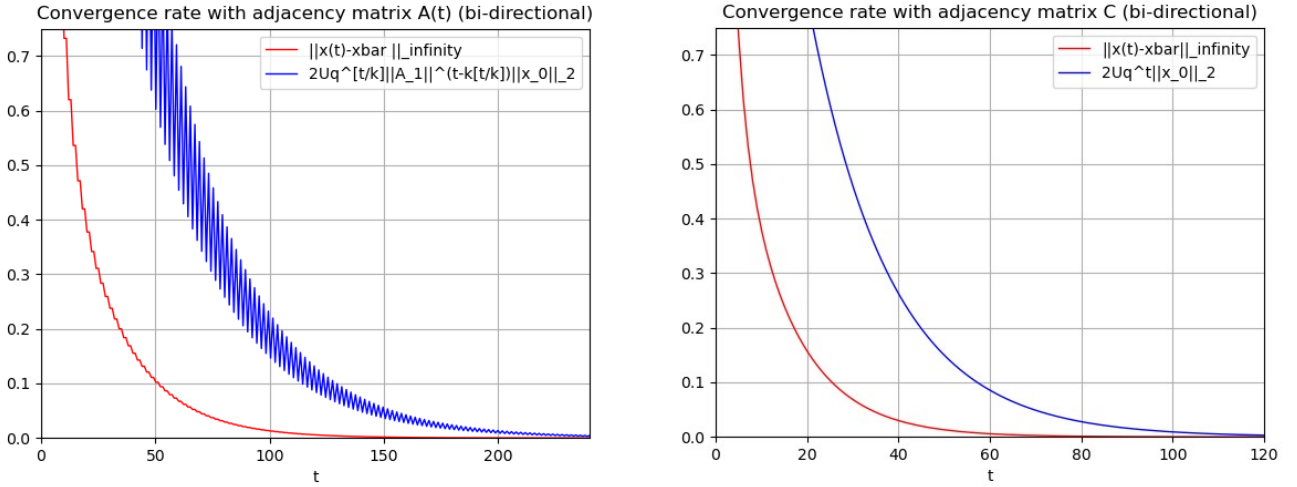

Figure 7: Convergence rate for example 2 network topology with bi-directional interactions

Finally, Figure 7 demonstrates that convergence takes longer in the bidirectional version of example two. However, it seems that the difference is not as significant as that of example one. Again, all agents succeed in reaching consensus with a final opinion of 2.44.

6. Conclusions

In conclusion, our investigation into the dynamics of opinions in a two-layer multiplex network, considering factors such as layer switching, non-negative diagonal elements in adjacency matrices, and decomposable structures, has provided valuable insights. The presence of a leader and mono-directional interactions among agents has been shown to facilitate consensus under certain conditions.

Our study has extended the coordination game model to a multiplex network context, shedding light on the impact of active and inactive layers on the convergence of opinions. The analysis of convergence rates, aided by upper bounds derived from existing research, has revealed that bidirectional interactions can introduce delays in achieving consensus.

Furthermore, our research contributes to the broader field of consensus problems, offering novel perspectives on networks with changing topological properties and addressing scenarios with non-negative diagonal elements. The upper bounds established for convergence rates provide a valuable framework for understanding the dynamics of opinion evolution in complex, multiplex networks.

Overall, our findings emphasize the intricate interplay between network structure, layer dynamics, and agent interactions, paving the way for future exploration in this evolving research domain. As we delve deeper into the complexities of multiplex networks, our study serves as a foundation for understanding the nuances of opinion dynamics and consensus formation in dynamic, real-world scenarios.

To identify potential directions for further advancements in this project, two noteworthy avenues emerge. Firstly, extending the proposed approach to networks with more than two layers could unveil additional complexities and insights into the dynamics of opinion evolution. Exploring the dynamics in other types of multilayer networks, such as interconnected networks, represents a promising frontier for comprehensive analysis.

Furthermore, incorporating stubborn agents into the network or introducing randomness in the layer-switching process could introduce realistic elements, reflecting the intricacies of real-world scenarios. These variations may offer a more nuanced understanding of opinion convergence and consensus formation in dynamic multiplex networks.

7. Declaration of competing interest

The author affirms that there are no identifiable conflicting financial interests or personal associations that might have seemed to impact the work described in this article.

8. Data and Code availability

Data and code are available upon request.

References

- [1] J. Kleinberg, Cascading behavior in networks: Algorithmic and economic issues, *Algorithmic game theory* 24 (2007) 613–632.
- [2] R. Olfati-Saber, R. M. Murray, Consensus protocols for networks of dynamic agents, *Proceedings of the 2003 American Control Conference*, 2003. 2 (2003) 951–956.
URL <https://api.semanticscholar.org/CorpusID:2746408>
- [3] A. Jadbabaie, J. Lin, A. S. Morse, Coordination of groups of mobile autonomous agents using nearest neighbor rules, *IEEE Transactions on automatic control* 48 (6) (2003) 988–1001.

- [4] J. Ghaderi, R. Srikant, Opinion dynamics in social networks: A local interaction game with stubborn agents, in: 2013 American control conference, IEEE, 2013, pp. 1982–1987.
- [5] W. Ren, R. W. Beard, Consensus seeking in multiagent systems under dynamically changing interaction topologies, *IEEE Transactions on automatic control* 50 (5) (2005) 655–661.
- [6] A. Sarlak, Y. Darmani, An approach to improve the quality of service in dtn and non-dtn based vanet, *Information Systems & Telecommunication* (2020) 263.
- [7] J. M. Hendrickx, V. D. Blondel, Convergence of linear and non-linear versions of vicsek’s model, in: *Proceedings of 17th International Symposium on Mathematical Theory of Networks and Systems (MTNS’06)*, Kyoto, Japan, 2005, pp. 1229–1240.
- [8] M. De Domenico, C. Granell, M. A. Porter, A. Arenas, The physics of spreading processes in multilayer networks, *Nature Physics* 12 (10) (2016) 901–906.
- [9] S. Boccaletti, G. Bianconi, R. Criado, C. I. Del Genio, J. Gómez-Gardenes, M. Romance, I. Sendina-Nadal, Z. Wang, M. Zanin, The structure and dynamics of multilayer networks, *Physics reports* 544 (1) (2014) 1–122.
- [10] A. Fazeli, A. Ajorlou, A. Jadbabaie, Duopoly budget allocation in social networks: A nash analysis approach, in: 2015 54th IEEE Conference on Decision and Control (CDC), IEEE, 2015, pp. 2901–2906.
- [11] J. Gómez-Gardenes, I. Reinares, A. Arenas, L. M. Floría, Evolution of cooperation in multiplex networks, *Scientific reports* 2 (1) (2012) 1–6.
- [12] H.-B. Hu, C.-H. Li, Q.-Y. Miao, Opinion diffusion on multilayer social networks, *Advances in Complex Systems* 20 (06n07) (2017) 1750015.
- [13] Z. Wang, L. Wang, A. Szolnoki, M. Perc, Evolutionary games on multilayer networks: a colloquium, *The European physical journal B* 88 (5) (2015) 1–15.
- [14] V. D. Blondel, J. M. Hendrickx, A. Olshevsky, J. N. Tsitsiklis, Convergence in multiagent coordination, consensus, and flocking, in: *Proceedings of the 44th IEEE Conference on Decision and Control*, IEEE, 2005, pp. 2996–3000.
- [15] A. Olshevsky, J. N. Tsitsiklis, Convergence rates in distributed consensus and averaging, in: *Proceedings of the 45th IEEE Conference on Decision and Control*, IEEE, 2006, pp. 3387–3392.
- [16] A. Olshevsky, J. N. Tsitsiklis, Convergence speed in distributed consensus and averaging, *SIAM journal on control and optimization* 48 (1) (2009) 33–55.
- [17] Y. Dong, Z. Ding, H. Liang, F. Chiclana, Asynchronous opinion dynamics with online and offline interactions in bounded confidence model, *Journal of Artificial Societies and Social Simulation*, The (2017).
- [18] Y. Dong, Z. Ding, F. Chiclana, E. Herrera-Viedma, Dynamics of public opinions in an online and offline social network, *IEEE Transactions on Big Data* 7 (4) (2017) 610–618.
- [19] M. Hamzeh, A. Kachabi, M. Andayesh, M. H. K. Fadaei, Conceptual design of a cryocooler and investigation of the effect of design parameters on cryocooler performance.
- [20] M. Hamzeh, New approach method for solving nonlinear differential equations of blood flow with nanoparticle in presence of magnetic field.

- [21] Amirreza Talebi, On the mixed integer linear programming model for revenue management under consumer choice behavior theories (2021). doi:10.13140/RG.2.2.29416.03849. URL <https://rgdoi.net/10.13140/RG.2.2.29416.03849>
- [22] S. Soleymani, A. Talebi, Forecasting Solar Irradiance with Geographical Considerations: Integrating Feature Selection and Learning Algorithms, *Asian Journal of Social Science and Management Technology* 6 (1) (2024) 85–93.
- [23] S. P. H. Boroujeni, A. Razi, Ic-gan: An improved conditional generative adversarial network for rgb-to-ir image translation with applications to forest fire monitoring, *Expert Systems with Applications* 238 (2024) 121962.
- [24] R. Nematirad, A. Pahwa, Solar radiation forecasting using artificial neural networks considering feature selection, in: *2022 IEEE Kansas Power and Energy Conference (KPEC)*, 2022, pp. 1–4. doi:10.1109/KPEC54747.2022.9814765.
- [25] A. Yousefpour, M. Shishehbor, Z. Zanjani Foumani, R. Bostanabad, Unsupervised anomaly detection via nonlinear manifold learning, *Journal of Computing and Information Science in Engineering* (2023) 1–37.
- [26] S. P. Haeri Boroujeni, E. Pashaei, A hybrid chimp optimization algorithm and generalized normal distribution algorithm with opposition-based learning strategy for solving data clustering problems, *Iran Journal of Computer Science* (Oct. 2023). doi:10.1007/s42044-023-00160-x. URL <http://dx.doi.org/10.1007/s42044-023-00160-x>
- [27] S. P. H. Boroujeni, E. Pashaei, Data clustering using chimp optimization algorithm, in: *2021 11th international conference on computer engineering and knowledge (ICCKE)*, IEEE, 2021, pp. 296–301.
- [28] N. Mehrabi, S. P. H. Boroujeni, Age estimation based on facial images using hybrid features and particle swarm optimization, in: *2021 11th International Conference on Computer Engineering and Knowledge (ICCKE)*, 2021, pp. 412–418. doi:10.1109/ICCKE54056.2021.9721496.
- [29] N. Mehrabi, S. P. H. Boroujeni, E. Pashaei, An efficient high-dimensional gene selection approach based on binary horse herd optimization algorithm for biological data classification (2023). arXiv:2308.09791.
- [30] S. S. Sadralashrafi, S. H. R. Pasandideh, S. T. A. Niaki, M. H. Nahavandian, The gardener problem with reservation policy and discount, *Computers & Industrial Engineering* 123 (2018) 82–102.
- [31] A. Amiri-Margavi, H. Babaei, Low-rank solution operator for forced linearized dynamics with unsteady base flows (2023). arXiv:2312.00790.
- [32] I. Jebellat, E. Jebellat, A. Amiri-Margavi, A. Vahidi-Moghaddam, H. Nejat Pishkenari, A reinforcement learning approach to find optimal propulsion strategy for microrobots swimming at low reynolds number, Available at SSRN 4559765 (2023).
- [33] A. Amiri Margavi, H. Babaei, Rank-adaptive reduced-order modeling of 2d incompressible linearized navier stokes equations with time-dependent bases, *Bulletin of the American Physical Society* (2023).

- [34] M. Kargar, C. Zhang, X. Song, Integrated optimization of power management and vehicle motion control for autonomous hybrid electric vehicles, *IEEE Transactions on Vehicular Technology* 72 (9) (2023) 11147–11155. doi:10.1109/TVT.2023.3270127.
- [35] A. Montanari, A. Saberi, Convergence to equilibrium in local interaction games, in: 2009 50th Annual IEEE Symposium on Foundations of Computer Science, IEEE, 2009, pp. 303–312.
- [36] R. Olfati-Saber, R. M. Murray, Consensus problems in networks of agents with switching topology and time-delays, *IEEE Transactions on automatic control* 49 (9) (2004) 1520–1533.
- [37] J. Wolfowitz, Products of indecomposable, aperiodic, stochastic matrices, *Proceedings of the American Mathematical Society* 14 (5) (1963) 733–737.
- [38] J. Hajnal, M. S. Bartlett, Weak ergodicity in non-homogeneous markov chains, in: *Mathematical Proceedings of the Cambridge Philosophical Society*, Vol. 54, Cambridge University Press, 1958, pp. 233–246.
- [39] W. Xia, J. Liu, M. Cao, K. H. Johansson, T. Başar, Products of generalized stochastic sarymsakov matrices, in: 2015 54th IEEE Conference on Decision and Control (CDC), IEEE, 2015, pp. 3621–3626.
- [40] W. Xia, J. Liu, M. Cao, K. H. Johansson, T. Başar, Generalized sarymsakov matrices, *IEEE Transactions on Automatic Control* 64 (8) (2018) 3085–3100.
- [41] T. Vicsek, A. Czirók, E. Ben-Jacob, I. Cohen, O. Shochet, Novel type of phase transition in a system of self-driven particles, *Phys. Rev. Lett.* 75 (1995) 1226–1229. doi:10.1103/PhysRevLett.75.1226.
URL <https://link.aps.org/doi/10.1103/PhysRevLett.75.1226>
- [42] R. B. Bapat, *Graphs and matrices*, Vol. 27, Springer, 2010.
- [43] D. A. Levin, Y. Peres, *Markov chains and mixing times*, Vol. 107, American Mathematical Soc., 2017.
- [44] R. A. Horn, C. R. Johnson, *Matrix analysis*, Cambridge university press, 2012.