

Hidden Markov Models and the Bayes Filter in Categorical Probability

Tobias Fritz¹, Andreas Klingler², Drew McNeely³,
Areeb Shah-Mohammed¹, and Yuwen Wang¹

¹*Department of Mathematics, University of Innsbruck, Austria*

²*Institute for Theoretical Physics, University of Innsbruck, Austria*

³*Cockrell School of Engineering, The University of Texas at Austin, USA*

Abstract

We use Markov categories to generalize the basic theory of Markov chains and hidden Markov models to an abstract setting. This comprises characterizations of hidden Markov models in terms of conditional independences and algorithms for Bayesian filtering and smoothing applicable in all Markov categories with conditionals. When instantiated in appropriate Markov categories, these algorithms specialize to existing ones such as the Kalman filter, forward-backward algorithm, and the Rauch–Tung–Striebel smoother. We also prove that the sequence of outputs of our abstract Bayes filter is itself a Markov chain with a concrete formula for its transition maps.

There are two main features of this categorical framework. The first is its abstract generality, as manifested in our unified account of hidden Markov models and algorithms for filtering and smoothing in discrete probability, Gaussian probability, measure-theoretic probability, possibilistic nondeterminism and others at the same time. The second feature is the intuitive visual representation of information flow in terms of string diagrams.

Contents

1	Introduction	2
1.1	Our contributions	3
1.2	Organization of the paper	3
2	Background and Summary	5
2.1	Background on Markov categories	5
2.2	Detailed outline	14
2.3	Implementation	17
2.4	Related work	17
3	Hidden Markov models in Markov categories	18
3.1	Markov chains	19
3.2	Hidden Markov models	22

4	The Bayes filter in Markov categories	25
4.1	The Bayes filter	25
4.2	The instantiated Bayes filter	29
4.3	Examples of the instantiated Bayes filter	31
4.4	The Bayes filter recursion as a single string diagram	36
4.5	The Bayes filter as a Markov chain	38
5	Smoothing in Markov categories	43
5.1	The Bayes smoother	44
5.2	The instantiated Bayes smoother	49
5.3	Examples of the instantiated Bayes smoother	50
	Bibliography	52

1 Introduction

A **hidden Markov model** is a stochastic dynamical system in discrete time, whose state is considered “hidden” (not directly observable), together with a sequence of noisy observations that are functions of the hidden state and each point in time. Hidden Markov models are widely used across manifold scientific domains to model stochastic dynamical systems in which the hidden state must be approximately inferred from observations that only give partial and/or noisy information. Making this inference can be a difficult problem in practice: while one would optimally want to use Bayesian updating, actually doing this requires conditioning on a potentially long sequence of observations. This is problematic as it requires dealing with spaces growing exponentially with the length of the sequence, so that the naïve way of calculating this quickly becomes unworkable. Recursive **filters** and **smoothers** are algorithms that address this difficulty by providing recursion formulas for this Bayesian update and, in some cases, employ suitable approximations that simplify things further. While we will treat both filters and smoothers in the main text, let us focus on filters in this introduction.

The most widely used filter is the **Kalman filter**, which assumes the state transitions and observations of the hidden Markov model to be linear maps with additive Gaussian noise. The most general recursive filter is the **Bayes filter**, which does not assume any kind of linearity, makes sense for discrete and continuous variables alike, but is difficult to compute with in practice. But the world of recursive filters has a diverse landscape of variations upon these, each tailored to a different structure within an hidden Markov model or a different

Acknowledgments. We thank Dario Stein for suggesting Proposition 4.2, Matthew B. Smith for help with the forward-backward algorithm, and Ramon van Handel for helpful discussion about non-linear filtering.

This research was funded in part by the Austrian Science Fund (FWF) [doi:10.55776/P35992, doi:10.55776/P33122, doi:10.55776/P34129]. For open access purposes, the authors have applied a CC BY public copyright license to any author accepted manuscript version arising from this submission. AK further acknowledges funding of the Austrian Academy of Sciences (ÖAW) through the DOC scholarship 26547. YW’s research is further supported by the University of Innsbruck Early Stage Funding Program.

approximation scheme. Some filters are designed to handle nonlinearities approximately [3, 21]. Others employ additional structure on the state and observation spaces, such as a metric [29]. Some may even take on a different representation of probability or information to better reflect the actual prior knowledge of the system state or improve numerical stability [5].

The differences in these variations can be a lot to keep track of. While the basic propagate-update structure is common to all of them, deriving the concrete formulas for a particular filter can be quite cumbersome. In fact, the equations that define the Kalman filter are already quite involved and difficult to gain intuition for. It would be helpful to have a unifying framework in which one can understand and reason about filters, and in which the common propagate-update structure can be made formal and precise. One may then hope that this will provide a more intuitive account of filters which moreover allows one to easily determine the relevant equations in each case.

In this paper, we aim to provide such a unifying mathematical framework in terms of **categorical probability theory**. Technically, we develop the theory of Markov chains, hidden Markov models, recursive Bayes filters and smoothers within any **Markov category with conditionals**. Instantiating our abstract Bayes filter within any such category gives rise to a concrete filter, and we show that both the Kalman filter and the general Bayes filter arise as special cases of this construction. We have yet to attempt to obtain other filters in this way, but we expect this to be possible for at least some of them. Others may require further generalizations to the categorical framework such that approximations can be considered explicitly.

1.1 Our contributions

We demonstrate how to implement hidden Markov models, filtering, and smoothing within the framework of categorical probability. This unifies various filters, including the Kalman filter, the Bayes filter for finite Markov chains used in discrete probability as well as its measure-theoretic generalization, as well as a filter for nondeterministic automata (without probability). The latter seems to be new and may have applications to information security. The expressive language underlying our abstract approach also produces non-trivial mathematical results, such as that the sequence of filter outputs is itself a Markov chain (Theorem 4.19).

The string diagram language of Markov categories also provides a visually intuitive representation of information flow within systems like hidden Markov models.

1.2 Organization of the paper

Section 2.1 introduces relevant background from the relatively new theory of Markov categories. This should make the paper accessible to anyone familiar with symmetric monoidal categories and string diagrams as well as basic probability. In particular, we present the definition of Markov category together, with the most pertinent examples being `FinStoch` for discrete probability, `Gauss` for Gaussian probability, `BorelStoch` for measure-theoretic probability and `FinSetMulti` for possibilistic nondeterminism. We also recall those concepts from the theory

of Markov categories that are relevant to the present paper. In Section 2.2, we then provide a more technical outline of the novel contributions of this paper. In Section 2.3, we briefly discuss the C++ implementation of our formalism and highlight how the categorical structure can be facilitates modular system design. In Section 2.4, we discuss related work and the connections to existing literature.

In Section 3, we treat hidden Markov models within the framework of Markov categories with conditionals. We begin in Section 3.1 with **Markov chains** by generalizing their traditional definition and characterization in terms of Markov properties to the categorical setting. In Section 3.2, we extend this to **hidden Markov models**, which we characterize in terms of Markov properties as well (Proposition 3.7), and we provide examples in various Markov categories.

In Section 4, we develop the categorical formulation of the **Bayes filter**, which is the result of applying Bayesian inference to a hidden Markov model. While the naïve application of Bayesian inference to a sequence of observations amounts to conditioning on the entire sequence in batch, the Bayes filter is a recursive algorithm that computes this conditional recursively (Proposition 4.2). We define the **instantiated Bayes filter** as the result of applying this Bayes filter to a fixed deterministic sequence of observations. In Section 4.3, we give several examples of the instantiated Bayes filter in various Markov categories. In **FinStoch**, it recovers the traditional Bayes filter for discrete probability. In **FinSetMulti**, we obtain a filter for nondeterministic automata, which seems to be new and may have applications to information security. In Section 4.4, we discuss the deterministic counterpart of the Bayes filter that arises when the underlying Markov category is representable, which allows us to formulate the recursion as a single string diagram. In Section 4.5, we show that the sequence of outputs of the Bayes filter is itself a Markov chain and give a concrete formula for its transition maps. This illustrates how the expressive language of Markov categories can produce non-trivial mathematical results.

In Section 5, we develop the categorical formulation of the **Bayes smoother**, which is very similar to the Bayesian filter but addresses the more general problem of inferring the hidden state at any time t from a sequence of observations up to time $n \geq t$. We give some similar results to those obtained in Section 4, notably that there is a *backward in time* recursive construction of the Bayesian smoother called the **fixed-interval smoother** that also comes in both uninstantiated and instantiated flavors. We also develop a categorical generalization of the classic **forward-backward algorithm**. We then give two concrete examples of the instantiated Bayes smoother: one is to show how the forward-backward algorithm resolves to its traditional counterpart when applied in **FinStoch**, and the other example demonstrates how the fixed-interval smoother recovers the **Rauch-Tung-Striebel smoother** when applied to **Gauss**.

2 Background and Summary

2.1 Background on Markov categories

In the following, we summarize the basic notions of Markov categories relevant to this paper. Understanding the results and proofs requires only familiarity with the string diagrammatic calculus of Markov categories, which we sketch below. General introductions to category theory and monoidal categories can be found in [27, 33], while [2, 10, 11, 34] provide overviews of string diagram calculus for monoidal categories in general. In essence, a monoidal category is a category equipped with a product structure \otimes , which assigns a product object $A \otimes B$ to objects A and B and a product morphism $f \otimes g$ to morphisms f and g . Symmetric monoidal categories also have well-behaved isomorphisms between $A \otimes B$ and $B \otimes A$. All monoidal categories discussed in this paper are symmetric.

To the best of our knowledge, the only novel contribution in this section is Proposition 2.13(c) on conditioning commuting with precomposition by deterministic morphisms.

Notation 2.1. *Throughout, we write*

$$[n] := \{0, 1, \dots, n\}, \quad (t, n] := \{t + 1, \dots, n\}$$

for all $t, n \in \mathbb{N}$.

2.1.1 Markov categories

The starting point of categorical probability is the notion of a **Markov category**, which extends the notion of a symmetric monoidal category by certain additional structure as follows.

Definition 2.2 ([12, Definition 2.1]). *A **Markov category**¹ is a semicartesian² symmetric monoidal category \mathcal{C} in which every object X is equipped with a distinguished commutative comonoid structure³*

$$\text{copy}_X : X \rightarrow X \otimes X, \quad \text{del}_X : X \rightarrow I,$$

drawn in string diagrams as

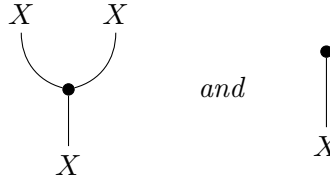

¹The definition was introduced under this name in [12, Definition 2.1], but had already appeared earlier as **affine CD category** in [9, Definition 2.3]. We refer to [14, Remark 2.2] for a more detailed account of the history and even earlier closely related definitions.

²By definition, a monoidal category is semicartesian if the monoidal unit I is terminal.

³The relevant piece of data here is copy_X , as del_X must be the unique morphism to the terminal object I .

which is compatible with the tensor product in the sense that for all objects X and Y ,

$$\begin{array}{ccc}
 X \otimes Y & X \otimes Y & \\
 \uparrow & \uparrow & \\
 & \bullet & \\
 \downarrow & & \\
 X \otimes Y & & \\
 & = & \\
 & & \\
 X & Y & X & Y \\
 \uparrow & \uparrow & \uparrow & \uparrow \\
 & \bullet & \bullet & \\
 \downarrow & \downarrow & \downarrow & \\
 X & Y & &
 \end{array}$$

Remark 2.3. Let us sketch the intuition behind this definition. The objects of a Markov category can be interpreted as spaces of values of a variable, such as the state of possible states of a system or Markov chain. In the Markov categories that model probability, these spaces are measurable spaces that do *not* come equipped with a probability measure already. A morphism $f: A \rightarrow X$ can be thought of as a random function or process that takes an input from A and produces an output in X that may be random or uncertain, depicted in string diagrams like this:

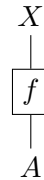

In general, composition of morphisms is depicted by using the output wire of one morphism as the input wire of another morphism. We think of a composite $g \circ f$ as taking an input to f , producing a random output, and then feeding this to g . In the various flavors of probability, a morphism $A \rightarrow X$ is a conditional probability distribution on X depending on A , also known as a **Markov kernel**. These compose via the Chapman–Kolmogorov equation. Morphisms of the specific type $p: I \rightarrow X$, which effectively have trivial input, are also called **states** and drawn as triangles:



In probability, these correspond to probability measures on X : the monoidal unit I is a singleton, and a Markov kernel with singleton input is just a single probability measure.

The symmetric monoidal structure formalizes the possibility of taking products of spaces, which is relevant for probability for talking about joint distributions. The monoidal structure on morphisms amounts to a different mode of composition, often called **parallel composition**, where $f: A \rightarrow X$ and $g: B \rightarrow Y$ compose to

$$f \otimes g: A \otimes B \rightarrow X \otimes Y,$$

and this is drawn in string diagrams by placing the diagram for f next to the diagram for g . We interpret this as having the morphisms f and g act independently and possibly concurrently.

For example in Markov categories modelling probability, the parallel composite of two states is the corresponding product distribution. A morphism from an n -fold tensor product to an m -fold tensor product is thought of as a morphism with n inputs and m outputs, and correspondingly drawn with n input wires and m output wires.

The comonoid structures implement the idea is that the information “flowing” on the wires of a string diagram can be copied or discarded. In probability theory, composing with a discard map corresponds to marginalizing a variable, while composing with a copy map corresponds to copying the value of a variable. With this interpretation in mind, the equations

$$\begin{array}{c} \bullet \\ | \\ \boxed{f} \\ | \end{array} = \begin{array}{c} \bullet \\ | \end{array} \tag{2.1}$$

$$\begin{array}{c} \bullet \quad \bullet \\ \cup \\ \bullet \\ | \end{array} = \begin{array}{c} \bullet \quad \bullet \\ \cup \\ \bullet \\ | \end{array} = \begin{array}{c} | \end{array} \tag{2.2}$$

which are part of the defining conditions, reflect elementary properties of these operations in probability theory.⁴

Example 2.4 (See [12] for more details). Many different flavors of probability theory can be formalized as Markov categories. In all of these examples, we leave it understood that the copy morphisms are the obvious ones.

- (a) **FinStoch** is a Markov category capturing discrete probability theory on finite sets. It has finite sets as objects and stochastic matrices $(f(y|x))_{x \in X, y \in Y}$ as morphisms, with matrix multiplication as composition. In particular, a morphism $p: I \rightarrow X$ is a probability distribution on a finite set X . The symmetric monoidal structure is given by the Cartesian product of sets and the tensor product (Kronecker product) of matrices.
- (b) **Stoch** is the Markov category with arbitrary measurable spaces as objects and measurable Markov kernels as morphisms. Composition is defined by the Chapman–Kolmogorov equation $(g \circ f)(T|a) := \int_X g(T|x) f(dx|a)$. The symmetric monoidal structure is given by the usual product of measurable spaces and the tensor product of Markov kernels. This Markov category models general measure-theoretic probability. In particular, a morphism $p: I \rightarrow X$ is just a probability measure on a measurable space X .
- (c) **BorelStoch** is given by **Stoch** restricted to standard Borel spaces as objects. This is the Markov category that we usually use for measure-theoretic probability, since it is better-behaved than **Stoch**, and because standard Borel spaces are sufficient for most applications.

⁴Intuitively, the first reflects the fact that if one marginalizes the output of a Markov kernel, then the kernel itself becomes irrelevant. The second reflects the fact that if a variable gets copied and one of the outputs gets marginalized, then the resulting map acts like an identity.

- (d) **Gauss** is the Markov category modelling Gaussian distributions and kernels. Its objects are the Euclidean spaces \mathbb{R}^n , morphisms $p: I \rightarrow \mathbb{R}^n$ are Gaussian probability measures, and general morphisms $f: \mathbb{R}^n \rightarrow \mathbb{R}^m$ are triples (A, μ, Σ) consisting of a real $m \times n$ matrix A , a vector $\mu \in \mathbb{R}^m$, and a positive definite $m \times m$ matrix Σ . Such a triple represents a stochastic map of the form

$$x \mapsto Ax + \mathcal{N}(\mu, \Sigma),$$

where $\mathcal{N}(\mu, \Sigma)$ denotes a Gaussian random variable with mean μ and covariance Σ . Two such maps

$$x \mapsto Ax + \mathcal{N}(\mu, \Sigma), \quad y \mapsto By + \mathcal{N}(\nu, \Lambda)$$

compose to

$$\begin{aligned} x \mapsto (BA)x + B\mathcal{N}(\mu, \Sigma) + \mathcal{N}(\nu, \Lambda) \\ = (BA)x + \mathcal{N}(B\mu + \nu, B\Sigma B^t + \Lambda), \end{aligned} \tag{2.3}$$

where the last equation holds as the two noise terms are assumed independent. For details on the symmetric monoidal structure, we refer to [12].

- (e) Besides Markov categories modeling probability distributions, there are also *non-probabilistic* Markov categories. For example, every cartesian monoidal category is a Markov category in which every morphism is deterministic (Definition 2.5). In these examples, categorical probability essentially trivializes [12, Remark 2.4].
- (f) The Markov category **FinSetMulti** models nondeterminism in the computer science sense, where the uncertainty is *possibilistic* rather than probabilistic. It has finite sets as objects, and a morphism $f: X \rightarrow Y$ is given by a multivalued map, by which we mean a matrix $(f(y|x))_{y \in Y, x \in X}$ with entries in $\{0, 1\}$, subject to the condition that for every x we have $f(y|x) = 1$ for some y . We interpret the case $f(y|x) = 1$ as saying that output y is possible on input x , and impossible if $f(y|x) = 0$. Composition is given again by matrix multiplication as in **FinStoch**, but with the convention that $1 + 1 = 1$. Thus an output of a composite $g \circ f$ is possible on a given input if and only if there is an intermediate output y which is possible on the input x according to f , and the final output z is possible on y according to g . The symmetric monoidal structure is again the obvious one [12].

2.1.2 Representability

Definition 2.5 ([12, Definition 10.1]). *A morphism f in a Markov category \mathcal{C} is **deterministic** if it commutes with copying, that is if*

$$\begin{array}{c} \begin{array}{c} | \\ \boxed{f} \\ | \end{array} \quad \begin{array}{c} | \\ \boxed{f} \\ | \end{array} \\ \text{---} \bullet \text{---} \\ | \end{array} = \begin{array}{c} \begin{array}{c} | \\ \boxed{f} \\ | \end{array} \\ \text{---} \bullet \text{---} \\ | \end{array} \tag{2.4}$$

The deterministic morphisms form a cartesian monoidal subcategory denoted \mathcal{C}_{det} [12, Remark 10.13]. For example, $\text{FinStoch}_{\text{det}}$ is⁵ the category of finite sets and functions, $\text{BorelStoch}_{\text{det}}$ is the category of standard Borel spaces and measurable functions, $\text{Gauss}_{\text{det}}$ is the category of Euclidean spaces and affine maps, and $\text{FinSetMulti}_{\text{det}}$ is again the category of finite sets and functions.

Definition 2.6 ([16, Definition 3.10]). *A Markov category \mathcal{C} is **representable** if for every object X , there is an object PX and a morphism $\text{samp}_X: PX \rightarrow X$ such that every morphism $f: A \rightarrow X$ factors as*

$$\begin{array}{c} X \\ | \\ \boxed{f} \\ | \\ A \end{array} = \begin{array}{c} X \\ | \\ \boxed{\text{samp}_X} \\ | \text{ } PX \\ \boxed{f^\sharp} \\ | \\ A \end{array}$$

for a unique deterministic morphism $f^\sharp: A \rightarrow PX$ that we call the **deterministic counterpart** of f .⁶

For example, BorelStoch is representable because a Markov kernel $A \rightarrow X$ can be identified with a measurable function $A \rightarrow PX$, where PX is the measurable space of probability measures on X . This correspondence is implemented by composition with the sampling morphism $\text{samp}_X: PX \rightarrow X$, which is the Markov kernel that samples from the distribution that it receives as input. Similarly, FinSetMulti is representable because a multivalued map $A \rightarrow X$ can be identified with a function $A \rightarrow PX$, where PX is the set of non-empty subsets of X . On the other hand, FinStoch is not representable.

Definition 2.7 ([16, Definition 13.1]⁷). *For morphisms $p: W \rightarrow A$ and $f, g: A \rightarrow X$ in a Markov category, the **almost sure equality** $f =_{p\text{-a.s.}} g$ is shorthand notation for*

$$\begin{array}{c} A \quad X \\ \quad | \quad | \\ \quad \boxed{f} \\ \quad | \quad | \\ \quad \bullet \quad \bullet \\ \quad | \quad | \\ \quad \boxed{p} \\ \quad | \\ \quad W \end{array} = \begin{array}{c} A \quad X \\ \quad | \quad | \\ \quad \boxed{g} \\ \quad | \quad | \\ \quad \bullet \quad \bullet \\ \quad | \quad | \\ \quad \boxed{p} \\ \quad | \\ \quad W \end{array}$$

⁵What we mean by “is” here is that a deterministic stochastic matrix is a matrix with exactly one non-zero entry in each row, and can therefore be identified with a genuine function, and similarly for the other cases.

⁶Equivalently, \mathcal{C} is representable if the inclusion functor $\mathcal{C}_{\text{det}} \hookrightarrow \mathcal{C}$ has a right adjoint $P: \mathcal{C} \rightarrow \mathcal{C}_{\text{det}}$. In this formulation, the morphisms samp_X are the counit components of this adjunction. We refer to [16] for more details e.g. on the interaction with the monoidal structure.

⁷See also [9, Definition 5.1] for an earlier version of the definition.

Intuitively, this is thought of as f and g behaving the same on the support of p , where p is itself thought of as a state depending on a parameter A . In **BorelStoch**, it specializes to the usual notion of almost sure equality [12, Example 13.3], and therefore the same holds for its subcategories **FinStoch** and **Gauss**.

Definition 2.8 ([16, Definition 3.18]). *A representable Markov category \mathcal{C} is **a.s.-compatibly representable** if for all $p: W \rightarrow A$ and $f, g: A \rightarrow X$,*⁸

$$f =_{p\text{-a.s.}} g \implies f^\sharp =_{p\text{-a.s.}} g^\sharp. \quad (2.5)$$

Most representable Markov categories that we know of are also a.s.-compatibly representable, including **BorelStoch** and **FinSetMulti** [16].

2.1.3 Conditionals

Many Markov categories satisfy additional axioms that are relevant for categorical probability theory. The existence of conditionals in particular is a key feature, and we refer to [12, Example 11.3] and [9, Definition 3.5] for more details.

Definition 2.9 ([12, Definition 11.5]). *A morphism $f: A \rightarrow X \otimes Y$ in a Markov category \mathcal{C} has a **conditional** $f_{|X}: A \otimes X \rightarrow Y$ with respect to X if it factorizes as*⁹

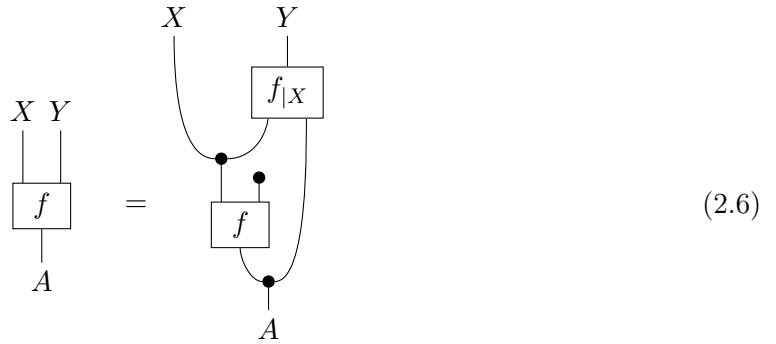

We say that \mathcal{C} **has conditionals** if such a conditional always exists.

Example 2.10. The main examples from Example 2.4 all have conditionals.

(a) **FinStoch** has conditionals given by

$$f_{|Y}(x | y, a) := \frac{f(x, y | a)}{\sum_{x'} f(x', y | a)} \quad (2.7)$$

whenever the denominator is nonzero, and with $f_{|Y}(x | y, a)$ an arbitrary distribution on X whenever it is zero.

⁸The converse of this implication holds for representable Markov categories in general, as can be seen by post-composing with the relevant sampling map.

⁹There is an obvious mirror-image definition of $f_{|X}$. Since these two definitions are interchangeable by a swap, and whichever one is used should be obvious in context throughout the paper, we only treat one of them explicitly.

- (b) In **BorelStoch**, a conditional $p_{|Y}: Y \rightarrow X$ for a probability measure $p: I \rightarrow X \otimes Y$ is known as a **regular conditional probability**. **BorelStoch** has conditionals since such regular conditional probabilities exist, even with measurable dependence on an additional parameter from some space A , although the larger category **Stoch** does not have conditionals [12, Example 11.3].
- (c) **Gauss** has conditionals, and for our upcoming treatment of the Kalman filter it is instructive to work out what they are.¹⁰ A general morphism $f: A \rightarrow X \otimes Y$ can be written as

$$\begin{pmatrix} x \\ y \end{pmatrix} = \begin{pmatrix} M \\ N \end{pmatrix} a + \mathcal{N}(v, C),$$

where the Gaussian noise has mean v and covariance matrix C of the form

$$v = \begin{pmatrix} s \\ t \end{pmatrix} \quad \text{and} \quad C = \begin{pmatrix} C_{\xi\xi} & C_{\xi\eta} \\ C_{\eta\xi} & C_{\eta\eta} \end{pmatrix}.$$

As per [12, Example 11.8], a conditional $f_{|Y}: A \otimes Y \rightarrow X$ is given by

$$x = (N - C_{\xi\eta}C_{\eta\eta}^-M)a + C_{\xi\eta}C_{\eta\eta}^-y + \mathcal{N}(s - C_{\xi\eta}C_{\eta\eta}^-t, C_{\xi\xi} - C_{\xi\eta}C_{\eta\eta}^-C_{\eta\xi}),$$

where $C_{\eta\eta}^-$ is the Moore–Penrose pseudoinverse of $C_{\eta\eta}$.

- (d) **FinSetMulti** has conditionals [13, Proposition 16] given simply by

$$f_{|Y}(x|y, a) = f(x, y|a).$$

Remark 2.11. The conditional of a morphism is often not unique,¹¹ and this problem in particular afflicts the Bayes filter as a particular conditional (Definition 4.1). However, by pre-composing the defining equation (2.6) with copy_A , it follows that $f_{|Y}$ is unique up to almost sure equality with respect to

$$(2.8)$$

Thanks to this “almost uniqueness”, we often speak of “the” conditional, and hence “the Bayes filter”, as long as it is ensured that all statements under consideration are valid regardless of the particular choice of conditional. This will be the case for all of our uses of conditionals in this paper.

¹⁰See also [44, Section 6.5] for a more geometric construction of conditionals in a closely related category of *extended Gaussians*.

¹¹This is indeed already the case in **FinStoch** due to the arbitrary choice made in the case of zero denominator in (2.7).

In an a.s.-compatibly representable Markov category, the deterministic counterpart $f_{|Y}^\#$ is clearly unique up to the same almost sure equality as well. This will become relevant in Section 4.4.

Notation 2.12. Following Jacobs [19, Section 7.5/6], we denote a conditional also by¹²

In this notation,¹³ the defining equation of the conditional reads as

The following coherence results for conditionals admit particularly elegant depictions in terms of the dashed box notation [19, Exercise 7.5.4]. The first two were originally proven as [12, Lemmas 11.11-12] while the third one is new.

Proposition 2.13. *In any Markov category \mathcal{C} with conditionals:*

¹²The subscript “a.s.” reminds us that conditionals are unique only up to almost sure equality as discussed in Remark 2.11. Because of this lack of uniqueness, the dashed box cannot be viewed as an algebraic operation on morphisms.

¹³Such notation (dashed boxes and bending wires around) has also been used in the context of conditionals constructed out of “caps” and “normalization” (e.g. [46]). While this approach leads to identical notation for conditionals, we emphasize that we do not use these notions, since this is generally not how conditionals can be constructed (e.g. in BorelStoch).

(a) For $f: A \rightarrow X \otimes Y \otimes Z$, the “double conditional” $(f|_Z)|_Y$ is also a conditional $f|_{(Z \otimes Y)}$,

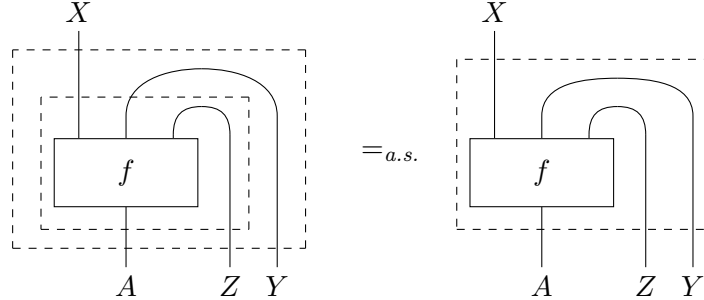

(b) For $f: A \rightarrow X \otimes Y$ and $g: W \otimes X \rightarrow Z$, we have¹⁴

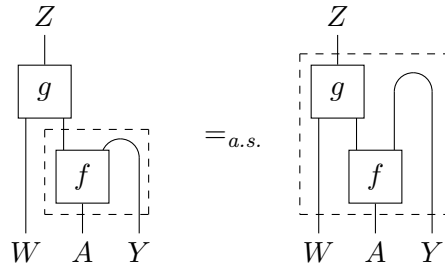

(c) For $f: A \otimes B \rightarrow X \otimes Y$ and deterministic¹⁵ $g: C \rightarrow B$, we have

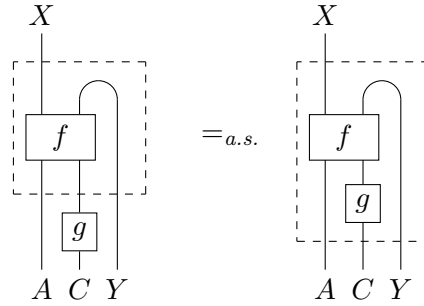

Proof. We only prove the new part (c) and restrict to $A = I$, since the general case follows by

¹⁴This equation shows in particular that conditioning commutes with marginalization. For $f: A \rightarrow X \otimes Y \otimes Z$, using the marginalization morphism $g := \text{id}_X \otimes \text{del}_Y$ shows that marginalizing out Y before or after conditioning on Z gives the same morphism up to almost sure equality.

¹⁵Assuming g to be deterministic in (c) is necessary, in the sense that if the conclusion holds for $A = I$ and $f = \text{copy}_B$, then g is deterministic. Indeed, copy_B has a conditional with respect to the second output given by $\text{id}_B \otimes \text{del}_B$. Thus, if the equality of Proposition 2.13(c) holds for $f := \text{copy}_B$, it is the assertion that $g \otimes \text{del}_B$ is a conditional of $\text{copy} \circ g$. The defining equation of this conditional is precisely that g is deterministic.

using $\text{id}_A \otimes g$ in place of g . In this case we get

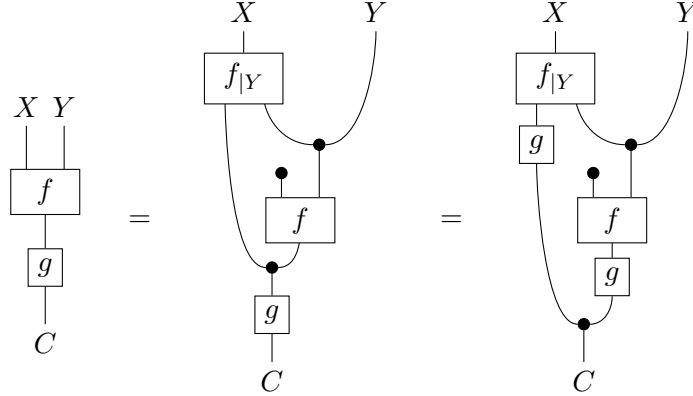

where we use the definition of the conditional in the first step and the determinism assumption in the second. This shows that $f|_Y \circ (g \otimes \text{id}_Y)$ is a conditional of $f \circ g$ with respect to Y . \square

2.2 Detailed outline

Here, we give a brief overview of Bayesian filtering and the main results of this paper. Traditionally, hidden Markov models are represented as graphical models corresponding to these directed acyclic graphs:

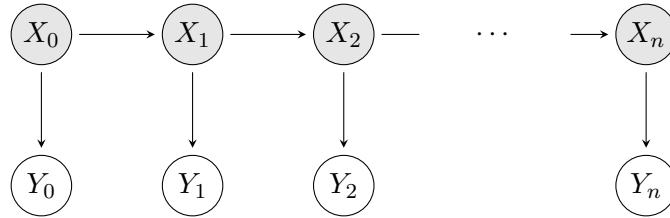

Hence, a hidden Markov model is a particular kind of Bayesian network. The nodes of this graph are partitioned into “hidden” nodes (gray) and “observed” nodes (white) carrying the random variables X_i and Y_i , respectively. Each directed arrow indicates a possible causal dependence between these variables. Formally, this means that a joint probability distribution p is a hidden Markov model if it can be factored as

$$p(x_0, x_1, \dots, x_n, y_0, y_1, \dots, y_n) = p(x_0) \cdot p(y_0 | p_0) \cdot \prod_{t=1}^n p(y_t | x_t) \cdot p(x_t | x_{t-1}).$$

Let us turn to the new development of this paper. In our string-diagrammatic setting, a

Markov chain is represented as follows:

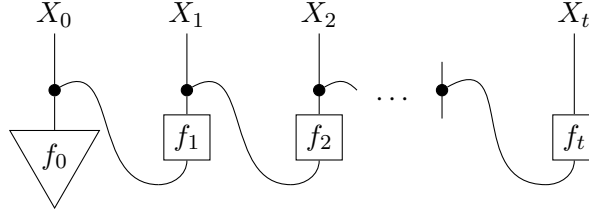

Here, each box f_i for $i > 0$ represents the transition kernel which generates an X_i -valued random variable as a function of the X_{i-1} -valued random variable. The bending of the wires has no formal meaning in this string diagram, and we use it only in order to be able to draw the diagram horizontally. Similarly, a **hidden Markov model** is represented as follows:

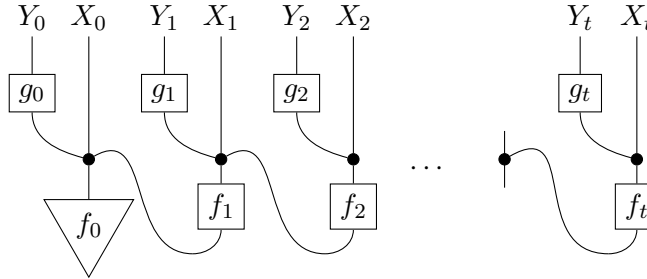

Now, additional Y_i -valued variables that depend on the X_i -valued ones are introduced, and this dependence is modeled by the morphisms g_i . For Markov categories with conditionals, we show that Markov chains and hidden Markov models can be equivalently characterized by **Markov properties**, which are certain conditional independence relations among the different variables (Propositions 3.1 and 3.7).

To motivate filtering and smoothing, recall that a hidden Markov model often models a situation in which one only has access to a sequence of observations y_0, \dots, y_t , and one wants to guess the hidden state $x_t \in X_t$. This is the so-called **filtering problem**. More formally, we want to find the **Bayes filter** BF_t , which is the conditional of the hidden variable x_t given the observations y_0, \dots, y_t , which by definition must be $\text{BF}_t: Y_0 \otimes \dots \otimes Y_t \rightarrow X_t$ such that

Here, $p_{[t]}$ is a shorthand notation for the hidden Markov model with all hidden states before time t marginalized out.

Working with this definition of the Bayes filter BF_t in practice is hard since its domain typically grows exponentially in t . This is why *recursive* formulas are used in concrete applications. In Proposition 4.2, we show that BF_t permits such a recursive formulation in every Markov category with conditionals. However, this is still not so useful in practice, where one does not need to know the Bayes filter on *all* inputs, but only on *one* particular sequence of observations y_0, \dots, y_t as input. This is why we also consider the **instantiated Bayes filter** IBF_t , which is the morphism $I \rightarrow X_t$ obtained by plugging in a particular sequence of observations, and for which a recursion formula holds as well (Proposition 4.7). Subsequently, we show that our abstract IBF_t specializes to the Kalman filter in **Gauss** (Section 4.3.4) and to the discrete and continuous Bayes filters in **FinStoch** and **BorelStoch** (Sections 4.3.1 and 4.3.2). Moreover, instantiating our general construction in **FinSetMulti** produces the **possibilistic filter**, which seems to be new.

For a hidden Markov model, we may think of the deterministic counterpart BF_t^\sharp as a function which deterministically outputs the observer’s posterior distribution at time t as a function of the observations (while BF_t samples from that distribution). In Theorem 4.19, we show that in every a.s.-compatibly representable Markov category with conditionals, the deterministic Bayes filters form a Markov chain of their own, in the sense that the posterior at time n , considered as a random element of PX_n , exclusively depends on the previous posterior in PX_{n-1} .

A common question that is related to the filtering problem is how to incorporate future measurements into one’s guess of a hidden state. In other words, while the Bayes filter BF_t at time t takes observations y_0, \dots, y_t as inputs and produces an estimate of the final hidden x_t , one may also want to utilize even further observations up to y_n for $n > t$ in order to obtain an improved estimate of x_t . This problem commonly appears in the following scenario: a Bayes filter can be used in real time as a sequence of measurements arrives in order to make a best guess of the current state using available data. Upon reaching a time n , one will have obtained an estimate of the state trajectory sequence $(x_t)_{t \leq n}$, but each estimate x_t will only have utilized the measurements y_0, \dots, y_t that came before it. At the time n , one may want to “refine” this trajectory estimate, and obtain an improved sequence of estimates $(\hat{x}_t)_{t \leq n}$ where each \hat{x}_t now incorporates *all* measurements up to time n . By nature, the n th state estimate will not change, that is $x_n = \hat{x}_n$, but state estimates earlier in the trajectory will typically become more accurate through this process. This is the so-called **smoothing problem**. In Section 5, we define a **Bayes smoother at time t with respect to time n** to be a morphism $\text{BS}_t^n: Y_0 \otimes \dots \otimes Y_n \rightarrow X_t$ for $t < n$ that satisfies

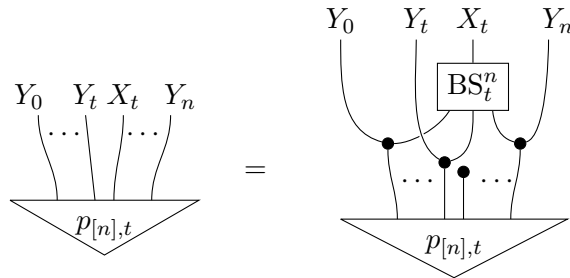

where we now write $p_{[n],t}$ as shorthand for the hidden Markov model up to time n with all X_i except for X_t marginalized out.

Similar to BF_t , using the definition of the Bayes smoother BS_t^n becomes difficult in practice as the marginalization and conditioning procedures become exponentially complex in n and $n-t$. Therefore, we develop several recursive procedures (Lemmas 5.4 and 5.6 and Proposition 5.9) which reduce this complexity to linear. Again, instantiated versions of these recursions tend to be more useful in practice, so we also introduce the **instantiated Bayes smoother** with corresponding recursions. We then show how our general categorical recipes specialize to the forward-backward algorithm in `FinStoch` (Section 5.3.1) and to the Rauch–Tung–Striebel smoother in `Gauss` (Section 5.3.2).

2.3 Implementation

In the context of computing, the abstract nature of Markov categories allows any algorithm expressed in terms of string diagrams to be implemented in a reusable way, as it can be instantiated both in a probabilistic and possibilistic context, or generally in any Markov category that may be of interest to the programmer. As a demonstration, Matvey Soloviev and the last named author have implemented a proof-of-concept codebase [43] that formalizes Markov categories as C++ *abstract classes* [45], which are a mechanism that enables writing programs that operate on any data structure for which a particular set of methods has been implemented.

Based on this, we then provide an implementation of the instantiated Bayes filter (Section 4.2) that mirrors the string-diagrammatic formulas, together with implementations of the categories `FinStoch` and `FinSetMulti`, in which the filter implementation can be used with no change to its code. To add support for an additional category, the programmer needs only to implement a representation of objects and morphisms in that category, together with methods that implement the Markov category structure as well as conditioning.¹⁶

2.4 Related work

There are several different lines of work related to ours, in the sense that they also consider related notions of Markov chains, hidden Markov models, and/or filters in a categorical framework.

- A different treatment of filters in categorical probability was developed concurrently and independently by Virgo [48]; we refer to Remark 4.4 for a discussion of the precise relation.
- An approach to active inference for open generative models (of which hidden Markov models are an example, albeit in a different kind of category) was developed concurrently

¹⁶Depending on the category, it may be advantageous to implement some frequently-used operations which can be derived from the basic ones directly, exploiting additional structure in the category for increased performance. Our implementation demonstrates an example of this for the projection morphisms $A_1 \otimes \dots \otimes A_n \rightarrow A_i$, which can be obtained as a tensor product of $n-1$ deletion morphisms with an identity, but has a faster implementation in `FinStoch` when the dimensions of the A_i are known.

and independently by Tull et al. [46]; we refer to Remark 4.5 for a discussion of the precise relation.

- A recent line of work by McIver et al. is concerned with so-called *quantitative information flow* in computer science [28, 35, 1]. This seeks to establish information-theoretic upper bounds on how much certain inputs (such as sensitive secrets) of a process or program may influence certain outputs (such as ones visible to the general public). Since the hidden state of the process changes over time, it is natural to formalize this kind of situation in terms of hidden Markov models. One then looks for ways to quantify how much information the observed (leaked) values carry about the hidden state.

These works are related to the present paper insofar as they employ a certain amount of categorical language, although everything takes place explicitly in the category of sets and stochastic matrices (the infinitary version of `FinStoch`).

- Panangaden’s work on *labelled Markov processes* provides a categorical framework for Markov chains with additional *inputs* (called labels) rather than outputs [32]. This work places particular emphasis on developing analogues of notions from automata theory (like bisimilarity) to labelled Markov processes.
- Recent work of Schauer and van der Meulen in [41] gives a categorical account of the *Backward Filtering Forward Guiding (BFFG)* algorithm for smoothing, previously introduced in [30] and further generalized in [47]. They consider a more general setting of graphical models, of which the causal structure of a hidden Markov model is an example. While they do construct the algorithm using a particular Markov category, they do not use the Markov structure explicitly. Instead, they provide a categorical treatment in terms of optics (in the sense of [17]). They then demonstrate that compatibility of the optics construction with parallel and sequential composition allows the algorithm to be formulated as a composition of optics.

In contrast to our approach, the latter three lines of work are not concerned with a general categorical formalism, but merely use categorical language to talk about the respective structures in particular Markov categories (roughly `FinStoch` and `BorelStoch`). Also the transition kernels and the observation kernels are assumed to be the same at all times, whereas we allow them to vary over time.

3 Hidden Markov models in Markov categories

In this section, we develop the notions of Markov chains and hidden Markov models in the language of categorical probability, including their characterizations in terms of Markov properties. Instantiating these results in `FinStoch` and `BorelStoch` then recovers the standard discrete theory as well as the general theory of Markov chains on standard Borel spaces. Instantiating it in `FinSetMulti` specializes it to a theory of finite nondeterministic automata.

3.1 Markov chains

Classically, a discrete-time Markov chain is defined as a sequence of random variables¹⁷ x_0, x_1, \dots, x_n taking values in a common (say discrete) **state space** X , such that the sequence satisfies the **Markov property**

$$\mathbb{P}(x_t = \chi_t \mid x_{t-1} = \chi_{t-1}, \dots, x_0 = \chi_0) = \mathbb{P}(x_t = \chi_t \mid x_{t-1} = \chi_{t-1}) \quad (3.1)$$

for all $1 \leq t \leq n$ and $\chi_0, \dots, \chi_n \in X$.¹⁸ A more abstract way to view this equation is to express it as the conditional independence

$$x_t \perp x_{[t-2]} \mid x_{t-1} \quad \forall t = 1, \dots, n,$$

where $x_{[t-2]}$ denotes the tuple of random variables (x_0, \dots, x_{t-2}) . Moreover, such a sequence is called **time-homogeneous** if the conditionals on the right-hand side of (3.1) are independent of t .

A well-known different definition of Markov chain specifies how the joint distribution is generated: one starts with an **initial distribution** f_0 corresponding to the law of x_0 , and a **transition kernel** $f: X \rightarrow X$, in terms of which the joint distribution should be given by

$$\mathbb{P}(x_n = \chi_n, \dots, x_0 = \chi_0) = f_0(\chi_0) \prod_{i=1}^n f(\chi_i \mid \chi_{i-1}).$$

One then proves that the $(x_t)_{t \in [n]}$ form a time-homogeneous Markov chain if and only if there exist f_0 and f such that the joint distribution factorizes like this.

The following result is an equivalence of this type in the setting of Markov categories. We do not assume homogeneity in time, and we even allow the state space itself to vary in time. As is standard, we also consider two versions of the Markov property, a *local* one as above and a *global* one having additional conditional independences that are implied by the local ones. We refer to [13] for background on conditional independence and Markov properties in the language of Markov categories.

Proposition 3.1. *Let \mathcal{C} be a Markov category with conditionals. Then the following are equivalent for any $p: I \rightarrow \bigotimes_{t \in [n]} X_t$ in \mathcal{C} :*

(a) **Local Markov property:** p displays the conditional independence¹⁹

$$X_t \perp X_{[t-2]} \mid X_{t-1} \quad \forall t = 1, \dots, n.$$

¹⁷We use lowercase notation for random variables since we exclusively reserve uppercase symbols for objects in Markov categories (typically measurable spaces serving as states spaces or observation spaces).

¹⁸When assuming a discrete state space, this equation only needs to be considered for those sequences of values for which the left-hand side is well-defined, i.e. for which $\mathbb{P}(x_{t-1} = \chi_{t-1}, \dots, x_0 = \chi_0) > 0$.

¹⁹The $t = 1$ case of this condition is trivial because of $X_{[1-2]} = X_\emptyset = I$, so it would be enough to consider $t = 2, \dots, n$ only.

(b) **Global Markov property:** p displays the conditional independence

$$X_R \perp X_T \mid X_S$$

for all disjoint sets $R, S, T \subseteq [n]$ such that for every $r \in R$ and $t \in T$ there is $s \in S$ between r and t , meaning $r < s < t$ or $r > s > t$.

(c) With the convention $X_{-1} := I$, there is a sequence of morphisms $(f_t: X_{t-1} \rightarrow X_t)_{t=0}^n$ such that

$$(3.2)$$

In (3.2), the bending of the wires has no formal meaning, and we only need them to be able to draw the diagram horizontally. The statement is a special case of the **categorical d -separation** criterion [13, Theorem 28], which shows equivalences of this kind for arbitrary causal structures, and we thus omit the proof.

Definition 3.2. When the equivalent conditions of Proposition 3.1 hold, we say that p is a **Markov chain** in \mathcal{C} . In this case:

- (a) The object X_t is called the **state space at time t** .
- (b) The morphism $f_0: I \rightarrow X_0$ is the **initial distribution** of the chain, and the morphisms $(f_t: X_{t-1} \rightarrow X_t)_{t=1}^n$ are the **transition kernels**.²⁰
- (c) We call p **time-homogeneous** if the transition kernels f_t can be taken to be independent of t (which requires in particular the state spaces X_t to be independent of t).

Remark 3.3. Traditionally, a Markov chain is defined over unbounded time as an *infinite* sequence of random variables $(x_t)_{t \in \mathbb{N}}$, with their joint distribution forming a probability measure on an infinite product space. Extending this to the categorical setting is straightforward in terms of countable Kolmogorov products [15], but we will not consider this here.

Example 3.4. We now describe Markov chains in the concrete Markov categories from Example 2.4.

- (i) In FinStoch, a Markov chain is given by

$$p(x_0, \dots, x_n) = f_0(x_0) \cdot \prod_{t=1}^n f_t(x_t \mid x_{t-1}), \quad (3.3)$$

²⁰As with conditionals in general (Remark 2.11), the transition kernels are uniquely determined by p up to almost sure equality.

where f_0 is a discrete probability distribution on X_0 , and the f_t are stochastic matrices for $t \geq 1$. These f_t are called **transition matrices** and form the textbook definition of Markov chains for discrete state spaces [42, Section 4.1].

- (ii) In **BorelStoch**, a Markov chain extends **FinStoch** to standard Borel spaces X_t , with the joint distribution determined by

$$p(S_0 \times \cdots \times S_n) = \int_{x_0 \in S_0} \cdots \int_{x_n \in S_n} f_0(dx_0) \cdot \prod_{t=1}^n f_t(dx_t | x_{t-1})$$

for all measurable $S_t \subseteq X_t$.

- (iii) In **Gauss**, a Markov chain is defined by a Gaussian vector $x_0 = \mathcal{N}(v_0, Q_0)$ and relations

$$x_t = F_t x_{t-1} + \mathcal{N}(v_t, Q_t)$$

for $t = 1, \dots, n$, where F_t is a linear map, and v_t and Q_t are means and covariances of independent Gaussian noise terms as in Example 2.4.

- (iv) In **FinSetMulti**, a Markov chain follows (3.3), but with $f_0: X_0 \rightarrow \{0, 1\}$ as an initial possibility distribution and transition matrices $f_t: X_{t-1} \times X_t \rightarrow \{0, 1\}$. For each $x_t \in X_t$, there exists at least one $x_{t+1} \in X_{t+1}$ such that $f_{t+1}(x_{t+1} | x_t) = 1$. Thus f_0 specifies allowed initial states and f_t defines allowed transitions. The joint distribution $p: I \rightarrow \bigotimes_{t=0}^n X_t$ gives the set of possible trajectories (x_0, \dots, x_n) .

A time-homogeneous Markov chain in **FinSetMulti** is therefore the same thing as a **non-deterministic finite automaton** with trivial input and at least one outgoing transition per state.

Remark 3.5. Given a Markov category \mathcal{C} and an object W of \mathcal{C} , there is a **parametric Markov category** \mathcal{C}_W associated to it [16, Section 2.2]. \mathcal{C}_W has the same objects as \mathcal{C} , but the morphisms have an extra dependence on a parameter represented by W : a morphism $X \rightarrow Y$ in \mathcal{C}_W is a morphism $W \otimes X \rightarrow Y$ in \mathcal{C} .²¹ It is also known that if \mathcal{C} has conditionals, then so does \mathcal{C}_W [16, Lemma 2.10]. A Markov chain in \mathcal{C}_W looks like

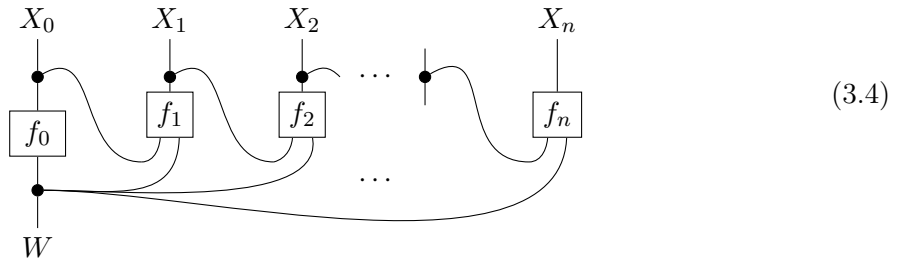

²¹Equivalently, \mathcal{C}_W is the co-Kleisli category of the so-called *reader comonad* $W \otimes -$ on \mathcal{C} .

This illustrates again that W can be thought of as an “external” parameter that is fed into each of the transition kernels. Since all of our results apply to parametric Markov categories as well, we automatically obtain the corresponding results with additional (measurable) dependence on a parameter.

3.2 Hidden Markov models

We now consider **hidden Markov models**, which consist of a Markov chain of hidden states and a sequence of observations $g_t: X_t \rightarrow Y_t$. The observations by themselves do typically not form a Markov chain, as they lack the local Markov property: knowing an earlier observation can refine predictions about future observations, even given the present one.

Notation 3.6. For families of objects $(X_t)_{t \in [n]}$ and $(Y_t)_{t \in [n]}$, we write:

(a) $(X \otimes Y)_{[t]}$ as shorthand for $\bigotimes_{i \in [t]} (X_i \otimes Y_i)$.

Given a state $p: I \rightarrow (X \otimes Y)_{[n]}$, we write:

(b) $p_{[t]}$ for the marginal of p up to time t , i.e. the marginal on $(X \otimes Y)_{[t]}$.

(c) p^X for the marginal of p on $X_{[n]}$, and similarly p^Y for the marginal of p on $Y_{[n]}$.

Both notations can also be combined to $p_{[t]}^X$ and $p_{[t]}^Y$.

Proposition 3.7. Let \mathcal{C} be a Markov category with conditionals with two families of objects $(X_t)_{t \in [n]}$ and $(Y_t)_{t \in [n]}$. Then the following are equivalent for any state $p: I \rightarrow (X \otimes Y)_{[n]}$:

(i) The **backward Markov property**:

$$(a) X_t \perp X_{[t-2]}, Y_{[t-1]} \mid X_{t-1} \quad \forall t = 1, \dots, n,$$

$$(b) Y_t \perp Y_{[t-1]}, X_{[t-1]} \mid X_t \quad \forall t = 1, \dots, n.$$

(ii) The **local Markov property**:

$$(a) X_t \perp X_{[t-2]}, Y_{[t-1]} \mid X_{t-1} \quad \forall t = 1, \dots, n,$$

$$(b) Y_t \perp X_{[n] \setminus \{t\}}, Y_{[n] \setminus \{t\}} \mid X_t \quad \forall t = 0, \dots, n.$$

(iii) The **global Markov property**: for all disjoint sets $R, S, T \subseteq [n]$ and disjoint sets $U, V, W \subseteq [n]$ such that

$$\forall r \in R, t \in T \exists s \in S: s \text{ is between } r \text{ and } t$$

and

$$\forall u \in U, w \in W \exists s \in S: s \text{ is non-strictly between } u \text{ and } w$$

we have

$$X_R, Y_U \perp X_T, Y_W \mid X_S, Y_V.$$

(iv) There exist a state $f_0: I \rightarrow X_0$ and sequences of morphisms

$$f_t: X_{t-1} \rightarrow X_t, \quad g_t: X_t \rightarrow Y_t, \quad t = 0, \dots, n$$

such that

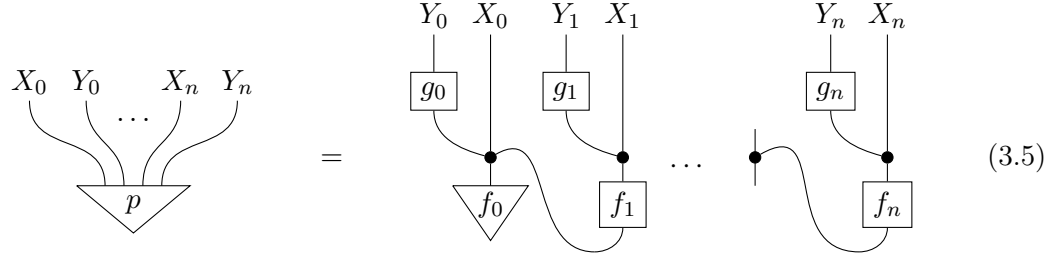

These Markov properties are rarely considered in the traditional hidden Markov model literature. The backward Markov property is noted in [26], and two special cases of the global Markov property appear in [7, Corollary 2.2.5]. However, we have found no references proving the above equivalences in measure-theoretic probability. Our approach delivers on this simply by instantiating the proposition in **BorelStoch**.

Proof. The equivalence (ii) \iff (iii) \iff (iv) is precisely [13, Theorem 34] applied to the causal structure displayed in (3.5).

To show that the local Markov property (ii) implies the backward Markov property (i), note that Condition (a) is shared by both. Condition (b) of the backward Markov property follows from Condition (b) of the local Markov property by marginalizing out $X_{[n]\setminus[t]}$ and $Y_{[n]\setminus[t]}$, which preserves conditional independence [12, Lemma 12.5(b)].

The proof that the backward Markov property (i) is sufficient for p to have the form (3.5) is analogous to the proof of [13, Theorem 34] (iii) \implies (i). \square

Definition 3.8. When the equivalent conditions of Proposition 3.7 hold, we say that p is a *hidden Markov model* in \mathcal{C} . In this case:

- (a) The object Y_t is called the **observation space at time t** .
- (b) The morphisms $(g_t: X_t \rightarrow Y_t)_{t=0, \dots, n}$ are the **observation kernels**.
- (c) We call p **time-homogeneous** if both the transition kernels f_t and the observation kernels g_t can be taken to be independent of t (which requires, in particular, the state spaces X_t and observation spaces Y_t to be independent of t).

So, most concretely, we can say that a hidden Markov model in \mathcal{C} is specified by a Markov chain $(f_t: X_{t-1} \rightarrow X_t)_{t=1}^n$ with initial distribution $f_0: I \rightarrow X_0$ and an additional sequence of morphisms $(g_t: X_t \rightarrow Y_t)_{t=0}^n$.

Example 3.9. We describe hidden Markov models in the Markov categories from Example 2.4.

(i) In **FinStoch**, a hidden Markov model is described by

$$p(x_0, y_0, \dots, x_n, y_n) = \prod_{t=0}^n f_t(x_t | x_{t-1}) \cdot g_t(y_t | x_t), \quad (3.6)$$

where x_{-1} is the sole element of $X_{-1} := I$, and the f_t and g_t are stochastic matrices. The g_t are also called **emission probabilities**.

(ii) In **BorelStoch**, hidden Markov models generalize those in **FinStoch**, allowing arbitrary standard Borel spaces for states and observations, and arbitrary measurable transition and observation kernels. Despite this generality, Proposition 3.7 applies and proves the characterization in terms of Markov properties in a way that completely avoids measure theory.²²

(iii) In **Gauss**, a hidden Markov model is defined by

$$x_t = A_t x_{t-1} + \mathcal{N}(v_t, Q_t), \quad y_t = H_t x_t + \mathcal{N}(w_t, R_t),$$

where A_t and H_t are matrices, and $x_{-1} = 0$ due to $X_{-1} = I = \mathbb{R}^0$. Thus, x_t and y_t are affine functions of the respective previous state and current state, with Gaussian noise added. These are the classical Gaussian hidden Markov models [39].

(iv) In **FinSetMulti**, a hidden Markov model extends the nondeterministic finite automaton interpretation of Markov chains from Example 3.4. The maps $g_t: X_t \rightarrow Y_t$ determine the possible outputs for each state. A sequence y_0, \dots, y_n is possible if and only if there exists a valid sequence x_0, \dots, x_n such that each y_t is possible according to g_t with input x_t .

This is closely related to the definition of **labelled transition system**, where one has a single sequence of morphisms

$$h_t: X_{t-1} \rightarrow X_t \times Y_t$$

which output a state and observation pair at each step. Such a labelled transition system is a hidden Markov model in our sense if these morphisms have the specific form

$$\begin{array}{c} Y_t \quad X_t \\ | \quad | \\ \boxed{h_t} \\ | \\ X_{t-1} \end{array} = \begin{array}{c} Y_t \quad X_t \\ | \quad | \\ \boxed{g_t} \\ | \quad | \\ \bullet \\ | \\ \boxed{f_t} \\ | \\ X_{t-1} \end{array} \quad (3.7)$$

but not in general. It would be possible to generalize our definition of hidden Markov models to match the definition of labelled transition system by combining the f_t and g_t into one morphism h_t , as some literature does also in the probabilistic setting [8], but we have chosen to stick to the more commonly encountered notion.

²²Measure theory is needed only for the proof that **BorelStoch** is a Markov category with conditionals.

4 The Bayes filter in Markov categories

Throughout this section, we work in a Markov category \mathcal{C} with conditionals and consider a hidden Markov model in the notation of Definition 3.8. As mentioned, the idea is to model situations in which a system evolves in a Markovian fashion, but the states of the system are only indirectly observable through noisy observations. A natural problem to ask now is, given a sequence of observations $(y_i)_{i=0}^t$ up to a time t , with $y_i \in Y_i$, what can we infer about the hidden state $x_t \in X_t$? This is precisely the problem of filtering.

4.1 The Bayes filter

Using Bayesian inference, answering the filtering question amounts to conditioning x_t with respect to the given sequence of observations y_0, \dots, y_t . Here is the formulation in our categorical setting.

Definition 4.1. For $p: I \rightarrow (Y \otimes X)_{[n]}$ a hidden Markov model, the **Bayes filter** at time $t \in [n]$ is the conditional²³

$$\text{BF}_t := a.s. \quad (4.1)$$

The marginalizations on the right-hand side are precisely those over the state spaces X_0, \dots, X_{t-1} . We can therefore also phrase this definition in the following form: the Bayes filter at time t is any morphism $\text{BF}_t: Y_{[t]} \rightarrow X_t$ such that

$$(4.2)$$

By Remark 2.11, BF_t is often not strictly unique. For example in FinStoch , on a sequence of outcomes y_0, \dots, y_t which has probability zero, BF_t is completely arbitrary, which intuitively means that we can make an arbitrary inference about the hidden state. We nevertheless speak of *the* Bayes filter, as the choice is unique up to $p_{[t]}^Y$ -a.s. equality.

²³See Notation 2.12 for the dashed box and bent wire notation.

Since the definition of BF_t is difficult to work with in practice due to the space $Y_{[t]}$ that we condition on having size exponential in t (when it is finite), it is useful to have recursion formulas that unravel this complexity.

Proposition 4.2. *The Bayes filter can be recursively computed through conditionals as²⁴*

$$(4.3)$$

for all $t = 0, \dots, n$, where we take $\text{BF}_{-1} := \text{id}_I$.

Setting $\text{BF}_{-1} := \text{id}_I$ makes sense insofar as before time 0, there are no observations and no hidden state, so that the Bayes filter at that time takes no input and produces no output, and the first recursion step gives

$$(4.4)$$

This makes BF_0 a Bayesian inverse $(g_0)_{f_0}^\dagger$ in the sense of [9, Definition 3.5].

Proof. Starting with the definition (4.1), we expand $p_{[t]}$ via (3.5) and use Proposition 2.13(a)

²⁴This formulation was suggested to us by Dario Stein.

to split it into two conditionals,

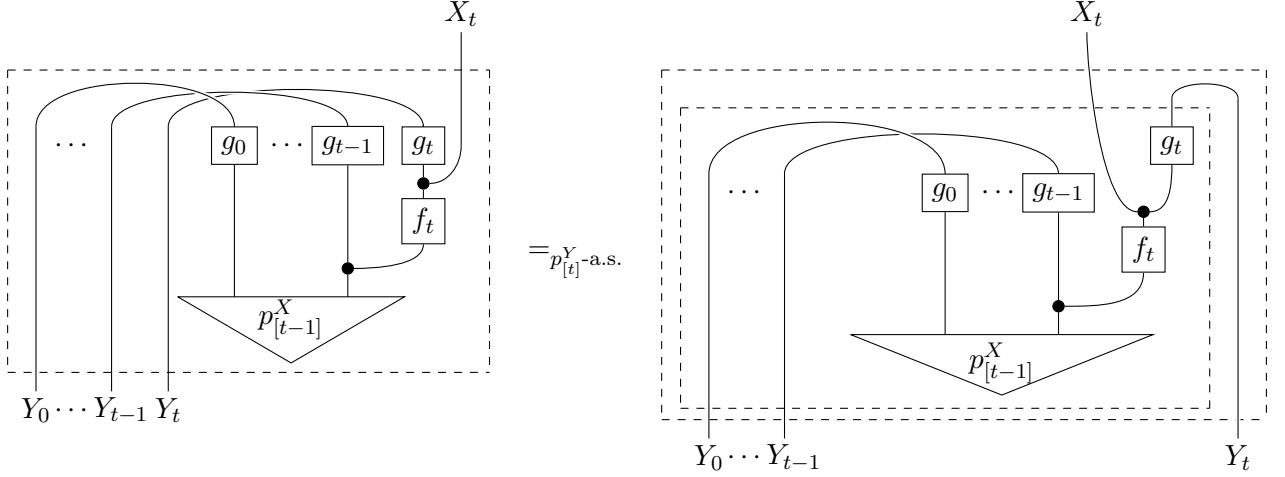

where we have moved the Y_t input to right to obtain a more convenient way of drawing the diagram. An application of Proposition 2.13(b) lets us rewrite the diagram further to

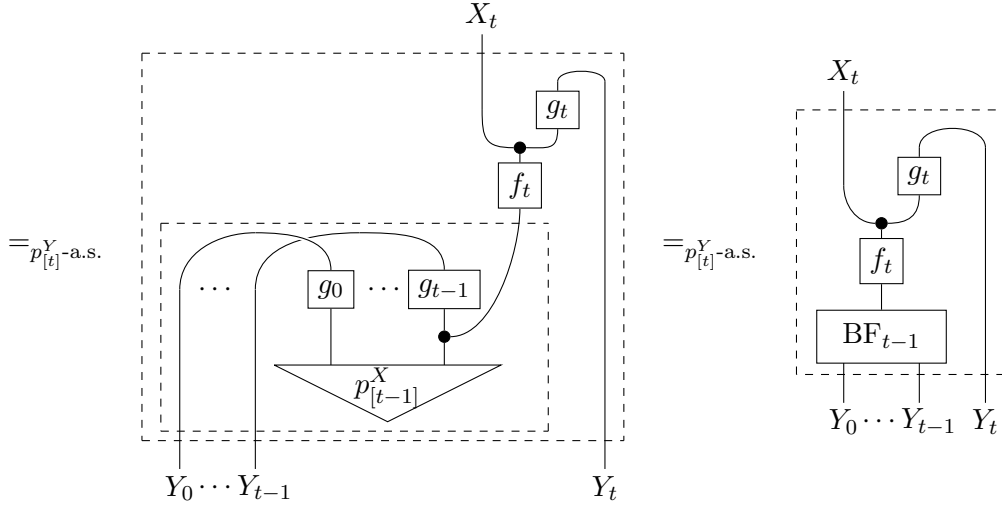

since the inner conditional is precisely the definition of BF_{t-1} . This reasoning is still valid for $t = 0$ if we take all objects and morphisms at time -1 to be given by I and id_I , respectively. \square

We will consider instances of the Bayes filter in the usual Markov categories of interest in the subsequent subsections and end here with a few general remarks.

Remark 4.3. What happens when we instantiate the Bayes filter in a parametric Markov category \mathcal{C}_W , in the style of Remark 3.5? This is possible, as our constructions again apply to that case, and we thereby automatically obtain a Bayes filter with parameters.

The conditionals in a parametric Markov category \mathcal{C}_W can be constructed as conditionals in \mathcal{C} of their representatives [16, Lemma 2.10]. Therefore, the Bayes filter of a hidden Markov

model in a parametric Markov category is represented simply by the corresponding conditional in \mathcal{C} . This reproduces the intuitive idea that the Bayes filter for a hidden Markov model with measurable dependence on a parameter should be the Bayes filter for each of the parameter values, and it guarantees that this filter can be chosen to have measurable dependence on the parameter.

Remark 4.4. A treatment of hidden Markov models and Bayesian filtering in the setting of Markov categories can also be found in a recent paper by Virgo [48] based on *stochastic Mealy machines*. This amounts to considering time-homogeneous hidden Markov models but generalized to the form $X \rightarrow Y \otimes X$, where the transition kernel and observation kernel is unified into one morphism as in (3.7), and in addition also allowing *inputs*,²⁵ which we do not consider in this paper.

Virgo’s work adopts a perspective slightly different from ours. Fixing an observation space Y , he forms a category $\text{Generator}(Y)$ having generalized hidden Markov models (in his sense) with observation space Y as objects and morphisms those maps between the state spaces which preserve the structure [48, Section 2.1]. Assuming that the Markov category in question is *strongly representable*, Virgo then extends Bayesian filtering to a functor out of the category $\text{Generator}(Y)$. This can be seen as functorially converting a hidden Markov model into a machine that updates Bayesian priors. It is further shown that this Bayesian filtering functor is a right adjoint [48, Theorem 2.6].

While Virgo’s hidden Markov models are partly more restrictive (time-homogeneous) and partly more general than ours, his work is complementary to ours insofar as it is concerned with different aspects of the Bayes filter. For instance, Virgo does not prove any version of Proposition 4.2, focusing instead on the adjunction of [48, Theorem 2.6] and its consequences (such as constructing conjugate priors).

Remark 4.5. In the recent preprint [46], Tull, Kleiner and Smithe develop the theory of active inference in the framework of CD categories with *caps* and *normalizations*. This is done as a part of an overarching programme to develop a categorical approach to predictive processing. The primary focus is to describe an approximate updating procedure based on energy minimization, which is done for a wide class of structures called *open generative models*. Of these, the *discrete time open generative models* of Section 3.2 are essentially our hidden Markov models.

However, the authors focus primarily on the category FinStoch and on a single update step, but entertain greater complexity there by considering updating on non-deterministic observations, which makes Bayesian inversion branch into various versions like Jeffrey updating and Pearl updating. Thus their work is complementary to ours, as we focus on the recursive computation of the Bayes filter and smoother in the greater generality of all Markov categories with conditionals.

²⁵These can be used to extend the framework to Markov decision processes, for instance.

4.2 The instantiated Bayes filter

Per Proposition 4.2, the Bayes filter BF_t is given by a conditional involving BF_{t-1} , f_t and g_t . However, this conditional is still too cumbersome to work with in practice, as its domain $Y_{[t]} = Y_0 \otimes \cdots \otimes Y_{t-1}$ still typically grows exponentially in t . For this reason, we introduce the **instantiated Bayes filter** here, which specializes the Bayes filter to a *fixed* sequence of observations. This simplifies the recursive computation of the conditional (see Proposition 4.7) and recovers standard filters like the Kalman filter in the Gaussian case (see Section 4.3.4). The price to pay is that one does not compute the whole filter BF_t , but only its value on a particular sequence of inputs.

Definition 4.6. *Given a sequence of deterministic morphisms*

$$y_0: I \rightarrow Y_0, \quad y_1: I \rightarrow Y_1, \quad \dots, \quad y_t: I \rightarrow Y_t,$$

which we abbreviate by $\mathbf{y}_{[t]}$, the **instantiated Bayes filter** is

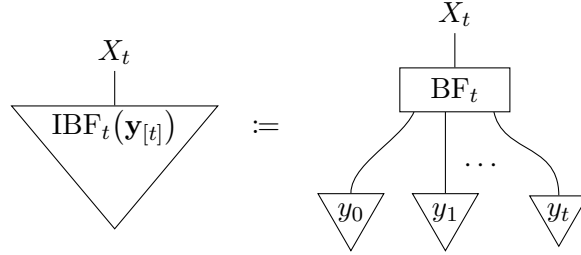

The non-uniqueness of BF_t discussed before now has more severe consequences, as the instantiated Bayes filter is not well-defined in general. We will discuss this further in the case of BorelStoch in Section 4.3.2.

We have the following recursive formula for IBF_t analogous to Proposition 4.2.

Proposition 4.7. *The instantiated Bayes filter can be recursively computed through conditionals as*

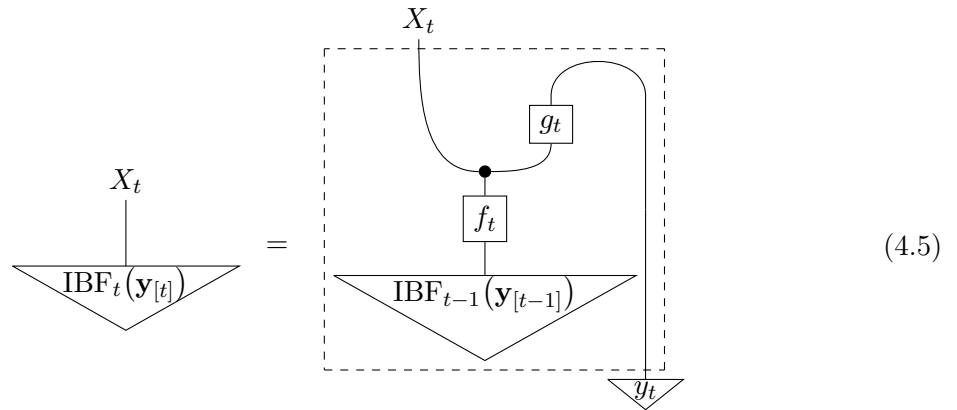

for all $t = 0, \dots, n$, where we take $\text{IBF}_{-1} := \text{id}_I$.

So explicitly, the $t = 0$ case is given by

$$(4.6)$$

Each step of the recursion involves a *choice* of conditional, and making such choices throughout the recursion merely results in *one version* of the instantiated Bayes filter.

Proof. Plugging in Proposition 4.2 implies that

where we have used Proposition 2.13(c)²⁶ together with the definition of $\text{IBF}_{t-1}(\mathbf{y}_{[t-1]})$ \square

The formula (4.5) allows us to compute our posterior distribution for the hidden state x_t through the following two steps:

- (a) **Prediction step:** We use the posterior from our previous guess for the hidden state x_{t-1} and apply the transition kernel f_t in order to predict the next hidden state x_t .
- (b) **Update step:** We use the observation y_t and our knowledge of the observation kernel g_t to update our guess for the hidden state x_t by conditioning on the observation at time t being y_t .

This is the known procedure for the classical Bayes filter [40, Theorem 4.1], but now generalized to the categorical setting.

²⁶This is where the determinism assumption on the y_i enters.

4.3 Examples of the instantiated Bayes filter

In the following, we show that the instantiated Bayes filter recovers known filters for suitable choices of Markov categories. This includes the discrete Bayes filter in the case of **FinStoch** as well as the Kalman filter in the case of **Gauss**.

4.3.1 The instantiated Bayes filter in **FinStoch**

We now consider the instantiated Bayes filter in the Markov category **FinStoch** explicitly, a procedure sometimes called the **forward algorithm**.²⁷ As in Example 3.9, the hidden Markov model up to time $t \in [n]$ is a probability distribution on the product of the finite sets $(X_i)_{i=0}^t$ and $(Y_i)_{i=0}^t$. It is “categorical” in the sense of these sets being finite. The sequence of deterministic morphisms $\mathbf{y}_{[t]}$ is a sequence of observed values $y_0 \in Y_0, \dots, y_t \in Y_t$. To then compute the instantiated Bayes filter IBF_t recursively, we consider the prediction and update steps as explained above separately. The prediction step produces the distribution $q_t: I \rightarrow X_t$ given by

$$q_t(x_t) := \sum_{x_{t-1}} f_t(x_t | x_{t-1}) \cdot \text{IBF}_{t-1}(\mathbf{y}_{[t-1]})(x_{t-1}) \quad (4.7)$$

for $t > 0$, and $q_0 = f_0$ to get the recursion going. Performing the update step on top of that results in

$$\text{IBF}_t(\mathbf{y}_{[t]})(x_t) = \frac{g_t(y_t | x_t) q_t(x_t)}{\sum_{x'_t} g_t(y_t | x'_t) q_t(x'_t)}. \quad (4.8)$$

This equation agrees with the Bayes filter in its standard form for discrete variables [38, Eq. (1.25)]. It is worth noting that the right-hand side is well-defined whenever the denominator is nonzero, while $\text{IBF}_t(\mathbf{y}_{[t]})$ is an arbitrary distribution whenever the denominator is zero. This is not an issue in the present discrete case since the denominator is nonzero for all y_t that can occur as part of a sequence of observations with nonzero probability.

4.3.2 The instantiated Bayes filter in **BorelStoch**

This construction immediately generalizes to **BorelStoch**. So now our X_i and Y_i are standard Borel spaces, and the $f_i: X_{i-1} \rightarrow X_i$ and $g_i: X_i \rightarrow Y_i$ are measurable Markov kernels. Again we have a sequence of observations $y_0 \in Y_0, \dots, y_{t-1} \in Y_{t-1}$. For $t > 0$, the prediction step constructs a probability measure $q_t: I \rightarrow X_t$ given by

$$q_t(S) := \int_{x_{t-1} \in X_{t-1}} f_t(S | x_{t-1}) \cdot \text{IBF}_{t-1}(\mathbf{y}_{[t-1]})(dx_{t-1}),$$

for every measurable $S \subseteq X_t$, which is the generalization of (4.7) in **BorelStoch**, and with initial condition $q_0 := f_0$. The update step is more subtle: every individual observation value y_t , or entire observation sequence $\mathbf{y}_{[t]}$, typically has probability zero, and we run into the issue

²⁷See Remark 5.7.

that conditioning on events of probability zero is ill-defined.²⁸ Hence, the instantiated Bayes filter $\text{IBF}_t(\mathbf{y}_{[t]})$ is completely arbitrary for every probability zero sequence $\mathbf{y}_{[t]}$, which is the typical case with continuous variables. What can be considered more well-defined—as per the uniqueness of conditionals up to almost sure equality—is the *totality* of values $\text{IBF}_t(\mathbf{y}_{[t]})$ for all $\mathbf{y}_{[t]}$, which is our Bayes filter BF_t again.

With this in mind, we can explicate the update step: it is given by the formation of product regular conditional probabilities, which amounts to the implicit equation

$$\int_{y_t \in T} \int_{x_t \in X_t} \text{IBF}_t(\mathbf{y}_{[t]})(S) g_t(dy_t | x_t) q(dx_t) = \int_{x_t \in S} g_t(T | x_t) q(dx_t)$$

for all measurable $S \subseteq X_t$ and $T \subseteq Y_t$. This follows as an instance of [12, Example 11.3], and can be interpreted as follows: both sides represent the probability that the hidden state x_t is in S and that the observation y_t is in T , and $\text{IBF}_t(\mathbf{y}_{[t]})$ is constructed precisely such that this probability can be calculated as on the left-hand side.

[7, Proposition 3.1.4] gives a similar filtering formula for hidden Markov models of continuous variables with the additional restriction that the processes $g_t(dy_t | x_t)$ need to be absolutely continuous for all x_t with respect to a single measure.

4.3.3 The instantiated Bayes filter in FinSetMulti

We turn to the **possibilistic Bayes filter**, by which we mean the Bayes filter in FinSetMulti. This seems to have not been considered before.

Given a hidden Markov model as in Example 3.9(iv), the prediction step for the instantiated Bayes filter again takes the form

$$q_t(x_t) := \sum_{x_{t-1}} f_t(x_t | x_{t-1}) \cdot \text{IBF}_{t-1}(\mathbf{y}_{[t-1]})(x_{t-1}). \quad (4.9)$$

This now means that x_t is considered possible if and only if x_{t-1} is possible according to our previous estimate of the hidden state $\text{IBF}_{t-1}(\mathbf{y}_{[t-1]})$ and x_t is possible according to the transition kernel f_t . Choosing conditionals as in Example 2.10(d) and using the general prescription shows that the update step is given simply by

$$\text{IBF}_t(\mathbf{y}_{[t]})(x_t) = g_t(y_t | x_t) \cdot q_t(x_t). \quad (4.10)$$

Since this multiplication amounts to a logical conjunction of possibilities, this now means that the state x_t is considered possible if and only if it was considered possible before and is in addition compatible with the observed y_t according to the observation map g_t .

²⁸Compare Remark 2.11 and the Borel–Kolmogorov paradox [20, Section 15.7], which illustrates that this lack of uniqueness is not an issue with our formalism but rather an unavoidable complication in measure-theoretic probability quite generally.

Example 4.8. Let us work through a simple example of a hidden Markov model in `FinSetMulti` and the possibilistic filter. Consider first the time-homogeneous Markov chain—or equivalently as a nondeterministic automaton—on a three-element set $X = \{a, b, c\}$ with possible transitions like this:

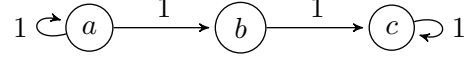

Our transition kernels f_t are all the same for $t > 0$ by time-homogeneity, and we thus omit the index t . In matrix form, the transition kernel f is given by²⁹

$$f = (f(x'|x))_{x,x' \in \{a,b,c\}} = \begin{pmatrix} 1 & 0 & 0 \\ 1 & 0 & 0 \\ 0 & 1 & 1 \end{pmatrix}.$$

Suppose that our chain starts at a , which means that our initial state is $f_0 = [1, 0, 0]^t$.

Let us consider observation morphisms $g_t: \{a, b, c\} \rightarrow \{\perp, \top\}$ that are also independent of t and given by the matrix

$$g = (g(y|x))_{y \in \{\perp, \top\}, x \in \{a,b,c\}} = \begin{pmatrix} 1 & 1 & 0 \\ 0 & 1 & 1 \end{pmatrix}.$$

Thus the hidden state a is always observed as \perp , the hidden state c as \top , and b as either. Given the underlying Markov chain, it is clear that the possible sequences of observations are as follows: a sequence of \perp 's as long as the hidden state is a , possibly followed by an arbitrary sequence of \perp and \top while it is b , possibly followed by only \top 's if the chain proceeds to its terminal state c .

Now, let's compute the instantiated Bayes filter by doing the prediction and update steps. For time $t = 0$, the prediction coincides with the initial distribution: $q_0 = f_0$. On $y_0 = \perp$ as the only possible initial observation, the initial update step gives

$$\text{IBF}_0(\perp) = \begin{pmatrix} g(\perp|a) q_0(a) \\ g(\perp|b) q_0(b) \\ g(\perp|c) q_0(c) \end{pmatrix} = \begin{pmatrix} 1 \\ 0 \\ 0 \end{pmatrix}.$$

This tells us what we already knew: the initial state must have been a with certainty. The other instance $\text{IBF}_0(\top)$ depends on the choice of conditional, since $y_0 = \top$ is not possible under the initial state a . Using the choice of conditional (4.10), we get $\text{IBF}_0(\top) = \text{IBF}_0(\perp)$, in line with the fact that the initial observation does not tell us anything new about the hidden state.

Suppose now that our sequence of observations up to $t = 2$ is $\mathbf{y}_{[2]} = (\perp, \perp, \top)$. At time $t = 1$, the chain can a priori be in state a or b . Indeed using the `FinSetMulti`-arithmetic $1+1 = 1$

²⁹So $f(x'|x) = 1$ if it is possible to reach x' from x in one step. This matrix representation is the transpose of transition matrices as conventionally used for Markov chains in discrete probability theory.

in the prediction step (4.9) gives

$$q_1 = f \text{ IBF}_0(\perp) = \begin{pmatrix} 1 & 0 & 0 \\ 1 & 0 & 0 \\ 0 & 1 & 1 \end{pmatrix} \begin{pmatrix} 1 \\ 0 \\ 0 \end{pmatrix} = \begin{pmatrix} 1 \\ 1 \\ 0 \end{pmatrix}.$$

Applying the update step (4.10) produces

$$\text{IBF}_1(\perp, \perp) = \begin{pmatrix} g(\perp|a) q_1(a) \\ g(\perp|b) q_1(b) \\ g(\perp|c) q_1(c) \end{pmatrix} = \begin{pmatrix} 1 \\ 1 \\ 0 \end{pmatrix}.$$

So with our second observation having been $y_1 = \perp$, we cannot distinguish between the hidden states a and b , but we can be sure that the chain is not in state c .

Now at time $t = 2$, and before we take the observation $y_2 = \top$ into account, the chain can be in any of the three states: the prediction step (4.9) gives

$$q_2 = f \text{ IBF}_1(\perp, \perp) = \begin{pmatrix} 1 & 0 & 0 \\ 1 & 0 & 0 \\ 0 & 1 & 1 \end{pmatrix} \begin{pmatrix} 1 \\ 1 \\ 0 \end{pmatrix} = \begin{pmatrix} 1 \\ 1 \\ 1 \end{pmatrix}.$$

At this point, the third observation $y_2 = \top$ finally gives us nontrivial information: using the update step (4.10), we find $\text{IBF}_2(\perp, \perp, \top) = (0, 1, 1)^t$, which again is intuitively clear as the observed value $y_2 = \top$ has excluded the hidden state a .

4.3.4 The Kalman filter as the instantiated Bayes filter

The Kalman filter is the special case of the Bayes filter for Gaussian distributions. It was initially formulated as an optimization problem [23, 24] and considered from a Bayesian perspective only later [18]. This re-derivation utilized a version of Bayes' rule for probability density functions: the equations for the prediction and update steps were obtained from the parametrization of the probability densities for multivariate Gaussian distributions.

Here, we show that in the Markov category **Gauss**, our instantiated Bayes filter turns into a mildly generalized version of the Kalman filter. So as in Example 3.9(iii), the $(x_t)_{t=0}^n$ and $(y_t)_{t=0}^n$ are Gaussian vectors which are related via

$$x_t = A_t x_{t-1} + \mathcal{N}(v_t, Q_t), \quad y_t = H_t x_t + \mathcal{N}(w_t, R_t),$$

where our notation loosely follows that of [40, Section 4.3]. In particular, we write m_t and P_t for the mean and covariance matrix of the Gaussian distribution of $\text{IBF}_t(\mathbf{y}_{[t]})$, so that

$$\text{IBF}_t(\mathbf{y}_{[t]}) = \mathcal{N}(m_t, P_t).$$

We may think of m_t as our best guess of the hidden state given the observations up to time t , while the covariance matrix P_t measures our uncertainty in this guess. We suppress the dependence on $\mathbf{y}_{[t]}$ from the notation. The problem solved by the Kalman filter is the calculation of m_t and P_t recursively from m_{t-1} and P_{t-1} together with the new observation y_t .

For the prediction step, we simply apply the transition kernel f_t to $\text{IBF}_{t-1}(\mathbf{y}_{[t-1]})$. By the composition formula in Gauss (2.3), this produces a new Gaussian with parameters

$$\tilde{m}_t = A_t m_{t-1} + v_t, \quad \tilde{P}_t = A_t P_{t-1} A_t^t + Q_t, \quad (4.11)$$

where the tildes remind us that this models the prediction obtained from the filter at time $t - 1$ before taking the observation y_t into account. The joint distribution with the expected observation y_t , or more formally the right-hand side of (4.5) before the conditioning, can then be calculated to be given by the Gaussian

$$\begin{pmatrix} x_t \\ y_t \end{pmatrix} = \mathcal{N}(a_t, C_t)$$

with parameters

$$a_t = \begin{pmatrix} \tilde{m}_t \\ H_t \tilde{m}_t + w_t \end{pmatrix} \quad \text{and} \quad C_t = \begin{pmatrix} \tilde{P}_t & \tilde{P}_t H_t^t \\ H_t \tilde{P}_t & S_t \end{pmatrix},$$

where

$$S_t := H_t \tilde{P}_t H_t^t + R_t \quad (4.12)$$

is the so-called **innovation covariance**. Now $\text{IBF}_t(\mathbf{y}_{[t]})$ is given by the conditional of this Gaussian with respect to y_t . Using the known formulas for conditionals in Gauss from Example 2.10(c) and introducing the **optimal Kalman gain**³⁰

$$K_t = \tilde{P}_t H_t^t S_t^- \quad (4.13)$$

as shorthand notation, we obtain that

$$\text{IBF}_t(\mathbf{y}_{[t]}) = \mathcal{N}(m_t, P_t)$$

with

$$m_t = \tilde{m}_t + K_t(y_t - H_t \tilde{m}_t - w_t), \quad P_t = (I - K_t H_t) \tilde{P}_t.$$

Together with (4.11), (4.12), and (4.13), these formulas form a mild generalization of the standard Kalman filter formulas [40, Theorem 4.2]: the latter are recovered as the special case $v_t = w_t = 0$, which amounts to assuming zero displacement and centered Gaussian noise for both the transition kernels and the observation kernels.

There are many other variations on the Kalman filter. For example, some Kalman filter variations use different representations of uncertainty to improve robustness to numerical error from matrix inversions in the Bayesian inversion step [4]. Others account for different structures in the state and measurement spaces, such as filters over Riemannian manifolds [29]. Many variations attempt to handle nonlinear transition kernels and observation maps by approximating their state propagations [3, 22]. Since the general predict-update structure is common to all of these, it is plausible that at least some of them can be captured by our current framework by choosing the appropriate Markov category, while others may require further generalizations.

³⁰As in Example 2.10(c), we write S_t^- for the Moore-Penrose pseudoinverse of S . In practice S_t will usually be invertible, and then simply $S_t^- = S_t^{-1}$.

4.4 The Bayes filter recursion as a single string diagram

For a given a sequence of observations as input, our Bayes filter BF_t should be thought of as returning a *sample* from the posterior distribution over the hidden state. Although that distribution itself is precisely what is specified by BF_t , it is not directly accessible as an output if one thinks of BF_t as a process that produces a random output. This situation changes in a representable Markov category (Definition 2.6). There BF_t has a deterministic counterpart $\text{BF}_t^\sharp: Y_{[t]} \rightarrow PX_t$, which can be thought of as the actual function that returns the posterior distribution and which recovers BF_t after composition with $\text{samp}: PX_t \rightarrow X_t$.

Throughout this section, we assume that our Markov category is a.s.-compatibly representable (Definition 2.8) in addition to having conditionals. By Remark 2.11, this ensures that the deterministic counterpart BF_t^\sharp is well-defined up to $p_{[t]}^Y$ -a.s. equality. Consider a hidden Markov model in the form of Proposition 3.7(iv) as before, our goal is then to rewrite the recursion for the Bayes filter in terms of BF_t^\sharp . This will allow us to draw it as a single string diagram.

Notation 4.9. For $t = 0, \dots, n$, let $u_t: PX_{t-1} \otimes Y_t \rightarrow X_t$ be the morphism

$$\begin{array}{c} X_t \\ | \\ \boxed{u_t} \\ | \quad | \\ PX_{t-1} \quad Y_t \end{array} \quad := \quad \begin{array}{c} X_t \\ | \\ \text{---} \bullet \text{---} \\ | \quad | \\ \boxed{g_t} \\ | \\ \boxed{f_t} \\ | \\ \boxed{\text{samp}} \\ | \quad | \\ PX_{t-1} \quad Y_t \end{array} \quad (4.14)$$

As before, this uses the convention that $X_{-1} = I$, and thus also $PX_{-1} = I$, so that $u_0 = \text{BF}_0$. Here is how the u_t act as update maps for the Bayes filter.

Proposition 4.10. We have

$$\begin{array}{c} X_t \\ | \\ \boxed{\text{BF}_t} \\ | \quad | \\ Y_0 \cdots Y_t \end{array} \quad =_{p_{[t]}^Y\text{-a.s.}} \quad \begin{array}{c} X_t \\ | \\ \boxed{u_t} \\ | \quad | \\ \boxed{\text{BF}_{t-1}^\sharp} \\ | \quad | \quad | \\ Y_0 \cdots Y_{t-1} \quad Y_t \end{array} \quad (4.15)$$

for all $t = 0, \dots, n$.

Proof. This is a consequence of the equations

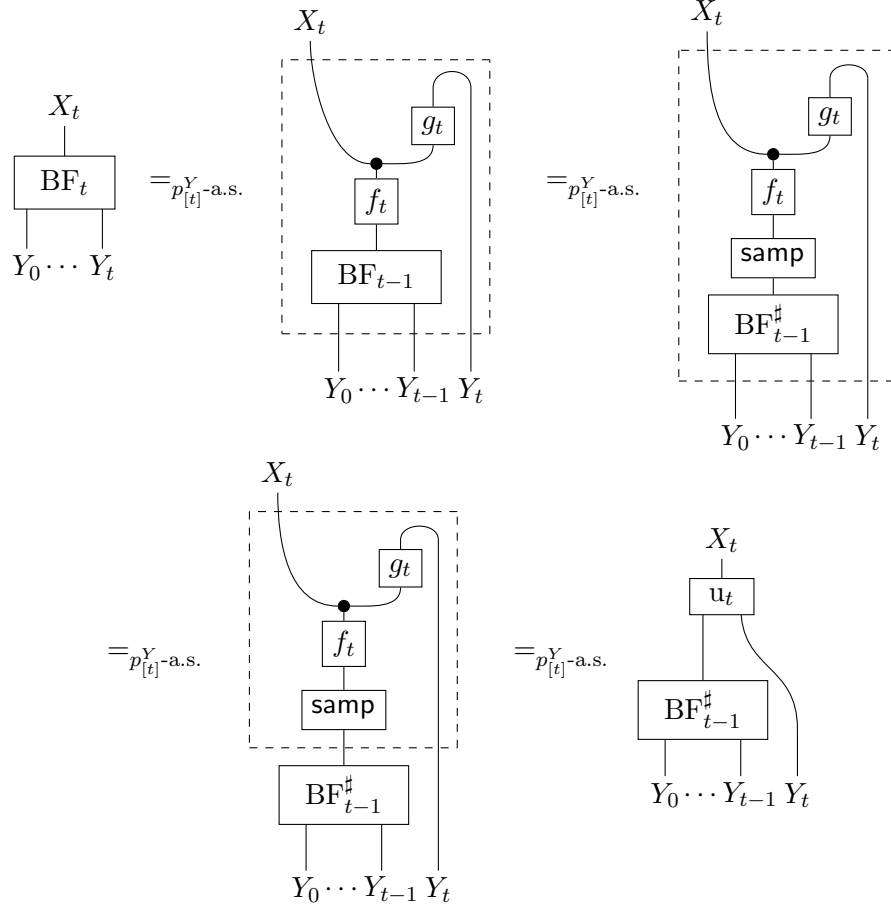

where we have used Proposition 4.2 in the first step and Proposition 2.13(c) together with the fact that BF_{n-1}^\sharp is deterministic in the third step. \square

Corollary 4.11. *The deterministic counterpart of the Bayes filter satisfies the recursion*

$$\begin{array}{c}
 PX_t \\
 \downarrow \\
 \text{BF}_t^\sharp \\
 \downarrow \\
 Y_0 \cdots Y_t
 \end{array}
 \quad =_{p_{[t]}^Y\text{-a.s.}} \quad
 \begin{array}{c}
 PX_t \\
 \downarrow \\
 u_t^\sharp \\
 \downarrow \quad \downarrow \\
 \text{BF}_{t-1}^\sharp \quad Y_t \\
 \downarrow \quad \downarrow \\
 Y_0 \quad Y_{t-1}
 \end{array}
 \tag{4.16}$$

Proof. Both sides of the equation are deterministic, and post-composition with samp shows

that they are the deterministic counterparts of the two sides of (4.15). Therefore the claim follows by a.s.-compatible representability (Definition 2.8). \square

Since the recursion of Corollary 4.11 is easy to expand, we immediately arrive at the following.

Corollary 4.12. *In any a.s.-compatibly representable Markov category with conditionals, the Bayes filter can be written as the single string diagram*

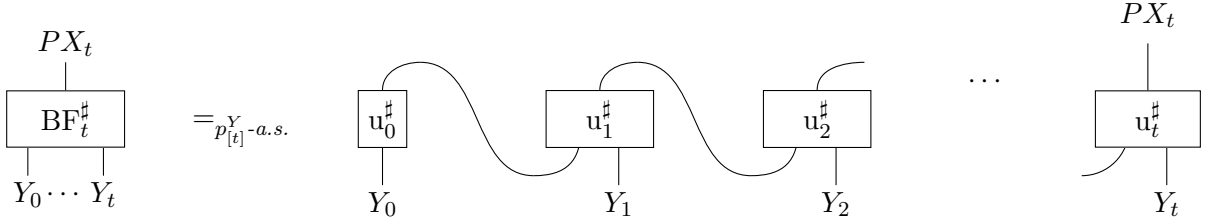

which furthermore recovers BF_t itself upon composition with `samp`.

Remark 4.13. If \mathcal{C} is a.s.-compatibly representable, then so is the parametric Markov category \mathcal{C}_W for any object W [16, Lemma 3.25]. Further, the deterministic counterpart of a morphism in \mathcal{C}_W is represented in \mathcal{C} by the deterministic counterpart of its representative in \mathcal{C} . Consequently, as with Remark 4.3, the results of this section also apply to \mathcal{C}_W . This immediately shows that Corollary 4.12 holds even in case all morphisms involved have an additional dependence on some parameter object W . This amounts to every box in our diagrams, including the u_i , connecting to a copy of the W input as in (3.4).

4.5 The Bayes filter as a Markov chain

Consider a hidden Markov model and the sequence of posterior distributions that describe an observer's guess about the hidden state. Since the observations are typically random, the posterior distributions are also random. It is natural to consider them as a stochastic process in their own right. Here we show that this process is a Markov chain. As far as we know, this is due to Blackwell [6] for the case of `FinStoch`, while [8, Lemma 2.4] provides a partial measure-theoretic generalization.

Throughout, we work in an a.s.-compatibly representable Markov category \mathcal{C} with conditionals and consider a hidden Markov model and its Bayes filter as before. In these terms, the stochastic process of posterior distributions up to some time $t \in [n]$ is given schematically by

the **filter process**

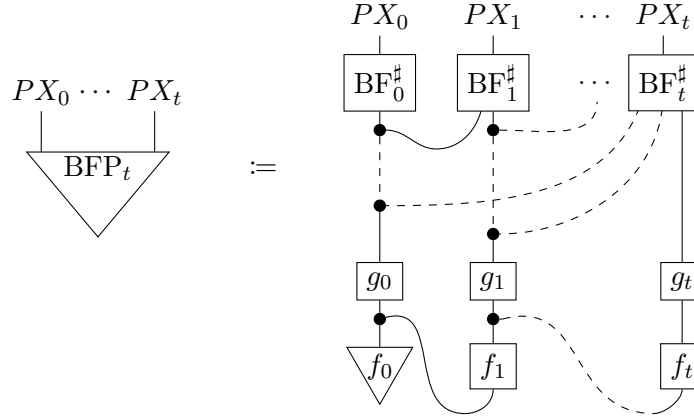

where the dashed wires indicate what the pattern is. In order to spell this out more formally, we introduce the following auxiliary morphisms.

Definition 4.14. *Let*

$$\lambda_t: Y_0 \otimes \cdots \otimes Y_t \longrightarrow PX_0 \otimes \cdots \otimes PX_t$$

be defined recursively, starting with $\lambda_0 := \text{BF}_0^\sharp$, and for $t \geq 1$,

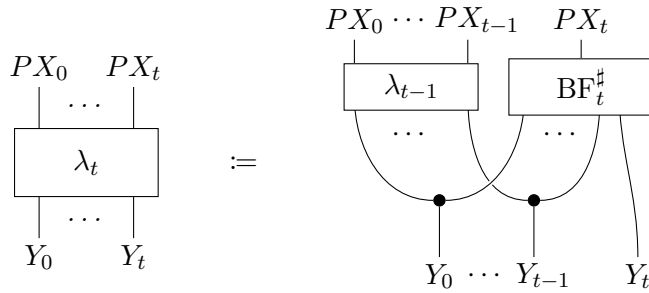

As before, we could alternatively consider the start of the recursion to be $\lambda_{-1} := \text{id}_I$ with $Y_{-1} = I$ and $PX_{-1} = X_{-1} = I$. In terms of these λ_t 's, the filter process is now formally defined as

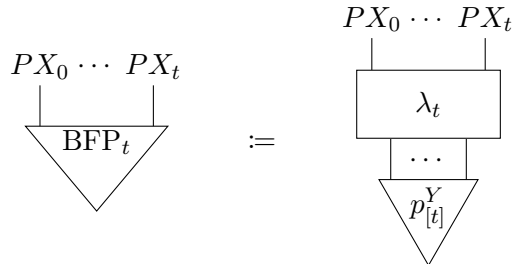

Lemma 4.15. For all $t \in [n]$, we have

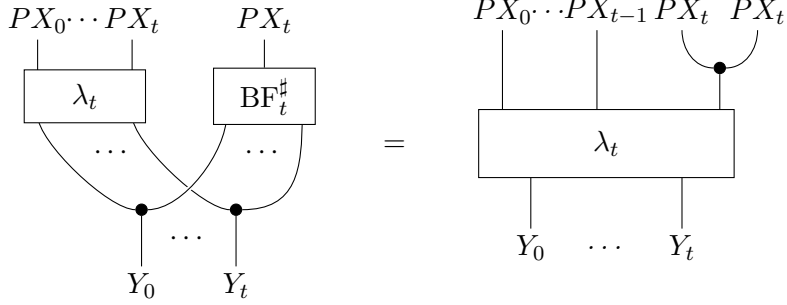

Proof. For $t = 0$, this is simply the statement that $\lambda_0 = \text{BF}_0^\#$ is deterministic. The induction step follows similarly straightforwardly by the fact that $\text{BF}_t^\#$ is deterministic.³¹ \square

The following other sequence of auxiliary morphisms will describe the transition kernels of the filter process.

Definition 4.16. For $t \in [n]$, let h_t be the morphism

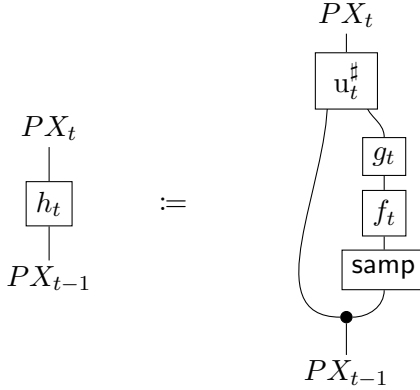

For $t = 0$, we follow the convention $X_{-1} := I$, so that $h_0 = u_0^\# g_0 f_0$.

Remark 4.17. Intuitively, h_t takes a distribution on X_{t-1} , samples from it and determines a sample of the observation in Y_t , and then applies a Bayesian updating to the original distribution with respect to this observation. In **FinStoch**, our $h_t^\#$ seems to match up with the “abstract hidden Markov models” of McIver et al. described at [28, Section 3.B] and [1, Section 14.3].

Before proceeding, it will be helpful to note that the process of observations can be generated recursively using the Bayes filter in the following sense.

³¹For a more abstract proof, note that all morphisms involved are deterministic, and it is therefore enough to show that all single-output marginals of the equation hold. We leave the details to the reader.

Lemma 4.18. For all $t \in [n]$, we have

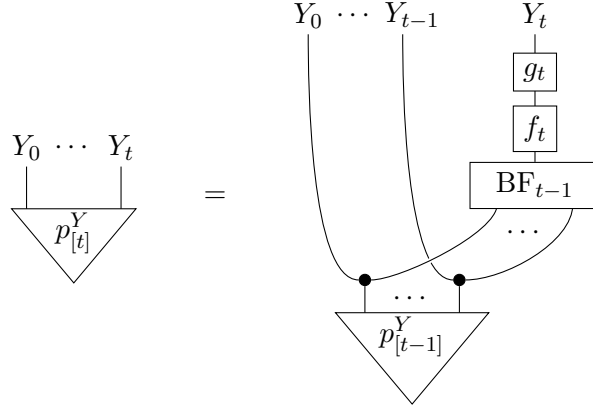

Proof. At $t = 0$, this amounts to $p_{[0]}^Y = g_0 f_0$, which is obvious. And with $t + 1$ in place of t , the claim follows upon composing the definition of the Bayes filter (4.1) with $g_{t+1} f_{t+1}$. \square

The following result now shows that the filter process is indeed a Markov chain with initial distribution h_0 and transition kernels h_t .

Theorem 4.19. For all $t \in [n]$,

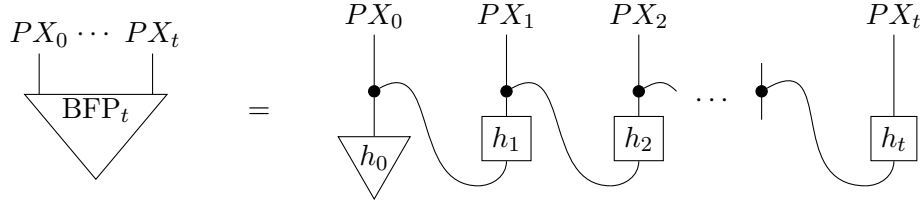

Proof. We proceed by induction on t . The base case $t = 0$ asserts $\text{BF}_0^\# p_0^Y = h_0$, which holds because of $u_0 = \text{BF}_0$ and $p_0^Y = g_0 f_0$.

For the induction step, we consider $t \geq 1$ such that the desired equation holds for BFP_{t-1} , and we then show that it holds for BFP_t . Expanding the definitions gives

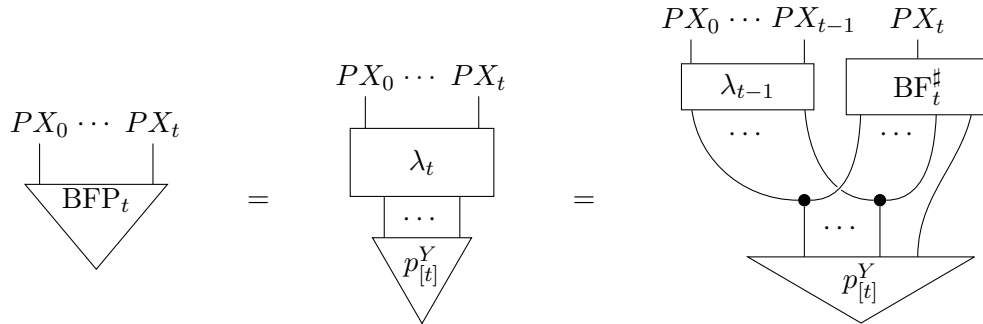

Applying Lemma 4.18, this evaluates further to

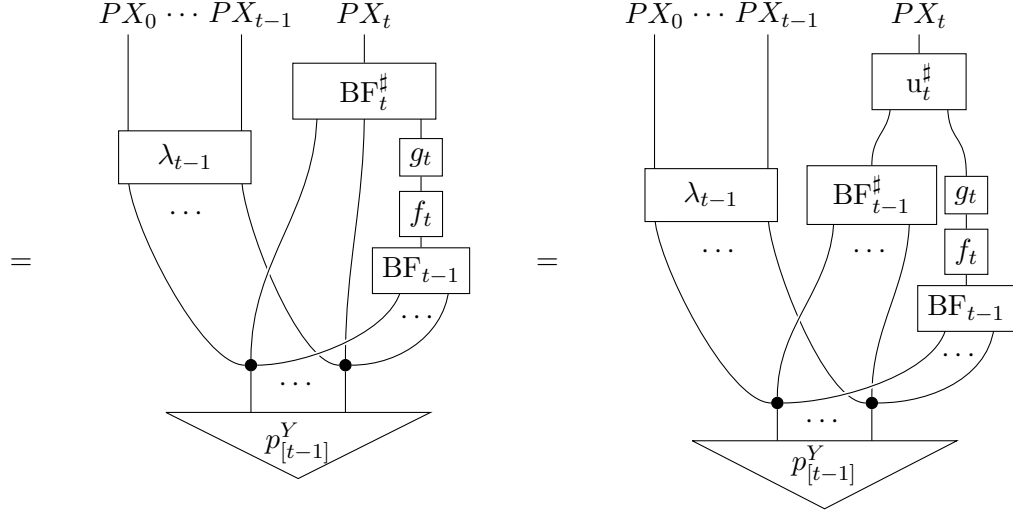

where the second equation uses the recursion formula of Corollary 4.11. By the fact that $\text{BF}_{t-1}^\#$ is the deterministic counterpart of BF_t , we can also write this as

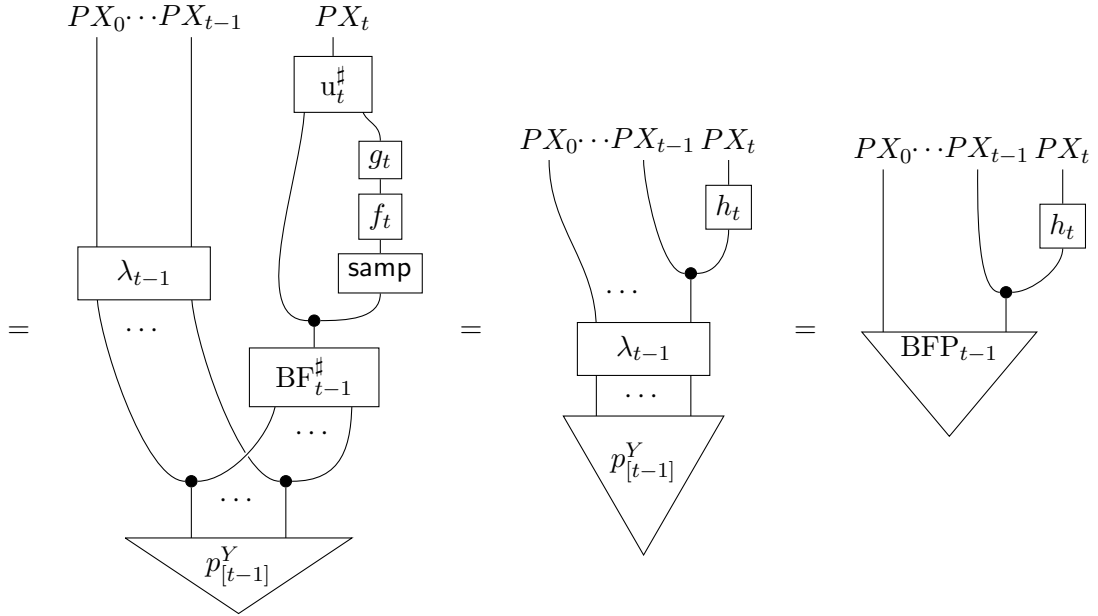

where the second equation holds by Lemma 4.15 and the definition of h_t . The claim now follows straightforwardly by the induction hypothesis. \square

Remark 4.20. This result may have some significance in the context of information security. Indeed, if the observations in the hidden Markov model are the observations of an adversary,

then it is of interest to make statements about the adversary's guess of the hidden state and how it evolves in time. The fact that the filter process is a Markov chain indicates that given the adversary's guess at some time t , learning about their guess at an earlier time does not help with predicting their guess at a later time.

Example 4.21. In `FinSetMulti`, each distribution object PX_t is the set of nonempty subsets of X_t . Indeed evaluating (4.14) in `FinSetMulti` shows that the filter update

$$u_t^\sharp : PX_{t-1} \otimes Y_t \longrightarrow PX_t$$

is the map which takes a subset of X_{t-1} and an observation y_t , applies the transition f_t to determine all states x_t consistent with the given set at time $t-1$ and then intersects with the set of states consistent with the observed value y_t . This is effectively what we already did in Example 4.8 to compute the possibilistic filter.

Continuing on from that example, let us see what the filter process and its Markov property amount to in that example. At $t=0$, we have seen that the filter deterministically outputs $\text{IBF}_0(\perp) = (1, 0, 1)^t$. At time $t=1$, the possible filter outputs are $\text{IBF}_1(\perp, \perp) = (1, 1, 0)^t$ and $\text{IBF}_1(\perp, \top) = (0, 1, 0)^t$ depending on the value of the second observation. At time $t=2$, we similarly get one of $\text{IBF}_2(\perp, \perp, \perp) = (1, 1, 0)^t$, $\text{IBF}_2(\perp, \perp, \top) = (0, 1, 1)^t$, and $\text{IBF}_2(\perp, \top, \top) = (0, 0, 1)^t$. Continuing like this, a simple induction argument shows that the filter process is given by the following possibilistic Markov chain, or nondeterministic automaton:

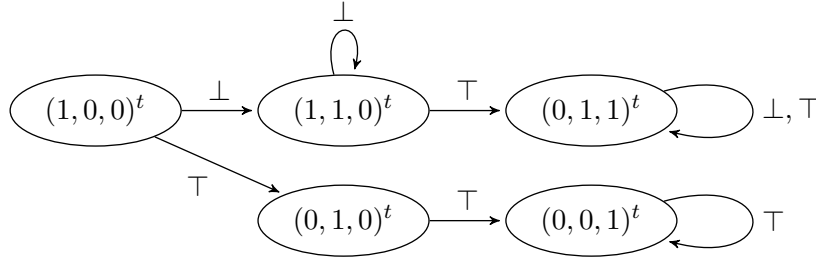

Here, the labels indicate which new observations trigger which transition. \perp does not appear on any transition out of the bottom two states, since when we are at b or c with certainty, then we must be at c in the next step and will necessarily observe \top .

5 Smoothing in Markov categories

While the Bayes filter tries to infer the most recent state on X_t from a sequence of observations up to time t , it is sometimes desirable to go back and make inferences about the hidden state at an earlier time. So in this section, we consider observations up to time n and the problem of inferring the hidden state at a time $t \in [n]$.

Some of the material in this section will be similar to that in Section 4, so we will be brief in places. Throughout, we work in a Markov category \mathcal{C} with conditionals and consider a hidden Markov model $p : I \rightarrow (Y \otimes X)_{[n]}$ as in Definition 3.8.

Notation 5.2. We write $\alpha_t: I \rightarrow Y_{[t]} \otimes X_t$ for the marginal given by

$$(5.3)$$

Remark 5.3. By definition, the Bayes filter BF_t is the conditional of α_t on $Y_{[t]}$.

The naïve approach to computing α_t in practice would first calculate the entire $p_{[t]}: I \rightarrow (Y \otimes X)_{[t]}$ and then marginalize out $X_{[t-1]}$. But already in `FinStoch`, this would involve many redundant calculations, resulting in a computation that gets intractable in practice. The following more workable recursion formula is clear from the definition.

Lemma 5.4 (The forward algorithm). *The morphisms α_t satisfy the recursion formula*

$$(5.4)$$

for all $t \in [n]$, starting with $\alpha_{-1} := \text{id}_I$.

Similarly, the goal of the backward algorithm is to compute the right part of (5.2), traditionally denoted β [36, Section III].

Notation 5.5. For a hidden Markov model p and $t \in [n]$, we write $\beta_t: X_t \rightarrow Y_{(t,n]}$ for

$$(5.5)$$

Again the following recursion formula is clear from the definition.

Lemma 5.6 (The backward algorithm). *The morphisms β_t satisfy the backwards recursion formula*

$$\begin{array}{c} Y_{(t,n)} \\ | \\ \boxed{\beta_t} \\ | \\ X_t \end{array} = \begin{array}{c} Y_{t+1} \quad Y_{(t+1,n)} \\ | \quad | \\ \boxed{g_{t+1}} \quad \boxed{\beta_{t+1}} \\ \curvearrowright \quad \curvearrowleft \\ \bullet \\ | \\ \boxed{f_{t+1}} \\ | \\ X_t \end{array} \tag{5.6}$$

for all $t \in [n]$, starting with $\beta_{n+1} := \text{id}_I$ where $X_{n+1} := Y_{n+1} := I$.

Remark 5.7. There are some differences in the literature concerning the definitions of the forward and the forward-backward algorithm, and in particular on whether some conditioning on observations is already considered part of the algorithm or not. Common to most prior treatments is that they take place in FinStoch only.³² Otherwise accounts differ in the details. For example, Rabiner [36] defines α_t as we do, and conditioning on observations is only done in subsequent steps, such as trying to estimate the most likely hidden state (known as the *Baum–Welch algorithm*). Murphy [31, Sections 17.4.2, 17.4.3] instead defines α_t to coincide with our Bayes filter BF_t , and his description of the forward algorithm is more akin to our instantiated Bayes filter in FinStoch , while his version of the forward-backward algorithm corresponds to an instantiated version of our (5.7) below in FinStoch .³³

We find it most clear to define α_t and β_t as quantities that are not conditioned, and we reserve notation such as BF_t and BS_t^n for morphisms that have been conditioned on observations and thus perform Bayesian inference.

Lemma 5.8. *The Bayes smoother can also be expressed as*

$$\begin{array}{c} X_t \\ | \\ \boxed{\text{BS}_t^n} \\ | \\ Y_{[n]} \end{array} =_{p_{[n]}^Y\text{-a.s.}} \begin{array}{c} X_t \\ | \\ \boxed{\beta_t} \\ | \\ \bullet \\ | \\ \boxed{\alpha_t} \\ | \\ Y_{[t]} \quad Y_{(t,n)} \end{array} =_{p_{[t]}^Y\text{-a.s.}} \begin{array}{c} X_t \\ | \\ \boxed{\beta_t} \\ | \\ \bullet \\ | \\ \boxed{\text{BF}_t} \\ | \\ Y_{[t]} \quad Y_{(t,n)} \end{array} \tag{5.7}$$

³²One exception is Murphy [31, Section 18.3.2.3], who does discuss an equivalent for continuous variables with density.

³³See Section 5.2.

Proof. We have

$$\begin{array}{c} X_t \\ | \\ \boxed{\text{BS}_t^n} \\ | \\ Y_{[n]} \end{array} \stackrel{= p_{[n]}^Y\text{-a.s.}}{=} \begin{array}{c} X_t \\ | \\ \begin{array}{|c|} \hline \beta_t \\ \hline \end{array} \\ | \\ \begin{array}{|c|} \hline \alpha_t \\ \hline \end{array} \\ | \\ \begin{array}{|c|} \hline Y_{[t]} \\ \hline \end{array} \quad \begin{array}{|c|} \hline Y_{(t,n)} \\ \hline \end{array} \end{array} \stackrel{= p_{[n]}^Y\text{-a.s.}}{=} \begin{array}{c} X_t \\ | \\ \begin{array}{|c|} \hline \beta_t \\ \hline \end{array} \\ | \\ \begin{array}{|c|} \hline \alpha_t \\ \hline \end{array} \\ | \\ \begin{array}{|c|} \hline Y_{[t]} \\ \hline \end{array} \quad \begin{array}{|c|} \hline Y_{(t,n)} \\ \hline \end{array} \end{array} \quad (5.8)$$

where the first equation follows by plugging in definitions and the second by Proposition 2.13. Now the inner dashed box is precisely BF_t by definition. \square

The conditioning on $Y_{(t,n)}$ in (5.7) may still pose challenges if $n - t$ is not small. A solution to this has been explored in Gauss called the *two-filter smoother* [25, 40], but we instead explore an alternative smoothing algorithm next.

5.1.2 Fixed-interval smoothing

Here, we develop the categorical version of **fixed-interval smoothing**, an existing recursion formula for the Bayes smoothers BS_t^n in terms of the Bayes filters BF_t [3, Section 8.6]. Its name refers to the time interval for the observation sequence being fixed. As with the recursion formulas for the Bayes filter from Section 4, the complexity reduces to linear in n and t .

Proposition 5.9 (Fixed-interval smoother). *The following backwards recursion formula for BS_t^n holds true for all $t \in [0, n]$:*

$$\begin{array}{c} X_t \\ | \\ \boxed{\text{BS}_t^n} \\ | \\ Y_{[n]} \end{array} \stackrel{= p_{[n]}^Y\text{-a.s.}}{=} \begin{array}{c} X_t \\ | \\ \begin{array}{|c|} \hline f_{t+1} \\ \hline \end{array} \\ | \\ \begin{array}{|c|} \hline \text{BF}_t \\ \hline \end{array} \\ | \\ \begin{array}{|c|} \hline \text{BS}_{t+1}^n \\ \hline \end{array} \\ | \\ \begin{array}{|c|} \hline Y_{[t]} \\ \hline \end{array} \quad \begin{array}{|c|} \hline Y_{(t,n)} \\ \hline \end{array} \end{array} \quad (5.9)$$

where $X_{n+1} = I$, meaning that $\text{BS}_{n+1}^n = \text{del}_{Y_{[n]}}$ and $f_{n+1} = \text{del}_{X_n}$.

More explicitly, the initial $t = n$ step of the recursion constructs $\text{BS}_n^n = \text{BF}_n$, which can alternatively be taken to be the start of the recursion.

Proof. The initial condition $t = n$ holds as $\text{BS}_n^n = \text{BF}_n$ by definition. For $t < n$, we combine Lemma 5.8 and the backwards procedure from Lemma 5.6 to get

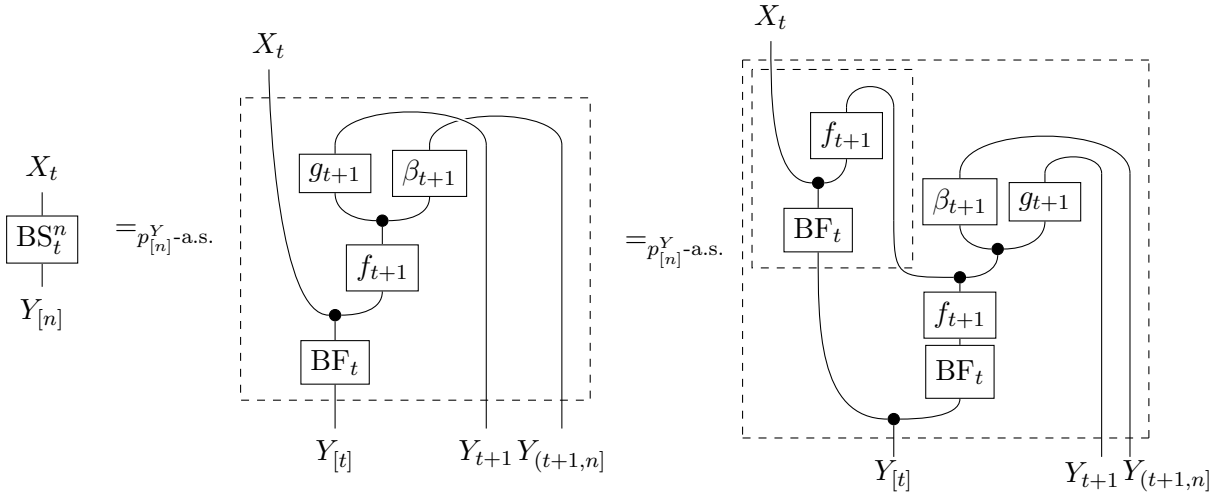

where the second step holds by the definition of conditionals. Applying Proposition 2.13 together with the fact that copy is deterministic, we can further evaluate this to

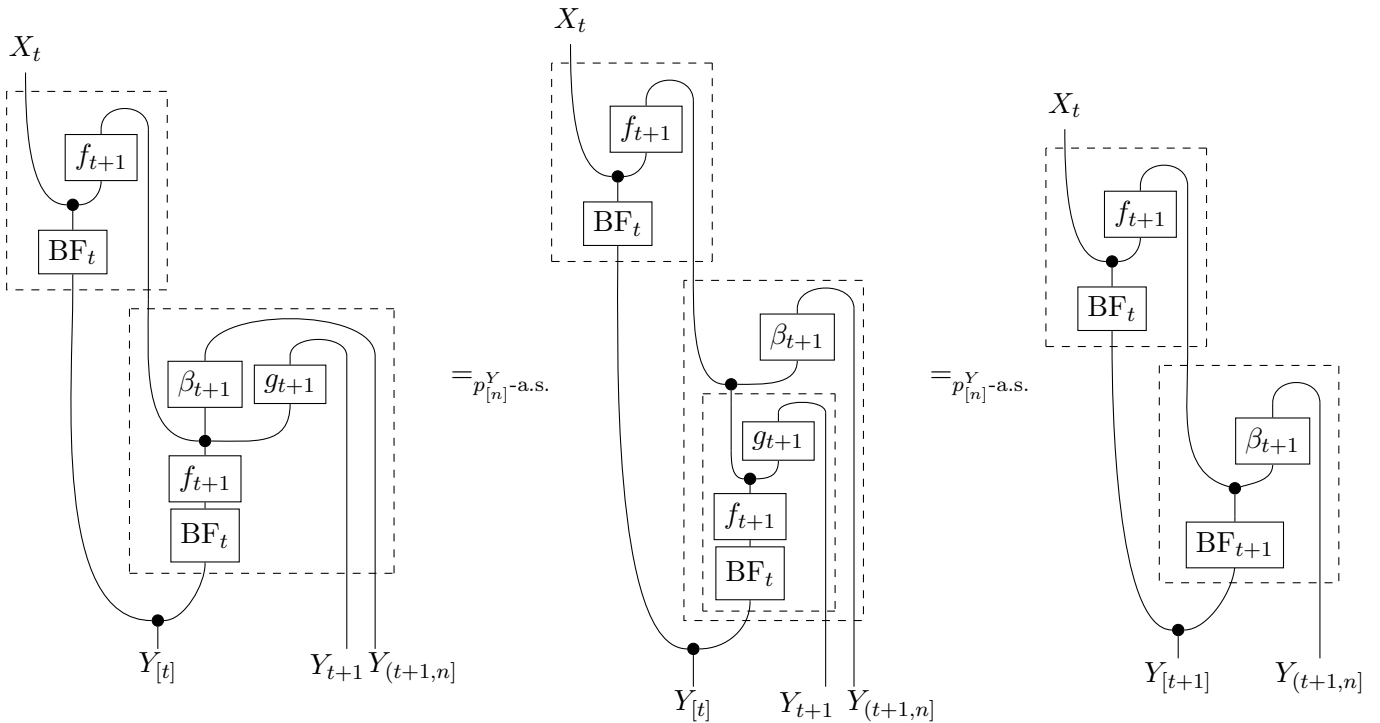

and the bottom right subdiagram is BS_{t+1}^n by Lemma 5.8 again. \square

5.2 The instantiated Bayes smoother

As with the Bayes filter, working with the uninstantiated smoother BS_t^n can be difficult already because its domain grows exponentially with n . Here, we introduce the **instantiated Bayes smoother** by specializing the Bayes smoother to a *fixed* sequence of observations, much in the same fashion as we had done for the Bayes filter in Section 4.2.

Definition 5.10. *Given a sequence of deterministic morphisms*

$$y_0: I \rightarrow Y_0, \quad y_1: I \rightarrow Y_1, \quad \dots, \quad y_n: I \rightarrow Y_n$$

which we abbreviate by $\mathbf{y}_{[n]}$, the **instantiated Bayes smoother** is

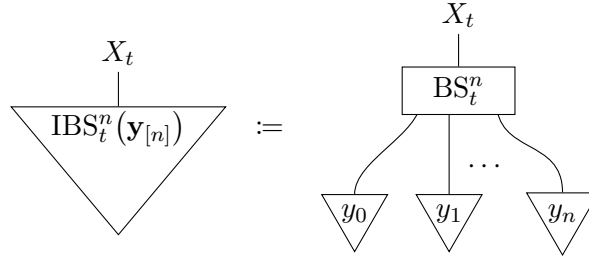

From here we can easily construct an instantiated version of the fixed-interval smoothing recursion, which in **Gauss** recovers the Rauch-Tung-Striebel smoother (Section 5.3.2).

Proposition 5.11 (Instantiated fixed-interval smoother). *The instantiated Bayes smoother can be computed through the following backwards recursion:*

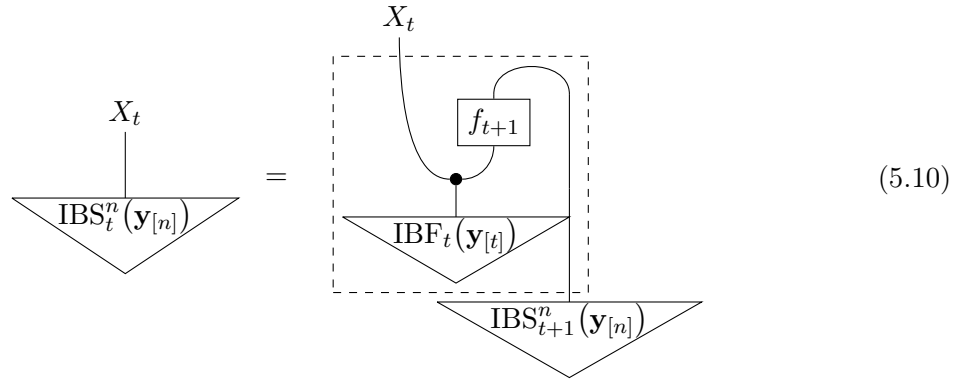

for all $t \in [n]$, where the recursion starts at $\text{IBS}_n^n(\mathbf{y}_{[n]}) = \text{IBF}_n(\mathbf{y}_{[n]})$.

Proof. Straightforward from Proposition 5.9 and Proposition 2.13(c). \square

5.3 Examples of the instantiated Bayes smoother

We briefly consider what form the forward-backward algorithm and the fixed-interval smoother take in particular Markov categories, limiting our presentation to **FinStoch** for the former and **Gauss** for the latter.

5.3.1 The forward-backward algorithm in **FinStoch**

Usually taken to start at $t = 0$, the forward procedure is:

- (a) Initialize as $\alpha_0(y_0, x_0) := g_0(y_0 | x_0) f_0(x_0)$.
- (b) For $t = 1, \dots, n$, compute

$$\alpha_t(\mathbf{y}_{[t]}, x_t) = g_t(y_t | x_t) \sum_{x_{t-1}} f_t(x_t | x_{t-1}) \alpha_{t-1}(\mathbf{y}_{[t-1]}, x_{t-1}). \quad (5.11)$$

Indeed this is the straightforward translation of (5.4) into **FinStoch**. Similarly, by (5.6) the backward procedure is:

- (a) Initialize as $\beta_n(x_n) = 1 \quad \forall x_n \in X_n$.³⁴
- (b) For $t = n - 1, \dots, 0$, compute

$$\beta_t(\mathbf{y}_{(t,n)} | x_t) = \sum_{x_{t+1}} g_{t+1}(y_{t+1} | x_{t+1}) \beta_{t+1}(\mathbf{y}_{(t+1,n)} | x_{t+1}) f_{t+1}(x_{t+1} | x_t).$$

Finally, performing the conditioning with the observed values $\mathbf{y}_{[n]}$ plugged in to (5.8) produces the desired result,

$$\text{IBS}_t^n(\mathbf{y}_{[n]})(x_t) = \frac{\alpha_t(\mathbf{y}_{[t]}, x_t) \beta_t(\mathbf{y}_{(t,n)} | x_t)}{\sum_{x'_t} \alpha_t(\mathbf{y}_{[t]}, x'_t) \beta_t(\mathbf{y}_{(t,n)} | x'_t)} \quad (5.12)$$

We leave the instantiation of this algorithm in other Markov categories, like **BorelStoch**, **Gauss**, **FinSetMulti** and parametric Markov categories, to the reader.

5.3.2 The RTS smoother as the instantiated Bayesian smoother

Shortly after the Kalman filter, a Gaussian fixed-interval backwards recursion was developed [37], now commonly known as the **Rauch-Tung-Striebel (RTS) smoother** or **Kalman smoother** [31, Section 18.3.2]. Similar to the Kalman filter in Section 4.3.4, we show that our

³⁴This $\beta_n: X_n \rightarrow I$ is sometimes described as a “uniform distribution”, which is technically correct as the only distribution on the singleton set I is uniform, but we stress that this is not a uniform distribution on X_n , already because X_n is the *domain* rather than the codomain of β_n .

categorical fixed-interval smoother specializes to the RTS smoother in Gauss, slightly generalized to allow for biased noise.

Keeping notation as in the Kalman filter case from Section 4.3.4, we additionally write the parameters for the filter output as

$$\text{IBF}_t(\mathbf{y}_{[t]}) = \mathcal{N}(m_t, P_t),$$

noting that we assume these quantities to have been computed already e.g. through the Kalman filter. To indicate the relation, let us denote the output parameters of the instantiated smoother with “hats,” meaning that

$$\text{IBS}_t^n(\mathbf{y}_{[n]}) = \mathcal{N}(\hat{m}_t, \hat{P}_t).$$

To determine the recursion formulas for these new parameters, we first write out the joint state inside the dashed box in (5.10) as

$$\begin{pmatrix} x_t \\ \tilde{x}_{t+1} \end{pmatrix} = \mathcal{N}(a_t, S_t),$$

where the parameters

$$a_t = \begin{pmatrix} m_t \\ \tilde{m}_{t+1} \end{pmatrix} \quad \text{and} \quad S_t = \begin{pmatrix} P_t & P_t A_{t+1}^t \\ A_{t+1} P_t & \tilde{P}_{t+1} \end{pmatrix}$$

are determined by

$$\tilde{m}_{t+1} = A_{t+1} m_t + v_{t+1}, \quad \tilde{P}_{t+1} = A_{t+1} P_t A_{t+1}^t + Q_{t+1}, \quad (5.13)$$

as in (4.11) for the Kalman filter. The conditional of this joint state is represented by the equation

$$\hat{x}_t = C_t \hat{x}_{t+1} + \mathcal{N}\left(m_t - C_t \tilde{m}_{t+1}, P_t - C_t \tilde{P}_{t+1} C_t^t\right),$$

where we have introduced the **optimal smoother gain**

$$C_t := P_t A_{t+1}^t \tilde{P}_{t+1}^-.$$

Composing this with $\text{IBS}_{t+1}^n(\mathbf{y}_{[n]})$, we obtain the recursion formulas that define the RTS smoother,

$$\hat{m}_t = m_t + C_t(\hat{m}_{t+1} - \tilde{m}_{t+1}), \quad \hat{P}_t = P_t + C_t(\hat{P}_{t+1} - \tilde{P}_{t+1})C_t^t, \quad (5.14)$$

where the tilde quantities are given by (5.13).

Bibliography

- [1] M. S. Alvim, K. Chatzikokolakis, A. McIver, C. Morgan, C. Palamidessi, and G. Smith. *The science of quantitative information flow*. Information Security and Cryptography. Springer, Cham, 2020.
- [2] J. Baez and M. Stay. Physics, topology, logic and computation: a Rosetta Stone. In *New structures for physics*, volume 813 of *Lecture Notes in Phys.*, pages 95–172. Springer, Heidelberg, 2011. [arXiv:0903.0340](#).
- [3] Y. Bar-Shalom, X. Li, and T. Kirubarajan. *Estimation with Applications to Tracking and Navigation: Theory Algorithms and Software*. John Wiley & Sons, Inc., 2002. doi:[10.1002/0471221279](#).
- [4] G. J. Bierman. *Factorization methods for discrete sequential estimation*. Mathematics in science and engineering. Academic Press, New York, 1977. ISBN 0120973502.
- [5] G. J. Bierman. Square-root information filtering and smoothing for precision orbit determination. In D. C. Sorensen and R. J. B. Wets, editors, *Algorithms and Theory in Filtering and Control: Proceedings of the Workshop on Numerical Problems, Part 1*, pages 61–75. Springer, Berlin, Heidelberg, 1982. doi:[10.1007/BFb0120973](#).
- [6] D. Blackwell. The entropy of functions of finite-state Markov chains. In *Transactions of the first Prague conference on information theory, statistical decision functions, random processes held at Liblice near Prague from November 28 to 30, 1956*, pages 13–20. Publ. House Czech. Acad. Sci., Prague, 1957.
- [7] O. Cappé, E. Moulines, and T. Rydén. *Inference in Hidden Markov Models*. Springer New York, 2005. doi:[10.1007/0-387-28982-8](#).
- [8] P. Chigansky and R. van Handel. A Complete Solution to Blackwell’s Unique Ergodicity Problem for Hidden Markov Chains. *Ann. Appl. Probab.*, 20(6):2318–2345, 2010. doi:[10.1214/10-AAP688](#). [arXiv:0910.3603](#).
- [9] K. Cho and B. Jacobs. Disintegration and Bayesian inversion via string diagrams. *Math. Structures Comput. Sci.*, 29:938–971, 2019. doi:[10.1017/S0960129518000488](#). [arXiv:1709.00322](#).
- [10] B. Coecke and A. Kissinger. *Picturing Quantum Processes*. Cambridge University Press, 2017.
- [11] B. Coecke and R. W. Spekkens. Picturing classical and quantum Bayesian inference. *Synthese*, 186(3):651–696, 2012. [arXiv:1102.2368](#).
- [12] T. Fritz. A synthetic approach to Markov kernels, conditional independence and theorems on sufficient statistics. *Adv. Math.*, 370:107239, 2020. doi:[10.1016/j.aim.2020.107239](#). [arXiv:1908.07021](#).

- [13] T. Fritz and A. Klingler. The d -separation criterion in categorical probability. *J. Mach. Learn. Res.*, 24(46):1–49, 2023. url:[jmlr.org/papers/v24/22-0916.html](https://jmlr.org/papers/v24/fritz22-0916.html). arXiv:2207.05740.
- [14] T. Fritz and W. Liang. Free gs-monoidal categories and free Markov categories. *Appl. Categ. Structures*, 31(21), 2023. doi:10.1007/s10485-023-09717-0. arXiv:2204.02284.
- [15] T. Fritz and E. F. Rischel. Infinite products and zero-one laws in categorical probability. *Compositionality*, 2:3, 2020. doi:10.32408/compositionality-2-3. arXiv:1912.02769.
- [16] T. Fritz, T. Gonda, P. Perrone, and E. F. Rischel. Representable Markov categories and comparison of statistical experiments in categorical probability. *Theor. Comput. Sci.*, 961:113896, 2023. doi:10.1016/j.tcs.2023.113896. arXiv:2010.07416.
- [17] B. Gavranovič. Space-time tradeoffs of lenses and optics via higher category theory, 2022. arXiv:2209.09351.
- [18] Y. Ho and R. Lee. A Bayesian approach to problems in stochastic estimation and control. *IEEE Trans. Automat. Contr.*, 9(4):333–339, 1964. doi:10.1109/TAC.1964.1105763.
- [19] B. Jacobs. Structured Probabilistic Reasoning. url:cs.ru.nl/B.Jacobs/PAPERS/ProbabilisticReasoning.pdf
- [20] E. T. Jaynes. *Probability theory: The logic of science*. Cambridge University Press, 2003. doi:10.1017/CBO9780511790423.
- [21] S. Julier and J. Uhlmann. Unscented filtering and nonlinear estimation. *Proc. IEEE*, 92(3):401–422, 2004. doi:10.1109/JPROC.2003.823141.
- [22] S. J. Julier and J. K. Uhlmann. New extension of the Kalman filter to nonlinear systems. In *Signal processing, sensor fusion, and target recognition VI*, volume 3068, pages 182–193. Spie, 1997. doi:10.1117/12.280797.
- [23] R. E. Kalman. A new approach to linear filtering and prediction problems. *J. Basic Eng.*, 82:35–45, 1960. doi:10.1115/1.3662552.
- [24] R. E. Kalman and R. S. Bucy. New results in linear filtering and prediction theory. *J. Basic Eng.*, 83:95–108, 1961. doi:10.1115/1.3658902.
- [25] G. Kitagawa. The two-filter formula for smoothing and an implementation of the gaussian-sum smoother. *Annals of the Institute of Statistical Mathematics*, 46:605–623, 1994.
- [26] J. Lambert. The Bayes filter and intro to state estimation, 2018. url:johnwlambert.github.io/bayes-filter/.
- [27] T. Leinster. *Basic category theory*. Cambridge University Press, 2014.
- [28] A. McIver, C. Morgan, and T. Rabehaja. Abstract hidden Markov models: a monadic account of quantitative information flow. *Log. Methods Comput. Sci.*, 15(1):Paper No. 36, 50, 2019.

- [29] H. M. T. Menegaz, J. Y. Ishihara, and H. T. M. Kussaba. Unscented Kalman filters for Riemannian state-space systems. *IEEE Trans. Automat. Contr.*, 64(4):1487–1502, 2019. doi:[10.1109/TAC.2018.2846684](https://doi.org/10.1109/TAC.2018.2846684).
- [30] M. Mider, M. Schauer, and F. Meulen. Continuous-discrete smoothing of diffusions. *Electronic Journal of Statistics*, 15, 01 2021. doi:[10.1214/21-EJS1894](https://doi.org/10.1214/21-EJS1894).
- [31] K. Murphy. *Machine Learning: A Probabilistic Perspective*. Adaptive Computation and Machine Learning series. MIT Press, 2012. ISBN 9780262018029. url:dl.acm.org/doi/book/10.5555/2380985.
- [32] P. Panangaden. *Labelled Markov processes*. Imperial College Press, London, 2009. doi:[10.1142/p595](https://doi.org/10.1142/p595).
- [33] P. Perrone. *Starting Category Theory*. World Scientific, 2024. doi:[10.1142/13670](https://doi.org/10.1142/13670). URL <https://www.worldscientific.com/doi/abs/10.1142/13670>.
- [34] R. Piedeleu and F. Zanasi. *An Introduction to String Diagrams for Computer Scientists*. Elements in Applied Category Theory. Cambridge University Press, 2025.
- [35] T. Rabehaja, A. McIver, C. Morgan, and G. Struth. Categorical information flow. In *The art of modelling computational systems—a journey from logic and concurrency to security and privacy*, volume 11760 of *Lecture Notes in Comput. Sci.*, pages 329–343. Springer, Cham, 2019.
- [36] L. Rabiner. A tutorial on hidden Markov models and selected applications in speech recognition. *Proc. IEEE*, 77(2):257–286, 1989. doi:[10.1109/5.18626](https://doi.org/10.1109/5.18626).
- [37] H. E. Rauch, F. Tung, and C. T. Striebel. Maximum likelihood estimates of linear dynamic systems. *AIAA Journal*, 3(8):1445–1450, 1965. doi:[10.2514/3.3166](https://doi.org/10.2514/3.3166).
- [38] B. Ristic, S. Arulampalam, and N. Gordon. *Beyond the Kalman Filter: Particle Filters for Tracking Applications*. Artech House, 2004. ISBN 9781580536318. url:uk.artechhouse.com/Beyond-the-Kalman-Filter-Particle-Filters-for-Tracking-Applications-P1308.aspx.
- [39] S. Roweis and Z. Ghahramani. A unifying review of linear Gaussian models. *Neural comput.*, 11(2):305–345, 1999. doi:[10.1162/089976699300016674](https://doi.org/10.1162/089976699300016674).
- [40] S. Särkkä. *Bayesian filtering and smoothing*. Cambridge University Press, Cambridge, 2013. doi:[10.1017/CBO9781139344203](https://doi.org/10.1017/CBO9781139344203).
- [41] M. Schauer and F. van der Meulen. Compositionality in algorithms for smoothing, 2023. arXiv:[2303.13865](https://arxiv.org/abs/2303.13865).
- [42] E. Seneta. *Non-negative matrices and Markov chains*. Springer Science & Business Media, 2006. doi:[10.1007/0-387-32792-4](https://doi.org/10.1007/0-387-32792-4).

- [43] M. Soloviev and Y. Wang. Github project: Markov categories in C++, 2024. url:github.com/blackhole89/markovcats.
- [44] D. Stein and R. Samuelson. A category for unifying Gaussian probability and nondeterminism. In *CALCO*, volume 270. LIPIcs, 2023. arXiv:[2204.14024](https://arxiv.org/abs/2204.14024).
- [45] B. Stroustrup. *The C++ Programming Language*. Addison-Wesley Professional, 4th edition, 2013. ISBN 0321563840.
- [46] S. Tull, J. Kleiner, and T. S. C. Smithe. Active inference in string diagrams: A categorical account of predictive processing and free energy. arXiv:[2308.00861](https://arxiv.org/abs/2308.00861).
- [47] F. van der Meulen and M. Schauer. Automatic backward filtering forward guiding for markov processes and graphical models, 2022. arXiv:[2010.03509](https://arxiv.org/abs/2010.03509).
- [48] N. Virgo. Unifilar machines and the adjoint structure of Bayesian models. *EPTCS*, 397: 299–317, 2023. doi:[10.4204/EPTCS.397.18](https://doi.org/10.4204/EPTCS.397.18). arXiv:[2305.02826](https://arxiv.org/abs/2305.02826).