

# VyZX: Formal Verification of a Graphical Quantum Language

ADRIAN LEHMANN\*, University of Chicago, USA

BEN CALDWELL\*, University of Chicago, USA

BHAKTI SHAH, University of Chicago, USA

ROBERT RAND, University of Chicago, USA

Graphical languages are a convenient shorthand to represent computation, with rewrite rules relating one graph to another. In contrast, proof assistants rely heavily on inductive datatypes, particularly when giving semantics to embedded languages. This creates obstacles to formally reasoning about graphical languages, since imposing an inductive structure obfuscates the diagrammatic nature of graphical languages, along with their corresponding equational theories.

To address this gap, we present *VyZX*, a verified library for reasoning about inductively defined graphical languages. These inductive constructs arise naturally from category-theoretic definitions. We developed *VyZX* to Verify the *ZX*-calculus, a graphical language for reasoning about quantum computation. The *ZX*-calculus comes with a collection of diagrammatic rewrite rules that preserve the graph’s semantic interpretation. We show how inductive graphs in *VyZX* are used to prove the soundness of the *ZX*-calculus rewrite rules and apply them in practice using standard proof assistant techniques. We also provide an IDE-integrated visualizer for proof engineers to directly reason about diagrams in graphical form.

## 1 INTRODUCTION

How do we formally verify a graphical language? Of special interest are graphical languages which follow the principle that *only connectivity matters* [Coecke and Kissinger 2017]: We care about the connections in a graph, not the position of any given node. Figure 1 shows a simple graphical program, in which the green and red nodes represent processes that are each connected to one input, one output, and each other. Hence, we can connect the green and red nodes vertically without being concerned about their left-to-right ordering in the graph. When giving a *semantic* to a graph, we often have to first fix an ordering. In this paper, we will focus on the *ZX*-calculus, a lightweight language for quantum computing, in which nodes correspond to matrix multiplication. For example, to translate Figure 1 into matrix products, we will need to choose whether the green or red node comes first, even though the full program’s semantics will be the same regardless of our choice. The standard approach here is to slide the nodes in the diagram slightly, so that any two connected nodes always have an ordering. We see one of the two ways of repositioning the red and green nodes in Figure 2. Unfortunately, while decomposing a *ZX*-diagram into a series of composed boxes allow us to give it semantics, it complicates reasoning about the diagram. If we now wish to shift the green node past the red one, we will need to prove that this is semantics preserving. De facto, we are dealing with a far more rigid structure than the graphical diagram we first saw, and manipulating it in the expected ways will prove difficult.

This paper is about bridging this gap. Using the *ZX*-calculus as a motivating example, we show how we can represent a graphical diagram in terms of its compositional structure in a proof assistant. We show how to regain key rules that pertain to graphs, including “only connectivity matters”. Moreover, since *ZX*-calculus is a *calculus* endowed with a range of semantics-preserving rewrite

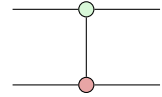

Fig. 1. A simple graphical program, corresponding to a CNOT in the *ZX*-calculus.

\* Equal contribution

rules, we prove the soundness of these rules as well, allowing users to graphically transform one ZX-diagram into an equivalent one.

We use these insights to present a formally verified ZX-calculus library called  $VyZX$ . By verified, we mean that all the rules pertaining to both connectivity and quantum operations have been proven sound with respect to the linear-algebraic semantics of ZX-diagrams.

Besides the central contribution of representing graphical structures inductively, endowing them with semantics, and proving the soundness of a range of rewrite rules,  $VyZX$  has additional features that make it a valuable tool for reasoning about abstract quantum operations.

**$VyZX$  allows for diagrams to be parametric:** ZX-diagrams can have a variable number of inputs, connections, and outputs, and the ZX-calculus rules are often written parametrically, allowing us to apply them in diverse contexts. Our inductive structure in  $VyZX$  allows for variables for all inputs, connections, and outputs, allowing us to state and prove rules in their most general form. We can also reason over the structure of our diagrams using variables as placeholders for arbitrary diagrams.

**$VyZX$  works with other semantic models:** Other works in verified quantum computing, such as `SQIR` [Hietala et al. 2021a] and `VOQC` [Hietala et al. 2021b] use a matrix-based Coq quantum mathematics library called `QuantumLib` [INQWIRE Developers 2022] to define their semantics. To allow  $VyZX$  to interoperate with these quantum circuit verification tools, we also use `QuantumLib` for our matrix semantics. We show how these tools can interact through quantum circuit ingestion to  $VyZX$  diagrams.

**$VyZX$  allows for graphical rewriting on top of the denotational semantics.** While  $VyZX$  allows for inductive reasoning about graphs and has denotational semantics in terms of matrices, it doesn't require the user to appeal to those semantics.  $VyZX$  verifies a complete set of standard ZX-calculus rewrite rules, allowing the user to prove equivalences between ZX-diagrams purely diagrammatically. They can then appeal to the semantics if we want to convert to other models, such as the circuit model, that use compatible matrix semantics.

**$VyZX$  allows for code extraction,** as its structure is not axiomatic. Every transformation, structural component, and lemma is constructively defined and computable. ZX-diagram semantics can be evaluated and lowered into floating point based matrices<sup>1</sup>. However, the matrix representation merely provides ground truth for verification, and we are not forced to evaluate these matrices. We can instead use the rewrite rules of the ZX-calculus to validate our transformations. This way, proof engineers can create fully verified software operating on ZX-diagrams using  $VyZX$ .

We also provide a **visualizer for graphical structures**. The `ZXViz` coq-lsp plugin integrates graphical proof states into the user's proof writing environment. This addresses a fundamental limitation of existing graphical libraries, including  $VyZX$ , that graphs are hard to represent and reason about textually. In  $VyZX$ , we frequently see examples with a deeply nested structure that obfuscates the ZX-diagrams they represent. A human-readable graphical visualization of the proof state makes  $VyZX$  proofs significantly more approachable.

We also provide a tool, `DC $\Uparrow$ AC`, for efficiently checking the equivalence of two ZX-diagrams up to associativity and distributivity. We intend to convert `DC $\Uparrow$ AC` into a Coq plugin that lets users efficiently manipulate ZX-diagrams.

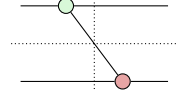

Fig. 2. A CNOT adjusted for ordering.

<sup>1</sup>Changing reals in Coq to floating points is standard practice, given the limitations of real computing systems. There is, however, recent work on reasoning about the inaccuracies of floating point numbers in Coq [Kellison et al. 2023].

Though VyZX was developed as a tool for reasoning about the ZX-calculus, the sample principles can apply to any symmetric monoidal category, which can represent a broad range of mathematical structures, all of which can be visualized as graphs [Selinger 2010].

## 2 THE ZX CALCULUS

In most existing quantum software, like IBM’s Qiskit [Qiskit contributors 2023] or Google’s Cirq [Developers 2022], quantum programs are written as *quantum circuits* [Deutsch 1989], a quantum analog to classical circuits that generally features from three to over a dozen distinct basic gates. By contrast, ZX-diagrams are expressible with only two kinds of nodes and a more flexible graphical structure. In addition to their comparative simplicity, ZX-diagrams have proven useful for creating quantum circuit optimizers [Cowtan et al. 2020; de Beaudrap et al. 2020; Kissinger and van de Wetering 2020], simulating quantum circuits [Kissinger and van de Wetering 2022], implementing error correcting codes [Chancellor et al. 2018; de Beaudrap and Horsman 2020a], and reasoning about measurement-based quantum computing [Duncan and Perdrix 2010; McElvanney and Backens 2023].

Fundamentally, ZX-diagrams are graphs with green and red nodes<sup>2</sup>, called Z and X spiders, with  $n$  inputs and  $m$  outputs, along with a rotation angle  $\alpha \in [0, 2\pi)$ . Spiders without an explicit rotation parameter are considered to have a 0 rotation. The semantics of Z and X spiders are shown in Figure 3.

While this paper doesn’t aim to explain quantum computing in general<sup>3</sup>, we will briefly explain the notation above. Here  $|0\rangle^{\otimes n}$  with  $n$  repeated zeroes represents (in Dirac’s *bra-ket* notation) a  $2^n$ -length vector with a 1 in the first position and zeroes elsewhere while  $\langle 0|^{\otimes n}$  represents its transpose. Similarly,  $|1\rangle^{\otimes n}$  is a  $2^n$ -length vector with a 1 in the last position. The intuition behind these spiders is that they take in a quantum state, preserve the  $|0\rangle^{\otimes n}$  vectors, and rotate the  $|1\rangle^{\otimes n}$  vectors by  $\alpha$ , postselecting on the two cases above. The red X spiders act equivalently but using the X basis. From a linear algebraic standpoint, Z and X spiders correspond to sparse complex-valued matrices. The number of inputs and outputs to a spider determines the dimensions of the matrix it represents.

The ZX-calculus [Coecke and Duncan 2011; Coecke and Kissinger 2017] uses ZX-diagrams with a set of rewrite rules to translate between equivalent quantum operations. We show the canonical set of rewrite rules in Section 2.2. Note that instead of denoting ZX-diagrams as equal, we denote them as proportional ( $\propto$ ), meaning they are equal up to a non-zero constant factor. Considering equality up to constant factors is a convention in ZX-calculus, as any non-zero scalar can be written as a ZX-diagram with no inputs or outputs.

This presentation of ZX-calculus draws upon van de Wetering’s [2020] extensive survey. We also recommend Coecke’s [2023] introduction to the ZX-calculus.

### 2.1 Meta-Rules

*Colorswapping.* We define a color-swapped ZX-diagram as a ZX-diagram with the same structure but changing every spider from Z to X and X to Z while preserving the angle. It can be shown that if a rule can be applied to a ZX-diagram  $zx_1$  transforming it into  $zx_2$ , then it can be applied to

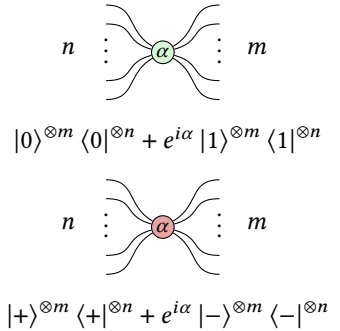

Fig. 3. Z and X spiders with their standard bra-ket semantics.

<sup>2</sup>We choose the conventional but accessible shades of green and red for this paper, see [zxcalculus.com/accessibility.html](http://zxcalculus.com/accessibility.html).

<sup>3</sup>The interested reader is encouraged to consult the standard textbook in the area [Nielsen and Chuang 2010].

a color-swapped version of  $\text{zx}_1$  transforming it into a color-swapped  $\text{zx}_2$ . With this in mind, we show any rule only for one color configuration, understanding that it applies to the color-swapped version.

### Only connectivity matters.

Perhaps the most important meta-rule in the ZX-calculus is that only connectivity matters (OCM). This means that wires can be arbitrarily deformed as long as the input and output order to the overall diagram is maintained.

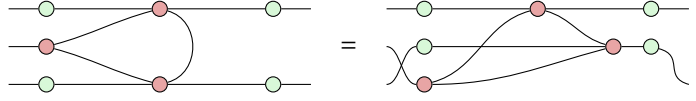

Fig. 4. Only connectivity matters: Two equal ZX-diagrams, where the right diagram is deformed. Connections and qubit order are maintained.

This rule is very powerful as it allows us to move diagrams into the most convenient form to apply rules to. Another important corollary of OCM is that it doesn't matter whether a wire is an input or output to a node. We show an example of OCM deformations in Figure 4.

## 2.2 Rewrite Rules

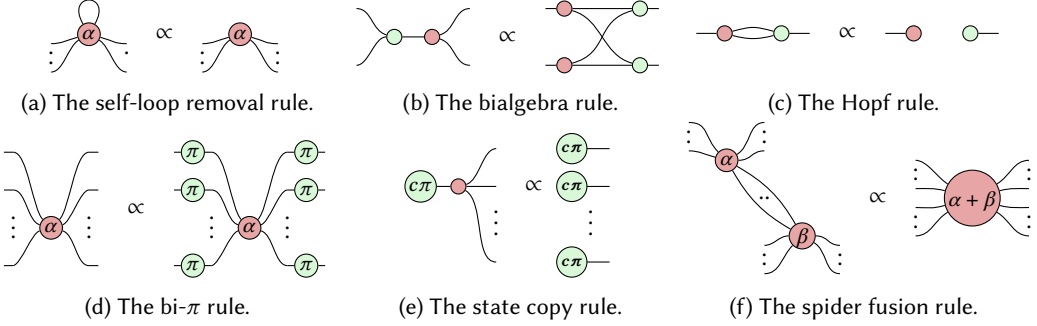

Fig. 5. Rules of the ZX-calculus, where  $\alpha, \beta \in \mathbb{R}, c \in \mathbb{N}$

One of the most critical ZX-calculus rules is that spiders connected by an arbitrary (non-zero) number of edges can be fused into a single node with the angles added together. This rule is shown in Figure 5f. The reverse is also true: any spider can be split such that the two new spiders add up to the original angle. A corollary of this is that spiders with 0 angle can be split off any input or output, so long as they have the color of the original spider. Further, with the spider fusion rule, we can manipulate the number of inputs and outputs for all other rules by adding a fuseable node to said input or output.

Another simplification is that we can remove self-loops, as shown in Figure 5a [van de Wetering 2020]. Intuitively, this rule says that a node cannot provide more information about itself.

The bialgebra rule (Figure 5b), while not intuitive, is crucial for many ZX proofs, as it allows for the rearranging of edges between nodes and the introduction or removal of swaps.

The Hopf rule, shown in Figure 5c, as a corollary to the bialgebra rule<sup>4</sup>, states that maximum information about the Z basis gives minimal information about the X basis. The relevance in practice is that the Hopf rule allows us to disconnect specific nodes in the diagram instead of changing their connection.

For a given X spider, the spider equals itself with Z rotations by  $\pi$  on each incoming or outgoing edge. Intuitively, this rule is true due to the orthogonal nature of the X and Z basis and the fact that we are performing in total a full rotation. Figure 5d shows this rule.

<sup>4</sup>This stems from the fact the Hopf algebras are bi-algebras.

The state copy rule (Figure 5e) shows us how the orthogonal spiders interact when considered as states.

### 2.3 Representing Unitary Gates

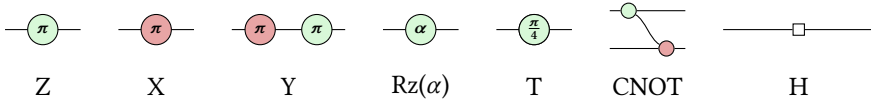

Fig. 6. Common gates represented in the ZX-calculus.

We translate some standard unitary gates from the quantum circuit model into ZX-calculus in Figure 6. Z, T, and  $Rz(\alpha)$  represent Z-axis rotations by the given angles, while X and Y rotate qubits by  $\pi$  around the X and Y axes. H switches between the Z and X bases; following van de Wetering [2020, Section 3.6] it can be decomposed into a sequence of red and green nodes. Finally, CNOT applies an X rotation (or “NOT”) on the second qubit contingent on the first being 1. Note that OCM counterintuitively tells us that we can slide the green “controlling node” past the red “NOT” without changing the semantics of the diagram.

Having translations from gates into ZX allows us to convert quantum circuits to diagrams. Once we translate circuits into diagrams, we can use the ZX-calculus rules without being bound by the circuit model’s rigid structure. Note that the gates shown in Figure 6 form the RzQ gate set [Nam et al. 2018], a complete gate set for quantum computing.

The ZX-calculus is a valuable tool in the toolbox of any quantum computer scientist. It is broadly applicable within quantum computing due to its general nature. We can use the ZX-calculus to visualize and diagrammatically reason about complex quantum operations.

### 3 INDUCTIVE GRAPHS

Reasoning about a graphical language like ZX inside a proof assistant is difficult. As in most graphs, our main concern is connectivity, but these languages have semantics, meaning that we need a way to construct diagrams that enforces a consistent order between the graph’s nodes. To find a suitable inductive definition, we turn to the category that underpins the ZX-calculus and use categorical definitions to inspire our inductive constructors. This allows us to look at something more general purpose than just ZX-calculus, and discuss how we could graphically reason about any monoidal category. This section is not necessary for understanding VyZX, but may serve as a useful intuition pump for readers familiar with category theory, and those interested in extending the ideas in this paper beyond the ZX-calculus, using category theory as a foundation.

Monoidal categories are useful mathematical objects when creating inductive graphs, as every monoidal category admits a graphical language [Selinger 2010] while also being defined by a small collection of equations, which we will cover later in this section. To get started, we lay out Definition 1 for categories and see how the basic objects have graphical interpretations. We will call the graphical interpretations diagrams, and each categorical definition will have an associated diagram constructor. The following definitions are adapted from [Joyal and Street 1993] and [Selinger 2010].

DEFINITION 1 (CATEGORY). A **category**  $C$  is

- (1) A collection of objects of  $C$  for which we write  $A$  in  $C$ ,
- (2) A collection of arrows between objects in  $C$  written  $f : A \rightarrow B$ ,
- (3) A composition operator for arrows  $\circ$  such that if  $f : A \rightarrow B$  and  $g : B \rightarrow D$  are arrows of  $C$ ,  $g \circ f : A \rightarrow D$  is an arrow of  $C$ ,

- (4) two operations domain and codomain such that for an arrow  $f : A \rightarrow B$ , domain  $f = A$  and codomain  $f = B$ , and  
 (5) for every object  $A$  of  $C$ , an identity arrow  $id_A : A \rightarrow A$ ,

where the following equations are satisfied:

$$id_B \circ f = f, \quad f \circ id_A = f, \quad (h \circ g) \circ f = h \circ (g \circ f)$$

Expanding on our basic category, we look at the definitions for *monoidal* (Definition 2), *symmetric* (Definition 4), and *autonomous* (Definition 6) to see their natural diagrammatic interpretations.

DEFINITION 2 (MONOIDAL CATEGORY). A category  $C$  is **monoidal** if there exists:

- (1) A binary operation  $\otimes$  on objects and a left and right identity object for  $\otimes$  called  $I$ .
- (2) A binary operation  $\otimes$  on arrows such that if  $f : A \rightarrow B$  and  $g : C \rightarrow D$  then  $f \otimes g : A \otimes C \rightarrow B \otimes D$ .
- (3) Natural isomorphisms  $\alpha_{A,B,C} : (A \otimes B) \otimes C \simeq A \otimes (B \otimes C)$ ,  $\lambda_A : I \otimes A \simeq A$ ,  $\rho_A : A \otimes I \simeq A$

Where  $\alpha, \lambda, \rho$  satisfy the following:

- (1)  $(f \otimes (g \otimes h)) \circ \alpha_{A,B,C} = \alpha_{A',B',C'} \circ ((f \otimes g) \otimes h)$ ,
- (2)  $f \circ \lambda_A = \lambda_{A'} \circ (id_I \otimes f)$ ,
- (3)  $f \circ \rho_A = \rho_{A'} \circ (f \otimes id_I)$ ,

With the following axioms also holding:

- (1)  $\otimes$  is a bifunctor, so  $id_A \otimes id_B = id_{A \otimes B}$  and  $(k \otimes h) \circ (g \otimes f) = (k \circ g) \otimes (h \circ f)$ ,
- (2) The “pentagon” and “triangle” coherence axioms given in Figure 7 commute.

$$\begin{array}{ccccc}
 & & \alpha_{A,B \otimes C, D} & & \\
 & & (A \otimes (B \otimes C)) \otimes D & \xrightarrow{\quad} & A \otimes ((B \otimes C) \otimes D) \\
 \alpha_{A,B,C} \otimes id_D \nearrow & & & & \searrow id_A \otimes \alpha_{B,C,D} \\
 ((A \otimes B) \otimes C) \otimes D & & & & A \otimes (B \otimes (C \otimes D)) \\
 \alpha_{A \otimes B, C, D} \searrow & & & & \nearrow \alpha_{A,B, C \otimes D} \\
 (A \otimes B) \otimes (C \otimes D) & & & & (A \otimes I) \otimes B \xrightarrow{\alpha_{A,I,B}} A \otimes (I \otimes B) \\
 & & & & \rho_A \otimes id_B \searrow \quad \swarrow id_A \otimes \lambda_B \\
 & & & & A \otimes B
 \end{array}$$

Fig. 7. The pentagon and triangle coherence axioms.

Objects, arrows, and compositions have a natural diagrammatic interpretation, shown in Figure 8. The definition of a monoidal category adds a sense of parallelism to our category. This will allow us to take two objects or arrows and set them in parallel, or take two operations and perform them in parallel as well. The isomorphism  $\alpha_{A,B,C}$  allows us to reassociate an object  $(A \otimes B) \otimes C$  to  $A \otimes (B \otimes C)$ . We can take two arrows  $f$  and  $g$  and form a new arrow  $f \otimes g$  or pass information along with  $f \otimes id_A$ . The identity object  $I$  can be represented using the empty diagram, which is just blank space, allowing us to satisfy the equations  $\lambda_A$  and  $\rho_A$  in our diagram.

To define a symmetric category, we first define a braided category.

DEFINITION 3 (BRAIDED CATEGORY). A monoidal category  $C$  is **braided** if there exists a natural family of isomorphisms  $c_{A,B} : A \otimes B \rightarrow B \otimes A$  such that the following diagrams commute:

$$\begin{array}{ccccc}
 & & (B \otimes A) \otimes C & \xrightarrow{\alpha_{B,A,C}} & B \otimes (A \otimes C) & \xrightarrow{id_B \otimes c_{A,C}} & B \otimes (C \otimes A) \\
 c_{A,B} \otimes id_C \nearrow & & & & & & \searrow \\
 (A \otimes B) \otimes C & & & & & & \\
 \alpha_{A,B,C} \searrow & & & & & & \nearrow \alpha_{B,C,A} \\
 A \otimes (B \otimes C) & \xrightarrow{c_{A,B \otimes C}} & (B \otimes C) \otimes A & & & & \\
 & & & & & & 
 \end{array}$$

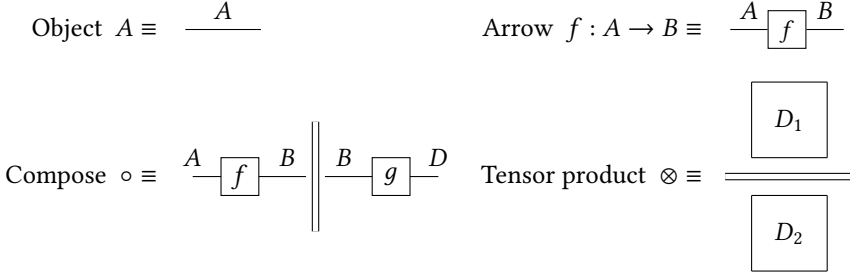
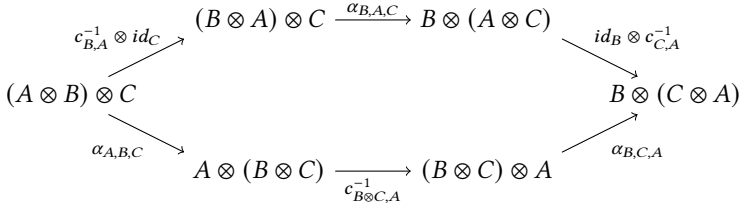

Fig. 8. The diagrammatic construction for monoidal category definitions, where  $D_1$  and  $D_2$  are arbitrary diagrams. In practice, the doubled lines can be dropped.



Diagrammatically, this gives us two ways to wrap wires, picking one to be on top of the other. Since we are only interested in symmetric monoidal categories for our purposes, we immediately extend the notion of a braided category.

DEFINITION 4 (SYMMETRIC CATEGORY). A braided category  $C$  is **symmetric** if  $c_{A,B} \cong c_{B,A}^{-1}$ .

The symmetric braid can be interpreted diagrammatically as shown in Figure 9.



Fig. 9. The diagrammatic interpretations for symmetric and autonomous categories.

To start defining an autonomous category, we first define the dual of an object.

DEFINITION 5 (EXACT PAIRING). In a monoidal category, an **exact pairing** between two objects  $A$  and  $B$  is given by a pair of morphisms  $v : I \rightarrow B \otimes A$  and  $\epsilon : A \otimes B \rightarrow I$  such that the following triangles commute:

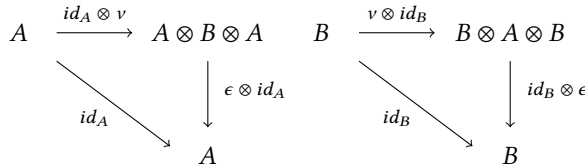

In an exact pairing, we say that  $A$  is the left dual of  $B$  and  $B$  the right dual of  $A$  and we call  $v$  the unit and  $\epsilon$  the co-unit.

DEFINITION 6 (AUTONOMOUS CATEGORY). We say a monoidal category is **autonomous** if every object has both a left and a right dual (Definition 5).

We can see the graphical definitions for a unit and co-unit in Figure 9. Given these definitions, we have a minimal collection of necessary objects to define our inductive data structure. The simplest

form of symmetric monoidal category we can define will be string diagrams with only the identity arrow, which have semantics that captures the connections from some input or output of a diagram to another input or output. This is the simplest form of a diagram we can create, and we can extend this idea later to build diagrams for the ZX-calculus. We assign these different names in Table 1 to match their diagrammatic interpretation more closely.

Categorical Concept	Inductive Constructor	Symbol
$id_A$	Wire	–
$I$	Empty	$\emptyset$
$\circ$	Compose	$\leftrightarrow$
$\otimes$	Stack	$\updownarrow$
Symmetric braid	Swap 1 1	$\times$
Unit	Cap	$\subset$
Co-unit	Cup	$\supset$

Table 1. Translating categorical concepts to inductive constructors with their respective symbolic notation.

With all of our categorical concepts and constructors for diagrams laid out, we can use these exact constructors to define string diagrams. We define inductive constructors for string diagrams  $SD(n\ m : \mathbb{N})$  with  $n$  inputs and  $m$  outputs as:

$$\begin{array}{c}
 \hline
 \text{Cup : } SD\ 0\ 2 \quad \text{Cap : } SD\ 2\ 0 \quad \text{Wire : } SD\ 1\ 1 \quad \text{Swap } n\ m : SD\ (n + m)\ (m + n) \quad \text{Empty : } SD\ 0\ 0 \\
 \hline
 \text{sd}_0 : SD\ in\ mid \quad \text{sd}_1 : SD\ mid\ out \quad \text{sd}_0 : SD\ in_0\ out_0 \quad \text{sd}_1 : SD\ in_1\ out_1 \\
 \hline
 \text{Compose } \text{sd}_0\ \text{sd}_1 : SD\ in\ out \quad \text{Stack } \text{sd}_0\ \text{sd}_1 : SD\ (in_0 + in_1)\ (out_0 + out_1) \\
 \hline
 \end{array}$$

We will refer to the diagrams generated by these constructors as the *block form* for string diagrams. They can be seen as blocks we can stack on top of one another or compose side by side if their dimensions are equal.

### 3.1 Connection Information in the Block Structure

Existing soundness and completeness results show that these graphical languages and their connection information properly reflect the categories they represent [Selinger 2010]. Completeness says that if two diagrams are equivalent up to some manipulation of the diagram (say twisting a wire around, moving a box, or stretching wires while preserving connections), then that manipulation can be explained as a consequence of the axioms of the category. In the other direction, soundness states that every axiom of a category holds in the diagrammatic language, up to some manipulation of the diagram. For example, take  $id_A \circ f = f$ . This is an axiom, but at a diagrammatic level it just looks like shortening the wire on the left side of the diagram. These two results together are known as coherence results for diagrammatic languages. All that remains for us is to take a look at the connection information of the different rules to justify why we call these diagrams “graphs”. To do this, we can check the axioms given in the prior definitions Definition 1 through Definition 6 and observe they do not modify the connection information of diagrams. We take our block structure constructors from above and view them as string diagrams to do this. We then can observe that the three isomorphisms maintain connection information. From Figure 10 and Figure 11, we can see the isomorphisms that move wires around do not modify the connection information of the diagram. The remaining isomorphisms  $\lambda_A$  and  $\rho_A$  do not change our diagram visually, as they add or remove the empty diagram which contains no connections. The same is true for  $\alpha_{A,B,C}$ , which



only reassociates objects, while diagrams have no parentheses. This means the minimum collection of rules required for our string category will not modify any connection information, telling us we can use these constructors to describe graphs. We can specify our category's arrows to extend our inductive construction beyond a minimal collection of rules. When extending our string diagrams to define the ZX-calculus in Section 4, we have to add constructors to represent the Z and X spiders. Further, we will define an appropriate semantic interpretation for the ZX calculus.

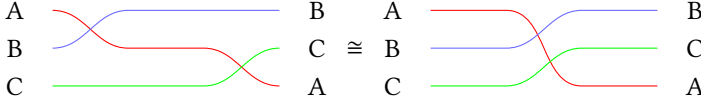

Fig. 10. The connection information for the hexagon isomorphism; see Definition 3.

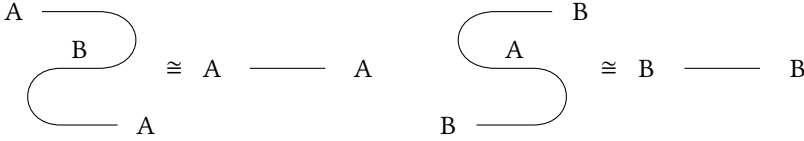

Fig. 11. The connection information for the triangle isomorphisms; see Definition 5.

#### 4 INDUCTIVE ZX-DIAGRAMS

We described translating parts of symmetric monoidal categories into inductive diagrams in the previous section and Table 1. Given the ZX-calculus is a symmetric monoidal category generated by the Z and X spiders, we can naturally translate the ZX-calculus into an inductive datatype for Coq, as shown Figure 12. Henceforth, we use the symbolic notation introduced in Table 1. We define additional constructs for convenience. Relevant constructs include  $n\_stack1 : \forall n, \mathbb{N}, ZX\ 1\ 1 \rightarrow ZX\ n\ n$ , written  $n \uparrow zx$ , which stacks a ZX diagram with a single input and output  $n$  times upwards. We further create a shorthand for  $n$  wires stacked called  $n\_wire\ n$ .

To assign meaning to our syntactic constructs, we construct a semantic evaluation function  $\llbracket \cdot \rrbracket : ZX\ n\ m \rightarrow \mathbb{C}^{2^m \times 2^n}$ ; a ZX-diagram with  $n$  inputs and  $m$  outputs semantically evaluates to a matrix of size  $2^m$  by  $2^n$ . In practice, all our semantics are built using QuantumLib's [INQWIRE Developers 2022] matrices and complex numbers. We implement  $\llbracket \cdot \rrbracket$  as shown in Figure 13, with the minor difference that instead of generating the matrices for Z spiders through the composition

$in\ out : \mathbb{N} \quad \alpha : \mathbb{R}$	$Cup : ZX\ 0\ 2$	$Cap : ZX\ 2\ 0$	$in\ out : \mathbb{N} \quad \alpha : \mathbb{R}$
$Z\ in\ out\ \alpha : ZX\ in\ out$	$Box : ZX\ 1\ 1$	$Swap : ZX\ 2\ 2$	$X\ in\ out\ \alpha : ZX\ in\ out$
$Wire : ZX\ 1\ 1$	$Compose\ zx_0\ zx_1 : ZX\ in\ out$	$Stack\ zx_0\ zx_1 : ZX\ (in_0 + in_1)\ (out_0 + out_1)$	$Empty : ZX\ 0\ 0$

Fig. 12. The inductive constructors for block representation ZX-diagrams

$$\begin{aligned}
 \llbracket Empty \rrbracket &= I_{1 \times 1} & \llbracket Wire \rrbracket &= I_{2 \times 2} & \llbracket Box \rrbracket &= H & \llbracket Cap \rrbracket &= [1, 0, 0, 1] \\
 \llbracket Swap \rrbracket &= |00\rangle\langle 00| + |11\rangle\langle 11| + |01\rangle\langle 10| + |10\rangle\langle 01| & \llbracket Cup \rrbracket &= [1, 0, 0, 1]^T \\
 \llbracket Z\ n\ m\ \alpha \rrbracket &= |0\rangle^{\otimes m} \langle 0|^{\otimes n} + e^{i\alpha} |1\rangle^{\otimes m} \langle 1|^{\otimes n} & \llbracket X\ n\ m\ \alpha \rrbracket &= H^{\otimes m} \times \llbracket Z\ n\ m\ \alpha \rrbracket \times H^{\otimes n} \\
 \llbracket zx_0 \leftrightarrow zx_1 \rrbracket &= \llbracket zx_1 \rrbracket \times \llbracket zx_0 \rrbracket & \llbracket zx_0 \updownarrow zx_1 \rrbracket &= \llbracket zx_0 \rrbracket \otimes \llbracket zx_1 \rrbracket
 \end{aligned}$$

Fig. 13. VyZX semantics

of vectors, we directly build the resulting matrix. The same holds for swaps, which are also built directly. These two different representations are proven to be equivalent, with one being more useful for proof and the other for direct computation. Notice that some constructs such as `Wire`, `Box`, `Cap`, and `Cup` could be equivalently created out of various compositions of spiders. However, given that they will appear frequently in definitions and lemmas, it is useful to have them as their own constructors.

We need a notion of equality to reason about statements in  $\forall y ZX$ . We define the equivalence relation *proportionality*, as discussed in [Section 2](#):

$$\forall (z_{x_0}, z_{x_1} : ZX\ n\ m), z_{x_0} \propto z_{x_1} := \exists c \in \mathbb{C}, \llbracket z_{x_0} \rrbracket = c \cdot \llbracket z_{x_1} \rrbracket \wedge c \neq 0$$

We show within Coq that this is an equivalence relation and that `Stack` and `Compose` are *parametric morphisms* [[Sozeau 2023](#)], meaning that we can safely rewrite using proportionality within ZX-diagrams. Using the definition of proportionality, we can then prove facts about the ZX-calculus.

A major difference to conventional proofs in ZX-calculus, where one reasons about ZX-calculus through the lens of adjacency, is the explicit structure of stacking and composition. A common challenge in dependently typed programming shows up, as we require precise equality of dimensions across proportionality and the composition constructor. While the proof of the associativity of `Compose` is trivial, we encounter an issue with `Stack`. Consider the diagrams  $z_{x_0} : ZX\ n\ m, z_{x_1} : ZX\ n'\ m', z_{x_2} : ZX\ n''\ m''$ . Here we see that  $(z_{x_0} \downarrow z_{x_1}) \downarrow z_{x_2}$  and  $z_{x_0} \downarrow (z_{x_1} \downarrow z_{x_2})$  have the types  $ZX\ (n+n')+n''\ (m+m')+m''$  and  $ZX\ n+(n'+n'')\ m+(m'+m'')$ , respectively, as we see from the typing rules in [Figure 12](#). To bridge this gap, we define a function called `cast` with the following type:

```
cast (n m : ℕ) {n' m' : ℕ} (prfn : n = n') (prfm : m = m') (zx : ZX n' m') : ZX n m.
```

`cast` uses a proof that  $n = n'$  and  $m = m'$  to change the explicit dimensions of a ZX-diagram. Casting functions have been used in similar contexts, like the Lean matrix library `mathlib3`'s `matrix.reindex` [[mathlib Community 2020](#)] or Coq vector library's `cast` [[Coq Development Team 2012](#)]. Note that Coq can infer the first target dimensions of `cast` as well as the types of `prfm` and `prfn`. Casts introduce more implicit structure into our already highly structured diagrams. For example, in proving associativity, we can decide which side of the proportionality judgment is cast to the other's dimensions. In the implementation, we define numerous lemmas to move casts through our structure under type restrictions appropriately. In practice, it turns out that the added structure and required moves are the only proof overhead caused. Any potential obligations from creating/manipulating casts can commonly be resolved using a linear arithmetic solver such as Coq's `lia` [[Besson 2007](#)].

With proof irrelevance (see Hedberg's theorem [[Hedberg 1998](#)]), we can then have arbitrary rewrite capabilities over casts. Unfortunately, in its current state, Coq's `rewrite` tactic is not powerful enough to natively allow for rewrites over arbitrary proofs, as with parametric morphisms parameterization is only allowed over the arguments of the relation ( $\propto$ ) itself. We show the Coq code for stack associativity as an example illustrating the use of `cast` in [Listing 1](#). Here, `cast` serves to unify the dimensions of the proportionality statement. Notice that while we could provide an exact proof to `cast (Nat.add_assoc)`, we instead keep the proof parameterized. This allows us to ignore the specific construction of the equality proof and consider any proof sufficient and allows us to circumvent the limitations of the Coq rewrite engine regarding proof irrelevance. If used in forward rewrites, this decision creates additional obligations, which can either be immediately resolved with automation or deferred to the end, where all remaining obligations generated by cast operations can be resolved using a linear arithmetic solver. Since our lemmas are parametric over equality proofs, we can backwards rewrite with any arbitrary proof. For key results intended to be proven, it is prudent to restate the theorem without parametric proofs and then use the

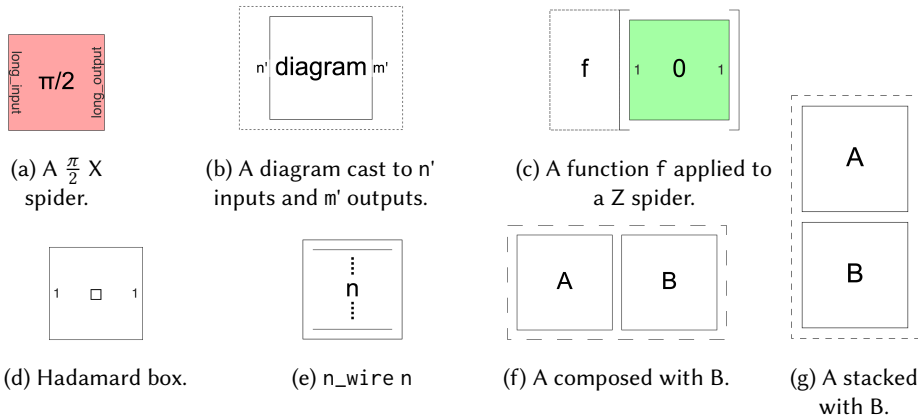

Fig. 14. VyZX constructors and functions visualized using ZXViz. See Section 4 for details on the constructs.

parametric proof with an arithmetic solver to prove their soundness. Therefore, our approach allows us a lightweight, Coq rewrite engine compatible, encapsulation of proof irrelevance at the cost of automatically resolvable goals.

```

Lemma stack_assoc :  $\forall \{n0\ n1\ n2\ m0\ m1\ m2 : \mathbb{N}\}$ 
(zx0 : ZX n0 m0) (zx1 : ZX n1 m1) (zx2 : ZX n2 m2) prfn prfm,
(zx0  $\Downarrow$  zx1)  $\Downarrow$  zx2  $\propto$  cast _ _ prfn prfm (zx0  $\Downarrow$  (zx1  $\Downarrow$  zx2)).
    
```

Listing 1. Example of the use of cast: Proving the associativity of stack

Using cast gives a fully expressive approach to dealing with dependent types of compositional objects. There have been various approaches in the past to solve similar problems. One of the approaches is phantom typing [Rand et al. 2018a], where we allow the types of compositional objects to change and then require implicit unification later. Phantom types provide great flexibility but also obfuscate information critical to proof. For example, phantom types can cause rewrites to fail silently because of the disconnect between displayed and expected types. While there are automation possibilities to restore such types in a phantom-type context, we can apply the same logic to reduce explicit cast terms. In fact, VyZX handles most straightforward cases of cast automatically, as we discuss in Section 7.3. This makes cast not only a more explicit approach but one which retains flexibility.

## 5 ZXVIZ

With all the structure we introduce for ZX-diagrams in VyZX, our textual, inductive representation of ZX-diagrams can be deeply nested and tricky to parse. To address this, we exploit the inherently visual nature of our diagrams to provide a human-readable diagrammatic representation using ZXViz. The block structure is one key feature distinguishing ZXViz diagrams from standard visualizations of ZX-diagrams. ZX-diagrams are built around the principle of connectivity, which alone is insufficient for formal reasoning. VyZX proofs manipulate the associativity and subdiagrams of the block form instead of just the connectivity of the graphical form. Further, parametric properties such as the number of inputs and outputs for casts must be kept intact in the visualizations, something the standard representation does not make room for.

Figure 14 shows how we visualize constructs from Section 6. To avoid ambiguity relating to associativity information, we also enclose the stacked, composed, or cast diagrams within a dashed

boundary. The styles for the dash are slightly varied by construct to improve readability when multiple dashed lines are side by side.

$VyZX$  diagrams are more frequently more complex than just the single elements explored above. In Sections 7.6 and 7.7, we use  $ZXViz$  to render entire example proofs as diagrams.

The visualization makes it a lot simpler to interpret the structure of terms. The visualization clarifies how the subterms fit into the larger associativity structure. We discuss how this aids proof engineering practice in Section 7.4. As terms get more complex, the visualizations significantly enhance the user’s experience with parsing the proof term. Using color for the  $Z$  and  $X$  spiders gives us another layer of visual communication that text cannot provide. Associativity can be challenging to understand from the term string, but the visual element makes it easy to parse.

The  $ZXViz$  implementation can roughly be divided into five stages. First, the input  $VyZX$  proof state is lexed and parsed. Next, the parsed term and all nested sub-terms are assigned graphical objects, which are assigned sizes and coordinates on an HTML canvas of size defined by the user-specified scale. The term is then rendered using those coordinates, adding additional visual components, including text and color. Finally, this canvas is displayed as a webview in the VSCode user interface and rendered as a panel alongside the code and goals.

## 6 $VYZX$

To encode the  $ZX$ -calculus, we need both diagrams and rules. Section 4 described how we can encode any  $ZX$ -diagram in Coq. Here, we show how to encode the canonical set of rules from Section 2 using the visual representation generated by  $ZXViz$ .

*Spider fusion.* Spider fusion is perhaps the most interesting and important rule in the  $ZX$ -calculus. We implement it in  $VyZX$  by explicitly encoding the number of inputs and outputs of each spider and the connections between the two spiders. Notice that the dimensions in Figure 15a across the cast are  $top + (1 + mid) + bot$  and  $top + (1 + mid + bot)$  respectively. To unify this discrepancy, we must cast (see Section 4) one side of the composition. This rule also highlights that we can express  $VyZX$  rules in multiple ways. For example, we assume that the left node in the fusion expression is above the wires and the right node is below the wires. There are, however, many combinations of different locations for the rules. Further, we could cast either the left or right side. Later, in Section 7, we discuss the proof engineering techniques to deal with such structural challenges.

*Self-loop removal.* Figure 15b shows self-loop removal in  $VyZX$ . We express self-loop removal with the restriction that the self-loop has come from a given spider’s top inputs/outputs. However,

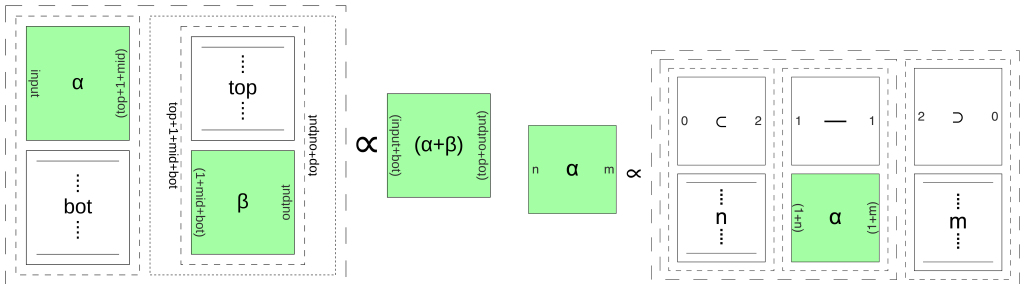

(a) Spider fusion in  $VyZX$

(b) Self-loop removal in  $VyZX$

Fig. 15. Select rules from  $VyZX$

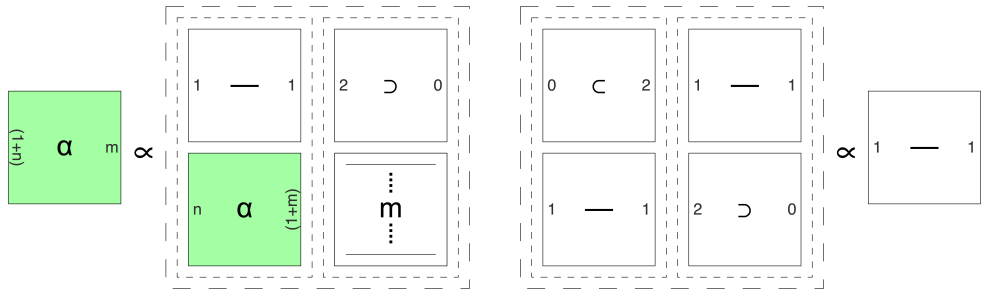

(a) The wrap over top left lemma used to express only connectivity matters

(b) A yanking lemma used to simplify connectivity information, one of the triangle isomorphisms of our category (see Definition 5).

Fig. 16. A visualization of a selection of VyZX lemmas to express “only connectivity matters”

using swaps constructors, we can swap any output of a spider to become the uppermost. We can then remove swaps fully connected to a spider using other lemmas.

*Bi-algebra rule.* Using the expected constructs, we express the bi-algebra rule in VyZX cast free. Note that this rule depends on the associativity of the three-component stack and the composes. We discuss the engineering implications of situations like this in Section 7.

The *Hopf rule* and *state-copy-rule* can be directly stated in VyZX, as shown in Figures 26d and 27a.

*Only connectivity matters.* One significant “only connectivity matters” rule in ZX-diagrams is freely converting between inputs and outputs. We have wrapping lemmas like the one shown in Figure 16a to make this possible within our block structure. This lemma allows us to change an input wire to an output wire. We also have lemmas for wrapping outputs to become inputs and lemmas for wrapping below a spider. Having this lemma allows us to manipulate connection information locally on a spider. Globally, we have other lemmas, such as the yanking lemma shown in Figure 16b, to manipulate connectivity information in a diagram. With these lemmas, we encapsulate “only connectivity matters” without relying on a datatype that only cares about connection information.

*Transpose & Adjoint.* As we can see, VyZX rules are often restricted because they require certain relative positioning. However, using VyZX, we can rearrange the structure if necessary or prove lemmas with different positioning (e.g., spider where we fuse top left into bottom right). We can automate these changes using the transpose, adjoint, and color swap operations.

*Completeness.* VyZX implements Jeandel et al.’s [Jeandel et al. 2018] complete set of rewrite rules for the ZX-calculus. This allows us to prove two diagrams equivalent without having to rely on the matrix semantics or any matrix level manipulations. The full set of rewrite rules is given in ZXVIZ form in Appendix A.

## 6.1 Ingesting Quantum Circuits

Quantum programs are usually represented using the circuit model [Deutsch 1989; Nielsen and Chuang 2010]. SQIR [Hietala et al. 2021a] embeds quantum circuits in Coq, with a translation to QuantumLib matrices [INQWIRE Developers 2022]. Fundamentally, its representation of circuits is an inductive structure that allows circuit components of size  $n$  to be created. Circuits comprise a composition of components of size  $n$ . Each component either has no gate, a one-qubit gate operating on qubit  $q < n$ , or a two-qubit gate operating on qubits  $p, q < n$  where  $p \neq q$ . We immediately see

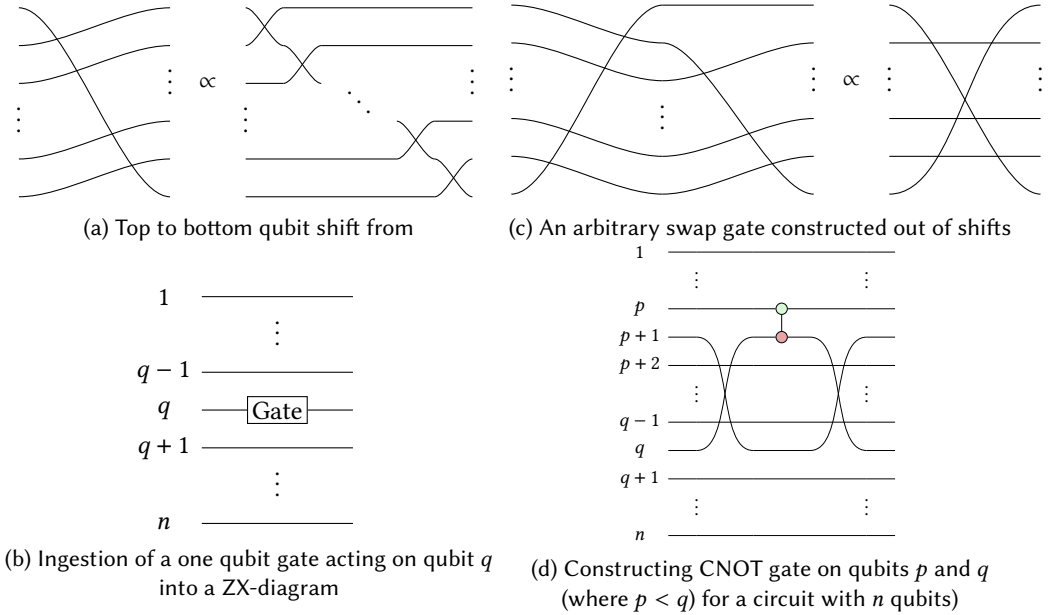
Fig. 17. Construction of sqir operations in  $VyZX$ 

that this model differs from  $VyZX$ 's model substantially. While still working based on composed blocks,  $sqir$ 's circuits must always have the same number of outputs as inputs. This differs from  $VyZX$ , where we can have diagrams with  $n$  inputs and  $m$  outputs for any  $n$  or  $m$ . Moreover,  $sqir$  circuit components explicitly specify gate locations instead of stacking diagrams.

Ingesting circuits is the process of converting  $sqir$  circuits into  $VyZX$  diagrams. In the following we describe our formalization of circuit ingestion, which has been implemented in `Coq` allowing us to create  $ZX$ -diagrams from  $sqir$  circuits. Performing this transformation for a circuit with  $n$  qubits, we build components of type  $ZX\ n\ n$  for each gate application and then compose them appropriately.

Without loss of generality, we can assume that 1-qubit gates are Hadamard, Pauli X, or Rz gates with rotation  $\alpha$ , and 2-qubit gates are CNOT gates between two qubits. We can make this assumption as `voqc` [Hietala et al. 2021b] can verifiably translate any  $sqir$  circuit into the gate set that only contains these terms<sup>5</sup>.

For the case of 1-qubit gates, we define constructions  $ZX\_H : ZX\ 1\ 1$ ,  $ZX\_X : ZX\ 1\ 1$ , and  $ZX\_Rz : \mathbb{R} \rightarrow ZX\ 1\ 1$  that translate gates to the corresponding unitary spiders<sup>6</sup>. To include explicit circuit size, we define padding functions `pad_top` and `pad_bot`, which add an arbitrary number of wires to the bottom or top of a diagram. We then use these functions to define a function that produces diagrams of the specified height. For a gate operating on qubit  $q$ , we pad our  $ZX\ 1\ 1$  circuit with  $q - 1$  wires above and  $n - q$  wires below. Figure 17b shows the result of said transformation.

To translate CNOT gates, we need to be more thoughtful. Since we can't easily connect two arbitrary qubits in  $VyZX$ , we first consider CNOTs on adjacent qubits. We see that in such situations, we can use the approach for single-qubit gates to correctly place the CNOT using a slight modification of the construction shown in Figure 17b. To allow for CNOT gates that do not operate on adjacent qubits, we swap the qubit with the higher index to be next to the qubit with the lower index. We show this construction in Figure 17d. Notice that here we use swap gates that do not merely swap adjacent qubits. Unlike the adjacent swaps, these swaps are not

<sup>5</sup>This gate set is commonly referred to as the RzQ gate set.

<sup>6</sup>See  $ZX$  construction of gates in Section 2.3.

basic constructs of our representation; we need to define them. We can use swaps of adjacent wires to create a swap between two arbitrary wires. We first define  $\text{zx\_shift } n$  as a shift of the top to the bottom qubit, as shown in Figure 17a. We use the shift to build an *arbitrary swap* as  $\text{a\_swap } n := \text{zx\_shift } (S \ n) \leftrightarrow ((\text{zx\_shift } n)^\top \uparrow \ -)$ , shown in Figure 17c. An arbitrary swap swaps the first and  $n^{\text{th}}$  qubits. Using arbitrary swaps and shifts, we can now interpret any wire crossing. Hence, in block representation, we can construct a CNOT acting on two qubits  $p, q$  by swapping one qubit next to the other qubit, applying the CNOT, and swapping back, as shown in Figure 17d. We can also construct single qubit gates as previously described. Composition of SQIR terms is represented by composition in our block representation. We have proof automation to convert any circuit problem into VyZX.

Showing this translation highlights that our syntactic representation of graphical diagrams can interoperate with different notions of semantics. In the context of proof assistants, having translations between different representations often becomes a challenge. This is especially true for systems relying on axiomatic semantics, since two systems will likely not share the same ground truth. By using QuantumLib, VyZX can be used for proof along with other libraries using QuantumLib, bridging the common pitfall of having different verification models that only exist in isolation.

## 6.2 Peephole optimizations

Using SQIR ingestion we demonstrate the capabilities of VyZX by verifying peephole optimizations from Nam et al.’s 2018 optimizer which are previously verified in the voqc optimizer [Hietala et al. 2021b].

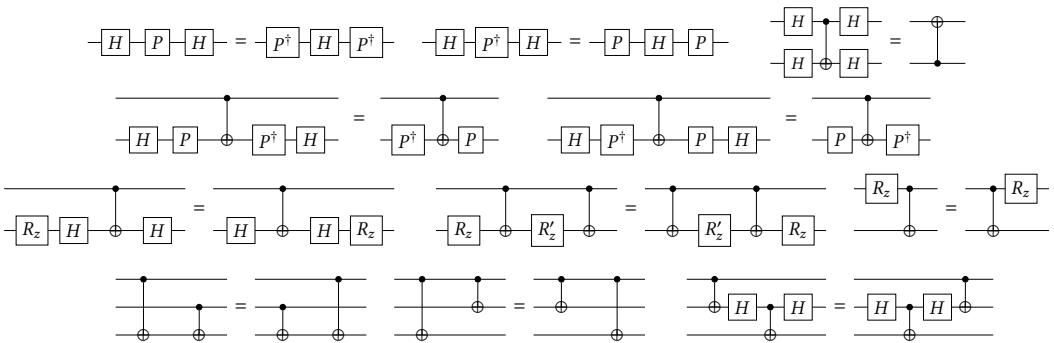

Fig. 18. The peephole optimizations from Figures 4 and 5 in Nam et al.[2018]

We use automation to convert each circuit into a ZX-diagram and then proceed to prove equivalences using VyZX’s rules. Across all these peephole optimization proofs, we found that VyZX was able to produce shorter proofs of the same statement. While there are significant differences in how voqc and VyZX approach these problems, that would be true of any two systems we chose to compare. In VyZX we are often able to clearly see the equivalences based on the few ZX rules that exist and have an immediate proof path we can follow. Due to VyZX’s approach, we are able to use the fact that some of these rules are corollaries of each other, as they are equivalent save for the fact that they are transposes, complex conjugates, or color swapped versions of each other. This is something that is easy to see diagrammatically, but potentially hard to see if you’re working at a textual level. By using ZXViz and working diagrammatically, we are able to see this and easily reuse code when needed. By implementing these optimizations we show the flexibility of the ZX-calculus

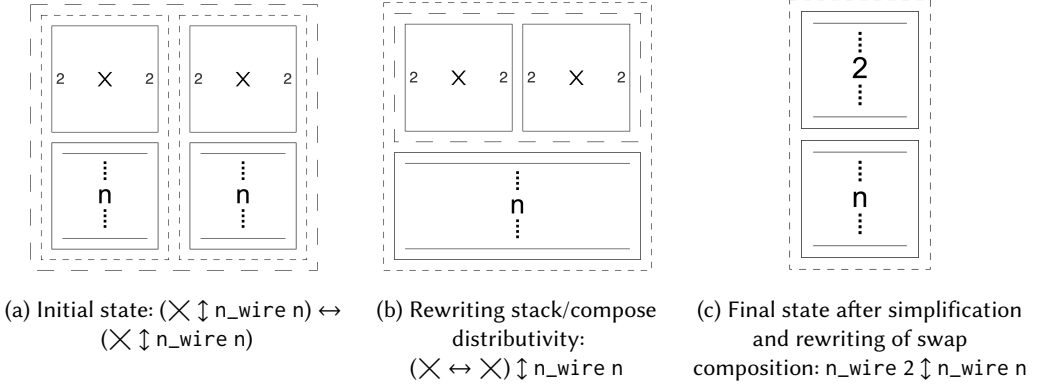

Fig. 19. Example of rewriting structure

for reasoning about quantum systems. We also set the foundations for building a verified optimizer based on the ZX-calculus instead of quantum circuits.

## 7 GRAPHICAL PROOF IN VYZX

Every formal verification project must eventually confront proof engineering challenges. In  $VyZX$ , it is important to concisely express proofs about the ZX-calculus. To this end, we prove basic facts about the graphical language through the underlying linear algebraic semantics. These basic facts allow us to derive additional lemmas without appealing to linear algebra. Proving facts using only graphical reasoning allows for more understandable proofs. This approach is integral to the school of *Quantum Picturalism* [Coecke 2010; Coecke and Kissinger 2017], the philosophy that underlies the ZX-calculus and quantum process calculi in general.

The constructors within  $VyZX$  represent graphical objects textually. This textual representation can be unintuitive. We must consider how to make it approachable. Using  $ZXViz$ , we visualize the proof term’s structure to comprehend the proof state and effectively identify rewrite strategies.

### 7.1 Structural manipulation

The block structure defined in Section 4 introduces new proof challenges. When defining lemmas, we can encode our diagrams in multiple ways using block structure. When using them for proof, we often find that the structure found in the lemma does not precisely match the structure in the diagram we are attempting to rewrite. Consider the diagram  $(X \downarrow_{n\_wire} n) \leftrightarrow (X \downarrow_{n\_wire} n)$ , shown in Figure 19a. We want to perform a rewrite on swaps that are effectively adjacent, using a lemma that states  $X \leftrightarrow X \circ_{n\_wire} 2$ . First, we must rearrange the structure using distributivity and associativity rules for stack and compose. With those rules applied, we get to the form  $(X \leftrightarrow X) \downarrow_{n\_wire} n$ , shown in Figure 19b. We can now rewrite using the lemma we intended to use; we show the final stage in Figure 19c.

Often we wish to apply lemmas to a subdiagram deeply embedded in a larger diagram. Manually, this would require a significant amount of proof overhead. The proof engineer would be writing a lot of lines of code that are semantically irrelevant and merely change the associativity structure of diagrams. To measure how big this issue is in practice, we took basic counts of rewrites we consider to be purely structural: ones that deal with associativity, commutativity, casting, and other simplification. We found that 27.27% of all tactic applications within  $VyZX$  proofs are to manipulate associativity. Of those, 24.33% (i.e., 6.63% of overall statements) are repeated applications (we consider `Ltac` automated statements to be single statements). Given that many  $VyZX$  proofs are



```

; Functions and rules to define "dependent types"
(function ZX_n (ZX) Dim)
(function ZX_m (ZX) Dim)
(rewrite (ZX_n (ZX_Z n m a)) n)
(rewrite (ZX_m (ZX_Z n m a)) m)
(rewrite (ZX_n (ZX_cast a n m)) n)
(rewrite (ZX_m (ZX_cast a n m)) m)
(rewrite (ZX_n (ZX_compose a b)) (ZX_n a) :when ((= (ZX_m a) (ZX_n b))))
(rewrite (ZX_m (ZX_compose a b)) (ZX_m b) :when ((= (ZX_m a) (ZX_n b))))
; Rest omitted for brevity

```

Listing 2. Dependent type information reconstruction in DC $\uparrow$ AC

not diagrammatic but instead do direct linear-algebraic reasoning that does not count towards the structural rewrite count, we can start to see the practical costs of having to manually associate diagrams in our proof development. To bridge this gap, we developed DC $\uparrow$ AC (*Distributivity, Cast, and Associativity in Coq*). DC $\uparrow$ AC is a tool that takes in two structural ZX-diagrams equal up to associativity information and checks their equivalence. While there are no guarantees that DC $\uparrow$ AC can correctly label *any* two ZX-diagrams that are equal up to associativity, it has proven quite robust in practice.

DC $\uparrow$ AC is built upon E-Graphs, which allow us to reach every possible equivalent state when reasoning about equalities, while avoiding double computation. `egglog` [Zhang et al. 2023] is a prolog/datalog-style domain-specific language that abstracts the E-Graphs representation. `egglog` performs *equality saturation* [Tate et al. 2009] with user defined algebraic data types and rules. Instead of having to either guess a candidate for rewriting or try all rewrites concurrently, equality saturation uses the E-Graph structure to bound the search space. E-Graph systems (such as `egg` [Willsey et al. 2021]) also allow for extracting a proof [Flatt et al. 2022], however, this feature is being actively worked on in `egglog`.

We are building DC $\uparrow$ AC on `egglog`. Within `egglog` we encode ZX-diagrams as a regular datatype. `egglog` does not support dependent types, while some of our rules fundamentally rely on our ZX constructors' dependent types, which specify a number of inputs and outputs. We effectively express dependent types within `egglog` by modeling them as functions from the inductive constructors to the respective type, as shown in Listing 2. Concretely, for inductive ZX-diagrams, we model the two dependent types (`nats`) as functions from ZX-diagrams to a datatype resembling Coq's natural number expressions, for inputs and outputs. This datatype allows for Coq style simplification, such as constant folding or removing left identities for addition and multiplication. Further, we can encode dependent type constraints in rules, ensuring that rewriting with such rules does not break well-formedness. There are no technical guardrails to prevent malformed diagrams from existing, but given rules that preserve well-formedness, we can only obtain malformed diagrams by inputting malformed diagrams. Since we import diagrams from Coq into DC $\uparrow$ AC, we know that diagrams are well-formed at the time of input, so we should not run into situations where invalid diagrams arise. Since `egglog`'s proof extraction is actively being developed, we do not yet have a full pipeline to generate Coq proofs but plan on implementing this feature once proof extraction is complete. At that point, we will be able to integrate DC $\uparrow$ AC with VyZX as a Coq plugin, as Coq's typechecker will be able guarantee that the proofs produced by `egglog` are correct.

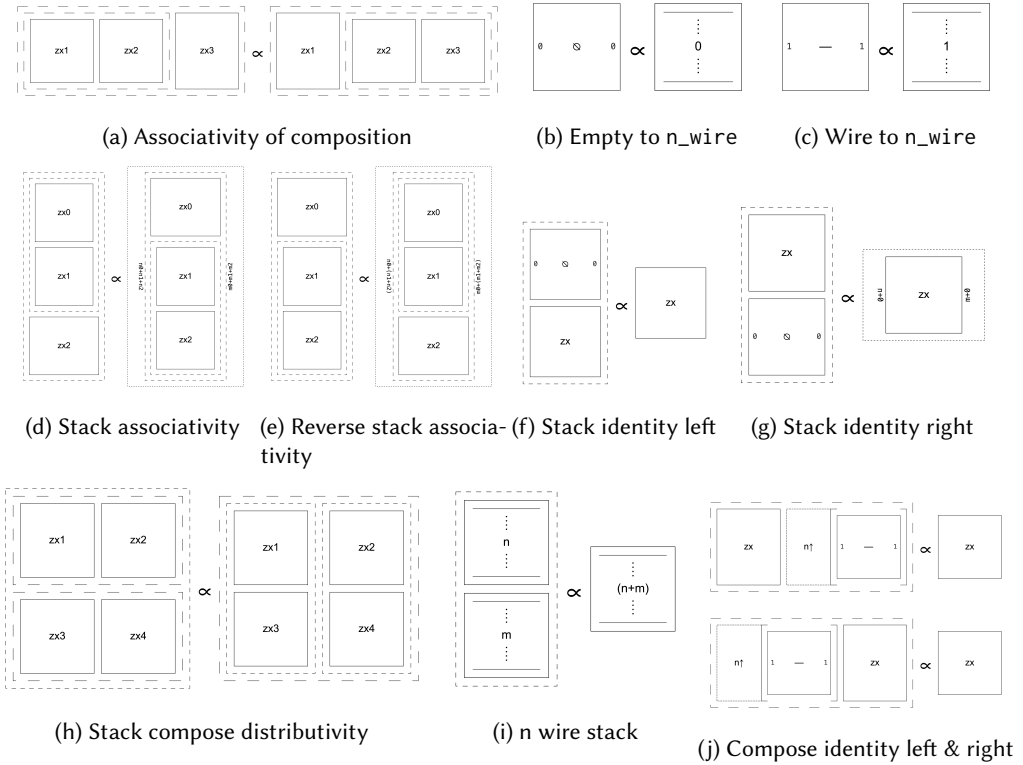
Fig. 20. The lemmas we encode in  $DC\downarrow AC$  rendered with  $ZXViz$ 

```
(rewrite (ZX_compose (ZX_stack zx0 zx1) (ZX_stack zx2 zx3))
  (ZX_stack (ZX_compose zx0 zx2) (ZX_compose zx1 zx3))
 :when ((= (ZX_m zx0) (ZX_n zx2)) (= (ZX_n zx3) (ZX_m zx1))))
```

Listing 3. `stack_compose_distr` translated into `egglog` where `ZX_n` and `ZX_m` are the functions providing dependent type information

With the rules in [Section 7.1](#) rules most associativity problems and other menial structural rewrites can be easily performed automatically. We convert  $VyZX$  lemmas into a simple intermediate representation embedded in Python, which in turn automatically translates into `egglog` code. This second translation happens in two stages: First, the statement is translated without dependent types; second, the dependent type constraints are generated. With these constraints we ensure that no malformed diagrams are produced. Looking at [Figure 20h](#),  $DC\downarrow AC$  would output the code shown in [Listing 3](#), as `stack_compose_distr` requires `zx1` to have the same number of outputs as `zx2` has inputs. We know, however, that in Coq this equality doesn't have to be syntactic equality but equality up to constant folding and left identities. Since we have encoded this information in `egglog`, we know through the process of equality saturation we can perform these rewrites with preconditions on dimensions even for dimensions that are not syntactically equal.

### 7.2 Induction

A central proof tactic we want to bring to graphical calculi is induction, allowing us to prove statements for parametric numbers of inputs or outputs of a given node. In inductive cases, we generate a hypothesis about a smaller diagram and use the techniques described earlier to simplify our goal and apply the hypotheses. These techniques rely on our splitting lemmas, which are themselves proved inductively. We discuss how we built induction capabilities throughout VyZX to apply inductive reasoning in practice.

Induction on the size of a spider relies on splitting out a two-connection spider. We describe this with the lemma shown in Figure 21a. We prove this lemma directly via the underlying semantics by using mathematical properties of composition and stacking. Using this lemma, we then prove the lemma shown in Figure 21b. This lemma allows us to reason inductively over spider sizes and hence allows us to prove parametric rules, such as the wrapping rules shown in Section 6. We prove such a rule in Section 7.6.

### 7.3 Proof automation

Previously, we primarily talked about lemmas that act on Z spiders; however, from the ZX-calculus, we know that every valid statement has a valid dual where all spider colors are swapped. We encapsulate this through a function that creates the dual diagrams, denoted by  $\odot$ , and we prove that  $zx0 \propto zx1$  implies  $\odot zx0 \propto \odot zx1$ . Similarly, we create a function to transpose diagrams and prove a corresponding lemma. Using Coq’s proof automation features, specifically `autorewrite` and `Ltac`, we provide tactics that automatically prove the color-swapped or transposed versions of a lemma. For example, we prove the dual of `Hopf_rule_Z_X` in Listing 4, and we show the diagram in Figure 22. The `colorswap_of` tactic takes the color-swap of both sides of the provided statement, simplifies trivial components, and uses other proven identities of color-swap to simplify further. We automate proofs about the transposed versions of diagrams using a similar tactic. We can drastically reduce proof overhead and increase proof maintainability using these two automation tactics.

**Theorem** `Hopf_rule_X_Z` :

$$(X\_Spider\ 1\ 2\ 0) \leftrightarrow (Z\_Spider\ 2\ 1\ 0) \propto (X\_Spider\ 1\ 0\ 0) \leftrightarrow (Z\_Spider\ 0\ 1\ 0).$$

**Proof.** `colorswap_of Hopf_rule_Z_X. Qed.`

Listing 4. Example of proving the dual of a lemma. See Figure 22 for visualization

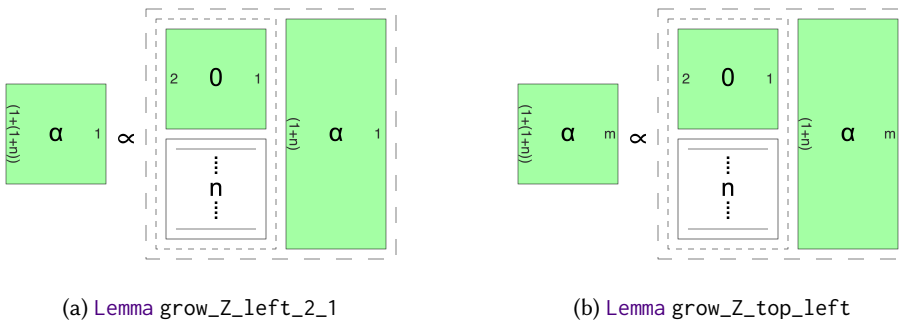

Fig. 21. `grow_Z_top_left` is built by induction using the base lemma `grow_Z_left_2_1`

Along with these proof automation options, we also have a variety of tactics to automatically deal with structural trivialities, such as superfluous stacks of empty diagrams or compositions with  $n_{\text{wires}}$ . With this automation, we can deal with most such structures arising from rewrites in practice. Without the strategies mentioned above, the size of proofs would grow significantly and make them harder to comprehend. These observations confirm previous findings of domain-specific optimizations being a valuable aide to proof engineering [Ringer et al. 2020].

We also have automation in place to simplify casts. Besides eliminating trivial casts, the automation attempts to merge multiple casts into a single cast by lifting them to the outermost part of the relevant structure. With these tools, we have been able to remove most casts within our diagrams automatically. In cases where our cast automation does not work immediately, we have found that after performing a suitable rewrite within the cast, the automation works successfully.

#### 7.4 Using visual proof

$\text{V}_y\text{ZX}$  aims to prove graphical statements. We represent such statements through a syntax tree, as described in Section 6, along with a provided visualization, as described in Section 5. Our visualization aims to convey the core information that  $\text{V}_y\text{ZX}$  diagrams capture: its inductive elements and the overall structure. Specifically, we choose not to use the conventional visualization form of ZX-diagrams, which focuses on connectivity without conveying the integral structural information we need. The integral structural information comes in the form of swaps, caps, and cups, which tell us how wires must bend and cross to make the diagram connect. This explicit information is not present when you only focus on connectivity.

ZXViz is integrated with the `coq-lsp` [Developers 2023] language server to render diagrams of proof terms in the goal state automatically. When the proof state in focus changes, the `coq-lsp` extension sends updated goals to ZXViz. ZXViz then sends the updated diagrams to VSCode, which will display them to the proof engineer. This simple workflow augments the proof engineer’s preexisting workflow by providing a digestible representation of  $\text{V}_y\text{ZX}$  diagrams.

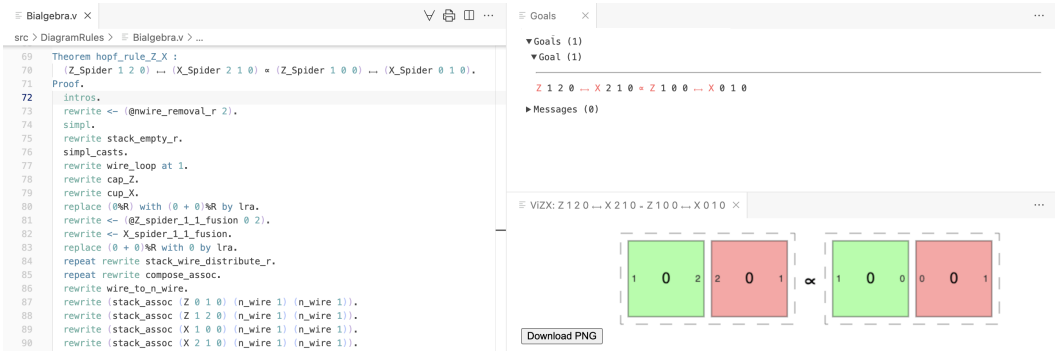

Fig. 23. ZXViz integrated with the user’s proof writing environment.

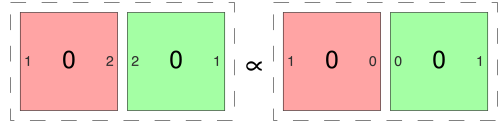

Fig. 22. Color-swapping the hopf rule, as defined in Figure 5c, using automation

## 7.5 Static validation in VyZX

In previous sections, we discussed the importance of having multiple versions of a lemma. For example, most lemmas need their color-swapped version. Relying on humans to notice the absence of such lemmas will typically lead to an incomplete code base. We built domain-specific static validation tools for VyZX to address this and other challenges. The most important static checker ensures that if the lemma `lemma1_X` and `lemma2_Z_X` exist, then there have to be corresponding lemmas `lemma1_Z` and `lemma2_X_Z`, respectively. This static checker relies on our file structure and our naming conventions. We also include a static checker that enforces the naming conventions themselves. Lastly, as perhaps a more broadly applicable checker, we ensure no `Search/Print/etc.` commands are committed to ensure a clean build process. Our static checkers also offer an interactive mode where every violation is highlighted and an automatic fix is offered to the engineer. The engineer can choose to accept it, provide a manual fix, ignore the violation for now, or permanently (by having the checker place a special comment instructing it to ignore the violation from now on). Using these checks, we found that our code base quality improved, fragmentation was reduced, and searching for lemmas became easier.

## 7.6 Induction example: `Z_absolute_fusion`

Our first example is an induction proof about the VyZX structure. In [Figure 24](#), we prove that two fully connected spiders can be fused; we call such fusion *absolute fusion*. The lemma is shown in [Figure 24a](#). When looking at the base ( $m = 1$ ) case in [Figure 24b](#), we see that our base case corresponds to a lemma that we previously proved via an appeal to the underlying semantics. In the  $m + 1$  case ([Figure 24c](#)), we aim to fuse the top two wires and reduce the goal to our inductive hypothesis. As shown in [Figure 24d](#), we first expand both spiders to have 1 input and 2 outputs or 2 inputs and 1 output spiders emerging from the top. We then reassociate in [Figure 24e](#). Then, we fuse the expanded spiders in [Figure 24f](#). We use automation to clean up the diagram; we show the state in [Figure 24g](#). Lastly, we complete the proof using the inductive hypothesis in [Figure 24h](#).

## 7.7 Bell state preparation

To show an example of structural editing within VyZX, we prove the correctness of the bell state preparation circuit. First, we transform the standard Bell pair circuit into a ZX-diagram by translating gates as shown in [Section 2.3](#). [Figure 25a](#) shows the outcome of this translation: The two X spiders on the left prepare qubits in the  $|0\rangle$  state, which is followed by a Hadamard and CNOT gate. We start the proof by reassociating to use bi-Hadamard color-swapping on the top wire in [Figure 25b](#). After that, we reassociate (see [Figure 25c](#)) and fuse the two Z spiders in [Figure 25d](#). The next step is to reassociate ([Figure 25e](#)) and to fuse the X spiders in [Figure 25f](#). Lastly, in [Figure 25g](#), we simplify the resulting diagram and then convert the spider into a cap in [Figure 25h](#).

## 8 RELATED WORK

*ZX-calculus tools.* *Quantomatic* [[Kissinger and Zamdzhiev 2015](#)] is a diagrammatic proof assistant specific to the ZX-calculus which allows for assisted ZX-calculus rewrites. Quantomatic uses a visual interface and allows finite diagrammatic rewrites to be performed using its UI. Quantomatic isn't verified with respect to underlying linear algebraic semantics, meaning it would have difficulty interfacing with a broader verified library. It is a useful interactive theorem prover for reasoning about ZX-diagrams, but it is unable to verify programs which operate on ZX-diagrams. This is a gap that VyZX aims to fill. The ZX-calculus has been shown to be useful for building quantum computing tools. Given the complex nature of quantum computing and the narrow range of tools required, this we believe this to be a prime opportunity for building verified software and try to fill

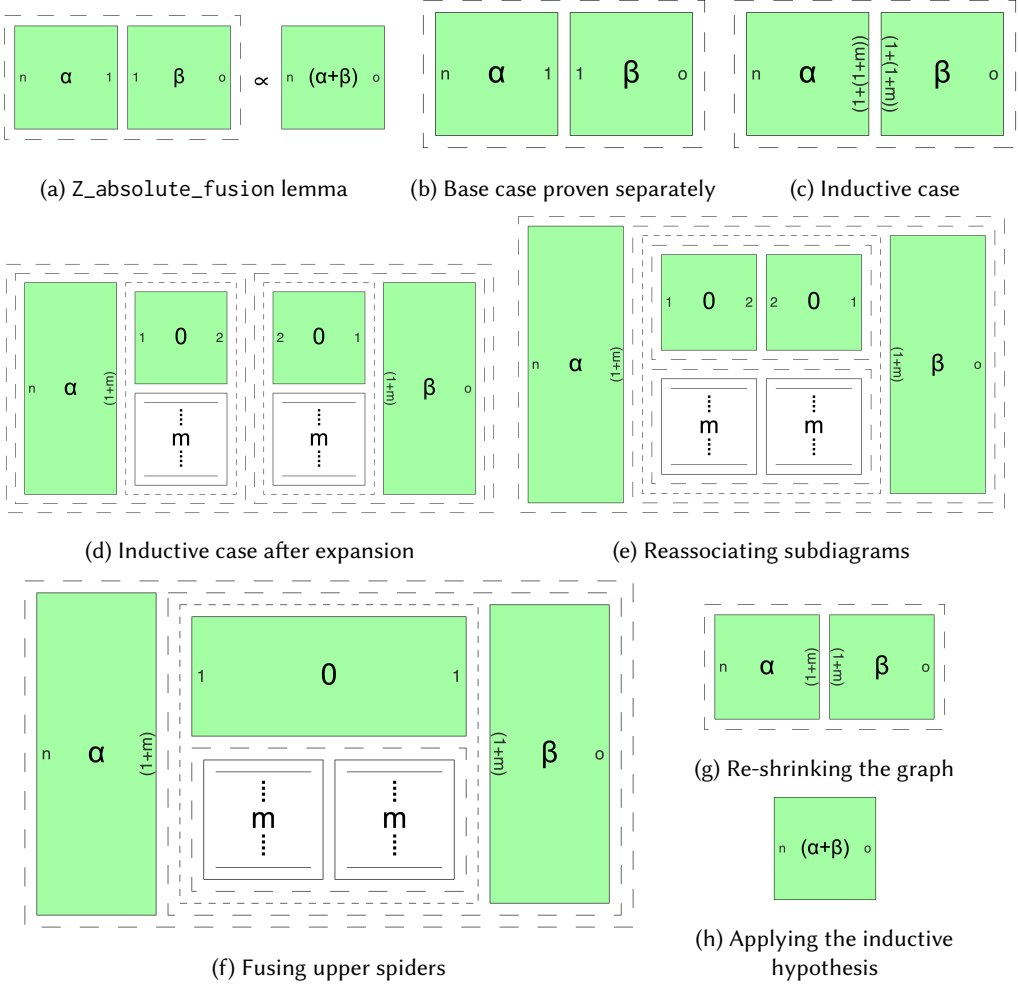

Fig. 24. Proof of Z\_absolute\_fusion.

the gap for ZX-calculus with  $\forall yZX$ . Quantomatic, however, allows for reasoning through adjacency and hence avoid the structural overhead introduced by  $\forall yZX$ , leaving it a useful tool for research on theoretical ZX-calculus results.

Similarly, Kissinger [2023] recently released Chyp, an interactive theorem prover for symmetric monoidal categories. It manages a textual and visual representation to assist in proof over these categories. Chyp allows the user to define axioms and generators for any symmetric monoidal category to use in proof. This means it is not restricted to the ZX calculus but depends on the user’s defined axioms and generators. Chyp does not support parametric generators, so every generator must have a fixed finite dimension for its inputs and outputs. Fixed and finite dimensions are often times very limiting, especially when needing to discuss families of diagrams, such as in the domains of circuit optimization and error correction. It an important design consideration in  $\forall yZX$  to allow such reasoning allow general software to be able to abstractly reason about these domains so that verified software packages can be built. Chyp is also limited to reasoning about string diagrams and does not allow for extracting programs, which is a core part of  $\forall yZX$ .

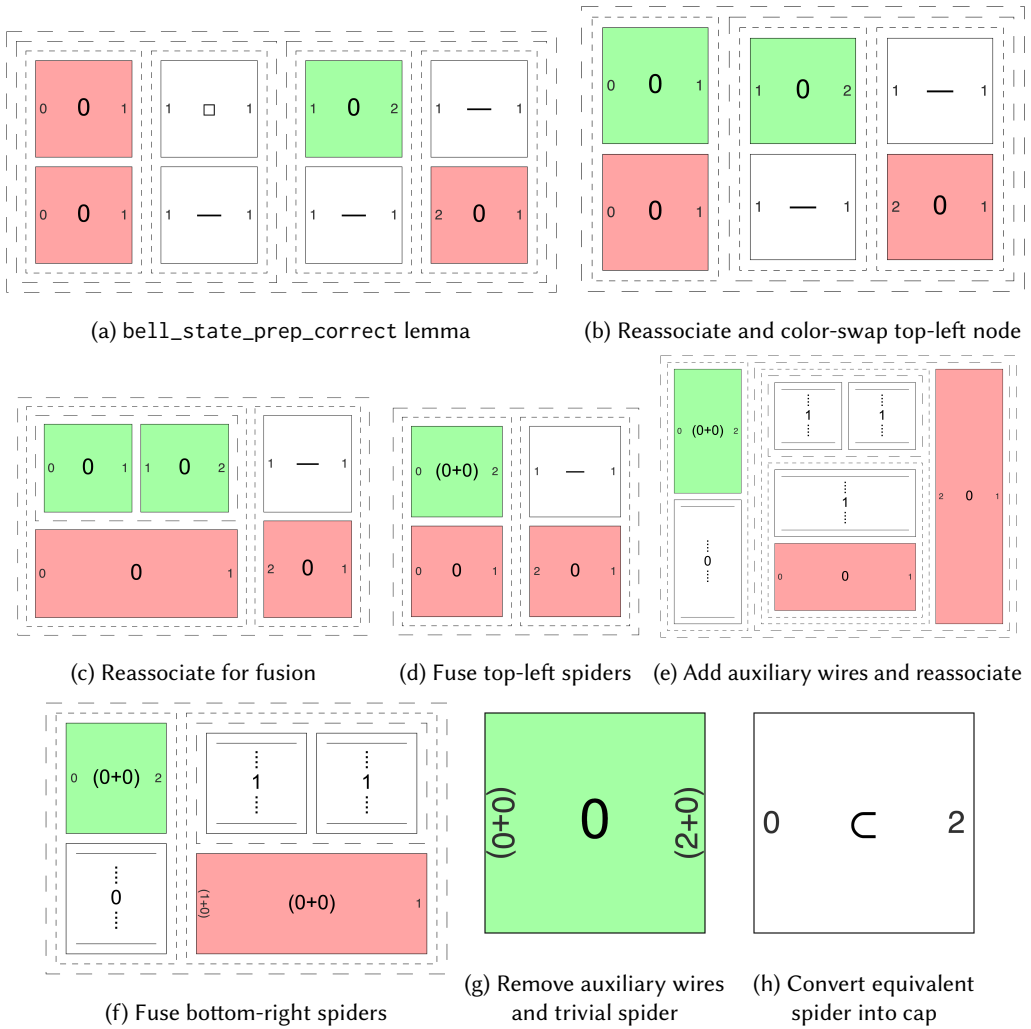

Fig. 25. Proof of the correctness of bell state preparation in VyZX. See Section 7.7.

*Proof visualization.* There have been efforts in developing primarily graphical proof assistants [Jörg et al. 1999], as well as integrating visual components into primarily textual proof assistants [Ayers et al. 2021]. One recent development in this domain is the diagram editor Yade [Lafont 2023] for Coq proofs. Yade deploys a bidirectional framework to allow for both construction of diagrammatic proofs from proof scripts, and generation of mechanical proofs from diagrams. The diagrammatic foundations of categorical semantics make it a perfect candidate for such a bidirectional tool, and future work on ZXViz intends to generalize it to a bidirectional framework. Proof assistants such as Lean [de Moura et al. 2015] have even successfully integrated interactive, user-specified graphical components into the proof engineering workflow [Nawrocki et al. 2023] for users to define their own interfaces as they see fit. This approach is far more general than the one we took with ZXViz, but may provide a roadmap to introduce such a tool to other domains.

*Verified quantum computing.* Several attempts have been made to verify quantum computation within a proof assistant, beginning with [Boender et al.’s \[2015\]](#) Coq library used to prove quantum teleportation. Later, [Rand et al. \[2018b\]](#) developed a Coq library to verify programs written in the QWIRE quantum programming language [[Paykin et al. 2017](#)]; this library later became QuantumLib [[INQWIRE Developers 2022](#)]. QuantumLib was used and expanded in the development of the SQIR intermediate representation [[Hietala et al. 2021a](#)], the voQC verified optimizing compiler [[Hietala et al. 2021b](#)], verified quantum oracles [[Li et al. 2022](#)], and a proof of Shor’s algorithm [[Peng et al. 2023](#)]; it also underlies the present work.

Other attempts to verify quantum computing and quantum protocols include QBRICKS [[Chareton et al. 2021](#)], which verified key quantum algorithms using path sums in the Why3 prover, QHL-Prover [[Liu et al. 2019](#)], which verified a quantum Hoare logic in Isabelle, and CoqQ [[Zhou et al. 2023](#)], which was able to verify cutting-edge quantum algorithms using Coq and the Mathematical Components library. These tools show showcase the active effort to verify quantum computation. Given the relevance of ZX-calculus, we believe VyZX provides the foundation to fill an important gap in verified quantum software.

*String diagrams for graphical verification.* Concurrently with our own work, [Castello et al. \[2023\]](#) proposed *causal separation diagrams* (CSDs) for reasoning about parallel processes in a proof assistant, which they formalized in Agda. A key difference between our work and their work is that their diagrams enforce a strict temporal ordering of operations: “Only Connectivity Matters” is antithetical to their application to logical clocks. The lack of OCM leads to restrictions on composition, which is an interesting aspect that many graphical reasoning systems without OCM properties share. Their work is very exciting as it implicitly deals with edge labeling, creating a path to reasoning about adjacency. We take the simultaneous development of VyZX and CSDs as a sign of burgeoning interest in process theories and diagrammatic reasoning in proof assistants.

## 9 FUTURE WORK

VyZX lays the groundwork for future work on the ZX-calculus in Coq. The ZX-calculus is particularly useful in quantum circuit optimization, as shown by the PyZX [[Kissinger and van de Wetering 2020](#)] optimizer. With the rules proven in VyZX and some extensions to the interface, a fully verified PyZX style optimizer is a clear goal for the future, fully integrating with other verified optimizers such as voQC to provide a full circuit and ZX optimization pass.

There are a variety of useful extensions to the ZX-calculus that we could explore adding to VyZX. The most immediate is conditioning on measurement outcomes. The ZX-calculus, by default, captures an idea of postselection. Suppose we add a Boolean variable to any spider with one input and no outputs. In that case, we can capture that our measurement outcome has two possibilities instead of one postselected option. These variables could be embedded in later spiders to represent conditional rotations, following [van de Wetering 2020](#).

Another exciting use of the ZX-calculus is for writing error-correcting surface codes [[de Beau-drap and Horsman 2020b](#)]. With VyZX, we can implement and verify various surface codes and conversions between them. When performing error corrections, the ZX-calculus is a useful tool to discover what measurement patterns and Pauli corrections must be applied. ZX-calculus is commonly used to visualize surface codes and translate physical actions on a code into logical actions on the logical qubit the code represents. We can use VyZX to verify the translation between physical and logical actions and the error-resistant properties of these surface codes.

ZXViz reasons about graphical structures in the context of a proof term. We plan to extend ZXViz to enable interactive proof editing of VyZX graphical structures. We believe the ZX-calculus



is a step towards entirely visual, formally verified proof, similar to unverified tools such as Quantomatic [Kissinger and Zamdzhiev 2015].

This work focuses on the ZX-calculus, but we also presented a framework for reasoning about connections in other string diagrams. These are examples of symmetric monoidal categories, which appear in various settings, including higher-dimension topological monoids and vector spaces. In initial follow-up work [Anonymized 2024], we generalize V<sub>Y</sub>ZX to reason about arbitrary symmetric monoidal categories, so that V<sub>Y</sub>ZX and the string diagrams of Section 3 can be treated as simply instances of a broader type class. We also extend the resulting tool to other categories, and add automation and visualization for those categories. We could further extend the tool to reason about areas with related categorical interpretations, like logic and topology [Baez and Stay 2010].

## 10 CONCLUSION

We presented V<sub>Y</sub>ZX, a tool for verifying the ZX-calculus. By leveraging the categorical underpinnings of ZX-diagrams, we inductively defined undirected graphs and gave them semantics in terms of complex-valued matrices. This structure allowed us to prove facts inductively about ZX-diagrams, which then enabled us to write fully diagrammatic proofs while retaining the guarantees arising from our matrix-level ground truth. Using the inductive structure presented challenges, namely dealing with additional structure and not having access to connection information directly. We presented proof strategies, automation techniques, and a visualizer to deal with these challenges. These allowed us to prove and use the standard ZX-calculus rule set, which will help verify the broad range of existing ZX-calculus tools and those yet to be developed. We hope the presented tools and techniques will be widely useful in reasoning about graphical structures both within and beyond the quantum domain.

## ACKNOWLEDGMENTS

The authors thank John Reppy for pointing us towards E-Graphs. We also especially thank Saul Shanabrook, Max Willsey, and Oliver Flatt for their time, their gracious help with egg/egglog, and for promptly fixing bugs or adding features when we needed them.

This material is based upon work supported by the Air Force Office of Scientific Research under awards number FA95502110051 and FA95502310361, and EPiQC, an NSF Expedition in Computing, under Grant No. CCF-1730449.

## REFERENCES

- Anonymized. 2024. ViCAR: Visualizing Categories with Automated Rewriting in Coq. In *Applied Category Theory*. To appear. The anonymized paper is included as supplementary material for the reviewers, following the PC chair's advice.
- Edward W. Ayers, Mateja Jamnik, and W. T. Gowers. 2021. A Graphical User Interface Framework for Formal Verification. In *12th International Conference on Interactive Theorem Proving (ITP 2021) (Leibniz International Proceedings in Informatics (LIPIcs), Vol. 193)*, Liron Cohen and Cezary Kaliszyk (Eds.). Schloss Dagstuhl – Leibniz-Zentrum für Informatik, Dagstuhl, Germany, 4:1–4:16. <https://doi.org/10.4230/LIPIcs.ITP.2021.4>
- J. Baez and M. Stay. 2010. Physics, Topology, Logic and Computation: A Rosetta Stone. *Lecture Notes in Physics* (2010), 95–172. [https://doi.org/10.1007/978-3-642-12821-9\\_2](https://doi.org/10.1007/978-3-642-12821-9_2)
- Frédéric Besson. 2007. Fast reflexive arithmetic tactics the linear case and beyond. In *Types for Proofs and Programs: International Workshop, TYPES 2006, Nottingham, UK, April 18–21, 2006, Revised Selected Papers*. Springer, 48–62.
- Jaap Boender, Florian Kammüller, and Rajagopal Nagarajan. 2015. Formalization of Quantum Protocols using Coq. In *Proceedings of the 12th International Workshop on Quantum Physics and Logic (QPL), Oxford, U.K., July 15–17, 2015 (Electronic Proceedings in Theoretical Computer Science, Vol. 195)*, Chris Heunen, Peter Selinger, and Jamie Vicary (Eds.). Open Publishing Association, Waterloo, NSW, Australia, 71–83. <https://doi.org/10.4204/EPTCS.195.6>
- Jonathan Castello, Patrick Redmond, and Lindsey Kuper. 2023. Inductive diagrams for causal reasoning. arXiv:2307.10484 [cs.PL]
- Nicholas Chancellor, Aleks Kissinger, Joschka Roffe, Stefan Zohren, and Dominic Horsman. 2018. Graphical Structures for Design and Verification of Quantum Error Correction. arXiv:1611.08012 [quant-ph]

- Christophe Charetton, Sébastien Bardin, François Bobot, Valentin Perrelle, and Benoît Valiron. 2021. An Automated Deductive Verification Framework for Circuit-Building Quantum Programs. In *Programming Languages and Systems, ESOP 2021 (Lecture Notes in Computer Science, Vol. 12648)*, Nobuko Yoshida (Ed.). Springer International Publishing, Cham, 148–177. [https://doi.org/10.1007/978-3-030-72019-3\\_6](https://doi.org/10.1007/978-3-030-72019-3_6) arXiv:2003.05841
- Bob Coecke. 2010. Quantum pictorialism. *Contemporary physics* 51, 1 (2010), 59–83.
- Bob Coecke. 2023. Basic ZX-calculus for students and professionals. arXiv:2303.03163 [quant-ph]
- Bob Coecke and Ross Duncan. 2011. Interacting quantum observables: categorical algebra and diagrammatics. *New Journal of Physics* 13, 4 (apr 2011), 043016. <https://doi.org/10.1088/1367-2630/13/4/043016>
- Bob Coecke and Aleks Kissinger. 2017. *Picturing Quantum Processes: A First Course in Quantum Theory and Diagrammatic Reasoning*. Cambridge University Press. <https://doi.org/10.1017/9781316219317>
- The Coq Development Team. 2012. The Coq Reference Manual, version 8.4. Available electronically at <http://coq.inria.fr/doc>.
- Alexander Cowtan, Silas Dilkes, Ross Duncan, Will Simmons, and Seyon Sivarajah. 2020. Phase Gadget Synthesis for Shallow Circuits. *Electronic Proceedings in Theoretical Computer Science* 318 (may 2020), 213–228. <https://doi.org/10.4204/eptcs.318.13>
- Niel de Beaudrap, Xiaoning Bian, and Quanlong Wang. 2020. Fast and effective techniques for T-count reduction via spider nest identities. arXiv:2004.05164 [quant-ph]
- Niel de Beaudrap and Dominic Horsman. 2020a. The ZX calculus is a language for surface code lattice surgery. *Quantum* 4 (jan 2020), 218. <https://doi.org/10.22331/q-2020-01-09-218>
- Niel de Beaudrap and Dominic Horsman. 2020b. The ZX calculus is a language for surface code lattice surgery. *Quantum* 4 (Jan. 2020), 218. <https://doi.org/10.22331/q-2020-01-09-218>
- Leonardo de Moura, Soonho Kong, Jeremy Avigad, Floris Van Doorn, and Jakob von Raumer. 2015. The Lean theorem prover (system description). In *Automated Deduction-CADE-25: 25th International Conference on Automated Deduction, Berlin, Germany, August 1-7, 2015, Proceedings 25*. Springer, 378–388.
- David Elieser Deutsch. 1989. Quantum computational networks. *Proceedings of the Royal Society of London. A. Mathematical and Physical Sciences* 425, 1868 (1989), 73–90.
- Cirq Developers. 2022. *Cirq*. <https://doi.org/10.5281/zenodo.7465577> See full list of authors on Github: <https://github.com/quantumlib/Cirq/graphs/contributors>.
- The Coq LSP Developers. 2023. GitHub - ejgallego/coq-lsp: Visual Studio Code Extension and Language Server Protocol for Coq – github.com. <https://github.com/ejgallego/coq-lsp>.
- Ross Duncan and Simon Perdrix. 2010. Rewriting Measurement-Based Quantum Computations with Generalised Flow. In *Automata, Languages and Programming*, Samson Abramsky, Cyril Gavoille, Claude Kirchner, Friedhelm Meyer auf der Heide, and Paul G. Spirakis (Eds.). Springer Berlin Heidelberg, Berlin, Heidelberg, 285–296.
- Oliver Flatt, Samuel Coward, Max Willsey, Zachary Tatlock, and Pavel Panchekha. 2022. Small Proofs from Congruence Closure. arXiv:2209.03398 [cs.PL] <https://arxiv.org/abs/2209.03398>
- Michael Hedberg. 1998. A coherence theorem for Martin-Löf’s type theory. *Journal of Functional Programming* 8, 4 (1998), 413–436. <https://doi.org/10.1017/S0956796898003153>
- Kesha Hietala, Robert Rand, Shih-Han Hung, Liyi Li, and Michael Hicks. 2021a. Proving Quantum Programs Correct. In *12th International Conference on Interactive Theorem Proving (ITP 2021) (Leibniz International Proceedings in Informatics (LIPIcs), Vol. 193)*, Liron Cohen and Cezary Kaliszyk (Eds.). Schloss Dagstuhl – Leibniz-Zentrum für Informatik, Dagstuhl, Germany, 21:1–21:19. <https://doi.org/10.4230/LIPIcs.ITP.2021.21>
- Kesha Hietala, Robert Rand, Shih-Han Hung, Xiaodi Wu, and Michael Hicks. 2021b. A Verified Optimizer for Quantum Circuits. *Proc. ACM Program. Lang.* 5, POPL, Article 37 (jan 2021), 29 pages. <https://doi.org/10.1145/3434318>
- INQWIRE Developers. 2022. *INQWIRE QuantumLib*. <https://github.com/inQWIRE/QuantumLib>
- Emmanuel Jeandel, Simon Perdrix, and Renaud Vilmart. 2018. Diagrammatic reasoning beyond Clifford+ T quantum mechanics. In *Proceedings of the 33rd Annual ACM/IEEE Symposium on Logic in Computer Science*. 569–578.
- Emmanuel Jeandel, Simon Perdrix, and Renaud Vilmart. 2020. Completeness of the ZX-Calculus. *Logical Methods in Computer Science* (6 2020). [https://doi.org/10.23638/LMCS-16\(2:11\)2020](https://doi.org/10.23638/LMCS-16(2:11)2020)
- Siekman Jörg, Hess Stephan, Benz Müller Christoph, Cheikhrouhou Lassaad, Fiedler Armin, Horacek Helmut, Kohlhas Michael, Konrad Karsten, Meier Andreas, Melis Erica, et al. 1999. LOUI: Lovely OMEGA User Interface. (1999).
- André Joyal and Ross Street. 1993. Braided tensor categories. *Advances in Mathematics* 102, 1 (1993), 20–78.
- Ariel E Kellison, Andrew W Appel, Mohit Tekriwal, and David Bindel. 2023. LAProof: a library of formal proofs of accuracy and correctness for linear algebra programs. (2023).
- Alex Kissinger. 2023. GitHub - akissinger/chyp: An interactive theorem prover for string diagrams – github.com. <https://github.com/akissinger/chyp>.
- Aleks Kissinger and John van de Wetering. 2020. PyZX: Large Scale Automated Diagrammatic Reasoning. In Proceedings 16th International Conference on *Quantum Physics and Logic*, Chapman University, Orange, CA, USA., 10-14 June 2019 (*Electronic Proceedings in Theoretical Computer Science, Vol. 318*), Bob Coecke and Matthew Leifer (Eds.). Open Publishing

- Association, 229–241. <https://doi.org/10.4204/EPTCS.318.14>
- Aleks Kissinger and John van de Wetering. 2022. Simulating quantum circuits with ZX-calculus reduced stabiliser decompositions. *Quantum Science and Technology* 7, 4 (2022), 044001.
- Aleks Kissinger and Vladimir Zamdzhev. 2015. Quantomatic: A proof assistant for diagrammatic reasoning. In *Automated Deduction-CADE-25: 25th International Conference on Automated Deduction, Berlin, Germany, August 1-7, 2015, Proceedings* 25. Springer, 326–336.
- Ambroise Lafont. 2023. A Diagram Editor to Mechanize Categorical Proofs. <https://ambfont.github.io/articles/yade.pdf>.
- Liyi Li, Finn Voichick, Kesha Hietala, Yuxiang Peng, Xiaodi Wu, and Michael Hicks. 2022. Verified Compilation of Quantum Oracles. *Proceedings of the ACM on Programming Languages* 6, OOPSLA2, Article 146 (October 2022), 146 pages. <https://doi.org/10.1145/3563309> arXiv:2112.06700
- Junyi Liu, Bohua Zhan, Shuling Wang, Shenggang Ying, Tao Liu, Yangjia Li, Mingsheng Ying, and Naijun Zhan. 2019. Quantum Hoare Logic. *Archive of Formal Proofs* (March 2019). <https://isa-afp.org/entries/QHLProver.html>, Formal proof development.
- The mathlib Community. 2020. The lean mathematical library. In *Proceedings of the 9th ACM SIGPLAN International Conference on Certified Programs and Proofs*. ACM. <https://doi.org/10.1145/3372885.3373824>
- Tommy McElvanney and Miriam Backens. 2023. Flow-preserving ZX-calculus rewrite rules for optimisation and obfuscation. arXiv:2304.08166 [quant-ph]
- Yunseong Nam, Neil J Ross, Yuan Su, Andrew M Childs, and Dmitri Maslov. 2018. Automated optimization of large quantum circuits with continuous parameters. *npj Quantum Information* 4, 1 (2018), 1–12. <https://doi.org/10.1038/s41534-018-0072-4>
- Wojciech Nawrocki, Edward W. Ayers, and Gabriel Ebner. 2023. An Extensible User Interface for Lean 4. In *To appear, 14th International Conference on Interactive Theorem Proving (ITP 2023) (Leibniz International Proceedings in Informatics (LIPIcs))*. Schloss Dagstuhl – Leibniz-Zentrum für Informatik, Dagstuhl, Germany. <https://doi.org/10.4230/LIPIcs.ITP.2023.8>
- Michael A. Nielsen and Isaac L. Chuang. 2010. *Quantum Computation and Quantum Information: 10th Anniversary Edition*. Cambridge University Press, Cambridge. <https://doi.org/10.1017/CBO9780511976667>
- Jennifer Paykin, Robert Rand, and Steve Zdancewic. 2017. QWIRE: A Core Language for Quantum Circuits. In *Proceedings of the 44th ACM SIGPLAN Symposium on Principles of Programming Languages (POPL '17)*. Association for Computing Machinery, New York, NY, USA, 846–858. <https://doi.org/10.1145/3009837.3009894>
- Yuxiang Peng, Kesha Hietala, Runzhou Tao, Liyi Li, Robert Rand, Michael Hicks, and Xiaodi Wu. 2023. A formally certified end-to-end implementation of Shor’s factorization algorithm. *Proceedings of the National Academy of Sciences* 120, 21 (2023), e2218775120.
- Qiskit contributors. 2023. Qiskit: An Open-source Framework for Quantum Computing. <https://doi.org/10.5281/zenodo.2573505>
- Robert Rand, Jennifer Paykin, and Steve Zdancewic. 2018a. Phantom Types for Quantum Programs. <https://popl18.sigplan.org/event/coqpl-2018-phantom-types-for-quantum-programs> Talk at The Fourth International Workshop on Coq for Programming Languages (CoqPL ’18).
- Robert Rand, Jennifer Paykin, and Steve Zdancewic. 2018b. QWIRE Practice: Formal Verification of Quantum Circuits in Coq. In *Proceedings of the 14th International Conference on Quantum Physics and Logic (QPL, Nijmegen, the Netherlands, July 3–7, 2017) (Electronic Proceedings in Theoretical Computer Science, Vol. 266)*, Bob Coecke and Aleks Kissinger (Eds.). Open Publishing Association, Waterloo, NSW, Australia, 119–132. <https://doi.org/10.4204/EPTCS.266.8>
- Talia Ringer, Karl Palmskog, Ilya Sergey, Milos Gligoric, and Zachary Tatlock. 2020. QED at Large: A Survey of Engineering of Formally Verified Software. *CoRR abs/2003.06458* (2020). arXiv:2003.06458 <https://arxiv.org/abs/2003.06458>
- P. Selinger. 2010. A Survey of Graphical Languages for Monoidal Categories. In *New Structures for Physics*. Springer Berlin Heidelberg, 289–355. [https://doi.org/10.1007/978-3-642-12821-9\\_4](https://doi.org/10.1007/978-3-642-12821-9_4)
- Matthieu Sozeau. 2023. Generalized rewriting. <https://github.com/coq/coq/blob/58ac2d8dd403fa7a96429cf1f839225d83be9566/doc/sphinx/addendum/generalized-rewriting.rst>
- Ross Tate, Michael Stepp, Zachary Tatlock, and Sorin Lerner. 2009. Equality saturation: a new approach to optimization. *SIGPLAN Not.* 44, 1 (jan 2009), 264–276. <https://doi.org/10.1145/1594834.1480915>
- John van de Wetering. 2020. ZX-calculus for the working quantum computer scientist. arXiv:2012.13966 [quant-ph]
- Max Willsey, Chandrakana Nandi, Yisu Remy Wang, Oliver Flatt, Zachary Tatlock, and Pavel Panchekha. 2021. Egg: Fast and extensible equality saturation. *Proceedings of the ACM on Programming Languages* 5, POPL (2021), 1–29.
- Yihong Zhang, Yisu Remy Wang, Oliver Flatt, David Cao, Philip Zucker, Eli Rosenthal, Zachary Tatlock, and Max Willsey. 2023. Better Together: Unifying Datalog and Equality Saturation. arXiv:2304.04332 [cs.PL]
- Li Zhou, Gilles Barthe, Pierre-Yves Strub, Junyi Liu, and Mingsheng Ying. 2023. CoqQ: Foundational Verification of Quantum Programs. *Proceedings of the ACM on Programming Languages* 7, POPL, Article 29 (January 2023), 29 pages. <https://doi.org/10.1145/3571222> arXiv:2207.11350

**A THE COMPLETE EQUATIONAL THEORY**

In this appendix, we present a complete set of ZX-calculus rules proven within  $V\gamma ZX$  and rendered using  $ZXViz$ . We do not show all of the rules proven within  $V\gamma ZX$ , but instead a sufficient subset for complete equational reasoning.

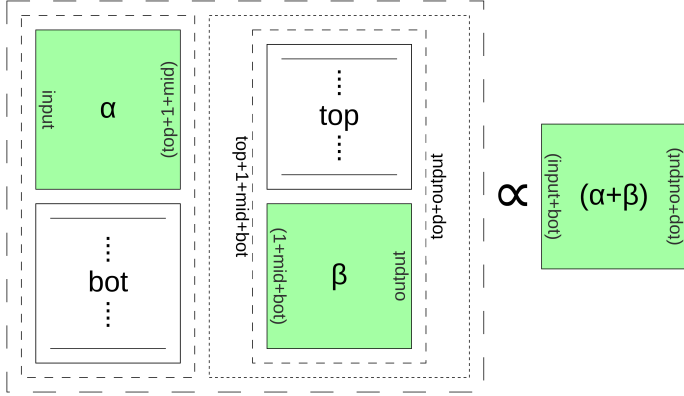

(a) Spider fusion in  $V\gamma ZX$

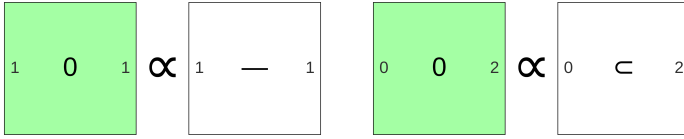

(b) Blank spider removal to wire

(c) Blank spider removal to cup

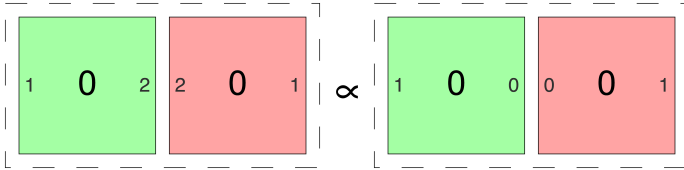

(d) Hopf rule in  $V\gamma ZX$

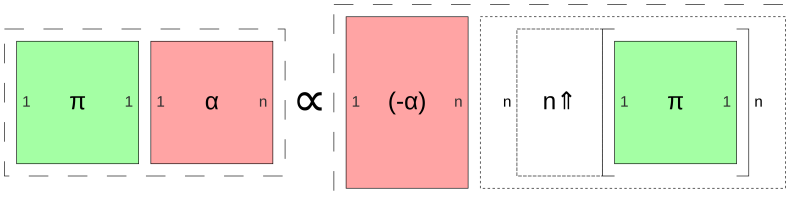

(e) Pi-copy rule in  $V\gamma ZX$

Fig. 26. Directly stateable  $V\gamma ZX$  rules

The primary source for these rules is [Jeandel et al. \[2020\]](#), but the rules are slightly modified with inspiration from [van de Wetering’s](#) survey [2020]. These rules should be compared to [Jeandel et al. \[2020, Figure 2\]](#), where the main differences are:

- (1) VyZX lacks a rule E, as it is a scalar based rule,
- (2) VyZX uses a more general rule, [Figure 26e](#), instead of rule K,
- (3) VyZX uses a more general rule, [Figure 27a](#), instead of rule B1,
- (4) VyZX does not have explicit scalars in its rewrites.

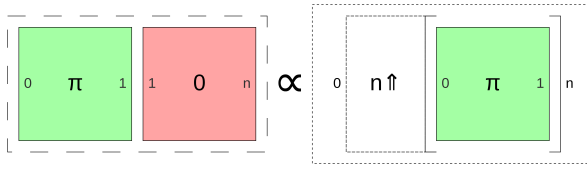

(a) State copy rule in VyZX, also holds for a Z rotation of 0

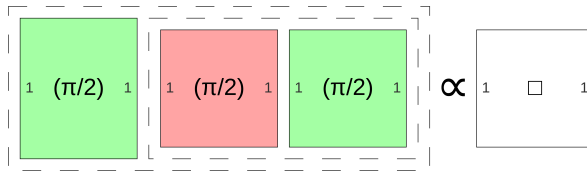

(b) Hadamard decomposition in VyZX

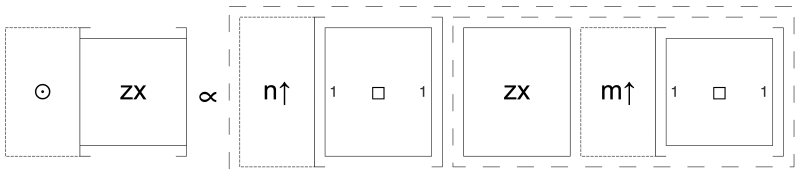

(c) Bi-Hadamard color swapping VyZX, where  $\odot$  represents a “color-swapped” diagram where all red spiders are replaced with green spiders and vice-versa

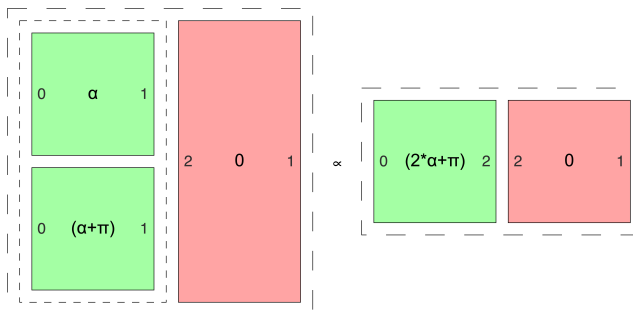

(d) The SUP rule in VyZX

These differences do not impact the universality of the Jeandel et al.'s system as  $VyZX$  contains more general rules.

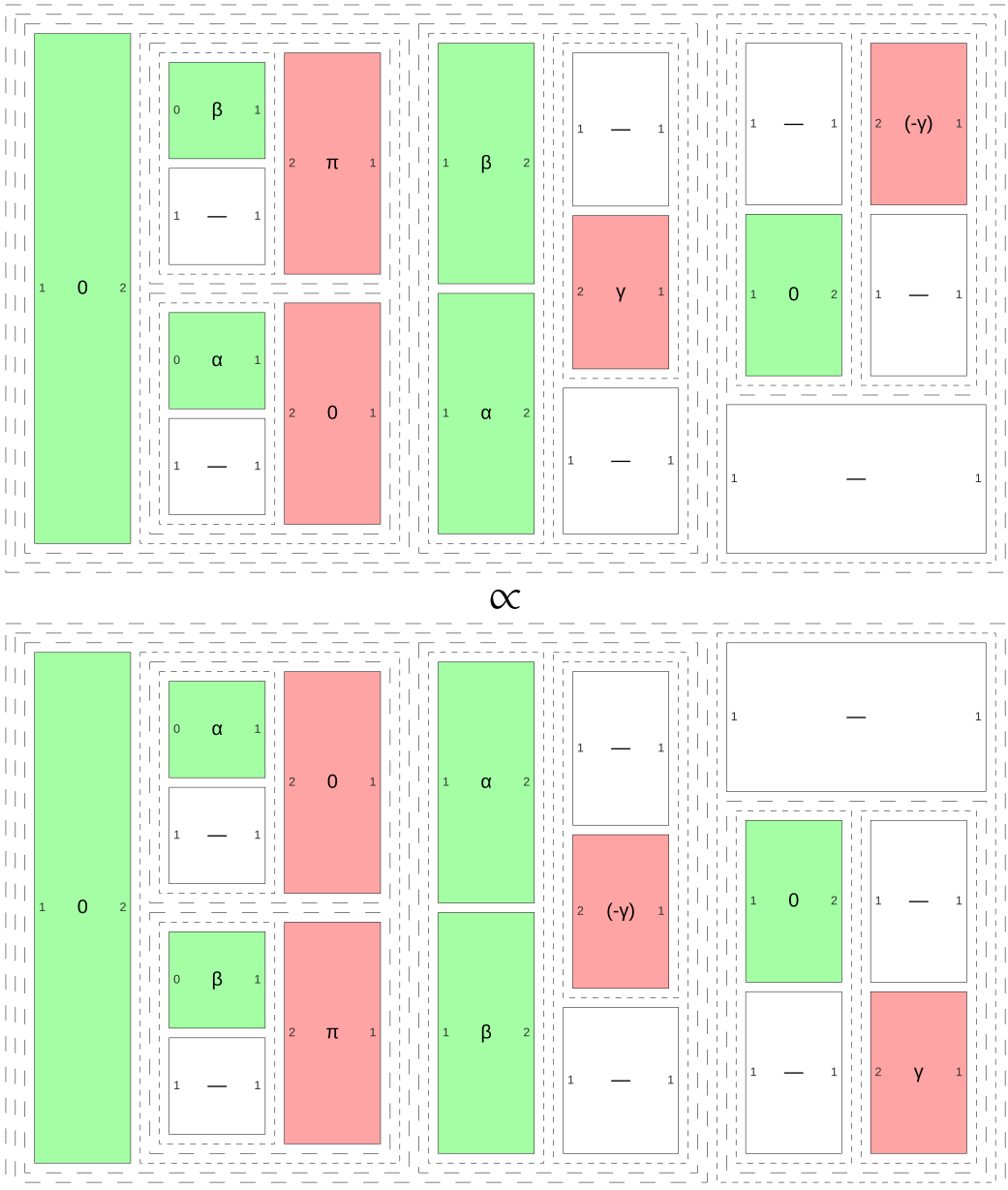

Fig. 28. The C rule in  $VyZX$

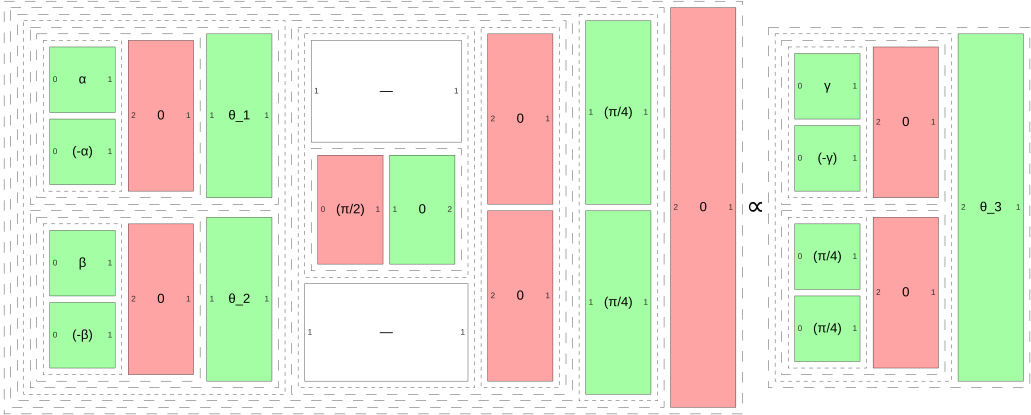
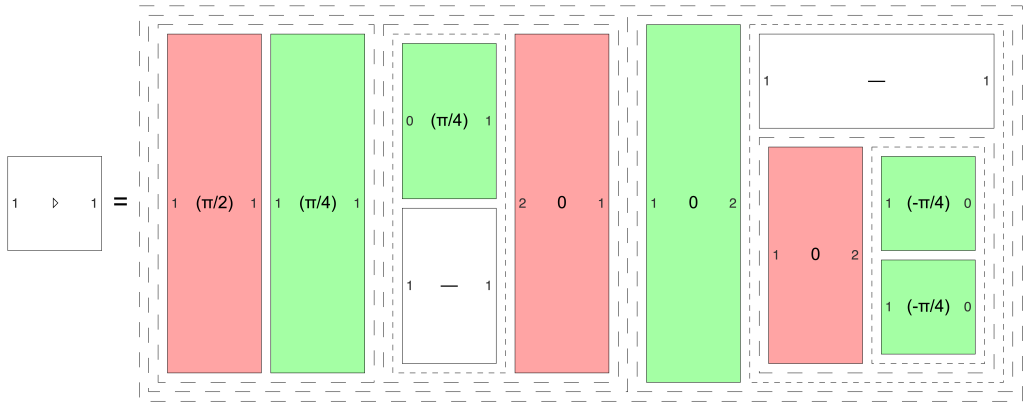
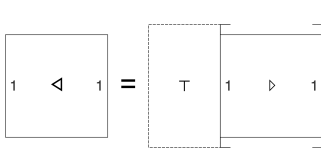

Fig. 29. The N rule in VyZX



(a) Definition of  $\triangleright$



(b) Definition of  $\triangleleft$

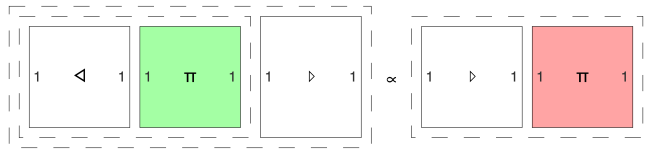

(c) The BW rule

Fig. 30. The BW rule in VyZX