

# A Survey on Quantum Machine Learning: Current Trends, Challenges, Opportunities, and the Road Ahead

Kamila Zaman<sup>1,2</sup>, Alberto Marchisio<sup>1,2</sup>, Muhammad Abdullah Hanif<sup>1,2</sup>, and Muhammad Shafique<sup>1,2</sup>

<sup>1</sup>eBrain Lab, Division of Engineering, New York University Abu Dhabi, PO Box 129188, Abu Dhabi, UAE

<sup>2</sup>Center for Quantum and Topological Systems (CQTS), NYUAD Research Institute, New York University Abu Dhabi, PO Box 129188, Abu Dhabi, UAE

Quantum Computing (QC) claims to improve the efficiency of solving complex problems, compared to classical computing. When QC is applied to Machine Learning (ML) applications, it forms a Quantum Machine Learning (QML) system. After discussing the basic concepts of QC and its advantages over classical computing, this paper reviews the key aspects of QML in a comprehensive manner. We discuss different QML algorithms and their domain applicability, quantum datasets, hardware technologies, software tools, simulators, and applications. In this survey, we provide valuable information and resources for readers to jumpstart into the current state-of-the-art techniques in the QML field.

## 1 Introduction

Machine Learning (ML) systems are established tools to find patterns in data and successfully generalize complex/nonlinear problems. They can be applied to several domains such as computer vision, health care, finance, and automotive [1, 2, 3, 4]. However, ML practitioners have to be wary of the computing resources required to run large ML models. Despite employing numerous hardware-aware optimizations such as compression and approximations [5, 6, 7, 8, 9], the current

computing infrastructures and technologies limit the computation capability of the given ML system.

The high computational requirements demand advanced hardware development. Hence, increasing the number of transistors on a chip to maximize the physical capacity has been the most obvious solution used in the last few years. Moore's law states that the number of transistors doubles every two years on an Integrated Circuit. This doubling pattern is now at full capacity with high-end CPUs and GPUs [10]. Such physical saturation limits the computation power and causes processing, developmental, and discovery delays in the ML community. For instance, training Large Language Models with hundreds of billions of parameters with trillions of tokens is extremely long and compute-intensive [11]. It requires massive investments in time and hardware resources that only a few high-end companies can afford. Hence, to overcome this physical limit and support further discoveries, there is a dire need to look for new technological avenues of hardware systems that can enhance the computation efficiency for solving a given real-world problem by closely simulating it and comprehending it.

Thus, one of the most promising solutions to this bottleneck seems to be the idea of employing Quantum Computing (QC) as an alternate technology to distribute the demand with new chip designs and offload the server industry into diverse directions. Initially presented by Feynman [32] and explained by Preskill [33, 34], QC systems, by exploiting quantum mechanical phenomena, show promising capabilities to significantly improve performance and information processing as compared to

Kamila Zaman<sup>1,2</sup>: [kz2137@nyu.edu](mailto:kz2137@nyu.edu)

Alberto Marchisio<sup>1,2</sup>: [alberto.marchisio@nyu.edu](mailto:alberto.marchisio@nyu.edu)

Muhammad Abdullah Hanif<sup>1,2</sup>: [mh6117@nyu.edu](mailto:mh6117@nyu.edu)

Muhammad Shafique<sup>1,2</sup>: [muhammad.shafique@nyu.edu](mailto:muhammad.shafique@nyu.edu)

Table 1: Qualitative comparison between our work and related QML surveys.

QML Survey	Year	# Pages	# Refs.	QC Details	QC Advantages	QML Algs.	Datasets/Encoding	HW Techs.	SW Tools	Applications
[12]	2006	12	24	✓	✗	✓	✓	✗	✗	✗
[13]	2014	19	71	✗	✓	✓	✗	✗	✗	✗
[14]	2015	38	97	✗	✗	✓	✓	✗	✗	✓
[15]	2016	17	100	✗	✓	✓	✗	✓	✗	✓
[16]	2017	106	309	✓	✓	✓	✓	✗	✗	✓
[17]	2018	33	187	✓	✓	✓	✗	✗	✗	✓
[18]	2019	15	74	✓	✗	✓	✗	✗	✗	✓
[19]	2019	29	309	✓	✓	✓	✗	✓	✗	✓
[20]	2020	8	71	✓	✗	✓	✗	✗	✗	✗
[21]	2020	6	47	✗	✗	✓	✗	✗	✗	✓
[22]	2020	17	165	✓	✗	✓	✗	✗	✗	✓
[23]	2021	9	75	✗	✓	✓	✓	✗	✗	✗
[24]	2021	4	41	✓	✗	✓	✗	✗	✗	✓
[25]	2021	14	73	✗	✓	✓	✗	✗	✗	✗
[26]	2022	6	21	✗	✗	✓	✗	✗	✗	✗
[27]	2022	17	154	✓	✗	✓	✗	✗	✗	✓
[28]	2022	12	59	✗	✗	✓	✗	✗	✓	✗
[29]	2023	19	116	✗	✗	✓	✓	✓	✓	✓
[30]	2023	49	199	✓	✓	✓	✓	✗	✗	✓
[31]	2023	337	851	✓	✓	✓	✓	✗	✗	✓
Our work	2023	43	165	✓	✓	✓	✓	✓	✓	✓

classical systems. While natural processes cannot be truly encompassed in classical systems, the deployment of quantum mechanical principles on quantum computers should help to understand their nature due to the similar principles they operate on. Moreover, QC holds the potential to solve problems with cost efficiency using optimizations, time-saving, and environmentally-friendly designs.

Merging QC with ML forms the Quantum Machine Learning (QML) paradigm. It represents an excellent opportunity for researchers and industries to make phenomenal discoveries and unravel efficient ways to solve complex real-world problems with significant direction toward practicality and improved performance compared to classical systems. QML opens new avenues for the community to discover, build, and align their designs to different levels of the quantum stack [35].

### 1.1 Scope and Contributions

In this work, we discuss how far this overlap of ML and QC has been explored and what further potential lies ahead. This paper presents a systematic discussion of the current status and a well-sorted outlook of the future perspectives in the QML field. It enables the readers to grasp an adequate understanding of QML with currently available algorithms, frameworks, technologies,

and tools. Compared to prior QML surveys [12, 13, 14, 15, 16, 17, 18, 19, 20, 21, 22, 23, 24, 25, 26, 27, 28, 29, 30, 31], we provide a well-structured collection of information and concepts that summarize the current state of development of QML. Table 1 illustrates the comparison between this work and a list of related QML surveys, considering all the important features and topics covered. From the table, it is clear that each prior survey has at least one missing feature, while this work provides a detailed review covering all the key aspects of QML. **The contributions of this paper are summarized below.**

- We present an overview of quantum computers, the current state of challenges, existing techniques, and efforts leading toward finding viable methods to solve them.
- We review the current state-of-the-art QML algorithms, encoding techniques, datasets, hardware technologies, software tools, and their applications.
- We discuss the open research challenges and future directions.

### 1.2 Outline

This paper is organized into different sections and sub-sections, as depicted in Figure 1.

## Paper Organization

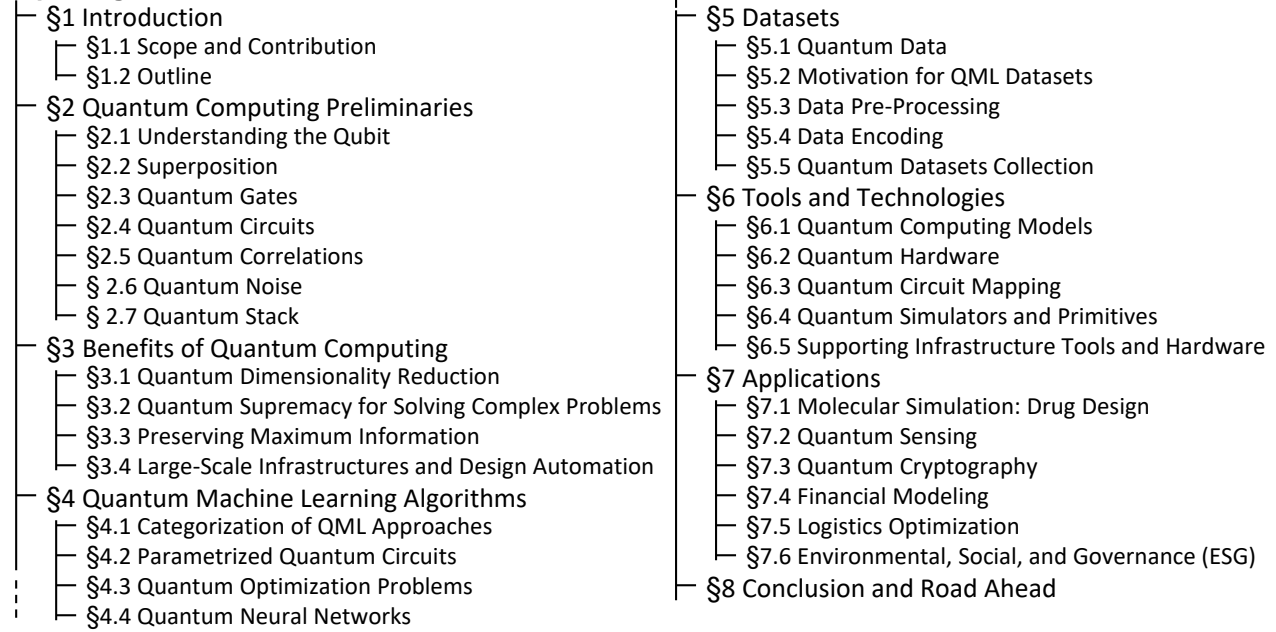

Figure 1: Paper outline.

Section 1 introduces the problem, the scope, and the contributions of this paper. Section 2 presents foundational theoretical concepts of general quantum computers, the challenges of the current technologies, and the state-of-the-art methodologies to overcome these issues. Section 3 provides an overview of the claimed and proven advantages of QC compared to classical computing. This section discusses the motivations that are driving researchers and industries to design QC and QML systems. Section 4 discusses the plethora of the most common QML algorithms that are present in the literature and provides an overview of their applicability. Section 5 provides the necessary information to understand the existing methods for manipulating quantum data in a way that it can be used in the QML workflow, along with a curated list of dataset resources from the QML perspective. Section 6 introduces the existing tools and technologies that are available for QML practitioners to experiment with and investigate further. Section 7 presents the current and potential applications of QML that majorly highlight their benefits over classical computing. Section 8 concludes the paper and provides future outlooks in the QML field.

## 2 Quantum Computing Preliminaries

This section provides an overview of the fundamental concepts in the field of quantum systems. It explains the core features and characteristics of QC systems to build a strong conceptual model of quantum computers, with necessary details for readers to understand the rest of the paper.

### 2.1 Understanding the Qubit

The bit forms the fundamental processing unit of a classical computing system. As shown in Figure 2a, it can hold a value of 0 or 1 at one instance of time. On the other hand, a quantum computer's fundamental unit is a *qubit*. The difference lies in what the qubit can represent at an instance of time against a classical bit. As opposed to a bit, the qubit can represent a mixture of the 0 and 1 state values simultaneously (see Figure 2b). The final state is dictated by the probabilistic occurrence of the collective system's states of qubits resulting from the measurement over the superposition of 0's and 1's followed by the final probabilistic distribution over possible state outcomes as solutions to the problem [36].

The Bloch sphere is an intuitive visual representation of a two-level qubit system for a single qubit. As shown in Figure 3, it represents the pure and mixed states of a qubit. The

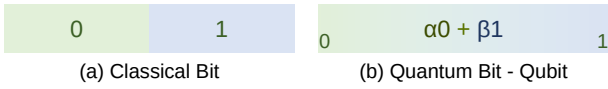

Figure 2: **(a)** Classical bit vs. **(b)** Quantum Bit with  $\alpha$  and  $\beta$  as respective amplitude values of a state-vector, creating a superposition state where  $|\alpha|^2 + |\beta|^2 = 1$  as per the Max-Born Rule.  $|\alpha|^2$  and  $|\beta|^2$  give the respective probability for each state.

pure states are distributed over the surface of the sphere, and all the internal states within the sphere are referred to as mixed-qubit states. It has three axes with their respective basis states on opposite ends.

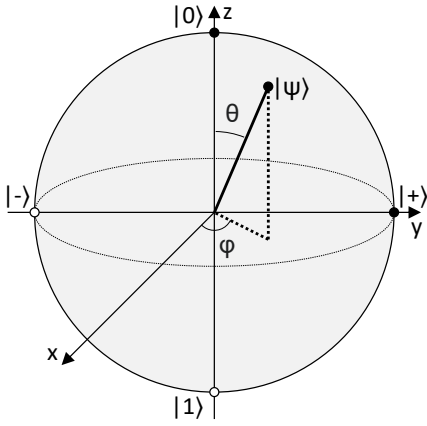

Figure 3: Bloch sphere for a single two-level qubit system.

## 2.2 Superposition

Before delving into the details of the superposition principle, we discuss two fundamental concepts of quantum mechanics, the *Wave-Particle duality* and the *Max-Born rule*.

The Wave-Particle duality theory states that waves can exhibit particle-like properties while particles can exhibit wave-like properties. This definition opposes classical mechanics or Newtonian Physics [37].

In its simplest form, the Max-Born rule states that the probability density of finding a system in a given state is proportional to the square of the amplitude of the system's wave function measured at that state, usually comprised within a state-vector representation. It is intertwined with the *measurement* process of qubits [38].

The superposition concept states that a quantum system can exist in multiple states

simultaneously until it is measured. The space of the solutions is defined as the *Hilbert space*. A common physical interpretation of the superposition principle is represented by the spin of a particle, which can assume two different spin directions (up or down) or any spin position in between those two. Additionally, energy levels of free electrons of an atom are also a common physical interpretation for a qubit capable of superposition where one level corresponds to the ground state (0) and the other one to the excited state (1) with additional possible states in between.

### 2.2.1 Single Qubit Superposition

As illustrated in Figure 4, the state of the qubit is composed of a mixed presence of state 0 and state 1, i.e., there is a superposition. This presence is dictated quantitatively by the amplitude value in context to the wave function driven by the underlying quantum mechanics of the system. Using the Max-Born rule, we sum the squared norm of all amplitudes of the superposition states, which in our example are  $\alpha$  and  $\beta$ . Converting the states into probabilities makes the system more intuitive and interpretable.

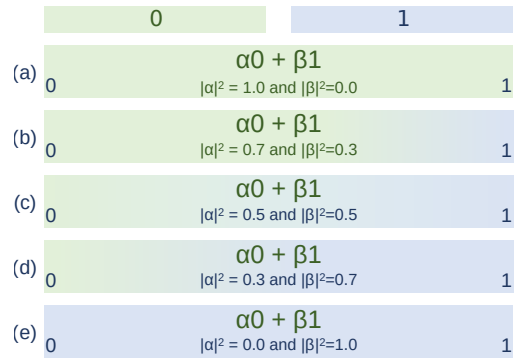

Figure 4: A few examples for single qubit Superposition cases. **(a)** Fully measured to be state 0. **(b)** 70% probability to be measured in state 0 and 30% for state 1. **(c)** Equal probability to be measured in state 0 and state 1. **(d)** 30% probability to be measured in state 0 and 70% for state 1. **(e)** Fully measured to be in state 1.

*Quantum physics uses state-vectors to describe the state of the system.* Figure 4 illustrates various superposition states possible for a single qubit system resulting in probabilities. Currently, there are 5 different arbitrarily chosen superposition states shown for a single qubit, where each block is an independent qubit

system with its own corresponding state-vector containing amplitude values  $\alpha$  and  $\beta$ . We can observe that the amplitudes of  $\alpha$  and  $\beta$  can hold any value from the complex number space defining the quantum mechanical system. However, for practical use of holding and processing information, some rules apply to the amplitude values in the state-vector. According to the Max-Born rule, all amplitude values in the state-vector are such that the sum of their squared norm is always equal to 1. In other words, we observe from the Max-Born rule that amplitudes and probabilities are related to each other. To use the probabilities, we should satisfy the property that their sum is equal to 1. To meet these conditions, the amplitude values of the state-vector must be normalized.

### 2.2.2 Two-Qubit Superposition

Let us now take one step forward and visualize the superposition samples for a two-qubit system. In Figure 5 and Figure 6, all the principles involved in the system are the same as those applied in a single qubit. Still, now the quantum system can exist in 4 (in general,  $2^n$  for an n-qubit system) superpositioned states with 2 qubits at once in the system with respective amplitudes for each state. Each figure shows one independent quantum system with various examples of superpositions to elaborate the idea. Equation (1) also illustrates that every state has a corresponding amplitude value ( $\alpha, \beta, \gamma, \eta$ ), whose squared value corresponds to the probability of that state being the final state.

$$\text{system state} = \alpha(00) + \beta(01) + \gamma(10) + \zeta(11) \quad (1)$$

To understand the basic difference between classical and quantum systems, let us consider an analogy that presents a problem to determine the position (A, B, C, or D equivalent to states 00, 01, 10, and 11) of an object at a given instance. Figure 7 shows an example of how the solution approaches differ for classical and quantum systems. Suppose that every state corresponds to the position of the object. In that case, the classical system determines the object's position by sequentially checking each of the possible states of the solution and validating whether the object is present. It ends up with one single state as the final solution, which in

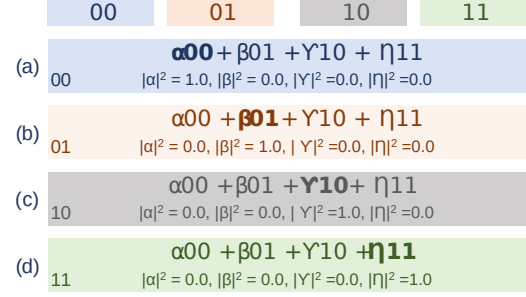

Figure 5: A few examples of two-qubit superposition cases. **(a)** State 00 as final state with 100% probability. **(b)** State 01 as final state with 100% probability. **(c)** State 10 as final state with 100% probability. **(d)** State 11 as final state with 100% probability.



Figure 6: Other examples of two-qubit superposition cases. **(a)** 25% equal probability to be measured in states 00, 01, 10, and 11. **(b)** 50% probability to be measured in state 00 and 50% for state 10. **(c)** 50% probability to be measured in state 01 and 50% for state 11. **(d)** 25% probability to be measured in state 00, 50% for state 01, and 25% for state 10.

the example is position B (state 01), with 100% probability that the object is at that position (state).

On the contrary, a quantum system for the same problem will result in the same solution for identifying the position (state) of the object, but the approach is different. Based on quantum mechanics principles, the quantum system identifies the solution that results in a probabilistic distribution of the possible solutions to the given problem, i.e., in this case, the probabilistic positions of the object's placement. The quantum system's solution is that the object is at position B (state 01). However, it is only 60% confident that it is there and considers other possible outcomes. The mechanisms that quantum systems follow to understand and find

the solution are much closer to the real world than classical systems.

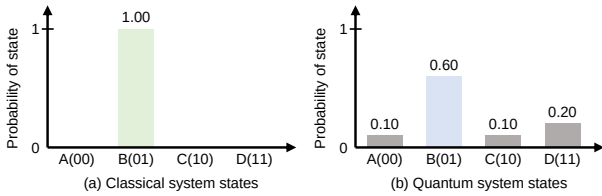

Figure 7: Example of the probability of states at one point in time for (a) a classical system and (b) a quantum system. This example helps to understand the differences between the two systems. We assume that each state shows a particular position where an object can be, i.e., positions A, B, C, or D. Both classical and quantum computers give the same solution. The main difference is that the classical system finds the solution after sequential iterations on each possible state. On the other hand, the quantum system gives a probability distribution of where the object is positioned. Both ultimately convey that the position of the object is B.

### 2.3 Quantum Gates

Quantum logic gates are one of the essential parts of a quantum computer and are the building blocks of all quantum algorithms. These gates are mathematically described by unitary matrices, and their action is always logically reversible. The gates correspond to operators used to manipulate the quantum state of qubits. The only condition on a valid gate (and its corresponding quantum operator) is that it should be unitary. By unitary we mean that it meets the  $U^\dagger = U^{-1}$  condition, where  $U$  is the gate operation matrix and  $U^\dagger$  is the adjoint of  $U$ . This property also ensures that it is a reversible gate operation [39].

### 2.4 Quantum Circuits

A quantum circuit is a collection of quantum gates interconnected by quantum wires. The actual structure of a quantum circuit, the number and the types of gates, as well as the interconnection scheme, are dictated by the unitary transformation,  $U$ , executed by the circuit [40]. A circuit is an independent module composed of gates, wires, and qubits arranged in a certain way to perform a task. Hence, its functionality is similar to what we refer to as an algorithm. A collection of circuits are

independent functional quantum units using the output of a circuit as the input of another one to form a complete algorithm for the solution of the given problem [41] (see Figure 8).

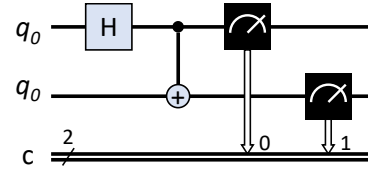

Figure 8: An example of a quantum circuit depicting input qubits, gates, measurement, and output.

## 2.5 Quantum Correlations

*Correlation* is a term derived from statistics. Given a system that consists of two (or more parts), the correlation quantifies how much we can predict about the second part when knowing of the first part, compared to how much we can predict about the second part without that knowledge. Therefore, the correlation in classical mechanics considers statistical systems in a deterministic way. Any observable has only one possible outcome, and the fluctuations around that value may be due to errors or inaccuracies. However, in quantum mechanics, the outcome of an observable does not always have to be the same value [42]. In fact, there exists a set of possible values, playing the role of the eigenvalues of the observable, which becomes a hermitian matrix. Hence, in quantum mechanics, even with no perturbation on the system, we may get varying results with respect to particular eigenvalues over time. Such a system is described by *eigenfunctions* that belong to a Hilbert space.

### 2.5.1 Quantum Entanglement

Quantum entanglement is one of the central concepts in quantum information theory. It is an unconventional and counter-intuitive phenomenon that explains how two particles can be linked to each other even if they are separated by a great distance. Despite their separation, a change induced in one particle will affect the other [43]. Einstein called this phenomenon a “spooky action at a distance” when referring to the non-local forces in a system [44]. The generic mechanism of their interaction is illustrated in Figure 9. While the quantum entanglement has a nondeterministic

behavior, a deterministic control over it can open avenues for new applications in several domains. Quantum development tools (e.g., Qiskit [45], PennyLane [46]) give access to creating and using these entanglement states for real-world problem-solving.

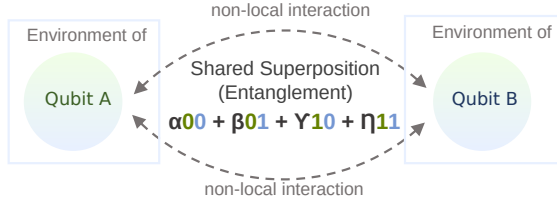

Figure 9: Overview of the mechanism of two-qubit entanglement. The bell states are four specific maximally entangled (shared) quantum states of two qubits. They are in a superposition of 0 and 1.

### 2.5.2 Quantum Decoherence

A quantum system is *coherent* if a definite phase relation exists between different quantum states. This property informs us about how long a qubit can retain its state without being affected by the external environment. It is a desired feature for qubits and allows us to perform computations in a suitable time frame while maintaining the system states over the required time for processing without information loss.

*Quantum decoherence* is a phenomenon that describes the loss of quantum coherence. It is evident when the persistence of a pure coherent state of the quantum system is altered due to the system's interaction with the external environment. The decoherence can be interpreted as a loss of information from the system to the environment or an interference that induces a wave function collapse [47]. This phenomenon constitutes one of the biggest obstacles that prevent the development of quantum computers with stable quantum states at a large scale.

## 2.6 Quantum Noise

Leading from the idea of coherence and decoherence, *quantum noise* makes the implementation of large-scale and reliable quantum computers with low error rates extremely challenging. Therefore, it is imperative to properly characterize the noise

in quantum systems and devise mitigation techniques to detect and correct the errors [48].

### 2.6.1 Uncertainty Principle

To some extent, quantum noise can be characterized using Heisenberg's uncertainty principle. According to Heisenberg's uncertainty principle, it is impossible to accurately know the values of specific related pairs of physical quantities of a particle, such as velocity, position, and momentum [49]. Such an uncertainty phenomenon generates quantum noise in the indeterminate quantum state. Since qubits physically function on quantum mechanical principles, they are susceptible to interference from the external environment and imperfect fabrication.

### 2.6.2 Noisy Intermediate-Scale Quantum Era

The long-term goal for QC is to develop functional quantum algorithms that can solve problems despite the noisy environmental systems they work in. Completely eliminating the noise errors is extremely difficult. Hence, the community has defined a set of achievable intermediate goals to evolve from Noisy Intermediate-Scale Quantum (NISQ)<sup>1</sup> to Fault Tolerant Quantum Computers (FTQC); see Figure 10.

The current state of quantum computing is referred to as the NISQ era [33]. Current quantum processors only support 50-100's of qubits but are not advanced enough to guarantee complete fault tolerance. Despite that, they represent a valid infrastructure for experimenting and improving the designs towards ideal systems. In the NISQ era, near-term hybrid quantum-classical algorithms are designed and applied to various fields, such as quantum chemistry, QML, and combinatorial optimization.

### 2.6.3 Error Correction

Due to the need for algorithms that are capable of handling quantum noise in the NISQ era, several techniques have been proposed for error correction and mitigation. In classical systems, error correction mechanisms are based on redundancy. If the copies do not retain

<sup>1</sup>NISQ is a term coined by John Preskill [33].

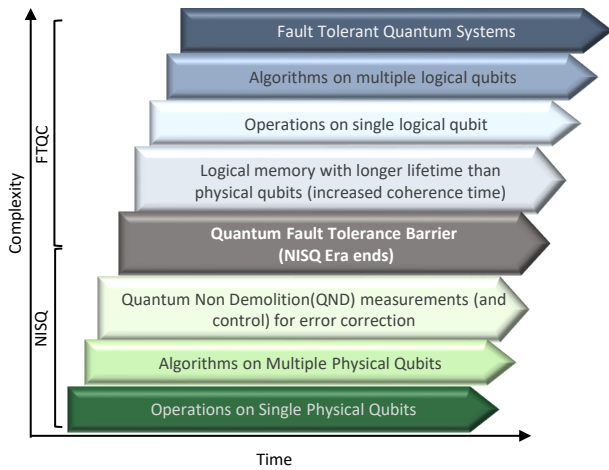

Figure 10: Quantum Information Processing Development Stages highlighting NISQ and FTQC era phases.

the same value, a majority vote determines the correct value. This process works well in systems with a sufficiently low error probability, since it is most likely that only single errors appear.

Similarly, error correction techniques for quantum systems do not correct 100% of the errors but help to reduce the effect of the noise. Unlike classical bits that can only be affected by a flip between 0 and 1, qubits can also experience phase errors, i.e., errors appearing when a qubit state changes its phase. Moreover, quantum errors are continuous since the rotation angle can assume any value.

Due to the no-cloning theorem [50], creating a perfect copy of a quantum state is impossible. Hence, Quantum Error Correction (QEC) codes introduce redundancy by spreading the information of a single qubit onto an entangled state of multiple qubits. With this approach, it is possible to perform multi-qubit (syndrome) measurements to extract the information about the error without altering the quantum information. Typical QEC schemes are the three-qubit bit flip code [51], the three-qubit phase flip code [52] and Shor's nine qubit code [53].

As shown in Figure 11, it is currently not possible to engineer systems with noise rates lower than  $10^{-2}$  or  $10^{-3}$  per gate, but the quantum community is confident that this threshold can be overcome in the next 5-10 years.

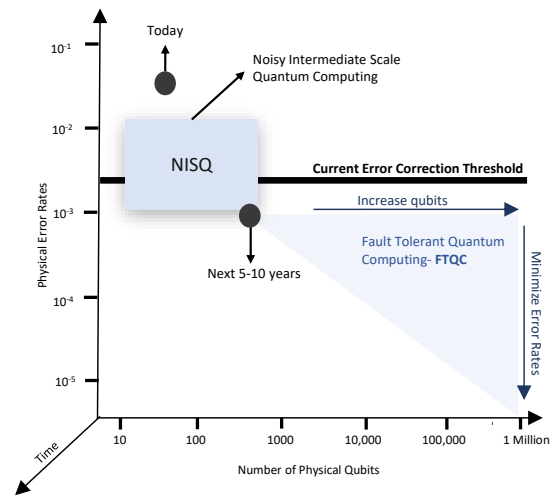

Figure 11: Current state of QEC development. The figure shows the physical error rate threshold per gate that is currently not possible to overcome in the NISQ era.

## 2.6.4 Error Mitigation

Despite sharing the same goal as QEC to reduce the impact of quantum noise, Quantum Error Mitigation (QEM) techniques operate differently. While QEC aims to restore the correct value after the error occurs, QEM aims to reduce or suppress the errors that occur during computation. Moreover, as shown in Figure 12, QEC completely removes the noise, while QEM keeps a small amount of noise under control. A scenario where QEC is applied, called 'hard regime', is theoretically ideal but difficult to realize. The other scenario where QEM is employed, called 'easy regime', is experimentally easier to implement but at the price of lower qubit protection. For QEM deployment, Mitiq [54] is an open-source error mitigation package in Python that implements QEM techniques like zero-noise extrapolation [55] and probabilistic error cancellation [56] for quantum computers.

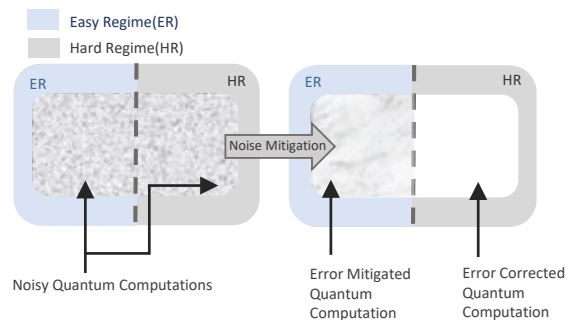

Figure 12: Error correction vs. error mitigation.



The NISQ era is characterized by relatively small-sized quantum circuits. Moreover, quantum noise affects state preparation, gate operations, and measurement. Due to the many qubits and large circuit depth required by QEC codes, it is impossible to implement QEC on NISQ devices. On the other hand, QEM techniques offer low-overhead solutions to implement quantum circuits in an accurate and reliable way [48][52].

### 2.6.5 Fault-Tolerant Quantum Computing

Fault tolerance is a property that enables a system to continue operating not only in normal conditions but also in the presence of hardware or software failures. While there is not often a direct comparison between classical and quantum information processing, the principles of fault tolerance in classical systems are easily transferable.

In a quantum computer, the basic gates are much more vulnerable to noise than classical transistors, since qubits' implementations depend on manipulating single electron spins, photon polarization, or similar fragile subatomic particle systems. Currently, the main challenge for developing efficient and reliable quantum hardware is the ability to maintain qubit states long enough to perform useful computations without requiring redundancy efforts that cause high compute inefficiency and overhead due to the duplication of states. However, it might not be possible to engineer systems with lower error rates. An important ongoing research direction dictates investigating alternative technologies for qubit materials to build quantum systems that achieve reasonable coherence times.

Additionally, the phenomenon of entanglement makes quantum systems inherently fragile. The interactions between qubits during the execution of the quantum circuit lead to errors. If several errors appear in an uncontrolled manner, the QEC or QEM is overwhelmed, and the computation will fail. Therefore, the main goal of FTQC is to control the propagation of faults between processes.

## 2.7 Quantum Stack

Quantum computers operate under a fundamentally different set of rules than classical

computers and can solve certain problems faster by exploiting quantum effects. The development stack in Figure 13 shows an abstraction of the quantum stages formulating a generalized quantum stack. Starting from the Hardware or qubit level, the abstractions go up to the application level composed of Quantum Algorithms. Since QC is at an early development stage, industries primarily focus on the Quantum Hardware level, where the reliability of measurements plays a crucial role in designing and choosing the physical mediums. While simulated quantum hardware can deal with perfect qubits, realistic quantum hardware can be implemented with superconducting qubits, ion trapped qubits, quantum dots, and neutral atom qubits [57].

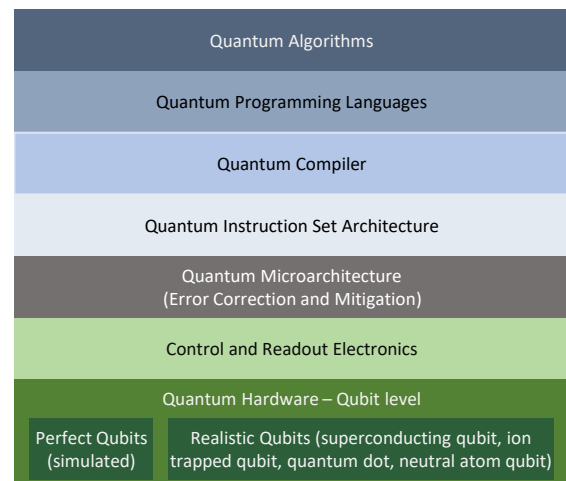

Figure 13: Quantum stack - from Hardware to Applications.

## 3 Benefits of Quantum Computing

This section presents an overview of the benefits of QC over classical systems. It provides the necessary motivations to conduct further research and development of quantum computers.

### 3.1 Quantum Dimensionality Reduction

A common way to reveal properties of an unknown quantum state, having many copies of a system in that state, is to measure different observables and to analyze the results statistically. The unknown quantum state can play an active role in this analysis. Given multiple copies of a quantum system with its

respective density matrix, it is possible to perform the unitary transformation. Its result generates quantum coherence among different copies of the system. Popular techniques for dimensionality reduction are the Principal Component Analysis (PCA) [58], where the eigenvectors corresponding to the unknown state's eigenvalues state are revealed in a very fast manner, and the Quantum Linear Discriminant Analysis Dimensionality Reduction (QLDADR) [59], where the vectors having a high-dimensional feature space are projected onto a low-dimensional feature space.

### 3.2 Quantum Supremacy for Solving Complex Problems

The inherent problems' difficulty, or hardness, is a fundamental concept in computational complexity theory (see Appendix A for more details). The hardness quantifies the resources required by different models of computation to solve problems, such as the number of steps of a deterministic Turing machine [60]. Various models and resources are often considered, including deterministic, nondeterministic, and probabilistic models, time and space constraints, and interactions across different models. "Quantum Supremacy" is a concept that indicates that a programmable quantum device can solve a problem that no classical computer can solve in a feasible amount of time. For instance, Google's Sycamore processor [61] performs in 200 seconds a task that would require 10,000 years using a classical computer. Such an acclaimed advantage of QC compared to classical computers demands a modification of the complexity theory for problems that are solvable on a quantum computer. Hence, the classical complexity classification diagram has been redefined to incorporate the quantum perspective and evaluate the complexity of the issues, considering their ability to be solvable on a quantum computer. Figure 14 shows that a set of problems outside the P space that can be solved in Bounded-error, Quantum, and Polynomial-time (BPQ) [62]. Identifying BPQ problems is crucial to prove the overwhelming ability of quantum computers compared to classical computers.

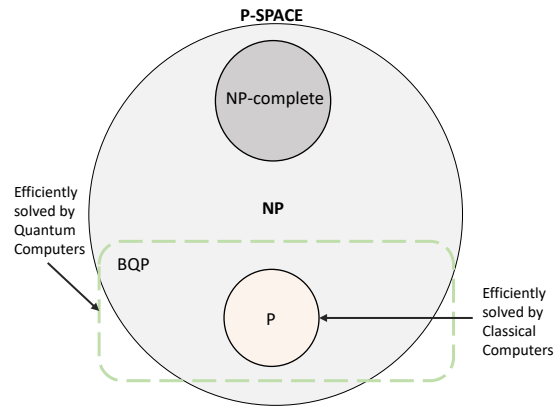

Figure 14: Quantum Computing complexity theory. The classical complexity theory is extended with the class of Bounded-error, Quantum, and Polynomial-time (BPQ) problems.

### 3.3 Preserving Maximum Information

Quantum computers are machines that execute calculations using the characteristics of quantum mechanics. What is occurring at the quantum scale follows the different laws of physics from what is known empirically from classical physics. Due to the superposition phenomenon, a qubit can represent the dual state of 0 and 1 simultaneously, while a classic binary bit can only take either 0 or 1 at a time. Hence, to express n-bit combinations using a classical computer, we need  $2^n$  combinations, which can be checked sequentially before the classical computer can find the solution. On the other hand, a quantum computer takes advantage of its wave nature so that the wave interference increases the probability of the desired state and decreases the other to reach a correct solution effectively all at once.

### 3.4 Large-Scale Infrastructures and Design Automation

Infrastructure is an asset to any economy. Its development and maintenance, despite being difficult, have an enormous contribution to economic development and prosperous future growth. Continuous needs for humanitarian survival and improved quality of life are attracting necessary investments in transportation, civil engineering, and health sectors. Developing systems that provide smooth processing for these domains is challenging, given the burden of data required to process

and handle with the aspects of time criticality, user safety, and reliability. The potential of QC to provide extensive grounds to optimize these processes defines new out-of-the-box ways for infrastructural development that are entirely new and creatively solve the problems at hand in a way that was impossible with classical computers.

The realization of large-scale quantum systems will take several years. However, it is the ultimate target for all significant quantum hardware companies. Their roadmaps aim to have such large-scale systems available for industrial and practical use around the end of the NISQ era. Figure 15 shows the development roadmaps provided by IBM [63] and Honeywell [64] for their current progress and plans towards achieving large-scale quantum infrastructures. These milestones demonstrate the continuous focus on developing quantum chips with more qubits every year, like the 432-qubit Osprey machine by IBM [65]. Similarly, Honeywell’s H-series [66] has stages planned from H1 to H5 as their progress from 10 qubit systems to larger scale qubit quantum systems envisioned to be designed around the year 2030.

## 4 Quantum Machine Learning Algorithms

This section provides an overview of QML algorithms and their domain applicability. ML is a class of advanced algorithms that perform a certain task. Given a large number of inputs and desired outputs, an ML model can be trained to make predictions on unseen data. If it is executed on quantum computers, it becomes a quantum ML algorithm. An overview of the existing QML algorithms is shown in Figure 16.

### 4.1 Categorization of QML Approaches

Before diving into the details of QML algorithms, it is important to characterize different approaches based on the type of data and type of processor used to solve the problem [12]. The four categories (see Figure 17) are formed based on whether the data is classical (C) or quantum (Q) and whether the algorithm runs on a classical (C) or quantum (Q) computer.

- **CC** refers to processing *Classical data using Classical computers*, but using algorithms inspired by quantum computing, such as the recommendation system algorithm.
- **CQ** refers to processing *Classical data using Quantum machine learning algorithms* and will be the main focus of this chapter.
- **QC** refers to processing *Quantum data using Classical machine learning algorithms*. This is an active area of investigation, with classical machine learning algorithms used in many quantum computing areas, such as qubit characterization, control, and readout
- **QQ** refers to processing *Quantum data using Quantum machine learning algorithms*. It is also known as Fully Quantum Machine Learning (FQML). It can be considered a future investigation area that can be developed during a more mature stage of quantum computing.

### 4.2 Parametrized Quantum Circuits

Variational or Parametrized Quantum Circuits (PQCs) are specific types of quantum algorithms that depend on free parameters. PQCs allow us to utilize the existing quantum computers to their full extent. In the context of QML, PQCs are used either to encode the data, where the parameters are determined by the data being encoded, or as a quantum model, where the parameters are determined by an optimization process. PQCs can be interpreted as ML models, considering a variational quantum classifier that uses two variational circuits (see Figure 18). The first circuit associates the gate parameters with fixed data inputs, while the second circuit depends on free and trainable parameters. This setup provides the basic building blocks to build QML algorithms on NISQ devices [67].

A Variational Quantum Algorithm (VQA) combines a classical optimizer with a PQC. VQAs represent a valid solution to enhance the quantum advantage over classical systems, despite using NISQ devices with several constraints, such as the limited number and connectivity of qubits and decoherence errors that limit quantum circuit depth [68].

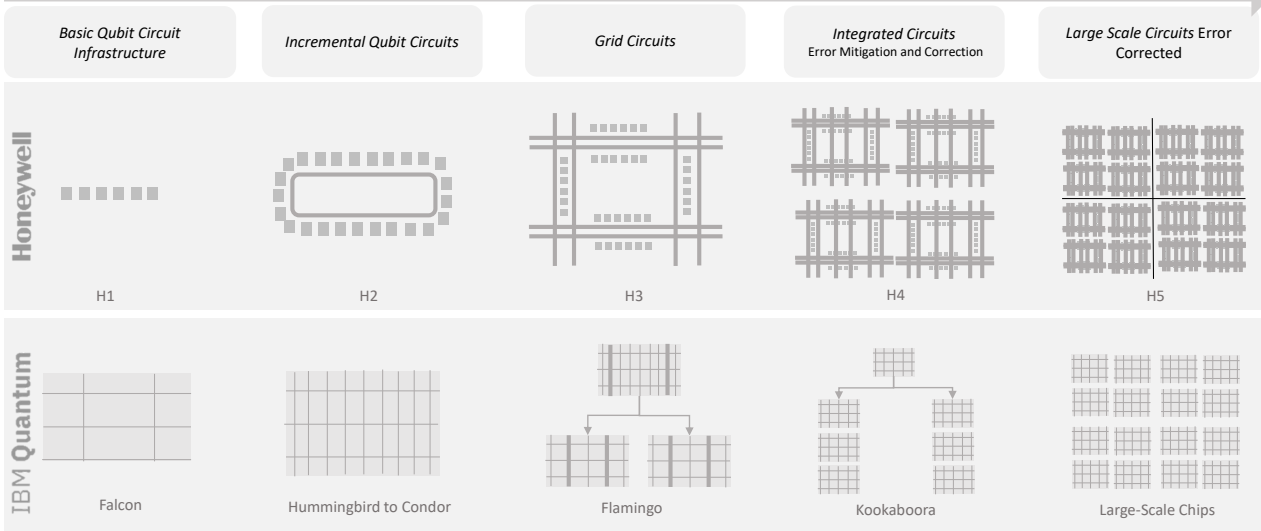

Figure 15: Roadmap to design large-scale quantum chips by Honeywell and IBM.

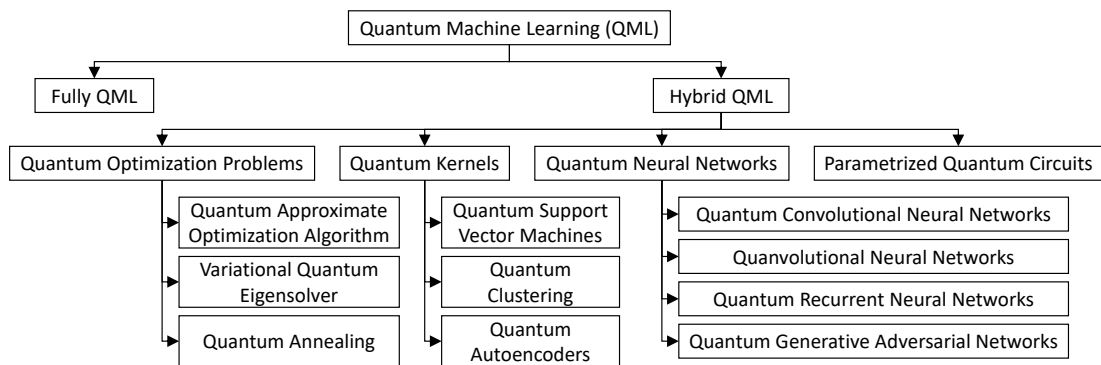

Figure 16: Overview of QML algorithms.

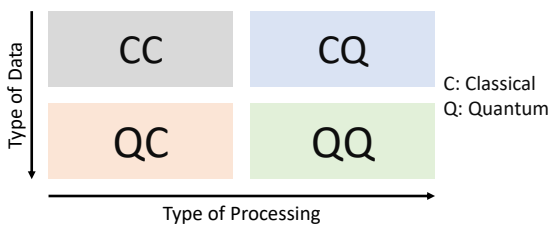

Figure 17: Categories of QML based on types of data and processor.

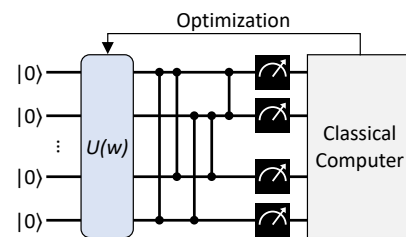

Figure 18: Example of a parametrized quantum circuit.

### 4.3 Quantum Optimization Problems

An optimization problem aims to find the best solution to a given challenge. For instance, the goals of a business are to minimize the production cost or maximize its revenue. The solution can either be discrete if the variable to optimize is determined from a countable set or

continuous if the optimized value is found from a continuous function. It can also be either single-objective or multi-objective. Applying QML to solve optimization problems enables us to employ quantum classification and regression programs on QML infrastructure (see Figure 19). The intrinsic parallelism of quantum computing can speed up the optimization computation to

compute the global minimum (or maximum) faster than classical computing [69].

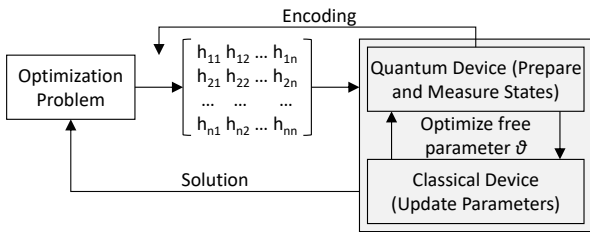

Figure 19: Solving a combinatorial Optimization Problem with hybrid quantum models. Hamiltonians (H) are always square matrices with lengths equal to  $2^n$ , where  $n$  is the number of qubits in the Hamiltonian.

#### 4.3.1 Quantum Approximate Optimization Algorithm

The Quantum Approximate Optimization Algorithm (QAOA) [70] is a technique that finds approximate solutions to combinatorial optimization problems. It is based on PQC that approximate the adiabatic evolution from an initial Hamiltonian. A set of parameters are tweaked to optimize a cost function out of the quantum circuit output. The QAOA method is a promising candidate for achieving quantum advantage over classical systems in the NISQ era.

#### 4.3.2 Variational Quantum Eigensolver

A Variational Quantum Eigensolver (VQE) is a hybrid algorithm that uses both classical computers and quantum computers to find the ground state of a given physical system. The VQE algorithm is versatile and can be applied to a wide range of tasks, making it a promising candidate for use in many applications of quantum computers, including machine learning and control theory [71]. One particularly useful application of the VQE algorithm is finding the ground state energy (i.e., the minimum eigenvalue) of a Hamiltonian. This is accomplished by minimizing a cost function based on the expectation value of the Hamiltonian. An additional term in this algorithm accounts for the overlap between the excited and ground states.

An instance of VQE requires the definition of two algorithmic sub-components, which are a quantum trial state (also called *Ansatz* [72]) and a *classical optimizer*. The optimizer

varies the parameters of the Ansatz, such that it works towards a state, as determined by its parameters, that results in the minimum expectation value being measured by the input operator (Hamiltonian). Additionally, the VQE can be used to model complex wave functions in polynomial time, making it one of the most promising NISQ applications for quantum computing.

#### 4.3.3 Quantum Annealing

The Quantum Annealing (QA) method is an algorithm to solve combinatorial optimization problems. Instead of using the temperature to explore the problem space, the QA uses the laws of quantum mechanics to measure the energy state. Starting from the qubits' dual state, where all the possible combinations of the values are equally likely to happen, the quantum mechanical effects are gradually reduced through a process called quantum fluctuation [73] to reach the most optimal point where the lowest energy state is achieved.

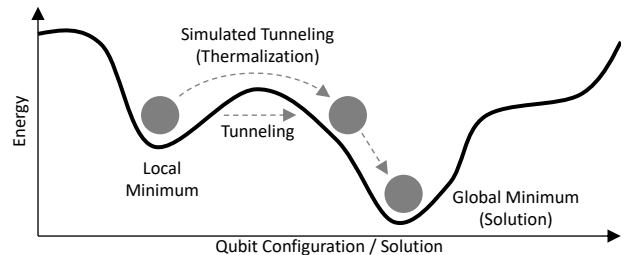

Figure 20: Example of quantum annealing.

QA techniques require an objective function to be defined in the *Ising model* or *Quadratic Unconstrained Binary Optimisation (QUBO)*. The Ising model is a mathematical model in statistical mechanics [74]. The QUBO [75] is mathematically equivalent to the Ising model and can be used to formulate a problem in a more simple way.

In physics, the minimum energy principle [76] states that the internal energy decreases and approaches the minimum values. If we can formulate our problems as an energy minimization problem, the QA method can search for the best possible solution by utilizing quantum methods over an energy landscape.

## 4.4 Quantum Neural Networks

Quantum Neural Networks (QNNs) are computational Artificial Neural Network (ANN) models that are based on the principles of quantum mechanics [77]. As shown in Figure 21, typically in QNNs, the input data is loaded with classical data inputs. The quantum circuit contains a feature map module with input parameters and an Ansatz module with trainable weights. Measurements are conducted to obtain the outputs.

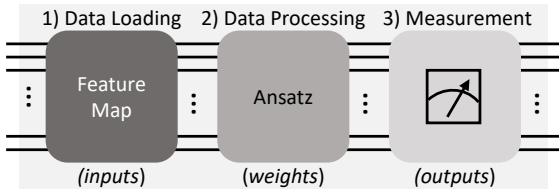

Figure 21: Example of a Quantum Neural Network.

What makes QNNs exciting compared to traditional ANNs is the differentiable nature of the quantum circuits. Quantum computers can compute the changes in the control parameters needed to make the QNN better at a given task.

During the NISQ era, the main focus is on Hybrid Quantum Neural Networks (HQNNs). The generic structure of an HQNN is illustrated in Figure 22, while specialized model types are discussed in the following sections.

### 4.4.1 Quantum Convolutional Neural Networks

Convolutional Neural Networks (CNNs) are established architectures for image classification tasks in the computer vision domain [78]. Quantum Convolutional Neural Networks (QCNNs) are HQNN architectures whose structure is inspired by classical CNNs (see Figure 23). The QCNN circuit model proposed by Cong et al. [79] extends fundamental properties of CNNs to the quantum domain by using only  $O(\log(N))$  variational parameters for input sizes of  $N$  qubits. Therefore, it enables efficient training and implementation of QCNNs on realistic, near-term quantum devices.

The structure of a classical CNN consists of applying alternating convolutional layers (with an activation function) and pooling layers, typically followed by fully-connected layers before the output is generated. In QCNNs, the convolution operations are performed as

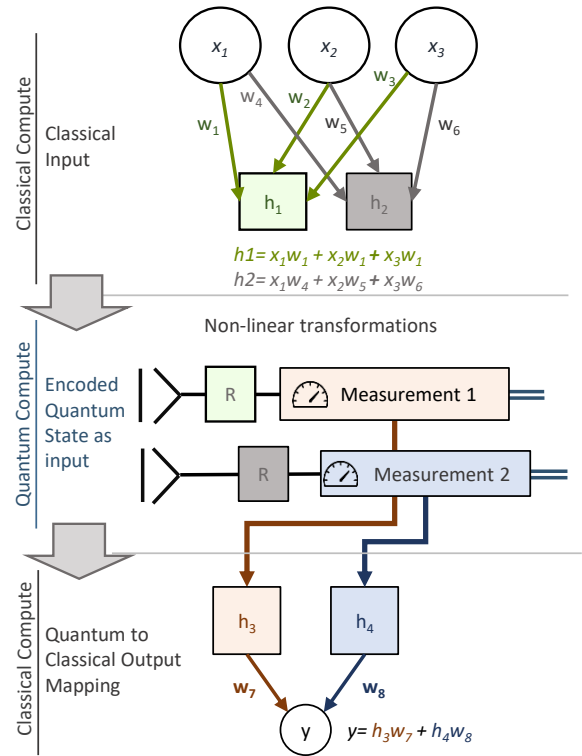

Figure 22: Functionality of a Hybrid Quantum Deep Neural Network. The classical input is converted into the quantum domain by encoding the data as a quantum state. After measurements, a quantum to classical output mapping is required to obtain the final results.

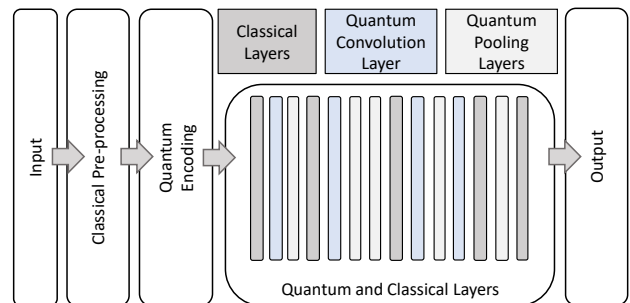

Figure 23: Functionality of a Quantum Convolutional Neural Network.

parameterized unitary rotations based on PQCs, executed on neighboring pairs of qubits. These convolutions are followed by pooling layers. The scope of pooling layers is to down-sample the results of the previous layer by reducing the data dimensions while inherently extracting the most relevant features. The dimensionality reduction with pooling layers reduces the dimensions of the quantum circuits, which in turn reduces the number of qubits in the circuit while retaining the maximum information possible from predecessor layers. Consequently, it reduces the

computational cost of the complete circuit since the number of learnable parameters of the QCNN is equal to the qubits in the circuit. However, in quantum physics, it is not possible to directly remove qubits from the circuit. Hence, the pooling layers in quantum circuits are deployed by measuring a subset of the qubits and using these measurement results to control subsequent operations. The fully-connected layers are implemented as a multi-qubit operation on the remaining qubits before the final measurement. All the parameters involved in these operations are learned during training.

While the classification task is the primary purpose for using QCNNs, they can also devise a quantum error correction scheme optimized for a given error model [79]. However, QCNNs with large circuit depths are challenging to implement due to the high coherence required for qubits.

#### 4.4.2 Quanvolutional Neural Networks

Motivated by the idea of a convolution layer where, instead of processing the entire input data with a global function, a local convolution is applied, Quanvolutional Neural Networks (QuanCNNs) [80] are based on a “quanvolutional” kernel. Compared to QCNNs, where the complete architecture is implemented with PQCs, QuanCNNs focus only on building efficient convolutional layers using quantum circuits (see Figure 24). Considering that the underlying basic principle of convolutional layers is to extract features from data hierarchically, a quanvolutional layer leverages the ability of quantum systems to contextualize greater information capacity. Therefore, QuanCNNs introduce preliminary layers before the classical CNN to manipulate (i.e., pre-process through transformations) the inputs using a single or a set of consecutive quantum layers. The input of the first classical layer is a quantum output measured classically that preserves a large amount of information for improving the contextual feature extraction in the classical layers. In other words, it aims to encapsulate the input information using a representation that results from the quantum space transformations. This approach complements and facilitates the architecture in identifying correlated features in the subsequent (classical) layers.

Considering the current limits of the

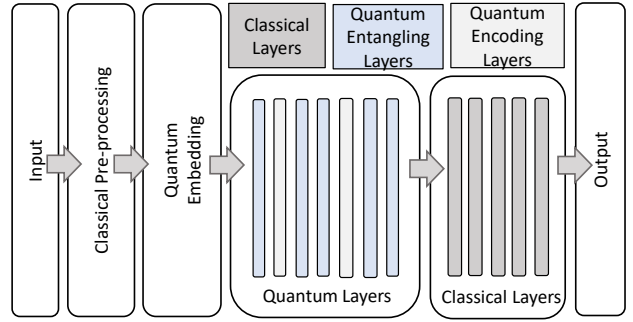

Figure 24: Functionality of a Quanvolutional Neural Network.

quantum hardware, where the quantum circuit implementation of many qubits is challenging, QuanCNNs represent a valid solution for circumventing this obstacle since the deeper layers are still implemented in classical computing. The advantage of quantum computing is that it is used for implementing convolutional layers, where low-qubit circuits are sufficient to perform the required task well.

#### 4.4.3 Quantum Recurrent Neural Networks

Recurrent Neural Networks (RNNs) are the foundational models for using sequential data to solve temporal problems such as natural language processing. Inspired by the structure of a VQE quantum circuit, a Quantum Recurrent Neural Network (QRNN) replaces the RNN layers with PQCs. While VQE circuits are very dense, QRNN cells are highly structured circuits with fewer parameters that are reused. Each parameter has a higher-level logical unit than the VQE components [81]. Applying multiple QRNN cells iteratively on the input sequence generates a QRNN (see Figure 25) that behaves similarly to classical RNNs. However, due to the decoherence issues, the QRNNs’ performance on long sequential data is typically worse than classical RNNs. The coherence constraints can be relaxed if the QRNN architecture is built by stacking the recurrent blocks in a staggered way [82].

#### 4.4.4 Quantum Generative Adversarial Networks

A Generative Adversarial Network (GAN) aims to generate data that resembles the original samples used in the training dataset. This is typically implemented using a generator that

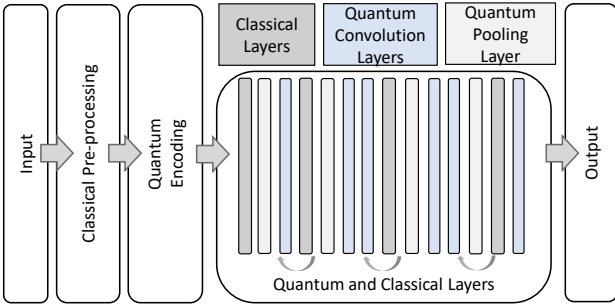

Figure 25: Functionality of a Quantum Recurrent Neural Network.

produces new (fake) data and a discriminator that distinguishes fake from real data. Fully Quantum GANs (QGANs) typically require too large resources that cannot be implemented in near-term quantum devices. To overcome this limitation, it is possible to design hybrid QGANs where either the generator or the discriminator is implemented with classical computing. For example, the QGAN architecture proposed by Huang et al. [83] has a quantum generator and a classical discriminator. The generator is divided into multiple sub-generator blocks, each of them responsible for generating a patch of the full image. As shown in Figure 26, the generated image is formed by concatenating the patches. This approach can be implemented on quantum computers with a limited number of available qubits, where the same device can execute the sub-generator sequentially. This architecture provides guidance for developing advanced QGAN models on near-term quantum devices and opens up an avenue for exploring quantum advantages in various GAN-related tasks.

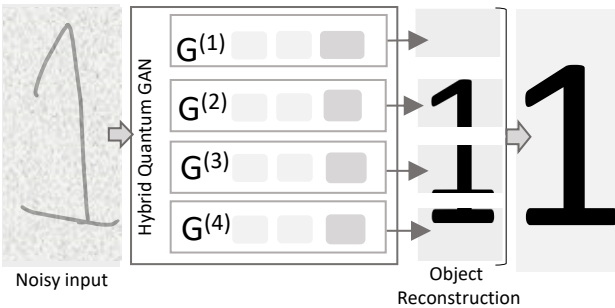

Figure 26: Functionality of a Quantum Generative Adversarial Network, where the quantum generator is split into multiple sub-generators that craft patches of the full image.

#### 4.4.5 Quantum Autoencoders

Autoencoders (AEs) are self-supervised ML models that reduce the size of the input data by reconstructing it. It can compress and encode information from the input using representation learning. Quantum counterparts of AEs, called Quantum Autoencoders (QAEs) [84], aim to reduce the dimensionality of quantum states. As shown in Figure 27, a QAE is composed of three layers, which are input, bottleneck, and output. Its primary use is for digital compression, where the information can be encoded into a smaller amount of qubits. QAEs enable the transformation and mapping of large problems into smaller quantum circuit equivalents. Moreover, QAEs are useful for denoising since they extract relevant features from the initial quantum state into encoded data while neglecting the additional noise [48].

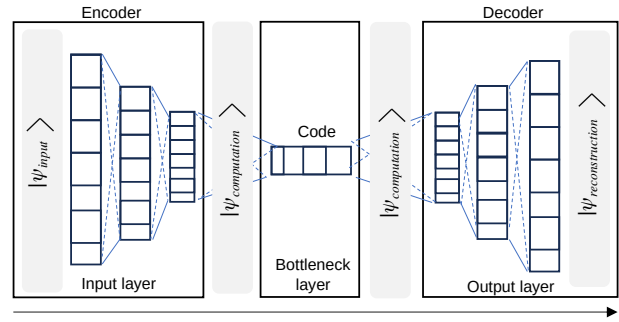

Figure 27: Functionality of a Quantum Autoencoder, where the input state is compressed through the encoder and then decompressed through the decoder.

#### 4.5 Quantum Kernels

Kernel methods are a collection of pattern analysis algorithms that employ kernel functions to operate in a high-dimensional feature space, such as Support Vector Machines (SVMs) and clustering techniques. The main objective of SVMs is to find decision boundaries to group a given set of data points into classes. When these classes' data spaces are not linearly separable, SVMs can benefit from using kernels to find these boundaries.

Similarly to classical kernels, Quantum Kernels (QKs) help to deal with data points in high dimensional feature space. A quantum kernel can be defined as in Equation (2), where  $x$  and  $y$  are  $n$ -dimensional inputs and  $Q(x, y)$  is the kernel



function.  $f$  denotes a function that performs the mapping from an  $n$ -dimensional space into an  $m$ -dimensional space, where  $n < m$ .  $\langle f(x), f(y) \rangle$  denotes the dot product between the functions. This function serves as the foundation for performing clustering and regression algorithms in the quantum domain.

$$Q(x, y) = \langle f(x), f(y) \rangle \quad (2)$$

Constructing QKs for SVMs has been under investigation in recent works. The performance of the resulting quantum SVMs for classification problems with a small number of training points exceeds that of optimized classical models with conventional kernels [85][86]. Moreover, QKs allow us to interpret the learning process with the help of quantum information tools [87].

Quantum clustering is a class of data clustering techniques that use the mathematical and conceptual tools of quantum mechanics. It belongs to a family of density-based clustering algorithms, where clusters are defined by areas of higher-density data points. Its design involves a scale-space probability function viewed at the lowest eigenstate of a Schrödinger equation, followed by simple analytic operations to derive a potential function whose minima determine cluster centers (see Figure 28). The design proposed by Horn et al. [88] was applied to a two-dimensional system but is also scalable to higher dimensions. As demonstrated by Aïmeur et al. [89], quantum clustering for different algorithms (divisive clustering, k-medians, and construction of a neighborhood graph) can obtain significant speedup compared to classical clustering.

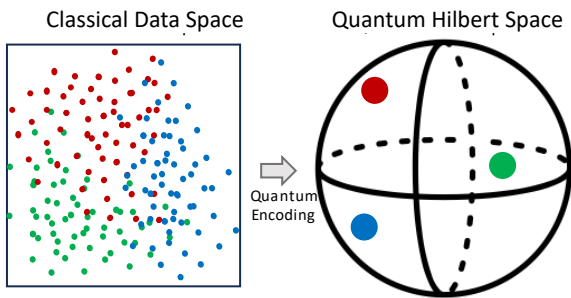

Figure 28: Overview of Quantum Clustering, where the cluster centers are represented in the Hilbert space.

## 5 Datasets

This section provides an overview of the existing methods for generating and manipulating quantum data to be usable for QML tasks. After discussing the data pre-processing methods and the data encoding techniques, we present a list of quantum datasets.

### 5.1 Quantum Data

In quantum mechanics, the fundamental principle is the evolution of energy systems over time, i.e., the Hamiltonian of the systems. In the domain of quantum computing, we deal with varying states of the system for computation and processing. Hence, quantum computing systems must be capable of handling data dictated by these transformations, mechanics, and quantum constraints. *Quantum data* can be referred to as relevant information describing the states and evolution of the quantum system over time. These quantum features represent input and output arguments for various quantum operations and functions that transform the system's quantum state from one form to another. The collection of such data is referred to as *quantum datasets*.

Some examples of quantum data can be:

- Factors affecting the relevant characteristics of a quantum system such as the Hamiltonian and other observables.
- A particular stationary state of the quantum system (e.g., the ground state), from where the process of evolution begins encapsulated in a quantum computation process.
- Unitary transformations, the possible quantum operations applicable to the system.
- Result of computation attained by measurement or additional projection operators which allow extraction of resulting distributions and expectation values of the system.
- Noise-relevant data for the systems' evolution and other phenomena collected via the control parameters.

The data collected for solving real-life problems are currently in classical form. To use quantum models for these solutions, we need to understand and process data in its quantum equivalent form. The possible types of classical data required to create quantum state representations for quantum processing are the following:

- Discrete data (binary or integer values).
- Real continuous data (floating-point values).
- Complex continuous data (complex values).

While fully quantum datasets will drive the FTQC era, the goal in the NISQ era is to understand how to encapsulate the current classical information into a quantum state. In this regard, after understanding the quantum pre-processing, we discuss encoding and embedding techniques for classical data into quantum data. Then, we provide a curated list of quantum datasets along with their properties and application domains.

## 5.2 Motivation for QML Datasets

A valuable lesson from the success of classical ML is that easily accessible and high-quality datasets catalyze the development of new algorithms and the improvement of existing ones. Learning from quantum data is more efficient when executed on quantum computers. Hence, deploying ML algorithms on quantum computers promises efficiency, accuracy, and rich data encapsulation into computing information about real-world systems.

Readily available data drives the efficiency of research quality. High-quality data curated for research and development catalyzes practical and collaborative research across disciplines and fosters insightful growth. Similarly, to experience the full potential of quantum computers to extract information and deeply understand a system through accurate simulations of its real-world counterpart, it is important to have quantum data available to diverse users.

## 5.3 Data Pre-Processing

Individual independent variables operating as inputs to the ML model are referred to as *features*. They can be thought of as representations or

attributes that describe the data. An ML model makes accurate and precise predictions if the algorithm can easily interpret the data's features.

However, applying ML algorithms to noisy data would not give quality results as the system would fail to identify features effectively. Noisy data would introduce factors and patterns in the learned model that are different from the actual distribution of the given problem. Therefore, data pre-processing is important to improve the overall data quality to feed the ML models. The generic data pre-processing pipeline in an ML system includes the steps needed to transform or encode data so that it can be easily parsed by the machine, as shown in Figure 29a. The same principle applies in the quantum domain, but the quantum machines should also interpret the classical data. In this regard, a coherent and structured pre-processing mechanism for QML in the NISQ era is an inevitable need. Despite the generic pre-processing pipeline applicable in any case, Figure 29b illustrates a hybrid pre-processing pipeline for quantum model development. It ensures that the information extraction is maximized using quantum machines and allows quantum computation to apply to any kind of classical data.

Since QML has not yet extensively demonstrated its advantages compared to classical ML, it is more susceptible to adoption by the industry. The current quantum computers have few qubits to test and are noisy, making it difficult to demonstrate the current and potential quantum advantage of QML methods. Utilizing quantum methods for ML in the pre-processing phase, it is possible to achieve better classical encoding and performance of quantum classifiers [90]. Since many proposed QML applications rely on using well-known datasets, especially in the context of quantum data with constraints generated due to the underlying quantum mechanics for representing it as quantum states, it is important to formulate and standardize its collection and encoding processes over time to maintain quality [91].

## 5.4 Data Encoding

Even though the current quantum resources and methodologies provide close estimations and approximations of real-world systems, they

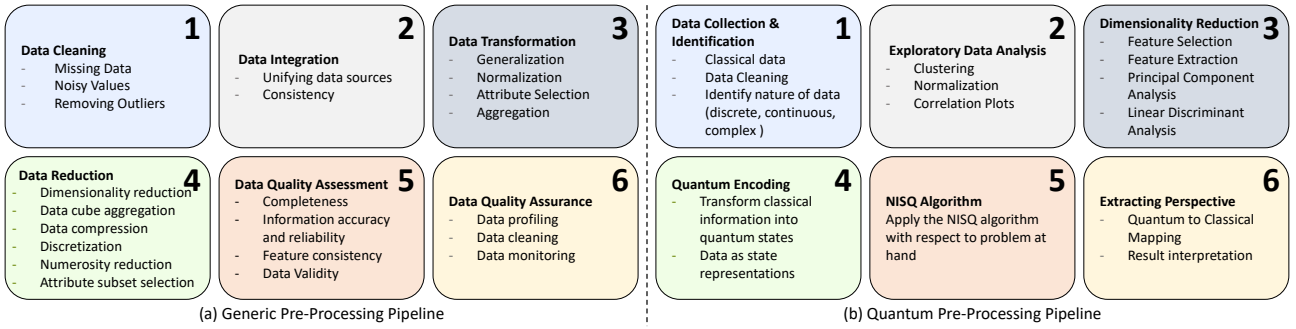

Figure 29: Data pre-processing pipelines. (a) Generic pipeline. (b) Quantum pipeline.

do not always constitute adequate datasets for quantum classification models. The most common approach in the NISQ era is transforming the well-known classical datasets into the corresponding quantum representation and vice versa [91]. The fundamental step in the quantum processing pipeline is referred to as *state preparation*. It allows us to process data on quantum circuits before applying any specific quantum computation. Figure 28 shows an example of how quantum encoding is used to project data from the classical space to the quantum (Hilbert) space.

For tackling the data constraints in QML implementations, data encoding is a fundamental step for representing classical data as quantum states. Encoding layers largely influence the QML model expressivity since the data encoding strategy defines and drives the relevant QML parameters, e.g., the features the QML model can represent [29]. Knowing the various encoding techniques is necessary to choose the most suitable one for solving the particular QML task. Each encoding method has constraints due to the unstable quantum mechanical properties that hinder the complete data encapsulation in quantum representation. However, despite that, they successfully encode the information into quantum states and have large margins of improvement over time [92, 93, 94]. Figure 30 shows a generic overview of the quantum state preparation stage. The process of embedding/encoding generates a quantum representation of the classical data governed by the selected encoding technique within the Hilbert space dimension.

Data encoding patterns describe a particular encoding as a tradeoff between three major objectives:

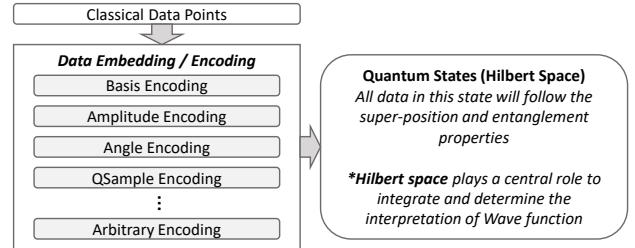

Figure 30: Quantum state preparation model in the data processing pipeline.

- The number of qubits needed for the encoding should be minimal because current quantum devices only support a limited number of qubits.
- The number of parallel operations needed to realize the encoding should be minimal to minimize the width of the quantum circuit. Ideally, the loading routine should have constant or logarithmic complexity.
- The data must be represented appropriately for further calculations, e.g., arithmetic operations.

The following list contains the encoding techniques that are used in the literature. Note that the terms *encoding* and *embedding* can be used interchangeably as they refer to the same process. Figure 31 shows an overview of the data encoding techniques and their key characteristics.

- The **Basis Embedding** encodes the binary feature vector into a basis state. It is primarily used when real numbers are mathematically manipulated in quantum algorithms. Such an encoding represents real numbers as binary numbers and transforms them into quantum states. However, since the binary features are not differentiable,

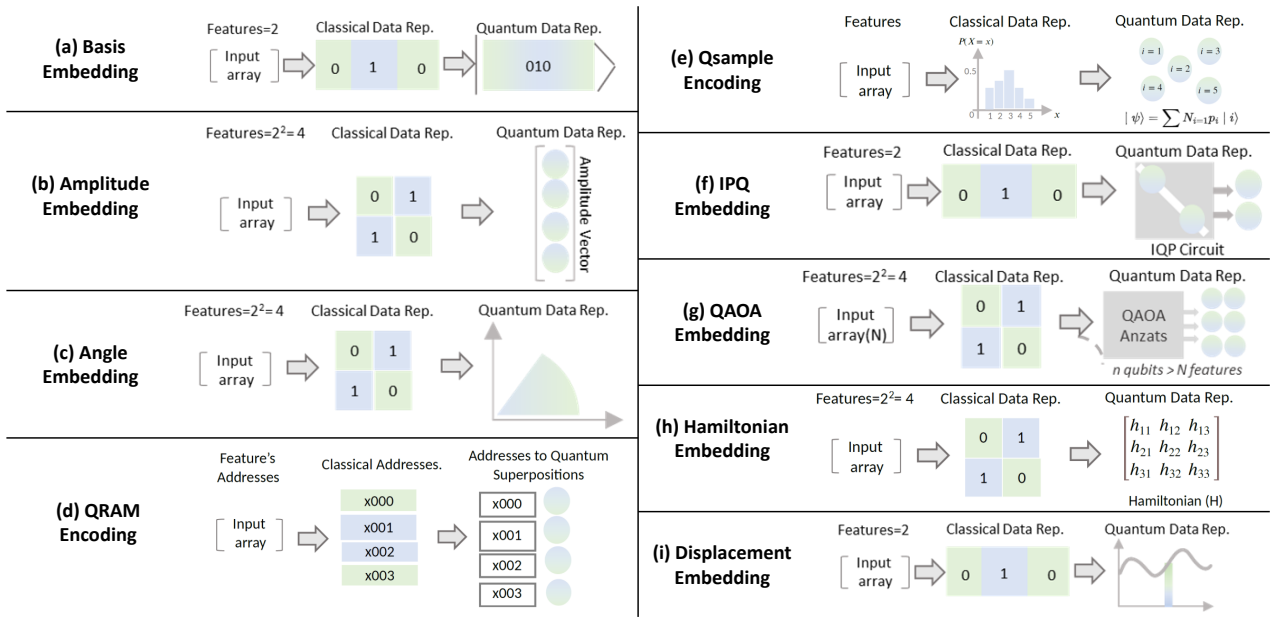

Figure 31: Overview of quantum data encoding techniques. **(a)** Basis Embedding. **(b)** Amplitude Embedding. **(c)** Angle Embedding. **(d)** Quantum Random Access Memory (QRAM) Encoding. **(e)** Qsample Encoding. **(f)** Instantaneous Quantum Polynomial-time (IQP) Embedding. **(g)** Quantum Approximate Optimization Algorithm (QAOA) Embedding. **(h)** Hamiltonian Embedding. **(i)** Displacement Embedding.

the basis encoding does not allow gradient computations [95].

- (b) In the **Amplitude Embedding** technique, classical data is encoded into the amplitudes of a quantum state. Besides defining the measurement probabilities, each quantum system's wavefunction can be used to represent its amplitude as a data value. The main advantage of the amplitude embedding is that it can encode  $n$  real values (or  $n$  fixed-point precision approximation of real numbers) using  $\mathcal{O}(\log n)$  qubits, i.e., it has a logarithmic runtime dependency on the dataset size. Due to its efficiency, it is employed in many QML algorithms [95].
- (c) The **Angle Embedding** is performed by applying rotations on the x-axis or y-axis using specialized quantum gates, called Pauli rotation gates, along with the values that must be encoded. If we apply angle embedding on a dataset, the number of rotations is the same as the number of features in the dataset [95].
- (d) The **Quantum Random Access Memory (QRAM) Encoding** [96] is a mechanism that allows accessing classically stored information in superposition by querying

an index register. In other words, it enables direct access to the quantum data given the corresponding classical data value. By introducing a conditional rotation and branch selection procedure, we can feed the QRAM with the classical address of the required quantum data and get the qubit state at the output.

- (e) The **Qsample Encoding** associates a real amplitude vector with a classical discrete probability distribution. It can be considered a hybrid case of Basis and Amplitude Encoding because amplitudes represent the encoded information, but the features are encoded in the qubits [95].
- (f) The **Instantaneous Quantum Polynomial-time (IQP) Embedding** [97] employs the so-called IQP circuit, which is a quantum circuit of a block of Hadamard gates, followed by a set of gates that are diagonal in the computational basis. Each diagonal gate is composed of a single-qubit RZ rotation gate, encoding the  $n$  features, followed by a two-qubit ZZ entangler. The entangler, whose pattern can be customized, encodes the product between features.
- (g) The **Quantum Approximate Optimization**

**Algorithm (QAOA) Embedding** [70] encodes  $n$  features into  $m$  qubits, where  $m > n$ . It uses a layered trainable quantum circuit inspired by the QAOA Ansatz. The feature-encoding circuit associates features with the angles of RX rotations. The main advantage is that it supports gradient computations with respect to both the features and the weights.

- (h) The **Hamiltonian Embedding** scheme encodes features into the values of the Hamiltonian operator matrix [95]. The Hamiltonian operator of a system is a quantum mechanical operator that corresponds to the total energy of the system. Unlike previous methods that encode the data in the qubits’ states, the Hamiltonian embedding method encodes the data into the operator. Since it is highly correlated with physics, various physical QML algorithms, including VQE and QAOA, are developed using the Hamiltonian encoding method.
- (i) The **Displacement Embedding** encodes  $n$  features into the displacement of amplitudes or phases of  $m$  modes, where  $n \leq m$ . It is used in continuous-variable quantum computing models, where classical information is encoded in the displacement operator parameters [29].

## 5.5 Quantum Datasets Collection

Table 2 shows the collection of quantum datasets with key features. The following list provides a brief description of each dataset.

- The **QDataSet** [98], released in 2022, is composed of 52 datasets based on simulations of one-qubit and two-qubit systems evolving in the presence or absence of noise. It provides a large-scale set of datasets for QML practitioners to train, benchmark, and develop classical and quantum algorithms for common tasks in quantum sciences, such as quantum control, quantum tomography, and noise spectroscopy. It has been generated using customized code running on base-level Python packages to facilitate interoperability and portability across

common QML platforms. Each dataset consists of 10,000 samples and includes a range of information (stored in list, matrix, or tensor format) regarding quantum systems and their evolution, such as quantum state vectors, drift and control Hamiltonians, unitaries, Pauli measurement distributions, time series data, pulse sequence data for square and Gaussian pulses, noise and distortion data. The total compressed size of the QDataSet (compressed with Pickle and zip) is around 14 TB, while its uncompressed size is around 100 TB.

- The **QM7, QM8, and QM9** datasets are subsets of the GDB-13 [107] and GDB-17 [108] databases, which contain billions of organic molecules. The QM7 [99] is composed of 7,165 molecules of up to 23 atoms (including 7 heavy atoms such as C, N, O, and S), represented using the Coulomb matrix. An extension of the QM7 dataset for multitask learning, called QM7B [100], has 13 additional properties (e.g., polarizability, HOMO and LUMO eigenvalues, excitation energies) and contains a total of 7,211 molecules. The QMB8 [101] has a training set of 10,000 molecules with up to 8 heavy atoms. The QM9 [102] contains 133,885 molecules with up to 9 heavy atoms. These databases serve as benchmarks for hybrid QML models and systematic identification of structure-property relationships.
- The **PennyLane Datasets** [46] are composed of the *Quantum Chemistry (QChem) Datasets* for common molecular systems and the *Quantum Many-Body Physics (QMBP) Datasets*. The QChem datasets contain the electronic structure data for 42 different geometries of molecules such as linear hydrogen chains, metallic and non-metallic hydrides, and charged species. For each geometry of the molecule, it is possible to extract molecular data (i.e., information regarding the molecule), Hamiltonian data (i.e., Hamiltonian for the molecular system), tapering data (i.e., features based on Z2 symmetries of the molecular Hamiltonian for performing tapering), tapered observables data, and

Table 2: Quantum datasets with key features.

Dataset	Ref.	Type	Volume/Count	Release Date
QDataSet	[98]	One-qubit and two-qubit systems evolving	14 TB (compressed), 10,000 samples each	Aug.2021
QM7, QM8, QM9	[99], [100] [101], [102]	Organic molecules	Between 7,165 and 133,885 molecules, with 7-9 heavy atoms	2012-2015
PennyLane Datasets	[46]	Organic molecules and spin	42 geometries of 34 molecules, 4 spin models with 100 configurations	Apr.2022
TensorFlow Quantum Data	[103]	Image classification	One-qubit per pixel	Mar.2020
Mendley Datasets for Quantum Circuit Mapping	[104]	Circuit mapping problem as classification task	188,434 random quantum circuits	Sep.2021
QFlow Lite	[105]	Charge state recognition	1,001 - 1,599 measurements, 100 × 100 - 250 × 250 pixel maps	Sep.2018
NTangled Datasets	[106]	Quantum states with multipartite entanglement	12,040 training samples, 4,060 test samples	Nov.2021

variational data. The QMBP datasets contain spin models displaying quantum correlations. For each spin system, datasets are generated for 1-D lattices (linear chain) and 2-D lattices (rectangular grid). Each dataset contains values for 100 different configurations of tunable parameters such as the external magnetic field and coupling constants.

- The **TensorFlow Quantum Data** builds upon classical datasets such as MNIST [109] and Fashion-MNIST [110]. It implements the method proposed by Farhi et al. [103] to use binary encoding for representing each pixel with a qubit, with the state depending on the pixel’s value. According to the experimental results of Huang et al. [111], this method achieves quantum speedup in the fault-tolerant regime compared to the classical system.
- The **Mendley Datasets for Quantum Circuits Mapping** [104] helps to solve the circuit mapping problem as a classification task. Each dataset contains features related to the calibration data of the physical device and others related to the generated quantum circuit for specific IBM quantum machines, such as IBMQ Santiago, IBMQ Athens, and IBMQ 16 Melbourne.
- The **QFlow Lite** dataset [105] contains a Python-based software suite to train neural networks to recognize the state of a device and differentiate between states in experimental data. It consists of 1,001

idealized simulated measurements with gate configurations sampling (stored as 100 × 100 pixel maps) over different realizations of the same type of device. The QFlow Lite represents a reference dataset for researchers to use in their experiments for developing QML approaches and concepts. The expanded dataset, denominated QFlow 2.0, consists of 1,599 idealized simulated measurements stored as 250 × 250 pixel maps. In addition, the QFlow 2.0 dataset includes two sets of noisy simulated measurements, one with a noise level varied around 1.5 times the optimized noise level, and the other with a noise level ranging from 0 to 7 times the optimized noise level.

- The **NTangled Datasets** [106] consist of trained weights for three hardware-efficient Ansatzes), strongly entangling, and convolutional, varying the number of qubits, depths, and types of multipartite entanglement. The states are generated by sending product state inputs into PQCs. The NTangled Datasets are used to benchmark QML models for supervised learning classification tasks.

## 6 Tools and Technologies

This section introduces the tools, simulators, and hardware models that are available for QML practitioners. Since the infrastructure provided by QML industries is rapidly evolving, it is important to keep updated about the new technologies and software.

## 6.1 Quantum Computing Models

The first concept of a quantum computer was introduced in 1982 by Richard Feynman [32]. Since then, a significant amount of research efforts have been conducted that resulted in the development of real quantum computers at our disposal for experiments [112]. Due to their different use cases and architectures, quantum computers can be classified into quantum gate models (or quantum circuits) and quantum annealers.

### 6.1.1 Quantum Gate Model

The gate model involves operations in quantum computation using matrix operators, which are applied to the input qubits. These operators process the information and generate the final output distributions. They are designed with unitary constraints to qualify as valid quantum operators, making them reversible. The reversibility property is necessary for introducing some form of determinism in the quantum computation. A single operator is referred to as a gate in the quantum circuit and can be applied independently or grouped together with other similar quantum operators to perform computation on qubits. A gate can be combined with other gates in varying orientations and series such that they solve certain problems. The collection of gates arranged in configurations respective to the problem being solved along with qubits and measurements is referred to as a circuit (see Section 2.4). Complex problems in the quantum domain can be solved by configuring gates in meaningful ways. The computation done with this quantum model is referred to as the gate model. Since it is easily interpretative and intuitive, it is nowadays the most used quantum computation model.

### 6.1.2 Quantum Annealer

Quantum Annealing (QA) is an adiabatic quantum computation method that finds optimal solutions to problems. It uses quantum tunneling, entanglement, and superposition to find the solution in terms of the system's energy. It usually corresponds to finding the global energy minimum in the quantum energy state plane. Instead of using temperature to explore the problem space, QA uses the laws of

quantum mechanics to measure the energy state. A quantum annealer is relatively more noise-tolerant compared to the gate model. Quantum annealers shine when they are used to search for the best from many possible combinations. Such challenges are called combinatorial optimization problems (see Section 4.3.3).

## 6.2 Quantum Hardware

Single qubits can be implemented using different materials and principles. As shown in Figure 32, companies do not use the same technology for implementing their quantum computers. For example, IBM Quantum uses niobium and aluminum on a silicon base to achieve superconductivity under near absolute zero temperature [65]. IonQ uses trapped ion quantum made of Ytterbium, a rare metal [113]. Another example is Xanadu, which applies photonics (light particles) in the quantum processing unit [114]. Using ion and light has advantages over the superconductivity materials as it works under room temperature. The superconducting qubits are more scalable and are implemented by other companies like Google [61] and D-Wave [115]. It is exciting to see future innovations in this area. In this section, after discussing the set of conditions necessary for designing qubits (denoted as DiVincenzo's criteria), we review the qubit technologies to understand their advantages and disadvantages and the reasons for their adoption in the industry. A detailed view of the quantum hardware technologies is also illustrated in Table 3.

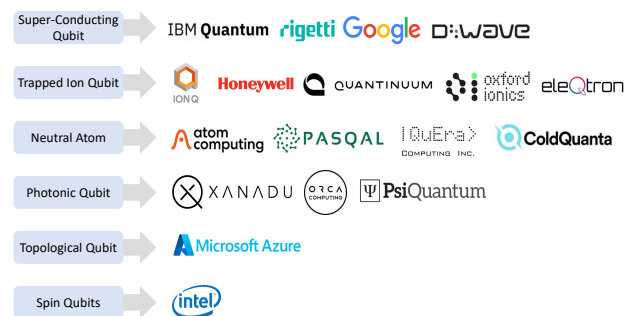

Figure 32: Qubit technologies used by companies for their quantum computers.

### 6.2.1 DiVincenzo's Criteria

Introduced by theoretical physicist David P. DiVincenzo in the year 2000, DiVincenzo's

Table 3: Quantum hardware technologies with key features.

Brand & Technology	Processor	Ref.	Connectivity	# Qubits	Single-Qubit Native Gates	Multi-Qubit Native Gates	Release Date
IBM Superconducting Qubit	Osprey	[65]	All-to-All	433	ID, RZ, SX, X	Echoed cross resonance gate (ECR)	Nov.2022
	Eagle			127			Nov.2021
	Egret	[116]		33		CZ	Apr.2022
	Hummingbird			65		CX	Nov.2020
	Falcon			27			Nov.2019
Canary		5-16		Jan.2017			
IonQ Trapped Ions	Forte	[117]	All-to-All	32	Gpi, GPI2, Virtual Z	Fully Entangling MS, Partially Entangling MS	2022
	Aria	[113]		21			2022
	Harmony	[113]		9			2020
Xanadu Photonic Qubits	Borealis	[114]	3D connectivity	216	NA	NA	Jun.2022
	X-Series	[118]	NA	NA			Mar.2021
Google Superconducting Qubits	Sycamore (Weber QC)	[61]	Square-Lattice Grid	54	Phased XZ, Virtual Z, Physical Z, Pauli Gates XYZ, PhasedXPowGate	Sycamore Gate, Square Root of iSWAP, CZ, FSim Gateset, Wait Gate, Parameterized Gates	Oct.2019
	Bristlecone	[119]	9-qubit linear array	72	NA	NA	Mar.2018
	Foxtail	[120]		NA			2016
Rigetti Superconducting Qubits	Aspen-M-3		Octagonal with 3-fold connectivity (2-fold for edges)	80	RX (angle, qubit) RZ (angle, qubit)	CPHASE, MEASURE (qubit, classical reg), CZ	Dec.2022
	Aspen-M-2			80			Aug.2022
	Aspen-M-1			80			Feb.2022
	Aspen-11			40			Dec.2021
	Aspen-10	[121]		32			Nov.2021
	Aspen-9			32			Feb.2021
	Aspen-8			31			May.2020
	Aspen-7			28			Nov.2019
	Aspen-4			13			Mar.2019
	Aspen-1			16			Nov.2018
	Acorn			19			Dec.2017
Agave		8	Jun.2017				
Intel Spin Qubits	Intel Quantum Hardware	[122]	NA	12	NA	NA	2023
Quantumium (Honeywell) Trapped Ions	H2-1		fully connected qubits	32	Rotation Gates	ZZ	Aug.2023
	H1-3	[123]		20			Jun.2022
	H1-2			12			Jul.2021
	H-1			10			Sep.2020
Atom Computing Neutral Atoms	Phoenix	[124]	8:1 connectivity	100	NA	NA	Jul.2021
QuEra Neutral Atoms	Aquila	[125]	NA	256	Rabi Oscillations Time-dependent protocols Dynamic Decoupling Protocols	Adiabatic State Preparation and Rydberg Blockade Rabi Frequency Enhancement Levin-Pichler gate analogues Non-Equilibrium dynamics of 2 qubits	Jul.2021
D-Wave Systems Superconducting Qubits	Advantage	[115]	Degree-15 Lattice (15 × 15 × 12)	5,000+	superconducting quantum annealing	superconducting quantum annealing	Sep.2022
	2000Q	[126]	Degree-6 Lattice (8 × 8 × 8)	2,000+	Quantum Annealing	Quantum Annealing	Mar.2017

**Legend ID:** Identity. **RZ:** Rotation around Z-axis. **X:** NOT gate. **SX:** Square root of X. **CZ:** Controlled Z-gate. **CX:** Controlled X-gate. **Gpi:**  $\pi$  or bit-flip rotation with an embedded phase. **GPI2:**  $RX\left(\frac{\pi}{2}\right)$  or  $RY\left(\frac{\pi}{2}\right)$  with an embedded phase. **Fully Entangling MS:** XX gate, a simultaneous, entangling  $\frac{\pi}{2}$  rotation on both qubits. **Partially Entangling MS:** a third (optional) arbitrary angle  $\theta$  is added. **FSim Gateset:** provides all three Sycamore, iSWAP, and CZ gates in one set. In addition, by using this combined gate set, it can be parametrized, which allows for efficient sweeps across varying two-qubit gates. **CPHASE:** operation applied with a rotation parameter  $\theta$ . **CZ (Rigetti):** offers single-pulse construction, allowing for lower error rates when full phase control is not needed.

criteria [127] defines a set of conditions necessary for constructing a quantum computer. The community widely accepts it, and, in the current state of the field, it represents a useful tool for designing qubits. The following list contains the fundamental characteristics for designing new qubit modalities in suitable experimental setup.

- Scalability with well-characterized qubits
- Ability to initialize qubits to a simple fiducial state

- Long relevant decoherence times
- A “universal” set of quantum gates
- A qubit-specific measurement capability

While the above criteria are necessary for designing qubits, the following two criteria are the minimum fundamental characteristics required for quantum communication.

- Ability to interconvert stationary and flying qubits



- Ability to faithfully transmit flying qubits between specified locations

## 6.2.2 Superconducting Qubits

Superconducting circuits are macroscopic in size but detain generic quantum properties such as entanglement, quantized energy levels, and superposition of states, all of which are more commonly associated with atoms. Their quantum state is manipulated using electromagnetic pulses to control the electric charge, the magnetic flux, or the phase difference across a Josephson junction [128] (a device with nonlinear inductance and no energy dissipation). As such, superconducting qubits represent the primitive building blocks of quantum computers [129]. There exist multiple types of superconducting qubits, such as flux qubits, phase qubits, charge qubits, and Transmon qubits. The most popular type is the Transmon qubit [130] given its design capability to limit noise effects, supporting error mitigation and correction.

## 6.2.3 Semiconducting Quantum Dots & Spin Qubits

Semiconductor charge and spin qubits based on gate-controlled semiconductor quantum dots, shallow dopants (i.e., traces of an impurity element introduced into a chemical material to alter its original electrical or optical properties), and color centers in wide-bandgap materials. Semiconductor Quantum Dots (QDs) [131] are nanoscale material clusters composed of 10<sup>2</sup>–10<sup>5</sup> atoms. The size of the QDs is orders of magnitude larger than a typical atomic radius, yet small enough to provide quantum confinement of electrons and holes in all three spatial dimensions. Depending on their configuration, they can be controlled by both magnetic and electric fields. Therefore, they can be dephased by electric and magnetic field noise, with different types of spin qubits having various control mechanisms and noise susceptibilities.

In semiconductor quantum dots, spin qubits represent a prominent class of solid-state qubits in the effort to build a quantum computer. The simplest spin qubit is a single electron spin located in a quantum dot. However, many additional varieties have been designed,

some containing multiple spins in multiple quantum dots, each with different benefits and drawbacks. Spin qubits based on solid-state defects have emerged as promising candidates because these qubits can be initialized, selectively controlled, and read with high fidelity at ambient temperatures.

## 6.2.4 Trapped Ions

As the name suggests, the qubits are ions trapped by electric fields and manipulated with lasers [52]. Trapped ions have relatively long coherence times, which implies that the qubits are long-lived. Moreover, they can easily interact with their neighbors.

## 6.2.5 Neutral Atoms

In the neutral atom quantum computing model, light beams manipulate arrays of single neutral atoms to encode and measure quantum states. In these quantum processors, a qubit is defined by one of two electronic states of an atom, and these single neutral atoms are arranged in configurable arrays. Neutral atom hyperfine qubits provide inherent scalability owing to their identical characteristics, long coherence times, and the ability to be trapped in dense, multidimensional arrays [132]. Combined with the strong entangling interactions provided by Rydberg states [133], all the necessary characteristics for quantum computation are met.

## 6.2.6 Photonic Atoms

One way to get scalable structures is to use photons (i.e., light particles) to represent qubits [134]. It consists of a ring that is used for photon storage, along with the scattering unit. Unlike other physical systems, photonics allows us access to an infinite number of states.

## 6.2.7 Transition Metal Dichalcogenides

Among the possibilities in the solid state, a defect in Transition Metal Dichalcogenides (TMDs), known as the nitrogen-vacancy (NV-1) center, stands out for its robustness. Its quantum state may be initialized, manipulated, and measured with high fidelity at room temperature. These controls can be used in conjunction with electronic structure theory to smartly sort

through candidate defect systems for probable qubit representation [135]. However, this technology has not really been popular in the industry until now.

### 6.2.8 Topological Nanowire Qubits (Majorana Qubits)

Majorana particles are a unique class of topological nanowire particles that are their own antiparticles. The quasi-particles emerge from the topological nature of systems and are bound at zero energy. They are predicted to obey non-abelian braiding statistics such that they can “remember” their histories. A *pair* of Majorana fermions represents a single qubit, and its realization could lead the way to fault-tolerant quantum computing [136]. Due to their stability at close to normal temperatures, Majorana Qubits work fine and are the technology chosen by Microsoft [137].

## 6.3 Quantum Circuit Mapping

The process of circuit mapping consists of compiling a quantum circuit to the given device. The circuit is transformed to comply with the architecture’s limited qubit connectivity.

Combining one-qubit rotation gates and two-qubit Controlled-NOT (CNOT) gates can realize any quantum circuit. However, CNOT gates cannot be applied to all pairs of qubits in the currently available NISQ quantum devices. Therefore, the circuit must be transformed into an equivalent circuit that does not violate the limitation of the device. The transformation often requires additional gates that limit the usability of the device [138]. The quality of the circuit mapping can be assessed via different metrics, such as the resulting circuit’s (two-qubit) gate count, depth, or the expected fidelity [139].

Circuit mapping is a fundamental step in the context of QML. The factors affecting the development of QML algorithms directly depend on the design and optimization of circuit mapping. For instance, considering a circuit mapping capability of coupling up to 4 qubits significantly limits the depth and size of QNN layers.

## 6.4 Quantum Simulators and Primitives

*Quantum Simulators* are cloud-based classical systems emulating quantum systems. These are useful in the NISQ era as designers fully control the hardware characteristics that enable experiments of fault-tolerant quantum systems. Ideal quantum systems can be simulated for long-term design and development with no noise in the system. Moreover, noise models can be introduced and analyzed to comprehend the intuitive and counterintuitive behaviors of the quantum systems under noise.

*Quantum Primitives* are foundational building blocks for designing and optimizing quantum workloads. They provide options to customize the iteration and execution of programs to maximize the solution quality. A primitive is a set of key language elements that serve as the foundation for a programming language. Every language supports a core set of primitives that grant the basic building blocks for instructing a processor on executing specific operations.

To be broadly applicable, quantum computers must accurately control and process the information stored in thousands of quantum bits. However, as the number of qubits increases, noise and cross-talk tend to increase the error rate rapidly. In this thrust, it is important to study how the error rates scale with the increased qubit number and system connectivity. To mitigate this, quantum computers can be built in a modular fashion, with adequate infrastructure needed to control them efficiently, and the software compilation of quantum algorithms should be tailored to specific system architectures and error characteristics.

Several software simulators have been released by major companies involved in QML research. While Table 4 summarizes the key features of the simulators, the following list provides key details of these tools.

- **IBM Qiskit** [45] is an open-source software development kit for quantum systems at the level of circuits, pulses, and algorithms. With the help of domain-specific APIs, Qiskit builds a software stack that makes it easy for users to use quantum computers, as it allows practitioners to easily design experiments and applications and run them on classical simulators or real quantum

Table 4: Quantum simulators with key features.

Brand	Simulator Name	Type	# Qubits	Noise Model
IBM	simulator_statevector	Schrödinger wavefunction	32	Yes
	simulator_stabilizer	Clifford	5000	Yes (Clifford only)
	simulator_extended_stabilizer	Extended Clifford	63	No
	simulator_mps	Matrix Product State	100	No
	ibmq_qasm_simulator	General, Context-Aware	32	Yes
	sampler	Qiskit Runtime Primitive (quasi-probability dist. generator)	NA (inherited from backend)	Yes (via <i>options</i> parameter)
	estimator	Qiskit Runtime Primitive (expectation values calculator)	NA	Yes (via <i>options</i> parameter)
Xanadu	default.qubit	Qubit Simulator	up to 26	Yes, non-native
	default.mixed	Qubit Simulator	up to 16	Yes (Native support)
	default.gaussian	Qubit Simulator	NA	Yes, non-native
	lightning.qubit	Quantum Photonic Simulator	up to 26	Yes, non-native
	lightning.gpu	GPU-Accelerated Simulator	up to 29 (+3 with MPI optimization)	Yes, non-native
	lightning.kokkos	Plugin for Kokkos Library	up to 29 (+3 with MPI optimization)	Yes, non-native
	Jet	tensor network contractions (acceleration)	NA	Yes, non-native
Rigetti	Quantum Virtual Machine (QVM)	Emulated Execution	NA	Yes (built-in and custom)
Intel	Intel Quantum Simulator (IQS)	Generic Qubit Simulator	32, 40	NA
Quantinuum (Honeywell)	H2 Emulator	Functional Simulator	32	Yes (via Quantinuum API)
	H1 Emulator	Functional Simulator	20	Yes (via Quantinuum API)
Google	Qsim	Full Wave Function Simulator	40	Yes (via <i>channel</i> in Cirq)

computers. An overview of the main characteristics of Qiskit is illustrated in Figure 33. It comprises the following components:

- *Qiskit Runtime*: It contains computational primitives to perform foundational quantum computing tasks and supports error correction and mitigation techniques.
- *Qiskit Composer*: A graphical quantum programming tool that lets users describe the operations to build quantum circuits and run them on real quantum hardware or simulators.
- *Qiskit Nature*: It supports different applications and provides the necessary components to convert classical codes into representations required by quantum computers.
- *Qiskit Finance*: It provides a set of illustrative applications and tools, including data providers for real or random data, Ising translators for portfolio optimization, and implementations for pricing different financial options or for credit risk analysis.
- *Qiskit Machine Learning*: It provides fundamental QK and QNN building blocks for QML algorithms that apply them to solve different tasks such as regression and classification. Moreover, it connects to PyTorch to enhance classical ML workflows with quantum components.
- *Qiskit Optimization*: It provides a range of optimizations, including high-level modeling of optimization problems, automatic conversion of problems to different required representations, and a suite of easy-to-use quantum optimization algorithms.
- *Qiskit Experiments*: It runs characterization, calibration, and verification steps for the experiments.
- *OpenQASM*: It is a simple text-format

quantum assembly language for describing acyclic quantum circuits composed of single-qubit, controlled single-qubit, multiple-qubit, and controlled multiple-qubit gates. It is used to implement experiments with low-depth quantum circuits. OpenQASM represents universal physical circuits with straight-line code that includes measurement, reset, fast feedback, and gate subroutines. The simple text language can be written by hand or by higher-level tools and may be executed on the IBM Q Experience.

- **Xanadu PennyLane** [46] is the leading tool for programming quantum computers. It is a cross-platform Python library that enables quantum differentiable programming and integration with ML tools to train a quantum computer like you would train a DNN. PennyLane also supports a comprehensive set of features, hardware, simulators, and community-led resources that enable users of all levels to build, optimize, and deploy quantum-classical applications easily. An overview of its main features is depicted in Figure 34.
- **Xanadu Strawberry Fields** [140] is a full-stack Python library for designing quantum algorithms and executing them directly on photonic quantum computers such as Xanadu’s next-generation quantum hardware.
- **Rigetti PyQuil** [141, 142] is a Python library for writing and running quantum programs using Quantum instruction language (Quil) programs. PyQuil allows developers to easily generate Quil programs from quantum gates and classical operations, compile and simulate these programs using the Quil compiler (Quilc) and the Quantum Virtual Machine (QVM), or execute them on a Rigetti quantum processor. Quilc is an optimizing compiler for gate-based quantum programs, capable of performing circuit transformations to produce optimal circuit implementations for a specific Rigetti processor. Such optimizations allow developers to write programs faster while

preserving (or improving) their execution fidelity on a given hardware system. Quil is built and executed using the Forest SDK, a software tool that allows users to write quantum programs in Quil.

- **Quantinuum (Honeywell) TKET** [143] is an advanced software development kit, accessible through the PyTKET Python package, for the creation and execution of programs for gate-based quantum computers. It is platform-inclusive, and its state-of-the-art circuit optimization routines allow users to extract as much power as possible from any of today’s NISQ devices.
- **Google Cirq** [144] is an open-source framework for programming quantum computers, whose software library can be used for writing, manipulating, optimizing, and running quantum circuits on quantum computers and quantum simulators. Cirq provides valuable abstractions for dealing with today’s NISQ computers, where hardware details are vital to achieving state-of-the-art results.
- **Google OpenFermion** [145] is an open-source library for analyzing and compiling quantum algorithms to simulate fermionic systems, including quantum chemistry. The package provides efficient data structures for representing fermionic operators and fermionic circuit primitives for their execution on quantum devices. Plugins to OpenFermion provide users with efficient and low-overhead means of translating electronic structure calculations into quantum circuit calculations.
- **Google TensorFlow Quantum (TFQ)** [146] is a QML library for rapid prototyping hybrid quantum-classical ML models. Research in quantum algorithms and applications can leverage Google’s TFQ, all from within TensorFlow. It integrates quantum computing algorithms and logic designed in Cirq and provides quantum computing primitives compatible with existing TensorFlow APIs, along with high-performance quantum circuit simulators.

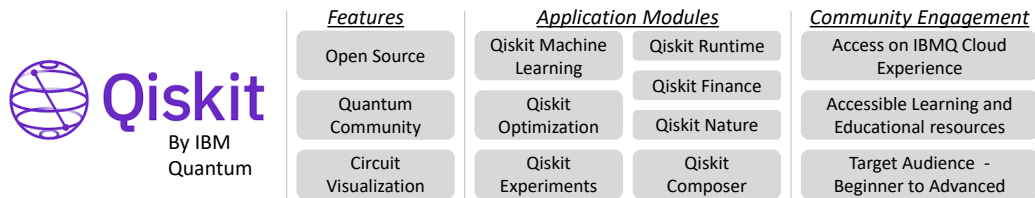

Figure 33: Qiskit features and modules.

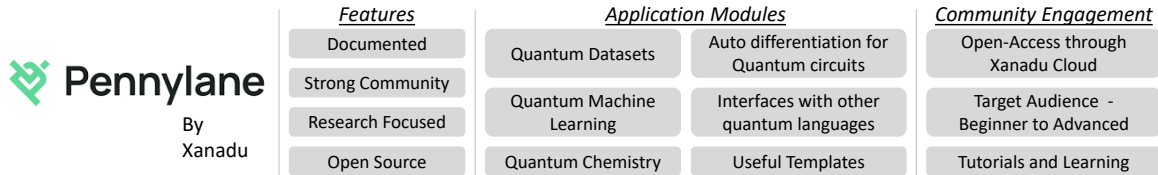

Figure 34: PennyLane features and modules.

- **D-Wave Leap** [147] is a programming model and execution framework to execute quantum and hybrid workloads effectively.

## 6.5 Supporting Infrastructure Tools and Hardware

To help users access quantum resources, several cloud-based platforms and development support infrastructures have been built. The following list describes the most popular resources used in the community.

- **qBraid** [148] is a cloud-based quantum computing platform designed to accelerate the pace of progress in the field. It offers access to the ecosystem of quantum software, hardware, and an entire suite of application-specific quantum algorithms, helping software engineers run programs on quantum computers available from AWS, IBM, Rigetti, IonQ, and QuEra within minutes. qBraid Lab is a web-based IDE interface (through JupiterLab) that provides software tools for developers and access to quantum hardware. It also includes CLI, a Command Line Interface for interacting with all parts of the qBraid platform.
- **IonQ Quantum Cloud** [149] provides access compatible with most Quantum SDKs with their continuous effort to extend the support to newer tools. The cloud provides access to all IonQ’s quantum processors and supports noisy and ideal simulators.
- **Amazon Braket by AWS** [150] is a fully

managed quantum computing service designed to speed up scientific research and software development for quantum computing. Its support is useful for experimenting with quantum computing algorithms, testing different quantum hardware, and building and developing quantum software. It provides access to different quantum computers and simulators using a consistent collection of development tools. Users can build quantum projects on a trusted cloud with affordable pricing and management controls for both quantum and classical workloads. It allows faster execution of hybrid quantum-classical algorithms with priority access to quantum computers and no classical infrastructure to manage.

- **Microsoft Azure Quantum** [151] provides quantum cloud access equipped with open-source development toolkits and environments for most leading quantum technologies with runtime metrics. Microsoft is adopting topological qubits as their qubit modality for developing their quantum computers. Their aim behind using these qubits directly corresponds with the long-term scalability of quantum computers. Since the topological qubits can survive at regular room temperatures, their usage improves the systems’ stability compared to other qubit technologies. The resource estimator tool provided by Azure monitors the quantum system’s runtime statistics. It estimates the resources

allocated by the quantum code and refines the solution to a reasonable extent. This tool calculates the number of logical and physical qubits and runtime requirements to execute quantum applications on future-scaled quantum computers. Additional features, like determining the number of physical qubits required by circuits and evaluating the differences across qubit technologies, facilitate the design of quantum solutions with varying technologies and refining them to scaled versions for FTQC.

- **Zapata Orchestra** [152] is a platform to develop and deploy generative AI applications. It allows rapid prototyping, benchmarking, and executing workflows across quantum and classical computing resources. Their objectives focus on prioritizing use cases that can deliver a near-term financial impact and build customer first-mover capabilities, ultimately leading to solving computationally complex problems.
- **Xanadu Cloud** [153] is an interface that allows the simulation and execution of programs on quantum photonic hardware. Users can develop quantum applications and program quantum computers with PennyLane’s library of tools, demonstrations, tutorials, and community support forums.

## 7 Applications

QC has been pacing itself from theory to practicality over the past decades, with immense efforts and investment attracting its attention now more than ever. Although there are significant hurdles in achieving high computing efficiency, a path is still paved in the direction of robust, reliable, and useful quantum computers. There is great potential in solving QML problems in many application areas that are discussed in this section.

It is not necessarily claimed that these applications are beneficial only when they are fully quantum. On the contrary, investigating it under the quantum physics lens improves some aspects of the problem compared to its basic (classical) version. In the following domains, the

introduction of quantum technology introduces improvements in speed, compatibility, accuracy, or memory that make them suitable to be solved using quantum technologies.

### 7.1 Molecular Simulation: Drug Design

Identifying and developing small molecules and macromolecules that may help cure illnesses and diseases is the primary activity of pharmaceutical companies. Given its focus on molecular formations, the pharma industry is a natural candidate for deploying quantum computing. The molecules (also including those that might be used for drugs) are actually quantum systems, i.e., systems based on quantum physics. Quantum systems can predict and simulate these molecules’ structure, properties, and behavior (or reactivity) more effectively than conventional computing. Exact methods are computationally intractable by standard computers, and often approximate methods are not sufficiently accurate when there are critical interactions on the atomic level, as is the case for many compounds. On the contrary, quantum computers can efficiently simulate the complete system, including interactions on the atomic level. As quantum computers become more powerful, tremendous value will be at stake.

QC’s primary value for pharmaceuticals lies in the R&D phase of drug design. Quantum computers can help drug developers build predictive models to identify which molecules will likely be effective drug candidates. These models can filter out less promising candidates early in the drug development process, saving resources and time [154].

### 7.2 Quantum Sensing

Quantum Sensing is an advanced sensor technology that detects changes in motion and electromagnetic fields by collecting data at the atomic level [155].

GPS, radar, lidar, and other electromagnetic technologies use quantum physics to provide increasingly common tools on city streets. In aircraft and even on basic cell phones, quantum sensing is in the process of shifting from being a highly-prized capability few can afford to being in daily use everywhere. Once it achieves widespread adoption, quantum sensing

is expected to improve capabilities for the following domains dramatically:

- Aircraft, Automobile and Electronics Manufacturers
- Geology and Civil Engineering
- Environmental Management
- Weather Forecasting
- Cosmic wave detection and simulations (gravitational wave sensing)

As witnessed by the increasing number of startups in this field, quantum sensors are finding their way from laboratories to the real world. The atomic length scale of quantum sensors and their coherence properties enable unprecedented spatial resolution and sensitivity. Biomedical applications ranging from brain imaging to single-cell spectroscopy [156] could benefit from these quantum technologies, but evaluating the potential impact of the techniques is not trivial.

Several projects in the field of civil engineering have launched the adoption of quantum sensing technologies. Since quantum sensors allow more precise and accurate measurements, they relieve and facilitate in making the right decisions for critical tasks (e.g., underground detection of sinkholes, which currently are manually done by experts using their personal knowledge with minimum technological support. This causes a massive amount of resources and time wasted due to the lack of accuracy in correctly identifying the areas where to dig holes.

Metrology is another applicable domain for quantum sensing [157]. The current interests in this direction demand compact and susceptible measurement systems. Integrating electronics with quantum sensing technology should be one of the viable areas of interest for NISQ devices.

### 7.3 Quantum Cryptography

This application domain entirely focuses on creating new cryptography schemes that ensure security against attacks and threats by quantum breach technology. As per our current understanding of the capability of Quantum Computers, it is evident that they will soon reach a point where they perform reliable computations. Keeping that in mind, currently

used encryption methods for many critical communication and transaction processes use the Rivest–Shamir–Adleman (RSA) scheme [158]. It is fundamentally based on the keys generated from prime factors of very large numbers. Although any classical computer can find prime numbers of a given small number given the understanding of complexity theory, it has been proved that for large numbers, the complexity of finding its prime numbers becomes difficult to intractable, i.e., solvable only in indefinite time. This particular property of the problem with classical computers made it an obvious choice to use the RSA as an encryption method. Something that would require thousands of years to solve with the available technology would raise no harm. However, the works of Peter Shor [159, 160] showed the capability of quantum computers to obtain solutions to problems that were presumably be indefinitely solved in the classical domain. These claims opened new avenues driven by the need to develop new cryptography methods that make the communication *Quantum Safe* [161, 162]. Instead of completely changing a classical algorithm into quantum, the focus is on adding quantum modules to existing classical cryptography techniques. The advantage of this strategy is that while the existing classical techniques remain intact, applying the quantum methods improves their efficiency and speed [163]. This proved to be a very useful domain of potential applications for QC that builds over the existing schemes and makes them robust and efficient rather than re-inventing the whole process.

### 7.4 Financial Modeling

By enabling more accurate and complex financial data modeling, improving risk management, and optimizing investment portfolios, QC could lead to better decision-making and higher returns for investors. It can also enable financial services organizations to re-engineer operational processes [164]. QC's specific use cases for financial services can be classified into three main categories: targeted predictions, trading optimizations, and risk profiling. Quantum technology computes more efficiently than classical computing when generating probability distributions, mapping data, testing samples, and iterating. These properties align well with the

financial modeling since they can help enhance investment gains, reduce capital requirements, open new investment opportunities, and improve the identification and management of risk and compliance.

### 7.5 Logistics Optimization

Supply chain and logistics professionals have been overloaded over the past several years. An increasing amount of uncertainties, extreme weather conditions, and pandemic-fueled supply and demand changes have exponentially increased logistics complexity. While businesses need supply chain optimizations to account for the complexity of the entire ecosystem, existing optimizations no longer provide the cure to supply chain and logistics challenges. In this regard, QC could provide solutions for persistent supply chain and logistics problems, such as air traffic routing, trade shipment routing, telecom network, quantum internet, and healthcare. Organizations in the transportation and logistics area could be among those to gain the most advantage from quantum computing's groundbreaking capabilities. An organization's path from the initial investigation of QC's impact to actual readiness for implementation can span a few years.

### 7.6 Environmental, Social, and Governance (ESG)

With the current environmental situation, we see the global need to establish and ensure sustainability. Despite that, technological developments are no further uncorrelated to the environment. Hence, while the quantum technology itself should be designed to be environmentally sustainable, it can be a catalyst in enabling sustainable energy solutions at a large infrastructure scale. Quantum technology, apart from reducing the efficiency and execution time, can also introduce and develop methods that complement Environmental, Social, and Governance (ESG) goals. It can drastically reduce energy wastage and fuel costs with its potential in route optimizations and sensing technologies. Moreover, it provides solutions that empower people to leave aside tedious and repetitive tasks and has a huge social impact by fulfilling problems that drastically improve

the quality of life. Therefore, there is great potential to evolve the quantum field from the ESG sustainability perspective.

## 8 Conclusion and Road Ahead

The development of the QC field, particularly QML, opens new avenues for demonstrating the true potential of technological advancements in the above-discussed subfields. Besides its potential to efficiently solve complex tasks, we have to face the realistic perspective of what has been implemented and proven so far and what is the impact of QML. Its development is rapid and substantial, but the limitations due to the size and noise constraints challenge the *scalability* and *reliability* of these systems. The path towards FTQC needs to be followed promptly, aligning with the steps envisioned by the roadmap. To enable groundbreaking advancements in this relatively new and exciting field, it is recommended to think out of the box rather than exclusively adopting the canonical R&D steps. For QML implementations, it is not always necessary to find analogies between classical ML and QML, but rather investigate alternative points of view to redefine metrics and standards from the quantum perspective. The open research directions can be summarized below.

- It is crucial to define QML benchmark suites to provide a standard set of metrics and workloads that enable the systematic design, evaluation, and comparison of different QML algorithms and infrastructures.
- To overcome the scalability challenge, it is important to go beyond the limit of single quantum chips and develop multi-chip devices with efficient interconnection and communication systems.
- For noise suppression, or, in general, to enable the computations in noisy environments, it is crucial to define protocols that characterize the noise correlations between the different qubits in a cost-effective and scalable manner.
- Due to the current resource limitations, it is imperative to design tailored optimizations



that enable the execution of QML workloads on resource-constraint quantum devices.

This survey provides a comprehensive overview of the current state-of-the-art algorithms, datasets, tools, and applications of QML. It represents a reference resource to instruct and motivate passionate readers to learn and join forces in researching and designing innovative methodologies, tools, algorithms, and technologies that facilitate advancements in this emerging field.

## Acknowledgment

This work was supported in part by the NYUAD Center for Quantum and Topological Systems (CQTS), funded by Tamkeen under the NYUAD Research Institute grant CG008.

## References

- [1] Supriya V. Mahadevkar, Bharti Khemani, Shruti Patil, Ketan Kotecha, Deepali Rahul Vora, Ajith Abraham, and Lubna Abdel Kareim Gabralla. A review on machine learning styles in computer vision - techniques and future directions. *IEEE Access*, 10:107293–107329, 2022.
- [2] Qi An, Saifur Rahman, Jingwen Zhou, and James Jin Kang. A comprehensive review on machine learning in healthcare industry: Classification, restrictions, opportunities and challenges. *Sensors*, 23(9):4178, 2023.
- [3] Arti Chandani and Rahul Dubey. Application of machine learning in banking and finance: A bibliometric analysis. *Int. J. Data Anal. Tech. Strateg.*, 14(3), 2022.
- [4] Martin Rabe, Stefan Milz, and Patrick Mäder. Development methodologies for safety critical machine learning applications in the automotive domain: A survey. In *IEEE Conference on Computer Vision and Pattern Recognition Workshops, CVPR Workshops 2021, virtual, June 19-25, 2021*, pages 129–141. Computer Vision Foundation / IEEE, 2021.
- [5] Alberto Marchisio, Muhammad Abdullah Hanif, Maurizio Martina, and Muhammad Shafique. Prunet: Class-blind pruning method for deep neural networks. In *2018 International Joint Conference on Neural Networks, IJCNN 2018, Rio de Janeiro, Brazil, July 8-13, 2018*, pages 1–8. IEEE, 2018.
- [6] Muhammad Abdullah Hanif, Alberto Marchisio, Tabasher Arif, Rehan Hafiz, Semeen Rehman, and Muhammad Shafique. X-dnns: Systematic cross-layer approximations for energy-efficient deep neural networks. *J. Low Power Electron.*, 14(4):520–534, 2018.
- [7] Alberto Marchisio, Muhammad Abdullah Hanif, Faiq Khalid, George Plastiras, Christos Kyrkou, Theocharis Theocharides, and Muhammad Shafique. Deep learning for edge computing: Current trends, cross-layer optimizations, and open research challenges. In *2019 IEEE Computer Society Annual Symposium on VLSI, ISVLSI 2019, Miami, FL, USA, July 15-17, 2019*, pages 553–559. IEEE, 2019.
- [8] Muhammad Abdullah Hanif, Giuseppe Maria Sarda, Alberto Marchisio, Guido Masera, Maurizio Martina, and Muhammad Shafique. Conlocnn: Exploiting correlation and non-uniform quantization for energy-efficient low-precision deep convolutional neural networks. In *International Joint Conference on Neural Networks, IJCNN 2022, Padua, Italy, July 18-23, 2022*, pages 1–8. IEEE, 2022.
- [9] Vasileios Leon, Muhammad Abdullah Hanif, Giorgos Armeniakos, Xun Jiao, Muhammad Shafique, Kiamal Z. Pekmestzi, and Dimitrios Soudris. Approximate computing survey, part I: terminology and software & hardware approximation techniques. *CoRR*, abs/2307.11124, 2023.
- [10] John L. Gustafson. Moore’s law. In David A. Padua, editor, *Encyclopedia of Parallel Computing*, pages 1177–1184. Springer, 2011.
- [11] OpenAI. GPT-4 technical report. *CoRR*, abs/2303.08774, 2023.
- [12] Esma Aïmeur, Gilles Brassard, and Sébastien Gambs. Machine learning in

- a quantum world. In Luc Lamontagne and Mario Marchand, editors, *Advances in Artificial Intelligence, 19th Conference of the Canadian Society for Computational Studies of Intelligence, Canadian AI 2006, Québec City, Québec, Canada, June 7-9, 2006, Proceedings*, volume 4013 of *Lecture Notes in Computer Science*, pages 431–442. Springer, 2006.
- [13] Maria Schuld, Ilya Sinayskiy, and Francesco Petruccione. An introduction to quantum machine learning. *Contemporary Physics*, 56(2):172–185, oct 2014.
- [14] Jeremy Adcock, Euan Allen, Matthew Day, Stefan Frick, Janna Hinchliff, Mack Johnson, Sam Morley-Short, Sam Pallister, Alasdair Price, and Stasja Stanisic. Advances in quantum machine learning, 2015.
- [15] Ashley Montanaro. Quantum algorithms: an overview. *npj Quantum Information*, 2(1), jan 2016.
- [16] Vedran Dunjko and Hans J. Briegel. Machine learning & artificial intelligence in the quantum domain, 2017.
- [17] Carlo Ciliberto, Mark Herbster, Alessandro Davide Ialongo, Massimiliano Pontil, Andrea Rocchetto, Simone Severini, and Leonard Wossnig. Quantum machine learning: a classical perspective. *Proceedings of the Royal Society A: Mathematical, Physical and Engineering Sciences*, 474(2209):20170551, jan 2018.
- [18] Sumit Jeswal and S. Chakraverty. Recent developments and applications in quantum neural network: A review. *Archives of Computational Methods in Engineering*, 26, 05 2018.
- [19] Salonik Resch and Ulya R. Karpuzcu. Quantum computing: An overview across the system stack, 2019.
- [20] Somayeh Bakhtiari Ramezani, Alexander Sommers, Harish Kumar Manchukonda, Shahram Rahimi, and Amin Amirlatifi. Machine learning algorithms in quantum computing: A survey. In *2020 International Joint Conference on Neural Networks, IJCNN 2020, Glasgow, United Kingdom, July 19-24, 2020*, pages 1–8. IEEE, 2020.
- [21] Simantini Chakraborty, Tamal Das, Saurav Sutradhar, Mrinmoy Das, and Suman Deb. An analytical review of quantum neural network models and relevant research. In *2020 5th International Conference on Communication and Electronics Systems (ICCES)*, pages 1395–1400, 2020.
- [22] Kishor Bharti, Tobias Haug, Vlatko Vedral, and Leong-Chuan Kwek. Machine learning meets quantum foundations: A brief survey. *AVS Quantum Science*, 2(3), jul 2020.
- [23] S. Mangini, F. Tacchino, D. Gerace, D. Bajoni, and C. Macchiavello. Quantum computing models for artificial neural networks. *Europhysics Letters*, 134(1):10002, apr 2021.
- [24] Yunseok Kwak, Won Joon Yun, Soyi Jung, and Joongheon Kim. Quantum neural networks: Concepts, applications, and challenges. In *Twelfth International Conference on Ubiquitous and Future Networks, ICUFN 2021, Jeju Island, South Korea, August 17-20, 2021*, pages 413–416. IEEE, 2021.
- [25] Renxin Zhao and Shi Wang. A review of quantum neural networks: Methods, models, dilemma, 2021.
- [26] Manjunath T N, Adarsh Hiremath, Niranjanamurthy M, Sheng-Lung Peng, Shrihari M R, and Pushpa S K. A survey on machine learning techniques using quantum computing. In *2022 Fourth International Conference on Emerging Research in Electronics, Computer Science and Technology (ICERECT)*, pages 1–6, 2022.
- [27] Muhammad Junaid Umer and Muhammad Imran Sharif. A comprehensive survey on quantum machine learning and possible applications. *Int. J. E Health Medical Commun.*, 13(5):1–17, 2022.
- [28] Nikolaos Schetakis, D. Aghamalyan, P. Griffin, and M. Boguslavsky. Review of some existing qml frameworks and novel hybrid classical–quantum neural networks realising binary classification for the noisy datasets. *Scientific Reports*, 12:11927, 07 2022.

- [29] Stefano Markidis. Programming quantum neural networks on NISQ systems: An overview of technologies and methodologies. *Entropy*, 25(4):694, 2023.
- [30] Fabio Valerio Massoli, Lucia Vadicamo, Giuseppe Amato, and Fabrizio Falchi. A leap among quantum computing and quantum neural networks: A survey. *ACM Comput. Surv.*, 55(5):98:1–98:37, 2023.
- [31] Alexander M. Dalzell, Sam McArdle, Mario Berta, Przemyslaw Bienias, Chi-Fang Chen, András Gilyén, Connor T. Hann, Michael J. Kastoryano, Emil T. Khabiboulline, Aleksander Kubica, Grant Salton, Samson Wang, and Fernando G. S. L. Brandão. Quantum algorithms: A survey of applications and end-to-end complexities, 2023.
- [32] Richard Feynmann. Simulating physics with computers. *Int J Theor Phys*, 21:467–488, 1982.
- [33] John Preskill. Quantum computing in the NISQ era and beyond. *Quantum*, 2:79, aug 2018.
- [34] John Preskill. Quantum computing 40 years later. *CoRR*, abs/2106.10522, 2023.
- [35] Maria Schuld and Nathan Killoran. Is quantum advantage the right goal for quantum machine learning? *PRX Quantum*, 3:030101, Jul 2022.
- [36] Dan C. Marinescu and Gabriela M. Marinescu. Chapter 2 - measurements and quantum information. In Dan C. Marinescu and Gabriela M. Marinescu, editors, *Classical and Quantum Information*, pages 133–220. Academic Press, Boston, 2012.
- [37] Bruce R. Wheaton. Wave-particle duality: A modern view. In Daniel M. Greenberger, Klaus Hentschel, and Friedel Weinert, editors, *Compendium of Quantum Physics*, pages 835–840. Springer, 2009.
- [38] Ovidiu Cristinel Stoica. Born rule: quantum probability as classical probability. *CoRR*, abs/2209.08621, 2023.
- [39] Adriano Barenco, Charles H. Bennett, Richard Cleve, David P. DiVincenzo, Norman Margolus, Peter Shor, Tycho Sleator, John A. Smolin, and Harald Weinfurter. Elementary gates for quantum computation. *Physical Review A*, 52(5):3457–3467, nov 1995.
- [40] Dan C. Marinescu and Gabriela M. Marinescu. Chapter 1 - preliminaries. In Dan C. Marinescu and Gabriela M. Marinescu, editors, *Classical and Quantum Information*, pages 1–131. Academic Press, Boston, 2012.
- [41] Edgard Muñoz-Coreas and Himanshu Thapliyal. Everything you always wanted to know about quantum circuits, aug 2022.
- [42] Gerardo Adesso, Thomas R Bromley, and Marco Cianciaruso. Measures and applications of quantum correlations. *Journal of Physics A: Mathematical and Theoretical*, 49(47):473001, nov 2016.
- [43] Diego G. Bussandri and Pedro W. Lambert. Chapter 7 - quantum metrology and quantum correlations. In Angelo Plastino, Arni S.R. Srinivasa Rao, and C.R. Rao, editors, *Information Geometry*, volume 45 of *Handbook of Statistics*, pages 149–160. Elsevier, 2021.
- [44] A. Einstein, M. Born, and H. Born. *The Born-Einstein Letters: Correspondence Between Albert Einstein and Max and Hedwig Born from 1916-1955, with Commentaries by Max Born*. Macmillan, 1971.
- [45] Qiskit contributors. Qiskit: An Open-source Framework for Quantum Computing, 2023. (Accessed on 10/10/2023).
- [46] Ville Bergholm, Josh A. Izaac, Maria Schuld, Christian Gogolin, and Nathan Killoran. Pennylane: Automatic differentiation of hybrid quantum-classical computations. *CoRR*, abs/1811.04968, 2018.
- [47] Maximilian Schlosshauer. Quantum decoherence. *Physics Reports*, 831:1–57, oct 2019.
- [48] Ali Shaib, Mohamad H. Naim, Mohammed E. Fouda, Rouwaida Kanj, and Fadi J. Kurdahi. Efficient noise mitigation technique for quantum computing. *CoRR*, abs/2109.05136, 2021.

- [49] W. Heisenberg. Über den anschaulichen Inhalt der quantentheoretischen Kinematik und Mechanik. *Zeitschrift für Physik*, 33:879–893, 1925.
- [50] W. K. Wootters and W. H. Zurek. A single quantum cannot be cloned. *Nature*, 299(5886):802–803, October 1982.
- [51] Asher Peres. Reversible logic and quantum computers. *Phys. Rev. A*, 32:3266–3276, Dec 1985.
- [52] Michael A. Nielsen and Isaac L. Chuang. *Quantum Computation and Quantum Information: 10th Anniversary Edition*. Cambridge University Press, 2010.
- [53] Peter W. Shor. Scheme for reducing decoherence in quantum computer memory. *Phys. Rev. A*, 52:R2493–R2496, Oct 1995.
- [54] Ryan LaRose, Andrea Mari, Sarah Kaiser, Peter J. Karalekas, Andre A. Alves, Piotr Czarnik, Mohamed El Mandouh, Max H. Gordon, Yousef Hindy, Aaron Robertson, Purva Thakre, Misty Wahl, Danny Samuel, Rahul Mistri, Maxime Tremblay, Nick Gardner, Nathaniel T. Stemen, Nathan Shammah, and William J. Zeng. Mitiq: A software package for error mitigation on noisy quantum computers. *Quantum*, 6:774, aug 2022.
- [55] Tudor Giurgica-Tiron, Yousef Hindy, Ryan LaRose, Andrea Mari, and William J. Zeng. Digital zero noise extrapolation for quantum error mitigation. In *2020 IEEE International Conference on Quantum Computing and Engineering (QCE)*. IEEE, oct 2020.
- [56] Ewout van den Berg, Zlatko K. Mineev, Abhinav Kandala, and Kristan Temme. Probabilistic error cancellation with sparse pauli-lindblad models on noisy quantum processors, 2022.
- [57] Koen Bertels, Aritra Sarkar, A. M. Krol, Ravish Budhrani, J. Samadi, E. Geoffroy, J. Matos, R. Abreu, Georges G. E. Gielen, and Imran Ashraf. Quantum accelerator stack: A research roadmap. *CoRR*, abs/2102.02035, 2021.
- [58] Seth Lloyd, Masoud Mohseni, and Patrick Rebentrost. Quantum principal component analysis. *Nature Physics*, 10(9):631–633, jul 2014.
- [59] Kai Yu, Song Lin, and Gong-De Guo. Quantum dimensionality reduction by linear discriminant analysis. *Physica A: Statistical Mechanics and its Applications*, 614:128554, mar 2023.
- [60] Christos H. Papadimitriou and Mihalis Yannakakis. Optimization, approximation, and complexity classes. *J. Comput. Syst. Sci.*, 43(3):425–440, 1991.
- [61] Ryan Babbush et al. Frank Arute, Kunal Arya. Quantum supremacy using a programmable superconducting processor. *Nature*, 574:505–510, 2019.
- [62] John Watrous. Quantum computational complexity. In Robert A. Meyers, editor, *Encyclopedia of Complexity and Systems Science*, pages 7174–7201. Springer, 2009.
- [63] IBM Quantum. The ibm quantum development roadmap. *Solving the scaling problem*, 2022.
- [64] Honeywell. Get to Know Honeywell’s Latest Quantum Computer. *Honeywell News*, 2022. (Accessed on 10/10/2023).
- [65] IBM. IBM Unveils 400 Qubit-Plus Quantum Processor and Next-Generation IBM Quantum System Two. <https://newsroom.ibm.com/2022-11-09-IBM-Unveils-400-Qubit-Plus-Quantum-Processor-and-Next-Generation-IBM-Quantum-System-Two>, 2022. (Accessed on 10/10/2023).
- [66] Honeywell. HONEYWELL SYSTEM MODEL H1. *Honeywell Quantum*, 2022. (Accessed on 10/10/2023).
- [67] Marcello Benedetti, Erika Lloyd, Stefan Sack, and Mattia Fiorentini. Parameterized quantum circuits as machine learning models. *Quantum Science and Technology*, 4(4):043001, nov 2019.
- [68] M. Cerezo, Andrew Arrasmith, Ryan Babbush, Simon C. Benjamin, Suguru Endo, Keisuke Fujii, Jarrod R. McClean, Kosuke Mitarai, Xiao Yuan, Lukasz Cincio, and Patrick J. Coles. Variational quantum algorithms. *Nature Reviews Physics*, 3(9):625–644, aug 2021.

- [69] Venkat R. Dasari, Mee Seong Im, and Lubjana Beshaj. Solving machine learning optimization problems using quantum computers. *CoRR*, abs/1911.08587, 2019.
- [70] Edward Farhi, Jeffrey Goldstone, and Sam Gutmann. A quantum approximate optimization algorithm, 2014.
- [71] Jules Tilly, Hongxiang Chen, Shuxiang Cao, Dario Picozzi, Kanav Setia, Ying Li, Edward Grant, Leonard Wossnig, Ivan Rungger, George H. Booth, and Jonathan Tennyson. The variational quantum eigensolver: A review of methods and best practices. *Physics Reports*, 986:1–128, nov 2022.
- [72] Yong Zhang. Quantum computing via the bethe ansatz. *Quantum Inf. Process.*, 11(2):585–590, 2012.
- [73] Jung Jun Park and Hyunchul Nha. Fluctuation theorem for information thermodynamics of quantum correlated systems. *Entropy*, 25(1):165, 2023.
- [74] Ajinkya Borle and Samuel J. Lomonaco. Analyzing the quantum annealing approach for solving linear least squares problems. In Gautam K. Das, Partha Sarathi Mandal, Krishnendu Mukhopadhyaya, and Shin-Ichi Nakano, editors, *WALCOM: Algorithms and Computation - 13th International Conference, WALCOM 2019, Guwahati, India, February 27 - March 2, 2019, Proceedings*, volume 11355 of *Lecture Notes in Computer Science*, pages 289–301. Springer, 2019.
- [75] Kyungtaek Jun. Qubo formulations for numerical quantum computing, 2022.
- [76] Herbert B Callen. *Thermodynamics and an introduction to thermostatistics; 2nd ed.* Wiley, New York, NY, 1985.
- [77] Massimo Panella and Giuseppe Martinelli. Neural networks with quantum architecture and quantum learning. *Int. J. Circuit Theory Appl.*, 39(1):61–77, 2011.
- [78] Maurizio Capra, Beatrice Bussolino, Alberto Marchisio, Guido Masera, Maurizio Martina, and Muhammad Shafique. Hardware and software optimizations for accelerating deep neural networks: Survey of current trends, challenges, and the road ahead. *IEEE Access*, 8:225134–225180, 2020.
- [79] Iris Cong, Soonwon Choi, and Mikhail D. Lukin. Quantum convolutional neural networks. *Nature Physics*, 15(12):1273–1278, aug 2019.
- [80] Maxwell Henderson, Samridhi Shakya, Shashindra Pradhan, and Tristan Cook. Quancvolutional neural networks: Powering image recognition with quantum circuits, 2019.
- [81] Johannes Bausch. Recurrent quantum neural networks, 2020.
- [82] Yanan Li, Zhimin Wang, Rongbing Han, Shangshang Shi, Jiaxin Li, Ruimin Shang, Haiyong Zheng, Guoqiang Zhong, and Yongjian Gu. Quantum recurrent neural networks for sequential learning, 2023.
- [83] Heliang Huang, Yuxuan Du, Ming Gong, Youwei Zhao, Yulin Wu, Chaoyue Wang, Shaowei Li, Futian Liang, Jin Lin, Yu Xu, Rui Yang, Tongliang Liu, Min-Hsiu Hsieh, Hui Deng, Hao Rong, Cheng-Zhi Peng, Chao-Yang Lu, Yu-Ao Chen, Dacheng Tao, Xiaobo Zhu, and Jian-Wei Pan. Experimental quantum generative adversarial networks for image generation. *CoRR*, abs/2010.06201, 2020.
- [84] Jonathan Romero, Jonathan P Olson, and Alan Aspuru-Guzik. Quantum autoencoders for efficient compression of quantum data. *Quantum Science and Technology*, 2(4):045001, aug 2017.
- [85] Elham Torabian and Roman V. Krems. Compositional optimization of quantum circuits for quantum kernels of support vector machines, 2023.
- [86] Zoran Kronic, Frederik Flother, George Seegan, Nate Earnest-Noble, and Shehab Omar. Quantum kernels for real-world predictions based on electronic health records. *IEEE Transactions on Quantum Engineering*, 3:1–11, 2022.
- [87] Teresa Sancho-Lorente, Juan Román Roche, and David Zueco. Quantum kernels to learn the phases of quantum matter. *Physical Review A*, 105(4), apr 2022.

- [88] David Horn and Assaf Gottlieb. Algorithm for data clustering in pattern recognition problems based on quantum mechanics. *Physical review letters*, 88:018702, 02 2002.
- [89] Esma Aïmeur, Gilles Brassard, and Sébastien Gambs. Quantum clustering algorithms. In Zoubin Ghahramani, editor, *Machine Learning, Proceedings of the Twenty-Fourth International Conference (ICML 2007), Corvallis, Oregon, USA, June 20-24, 2007*, volume 227 of *ACM International Conference Proceeding Series*, pages 1–8. ACM, 2007.
- [90] Javier Mancilla and Christophe Pere. A preprocessing perspective for quantum machine learning classification advantage in finance using NISQ algorithms. *Entropy*, 24(11):1656, 2022.
- [91] Daniel Sierra-Sosa, Juan D. Arcila-Moreno, Begonya Garcia-Zapirain, and Adel Elmaghraby. Diabetes type 2: Poincaré data preprocessing for quantum machine learning. *Computers, Materials & Continua*, 67(2):1849–1861, 2021.
- [92] Ryan LaRose and Brian Coyle. Robust data encodings for quantum classifiers. *CoRR*, abs/2003.01695, 2020.
- [93] Guangxi Li, Ruilin Ye, Xuanqiang Zhao, and Xin Wang. Concentration of data encoding in parameterized quantum circuits. In *NeurIPS*, 2022.
- [94] Manuela Weigold, Johanna Barzen, Frank Leymann, and Marie Salm. Expanding data encoding patterns for quantum algorithms. In *18th IEEE International Conference on Software Architecture Companion, ICSA Companion 2021, Stuttgart, Germany, March 22-26, 2021*, pages 95–101. IEEE, 2021.
- [95] Maria Schuld and Francesco Petruccione. *Supervised Learning with Quantum Computers*. Springer Publishing Company, Incorporated, 1st edition, 2018.
- [96] Daniel K. Park, Francesco Petruccione, and June-Koo Kevin Rhee. Circuit-based quantum random access memory for classical data. *Scientific Reports*, 9(1), mar 2019.
- [97] Vojtěch Havlíček, Antonio D. Córcoles, Kristan Temme, Aram W. Harrow, Abhinav Kandala, Jerry M. Chow, and Jay M. Gambetta. Supervised learning with quantum-enhanced feature spaces. *Nature*, 567(7747):209–212, mar 2019.
- [98] Elija Perrier, Akram Youssry, and Chris Ferrie. Qdataset, quantum datasets for machine learning. *Scientific Data*, 9, 09 2022.
- [99] M. Rupp, A. Tkatchenko, K.-R. Müller, and O. A. von Lilienfeld. Fast and accurate modeling of molecular atomization energies with machine learning. *Physical Review Letters*, 108:058301, 2012.
- [100] Grégoire Montavon, Matthias Rupp, Vivekanand Gobre, Alvaro Vazquez-Mayagoitia, Katja Hansen, Alexandre Tkatchenko, Klaus-Robert Müller, and O Anatole von Lilienfeld. Machine learning of molecular electronic properties in chemical compound space. *New Journal of Physics*, 15(9):095003, 2013.
- [101] Raghunathan Ramakrishnan, Mia Hartmann, Enrico Tapavicza, and O. Anatole von Lilienfeld. Electronic spectra from TDDFT and machine learning in chemical space. *The Journal of Chemical Physics*, 143(8):084111, 08 2015.
- [102] Raghunathan Ramakrishnan, Pavlo O Dral, Matthias Rupp, and O Anatole von Lilienfeld. Quantum chemistry structures and properties of 134 kilo molecules. *Scientific Data*, 1, 2014.
- [103] Edward Farhi and Hartmut Neven. Classification with quantum neural networks on near term processors, 2018.
- [104] Giovanni Acampora, Roberto Schiattarella, and Alfredo Troiano. A dataset for quantum circuit mapping. *Data in Brief*, 39:107526, 2021.
- [105] Justyna P. Zwolak, Sandesh S. Kalantre, Xingyao Wu, Stephen Ragole, and Jacob M. Taylor. Qflow lite dataset: A machine-learning approach to the charge states in quantum dot experiments. *PLOS ONE*, 13(10):1–17, 10 2018.
- [106] Louis Schatzki, Andrew Arrasmith, Patrick J. Coles, and Marco Cerezo.

- Entangled datasets for quantum machine learning. *CoRR*, abs/2109.03400, 2021.
- [107] L. C. Blum and J.-L. Reymond. 970 million druglike small molecules for virtual screening in the chemical universe database GDB-13. *J. Am. Chem. Soc.*, 131:8732, 2009.
- [108] Lars Ruddigkeit, Ruud van Deursen, Lorenz C. Blum, and Jean-Louis Reymond. Enumeration of 166 billion organic small molecules in the chemical universe database GDB-17. *J. Chem. Inf. Model.*, 52(11):2864–2875, 2012.
- [109] Yann LeCun, Léon Bottou, Yoshua Bengio, and Patrick Haffner. Gradient-based learning applied to document recognition. *Proc. IEEE*, 86(11):2278–2324, 1998.
- [110] Han Xiao, Kashif Rasul, and Roland Vollgraf. Fashion-mnist: a novel image dataset for benchmarking machine learning algorithms. *CoRR*, abs/1708.07747, 2017.
- [111] Hsin-Yuan Huang, Michael Broughton, Masoud Mohseni, Ryan Babbush, Sergio Boixo, Hartmut Neven, and Jarrod R. McClean. Power of data in quantum machine learning. *Nature Communications*, 12(1), may 2021.
- [112] IBM. Quantum Lab | IBM Quantum Learning. <https://quantum-computing.ibm.com/lab>. (Accessed on 10/10/2023).
- [113] IonQ. Compare Quantum Systems. <https://ionq.com/quantum-systems/compare>. (Accessed on 10/10/2023).
- [114] Lars Madsen, Fabian Laudenbach, Mohsen Askarani, Fabien Rortais, Trevor Vincent, Jacob Bulmer, Filippo Miatto, Leonhard Neuhaus, Lukas Helt, Matthew Collins, Adriana Lita, Thomas Gerrits, Sae Nam, Varun Vaidya, Matteo Menotti, Ish Dhand, Zachary Vernon, Nicolas Quesada, and Jonathan Lavoie. Quantum computational advantage with a programmable photonic processor. *Nature*, 606:75–81, 06 2022.
- [115] Catherine McGeoch and Pau Farre. The D-Wave Advantage System: An Overview. Technical report, 09 2020.
- [116] IBM. Hardware | IBM Quantum Documentation. <https://docs.quantum-computing.ibm.com>. (Accessed on 10/10/2023).
- [117] Jwo-Sy Chen, Erik Nielsen, Matthew Ebert, Volkan Inlek, Kenneth Wright, Vandiver Chaplin, Andrii Maksymov, Eduardo Páez, Amrit Poudel, Peter Maunz, and John Gamble. Benchmarking a trapped-ion quantum computer with 29 algorithmic qubits, 2023.
- [118] J. M. Arrazola, V. Bergholm, K. Brádler, T. R. Bromley, M. J. Collins, I. Dhand, A. Fumagalli, T. Gerrits, A. Goussev, L. G. Helt, J. Hundal, T. Isacsson, R. B. Israel, J. Izaac, S. Jahangiri, R. Janik, N. Killoran, S. P. Kumar, J. Lavoie, A. E. Lita, D. H. Mahler, M. Menotti, B. Morrison, S. W. Nam, L. Neuhaus, H. Y. Qi, N. Quesada, A. Reppingon, K. K. Sabapathy, M. Schuld, D. Su, J. Swinerton, A. Száva, K. Tan, P. Tan, V. D. Vaidya, Z. Vernon, Z. Zabaneh, and Y. Zhang. Quantum circuits with many photons on a programmable nanophotonic chip. *Nature*, 591(7848):54–60, mar 2021.
- [119] Google. A Preview of Bristlecone, Google’s New Quantum Processor. <https://blog.research.google/2018/03/a-preview-of-bristlecone-googles-new.html>, march 2018. (Accessed on 10/10/2023).
- [120] Google Quantum AI. <https://quantumai.google/>, 2016. (Accessed on 10/10/2023).
- [121] Rigetti Computing. Building scalable, innovative quantum systems. <https://www.rigetti.com/what-we-build>. (Accessed on 10/10/2023).
- [122] Intel. Intel Debuts 2nd-Gen Horse Ridge Cryogenic Quantum Control Chip — intel.com. <https://www.intel.com/content/www/us/en/newsroom/news/2nd-gen-horse-ridge-cryogenic-quantum-control-chip.html#gs.4h1159>. (Accessed on 10/10/2023).
- [123] Quantinuum. Hardware | The Future of Quantum Hardware. <https://www.quantinuum.com/hardware>. (Accessed on 10/10/2023).

- [124] Katrina Barnes, Peter Battaglini, Benjamin J. Bloom, Kayleigh Cassella, Robin Coxe, Nicole Crisosto, Jonathan P. King, Stanimir S. Kondov, Krish Kotru, Stuart C. Larsen, Joseph Lauigan, Brian J. Lester, Mickey McDonald, Eli Megidish, Sandeep Narayanaswami, Ciro Nishiguchi, Remy Notermans, Lucas S. Peng, Albert Ryou, Tsung-Yao Wu, and Michael Yarwood. Assembly and coherent control of a register of nuclear spin qubits. *Nature Communications*, 13(1), may 2022.
- [125] Jonathan Wurtz, Alexei Bylinskii, Boris Braverman, Jesse Amato-Grill, Sergio H. Cantu, Florian Huber, Alexander Lukin, Fangli Liu, Phillip Weinberg, John Long, Sheng-Tao Wang, Nathan Gemelke, and Alexander Keesling. Aquila: Quera’s 256-qubit neutral-atom quantum computer, 2023.
- [126] J. King, S. Yarkoni, J. Raymond, I. Ozfidan, A. D. King, M. Mohammadi Nevisi, J. P. Hilton, and C. C. McGeoch. Quantum Annealing amid Local Ruggedness and Global Frustration. Technical report, 03 2017.
- [127] David P. DiVincenzo. The physical implementation of quantum computation. *Fortschritte der Physik*, 48(9-11):771–783, sep 2000.
- [128] Anton Frisk Kockum and Franco Nori. Quantum bits with josephson junctions. In *Fundamentals and Frontiers of the Josephson Effect*, pages 703–741. Springer International Publishing, 2019.
- [129] Sergey Bravyi, Oliver Dial, Jay M. Gambetta, Darío Gil, and Zaira Nazario. The future of quantum computing with superconducting qubits. *Journal of Applied Physics*, 132(16):160902, oct 2022.
- [130] Ahmad Salmanogli. Entanglement engineering by transmon qubit in a circuit qed, 2021.
- [131] Shannon P. Harvey. Quantum dots/spin qubits, feb 2022.
- [132] Loïc Henriët, Lucas Beguin, Adrien Signoles, Thierry Lahaye, Antoine Browaeys, Georges-Olivier Reymond, and Christophe Jurczak. Quantum computing with neutral atoms. *Quantum*, 4:327, sep 2020.
- [133] Xiao-Feng Shi. Quantum logic and entanglement by neutral rydberg atoms: methods and fidelity. *Quantum Science and Technology*, 7(2):023002, apr 2022.
- [134] Sergei Slussarenko and Geoff J. Pryde. Photonic quantum information processing: A concise review. *Applied Physics Reviews*, 6(4):041303, dec 2019.
- [135] Jeng-Yuan Tsai, Jinbo Pan, Hsin Lin, Arun Bansil, and Qimin Yan. Antisite defect qubits in monolayer transition metal dichalcogenides. *Nature Communications*, 13(1), jan 2022.
- [136] C. Tutschku, R. W. Reinthaler, C. Lei, A. H. MacDonald, and E. M. Hankiewicz. Majorana-based quantum computing in nanowire devices. *Physical Review B*, 102(12), sep 2020.
- [137] Morteza Aghaee, Arun Akkala, Zulfi Alam, Rizwan Ali, Alejandro Alcaraz Ramirez, Mariusz Andrzejczuk, Andrey E. Antipov, Pavel Aseev, Mikhail Astafev, Bela Bauer, Jonathan Becker, Srini Boddapati, Frenk Boekhout, Jouri Bommer, Tom Bosma, Leo Bourdet, Samuel Boutin, Philippe Caroff, Lucas Casparis, Maja Cassidy, Sohail Chatoor, Anna Wulf Christensen, Noah Clay, William S. Cole, Fabiano Corsetti, Ajuan Cui, Paschalis Dalampiras, Anand Dokania, Gijs de Lange, Michiel de Moor, Juan Carlos Estrada Saldaña, Saeed Fallahi, Zahra Heidarnia Fathabad, John Gamble, Geoff Gardner, Deshan Govender, Flavio Griggio, Ruben Grigoryan, Sergei Gronin, Jan Gukelberger, Esben Bork Hansen, Sebastian Heedt, Jesús Herranz Zamorano, Samantha Ho, Ulrik Laurens Holgaard, Henrik Ingerslev, Linda Johansson, Jeffrey Jones, Ray Kallahaer, Farhad Karimi, Torsten Karzig, Cameron King, Maren Elisabeth Kloster, Christina Knapp, Dariusz Kocon, Jonne Koski, Pasi Kostamo, Peter Krogstrup, Mahesh Kumar, Tom Laeven, Thorvald Larsen, Kongyi Li, Tyler Lindemann, Julie Love, Roman Lutchny, Morten Hannibal Madsen, Michael Manfra, Signe Markussen, Esteban Martinez,



- Robert McNeil, Elvedin Memisevic, Trevor Morgan, Andrew Mullally, Chetan Nayak, Jens Nielsen, William Hvidtfelt Padkær Nielsen, Bas Nijholt, Anne Nurmohamed, Eoin O'Farrell, Keita Otani, Sebastian Pauka, Karl Petersson, Luca Petit, Dmitry I. Pikulin, Frank Preiss, Marina Quintero-Perez, Mohana Rajpalke, Katrine Rasmussen, Davydas Razmadze, Outi Reentila, David Reilly, Richard Rouse, Ivan Sadovskyy, Lauri Sainiemi, Sydney Schreppler, Vadim Sidorkin, Amrita Singh, Shilpi Singh, Sarat Sinha, Patrick Sohr, Tomaš Stankevič, Lieuwe Stek, Henri Suominen, Judith Suter, Vicky Svidenko, Sam Teicher, Mine Temuerhan, Nivetha Thiyagarajah, Raj Tholapi, Mason Thomas, Emily Toomey, Shivendra Upadhyay, Ivan Urban, Saulius Vaitiekėnas, Kevin Van Hoogdalem, David Van Woerkom, Dmitrii V. Viazmitinov, Dominik Vogel, Steven Waddy, John Watson, Joseph Weston, Georg W. Winkler, Chung Kai Yang, Sean Yau, Daniel Yi, Emrah Yucelen, Alex Webster, Roland Zeisel, and Ruichen Zhao and. InAs-al hybrid devices passing the topological gap protocol. *Physical Review B*, 107(24), jun 2023.
- [138] Toshinari Itoko, Rudy Raymond, Takashi Imamichi, and Atsushi Matsuo. Optimization of quantum circuit mapping using gate transformation and commutation. *Integration*, 70:43–50, 2020.
- [139] Robert Wille and Lukas Burgholzer. Mqt qmap: Efficient quantum circuit mapping. In *Proceedings of the 2023 International Symposium on Physical Design, ISPD '23*, page 198–204, New York, NY, USA, 2023. Association for Computing Machinery.
- [140] Nathan Killoran, Josh Izaac, Nicol'as Quesada, Ville Bergholm, Matthew Amy, and Christian Weedbrook. Strawberry Fields: A software platform for photonic quantum computing. *Quantum*, 3:129, 2019.
- [141] Robert S. Smith, Michael J. Curtis, and William J. Zeng. A practical quantum instruction set architecture, 2016.
- [142] Peter J Karalekas, Nikolas A Tezak, Eric C Peterson, Colm A Ryan, Marcus P da Silva, and Robert S Smith. A quantum-classical cloud platform optimized for variational hybrid algorithms. *Quantum Science and Technology*, 5(2):024003, apr 2020.
- [143] Quantinuum TKET. <https://www.quantinuum.com/developers/tket>. (Accessed on 10/10/2023).
- [144] Cirq Developers. Cirq, July 2023. See full list of authors on Github: <https://github.com/quantumlib/Cirq/graphs/contributors>.
- [145] Jarrod R McClean, Nicholas C Rubin, Kevin J Sung, Ian D Kivlichan, Xavier Bonet-Monroig, Yudong Cao, Chengyu Dai, E Schuyler Fried, Craig Gidney, Brendan Gimby, Pranav Gokhale, Thomas Häner, Tarini Hardikar, Vojtěch Havlíček, Oscar Higgott, Cupjin Huang, Josh Izaac, Zhang Jiang, Xinle Liu, Sam McArdle, Matthew Neeley, Thomas O'Brien, Bryan O'Gorman, Isil Ozfidan, Maxwell D Radin, Jhonathan Romero, Nicolas P D Sawaya, Bruno Senjean, Kanav Setia, Sukin Sim, Damian S Steiger, Mark Steudtner, Qiming Sun, Wei Sun, Daochen Wang, Fang Zhang, and Ryan Babbush. Openfermion: the electronic structure package for quantum computers. *Quantum Science and Technology*, 5(3):034014, jun 2020.
- [146] Michael Broughton, Guillaume Verdon, Trevor McCourt, Antonio J. Martinez, Jae Hyeon Yoo, Sergei V. Isakov, Philip Massey, Murphy Yuezhen Niu, Ramin Halavati, Evan Peters, Martin Leib, Andrea Skolik, Michael Streif, David Von Dollen, Jarrod R. McClean, Sergio Boixo, Dave Bacon, Alan K. Ho, Hartmut Neven, and Masoud Mohseni. Tensorflow quantum: A software framework for quantum machine learning. *CoRR*, abs/2003.02989, 2020.
- [147] The Leap™ Quantum Cloud Service | D-Wave. <https://www.dwavesys.com/solutions-and-products/cloud-platform/>. (Accessed on 10/10/2023).
- [148] qBraid. <https://www.qbraid.com/>. (Accessed on 10/10/2023).

- [149] IonQ Quantum Cloud. <https://ionq.com/quantum-cloud>. (Accessed on 10/10/2023).
- [150] Amazon Web Services. Amazon Braket, 2020.
- [151] Azure Quantum - Quantum Cloud Computing Service. <https://azure.microsoft.com/en-us/products/quantum>. (Accessed on 10/10/2023).
- [152] Build and deploy Industrial Generative AI applications on Orquestra. <https://zapata.ai/orquestra-platform/>. (Accessed on 10/10/2023).
- [153] Xanadu | Welcome to Xanadu. <https://www.xanadu.ai/>. (Accessed on 10/10/2023).
- [154] Raffaele Santagati, Alan Aspuru-Guzik, Ryan Babbush, Matthias Degroote, Leticia Gonzalez, Elica Kyoseva, Nikolaj Moll, Markus Oppel, Robert M. Parrish, Nicholas C. Rubin, Michael Streif, Christofer S. Tautermann, Horst Weiss, Nathan Wiebe, and Clemens Utschig-Utschig. Drug design on quantum computers, 2023.
- [155] C.L. Degen, F. Reinhard, and P. Cappellaro. Quantum sensing. *Reviews of Modern Physics*, 89(3), jul 2017.
- [156] N. Aslam, H. Zhou, and E.K. et al. Urbach. Quantum sensors for biomedical applications. *Nat Rev Phys*, 5:157–169, 2023.
- [157] Takeshi Ohshima. Toward real application of quantum sensing and metrology. *Front. Quantum. Sci. Technol. Sec. Quantum Sensing and Metrology*, 1:157–169, 2022.
- [158] R. L. Rivest, A. Shamir, and L. Adleman. A method for obtaining digital signatures and public-key cryptosystems. *Commun. ACM*, 21(2):120–126, feb 1978.
- [159] P.W. Shor. Algorithms for quantum computation: discrete logarithms and factoring. In *Proceedings 35th Annual Symposium on Foundations of Computer Science*, pages 124–134, 1994.
- [160] Peter W. Shor. Polynomial-time algorithms for prime factorization and discrete logarithms on a quantum computer. *SIAM Journal on Computing*, 26(5):1484–1509, oct 1997.
- [161] Matthew Campagna, Lidong Chen, Özgür Dagdelen, Jintai Ding, Jennifer K. Fernick, Nicolas Gisin, Donald Hayford, Thomas Jennewein, Norbert Lütkenhaus, Michele Mosca, Brian Neill, Mark Pecun, Ray Perlner, Grégoire Ribordy, John M. Schanck, Douglas Stebila, Nino Walenta, William Whyte, and Zhenfei Zhang. Quantum safe cryptography and security: An introduction, benefits, enablers and challengers. Technical report, ETSI (European Telecommunications Standards Institute), June 2015.
- [162] Douglas Stebila and Michele Mosca. Post-quantum key exchange for the internet and the open quantum safe project. *Cryptology ePrint Archive*, Paper 2016/1017, 2016. <https://eprint.iacr.org/2016/1017>.
- [163] Mathieu Bozzio, Michal Vyvlečka, Michael Cosacchi, Cornelius Nawrath, Tim Seidelmann, Juan C. Loredó, Simone L. Portalupi, Vollrath M. Axt, Peter Michler, and Philip Walther. Enhancing quantum cryptography with quantum dot single-photon sources. *npj Quantum Information*, 8(1), sep 2022.
- [164] Román Orús, Samuel Mugel, and Enrique Lizaso. Quantum computing for finance: Overview and prospects. *Reviews in Physics*, 4:100028, 2019.
- [165] László Babai, Peter Frankl, and Janos Simon. Complexity classes in communication complexity theory (preliminary version). In *27th Annual Symposium on Foundations of Computer Science, Toronto, Canada, 27-29 October 1986*, pages 337–347. IEEE Computer Society, 1986.

## A Complexity Theory

This section provides an overview of complexity classes. A *promise problem* is a decision problem where the input is to be selected from all possible input strings. A problem with an explicitly defined structure or characteristics of input is defined in advance, making the problem environment-entrusted with certain types of promised input with no instance of input sent in unexpectedly or out of definition. All promise problems are assigned to a complexity class suitable to their nature and requirements. Formally, *complexity classes* are a group of computational problems that have similar resource-based complexity [165]. In classical computing, there exist the following classes:

- *Polynomial Class (P)*: It contains all decision problems that can be solved by a deterministic Turing machine using a polynomial amount of computation time, or polynomial time.
- *Non-deterministic Polynomial (NP)*: It is the collection of decision problems that can be solved by a non-deterministic machine in polynomial time but these problems of NP can be verified by a Turing machine in polynomial time.
- *NP-hard*: An NP-hard problem is at least as hard as the hardest problem in NP and it is a class of problems such that every problem in NP reduces to NP-hard. Since it takes a long time to verify their solution, all NP-hard problems are not in NP.
- *NP-complete*: A problem is NP-complete if it is both NP and NP-hard. NP-complete problems are the hardest problems in the NP space. If one could solve an NP-complete problem in polynomial time, then one could also solve any NP problem in polynomial time.