

# A New Adaptive Phase-locked Loop for Synchronization of a Grid-Connected Voltage Source Converter: Simulation and Experimental Results

Wei He, Jiacheng Yan, Romeo Ortega, Daniele Zonetti

**Abstract**—In [1] a new adaptive phase-locked loop scheme for synchronization of a grid connected voltage source converter with guaranteed (almost) global stability properties was reported. To guarantee a suitable synchronization with the angle of the three-phase grid voltage we design an adaptive observer for such a signal requiring measurements only at the point of common coupling. In this paper we present some simulation and experimental illustration of the excellent performance of the proposed solution.

**Index Terms**—Voltage source converter, phase-locked loop, adaptive observer, generalized parameter estimation-based observer, synchronization

## I. INTRODUCTION

The landscape of energy generation is undergoing unprecedented transformations, as renewable energy sources (RES) become increasingly prominent in modern power grids. A key role in this transformation is played by voltage source converters (VSCs), which enable the integration of RES, such as photovoltaic panels and wind turbines, into the existing grid [2]–[5]. VSCs exhibit distinct characteristics from conventional synchronous generators—which are the devices that have historically dominated power grids—and possess a notable advantage in terms of enhanced controllability. However, capitalizing on this advantage demands the formulation of robust control strategies that can effectively withstand significant perturbations generated by variations in power supply and demand, transient disturbances, and intermittent RES.

These perturbations typically manifest as substantial voltage and frequency fluctuations at the Point of Common Coupling (PCC), which become more relevant in power grids characterized by a low level of inertia and low short-circuit capabilities. Although there is an interest in developing a unified approach to deal with both scenarios, there exist many practical situations where the grid is characterized by a relatively high level

of inertia, yet low short-circuit capabilities. These include low-voltage distribution systems characterized by a large share of constant power loads or where the cables used for transmission have a small section [6]; high-voltage transmission systems, whereas large transformers are needed to step up the voltage to facilitate transmission [7]. It is common to refer to grids with short-circuit capabilities as *weak* grids, irrespectively from their level of inertia.

A common approach for control design in grid-connected VSC is the use of the so-called dq controllers, i.e., control architectures that structurally rely on a suitably defined synchronous rotating frame, whose reference angle dictates the mode of operation of the VSC [8]. Whenever the reference angle is selected to synchronize up to a given phase shift (*follow*), with the grid angle, the VSC is said to operate in *grid-following* mode; whenever it is designed (*formed*) via a suitably defined frequency control loop, the VSC is said to operate in *grid-forming* mode [9]. While for the grid-forming mode of operation a variety of strategy have been proposed requiring only knowledge of the grid frequency, for the grid-following mode information about the grid angle remains critical. Since this information remains inaccessible to the system operator, an appropriate algorithm must be developed to estimate this signal. Traditional design relies on the use of phase-locked loops (PLLs) mechanisms [10]. Nevertheless, in weak grids subject to substantial voltage fluctuations, ensuring a stable reference angle for the PLL becomes considerably complex, since the varying voltage levels during disturbances can cause fluctuations in the frequency and phase angle estimates, disrupting the ability of the PLL to provide a synchronous reference frame. Consequently, hierarchical controllers that relies on this rotating frame may be prone to instability.

In literature numerous solutions to address the challenges posed by weak grids have been proposed. A possible approach involves refining the operation of the PLL to maintain stability. This requires careful adjustments of the PLL and dq controller gains to ensure stability. Traditionally, the power electronics community addressed this problem by analysing the small-signal model of the grid-connected VSC, see [11] and references therein for an overview. This strategy has inherent limitations as it is either built upon a small-signal analysis of the system. Consequently, it remains valid only

Wei He and Jiacheng Yan are with Jiangsu Collaborative Innovation Center of Atmospheric Environment and Equipment Technology (CICAET), Nanjing University of Information Science and Technology, Nanjing 210044, China.

Romeo Ortega is with the Departamento Académico de Sistemas Digitales, ITAM, Rio Hondo 1, Col. Progreso Tizapan, 01080 Ciudad de México, Mexico.

Daniele Zonetti is with the Centre d'Innovació Tecnològica en Convertidors Estàtics i Accionaments, Departament d'Enginyeria Elèctrica, Universitat Politècnica de Catalunya, Barcelona 08028, Spain.

in close proximity to equilibrium conditions. More recently, Lyapunov-based analysis based on a time-scale separation between the current controller dynamics and the PLL have been proposed [12], [13]. While these analysis provide further insights on the selection of the PLL gains, the results lead to conservative, local stability certificates whose applicability is highly questionable. Alternative approaches are based on the re-design of outer control loops, which in normal conditions would operate at a much slower time-scale [14]. In these approaches, the outer loops are brought closer in timescale to the PLL's operation. The purpose is to step in and enforce stability when the PLL is susceptible to failure due to voltage fluctuations. These strategies often rely on intuitive power system knowledge and insights. Yet, the overall effectiveness and reliability of these approaches raise questions about their overall practical applicability.

In a recent paper [1], we presented an adaptive solution for the synchronization of a grid-connected VSC, enhancing the standard PLL design based on a dq transformation of the system dynamics. More precisely, we proposed to complement the conventional synchronization scheme with an *observer* that reconstructs the dq voltage behind the grid impedance—an information that is next provided to a PLL to ensure synchronization. To solve this problem at hand we proposed in that paper a novel approach that combines recently developed and more conventional techniques in estimation theory: the generalized parameter-based estimation observer (GPEBO) technique is used to derive a linear regressor equation (LRE) needed for the estimation of the grid voltage; a classical least-squares estimator [15]–[17] (LS)—improved with a forgetting factor (FF) mechanism—is used to estimate such a voltage; a conventional PLL is applied to the estimated voltage to recover the grid phase. Significantly, we showed that under some classical *persistence of excitation* assumption, the proposed solution guarantees almost global convergence of the system's solutions—a result that, as already mentioned, should be contrasted with local stability results available in literature.

In this context, the present paper aims thus to substantiate the theoretical results obtained in [1] with practical experiments. The remainder of the paper is organized as follows. In Section II, to place our contribution in context, we first review the standard solutions to the grid synchronization problem. The main result is given in Section III, where we present our proposed observer-based approach. Some illustrative simulation results are presented in Section IV-A while experimental results are given in Section IV-B. We wrap-up the paper with concluding remarks and future research in Section V.

**Notation.** The symbols  $\mathbb{N}_+$ ,  $\mathbb{R}_+$  denote the sets of positive integers and positive real numbers respectively, and  $\mathbb{S}$  is the unit circle in  $\mathbb{R}^2$ . Given  $n \in \mathbb{N}_+$ ,  $q \in \mathbb{N}_+$ ,  $\mathbb{I}_n$  is the  $n \times n$  identity matrix and  $\mathbf{0}_{n \times q}$  is an  $n \times q$  matrix of zeros.  $\mathbf{e}_q \in \mathbb{R}^n$  denotes the  $q$ -th vector of the  $n$ -dimensional Euclidean basis. For  $x \in \mathbb{R}^n$ , we denote the square of the Euclidean norm as  $|x|^2 := x^\top x$ . Given  $J := \begin{bmatrix} 0 & -1 \\ 1 & 0 \end{bmatrix}$  and  $\alpha \in \mathbb{R}$  we define the rotation matrix as  $e^{J\alpha} = \begin{bmatrix} \cos(\alpha) & -\sin(\alpha) \\ \sin(\alpha) & \cos(\alpha) \end{bmatrix}$ .  $\text{atan2} : \mathbb{S} \rightarrow [-\pi \ \pi)$  denotes the 2-arguments arctangent function. Given

a differentiable signal  $u(t)$ , we define the derivative operator  $\mathbf{p}^i[u] := \frac{d^i u(t)}{dt^i}$  and denote the action of a linear time-invariant (LTI) filter  $F(\mathbf{p}) \in \mathbb{R}(\mathbf{p})$  as  $F[u]$ .

## II. GRID SYNCHRONIZATION PROBLEM AND STANDARD PLL SOLUTIONS

As indicated in the Introduction, the problem we address in this paper is the estimation of the angle of the grid voltage  $v_g(t) \in \mathbb{R}^3$ , which is in general *not measurable*, but assumed to be of the form

$$v_g = V_g \begin{bmatrix} \sin(\omega t) \\ \sin(\omega t - \frac{2}{3}\pi) \\ \sin(\omega t + \frac{2}{3}\pi) \end{bmatrix}, \quad (1)$$

where  $V_g \in \mathbb{R}_+$  and  $\omega \in \mathbb{R}_+$  denote the respectively the voltage amplitude and frequency of the grid, which are *both unknown*. A common assumption is that the grid voltage  $v_g$  only slightly differs from the voltage  $v$  at the PCC, which is *measurable*. Hence,  $v \approx v_g$ , meaning that the grid voltage can be considered as a signal *known* with good accuracy. Based on this assumption, the standard approach to accomplish the estimation task is to implement a PI controller that processes a *phase detector*, which is a signal containing information of the grid angle—this system is usually called a PLL, see [18]–[21] for tutorial introductions. Two widely popular schemes for the generation of the phase detector are the so-called synchronous reference frame (SRF) and the arctangent (ATAN)-PLL. Both of them rely on the transformation of the voltage (1) to dq coordinates via the well-known matrix rotation  $T_{\text{dq}}$  [22, eq. (2.3)] using a (designer chosen) rotation angle  $\vartheta$ —which plays the role of an *estimate* of the grid phase. That is, we define the new signals

$$v_{\text{dq}} := T_{\text{dq}} \left( \vartheta - \frac{\pi}{2} \right) v$$

that, in view of the aforementioned assumption, yields the rotated grid voltage

$$v_{\text{dq}} \approx v_{g\text{dq}} = V_g \begin{bmatrix} \cos(\phi) \\ \sin(\phi) \end{bmatrix}, \quad (2)$$

where we defined the *error signal*  $\phi(t) \in \mathbb{R}$  as

$$\phi := \vartheta - \omega t. \quad (3)$$

In the SRF-PLL the phase detector is the second component of the vector  $v_{\text{dq}}$ , and this signal is fed to the PI. The output of the PI, is viewed as an estimate of the unknown grid frequency, denoted  $\hat{\omega}$ . In the ATAN-PLL the phase detector is generated computing the arctangent of the error signal  $\phi$ , via the  $\text{atan2}$  function, as shown in Fig. 1. In both schemes, the output of the PI is integrated to generate an estimate of the grid phase  $\vartheta$ , that is used as the argument of the rotation matrix—see Fig. 1. Interestingly, in spite of the highly nonlinear dynamical systems that describe their behavior, it is possible to show *almost global stability* of both PLLs [12], [23], [24]. Unfortunately, the assumption of negligible difference between the grid voltage and the voltage at the PCC falls short in the case of weak grids, posing questions about the ability of the PLL to guarantee stability in these conditions.

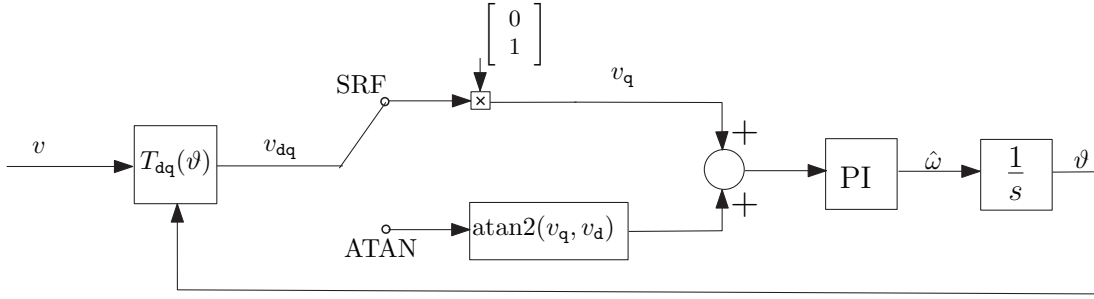

Fig. 1. Block diagram representation of the SRF- and ATAN-PLL schemes.

### III. AN OBSERVER-BASED SYNCHRONIZATION METHOD

Similarly to the SRF- or ATAN-PLL schemes described above, the adaptive PLL that we consider in this paper, which was proposed in [1], also implements a rotation of the grid voltage as (7) and uses the PI+integration feedback structure of Fig. 1, but *generates* the phase detector in a radically different way. Indeed, the problem of generation of an estimate of the error signal  $\phi$  is posed as an *adaptive observer* design task. Towards this end, we look at the dynamics of the whole system, comprising a three-phase, balanced two-level VSC interfaced to the balanced AC grid—modeled using the Thevenin equivalent (TE) circuit. The overall model of the system is given as

$$\begin{aligned} L_g \dot{i}_g &= -r_g i_g + v - v_g \\ L \dot{i} &= -ri + V_{dc} m - v \\ C \dot{v} &= -i_g + i, \end{aligned} \quad (4)$$

where  $v_g(t) \in \mathbb{R}^3$  is the voltage of the grid assumed to be of the form (1), with  $V_g \in \mathbb{R}_+$  and  $\omega \in \mathbb{R}_+$  *unknown*. The *measurable* state variables  $i_g(t) \in \mathbb{R}^3$ ,  $i(t) \in \mathbb{R}^3$  and  $v(t) \in \mathbb{R}^3$  denote the current of the grid, the current through the phase reactor and the AC voltage at the PCC, respectively,  $V_{dc} \in \mathbb{R}_+$  is the *known constant* DC voltage and  $m(t) \in \mathbb{R}^3$  are the modulation indices. The positive parameters  $L$ ,  $r$ ,  $L_g$ ,  $r_g$  and  $C$  are, respectively, the inductance and resistance of the phase reactor, the inductance and resistance associated to the grid and the capacitance of the filter—with  $L_g$  and  $r_g$  *known*.

In [1] it is proposed to represent the system dynamics (4) in a dq reference frame with a transformation angle  $\vartheta$ , generated by

$$\dot{\vartheta} = u_1$$

with  $u_1(t) \in \mathbb{R}$  a signal *to be defined* such that

$$\lim_{t \rightarrow \infty} \vartheta(t) = \omega t + \phi^{\text{ref}} \quad (5)$$

is ensured—where, for the sake a generality, we have added the constant  $\phi^{\text{ref}}$ , which is a user selected constant phase shift. That is, we define the new signals

$$(\cdot)_{\text{dq}} := T_{\text{dq}} \left( \vartheta - \frac{\pi}{2} \right) (\cdot)_{\text{abc}},$$

with the definition of  $T_{\text{dq}}$  given in [22, eq. (2.3)]. This operation yields the system dynamics

$$\begin{aligned} \begin{bmatrix} L_g \dot{i}_{gdq} \\ C \dot{v}_{dq} \\ L \dot{i}_{dq} \end{bmatrix} &= \begin{bmatrix} -r_g \mathbb{I}_2 & \mathbb{I}_2 & \mathbf{0}_{2 \times 2} \\ -\mathbb{I}_2 & \mathbf{0}_{2 \times 2} & \mathbb{I}_2 \\ \mathbf{0}_{2 \times 2} & -\mathbb{I}_2 & -r \mathbb{I}_2 \end{bmatrix} \begin{bmatrix} i_{gdq} \\ v_{dq} \\ i_{dq} \end{bmatrix} \\ &+ \begin{bmatrix} L_g J i_{gdq} & \mathbf{0}_{2 \times 2} \\ C J v_{dq} & \mathbf{0}_{2 \times 2} \\ L J i_{dq} & \mathbb{I}_2 \end{bmatrix} \begin{bmatrix} u_1 \\ u_2 \\ u_3 \end{bmatrix} + \begin{bmatrix} -v_{gdq} \\ \mathbf{0}_{2 \times 1} \\ \mathbf{0}_{2 \times 1} \end{bmatrix} \end{aligned} \quad (6)$$

where we defined the new control signal

$$\begin{bmatrix} u_2 \\ u_3 \end{bmatrix} := V_{dc} m_{dq},$$

and the rotated grid voltage (2) that, to simplify the future calculations, we rewrite as

$$v_{gdq} := V_g e^{J\phi} \mathbf{e}_1, \quad (7)$$

where  $\phi \in \mathbb{R}$  is the *error signal* defined in (3). This signal, which is of course *unknown*, satisfies the dynamic equation

$$\dot{\phi} = -\omega + u_1.$$

Moreover, the signal  $v_{gdq}$  given in (7), that we treat as an *unmeasurable state*, satisfies the differential equation

$$\begin{aligned} \dot{v}_{gdq} &= \dot{\phi} J v_{gdq} \\ &= -\omega J v_{gdq} + u_1 J v_{gdq}. \end{aligned}$$

Therefore, considering (3), we see that the synchronization objective (5) can be recast as follows.

**SO** Select the “control signal”  $u_1$  to ensure that the unmeasurable state  $v_{gdq}$  satisfies

$$\lim_{t \rightarrow \infty} v_{gdq}(t) = V_g e^{J\phi^{\text{ref}}} \mathbf{e}_1. \quad (8)$$

To solve this problem we design an *adaptive observer* for the state  $v_{gdq}$ , which is given in Proposition 1 below.

To streamline the presentation of this result we find convenient to rewrite the system using the standard control theory notation, defining the *unmeasurable* state  $x(t) \in \mathbb{R}^2$ , the *measurable* state  $y(t) \in \mathbb{R}^6$  and the input vector  $u(t) \in \mathbb{R}^3$  as

$$x := \frac{1}{L_g} v_{gdq}, \quad y := \begin{bmatrix} i_{gdq} \\ v_{dq} \\ i_{dq} \end{bmatrix},$$

respectively, and write the system dynamics as

$$\dot{y} = \begin{bmatrix} -\frac{r_g}{L_g}\mathbb{I}_2 & \frac{1}{L_g}\mathbb{I}_2 & \mathbf{0}_{2 \times 2} \\ -\frac{1}{C}\mathbb{I}_2 & \mathbf{0}_{2 \times 2} & \frac{1}{C}\mathbb{I}_2 \\ \mathbf{0}_{2 \times 2} & -\frac{1}{L}\mathbb{I}_2 & -\frac{r}{L}\mathbb{I}_2 \end{bmatrix} y + \begin{bmatrix} Jy_{1,2} & \mathbf{0}_{2 \times 2} \\ Jy_{3,4} & \mathbf{0}_{2 \times 2} \\ Jy_{5,6} & \frac{1}{L}\mathbb{I}_2 \end{bmatrix} u + \begin{bmatrix} -x \\ \mathbf{0}_{2 \times 1} \\ \mathbf{0}_{2 \times 1} \end{bmatrix}, \quad (9)$$

where the unknown state  $x$ , to be reconstructed, satisfies the differential equation

$$\dot{x} = -\omega Jx + u_1 Jx. \quad (10)$$

The proposition below describes in detail the structure of the proposed adaptive PLL and enunciates its stability properties. Its construction is based on GPEBO technique.

*Proposition 1:* Consider the grid-connected VSC system (4) and its dq representation (9), (10). Define the dynamic extension

$$\begin{aligned} \dot{z} &= u_1 Jz - \frac{r_g}{L_g} J \begin{bmatrix} y_1 \\ y_2 \end{bmatrix} + \frac{1}{L_g} J \begin{bmatrix} y_3 \\ y_4 \end{bmatrix} \\ \dot{\Phi} &= u_1 J\Phi, \quad \Phi(0) = \mathbb{I}_2, \end{aligned}$$

and introduce the signals

$$\begin{aligned} \mathbf{Y} &:= \mathbf{p}F(\mathbf{p}) \begin{bmatrix} y_1 \\ y_2 \end{bmatrix} - F(\mathbf{p}) \left[ \left( u_1 J - \frac{r_g}{L_g} \mathbb{I}_2 \right) \begin{bmatrix} y_1 \\ y_2 \end{bmatrix} + \frac{1}{L_g} \begin{bmatrix} y_3 \\ y_4 \end{bmatrix} \right] \\ \mathbf{\Omega} &:= -F(\mathbf{p}) \begin{bmatrix} -z + J \begin{bmatrix} y_1 \\ y_2 \end{bmatrix} \\ \Phi \end{bmatrix}, \end{aligned}$$

where  $F(\mathbf{p}) = \frac{\lambda}{\mathbf{p} + \lambda}$ ,  $\lambda > 0$ , is an LTI filter. Define the estimate of the state  $x$  as

$$\hat{x} = \begin{bmatrix} -z + J \begin{bmatrix} y_1 \\ y_2 \end{bmatrix} \\ \Phi \end{bmatrix} \hat{\theta}, \quad (11)$$

where  $\hat{\theta}$  is generated by the least-squares parameter estimator

$$\dot{\hat{\theta}} = \alpha F \mathbf{\Omega}^\top (\mathbf{Y} - \hat{\mathbf{\Omega}} \hat{\theta}), \quad \hat{\theta}(0) \in \mathbb{R}^3 \quad (12)$$

$$\dot{F} = \begin{cases} -\alpha F \mathbf{\Omega}^\top \mathbf{\Omega} F + \beta F & \text{if } \|F\| \leq M \\ 0 & \text{otherwise} \end{cases} \quad (13)$$

with  $F(0) = \frac{1}{f_0} I_3$  and tuning gains  $\alpha > 0$ ,  $f_0 > 0$ ,  $\beta \geq 0$  and  $M > 0$ . Define the adaptive PLL as

$$\begin{aligned} \dot{x}_c &= e_\phi(\hat{x}) \\ u_1 &= -K_P e_\phi(\hat{x}) - K_I x_c, \end{aligned} \quad (14)$$

with gains  $K_P > 0$ ,  $K_I > 0$  and the phase detector  $e_\phi(\hat{x})$  chosen in either one of the forms

$$\begin{aligned} e_\phi(\hat{x}) &= -\cos(\phi^{\text{ref}}) \hat{x}_2 + \sin(\phi^{\text{ref}}) \hat{x}_1, \\ \text{or } e_\phi(\hat{x}) &= -\text{atan2}(\hat{x}_2, \hat{x}_1) + \phi^{\text{ref}}, \end{aligned} \quad (15)$$

corresponding (with  $\hat{x} = x$ ) to an SRF-PLL or ATAN-PLL, respectively.<sup>1</sup> Assume the vector  $\mathbf{\Omega}$  is persistently exciting, that is there exists constants  $C_c > 0$  and  $T > 0$  such that

$$\int_t^{t+T} \mathbf{\Omega}^\top(s) \mathbf{\Omega}(s) ds \geq C_c I_3, \quad \forall t \geq 0.$$

<sup>1</sup>Conventional SRF- and ATAN-PLL aligned with the q axis can be recovered by picking  $\phi^{\text{ref}} = 0$ .

Under these conditions, the synchronization objective (8) is achieved for almost all system and controller initial conditions—guaranteeing that all signals remain bounded. □□□

Note that the signal  $m_{dq}$  is designed as a classical PI dq current controller given in [1, (27)], which is omitted here. The detailed proof of above proposition is given in [1, Section III]. We omit them here.

The structure of the proposed observer is shown in Fig.2. Besides, a block diagram representation of the whole system, including the proposed adaptive PLL is given in Fig. 3.

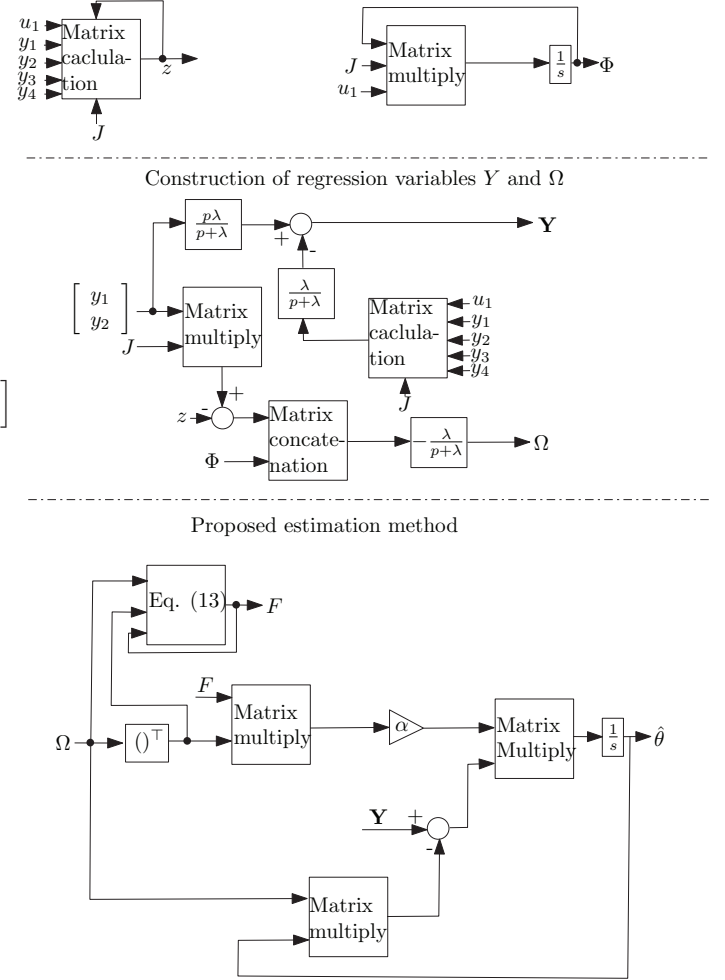

Fig. 2. The structure of the proposed estimation method.

## IV. SIMULATION AND EXPERIMENTAL RESULTS

### A. Simulation results

To validate the theoretical results we consider  $P^{\text{ref}}=600$  W, voltage reference  $V^{\text{ref}}=380$  V, and the frequency  $f = 50$  Hz. Then,  $\omega = 2\pi f$ . The experimental parameters are shown in Tabs. I and II.

Based on the classical power flow equations, references for the dq currents and phase shift reference  $\phi^{\text{ref}}$ —which are provided to the dq controller and PLL respectively—are calculated from the active power reference  $P^{\text{ref}}$  and voltage

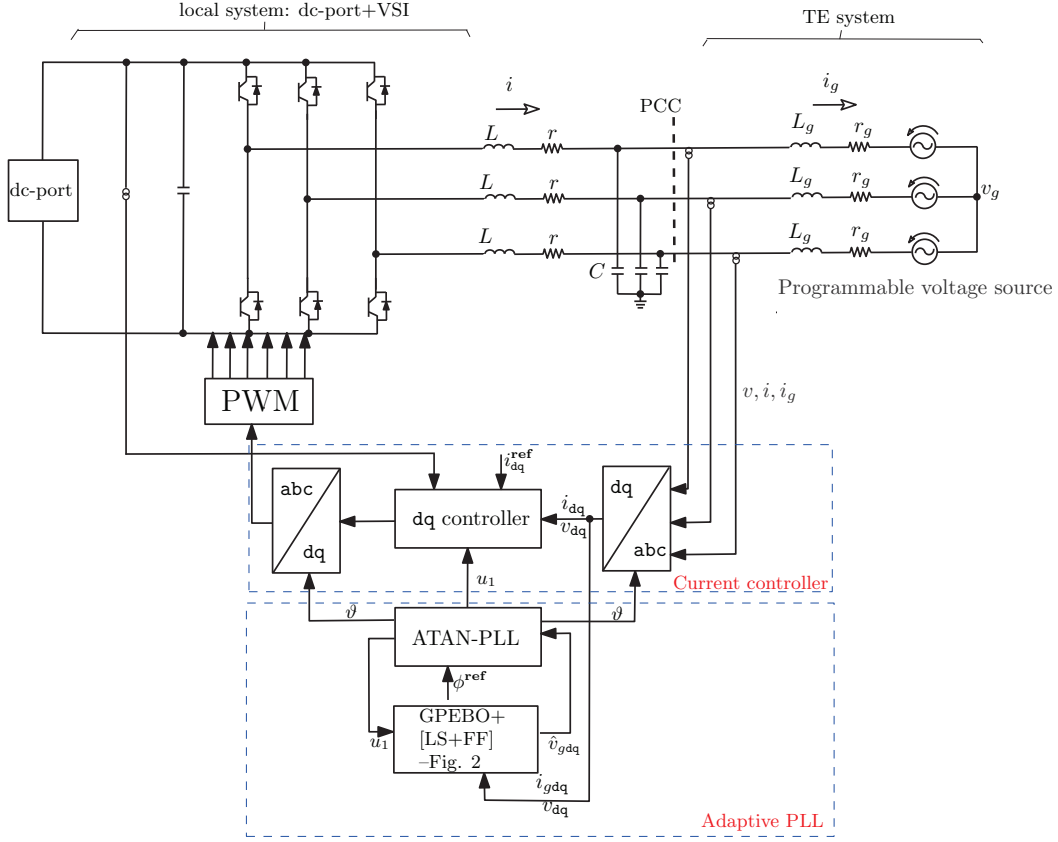

Fig. 3. Block diagram representation of the system (9) and the proposed control scheme.

reference  $V^{\text{ref}}$ . It is noted that the calculation of power flow equations is done under nominal conditions in the simulation and experiment studies. This is to say that the parameters shown in Tabs. I and II are adopted for the calculation of power flow equations and the calculation results for the references will be fixed for different test scenarios. In the design we consider the current controller, together with the adaptive PLL where the estimated parameters  $\hat{\theta}$  are generated via the observer. The gains of the adaptive PLL are set to  $K_{P\phi} = 200$ ,  $K_{I\phi} = 5000$ , while the gains of the current controller are set, for both the d and q axis, to  $K_P = 1250$ ,  $K_I = 50000$ . The gains of the LS+FF are, on the other hand, set to  $\lambda = 1000$ ,  $\alpha = 600$ ,  $\beta = 500$ ,  $M = 100$ ,  $f_0 = 1$ .

TABLE I  
VSC PARAMETERS.

Parameter	Value
$f$	50 Hz
$C$	4.6 $\mu\text{F}$
$L$	9.5 mH
$r$	0.64 $\Omega$

We evaluate both nominal and perturbed scenarios, illustrating the responses of the directly controlled variables, i.e. the dq currents  $i_{dq}$  and of the phase shift  $\phi = \vartheta - \omega t$ . In the simulation and experiment results, we will show the angle  $\varphi$  (degree) corresponding to the  $\phi$  (radian), where  $\varphi = \frac{180\phi}{\pi}$ .

Firstly, we evaluate the ability of the proposed solution PEBO-ATAN-PLL to track variations in the active power pro-

TABLE II  
VARIABLE POWER SOURCE.

Parameter	Value
$L_g$	282 mH
$r_g$	12.8 $\Omega$
$V_g$	310.2687 V

file, while keeping the voltage at the nominal value  $V^{\text{ref}} = 380$  V. In particular, we consider a variation in the active power reference from  $P_1^{\text{ref}} = 300$  W to  $P_2^{\text{ref}} = 600$  W (from half to full rated value). The dq currents  $i_{dq}$  and the angle  $\varphi$  responses are illustrated in Fig. 4. It is observed that the corresponding references are tracked within 200 ms. Besides, we carry out a comparison between the proposed adaptive PEBO-ATAN-PLL and conventionally non-adaptive ATAN-PLL. The gains are same for two schemes. The simulation result is shown in Fig. 5. It is seen that the angle  $\varphi$  is unstable and dq currents responses contain obvious oscillation in the voltage  $V_g$  with a step change in at  $t = 1.5$  s for conventional PLL, which shows a poor control performance.

For the validation in perturbed conditions, the active power is supposed to be equal to the VSC rated value of 600 W, maintaining the voltage to the nominal value  $V^{\text{ref}} = 380$  V. Then, an abrupt variation of the frequency  $f$ , stepping up from 50 Hz to 52 Hz, is supposed to occur but for the calculation of power flow equations it has always been 50 Hz. Hence, the references are unchanged when a step change in  $f$  is

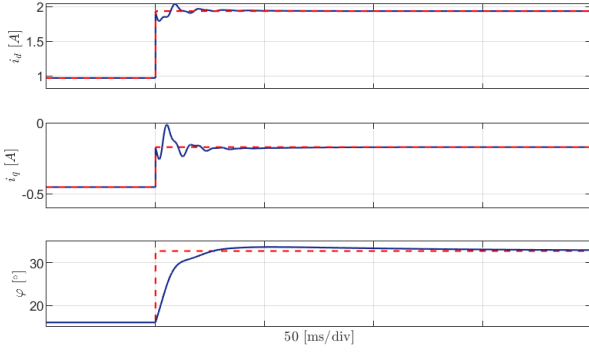

Fig. 4. Responses of dq currents and angle  $\varphi$ , facing an active power step variation from  $P_1^{\text{ref}}$  to  $P_2^{\text{ref}}$ .

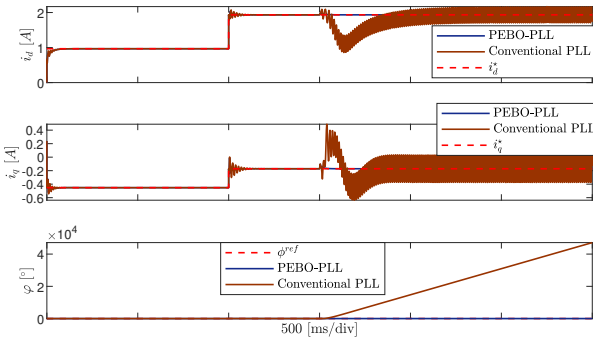

Fig. 5. Responses of dq currents and angle  $\varphi$ , facing an active power step variation from  $P_1^{\text{ref}}$  to  $P_2^{\text{ref}}$  and a step change in  $V_g$  under both proposed PEBO-PLL and conventional PLL schemes.

considered. It can be observed from Fig. 6 that the frequency variation is properly tracked, preserving stability of the overall system, with negligible fluctuations in the responses of the dq currents  $i_{dq}$ . Similarly, we illustrate performances of the proposed solution in presence of an abrupt 20% variation of the grid voltage amplitude  $V_g$ , stepping up from 310.2687 V to 248.215 V but for the calculation of power flow equations it has always been 310.2687 V. Hence, the references are unchanged when a step change in  $V_g$  is considered. The responses of the dq currents  $i_{dq}$  and angle  $\varphi$  are shown in Fig. 7. It can be observed that after small transients, both dq currents and angle  $\varphi$  are quickly restored to their reference values.

### B. Experimental results

In this section experimental results are illustrated to further validate the effectiveness of the proposed solution. A schematic of the experimental setup with pictures of the hardware components is given in Fig. 8. The experimental parameters are the same adopted for simulations—see Tabs. I and II. Moreover, the setting of experiment scheme and test scenarios are same with them of the simulation.

The real time control of the VSC is implemented via a STM32F407VGT6 microcontroller where, as for simulations,

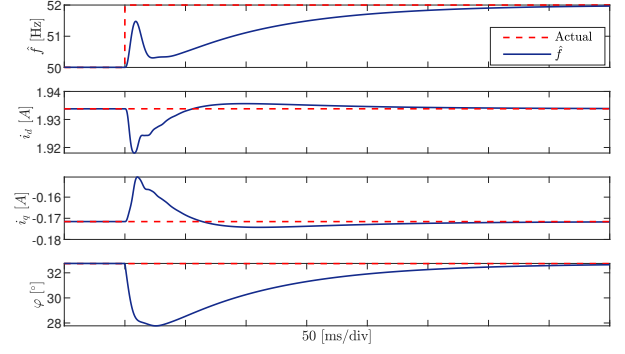

Fig. 6. Responses of dq currents and angle  $\varphi$ , facing a frequency step variation of 2 Hz.

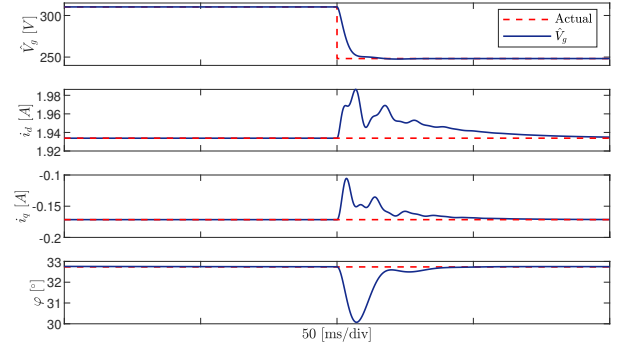

Fig. 7. Responses of dq currents and angle  $\varphi$ , facing a voltage amplitude step variation of 20%.

the conversion from the abc to the dq frame is realized via the angle  $\vartheta$  determined by the proposed adaptive PLL. The overall architecture employs voltage and current measurements obtained via dedicated sensors. In particular, the scheme described in Fig. 3 requires the read of the current of the output filter via the LEM-100P current sensor, its transformation in dq coordinates, and the comparison with the corresponding reference value, a procedure that allows for the calculation of the current regulation error to be fed to the microcontroller. On the other hand, the output voltage of the converter is read by resistive division and compared with the variable reference value. By using this approach to measure the voltage, it is possible to isolate and amplify the sampled voltage (in the range of  $\pm 250$  mv) through AMC1301, and then bring it to the range of 0 to 3.3 through OPAMP-based signal conditioning stage. An isolated DC-DC converter manufactured by CUI INC named PDQE15-Q24-S15-D with an output of 15 V and a current of 1 A is adopted to provide isolated voltage for feeding electronic circuits. The LM2575 switching regulator is used in this board to provide 5 V power supply for electronic circuits. Also, for hardware overcurrent protection, the amplified voltage is compared with the final current limit through a comparator TLC372 and, in case of overcurrent, the OCP command cuts off the input of the board. The IGBTs of the employed VSC are characterized by a voltage of 1200 V and a current of 40 A. The HCPL3120 gate drives are used to turn on the switches with a voltage of 15 V and turn them off with a voltage of  $-5$  V. The maximum input voltage is

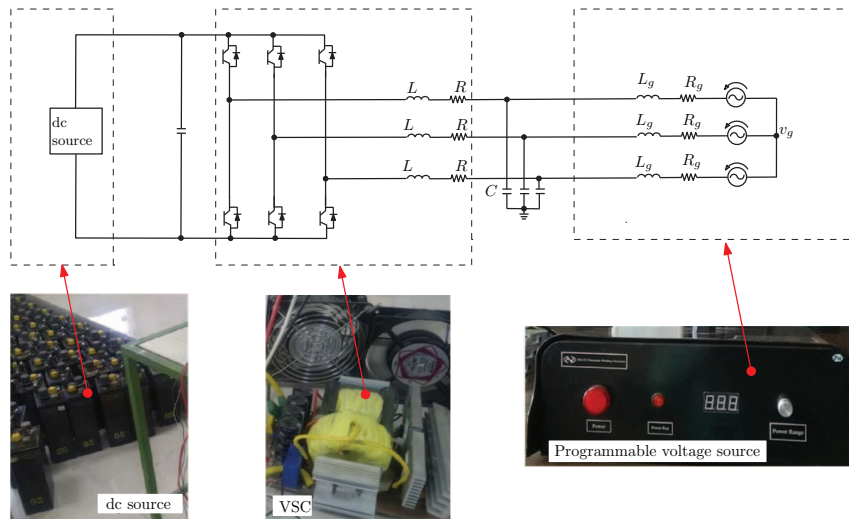

Fig. 8. Schematic of experimental setup with pictures of hardware components.

considered to 1000 V and the time is equal to  $16 \mu\text{s}$ , and a switching frequency of about 30 kHz. The battery set is the GS-Yuasa HS-200 series.

As for simulations, we consider a step change in the desired power, stepping from  $P_1^{\text{ref}}$  to  $P_2^{\text{ref}}$ , assuming that  $V^{\text{ref}}$  is fixed at 380 V. The experimental results are shown in Figs. 9 and 10. It is observed that the corresponding references are tracked within 0.2 s, a result that is consistent to the results observed in simulations.

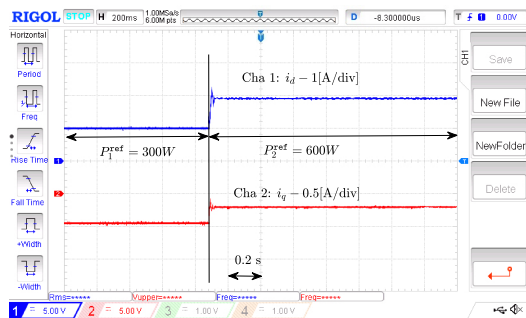

Fig. 9. Responses of dq currents, facing an active power step variation from  $P_1^{\text{ref}}$  to  $P_2^{\text{ref}}$ .

Then, the desired power is set to 600 W, with voltage  $V^{\text{ref}}$  maintained at 380 V. A change in  $f$  is thus imposed, stepping from 50 Hz to 52 Hz. This contributes to assess the performance of designed observer under frequency variation. It is seen from Figs. 11 and 12 that although there is an abrupt variation of the frequency, its perturbed value is rapidly estimated via the observer, ensuring that the dq current control objective is still guaranteed after reasonable transients. The estimate of  $f$  is illustrated in Fig. 13.

Finally, we validate the ability of the observer to accurately reconstruct the information of the grid voltage amplitude  $V_g$  in case of a voltage perturbation. A step change in  $V_g$  is therefore considered, in which its 20% variation is faced. This test case is same with the simulation study. The responses of the dq

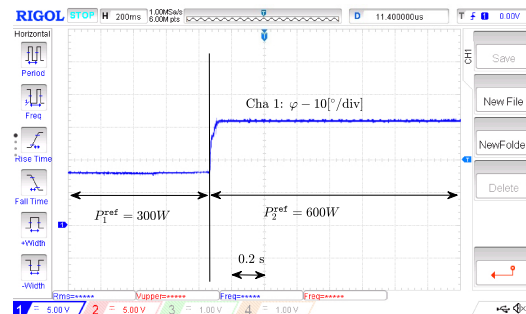

Fig. 10. Response of angle  $\varphi$ , facing an active power step variation from  $P_1^{\text{ref}}$  to  $P_2^{\text{ref}}$ .

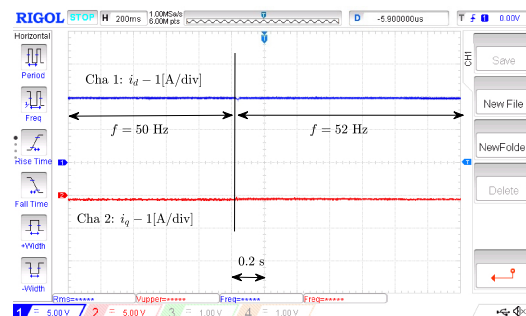

Fig. 11. Responses of dq currents, facing a frequency step variation of 2 Hz.

currents  $i_{dq}$  and angle  $\varphi$  are shown in Figs. 14 and 15. It is seen that they are quickly restored to their desired values after reasonably small transients, demonstrating robust performance of the solutions. The estimate of  $V_g$  is illustrated in Fig. 16, where it is shown that the perturbed value of the voltage is rapidly estimated.

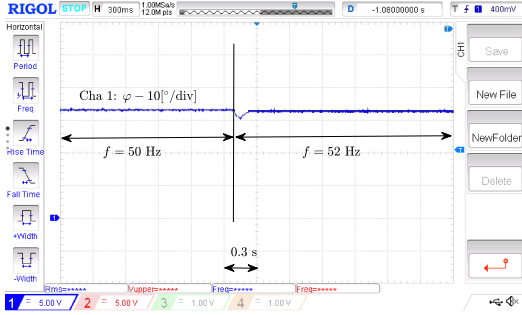

Fig. 12. Response of angle  $\varphi$ , facing a frequency step variation of 2 Hz.

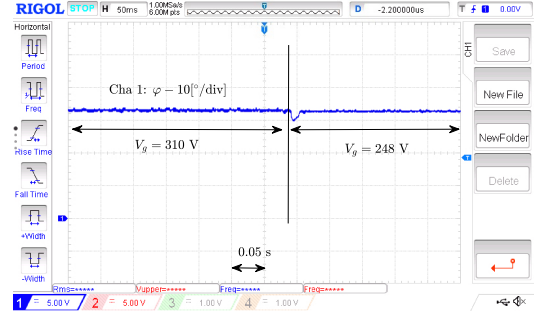

Fig. 15. Response of angle  $\varphi$ , facing a voltage amplitude step variation of 20%.

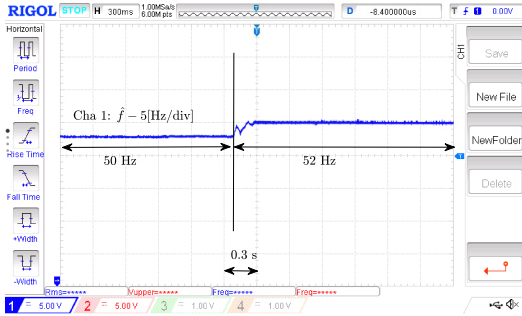

Fig. 13. Response of the estimate of  $f$ , facing a frequency step variation of 2 Hz.

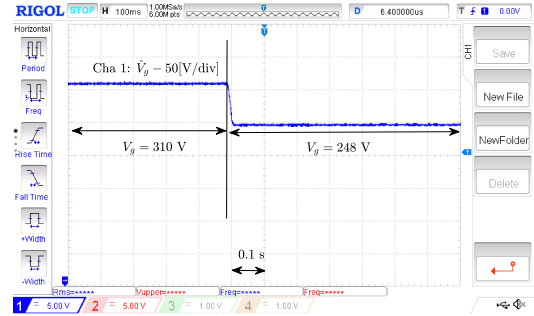

Fig. 16. Response of the estimate of  $V_g$ .

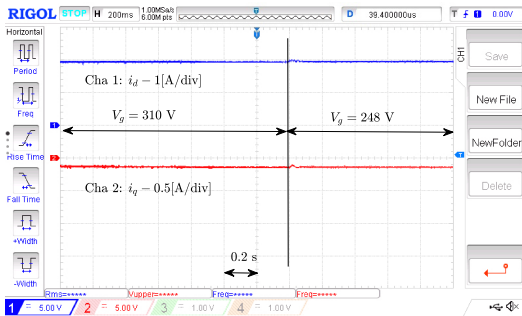

Fig. 14. Responses of dq currents, facing a voltage amplitude step variation 20%.

## V. CONCLUDING REMARKS

In this paper we addressed the problem of synchronization of grid-connected VSCs. The work is built upon the observer-based adaptive PLL solution proposed in [1] and provided experimental validation of this innovative approach, via the realization of a comprehensive series of experiments. Through these experiments, we bridge the gap between theoretical expectations and practical outcomes, finally demonstrating the adaptability and robustness of our design. In the future work, we intend to introduce the estimated terms to the calculation of power flow equations. Note that the observer dynamics obviously affects the control performance. In this version, we only consider the nominal conditions.

## REFERENCES

- [1] D. Zonetti, A. Bobtsov, R. Ortega, N. Nikolaev, and O. Gomis-Bellmunt, "An almost globally stable adaptive phase-locked loop for synchronization of a grid-connected voltage source converter," *arXiv preprint arXiv:2201.05490*, 2022.
- [2] B. K. Bose, *Power electronics in renewable energy systems and smart grid: technology and applications*. John Wiley & Sons, 2019.
- [3] N. Hoffmann and F. W. Fuchs, "Minimal invasive equivalent grid impedance estimation in inductive-resistive power networks using extended kalman filter," *IEEE Transactions on Power Electronics*, vol. 29, no. 2, pp. 631–641, 2013.
- [4] B. Mirafzal, "Survey of fault-tolerance techniques for three-phase voltage source inverters," *IEEE Transactions on Industrial Electronics*, vol. 61, no. 10, pp. 5192–5202, 2014.
- [5] F. Cecati, R. Zhu, S. Pugliese, M. Liserre, and X. Wang, "State feedback reshaping control of voltage source converter," *IEEE Transactions on Power Electronics*, vol. 37, no. 12, pp. 14 280–14 293, 2022.
- [6] G. Wu, H. Sun, X. Zhang, A. Egea-Álvarez, B. Zhao, S. Xu, S. Wang, and X. Zhou, "Parameter design oriented analysis of the current control stability of the weak-grid-tied vsc," *IEEE Transactions on Power Delivery*, vol. 36, no. 3, pp. 1458–1470, 2020.
- [7] A. Egea-Álvarez, S. Fekriasi, F. Hassan, and O. Gomis-Bellmunt, "Advanced vector control for voltage source converters connected to weak grids," *IEEE Transactions on Power Systems*, vol. 30, no. 6, pp. 3072–3081, 2015.
- [8] M. Davari and Y. A.-R. I. Mohamed, "Robust vector control of a very weak-grid-connected voltage-source converter considering the phase-locked loop dynamics," *IEEE Transactions on Power Electronics*, vol. 32, no. 2, pp. 977–994, 2016.
- [9] F. Milano, F. Dörfler, G. Hug, D. J. Hill, and G. Verbič, "Foundations and challenges of low-inertia systems," in *Power Systems Computation Conference (PSCC)*. IEEE, 2018, pp. 1–25.
- [10] D. Abramovitch, "Phase-locked loops: A control centric tutorial," in *Proceedings of the 2002 American control conference*, vol. 1. IEEE, 2002, pp. 1–15.
- [11] J. Z. Zhou, H. Ding, S. Fan, Y. Zhang, and A. M. Gole, "Impact of short-circuit ratio and phase-locked-loop parameters on the small-



- signal behavior of a vsc-hvdc converter," *IEEE Transactions on Power Delivery*, vol. 29, no. 5, pp. 2287–2296, 2014.
- [12] M. Z. Mansour, S. P. Me, S. Hadavi, B. Badrzadeh, A. Karimi, and B. Bahrani, "Nonlinear transient stability analysis of phased-locked loop-based grid-following voltage-source converters using lyapunov's direct method," *IEEE Journal of Emerging and Selected Topics in Power Electronics*, vol. 10, no. 3, pp. 2699–2709, 2021.
- [13] J. Zhao, M. Huang, H. Yan, K. T. Chi, and X. Zha, "Nonlinear and transient stability analysis of phase-locked loops in grid-connected converters," *IEEE Transactions on Power Electronics*, vol. 36, no. 1, pp. 1018–1029, 2020.
- [14] X. Wang, M. G. Taul, H. Wu, Y. Liao, F. Blaabjerg, and L. Harnefors, "Grid-synchronization stability of converter-based resources—an overview," *IEEE Open Journal of Industry Applications*, vol. 1, pp. 115–134, 2020.
- [15] L. Ljung, "System identification: Theory for the user," *Prentice Hall, New Jersey*, 1987.
- [16] S. Sastry, M. Bodson, and J. F. Bartram, *Adaptive control: stability, convergence, and robustness*. Acoustical Society of America, 1990.
- [17] G. Tao, *Adaptive control design and analysis*. John Wiley & Sons, 2003, vol. 37.
- [18] S.-K. Chung, "Phase-locked loop for grid-connected three-phase power conversion systems," *IEE Proceedings-Electric Power Applications*, vol. 147, no. 3, pp. 213–219, 2000.
- [19] I. Collins, "Phase-locked loop (pll) fundamentals," *SSB*, vol. 130, no. 140, p. 150, 2018.
- [20] R. Teodorescu, M. Liserre, and P. Rodriguez, *Grid converters for photovoltaic and wind power systems*. John Wiley & Sons, 2011.
- [21] A. Yazdani and R. Iravani, *Voltage-sourced converters in power systems: modeling, control, and applications*. John Wiley & Sons, 2010.
- [22] J. Schiffer, D. Zonetti, R. Ortega, A. M. Stanković, T. Sezi, and J. Raisch, "A survey on modeling of microgrids—from fundamental physics to phasors and voltage sources," *Automatica*, vol. 74, pp. 135–150, 2016.
- [23] A. Rantzer, "Almost global stability of phase-locked loops," in *Proceedings of the 40th IEEE Conference on Decision and Control*, vol. 1. IEEE, 2001, pp. 899–900.
- [24] D. Zonetti, O. Gomis-Bellmunt, E. Prieto-Araujo, and M. Cheah-Mane, "Passivity-based design and analysis of phase-locked loops," in *European Control Conference*. IEEE, 2022, pp. 2075–2080.