

TWO INVOLUTIONS ON BINARY TREES AND GENERALIZATIONS

YANG LI, ZHICONG LIN, AND TONGYUAN ZHAO

ABSTRACT. This paper investigates two involutions on binary trees. One is the mirror symmetry of binary trees which combined with the classical bijection φ between binary trees and plane trees answers an open problem posed by Bai and Chen. This involution can be generalized to weakly increasing trees, which admits to merge two recent equidistributions found by Bai–Chen and Chen–Fu, respectively. The other one is constructed to answer a bijective problem on di-sk trees asked by Fu–Lin–Wang and can be generalized naturally to rooted labeled trees. This second involution combined with φ leads to a new statistic on plane trees whose distribution gives the Catalan’s triangle. Moreover, a quadruple equidistribution on plane trees involving this new statistic is proved via a recursive bijection.

1. INTRODUCTION

Plane trees and binary trees are two of the most fundamental objects in the garden of Catalan numbers [20, Chapter 1.5]. The main objective of this paper is to study two involutions on binary trees (or plane trees), their applications and generalizations. One is the mirror symmetry of binary trees and the other one is newly constructed, which was motivated by a bijective problem on di-sk trees.

Recall that a *plane tree* is a rooted tree in which the children of each node are linearly ordered. A node without any child is called a *leaf*, and an *internal node* otherwise. For a node v of a plane tree T , the *level of v* is the distance between v and the root of T , i.e., the number of edges in the unique path from v to the root. Let $\alpha(j_1, j_2, \dots, j_h)$ be the number of plane trees having j_i nodes in level i for $1 \leq i \leq h$. This number has the following neat binomial expression (see Flajolet [9] for a continued fraction proof):

$$\alpha(j_1, j_2, \dots, j_h) = \binom{j_1 + j_2 - 1}{j_1 - 1} \binom{j_2 + j_3 - 1}{j_2 - 1} \cdots \binom{j_{h-1} + j_h - 1}{j_{h-1} - 1}.$$

In the study of decompositions of 132-avoiding permutations, Bai and Chen [1] introduced a statistic, called the right spanning widths of nodes, on plane trees that is equally distributed as the levels of nodes. The *right spanning width of a node v* in a plane tree T , denoted $\text{rsw}_T(v)$, is the number of children of v plus the number of edges attached to other nodes (than v) on the path from v to the root from the right-hand side (of the path); see Fig. 1 for an illustration. Their result can be stated as below, which refines the well-known fact that leaves and internal nodes are equally distributed on plane trees.

Date: September 13, 2023.

Key words and phrases. Binary trees; Plane trees; Involutions; Bijections; Weakly increasing trees; Rooted labeled trees.

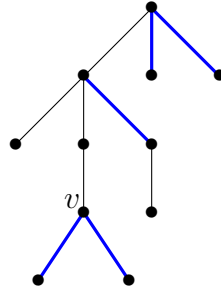

FIGURE 1. The right spanning width of v is 5, which counts the blue bold edges.

Theorem 1.1 (Bai and Chen). *Fix integers $n, k \geq 1$ and a multiset M . There are equally many plane trees with n edges and k leaves whose levels constitute M and plane trees with n edges and k internal nodes whose right spanning widths constitute M .*

This equidistribution was proved by combining two bijections, one due to Jani and Rieper [11] and another one was newly constructed in [1], between plane trees and 132-avoiding permutations. Recall that a *binary tree* is a special type of rooted tree in which every internal node has either one left child or one right child or both. The first purpose of this paper is to show that combining the mirror symmetry on binary trees with the classical bijection between plane trees and binary trees leads to an involution proof of Theorem 1.1, which can be generalized to the weakly increasing trees introduced in [17]. The generalization of this simple involution will also reproves a quintuple equidistribution on weakly increasing trees found by Chen and Fu [5].

The second purpose of this paper is to construct an intriguing involution on binary trees, which was inspired by a bijective problem posed by Fu, Lin and Wang [10] regarding a symmetry on di-sk trees. A *di-sk tree* is a binary tree whose nodes are labeled by \oplus or \ominus , and no node has the same label as its right child (this requirement is called the *right chain condition*). For a binary tree or a di-sk tree T , we consider two different orders to traverse the nodes of T :

- the *preorder*, i.e., recursively traversing the parent to the left subtree then to the right subtree;
- the *reverse preorder*, i.e., recursively traversing the right subtree to the left subtree then to the parent.

See Fig. 2 for the preorder and the reverse preorder of a di-sk tree. Following [10], denote by $\text{top}(T)$ (resp. $\text{rpop}(T)$) the number of initial \oplus -nodes under the preorder (resp. reverse preorder) in T and let $\text{omi}(T)$ be the number of \ominus -nodes in T . For example, if T is the di-sk tree in Fig. 2, then $\text{top}(T) = 2$, $\text{rpop}(T) = 3$ and $\text{omi}(T) = 4$. Note that di-sk trees are in natural bijection with separable permutations, under which the statistics ‘omi’ and ‘top’ in trees are corresponding respectively to the statistics of descents and components [10] in permutations. Using generating functions, Fu, Lin and Wang [10] proved the following symmetry

$$(1.1) \quad \sum_{T \in \mathcal{D}\mathfrak{S}_n} t^{\text{omi}(T)} x^{\text{top}(T)} y^{\text{rpop}(T)} = \sum_{T \in \mathcal{D}\mathfrak{S}_n} t^{\text{omi}(T)} x^{\text{rpop}(T)} y^{\text{top}(T)},$$

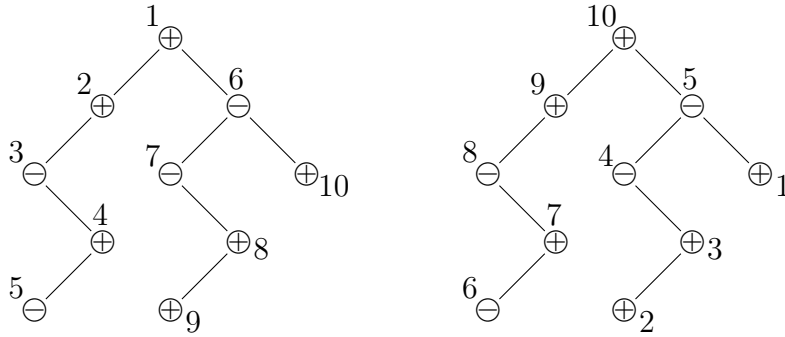

FIGURE 2. The preorder (on left) and the reverse preorder (on right) of a di-sk tree.

where \mathfrak{DT}_n denotes the set of di-sk trees with n nodes. They also proved several other symmetric distributions on di-sk trees, but the symmetry in (1.1) is the only one that lacks a combinatorial proof. Thus, they posed the following open problem at the end of the paper.

Problem 1.2 (Fu, Lin and Wang). *Can one find a bijective proof of the symmetry on di-sk trees in (1.1)?*

The rest of this paper is organized as follows. In Section 2, we investigate the mirror symmetry of binary trees, which leads to a joint generalization of two equidistributions found recently by Bai–Chen and Chen–Fu, respectively. We also answer affirmatively an open problem posed by Bai–Chen and introduce four new tree statistics analogous to rsw , having the same distribution as levels on plane trees. In Section 3, we construct a new involution on binary trees, which can be generalized to di-sk trees and rooted labeled trees. This involution answers Problem 1.2 and leads to a new statistic whose distribution over plane trees gives the Catalan’s triangle. Moreover, a quadruple equidistribution on plane trees involving this new statistic is proved via a recursive bijection.

2. THE MIRROR SYMMETRY OF BINARY TREES AND APPLICATIONS

Let \mathcal{P}_n be the set of all plane trees with n edges. For the sake of convenience, we will label the nodes of a plane tree in \mathcal{P}_n by using $\{0, 1, \dots, n\}$ in order to distinguish them and we assume that the root is labeled by 0 and the leftmost child of the root is labeled by 1. In a plane tree, nodes with the same parent are called *siblings* and the siblings to the left (resp. right) of a node v are called *elder* (resp. *younger*) *siblings* of v .

Let \mathcal{B}_n be the set of all binary trees with n nodes. For a tree $T \in \mathcal{P}_n$, we define the binary tree $\varphi(T) \in \mathcal{B}_n$ by requiring that for each pair of non-root nodes (x, y) in T :

- (i) y is the left child of x in $\varphi(T)$ only if when y is the leftmost child of x in T ;
- (ii) y is the right child of x in $\varphi(T)$ only if when x is the closest elder sibling of y in T .

The mapping $T \mapsto \varphi(T)$ establishes a natural one-to-one correspondence between \mathcal{P}_n and \mathcal{B}_n , which is well known [20, Page 9]. See the first step in Fig. 3 for an example of this bijection φ . For a binary tree $B \in \mathcal{B}_n$, let $\phi(B)$ be the mirror symmetry of B . Clearly,

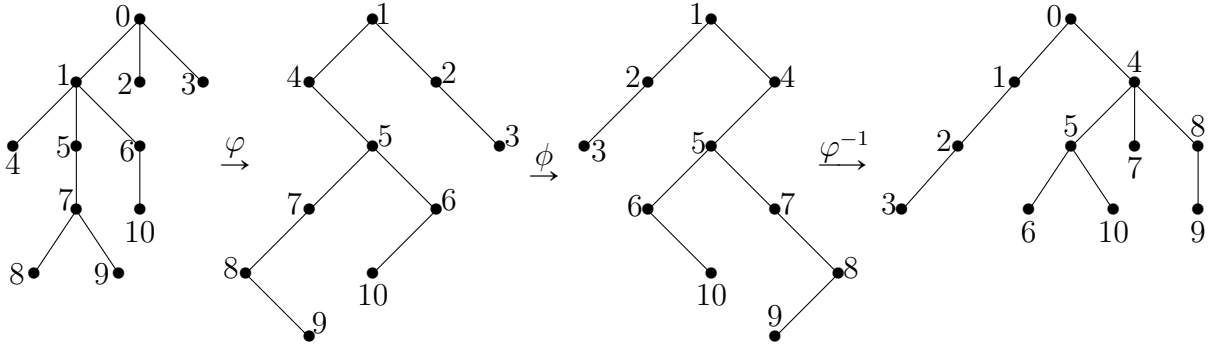

FIGURE 3. An example of the involution $\tilde{\phi} = \phi^{-1} \circ \phi \circ \phi$.

the map $B \mapsto \phi(B)$ is an involution on \mathcal{B}_n . Now introduce the involution $\tilde{\phi}$ on \mathcal{P}_n by $\tilde{\phi} = \phi^{-1} \circ \phi \circ \phi$. See Fig. 3 for an example of the involution $\tilde{\phi}$.

For a node v of a plane tree $T \in \mathcal{P}_n$, denote by $\text{lev}_T(v)$ the level of v in T and by $\text{lsw}_T(v)$ the *left spanning width*¹ of v , which is the number of children of v plus the number of edges attached to other nodes (than v) on the path from v to the root from the left-hand side. As long as there is no danger of confusion, we can remove the subscript T from $\text{lev}_T(v)$ and $\text{lsw}_T(v)$. Note that the distributions of left spanning widths and the right spanning widths are symmetric over plane trees, but are different in general over weakly increasing trees introduced in Definition 2.3.

Let $T \in \mathcal{P}_n$ and let $B = \varphi(T) \in \mathcal{B}_n$. We supply nodes to B to get a complete binary tree \bar{B} such that each node in B has exactly two children. We label the supplied nodes in \bar{B} by using $0', 1', \dots, n'$ according to the following rule:

- if the supplied node is a left child of a node v in B , then it is labeled by v' ;
- if the supplied node is a right child of a node v in B , then it is labeled by u' , where u is the father of v in T .

Then, such a \bar{B} is called the *complement* of B . For instance, if T and B are respectively the first two trees in Fig. 3, then \bar{B} is the tree drawn in Fig. 4. For any node v of T , there is a unique node u in T such that either v' is the right child of u in \bar{B} or u' is the right child of v in $\phi(\bar{B})$. We write $v \rightsquigarrow u$ for the relation of such two nodes. For the nodes of the first plane tree in Fig. 3, we have

$$0 \rightsquigarrow 3, 1 \rightsquigarrow 6, 2 \rightsquigarrow 1, 3 \rightsquigarrow 2, 4 \rightsquigarrow 0, 5 \rightsquigarrow 7, 6 \rightsquigarrow 10, 7 \rightsquigarrow 9, 8 \rightsquigarrow 4, 9 \rightsquigarrow 8, 10 \rightsquigarrow 5.$$

It is possible to describe the relation $v \rightsquigarrow u$ directly using T ; see Lemma 2.15. The reason to create the complements of binary trees lies in the following key observation.

Lemma 2.1. *Fix $T \in \mathcal{P}_n$ and let $B = \varphi(T) \in \mathcal{B}_n$. For any node v of T , $\text{lev}(v)$ (resp. $\text{lsw}(v)$) equals the number of left (resp. right) edges in the path from the root 1 to v' in \bar{B} .*

Proof. This observation follows from φ and the construction of the complement of binary trees. \square

¹The notion of left spanning widths was also noticed by Bai and Chen in their revised version of [1].

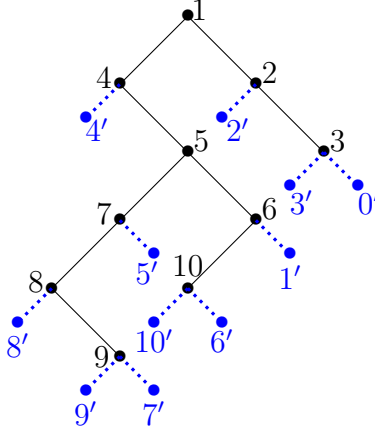

FIGURE 4. The complement of a binary tree.

For a node v of a plane tree $T \in \mathcal{P}_n$, let $\deg_T(v)$ be the number of children of v in T . We also introduce the *dual degree* of v , denoted $\widetilde{\deg}_T(v)$, according to the following three cases:

- if v is an internal node, then set $\widetilde{\deg}_T(v) = 0$;
- if v is a leaf in T and all nodes in the path from v to the root of T have no elder siblings, then set $\widetilde{\deg}_T(v) = \text{lev}_T(v)$;
- otherwise, let $\widetilde{\deg}_T(v)$ be the number of nodes from v to the first node that has elder siblings when walking along the path from v to the root of T .

Note that $\widetilde{\deg}_T(v)$ is positive iff v is a leaf. For example, if T is the last tree in Fig. 3, then $\widetilde{\deg}_T(3) = \widetilde{\deg}_T(6) = 3$, $\widetilde{\deg}_T(10) = \widetilde{\deg}_T(7) = 1$ and $\widetilde{\deg}_T(9) = 2$. By Lemma 2.1 and the mirror symmetry of binary trees, we have the following generalization of Theorem 1.1.

Theorem 2.2. Fix $T \in \mathcal{P}_n$. For any node v of T , if $v \rightsquigarrow u$, then

$$\text{lev}_T(v) = \text{lsw}_{\tilde{\phi}(T)}(u) \quad \text{and} \quad \text{lsw}_T(v) = \text{lev}_{\tilde{\phi}(T)}(u).$$

Moreover, $\widetilde{\deg}_T(v) = \widetilde{\deg}_{\tilde{\phi}(T)}(u)$.

2.1. Generalized to weakly increasing trees. Recall that an *increasing tree* with n edges is a plane tree with $n + 1$ nodes labeled by $\{0, 1, \dots, n\}$ such that each child receives greater label than its parent and siblings are labeled increasingly from left to right. Increasing trees are in bijection with permutations and has been extensively studied from the enumerative aspect; see [3, 13] and related references therein. As a unification of increasing trees and plane trees, the weakly increasing trees labeled by a multiset were introduced by Lin–Ma–Ma–Zhou [17] in 2021. Since then, various intriguing connections and bijections for weakly increasing trees have already been found [5, 15–17].

Definition 2.3 (Weakly increasing trees [17]). Fix a multiset $M = \{1^{p_1}, 2^{p_2}, \dots, n^{p_n}\}$ with $p = p_1 + \dots + p_n$. A weakly increasing tree on M is a plane tree with $p + 1$ nodes that are labeled precisely by all elements in the multiset $M \cup \{0\}$ satisfying

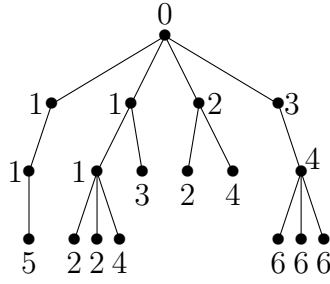

FIGURE 5. A weakly increasing tree on $\{1^4, 2^4, 3^2, 4^3, 5, 6^3\}$.

- (i) the labels along a path from the root to any leaf are weakly increasing (vertical weakly increasing);
- (ii) the labels of the children of each node is weakly increasing from left to right (horizontal weakly increasing).

Denote by \mathcal{P}_M the set of weakly increasing trees on M .

Note that weakly increasing trees on $[n] := \{1, 2, \dots, n\}$ are exactly increasing trees with n edges, while weakly increasing trees on $\{1^n\}$ are in obvious bijection with plane trees of n edges. See Fig. 5 for a weakly increasing tree on $M = \{1^4, 2^4, 3^2, 4^3, 5, 6^3\}$. It turns out that the bijection φ between plane trees and binary trees can be extended naturally to a bijection between weakly increasing trees and weakly increasing binary trees defined below.

Definition 2.4 (Weakly increasing binary trees [16]). *Fix a multiset M . A weakly increasing binary tree on M is a labeled binary tree such that*

- (i) the labels of the nodes form precisely the multiset M and
- (ii) the labels along a path from the root to any leaf is weakly increasing.

Denote by \mathcal{B}_M the set of weakly increasing binary trees on M .

Note that weakly increasing binary trees on $[n]$ are exactly increasing binary trees on $[n]$, while weakly increasing binary trees on $\{1^n\}$ are in obvious bijection with binary trees of n nodes. Since the mirror symmetry of a weakly increasing binary tree is still a weakly increasing binary tree, the involution ϕ introduced for plane trees can be extended directly to weakly increasing trees $\tilde{\phi} : \mathcal{P}_M \rightarrow \mathcal{P}_M$. Then the same discussions as in the proof of Theorem 2.2 for plane trees works for weakly increasing trees. Moreover, it turns out that such involution $\tilde{\phi}$ on \mathcal{P}_M also reproves a quintuple equidistribution on weakly increasing trees found by Chen and Fu [5].

To state our result, we need to recall some statistics on weakly increasing trees. Let T be a weakly increasing tree. Let $\text{leaf}(T)$ (resp. $\text{int}(T)$) be the number of leaves (resp. internal nodes) in T . The levels (resp. left spanning widths) of all nodes in T forms a multiset that is denoted as $\text{Lev}(T)$ (resp. $\text{Lsw}(T)$). Each node that has an elder sibling (resp. a child) with the same label is called a *repeated sibling* (resp. *repeated parent*). The labels of all repeated siblings (resp. parents) in T form a multiset that is denoted as $\text{Bro}(T)$ (resp. $\text{Par}(T)$). A leaf of a weakly increasing tree is *young* if it is the rightmost child of its parent; otherwise, it is old. Denote $\text{Yle}(T)$ the multiset of labels of all young leaves in T . Young and old leaves on plane trees were introduced by Chen, Deutsch and Elizalde [4]. Take the tree T in

Fig. 5 as an example, we have $\text{leaf}(T) = 10$, $\text{int}(T) = 8$, $\text{Lev}(T) = \{0, 1^4, 2^6, 3^7\}$, $\text{Lsw}(T) = \{0, 1^3, 2^3, 3^5, 4^4, 5, 6\}$, $\text{Bro}(T) = \{1, 2, 6, 6\}$, $\text{Par}(T) = \{1, 1, 2\}$ and $\text{Yle}(T) = \{3, 4, 4, 5, 6\}$. Our first main result is the following septuple equidistribution on weakly increasing trees that merges both results of Bai–Chen [1] and Chen–Fu [5].

Theorem 2.5. *Fix a multiset M a tree $T \in \mathcal{P}_M$. For any node v of T , if $v \rightsquigarrow u$, then*

$$\text{lev}_T(v) = \text{lsw}_{\tilde{\phi}(T)}(u), \quad \text{lsw}_T(v) = \text{lev}_{\tilde{\phi}(T)}(u) \quad \text{and} \quad \text{deg}_T(v) = \widetilde{\text{deg}}_{\tilde{\phi}(T)}(u).$$

Consequently, the following two septuples

$$(2.1) \quad (\text{Lev}, \text{Lsw}, \text{Bro}, \text{Par}, \text{Yle}, \text{leaf}, \text{int}) \quad \text{and} \quad (\text{Lsw}, \text{Lev}, \text{Par}, \text{Bro}, \text{Yle}, \text{int}, \text{leaf})$$

have the same distribution over \mathcal{P}_M .

Proof. The first statement follows from the same discussions as in the proof of Theorem 2.2 for plane trees. For the second statement, notice that a repeated sibling (resp. a young leaf) maps to a repeated right child (resp. a leaf) under φ , then to a repeated left child (resp. a leaf) under ϕ , and finally to a repeated parent (resp. a young leaf) under φ^{-1} . \square

Remark 2.6. *The septuple equidistribution (2.1) that does not involve Lev and Lsw was proved by Chen and Fu [5] using a recursively defined involution.*

2.2. Some new statistics having the same distribution as levels on plane trees.

Since the statistics lsw and rsw are in symmetry with each other, Bai and Chen posed the following open problem in their revised version of [1].

Problem 2.7 (Bai and Chen). *Does there exist another statistic st associated to nodes of plane trees such that the pair (lsw, rsw) is in equidistribution with the pair (lev, st) ?*

They believed that such a statistic exists but could not find it. We will answer this problem affirmatively and introduce four new statistics analogous to lsw and rsw , having the same distribution as levels on plane trees.

Let v be a node of a plane tree T . Let $\text{Lc}_T(v)$ be the set of nodes attached to other nodes (than v) on the path from v to the root from the left-hand side. For example, if T is the first tree in Fig. 7, then $\text{Lc}_T(10) = \{4, 5\}$ and $\text{Lc}_T(9) = \{4, 8\}$. Let $\text{lc}_T(v) = |\text{Lc}_T(v)|$. The statistic ‘ lc ’ is a refinement of ‘ lsw ’ in the sense that $\text{lsw}_T(v) = \text{deg}_T(v) + \text{lc}_T(v)$. Our first new statistic is a modification of ‘ lc ’ defined as

$$\text{dlev}_T(v) = \begin{cases} 0, & \text{if } v \text{ is the root of } T; \\ \text{lc}_T(v) + 1, & \text{otherwise.} \end{cases}$$

The following observation follows immediately from φ .

Lemma 2.8. *Fix $T \in \mathcal{P}_n$ and let $B = \varphi(T) \in \mathcal{B}_n$. For any node v of T other than the root, $\text{lev}_T(v) - 1$ (resp., $\text{lc}_T(v)$) equals the number of left (resp., right) edges in the path from the root 1 to v in B .*

This simple lemma has one interesting application about longest increasing/decreasing subsequences in 132-avoiding permutations. Recall that a permutation $\pi = \pi_1\pi_2 \cdots \pi_n$ is said to be 132-avoiding if there are no indices $1 \leq i < j < k \leq n$ such that $\pi_i < \pi_k < \pi_j$. Let $\mathfrak{S}_n(132)$ be the set of all 132-avoiding permutations of length n . For each permutation

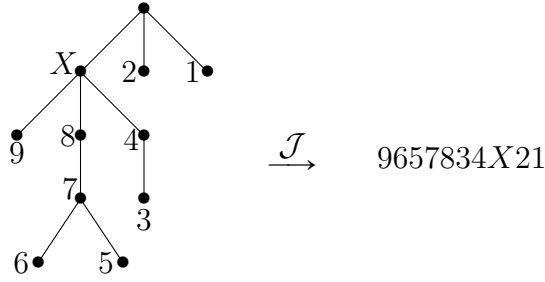
FIGURE 6. An example of Jani–Rieper’s bijection \mathcal{J} .

π , denote $\text{is}(\pi)$ (resp. $\text{ds}(\pi)$) the length of the longest increasing (resp. decreasing) subsequence of π . The distributions of these two statistics over 132-avoiding permutations were studied by Krattenthaler [12] and Reifegerste [18]. Combining $\tilde{\phi}$ with Jani and Rieper’s bijection [11] between \mathcal{P}_n and $\mathfrak{S}_n(132)$ leads to the following inequality distribution.

Proposition 2.9. *There exists an involution θ on $\mathfrak{S}_n(132)$ such that*

$$(2.2) \quad \text{is}(\pi) \leq \text{ds}(\theta(\pi)) \quad \text{and} \quad \text{is}(\theta(\pi)) \leq \text{ds}(\pi)$$

for each $\pi \in \mathfrak{S}_n(132)$. In particular, we have

$$\sum_{\pi \in \mathfrak{S}_n(132)} \text{is}(\pi) \leq \sum_{\pi \in \mathfrak{S}_n(132)} \text{ds}(\pi).$$

Let us first review briefly Jani and Rieper’s bijection $\mathcal{J} : \mathcal{P}_n \rightarrow \mathfrak{S}_n(132)$. Given a plane tree $T \in \mathcal{P}_n$, a node of T is said to be the i -th node under the preorder (resp. reverse preorder) in T iff it is the i -th node under the preorder (resp. reverse preorder) in $\varphi(T)$. Note that the preorder of plane trees defined here agrees with that in [20, Page 10] and a node v is the i -th node under the preorder iff it is the $(n + 2 - i)$ -th node under the reverse preorder. See Fig. 10 for a plane tree T labeled by its preorder. The permutation $\mathcal{J}(T) \in \mathfrak{S}_n(132)$ is constructed in two steps:

- label each non-root node of T by its reverse preorder;
- then $\mathcal{J}(T)$ is the word obtained by reading the labeled tree in *postorder*, that is, recursively traversing the left subtree to the right subtrees then to the parent.

See Fig. 6 for an example of Jani and Rieper’s bijection \mathcal{J} .

Remark 2.10. *The inverse of \mathcal{J} is essentially the restriction of the classical bijection (see [19, Example 1.3.15]) between permutations and increasing trees on 213-avoiding permutations. In fact, given $\pi \in \mathfrak{S}_n(132)$, for i from n down to 1, construct the (labeled) plane tree $\mathcal{J}^{-1}(\pi)$ by defining π_i to be the child of the leftmost letter π_j ($j > i$) which is greater than π_i . If there is no such letter π_j , then let π_i be the child of the root.*

Proof of Proposition 2.9. We set $\theta = \mathcal{J} \circ \tilde{\phi} \circ \mathcal{J}^{-1}$. Since θ is an involution, we only need to show $\text{is}(\pi) \leq \text{ds}(\theta(\pi))$.

For $\pi \in \mathfrak{S}_n(132)$ and an index $i \in [n]$, introduce

$$\begin{aligned} \text{IR}(\pi_i) &= \{\pi_j : j \geq i \text{ and } \pi_j \geq \pi_\ell \text{ for all } i \leq \ell < j\}, \\ \text{IL}(\pi_i) &= \{\pi_j : j \leq i \text{ and } \pi_j \geq \pi_\ell \text{ for all } j < \ell \leq i\}. \end{aligned}$$

Suppose that $T = \mathcal{J}^{-1}(\pi)$ whose non-root nodes are labeled as in the first step of \mathcal{J} , i.e., according to the reverse preorder. Then, we have the following two observations:

- (1) $\text{IR}(\pi_i)$ equals the set of nodes (other than the root) in the path from π_i to the root;
- (2) $\text{IL}(\pi_i) = \text{Lc}_T(\pi_i) \cup \{\pi_i\}$.

If we introduce the two multisets

$$\text{IR}(\pi) = \{|\text{IR}(\pi_i)| : i \in [n]\} \quad \text{and} \quad \text{IL}(\pi) = \{|\text{IL}(\pi_i)| : i \in [n]\},$$

then by Lemma 2.8, we have $\text{IR}(\pi) = \text{IL}(\theta(\pi))$. As π is 132-avoiding, $\text{is}(\pi) = \max(\text{IR}(\pi))$. On the other hand, $\text{ds}(\sigma) \geq \max(\text{IL}(\sigma))$ for any permutation σ . This leads to the conclusion that $\text{is}(\pi) \leq \text{ds}(\theta(\pi))$. \square

Before introducing the other three statistics, we need an auxiliary definition. The *left chain* of a node v in T is a path $v = v_1, v_2, \dots, v_k$, where v_{i+1} is the eldest child of v_i for $i = 1, \dots, k-1$ and v_k is a leaf in T . Denote by $\text{lchain}_T(v)$ the length of the left chain of v in T . Our second statistic is defined as

$$\text{dls}_T(v) = \begin{cases} \text{lchain}_T(v), & \text{if } v \text{ is the root;} \\ \text{lchain}_T(u) + \text{lev}_T(v), & \text{if } v \text{ has the closest younger sibling } u; \\ \text{lev}_T(v) - 1, & \text{otherwise.} \end{cases}$$

Our third statistic is defined as

$$\text{drsw}_T(v) = \begin{cases} 1 + \sum_{w \in \text{Lc}_T(v) \cup \{u, v\}} \text{lchain}_T(w), & \text{if } v \text{ has the closest younger sibling } u; \\ \sum_{w \in \text{Lc}_T(v) \cup \{v\}} \text{lchain}_T(w), & \text{otherwise.} \end{cases}$$

Theorem 2.11. *For any plane tree T and a node v of T , we have*

$$(2.3) \quad (\text{lev}, \text{ls}_T, \text{rs}_T)(v) = (\text{dlev}, \text{dls}_T, \text{drsw}_T)_{\tilde{\phi}(T)}(v).$$

In order to prove Theorem 2.11, we need a direct description of the involution $\tilde{\phi}$ as follows:

- (i) the node 1 is the eldest child of the root 0 in $\tilde{\phi}(T)$;
- (ii) if v is the eldest child of a node u other than the root in T , then v becomes the closest younger sibling of u in $\tilde{\phi}(T)$;
- (iii) if v is not the eldest child of its parent and u is the closest sibling elder than v in T , then v is the eldest child of u in $\tilde{\phi}(T)$.

See Fig. 7 for an example of the direct description of $\tilde{\phi}$. The following observation is clear from this direct description of $\tilde{\phi}$.

Lemma 2.12. *Fix $T \in \mathcal{P}_n$ and let $\tilde{T} = \tilde{\phi}(T)$. For any internal node v of T other than the root, if u is the eldest child of v in T , then*

$$\text{deg}_T(v) = \text{lchain}_{\tilde{T}}(u) + 1.$$

Lemma 2.13. *Fix $T \in \mathcal{P}_n$ and let $\tilde{T} = \tilde{\phi}(T)$. For any node v of T , we have*

$$\text{rsw}_T(v) = \text{drsw}_{\tilde{T}}(v).$$

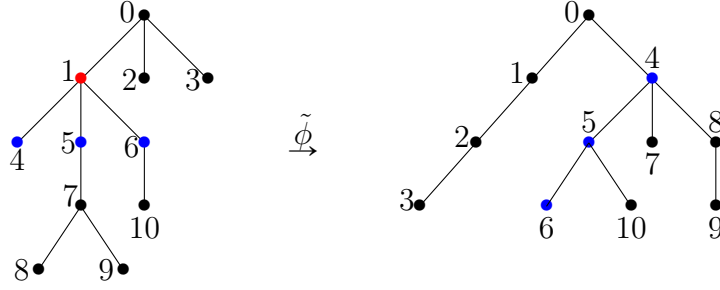
FIGURE 7. An example of $\deg_T(1) = \text{lchain}_{\tilde{T}}(4) + 1$.

Proof. Suppose the path from v to the root in T is v_0, v_1, \dots, v_k with $v_k = 0$. By definition, $\text{rsw}_T(v)$ equals the sum of the numbers of all the younger siblings of v_i ($0 \leq i < k$) plus $\deg_T(v)$. By the direct description of $\tilde{\phi}$, the nodes v_1, \dots, v_{k-1} of T are mapped to the nodes in $\text{Lc}_{\tilde{T}}(v)$ and all the younger siblings of v_i ($0 \leq i < k$) in T are mapped to the rest nodes of left chain of v_i other than v_i in \tilde{T} . Combining with Lemma 2.12 finishes the proof of the lemma. \square

Now, we are in position to prove Theorem 2.11.

Proof of Theorem 2.11. By Lemmas 2.8 and 2.13, we have

$$(\text{lev}, \text{rsw})_T(v) = (\text{dlev}, \text{drsw})_{\tilde{\phi}(T)}(v).$$

It remains to show that $\text{lsw}_T(v) = \text{dlsw}_{\tilde{\phi}(T)}(v)$. We distinguish the following three cases.

- (1) If $v = 0$ is the root of T , then it follows from the direct description of $\tilde{\phi}$ that $\deg_T(0) = \text{lchain}_{\tilde{\phi}(T)}(0)$ and so $\text{lsw}_T(0) = \text{dlsw}_{\tilde{\phi}(T)}(0)$.
- (2) If v is a leaf of T , then $\text{lsw}_T(v) = \text{dlsw}_{\tilde{\phi}(T)}(v)$ by Lemma 2.8.
- (3) Otherwise, v is an internal node of T other than the root. By Lemmas 2.8 and 2.12, we have

$$\text{lsw}_T(v) = \text{lc}_T(v) + \deg_T(v) = \text{lev}_{\tilde{\phi}(T)}(v) - 1 + \text{lchain}_{\tilde{\phi}(T)}(u) + 1 = \text{dlsw}_{\tilde{\phi}(T)}(v),$$

as desired.

The proof of Theorem 2.11 is complete. \square

We will solve Problem 2.7 by introducing the fourth statistic which is named *dual right spanning width* of v in T :

$$\widetilde{\text{rsw}}_T(v) = \sum_{w \in \text{Lc}_T(v) \cup \text{Ch}_T(v)} \text{lchain}_T(w) + \widetilde{\text{deg}}_T(v),$$

where $\text{Ch}_T(v)$ is the set of all children of v in T . For example, if T is the second tree in Fig. 8, then $\widetilde{\text{rsw}}_T(4) = 4$ and $\widetilde{\text{rsw}}_T(10) = 5$. The following theorem answers Problem 2.7.

Theorem 2.14. Fix $T \in \mathcal{P}_n$ and let $\tilde{T} = \tilde{\phi}(T)$. For any node v of T , if $v \rightsquigarrow u$, then

$$(2.4) \quad (\text{lsw}, \text{lev}, \text{rsw}, \widetilde{\text{rsw}})_T(v) = (\text{lev}, \text{lsw}, \widetilde{\text{rsw}}, \text{rsw})_{\tilde{T}}(u).$$

Before we prove Theorem 2.14, we need the following lemma, which can be verified from the bijection φ and the construction of the complement of binary trees.

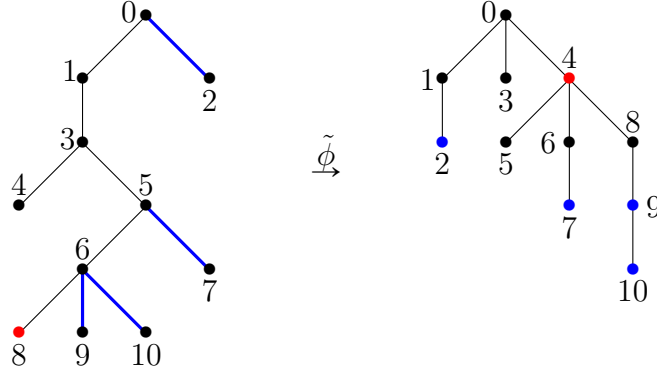
FIGURE 8. An example of $\text{rsw}_T(8) = \widetilde{\text{rsw}}_{\tilde{T}}(4)$.

Lemma 2.15. *For any node v of a plane tree T such that $v \rightsquigarrow u$, the node u can be determined in T according to the following three cases.*

- *If v is an internal node, then u is the youngest child of v .*
- *If v is a leaf and no nodes in the path from v to the root has elder siblings, then u is the root 0.*
- *If v is a leaf and w is the first node that has elder siblings in the path from v to the root, then u is the closest elder sibling of w .*

We are now ready to prove Theorem 2.14.

Proof of Theorem 2.14. As $v \rightsquigarrow u$ in T is equivalent to $u \rightsquigarrow v$ in \tilde{T} and $\tilde{\phi}$ is an involution, we only need to show $\text{rsw}_T(v) = \widetilde{\text{rsw}}_{\tilde{T}}(u)$ in view of Theorem 2.2. We distinguish the following three cases.

- (1) If v is an internal node other than the root of T , then u is a leaf in \tilde{T} . By Lemma 2.15, u is the youngest child of v in T and dually, if u' is the first node that has elder siblings in the path from u to the root in \tilde{T} , then $v \in \text{Lc}_{\tilde{T}}(u)$ is the closest elder sibling of u' in \tilde{T} . It then follows that $\widetilde{\text{deg}}_{\tilde{T}}(u) = \text{lchain}_{\tilde{T}}(u') + 1$. By Lemma 2.13 and the relationship between u and v in \tilde{T} , we have

$$\begin{aligned}
 \text{rsw}_T(v) &= \text{drsw}_{\tilde{T}}(v) \\
 &= 1 + \sum_{w \in \text{Lc}_{\tilde{T}}(v) \cup \{v, u'\}} \text{lchain}_{\tilde{T}}(w) \\
 &= \sum_{w \in \text{Lc}_{\tilde{T}}(u)} \text{lchain}_{\tilde{T}}(w) + \widetilde{\text{deg}}_{\tilde{T}}(u) \\
 &= \widetilde{\text{rsw}}_{\tilde{T}}(u).
 \end{aligned}$$

- (2) If v is the root of T , then $\text{rsw}_T(v) = \text{deg}_T(v) = \widetilde{\text{deg}}_{\tilde{T}}(u) = \widetilde{\text{rsw}}_{\tilde{T}}(u)$.

- (3) If v is a leaf of T , then v is the youngest child of u in \tilde{T} according to Lemma 2.15. By Lemma 2.13 and the fact that u is an internal node in \tilde{T} , we have

$$\begin{aligned}
\text{rsw}_T(v) &= \text{drsw}_{\tilde{T}}(v) \\
&= \sum_{w \in \text{Lc}_{\tilde{T}}(v) \cup \{v\}} \text{lchain}_{\tilde{T}}(w) \\
&= \sum_{w \in \text{Lc}_{\tilde{T}}(u) \cup \text{Ch}_{\tilde{T}}(u)} \text{lchain}_{\tilde{T}}(w) \\
&= \widetilde{\text{rsw}}_{\tilde{T}}(u).
\end{aligned}$$

The proof of this theorem is complete. \square

Remark 2.16. *The four new tree statistics (dlev, dls, drsw, $\widetilde{\text{rsw}}$) can be generalized to weakly increasing trees, as well as Theorems 2.11 and 2.14.*

3. A NEW INVOLUTION ON BINARY TREES, GENERALIZATIONS AND APPLICATIONS

In this section, we construct a new involution on binary trees, which can be generalized naturally to di-sk trees and rooted labeled trees. The description of this involution is simple but could not be found in the website of FindStat [8]. This involution answers Problem 1.2 and leads to a new statistic whose distribution over binary trees or plane trees gives the *Catalan's triangle* [2] (also known as *ballot numbers*) $C_{n,k} = \frac{k}{2n-k} \binom{2n-k}{n}$. Moreover, a quadruple equidistribution on plane trees involving this new statistic is proved via a recursive bijection.

For a binary tree (labeled or unlabeled) B , let $\text{spi}(B)$ be the *length of the spine* of B , which equals the smallest i such that the $(i+1)$ -th node under the *preorder* is a right child. Let $\text{rspi}(B)$ be the smallest i such that the $(i+1)$ -th node under the *reverse preorder* has a right child. By convention, if B is the special binary tree with only left edges that has n nodes, then define $\text{spi}(B) = \text{rspi}(B) = n$. As an example, for the first binary tree in Fig. 9, we have $\text{spi}(B) = 3$ (counts the three nodes in blue) and $\text{rspi}(B) = 4$ (counts the four nodes in red).

Given a binary tree, its *right chain* is any maximal path composed of only right edges. For instance, the first binary tree in Fig. 9 has 9 right chains, which are $v_1 - v_{10} - v_{11} - v_{12} - v_{17}$, $v_2 - v_4 - v_8$, $v_{13} - v_{15}$, v_3 , v_5 , v_9 , v_{14} , v_{16} and $v_6 - v_7$. Right chains of binary trees was introduced in the study of multiset Schett polynomials [15, 16]. The length of a right chain is the number of right edges in the chain. The multiset of the lengths of all right chains of a binary tree B is called the *right chain sequence* of B .

Let $B \in \mathcal{B}_n$ be a binary tree. We aim to construct an involution $\vartheta : \mathcal{B}_n \rightarrow \mathcal{B}_n$ that switches the statistics “spi” and “rspi” as follows. Under the preorder, suppose that the i -th node of B is v_i . Then, the root of $\vartheta(B)$ is v_n and for i from $n-1$ down to 1,

- if v_i has right child v_ℓ for $\ell > i$ in B , then set v_i to be the right child of v_ℓ in $\vartheta(B)$;
- otherwise, v_i has no right child in B , then set v_i to be the left child of v_{i+1} in $\vartheta(B)$.

See Fig. 9 for an example of ϑ . It is not immediately from the above simple construction that $\vartheta : \mathcal{B}_n \rightarrow \mathcal{B}_n$ is an involution.

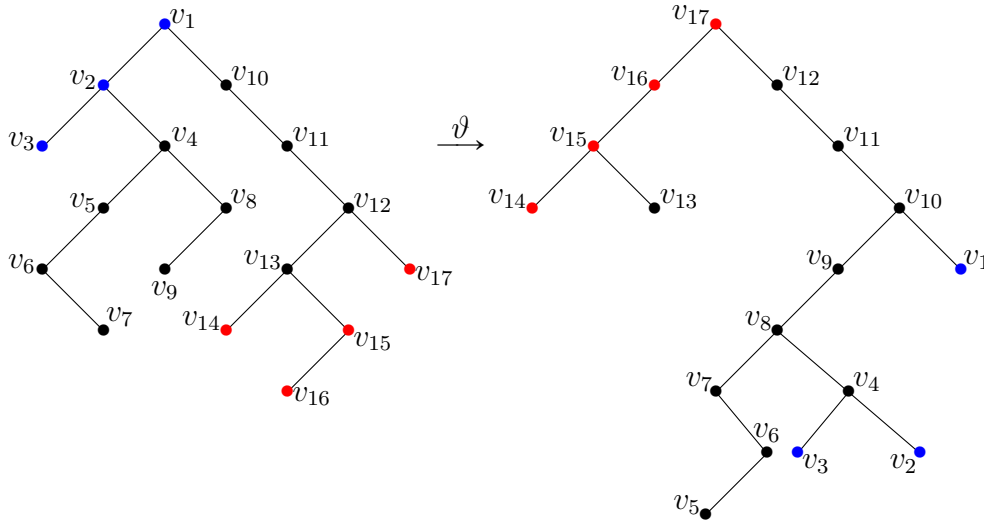
FIGURE 9. An example of the involution ϑ .

Theorem 3.1. *The mapping $\vartheta : \mathcal{B}_n \rightarrow \mathcal{B}_n$ is an involution preserving the right chain sequences and switching the statistics “spi” and “rspi”.*

Proof. Since the node v_i of B is the $(n + 1 - i)$ -th node under the reverse preorder, the mapping $\vartheta : \mathcal{B}_n \rightarrow \mathcal{B}_n$ admits an alternative description. Under the reverse preorder, suppose that the i -th node of B is u_i (note that $u_i = v_{n+1-i}$). Then, the root of $\vartheta(B)$ is u_1 and for i from 2 up to n ,

- if u_i has right child u_ℓ for $\ell < i$ in B , then set u_i to be the right child of u_ℓ in $\vartheta(B)$;
- otherwise, u_i has no right child in B , then set u_i to be the left child of u_{i-1} in $\vartheta(B)$.

It is clear from the above construction that $\text{rspi}(B) = \text{spi}(\vartheta(B))$. Thus, it remains to show that ϑ is an involution preserving the right chain sequences.

Note that a binary tree is completely determined by its left edges and right edges. Thus, it suffices to show that each edge of B is preserved under ϑ^2 . By the construction of ϑ , the node v_i becomes the i -th node of $\vartheta(B)$ under the reverse preorder. If v_j is the right child of v_i (for some $i < j$) in B , then v_i becomes the right child of v_j in $\vartheta(B)$ and so v_j remains the right child of v_i in $\vartheta^2(B)$. In other words, the right edges are preserved under ϑ^2 . It also follows that B and $\vartheta(B)$ have the same right chain sequence. To see that the left edges are preserved under ϑ^2 , suppose that v_{i+1} is the left child of v_i (for some i) in B . Note that v_{i+1} has no right child in $\vartheta(B)$, for otherwise v_{i+1} would be the right child of its parent in B , which contradicts with the fact that v_{i+1} is the left child of v_i in B . As v_i and v_{i+1} are respectively the i -th node and the $(i + 1)$ -th node in $\vartheta(B)$ under the reverse preorder, it then follows from the alternative description of ϑ that v_{i+1} remains the left child of v_i in $\vartheta^2(B)$. Therefore, $\vartheta^2(B) = B$ and so ϑ is an involution on \mathcal{B}_n , as desired. \square

Remark 3.2. *As the involution ϑ preserves the right edges of binary trees and di-sk trees are just binary trees labeled by \oplus and \ominus satisfying the right chain condition, ϑ is generalized naturally to di-sk trees which preserves the number of \ominus -nodes and switches the two statistics “top” and “rpop”. This answers Problem 1.2.*

The Catalan's triangle $C_{n,k} = \frac{k}{2n-k} \binom{2n-k}{n}$ has many known combinatorial interpretations in the literature (see [2, 14] and the references therein), among which is the enumeration of plane trees by the *length of left arms*. The left chain starting from the root of T is called the *left arm of T* and we denote by $\text{larm}(T)$ the length of the left arm of T . Symmetrically, we define the *right arm of T* and $\text{rarm}(T)$ the length of the right arm of T . In other words, $\text{rarm}(T)$ is the length of the left arm of the mirror symmetry of T . As an example, for the tree T in Fig. 10, we have $\text{larm}(T) = 2$ and $\text{rarm}(T) = 3$. Denote by $\text{rev}(T)$ the number of nodes before the first node (under the reverse preorder) that has younger sibling. By convention, if T is the path with n edges, then define $\text{rev}(T) = n$. For example, if T is the tree in Fig. 10, then the node 13 is the first node (under the reverse preorder) that has younger sibling and so $\text{rev}(T) = 5$ (counts the five nodes in blue).

The *degree of a node* in a plane tree is the number of its children. The multiset of the degrees of all internal nodes of a plane tree T is called the *degree sequence of T* . The involution $\tilde{\vartheta} : \mathcal{P}_n \rightarrow \mathcal{P}_n$ defined by $\tilde{\vartheta} = \varphi^{-1} \circ \vartheta \circ \varphi$ has the following interesting property.

Proposition 3.3. *The involution $\tilde{\vartheta} : \mathcal{P}_n \rightarrow \mathcal{P}_n$ preserves the degree sequences and the statistic “rarm” but switches the statistics “larm” and “rev”. In particular, “rev” is a new tree statistic that interprets the Catalan triangle $C_{n,k}$.*

The proof of Proposition 3.3 is decomposed into the following two lemmas. For a binary tree B , the path starting from the root and ending at the last node (under preorder) is called the *right boundary of B* . Let $\text{lrb}(B)$ be the number of left edges in the right boundary of B . Then, the following property of φ can be checked routinely.

Lemma 3.4. *For any $T \in \mathcal{P}_n$, we have*

$$\text{larm}(T) = \text{spi}(\varphi(T)), \quad \text{rev}(T) = \text{rspi}(\varphi(T)) \quad \text{and} \quad \text{rarm}(T) = \text{lrb}(\varphi(T)) + 1.$$

Moreover, the degree sequence of T equals the right chain sequence of $\varphi(T)$.

Combining Theorem 3.1 and Lemma 3.4 with the following lemma proves Proposition 3.3.

Lemma 3.5. *For any $B \in \mathcal{B}_n$, we have $\text{lrb}(B) = \text{lrb}(\vartheta(B))$.*

Proof. If v is the left child of u in the right boundary of B , then u has no right child in B . Thus, u becomes the left child of v in the right boundary of $\vartheta(B)$ (since v has no right child). On the other hand, if v is the right child of u in the right boundary of B , then obviously u becomes the right child of v in the right boundary of $\vartheta(B)$. This proves $\text{lrb}(B) = \text{lrb}(\vartheta(B))$. \square

Proposition 3.3 implies that the refinement of Catalan numbers

$$C_n(x, y, z) := \sum_{T \in \mathcal{P}_n} x^{\text{larm}(T)-1} y^{\text{rarm}(T)-1} z^{\text{rev}(T)-1}$$

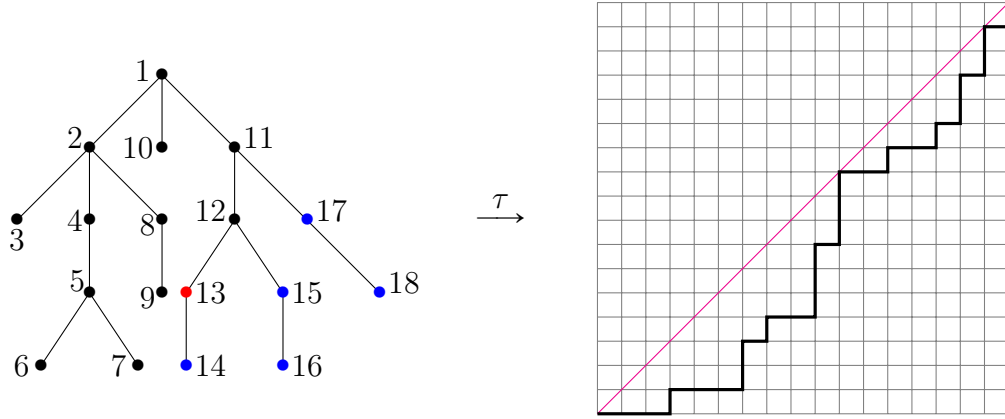

FIGURE 10. A plane tree labeled by its preorder and its associated Dyck path under τ .

is symmetric in x and z . In fact, $C_n(x, y, z)$ is a symmetric function in x, y and z , as will be proved in next section. The first few values of $C_n(x, y, z)$ are listed as follows:

$$C_1(x, y, z) = 1,$$

$$C_2(x, y, z) = 1 + xyz = 1 + m_{111},$$

$$C_3(x, y, z) = 1 + xy + xz + yz + x^2y^2z^2 = 1 + m_{11} + m_{222},$$

$$C_4(x, y, z) = 1 + m_1 + m_{11} + m_{22} + m_{211} + m_{333},$$

$$C_5(x, y, z) = 2 + 2m_1 + m_2 + 2m_{11} + m_{21} + 2m_{111} + m_{22} + m_{211} + m_{33} + m_{321} + m_{222} + m_{444},$$

where $m_\lambda = m_\lambda(x, y, z)$ is the monomial symmetric function for a partition λ .

3.1. A quadruple equidistribution on plane trees. For a plane tree T , let $\text{run}(T)$ be the number of non-leaf nodes after the last node (included) in preorder that has at least two children. By convention, if T is the path with n edges, then define $\text{run}(T) = n$. For example, if T is the tree in Fig. 10, then the 12-th node is the last node (in preorder) that has at least two children and so $\text{run}(T) = \#\{12, 13, 15, 17\} = 4$. This statistic originated from Duarte and Guedes de Oliveira's study [7] of parking functions (see also [14]). The main result in this section is the following bijection on plane trees.

Theorem 3.6. *There exists a bijection $\Psi : \mathcal{P}_n \rightarrow \mathcal{P}_n$ that preserves the triple of statistics (larm, rarm, leaf) and transforms the statistic “rev” to “run”. Consequently, $C_n(x, y, z)$ is a symmetric function in x, y and z .*

Remark 3.7. *The distribution of the pair (rev, run) is not symmetric over \mathcal{P}_5 .*

Before the construction of the bijection Ψ , we show how the symmetry of $C_n(x, y, z)$ follows from Ψ and an involution on Dyck paths introduced in [14].

Recall that a *Dyck path* of order n is a lattice path in \mathbb{N}^2 from $(0, 0)$ to (n, n) using the *east step* $(1, 0)$ and the *north step* $(0, 1)$, which does not pass above the diagonal $y = x$. Let \mathcal{D}_n be the set of all Dyck paths of order n . Let $\mathbf{c} = (c_1, c_2, \dots, c_k)$ be a composition of n . A Dyck path $D \in \mathcal{D}_n$ is said to have *composition-type* \mathbf{c} if it begins with c_1 east steps followed by at least one north step, and then continues with c_2 east steps followed by at least one

north step, and then so on. For instance, the Dyck path in Fig. 10 has composition type $(3, 3, 1, 2, 1, 2, 2, 1, 1, 1)$. Three statistics introduced in [14] are involved:

- the number of times that D returns to the diagonal $y = x$ after the departure, denoted $\text{ret}(D)$;
- the number of north steps before the first north step (included) that followed immediately by a north step, denoted $\text{hrun}(D)$;
- the number of east steps after the last east step (excluded) that followed immediately by an east step, denoted $\text{vrun}(D)$.

By convention, for the only zigzag Dyck path (i.e., each east step is followed by a north step) $D \in \mathcal{D}_n$, we define $\text{hrun}(D) = \text{vrun}(D) = n$. For example, for the Dyck path D in Fig. 10, we have $\text{ret}(D) = 3$, $\text{hrun}(D) = 2$ and $\text{vrun}(D) = 4$. The following involution on Dyck paths was constructed by Li and Lin [14].

Theorem 3.8 (Li and Lin). *There exists a composition-type preserving involution Φ on \mathcal{D}_n that exchanges the pair of statistics $(\text{hrun}, \text{ret})$.*

Corollary 3.9. *The three-variable function*

$$\sum_{D \in \mathcal{D}_n} x^{\text{hrun}(D)} y^{\text{ret}(D)} z^{\text{vrun}(D)}$$

is a symmetric function.

Proof. Since the composition-type of a Dyck path determines the statistic ‘vrun’, the symmetry

$$\sum_{D \in \mathcal{D}_n} x^{\text{hrun}(D)} y^{\text{ret}(D)} z^{\text{vrun}(D)} = \sum_{D \in \mathcal{D}_n} y^{\text{hrun}(D)} x^{\text{ret}(D)} z^{\text{vrun}(D)}$$

then follows from the involution Φ . The other two symmetries are clear by combining with the involution of taking the mirror symmetry of the Dyck paths after rotating 180 degrees. \square

There is a bijection τ (see [14]) that maps a plane tree to a Dyck path by recording the steps when the tree is traversed in preorder: whenever we visit a node of degree i (for the first time), except the last leaf, we record i east steps followed by one north step. See Fig. 10 for one example of τ . The bijection τ has the following properties, which are clear from the above construction.

Lemma 3.10. *For any plane tree T , we have*

$$(3.1) \quad (\text{larm}, \text{rarm}, \text{run})(T) = (\text{hrun}, \text{ret}, \text{vrun})\tau(T).$$

The fact that $C_n(x, y, z)$ is a symmetric function then follows by combining Lemma 3.10, Corollary 3.9 and the bijection Ψ . The rest of this section is devoted to the construction of Ψ , which is based on a technical lemma regarding the statistic ‘rev’.

For a plane tree T , let $\text{bran}(T)$ be the number of branches of T at the root, i.e., the number of children of the root. Let

$$\mathcal{P}_n^{(k,l)} := \{T \in \mathcal{P}_n : \text{bran}(T) \geq 2, \text{larm}(T) = k, \text{rarm}(T) = l\}.$$

Lemma 3.11. *Fix integers $n, k \geq 1$. There exists a bijection $\psi : \mathcal{P}_n^{(k,2)} \rightarrow \mathcal{P}_n^{(k+1,1)}$ preserving the pair of statistics $(\text{rev}, \text{leaf})$.*

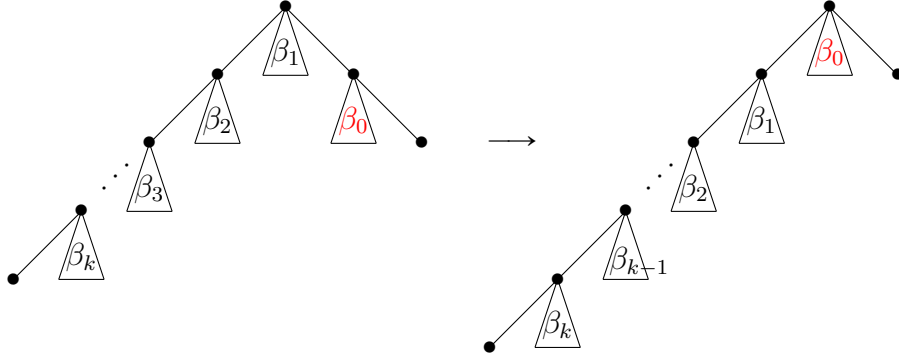
FIGURE 11. The first step of ψ .

Proof. For the sake of convenience, we call the first node (under the reverse preorder) that has younger sibling in T the *rev-node* of T . Thus, $\text{rev}(T)$ counts the nodes before the rev-node of T under the reverse preorder. The construction of ψ consists of two main steps: (i) shift the branches of the nodes in the right and left arms of T ; (ii) adjust the resulting tree if necessary to keep the statistic “rev”.

Step (i) of ψ . Given $T \in \mathcal{P}_n^{(k,2)}$, let β_0 be the subtree at the second node in the right arm and let β_i ($1 \leq i \leq k$) be the subtree at the i -th node in the left arm, after deleting all the edges in the left and right arms of T . Then form the plane tree $T' \in \mathcal{P}_n^{(k+1,1)}$ such that after deleting all the edges in the left and right arms, β_i ($0 \leq i \leq k$) is the subtree at the $(i+1)$ -th node in the left arm of T' . See Fig. 11 for an illustration of this shifting $T \mapsto T'$.

If β_0 contains at least two nodes, then $\text{rev}(T) = \text{rev}(T')$ and we set $\psi(T) = T'$. Otherwise, β_0 contains only one node and we perform the step (ii) of ψ .

Step (ii) of ψ . As β_0 contains only one node, $\text{rev}(T')$ is not always equal to $\text{rev}(T)$ and so we need to distinguish two main cases.

- a) $\text{rev}(T') \geq \text{rev}(T)$. We further distinguish two subcases:
 - a1) β_1 **contains only one node**. This forces all β_i , $2 \leq i \leq k$, contain only one node and thus $\text{rev}(T') = \text{rev}(T)$. We set $\psi(T) = T'$ in this case.
 - a2) β_1 **contains at least two nodes**. Thus, the subtree at the youngest child of the root of β_1 must be a path (otherwise, we will have $\text{rev}(T') < \text{rev}(T)$, a contradiction) that is denoted by P . Suppose that T^* is the subtree of T' at the second node in the left arm after cutting the branch P . Then $\psi(T)$ is obtained from T' by cutting the path P and attaching it to the node which is the penultimate node on the right arm of T^* (see Fig. 12 for an example). It is clear that $\text{rev}(T) = \text{rev}(\psi(T))$ holds. Note that $\psi(T) = T'$ may occur when the penultimate node on the right arm of T^* is the parent of the root of P in T' , i.e., when $\text{rarm}(T^*) = 1$.
- b) $\text{rev}(T') < \text{rev}(T)$. In this case, the parent of the rev-node of T can not be the root. Thus, we have $\text{rev}(T') = \text{rev}(T) - 1$. We further distinguish three subcases:
 - b1) **The rev-node of T' has no elder sibling**. Let P be the unique path in T' from the second node v in the left arm to the parent of the rev-node (see the

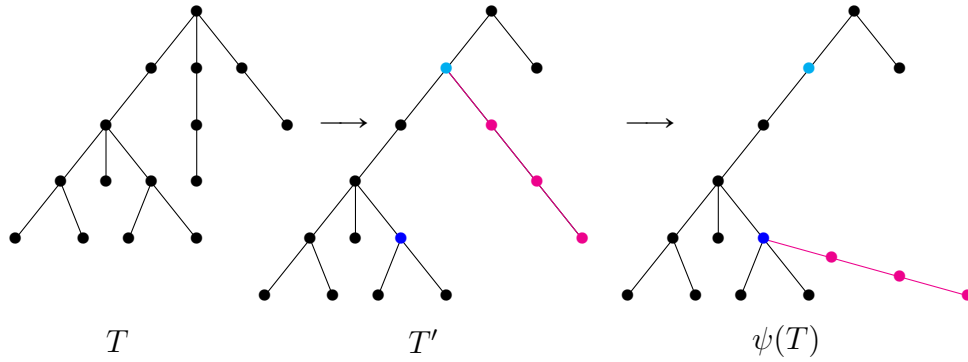

FIGURE 12. An example of case a2).

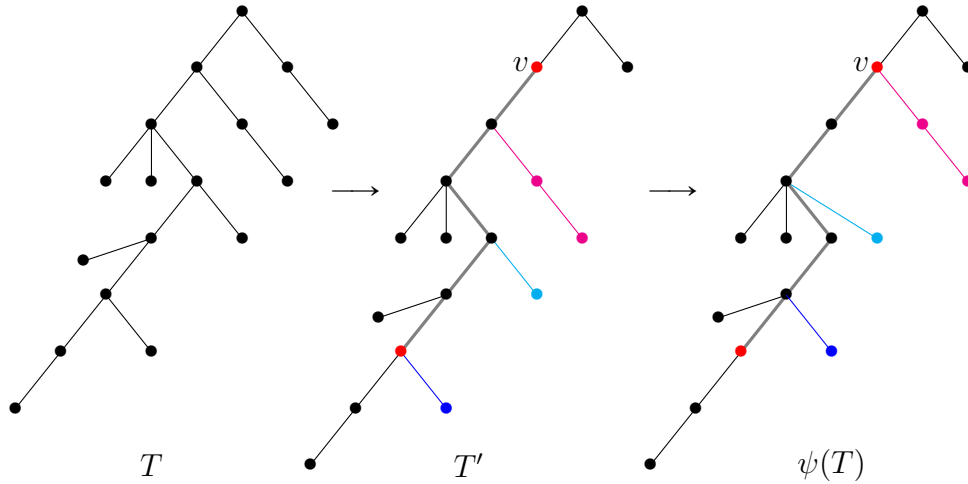

FIGURE 13. An example of case b1).

path in gray of T' in Fig. 13). Then, each node in P has at most one branch, which must be a path, to the right of P (see the three paths in color of T' in Fig. 13). In particular, there is no any branch of v to the right of P . Now define $\psi(T)$ to be the tree obtained from T' by moving all the paths connected to P (from the right side) one step up. See Fig. 13 for an example in this case. It is clear that $\text{rev}(\psi(T)) = \text{rev}(T') + 1 = \text{rev}(T)$.

- b2) **The rev-node of T' has elder siblings and the closest elder sibling has no children.** As in case b1), let P be the unique path in T' from the second node v in the left arm to the parent u of the rev-node. Then, each node in P has at most one branch, which must be a path, to the right of P . In particular, there is no any branch of v to the right of P . Now define $\psi(T)$ to be the tree obtained from T' by cutting the rightmost branch of u and attaching it to v as rightmost branch. See Fig. 14 for an example in this case. It is routine to check that $\text{rev}(\psi(T)) = \text{rev}(T') + 1 = \text{rev}(T)$.

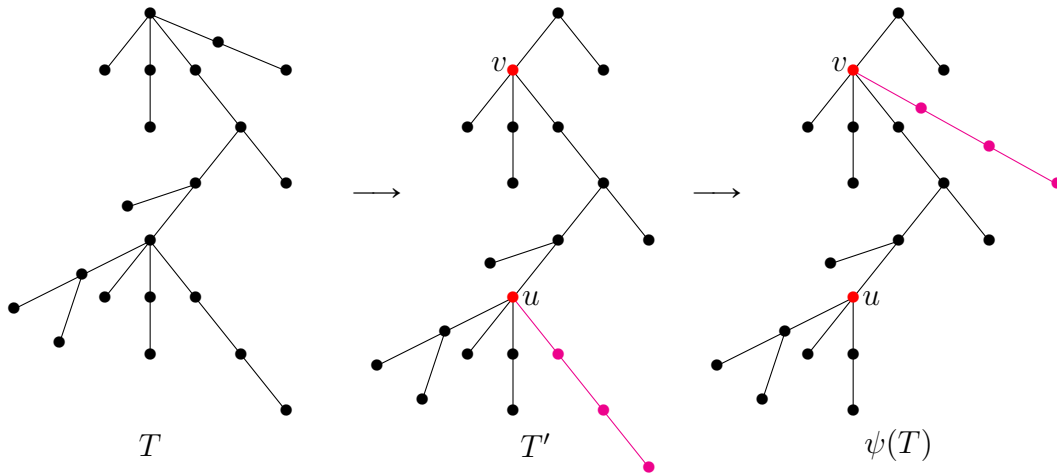

FIGURE 14. An example of case b2).

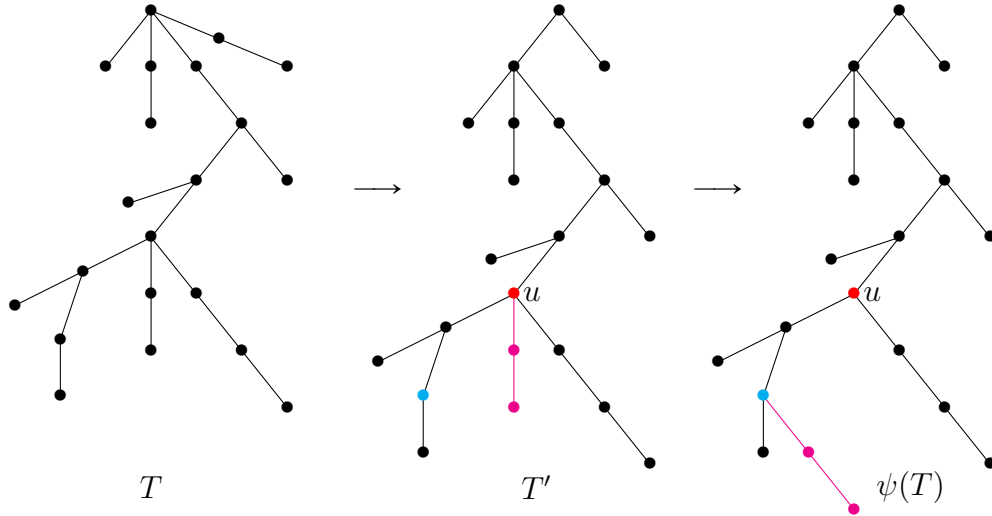

FIGURE 15. An example of case b3).

b3) **The rev-node of T' has elder siblings and the closest elder sibling has children.** Let u be the parent of the rev-node in T' . Let P be the branch of the subtree at u that contains the rev-node of T' . Then, P must be a path. Let B be the third branch (from right to left) of the subtree at u . Now define $\psi(T)$ to be the tree obtained from T' by cutting the path P and attaching it to the penultimate node on the right arm of B . See Fig. 15 for an example in this case. The reader is invited to check that $\text{rev}(\psi(T)) = \text{rev}(T') + 1 = \text{rev}(T)$.

It is clear from the above construction that the map $\psi : \mathcal{P}_n^{(k,2)} \rightarrow \mathcal{P}_n^{(k+1,1)}$ preserves the number of leaves. It remains to show that ψ is a bijection. We observe that each of the five cases in the construction of ψ is reversible and so we only need to figure out which case is involved for each specified tree. Given $T \in \mathcal{P}_n^{(k+1,1)}$, let us decompose T as in the right tree

in Fig. 11. If β_0 contains at least two nodes, then we apply the reverse operation of step (i) to retrieve $\psi^{-1}(T)$ directly. Otherwise, β_0 contains only one node and we can retrieve T' and then $\psi^{-1}(T)$ as follows.

Suppose that v is the second node in the left arm of T . If v is the rev-node, then $T' = T$. This corresponds to step (ii) case a1). Otherwise, v is not the rev-node and let P be the path from v to the parent u of the rev-node of T . For the sake of convenience, each extra branch (to the right of P) from a certain node x on P is called the ‘‘hanging branch’’ of x , and denoted as H_x (note that H_x must be a path). When such a hanging branch does not exist, we simply write $H_x = \emptyset$. So by the definition of P , the node u (the parent of the rev-node) must have $H_u \neq \emptyset$. We can retrieve T' in the following way:

- If the rev-node has no children and each node in P other than u has no hanging branch, then apply the reverse operation of step (ii) case a2) to get T' . In fact, T' is obtained from T by cutting H_u from u and attaching it to v so that it becomes the hanging branch for v .
- If the rev-node has no children and $H_v \neq \emptyset$, then apply the reverse operation of step (ii) case b2) to get T' . In this case, let T' be the tree obtained from T by cutting H_v from v and attaching it to u so that it becomes the new hanging branch for u .
- If the rev-node has no children and it is not in the above two situations, then apply the reverse operation of step (ii) case b3) to get T' . Suppose that x is the closest node to u on P with the property that $H_x \neq \emptyset$. We cut H_u and insert it to x as a middle branch between P and H_x . This new tree is then taken to be T' .
- If the rev-node has one child, then apply the reverse operation of step (ii) case b1) to get T' . Suppose that r is the rev-node of T and s is the child of r . We cut H_u from u and attach it to r so that it becomes the hanging branch for r and the node s becomes the new rev-node. For the remaining nodes on P , we ‘‘slide down’’ their hanging branches by one edge. Namely, if node y succeeds x on P , then we cut H_x and attach it to y so that it becomes the new hanging branch for y , and H_y is slid down to y 's successor if any, and so on and so forth. The new tree obtained this way is set to be T' .

Since the above cases are disjoint and exhaust all possible $T \in \mathcal{P}_n^{(k+1,1)}$ whose β_0 contains only one node, the map ψ is a bijection. \square

We also need the following bijection for the statistic ‘‘run’’ analogous to Lemma 3.11 for the statistic ‘‘rev’’.

Lemma 3.12. *Fix integers $n, k \geq 1$. There exists a bijection $\eta : \mathcal{P}_n^{(k,2)} \rightarrow \mathcal{P}_n^{(k+1,1)}$ preserving the degree sequences and the triple of statistics (run, leaf, bran).*

Proof. For a Dyck path $D \in \mathcal{D}_n$, denote by $\text{iest}(D)$ the number of initial consecutive east steps of D and by $\text{peak}(D)$ the number of peaks of D , where a peak of D is an east step followed immediately by a north step. For each $T \in \mathcal{P}_n$, the bijection τ satisfies $\text{bran}(T) = \text{iest}(\tau(T))$ and $\text{leaf}(T) = n + 1 - \text{peak}(\tau(T))$. If we introduce

$$\mathcal{D}_n^{(k,l)} := \{D \in \mathcal{D}_n : \text{iest}(D) \geq 2, \text{hrun}(D) = k, \text{ret}(D) = l\},$$

then Li and Lin [14] have constructed a bijection $f : \mathcal{D}_n^{(k,2)} \rightarrow \mathcal{D}_n^{(k+1,1)}$ that preserves the composition-type and the triple of statistics $(\text{vrun}, \text{iest}, \text{peak})$. It then follows from Lemma 3.10 that the bijection $\eta = \tau^{-1} \circ f \circ \tau$ has the required properties. \square

Remark 3.13. *Small examples (e.g., $n = 6, k = 1$) show that Lemma 3.11 for the statistic “rev” can not be refined further either by the number of branches or by the degree sequences.*

Now we are ready to construct recursively Ψ to prove Theorem 3.6.

Proof of Theorem 3.6. We will construct Ψ recursively with the help of Lemmas 3.11 and 3.12. Initially, the only tree in \mathcal{P}_1 is fixed under Ψ . For $n \geq 2$, suppose that the map Ψ is defined for \mathcal{P}_{n-1} . We perform the following three main cases to define Ψ for each tree $T \in \mathcal{P}_n$.

- (1) $\text{bran}(T) = 1$. Let T^* be the only branch of T . Define $\Psi(T)$ to be the tree with one branch $\Psi(T^*)$. Clearly, the triple of statistics $(\text{leaf}, \text{larm}, \text{rarm})$ is preserved and $\text{rev}(T) = \text{rev}(T^*) = \text{run}(\Psi(T^*)) = \text{run}(\Psi(T))$ in this case.
- (2) $\text{bran}(T) \geq 2$ and $\text{rarm}(T) \geq 2$. Let B be the subtree of T rooted at the penultimate node on the right arm of T . We further distinguish two subcases according to B :
 - $\text{bran}(B) \geq 2$. Define $\Psi(T)$ to be the tree obtained by replacing B in T by $\Psi(B)$. Clearly, the triple of statistics $(\text{leaf}, \text{larm}, \text{rarm})$ is preserved and $\text{rev}(T) = \text{rev}(B) = \text{run}(\Psi(B)) = \text{run}(\Psi(T))$ in this case.
 - $\text{bran}(B) = 1$. Let T^* be the tree obtained from T by deleting the last node in the right arm. Define $\Psi(T)$ to be the tree $\Psi(T^*)$ after adding to the last node in its right arm a child. Again, the triple of statistics $(\text{leaf}, \text{larm}, \text{rarm})$ is preserved and $\text{rev}(T) = \text{rev}(T^*) + 1 = \text{run}(\Psi(T^*)) + 1 = \text{run}(\Psi(T))$ in this case.
- (3) $\text{bran}(T) \geq 2$ and $\text{rarm}(T) = 1$. Suppose that $\text{larm}(T) = k + 1$ for some $k \geq 0$. We further distinguish two subcases according to the value k :
 - $k = 0$. In this case, let T^* be the tree obtained from T by deleting the eldest child of its root. Then define $\Psi(T)$ to be the tree obtained from $\Psi(T^*)$ by attaching a child to its root as eldest child. Clearly, the triple of statistics $(\text{leaf}, \text{larm}, \text{rarm})$ is preserved and $\text{rev}(T) = \text{rev}(T^*) = \text{run}(\Psi(T^*)) = \text{run}(\Psi(T))$ in this case.
 - $k \geq 1$. In this case, T is a tree in $\mathcal{P}_n^{(k+1,1)}$ and so $\psi^{-1}(T) \in \mathcal{P}_n^{(k,2)}$, which is a tree in case (2) above. Let $T' = \Psi(\psi^{-1}(T)) \in \mathcal{P}_n^{(k,2)}$ be obtained in case (2) above. Then define $\Psi(T) = \eta(T') \in \mathcal{P}_n^{(k+1,1)}$. By Lemmas 3.11 and 3.12, we see that the triple of statistics $(\text{leaf}, \text{larm}, \text{rarm})$ is preserved and $\text{rev}(T) = \text{rev}(\psi^{-1}(T)) = \text{run}(T') = \text{run}(\Psi(T))$ in this case.

It is easy to check that Ψ is a bijection by induction, which completes the proof of Theorem 3.6. \square

3.2. Generalized to rooted labeled trees. In this section, we show that the involution ϑ on binary trees and $\tilde{\vartheta}$ on plane trees can be generalized to right increasing binary trees and rooted labeled trees, respectively.

A *right increasing binary tree* on $[n]$ is a binary tree labeled by $[n]$ such that the label of each right child is greater than its parent. Let \mathcal{RB}_n be the set of all right increasing binary trees on $[n]$. A *rooted labeled tree* on $[n]_0 := \{0, 1, 2, \dots, n\}$ is a plane tree labeled by $[n]_0$

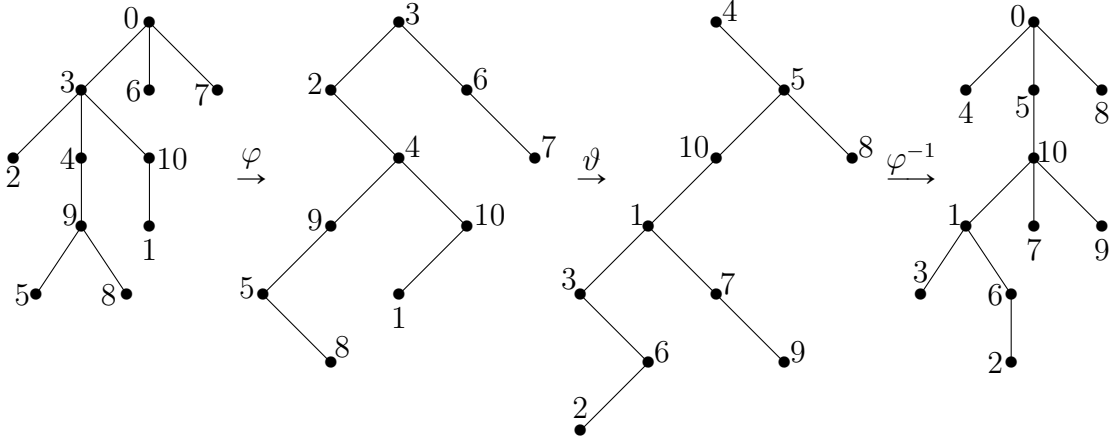

FIGURE 16. An example of the involution $\tilde{\vartheta} = \varphi \circ \vartheta \circ \varphi^{-1}$.

such that the root is labeled 0 and the labels of children of any node is increasing from left to right. Let \mathcal{LT}_n be the set of all rooted labeled trees on $[n]_0$. The bijection $\varphi : \mathcal{P}_n \rightarrow \mathcal{B}_n$ defined in Section 2 can be extended naturally to $\varphi : \mathcal{LT}_n \rightarrow \mathcal{RB}_n$. See Fig. 16 for an example of φ . Since it is well known [21] that the cardinality of \mathcal{LT}_n is $(n+1)^{n-1}$, then so is \mathcal{RB}_n .

We observe that our involution $\vartheta : \mathcal{B}_n \rightarrow \mathcal{B}_n$ can be generalized to \mathcal{RB}_n as follows. Given $T \in \mathcal{RB}_n$ whose underlying binary tree is B , define $\vartheta(T)$ to be the right increasing binary tree whose underlying binary tree is $\vartheta(B)$ and a node is labeled by i in $\vartheta(T)$ iff it is labeled by $n+1-i$ in T . See Fig. 16 for an example of ϑ .

Since the labeling is irrelevant for the seven tree statistics (spi , rspi , lrb , larm , rarm , rev , run), they can be extended naturally either to right increasing binary trees or to rooted labeled trees. Exactly the same discussions as in the proof of Theorem 3.1 results in the following analogue.

Theorem 3.14. *The involution $\vartheta : \mathcal{RB}_n \rightarrow \mathcal{RB}_n$ preserves the right chain sequences and switches the statistics “spi” and “rspi”.*

Introduce the refinement $T_{n,k}$ of the tree function $(n+1)^{n-1}$ by the exponential generating function

$$\sum_{n \geq 0} \sum_{k=1}^n T_{n,k} t^k \frac{x^n}{n!} = \left(1 - t \sum_{n \geq 1} (n-1)^{n-1} \frac{x^n}{n!} \right)^{-1}.$$

Among several other combinatorial interpretations found in [6, 7, 14], it was known that $T_{n,k}$ enumerates rooted labeled trees $T \in \mathcal{LT}_n$ with $\text{larm}(T) = k$ (or $\text{rarm}(T) = k$). As one application of Theorem 3.14, we have more interpretations for the triangle $T_{n,k}$ summarized in the following result, whose proof is the same as that for plane trees and will be omitted.

Proposition 3.15. *We have the following results concerning the bijection φ and the involution $\tilde{\vartheta} := \varphi \circ \vartheta \circ \varphi^{-1}$ (see Fig. 16 for an example of $\tilde{\vartheta}$).*

(i) *For any $T \in \mathcal{LT}_n$, we have*

$$\text{larm}(T) = \text{spi}(\varphi(T)), \quad \text{rev}(T) = \text{rspi}(\varphi(T)) \quad \text{and} \quad \text{rarm}(T) = \text{lrb}(\varphi(T)) + 1.$$

- (ii) The involution $\tilde{\vartheta} : \mathcal{LT}_n \rightarrow \mathcal{LT}_n$ preserves the degree sequences and the statistic “rarm” but switches the statistics “larm” and “rev”.
- (iii) Each statistic in $\{\text{spi}, \text{rspi}, \text{rev}, \text{lrb}\}$ is a new tree statistic that interprets the triangle $T_{n,k}$.

Regarding the counterpart of Theorem 3.6 for \mathcal{LT}_n , we have the following observations.

- The statistic “rev” is not equidistributed with “run” over \mathcal{LT}_4 .
- The triple (larm, rarm, rev) is not equidistributed with (rarm, larm, rev) over \mathcal{LT}_4 .
- Proposition 3.15 (ii) implies that the pair (rarm, rev) has the same distribution as (rarm, larm) over \mathcal{LT}_n . As the pair (rarm, larm) is symmetric by the mirror symmetry of rooted labeled trees, we see that (rarm, rev) is symmetric over \mathcal{LT}_n .

ACKNOWLEDGEMENT

The authors thank Joanna N. Chen and Jing Liu for their discussions that leads to the finding of Theorem 2.2. The authors also wish to thank the anonymous referee for carefully reading the paper and providing insightful comments and suggestions. This work was supported by the National Science Foundation of China grants 12322115, 12271301 and 12201641, and the project of Qilu Young Scholars of Shandong University.

REFERENCES

- [1] Z.-W. Bai and R.X.F. Chen, Equidistribution of decompositions of 132-avoiding permutations and consequences, [arXiv:2209.01961](https://arxiv.org/abs/2209.01961). [1](#), [2](#), [4](#), [7](#)
- [2] Y. Cai and C. Yan, Counting with Borel’s triangle, *Discrete Math.*, **342** (2019), 529–539. [12](#), [14](#)
- [3] W.Y.C. Chen and A.M. Fu, Context-free grammars for permutations and increasing trees, *Adv. in Appl. Math.*, **82** (2017), 58–82. [5](#)
- [4] W.Y.C. Chen, E. Deutsch and S. Elizalde, Old and young leaves on plane trees, *European J. Combin.*, **27** (2006), 414–427. [6](#)
- [5] X. Chen and S. Fu, Two bijections on weakly increasing trees, *Discrete Math.*, **345** (2022), Article 112760, 8 pp. [2](#), [5](#), [6](#), [7](#)
- [6] Z. Du, Some equidistributed statistics and applications to hook length formulas, preprint. [22](#)
- [7] R. Duarte and A. Guedes de Oliveira, The number of parking functions with center of a given length, *Adv. in Appl. Math.*, **107** (2019), 125–143. [15](#), [22](#)
- [8] *FindStat*: a database and search engine for combinatorial statistics and maps, <https://www.findstat.org>. [12](#)
- [9] P. Flajolet, Combinatorial aspects of continued fractions, *Discrete Math.*, **32** (1980), 125–161. [1](#)
- [10] S. Fu, Z. Lin and Y. Wang, A combinatorial bijection on di-sk trees, *Electron. J. Combin.*, **28** (2021), #P4.48, 23 pp. [2](#)
- [11] M. Jani and R.G. Rieper, Continued fractions and Catalan problems, *Electron. J. Combin.*, **7** (2000), #R45, 8pp. [2](#), [8](#)
- [12] C. Krattenthaler, Permutations with restricted patterns and Dyck paths, Special issue in honor of Dominique Foata’s 65th birthday, *Adv. Appl. Math.*, **27** (2001), 510–530. [8](#)
- [13] A.G. Kuznetsov, I.M. Pak and A.E. Postnikov, Increasing trees and alternating permutations, *Russian Math. Surveys*, **49** (1994), 79–114. [5](#)
- [14] Y. Li and Z. Lin, A symmetry on parking functions via Dyck paths, *Discrete Math.*, **346** (2023), Article 113426, 9pp. [14](#), [15](#), [16](#), [21](#), [22](#)
- [15] Z. Lin, J. Liu, S. Wang and W.J.T. Zang, More bijective combinatorics of weakly increasing trees, preprint. [5](#), [12](#)
- [16] Z. Lin and J. Ma, A symmetry on weakly increasing trees and multiset Schett polynomials, [arXiv:2104.10539](https://arxiv.org/abs/2104.10539). [5](#), [6](#), [12](#)

- [17] Z. Lin, J. Ma, S.-M. Ma and Y. Zhou, Weakly increasing trees on a multiset, *Adv. in Appl. Math.*, **129** (2021), Article 102206, 29 pp. [2](#), [5](#)
- [18] A. Reifegerste, On the diagram of 132-avoiding permutations, *European J. Combin.*, **24** (2003), 759–776. [8](#)
- [19] R.P. Stanley, *Enumerative Combinatorics*, vol. 1, Cambridge Stud. Adv. Math., vol. 49, Cambridge Univ. Press, Cambridge, 1997. [8](#)
- [20] R.P. Stanley, *Catalan numbers*, Cambridge University Press, New York, 2015. [1](#), [3](#), [8](#)
- [21] C. Yan, *Parking functions*, in: *Handbook of Enumerative Combinatorics* CRC Press Book, 2014. [22](#)

(Yang Li) RESEARCH CENTER FOR MATHEMATICS AND INTERDISCIPLINARY SCIENCES, SHANDONG UNIVERSITY & FRONTIERS SCIENCE CENTER FOR NONLINEAR EXPECTATIONS, MINISTRY OF EDUCATION, QINGDAO 266237, P.R. CHINA

Email address: 202117113@mail.sdu.edu.cn

(Zhicong Lin) RESEARCH CENTER FOR MATHEMATICS AND INTERDISCIPLINARY SCIENCES, SHANDONG UNIVERSITY & FRONTIERS SCIENCE CENTER FOR NONLINEAR EXPECTATIONS, MINISTRY OF EDUCATION, QINGDAO 266237, P.R. CHINA

Email address: linz@sdu.edu.cn

(Tongyuan Zhao) COLLEGE OF SCIENCE, CHINA UNIVERSITY OF PETROLEUM, 102249 BEIJING, P.R. CHINA

Email address: zhaotongyuan@cup.edu.cn