

LATTICE HOMOLOGY AND SEIBERG-WITTEN-FLOER SPECTRA

IRVING DAI, HIROFUMI SASAHIRA, AND MATTHEW STOFFREGEN

ABSTRACT. Using lattice homology, we give an explicit combinatorial description of the Seiberg-Witten-Floer spectrum $SWF(Y)$ for Y an almost-rational plumbed homology sphere. This class of manifolds includes all Seifert fibered rational homology spheres with base orbifold S^2 . Using our computations, we provide a calculation of Manolescu's κ -invariant for certain connected sums of these spaces.

1. INTRODUCTION

In [Fur01], Furuta initiated the use of stable homotopy theory in the study of the Seiberg-Witten equations via his proof of the 10/8-theorem. Building on these techniques, Manolescu [Man03] defined a Seiberg-Witten-Floer stable homotopy type $SWF(Y)$ for Y a rational homology sphere, partially implementing a program started by Floer [Flo89, CJS95] of realizing Floer homologies as the homology of some naturally-occurring spectra. Indeed, work of Lidman and Manolescu [LM18] has shown that for rational homology spheres, $SWF(Y)$ recovers the monopole Floer homology of Kronheimer and Mrowka [KM07]. Recent research has focused on defining a Seiberg-Witten-Floer stable homotopy type for 3-manifolds with $b_1 > 0$ and developing further formal properties of this theory [KM02, KLS18, KLS23, SS21, SS23]. The construction of a homotopy type for other invariants from low-dimensional or symplectic topology has likewise attracted a great deal of attention; see for example [LS14, MS21, AB21, AMS21, KL22].

Following work of Frøyshov [Frø96], Manolescu used $\text{Pin}(2)$ -equivariant Seiberg-Witten-Floer homology to define a new suite of Floer-theoretic invariants with a wide array of topological applications, exemplified by his disproof of the triangulation conjecture [Man16b]. (See also [Lin18].) Despite this success, there are few explicit computations of Seiberg-Witten-Floer spectra in the literature; or, for that matter, Floer spectra in others contexts. Although a significant amount of machinery has been established for computing and understanding Seiberg-Witten-Floer *homology*, progress on the homotopy side has been slow due to a lack of the typical tools present in Floer theory.

Indeed, to the best of the authors' knowledge, an (essentially) exhaustive list of all known non-trivial Seiberg-Witten-Floer homotopy types is presented in [Man14]: these consist of Brieskorn spheres of the form $\Sigma(2, 3, k)$.¹ Such examples follow from the work of Mrowka, Ozsváth, and Yu [MOY96], who provided an explicit description for the moduli spaces of the Seiberg-Witten equations on Seifert fibered homology spheres. In a handful of particularly simple cases, the critical points are such that the Seiberg-Witten-Floer spectrum is completely determined, giving the computations in [Man14].

The goal of the present paper is to expand the available computations of Seiberg-Witten-Floer spectra for 3-manifolds. We work with the class of almost-rational plumbed homology spheres; this includes all Seifert fibered rational homology spheres with base orbifold S^2 . Our approach is based on ideas from lattice homology, a combinatorial invariant for plumbed 3-manifolds which has its roots in work of Ozsváth and Szabó [OS03] and was formally introduced and developed

¹The behavior of SWF under connected sums and orientation reversal is also understood.

by Némethi [Ném08]. Lattice homology is now known, by work of Zemke, to be isomorphic to Heegaard Floer homology [Zem21] and has been used by several authors to understand various other invariants such as involutive Heegaard Floer homology and instanton Floer homology [DM19, ABDS20].

A key input from the work of Némethi [Ném08] is a re-formulation of lattice homology analogous to discrete Morse theory or persistent homology. We draw inspiration from this model to construct an S^1 -equivariant CW complex which we then prove computes the S^1 -equivariant Seiberg-Witten-Floer spectrum of any almost-rational homology sphere. Using some delicate equivariant homotopy theory, we are also able to determine the $\text{Pin}(2)$ -equivariant Seiberg-Witten-Floer spectrum of these examples. We use this to analyze Manolescu's κ -invariant [Man14] for certain connected sums.

Due to the work of Némethi, there is also a close connection between lattice homology and the study of surface singularities [Ném05, Ném08]. We demonstrate that the work in the present paper has a curious overlap with this program by showing that in certain cases, the Seiberg-Witten-Floer spectrum can be interpreted as a mapping cone between various sheaf cohomology groups associated to the resolution of a singularity. See Section 8 for a precise discussion.

1.1. Statement of results. Let Γ be a negative-definite plumbing graph. We denote the associated plumbing of 2-spheres by W_Γ and its boundary by Y_Γ . As discussed in Section 4, each spin^c -structure \mathfrak{s} on Y_Γ corresponds to an equivalence class $[k] \subset H^2(W_\Gamma; \mathbb{Z})$ of characteristic elements on W_Γ .

In general, the *lattice homology* $\mathbb{H}(\Gamma, [k])$ is a combinatorially-defined $\mathbb{F}[U]$ -module which is now known to be isomorphic to the Heegaard Floer homology of (Y_Γ, \mathfrak{s}) . If Γ is an *almost-rational plumbing* (see [Ném05, Definition 8.1]), then the lattice homology is especially simple and its output can be described in terms of an object called a *graded root* (see Section 2.1). We refer to the boundary of such a plumbing as an *almost-rational plumbed homology sphere*, or sometimes just an AR homology sphere. In Section 2.2 we describe how to construct an S^1 -equivariant spectrum $\mathcal{H}(\Gamma, [k])$ from the data of a graded root. The main theorem of this paper will be to show that this computes the S^1 -equivariant Seiberg-Witten-Floer spectrum of (Y_Γ, \mathfrak{s}) :

Theorem 1.1. *Let Y_Γ be an almost-rational plumbed homology sphere and \mathfrak{s} be a spin^c -structure on Y_Γ . Then we have an S^1 -equivariant homotopy equivalence*

$$\mathcal{H}(\Gamma, [k]) = \text{SWF}(Y_\Gamma, \mathfrak{s}).$$

Since the lattice homology $\mathbb{H}(\Gamma, [k])$ is combinatorial, this provides a combinatorial calculation of $\text{SWF}(Y_\Gamma, \mathfrak{s})$. Note that our construction of $\mathcal{H}(\Gamma, [k])$ factors through $\mathbb{H}(\Gamma, [k])$. Rather disappointingly, this indicates that (for such 3-manifolds) the Seiberg-Witten-Floer spectrum of (Y_Γ, \mathfrak{s}) is determined by its Floer homology; see Remark 2.1.

In the case that $[k]$ represents a self-conjugate spin^c -structure, it is also possible to upgrade $\mathcal{H}(\Gamma, [k])$ to a $\text{Pin}(2)$ -spectrum. The proof of Theorem 1.1 extends in a somewhat delicate way to show:

Theorem 1.2. *Let Y_Γ be an almost-rational plumbed homology sphere and \mathfrak{s} be a self-conjugate spin^c -structure on Y_Γ . Then we have a $\text{Pin}(2)$ -equivariant homotopy equivalence*

$$\mathcal{H}(\Gamma, [k]) = \text{SWF}(Y_\Gamma, \mathfrak{s}).$$

One especially effective application of Manolescu's construction has been in constraining the topology of spin 4-manifolds X with $\partial X = Y$. While several such restrictions may be derived using Seiberg-Witten-Floer homology (via the use of the invariants α, β , and γ of [Man16b]), if

$b_2^+(X)$ is large then the most useful constraint comes from the κ -invariant of [Man14]. Explicitly, consider the quantity

$$\xi(Y) = \max_{\substack{p, q \in \mathbb{Z} \\ q > 1}} \{p - q \mid \exists X \text{ spin with } \partial X = Y \text{ and } Q(X) = p(-E_8) \oplus q\left(\begin{smallmatrix} 1 & 0 \\ 0 & 1 \end{smallmatrix}\right)\},$$

where $Q(X)$ denotes the intersection form of X . In [Man14], it is shown that

$$\xi(Y) \leq \kappa(Y) - 1$$

for all integer homology spheres Y .

Since $\kappa(Y, \mathfrak{s})$ is defined in terms of the K -theory of $SWF(Y, \mathfrak{s})$ it is much harder to compute than the homological invariants α, β , and γ . The value of κ for many Seifert spaces was calculated by Ue in [Ue22], where it was also shown that $0 \leq \kappa(Y, \mathfrak{s}) + \bar{\mu}(Y, \mathfrak{s}) \leq 2$ for all Seifert fibered rational homology spheres. Here, $\bar{\mu}(Y, \mathfrak{s})$ is the Neumann-Siebenmann invariant. We sharpen and extend Ue's result to the class of all AR homology spheres:

Corollary 1.3. *Let Y be an AR homology sphere and \mathfrak{s} be a self-conjugate spin^c-structure on Y . Then there are two possibilities for $\kappa(Y, \mathfrak{s})$:*

- (1) *If $-\bar{\mu}(Y, \mathfrak{s}) = \delta(Y, \mathfrak{s})$, then $\kappa(Y, \mathfrak{s}) = -\bar{\mu}(Y, \mathfrak{s})$.*
- (2) *If $-\bar{\mu}(Y, \mathfrak{s}) < \delta(Y, \mathfrak{s})$, then $\kappa(Y, \mathfrak{s}) = -\bar{\mu}(Y, \mathfrak{s}) + 2$.*

Here, $\delta(Y, \mathfrak{s})$ is the monopole Frøyshov invariant.

Corollary 1.3 is similar to [Sto20, Corollary 1.2] and [Dai18, Theorem 2.4], in which it is shown that the α, β , and γ -invariants for an AR homology sphere are determined by $\delta(Y, \mathfrak{s})$ and $\bar{\mu}(Y, \mathfrak{s})$. Explicitly, we have

$$\beta(Y, \mathfrak{s}) = \gamma(Y, \mathfrak{s}) = -\bar{\mu}(Y, \mathfrak{s}),$$

while $\alpha(Y, \mathfrak{s})$ is either $\delta(Y, \mathfrak{s})$ or $\delta(Y, \mathfrak{s}) + 1$, depending on whether the parity of $-\bar{\mu}(Y, \mathfrak{s})$ coincides with that of $\delta(Y, \mathfrak{s})$. (Our orientation conventions are such that the set of AR homology spheres encompasses the class of *negative* Seifert spaces.) Hence in particular

$$-\bar{\mu}(Y, \mathfrak{s}) = \delta(Y, \mathfrak{s}) \text{ or } -\bar{\mu}(Y, \mathfrak{s}) < \delta(Y, \mathfrak{s}).$$

In the former case, we show that the local equivalence class of (Y, \mathfrak{s}) is trivial; this should be thought of as giving the dichotomy in Corollary 1.3.

We now specialize to the case when (Y, \mathfrak{s}) is *projective*, as defined in [Sto20, Section 5.2]. The class of projective AR homology spheres includes all positive integer surgeries on (right-handed) torus knots. Our goal will be to analyze the κ -invariant for connected sums of projective AR homology spheres:

Corollary 1.4. *Let $\{(Y_i, \mathfrak{s}_i)\}_{i=1}^n$ be a family of projective AR homology spheres. Then*

$$\kappa(\#_{i=1}^n (Y_i, \mathfrak{s}_i)) \leq -\sum_{i=1}^n \bar{\mu}(Y_i, \mathfrak{s}_i) + 2\lceil n/2 \rceil.$$

Note that understanding the behavior of κ under connected sums is significantly more difficult than the corresponding question for α, β , and γ (see [Sto17, Lin17] for results concerning the latter). Although it is possible to compute the entire K -theory in the case that (Y, \mathfrak{s}) is projective, this does not immediately yield Corollary 1.4 since equivariant K -theory does not have a Künneth formula. We also establish a more refined version of Corollary 1.4 in certain cases:

Corollary 1.5. *Let $\{(Y_i, \mathfrak{s}_i)\}_{i=1}^n$ be a family of projective AR homology spheres. Suppose that n is even and we have $-\bar{\mu}(Y_i, \mathfrak{s}_i) \leq \delta(Y_i, \mathfrak{s}_i) - 2$ for each i . Then*

$$\kappa(\#_{i=1}^n(Y_i, \mathfrak{s}_i)) = -\sum_{i=1}^n \bar{\mu}(Y_i, \mathfrak{s}_i) + n.$$

By applying Corollary 1.5 to self-connected sums of a single projective AR homology sphere, we obtain:

Corollary 1.6. *Let (Y, \mathfrak{s}) be a projective AR homology sphere with $-\bar{\mu}(Y, \mathfrak{s}) \leq \delta(Y, \mathfrak{s}) - 2$. Then*

$$\gamma(\#_{i=1}^n(Y, \mathfrak{s})) - \kappa(\#_{i=1}^n(Y, \mathfrak{s})) \rightarrow \infty$$

as $n \rightarrow \infty$. Furthermore,

$$\kappa(\#_{i=1}^n(-Y, \mathfrak{s})) - \alpha(\#_{i=1}^n(-Y, \mathfrak{s})) \rightarrow \infty$$

as $n \rightarrow \infty$.

This is in contrast to the asymptotic behavior of the invariants α , β , γ , and δ . Indeed, in [Sto17, Theorem 1.3], it is shown that

$$\alpha(\#_{i=1}^n(Y, \mathfrak{s})) - n\delta(Y, \mathfrak{s}), \quad \beta(\#_{i=1}^n(Y, \mathfrak{s})) - n\delta(Y, \mathfrak{s}), \quad \text{and} \quad \gamma(\#_{i=1}^n(Y, \mathfrak{s})) - n\delta(Y, \mathfrak{s})$$

are bounded functions of n .

We also explore some connections between $\mathcal{H}(\Gamma, [k])$ and Némethi's work regarding singularity theory [Ném05, Ném08]. To put this in context, recall that if $(X, 0)$ is an isolated surface singularity whose link is a rational homology sphere, then taking a *good resolution* \tilde{X} of X gives a plumbing of 2-spheres W_Γ equipped with a preferred analytic structure. In [Ném08], Némethi establishes an upper bound for the *geometric genus* of \tilde{X} in terms of the lattice homology $\mathbb{H}(\Gamma, [K])$.²

We show that if this upper bound is sharp, then it is possible to construct a certain mapping cone $\mathcal{H}(V_1, \dots, V_n)$ between various sheaf cohomology groups on \tilde{X} . (Our construction cannot be carried out unless the upper bound is sharp.) Moreover, $\mathcal{H}(V_1, \dots, V_n)$ turns out to be S^1 -homotopy equivalent to the lattice spectrum $\mathcal{H}(\Gamma, [K])$. Hence for certain plumbing graphs, the lattice spectrum $\mathcal{H}(\Gamma, [K])$ (which is a topological invariant) can be interpreted in terms of natural objects arising from certain analytic structures on W_Γ . The terms in the following theorem are defined in Section 8:

Theorem 1.7. *Let Γ be an extremal (almost-rational) plumbing graph equipped with an extremal analytic structure. Let $(x_i)_{i=0}^n$ be an extremal path of divisors. Consider the sequence of formal differences*

$$V_i = H^1(\tilde{X}, \mathcal{O}_{x_i})^* - H^0(\tilde{X}, \mathcal{O}_{x_i})^*$$

equipped with the inclusions induced by the sheaf maps $\mathcal{O}_{x_{i+1}} \rightarrow \mathcal{O}_{x_i}$. Up to suspension, the one-point compactification of the contracted mapping cone $\mathcal{H}(V_1, \dots, V_n)$ is S^1 -homotopy equivalent to the lattice homotopy type $\mathcal{H}(\Gamma, [K])$.

Theorem 1.7 is broadly reminiscent of the description of the critical sets by Mrowka, Ozsváth, and Yu [MOY96], who showed that if Y is a Seifert fibered space, the critical points of the Chern-Simons-Dirac functional (and flows between them) may be interpreted in terms of the algebraic geometry of a particular ruled surface.

²Here, K is the canonical characteristic element on W_Γ .

Finally, we indicate the construction of a general lattice spectrum in Section 5.1. As the current paper focuses on applications to Seiberg-Witten-Floer homotopy, we leave a full development of this theory to future work.

Organization. In Section 2, we provide a short summary of the construction and proof of Theorem 1.1. In Section 3 we review what we will need about stable homotopy categories and Seiberg-Witten Floer spectra, including the Bauer-Furuta maps and an exact triangle in Seiberg-Witten Floer spectra. In Section 4 we review lattice homology. Theorems 1.1 and 1.2 are proven in Sections 5 and 6. In Section 7, we analyze Manolescu’s κ -invariant for certain connected sums and establish some miscellaneous theorems pertaining to the lattice spectrum. Section 8 explores the connection between our construction and the work of Némethi in singularity theory. Finally, Section 9 provides an appendix which collects various technical results related to lattice homology.

Acknowledgments. The authors would like to thank Teena Gerhardt, Kristen Hendricks, Ciprian Manolescu, Ian Montague, Tomasz Mrowka, Andras Némethi, and Ian Zemke for helpful conversations. The first author was supported by NSF DMS-1902746 and NSF DMS-2303823. The second author was supported by JSPS KAKENHI Grant Number 23K03115. The third author was supported by NSF DMS-2203828.

2. OVERVIEW AND SKETCH OF PROOF

In this section, we describe how to compute the (S^1) -Seiberg-Witten-Floer spectra of AR plumbed homology spheres. In order to communicate the main ideas of the paper, we also give a brief outline of the proof. Details may be found in Section 5.

2.1. Preliminaries. Our proposed algorithm relies on understanding the output of lattice homology, as defined in [OS03, Ném08]. In particular, central to our discussion will be the notion of a graded root. We thus review this here.

Throughout, let Y be a plumbed homology sphere with plumbing graph Γ . Denote by W_Γ the plumbed 4-manifold corresponding to Γ and let \mathfrak{s} be a spin^c -structure on Y . As discussed in Section 4, we may identify \mathfrak{s} with an equivalence class $[k] \subset H^2(W_\Gamma; \mathbb{Z}) = \text{Hom}(H_2(W_\Gamma; \mathbb{Z}), \mathbb{Z})$ of characteristic elements on W_Γ .

The (*zeroth*) *lattice homology* $\mathbb{H}_0(\Gamma, [k])$ is a combinatorially-defined $\mathbb{Z}[U]$ -module constructed from $(\Gamma, [k])$. This was first introduced by Ozsváth and Szabó in [OS03] and generalized to the *higher lattice homology groups* $\mathbb{H}_i(\Gamma, [k])$ by Némethi [Ném08]. In [OS03, Ném08], it is shown that the $\mathbb{H}_i(\Gamma, [k])$ are invariants of (Y, \mathfrak{s}) , rather than the plumbing Γ . Moreover, if Y is an AR plumbed homology sphere, then $\mathbb{H}_0(\Gamma, [k])$ is isomorphic to $HF^-(Y, \mathfrak{s})$ and all higher lattice groups vanish; see [OS03, Theorem 1.2], [Ném05, Theorem 8.3], and [Ném08, Theorem 5.2.2].³ See Section 4.1 for the definition of lattice homology.

Importantly, $\mathbb{H}_0(\Gamma, [k])$ comes with a preferred basis over \mathbb{Z} , which is again independent of Γ . We record this preferred basis in the form of a *graded root* R . This is an upwards-opening tree with an infinite downwards stem, where each vertex of R is given a grading (represented by its height) lying in a coset of $2\mathbb{Z}$ in \mathbb{Q} . The vertices of R correspond to the preferred generators of $\mathbb{H}_0(\Gamma, [k])$ over \mathbb{Z} ; following edges downwards records multiplication by U . Note that the fact that $\mathbb{H}_0(\Gamma, [k])$ is represented by R places certain restrictions on $\mathbb{H}_0(\Gamma, [k])$: for instance, all

³For concreteness, we write HF^- here, as this is the original setting of [OS03] and [Ném08]. However, the appropriate monopole Floer or Seiberg-Witten-Floer homology groups can also be substituted.

generators of $\mathbb{H}_0(\Gamma, [k])$ differ in grading by an element of $2\mathbb{Z}$. An example of a graded root is given on the left of Figure 1.

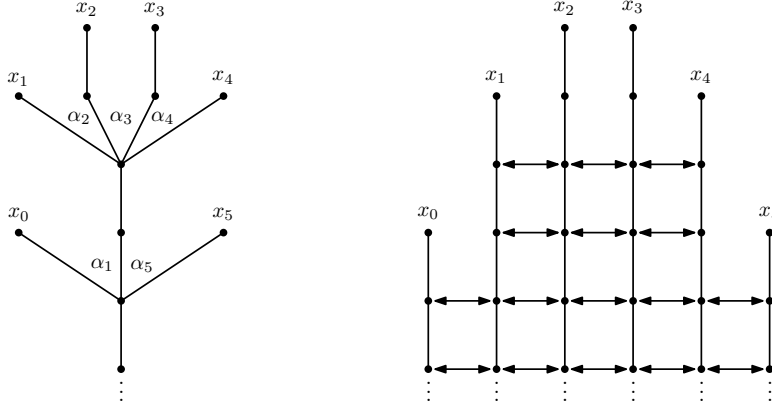

FIGURE 1. Left: a graded root. Right: a presentation of the corresponding $\mathbb{Z}[U]$ -module.

The structure of R gives a preferred presentation for $\mathbb{H}_0(\Gamma, [k])$ as a $\mathbb{Z}[U]$ -module, as follows. Label the leaves of R from left-to-right by x_0, x_1, \dots, x_n and label the upwards-opening angles of R from left-to-right by $\alpha_0, \alpha_1, \dots, \alpha_{n-1}$. Let $\text{gr}(x_i)$ be the Maslov grading of x_i and let $\text{gr}(\alpha_i)$ be the Maslov grading of the vertex at which α_i is based. Then $\mathbb{H}_0(\Gamma, [k])$ is isomorphic to

$$\text{span}_{\mathbb{Z}[U]}\{x_0, x_1, \dots, x_n\} / \sim \quad (2.1)$$

where \sim is generated over $\mathbb{Z}[U]$ by the relations

$$U^{\text{gr}(x_i) - \text{gr}(\alpha_i)/2} x_i \sim U^{\text{gr}(x_{i+1}) - \text{gr}(\alpha_i)/2} x_{i+1}$$

for $0 \leq i \leq n-1$. Visually, this is formed as follows: for each leaf x_i , we draw a $\mathbb{Z}[U]$ -tower starting in grading $\text{gr}(x_i)$. We then glue each successive pair of towers $\mathbb{Z}[U] \cdot x_i$ and $\mathbb{Z}[U] \cdot x_{i+1}$ along a subtower starting in grading $\text{gr}(\alpha_i)$, as in the right of Figure 1. We will use R interchangeably to refer to: (a) the graded root (as a combinatorial object); (b) the corresponding $\mathbb{Z}[U]$ -module; and even (c) the presentation (2.1) of this module.

2.2. The algorithm. Let $S^0 = \{\text{pt}\}^+$ (the point with a disjoint basepoint) and $S^2 = \mathbb{C}^+$ be given the usual S^1 -actions. Denote the S^1 -equivariant inclusion of S^0 into S^2 by $i: S^0 \hookrightarrow S^2$. Suspending this map gives an inclusion

$$\Sigma^n \mathbb{C}_i: S^n \hookrightarrow S^{n+2}$$

for any n , and thus an increasing sequence of S^1 -equivariant inclusions

$$S^0 \hookrightarrow S^2 \hookrightarrow S^4 \hookrightarrow \dots,$$

where $S^{2n} = (n\mathbb{C})^+$. Abusing notation, we denote each such inclusion (or composition of inclusions) uniformly by $i: S^{2m} \hookrightarrow S^{2n}$ for $m \leq n$.

Given a graded root R , we now construct an S^1 -equivariant space X in analogy with the presentation (2.1). First, cut R at some vertex of grading h on the infinite stem, such that any vertices of valency greater than two lie at or above the cut. For each leaf x_i of R , introduce an S^1 -sphere of dimension $\text{gr}(x_i) - h$. Define X by starting with the disjoint union of these spheres and quotienting by the equivalence relation \sim :

$$X = \left(\bigsqcup_{i=0}^n S^{\text{gr}(x_i) - h} \right) / \sim \quad (2.2)$$

where \sim is defined as follows. For each angle α_i , glue together the pair of successive spheres $S^{(\text{gr}(x_i)-h)}$ and $S^{(\text{gr}(x_{i+1})-h)}$ along the images of the inclusions

$$i: S^{(\text{gr}(\alpha_i)-h)} \hookrightarrow S^{(\text{gr}(x_i)-h)} \quad \text{and} \quad i: S^{(\text{gr}(\alpha_i)-h)} \hookrightarrow S^{(\text{gr}(x_{i+1})-h)}.$$

See the right of Figure 2 for an example. The parallel between (2.1) and (2.2) is clear: the spheres in (2.2) play the roles of the $\mathbb{Z}[U]$ -towers in (2.1), while the identification \sim of (2.2) is analogous to the subtower-gluing relation of (2.1). We will explain this further presently.

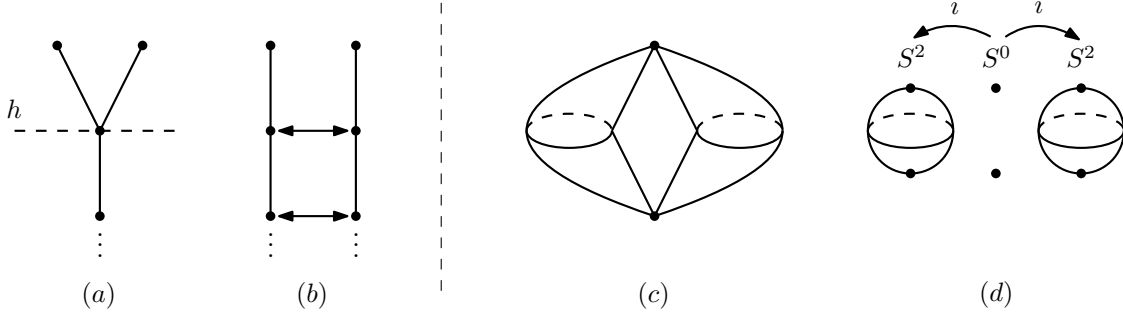

FIGURE 2. Illustration of the example $Y = \Sigma(2, 3, 7)$. Left: (a) the graded root corresponding to $HF^-(\Sigma(2, 3, 7))$ (together with a choice of h) and (b) its presentation from (2.1). Right: (c) the well-known spectrum $SWF(\Sigma(2, 3, 7))$, which is evidently formed by gluing the components of (d) together according to (2.2).

Decreasing the cutoff grading h corresponds to increasing the dimensions of all of the spheres in the construction of X , which is easily seen to be the same as suspending X by some \mathbb{C}^n . Hence X is well-defined up to suspension. We then define the (S^1) -lattice homotopy type associated to $(\Gamma, [k])$ to be

$$\mathcal{H}_0(\Gamma, [k]) = (X, 0, -h/2);$$

see Section 3.1 for the meaning of this notation. We often write this as the formal suspension $\Sigma^{(h/2)\mathbb{C}} X$, although $h/2$ here may be rational. Note that the S^1 -fixed point set of X is S^0 .

The main theorem of this paper will be to show that $\mathcal{H}_0(\Gamma, [k])$ is indeed homotopy equivalent to $SWF(Y, \mathfrak{s})$. In the case that \mathfrak{s} is self-conjugate, it is possible to put a $\text{Pin}(2)$ -action on X which calculates the $\text{Pin}(2)$ -equivariant Seiberg-Witten-Floer spectrum of Y . We discuss this in Section 6.2.

Remark 2.1. *A priori*, our construction of X depends on more than the combinatorial structure of R : we have also chosen a particular planar embedding of R in order to label the leaves of R from left-to-right. However, it is not difficult to show that choosing a different planar embedding does not change the homeomorphism class of X . In Lemma 7.2, we will show that X depends only on the isomorphism class of R as a $\mathbb{Z}[U]$ -module, rather than its graded root structure. However, the proof of Theorem 1.1 requires an understanding of the output of lattice homology as a graded root, which is why we emphasize this point-of-view.

2.3. Outline of proof. For the reader who is broadly familiar with the basics of both lattice homology and Seiberg-Witten-Floer homotopy, we now outline the proof of Theorem 1.1.

Computing the co-Borel homology. The first step of the proof is to show that the S^1 -equivariant homology of X is in fact isomorphic (as a $\mathbb{Z}[U]$ -module) to R . This certainly needs to be the case if Theorem 1.1 is to hold, since R is isomorphic to the monopole Floer (and thus the

Seiberg-Witten-Floer) homology of (Y, \mathfrak{s}) . More precisely, we wish to show that (up to an overall grading shift)

$$c\tilde{H}_*^{S^1}(X) \cong R,$$

where $c\tilde{H}_*^{S^1}(X)$ is the *co-Borel homology* of X . The definition of co-Borel homology may be found in [Man16b, Section 2.2], but this is almost unimportant: all we will need is that the co-Borel homology of S^{2n} is a single $\mathbb{Z}[U]$ -tower which starts in Maslov grading $2n$:

$$c\tilde{H}_*^{S^1}(S^{2n}) \cong \mathbb{Z}[U]_{2n}.$$

Note here that $\deg(U) = -2$. Moreover, it is straightforward to check that the map i_* on co-Borel homology induced by the inclusion $i: S^{2m} \hookrightarrow S^{2n}$

$$i_*: c\tilde{H}_*^{S^1}(S^{2m}) \cong \mathbb{Z}[U]_{2m} \rightarrow c\tilde{H}_*^{S^1}(S^{2n}) \cong \mathbb{Z}[U]_{2n},$$

simply maps the first tower to the subtower of the second starting in grading $2m$.

It is then not difficult to show that (roughly speaking) taking the co-Borel homology converts (2.2) into the presentation (2.1). Each sphere in the construction of X contributes a single $\mathbb{Z}[U]$ -tower to the co-Borel homology. The identification \sim of (2.2) (combined with the above observation regarding i_*) shows that successive $\mathbb{Z}[U]$ -towers are glued together along subtowers, precisely as (2.1). See Lemma 5.5 for further discussion.

Constructing a map of spectra. Having verified that X has the correct S^1 -equivariant homology, the second step of the proof is to construct (after appropriate suspension) an actual S^1 -equivariant map from X to $SWF(Y, \mathfrak{s})$:

$$\mathcal{T}: \mathcal{H}_0(\Gamma, [k]) \rightarrow SWF(Y, \mathfrak{s}).$$

For this, it will be helpful to draw on some intuition coming from lattice homology. We thus sketch how $\mathbb{H}_0(\Gamma, [k])$ is actually defined. In order to construct $\mathbb{H}_0(\Gamma, [k])$, we find a sequence of characteristic elements x_1, \dots, x_n in $[k]$ satisfying certain combinatorial conditions (see Theorem 4.9). Each of these is given the Maslov grading

$$\text{gr}(x_i) = \frac{1}{4}(x_i^2 + |\Gamma|).$$

The lattice homology $\mathbb{H}_0(\Gamma, [k])$ is constructed by quotienting the $\mathbb{Z}[U]$ -span of $\{x_0, x_1, \dots, x_n\}$ by a certain equivalence relation \sim defined in Section 4.1:

$$\mathbb{H}_0(\Gamma, [k]) = \text{span}_{\mathbb{Z}[U]}\{x_0, x_1, \dots, x_n\} / \sim.$$

This presentation of $\mathbb{H}_0(\Gamma, [k])$ is precisely the graded root R discussed in Section 2.1. The point we are making here is that the leaves of R correspond to certain characteristic elements in $[k]$, and thus to certain spin^c -structures on W_Γ .

This interpretation of $\mathbb{H}_0(\Gamma, [k])$ gives rise to the *lattice homology isomorphism map*

$$\mathbb{T}: R \cong \mathbb{H}_0(\Gamma, [k]) \rightarrow HF^-(Y, \mathfrak{s})$$

defined in [OS03]. Let

$$F_{W_\Gamma, x_i}: HF^-(S^3) \rightarrow HF^-(Y, \mathfrak{s})$$

be the cobordism map associated to the (punctured) cobordism W_Γ from S^3 to (Y, \mathfrak{s}) , equipped with the spin^c -structure corresponding to x_i . (Note that the x_i restrict to \mathfrak{s} on Y .) Set

$$\mathbb{T}(x_i) = F_{W_\Gamma, x_i}(1),$$

for some fixed generator $1 \in HF^-(S^3)$. Extending this map $\mathbb{Z}[U]$ -linearly gives a map from $\text{span}_{\mathbb{Z}[U]}\{x_0, x_1, \dots, x_n\}$ to $HF^-(Y, \mathfrak{s})$. In [OS03], it is shown that \mathbb{T} descends to the quotient

by \sim due to the adjunction relations of [OS06, Theorem 3.1]. These relate the images of the cobordism maps corresponding to different spin^c -structures on W_Γ . In [Ném05, Theorem 8.3] (see also [OS03, Theorem 1.2] and [Ném08, Theorem 5.2.2]), it is shown that if Y is an AR plumbed homology sphere, then \mathbb{T} is an isomorphism. See Section 4.2 for further discussion.

Roughly speaking, our map \mathcal{T} is defined by mimicking the construction of \mathbb{T} in the setting of Floer homotopy. For each x_i , consider the relative Bauer-Furuta invariant associated to (W_Γ, x_i) . This gives a homotopy class of map

$$\Psi_{W_\Gamma, x_i} : \Sigma^{(\text{gr}(x_i)/2)\mathbb{C}} SWF(S^3) \rightarrow SWF(Y, \mathfrak{s});$$

see Section 3.4. Now recall that in the suspension $\Sigma^{(h/2)\mathbb{C}} X$, the leaf x_i corresponds to a subsphere

$$\Sigma^{(h/2)\mathbb{C}}(S^{(\text{gr}(x_i)-h)}) = \Sigma^{(h/2)\mathbb{C}}\Sigma^{(\text{gr}(x_i)/2-h/2)\mathbb{C}} S^0 = \Sigma^{(\text{gr}(x_i)/2)\mathbb{C}} S^0.$$

We thus define \mathcal{T} on $\Sigma^{(h/2)\mathbb{C}}(S^{(\text{gr}(x_i)-h)}) \subset \mathcal{H}_0(\Gamma, [k])$ to be Ψ_{W_Γ, x_i} . Taking the disjoint union of these Bauer-Furuta maps defines \mathcal{T} on the disjoint union of spheres in (2.2). In Section 3.6, we establish an adjunction relation for Seiberg-Witten-Floer spectra which (roughly speaking) allows us conclude that the Bauer-Furuta maps associated to two consecutive x_i must coincide (up to homotopy) along a subsphere of a particular dimension. We use this to show that \mathcal{T} descends to a map on the quotient space $\mathcal{H}_0(\Gamma, [k])$. See Lemma 5.6 for further discussion.

The equivariant Whitehead theorem. As we show in Lemma 5.6, putting the above ingredients together gives a commutative diagram

$$\begin{array}{ccc} c\tilde{H}_*^{S^1}(\mathcal{H}_0(\Gamma, [k])) & & \\ \parallel & \searrow \mathcal{T}_* & \\ R & & c\tilde{H}_*^{S^1}(SWF(Y, \mathfrak{s})) \\ \parallel & \nearrow \mathbb{T} & \\ \mathbb{H}_0(\Gamma, [k]) & & \end{array}$$

Here, \mathcal{T}_* is the map on co-Borel homology induced by $\mathcal{T} : \mathcal{H}_0(\Gamma, [k]) \rightarrow SWF(Y, \mathfrak{s})$. The map \mathbb{T} out of the combinatorial object $\mathbb{H}_0(\Gamma, [k])$ is defined as in the previous section, except with $HF^-(Y, \mathfrak{s})$ replaced by $c\tilde{H}_*^{S^1}(SWF(Y, \mathfrak{s}))$; we note that *a priori*, even though \mathcal{T}_* is canonical, the map \mathcal{T} , up to homotopy, may depend on choices. That is, on each generator x_i of $\mathbb{H}_0(\Gamma, [k])$, we set $\mathbb{T}(x_i) = F_{W_\Gamma, x_i}(1)$, where F_{W_Γ, x_i} is the map on Seiberg-Witten-Floer *homology* corresponding to the spin^c -structure x_i on W_Γ .

There are two components of the final step. First, we show that \mathbb{T} is an isomorphism. Note that $\mathbb{H}_0(Y, [k])$ is isomorphic to $HF^-(Y, \mathfrak{s})$ by [Ném05, Theorem 8.3], so it is certainly the case that $\mathbb{H}_0(Y, [k])$ and $c\tilde{H}_*^{S^1}(SWF(Y, \mathfrak{s}))$ are isomorphic, since the latter is isomorphic to monopole Floer homology [LM18] and thus Heegaard Floer homology [KLT10, CGH12]. However, this isomorphism is not known to be natural with respect to cobordism maps. Hence this does not necessarily show that \mathbb{T} (defined in the context of Seiberg-Witten-Floer homology) is itself an isomorphism.

Instead, we simply replicate the original argument of [OS03, Ném05], replacing Heegaard Floer homology with Seiberg-Witten-Floer homology. The argument of [OS03, Ném05] depends on certain formal properties of the Heegaard Floer package, the most prominent of which is the existence of a surgery exact sequence. In the setting of Seiberg-Witten-Floer homology, this has

recently been established by the second and third authors [SS23]. For readers unfamiliar with [OS03, Ném05], we give an overview of the argument in Section 9.

The above commutative diagram then shows that the induced map on co-Borel homology \mathcal{T}_* is an isomorphism. The final component of the proof is to appeal to an equivariant Whitehead theorem. Indeed, in Lemma 5.7 we show that in this situation, the fact that \mathcal{T} induces an isomorphism on co-Borel homology suffices, along with limited other information from the geometric situation, to establish that \mathcal{T} is an S^1 -equivariant homotopy equivalence.

3. REVIEW OF SEIBERG-WITTEN FLOER SPECTRUM

In this section, we will review the Seiberg-Witten Floer spectrum and relative Bauer-Furuta invariant. Also we will recall some basic facts from homotopy theory.

3.1. Stable homotopy categories. We will define an S^1 -equivariant stable homotopy category \mathfrak{C}_{S^1} to define S^1 -equivalent Seiberg-Witten Floer spectrum. The category \mathfrak{C}_{S^1} was introduced in [Man03, Section 6].

An object of \mathfrak{C}_{S^1} is a triple (W, m, n) , where W is a pointed S^1 -CW complex, $m \in \mathbb{Z}$ and $n \in \mathbb{Q}$. For objects (W_0, m_0, n_0) and (W_1, m_1, n_1) of \mathfrak{C}_{S^1} , the set of morphisms is defined by

$$\text{Mor}_{\mathfrak{C}_{S^1}}((W_0, m_0, n_0), (W_1, m_1, n_1)) = \lim_{p, q \rightarrow \infty} [\Sigma^{p\mathbb{R} \oplus q\mathbb{C}} W_0, \Sigma^{(p+m_0-m_1)\mathbb{R} \oplus (q+n_0-n_1)\mathbb{C}} W_1]_{S^1}^0$$

if $n_1 - n_0 \in \mathbb{Z}$, and we define it to be the empty set otherwise, where $[X, Y]_{S^1}$ is the set of S^1 -equivariant (unstable) homotopy classes $X \rightarrow Y$. For a finite dimensional complex vector space F with an S^1 -action induced by the complex structure, we define the desuspension $\Sigma^{-F}(W, m, n)$ by

$$\Sigma^{-F}(W, m, n) := (W, m, n + \dim_{\mathbb{C}} F).$$

For a finite dimensional real vector space F with the trivial S^1 -action, we define

$$\Sigma^{-F}(W, m, n) := (\Sigma^F W, m + 2 \dim_{\mathbb{R}} F, n).$$

The reason why we define $\Sigma^{-F}(W, m, n)$ to be $(\Sigma^F W, m + 2 \dim_{\mathbb{R}} F, n)$ rather than $(\Sigma^F W, m + \dim_{\mathbb{R}} F, n)$ is the following. Note that the homotopy class of a trivialization $f : F \rightarrow \mathbb{R}^p$ is not unique since $\pi_0(O(p)) = \mathbb{Z}_2$. Hence we do not have a canonical identification between (W, m, n) and $\Sigma^F(W, m + \dim_{\mathbb{R}} F, n)$. However, the homotopy class of the trivialization $f \oplus f : F \oplus F \rightarrow \mathbb{R}^{2p}$ is independent of the choice of f and we have a canonical identification

$$\Sigma^F(\Sigma^F W, m + 2 \dim_{\mathbb{R}} F, n) = (\Sigma^{F \oplus F} W, m + 2 \dim_{\mathbb{R}} F, n) \cong (\Sigma^{2p\mathbb{R}} W, m + 2p, n) \cong (W, m, n)$$

up to homotopy.

For $q \in \mathbb{Q}$, we denote $(S^0, 0, q)$ by $S^{-q\mathbb{C}}$.

We will introduce a $\text{Pin}(2)$ -equivariant stable homotopy category $\mathfrak{C}_{\text{Pin}(2)}$ to define $\text{Pin}(2)$ -equivariant Seiberg-Witten Floer spectrum. Let $\tilde{\mathbb{R}}$ be the non-trivial, one dimensional real representation of $\text{Pin}(2)$. An object of $\mathfrak{C}_{\text{Pin}(2)}$ is a triple (W, m, n) , where W is a pointed $\text{Pin}(2)$ -CW complex, $m \in \mathbb{Z}$ and $n \in \mathbb{Q}$. We define the set of morphisms by

$$\begin{aligned} & \text{Mor}_{\mathfrak{C}_{\text{Pin}(2)}}((W_0, m_0, n_0), (W_1, m_1, n_1)) \\ & := \lim_{p, q, r \rightarrow \infty} [\Sigma^{p\mathbb{R} \oplus q\tilde{\mathbb{R}} \oplus r\mathbb{H}} W_0, \Sigma^{p\mathbb{R} \oplus (q+m_0-m_1)\tilde{\mathbb{R}} \oplus (r+n_0-n_1)\mathbb{H}} W_1]_{\text{Pin}(2)}^0, \end{aligned}$$

if $n_0 - n_1 \in \mathbb{Z}$ and we define it to be the empty set otherwise. For a $\text{Pin}(2)$ -representation F which is isomorphic to $\tilde{\mathbb{R}}^a \oplus \mathbb{H}^b$, we define

$$\Sigma^{-F}(W, m, n) := (\Sigma^{FS^1} W, m + 2a, n + b).$$

For $q \in \mathbb{Q}$, we denote $(S^0, 0, q)$ by $S^{-q\mathbb{H}}$.

3.2. Seiberg-Witten Floer spectrum. We will explain how to define the Seiberg-Witten Floer spectrum $SWF(Y, \mathfrak{s})$ briefly. See [Man03] for the details.

Let (Y, \mathfrak{s}) be a spin^c rational homology 3-sphere and take a Riemann metric g on Y . Write S for the spinor bundle and A_0 for a flat spin^c -connection on Y . We have the Clifford multiplication

$$\rho : T^*Y \otimes \mathbb{C} \xrightarrow{\cong} \mathfrak{sl}(S).$$

The Chern-Simons-Dirac function $CSD : i\Omega^1(Y) \oplus \Gamma(S) \rightarrow \mathbb{R}$ is defined by

$$CSD(a, \phi) = -\frac{1}{2} \int_Y a \wedge da + \frac{1}{2} \int_Y \langle D_a \phi, \phi \rangle d\mu_g.$$

Here $D_a : \Gamma(S) \rightarrow \Gamma(S)$ is the Dirac operator associated to the connection $A_0 + a$. The gradient vector field of CSD with respect to the L^2 -inner product is given by

$$\text{grad}_{L^2} CSD(a, \phi) = (*da + q(\phi), D_a \phi),$$

where

$$q(\phi) = \rho^{-1} \left(\phi \otimes \phi^* - \frac{1}{2} \text{Tr}(\phi \otimes \phi^*) id \right).$$

The gradient trajectory equation

$$\begin{aligned} \tilde{\gamma} : \mathbb{R} &\rightarrow i\Omega^1(Y) \oplus \Gamma(S), \\ \frac{\partial \tilde{\gamma}}{\partial t}(t) &= -\text{grad}_{L^2} CSD(\tilde{\gamma}(t)) \end{aligned} \tag{3.1}$$

of CSD is the Seiberg-Witten equations on $Y \times \mathbb{R}$.

To define $SWF(Y, \mathfrak{s})$, we need to take the Coulomb gauge slice:

$$V := i \ker(d^* : \Omega^1(Y) \rightarrow \Omega^0(Y)) \oplus \Gamma(S).$$

Let Π_C be the map $i\Omega^1(Y) \oplus \Gamma(S) \rightarrow V$ defined by

$$\Pi_C(a, \phi) := (a - d\xi(a), e^{\xi(a)} \phi),$$

where $\xi(a)$ is the unique function $Y \rightarrow i\mathbb{R}$ which satisfies

$$\Delta \xi(a) = d^* a, \quad \int_Y \xi(a) d\mu_g = 0.$$

The pushforward $\Pi_{C^*(a, \phi)} : i\Omega^1(Y) \oplus \Gamma(S) \rightarrow V$ of Π_C at (a, ϕ) is given by the formula

$$\Pi_{C^*(a, \phi)}(b, \psi) = (b - d\xi(b), \psi + \xi(b)\phi).$$

We consider the following equation for $\gamma : \mathbb{R} \rightarrow V$:

$$\frac{\partial \gamma}{\partial t}(t) = -\Pi_{C^*} \text{grad}_{L^2} CSD(\gamma(t)). \tag{3.2}$$

We can write

$$\Pi_{C^*} \text{grad}_{L^2} CSD(a, \phi) = l(a, \phi) + c(a, \phi),$$

where l is the self-adjoint operator on V defined by

$$l = *d \oplus D_{A_0},$$

and the non-linear term $c(a, \phi)$ is given by

$$c(a, \phi) = (q(\phi) - d\xi(q(\phi)), \rho(a)\phi + \xi(q(\phi))\phi).$$

We can see that if $\tilde{\gamma}$ is a solution to (3.1), then $\gamma := \Pi_C \tilde{\gamma}$ is a solution to (3.2). Conversely, if γ is a solution to (3.2), a lift $\tilde{\gamma}$ of γ is a solution to (3.1).

The vector field $\Pi_{C^*} \text{grad}_{L^2} CSD$ on V is the gradient vector field of $CSD|_V$ with respect to a metric on V . See [KLS18, Section 2]. Hence if $\gamma : \mathbb{R} \rightarrow V$ is a solution to (3.2), then $CSD(\gamma(t))$ decreases in t . We define the energy $E(\gamma)$ of γ by

$$E(\gamma) = \lim_{t \rightarrow -\infty} CSD(\gamma(t)) - \lim_{t \rightarrow \infty} CSD(\gamma(t)) \in \mathbb{R}_{\geq 0} \cup \{\infty\}.$$

We have the following compactness result for finite energy solutions to (3.2).

Proposition 3.1. *Let k be a non-negative number. Then there is a positive constant $R = R_k$ such that for any solution $\gamma : \mathbb{R} \rightarrow V$ with $E(\gamma) < \infty$ and $t \in \mathbb{R}$, we have*

$$\|\gamma(t)\|_{L_k^2(Y)} < R.$$

We will take finite dimensional approximations of (3.2) as follows. Fix $k \geq 2$ and let $R = R_k$ be the positive constant of Proposition 3.1. For $\lambda, \mu \in \mathbb{R}$ with $\lambda < \mu$, let V_λ^μ denote the subspace of V spanned by eigenvectors of l whose eigenvalues are in $(\lambda, \mu]$. By the standard theory of elliptic differential operators, the dimension of V_λ^μ is finite. Let p_λ^μ be the L^2 -projection onto V_λ^μ and $\chi : V \rightarrow [0, 1]$ be a smooth cut off function such that

$$\chi|_{B(V_\lambda^\mu, 2R)} \equiv 1, \quad \text{supp}(\chi) \subset B(V_\lambda^\mu, 3R),$$

where for $r > 0$

$$B(V_\lambda^\mu, r) = \{(a, \phi) \in V_\lambda^\mu \mid \|(a, \phi)\|_{L_k^2(Y)} \leq r\}.$$

We consider the following equation

$$\frac{\partial \gamma}{\partial t}(t) = -\chi(\gamma(t))\{l(\gamma(t)) + p_\lambda^\mu c(\gamma(t))\}$$

for $\gamma : \mathbb{R} \rightarrow V_\lambda^\mu$.

This equation generates an approximated Seiberg-Witten flow

$$\varphi_\lambda^\mu : V_\lambda^\mu \times \mathbb{R} \rightarrow V_\lambda^\mu.$$

This flow is S^1 -equivariant, where the S^1 -action on V_λ^μ is defined by complex multiplication on the spinor component. Using Proposition 3.1, we can prove the following:

Proposition 3.2 ([Man03]). *For $\lambda \ll 0$ and $\mu \gg 0$, the ball $B(V_\lambda^\mu, R)$ is an isolating neighborhood with respect to the flow φ_λ^μ . That is, the maximal invariant set $\text{Inv}(B(V_\lambda^\mu, R), \varphi_\lambda^\mu)$ in $B(V_\lambda^\mu, R)$ is included in the interior $\text{Int}(B(V_\lambda^\mu, R))$.*

This proposition implies that we can take an S^1 -equivariant index pair $(N_\lambda^\mu, L_\lambda^\mu)$ of the invariant set $\text{Inv}(B(V_\lambda^\mu, R), \varphi_\lambda^\mu)$ [Con78, Flo87].

Let $n(Y, g, \mathfrak{s})$ be the rational number defined by

$$n(Y, g, \mathfrak{s}) := \text{ind } D_{\hat{A}_0} - \frac{c_1(\mathfrak{t})^2 - \sigma(X)}{8}. \quad (3.3)$$

Here $(X, \hat{g}, \mathfrak{t})$ is a compact, spin^c Riemannian 4-manifold with boundary (Y, g, \mathfrak{s}) , \hat{A}_0 is a spin^c connection on X with $\hat{A}_0|_Y = A_0$ and $D_{\hat{A}_0}$ is the Dirac operator on X associated to \hat{A}_0 . We can show that $n(Y, g, \mathfrak{s})$ depends only on Y, g and \mathfrak{s} .

Definition 3.3. We define the S^1 -equivariant Seiberg-Witten Floer spectrum $SWF(Y, \mathfrak{s})$ to be the object $\Sigma^{-V_\lambda^0}(N_\lambda^\mu/L_\lambda^\mu, 0, n(Y, g, \mathfrak{s}))$ of the category \mathfrak{C}_{S^1} for fixed real numbers λ, μ with $\lambda \ll 0, \mu \gg 0$.

If \mathfrak{s} is a spin structure on Y , the spinor bundle S is a quaternionic vector bundle and we have a $\text{Pin}(2)$ -action on V , where the action of j is given by

$$j(a, \phi) = (-a, \phi j).$$

The equation (3.2) is $\text{Pin}(2)$ -equivariant, and we can choose a $\text{Pin}(2)$ -equivariant index pair $(N_\lambda^\mu, L_\lambda^\mu)$ for $\text{Inv}(B(V_\lambda^\mu, R), \varphi_\lambda^\mu)$.

Definition 3.4. For a closed, spin 3-manifold (Y, \mathfrak{s}) , we define the $\text{Pin}(2)$ -equivariant Seiberg-Witten Floer spectrum $SWF(Y, \mathfrak{s})$ to be the object $\Sigma^{-V_\lambda^0}(N_\lambda^\mu/L_\lambda^\mu, 0, \frac{1}{2}n(Y, g, \mathfrak{s}))$ of $\mathfrak{C}_{\text{Pin}(2)}$ for fixed real numbers λ, μ with $\lambda \ll 0, \mu \gg 0$.

We can prove that $SWF(Y, \mathfrak{s})$ is independent of the choices and is an invariant of (Y, \mathfrak{s}) .

Proposition 3.5 ([Man03]). *The object $SWF(Y, \mathfrak{s})$ is independent of the choices of $\lambda, \mu, (N_\lambda^\mu, L_\lambda^\mu)$ and metric g , up to canonical isomorphisms in \mathfrak{C}_{S^1} . If \mathfrak{s} is spin, $SWF(Y, \mathfrak{s})$ is independent of the choices, up to canonical isomorphisms in $\mathfrak{C}_{\text{Pin}(2)}$.*

We have a duality between $SWF(Y, \mathfrak{s})$ and $SWF(-Y, \mathfrak{s})$.

Proposition 3.6 ([Man07]). *There is a natural S -duality morphism*

$$\eta : SWF(Y, \mathfrak{s}) \wedge SWF(-Y, \mathfrak{s}) \rightarrow S^0$$

in \mathfrak{C}_{S^1} . If \mathfrak{s} is spin, we can take η as a morphism in $\mathfrak{C}_{\text{Pin}(2)}$.

Let (Y, \mathfrak{s}) be a closed, spin^c 3-manifold with $b_1 > 0$. We write $\mathfrak{C}_{S^1}^{\text{ind}}, \mathfrak{C}_{S^1}^{\text{pro}}$ for the categories of inductive systems and projective systems in \mathfrak{C}_{S^1} . In [KLS18], two types of Seiberg-Witten Floer spectra are defined:

$$\begin{aligned} \underline{swf}^A(Y, \mathfrak{s}, g, A_0) &= (I_0 \xrightarrow{i_0} I_1 \xrightarrow{i_1} I_2 \xrightarrow{i_2} \dots) \in \text{Ob}(\mathfrak{C}_{S^1}^{\text{ind}}), \\ \underline{swf}^R(Y, \mathfrak{s}, g, A_0) &= (\bar{I}_0 \xleftarrow{j_0} \bar{I}_1 \xleftarrow{j_1} \bar{I}_2 \xleftarrow{j_2} \dots) \in \text{Ob}(\mathfrak{C}_{S^1}^{\text{pro}}). \end{aligned}$$

Here g is a Riemannian metric on Y , A_0 is a fixed spin^c connection on Y , I_m, \bar{I}_m are objects of \mathfrak{C} which are desuspension of Conley indices of approximated Seiberg-Witten flow and i_m, j_m are morphisms of \mathfrak{C} which are induced by attractor and repeller maps. These Floer spectra are called unfolded Seiberg-Witten Floer spectra and it is expected that their S^1 -homologies are isomorphic to the monopole Floer homologies with coefficients in a local system whose fiber is the group ring $\mathbb{Z}[H^1(Y; \mathbb{Z})]$.

These Seiberg-Witten Floer spectra depend on the choices of g, A_0 . If $c_1(\mathfrak{s})$ is torsion, we can define normalized Seiberg-Witten Floer spectra which are independent of the choices of g, A_0 . Assume that $c_1(\mathfrak{s})$ is torsion. Then we can define a rational number $n(Y, \mathfrak{s}, g, A_0)$ as in (3.3). Put

$$\begin{aligned} \underline{SWF}^A(Y, \mathfrak{s}) &= (\underline{swf}^A(Y, \mathfrak{s}, g, A_0), 0, n(Y, \mathfrak{s}, g, A_0)) \in \text{Ob}(\mathfrak{C}_{S^1}^{\text{ind}}), \\ \underline{SWF}^R(Y, \mathfrak{s}) &= (\underline{swf}^R(Y, \mathfrak{s}, g, A_0), 0, n(Y, \mathfrak{s}, g, A_0)) \in \text{Ob}(\mathfrak{C}_{S^1}^{\text{pro}}). \end{aligned}$$

We can show that $\underline{SWF}^A(Y, \mathfrak{s}), \underline{SWF}^R(Y, \mathfrak{s})$ are independent of choices of g, A_0 up to isomorphisms.

For a spin 3-manifold (Y, \mathfrak{s}) , we can define Seiberg-Witten Floer spectra $\underline{swf}^A(Y, \mathfrak{s}, g, A_0), \underline{SWF}^A(Y, \mathfrak{s}), \underline{swf}^R(Y, \mathfrak{s}, g, A_0), \underline{SWF}^R(Y, \mathfrak{s})$ in the categories $\mathfrak{C}_{\text{Pin}(2)}^{\text{ind}}, \mathfrak{C}_{\text{Pin}(2)}^{\text{pro}}$.

In [KLS23, Section 4.3], it was proved that $\underline{swf}^A(Y, \mathfrak{s}, g, A_0)$ and $\underline{SWF}^A(Y, \mathfrak{s})$ are Spanier-Whitehead dual to $\underline{swf}^R(-Y, \mathfrak{s}, g, A_0)$ and $\underline{SWF}^R(-Y, \mathfrak{s})$.

There is another version of Seiberg-Witten Floer spectrum. In [SS21], the second and third authors defined Seiberg-Witten Floer spectrum whose S^1 -homology is conjecturally isomorphic to the monopole Floer homology with coefficients in \mathbb{Z} . It is defined as a parametrized spectrum over the Picard torus $\text{Pic}(Y)$.

3.3. CW complex of Type SWF. Following [Man14] and [Man16b], we will make the following definition:

Definition 3.7. Let X be a pointed S^1 -CW complex and l be a non-negative integer. We say that X is of type SWF at level l if the following conditions are satisfied:

- (1) The action of S^1 is free on $X - X^{S^1}$.
- (2) The S^1 -fixed point set is homotopy equivalent to $S^{l\mathbb{R}}$.

Let X be a pointed $\text{Pin}(2)$ -CW complex and l be a non-negative integer. We say that X is of type SWF at level l if the following conditions are satisfied:

- (1) The action of $\text{Pin}(2)$ is free on $X - X^{S^1}$.
- (2) The S^1 -fixed point set X^{S^1} is $\text{Pin}(2)$ -homotopy equivalent to $S^{l\mathbb{R}}$.

Lemma 3.8. *Let X be a pointed S^1 -CW complex of type SWF. For a subgroup H of S^1 , we have*

$$X^H = \begin{cases} X & \text{if } H = 1, \\ X^{S^1} & \text{if } H \neq 1. \end{cases}$$

Here X^H is the H -fixed point set. Let X be a pointed $\text{Pin}(2)$ -CW complex of type SWF. For a subgroup H of $\text{Pin}(2)$, we have

$$X^H = \begin{cases} X & \text{if } H = 1, \\ X^{S^1} & \text{if } H \neq 1, H \subset S^1, \\ X^{\text{Pin}(2)} & \text{if } H \not\subset S^1. \end{cases}$$

Proof. The statement follows from the condition that the action is free on $X - X^{S^1}$. □

We also recall some general facts:

Theorem 3.9 (Equivariant Whitehead theorem). *Let G be a compact Lie group and X, Y be G -CW complexes. A G -map $f : X \rightarrow Y$ is a G -homotopy equivalence if and only if the restriction $f^H : X^H \rightarrow Y^H$ is a weak homotopy equivalence for each closed subgroup H of G .*

Proposition 3.10. *Let X, Y be simply connected CW complexes. A continuous map $f : X \rightarrow Y$ is a homotopy equivalence if and only if the induced map $f_* : H_*(X; \mathbb{Z}) \rightarrow H_*(Y; \mathbb{Z})$ is an isomorphism.*

Lemma 3.11 ([tD87, Chapter II, Lemma (4.15)]). *Let G be a compact Lie group and X, Y be pointed G -CW complexes such that $X = \Sigma A$ for some pointed G -CW complex A and Y^G is simply connected. We write $[X, Y]_G$ and $[X, Y]_G^0$ for the sets of homotopy classes of G -maps $X \rightarrow Y$ and homotopy classes of G -maps $X \rightarrow Y$ preserving base points respectively. Then the forgetful map*

$$[X, Y]_G^0 \rightarrow [X, Y]_G$$

is bijective.

Note that for a CW complex X , the suspension $\Sigma^{\mathbb{R}^p} X$ with $p \geq 2$ is simply connected by the Freudenthal suspension theorem. From these facts, we obtain:

Corollary 3.12. *Let X and Y be pointed S^1 -CW complexes of type SWF and let $f : X \rightarrow Y$ be an S^1 -map. Then f represents an isomorphism in the S^1 -equivariant stable homotopy category \mathfrak{C}_{S^1} if the induced homomorphisms*

$$f_* : H_*(X; \mathbb{Z}) \rightarrow H_*(Y; \mathbb{Z}), \quad f_* : H_*(X^{S^1}; \mathbb{Z}) \rightarrow H_*(Y^{S^1}; \mathbb{Z})$$

are isomorphic.

Let X and Y be pointed $\text{Pin}(2)$ -CW complex of type SWF and $f : X \rightarrow Y$ be a $\text{Pin}(2)$ -map. Then f represents an isomorphism in the $\text{Pin}(2)$ -equivariant stable homotopy category $\mathfrak{C}_{\text{Pin}(2)}$ if the induced homomorphisms

$$f_* : H_*(X; \mathbb{Z}) \rightarrow H_*(Y; \mathbb{Z}), \quad f_* : H_*(X^{S^1}; \mathbb{Z}) \rightarrow H_*(Y^{S^1}; \mathbb{Z}), \quad f_* : H_*(X^{\text{Pin}(2)}; \mathbb{Z}) \rightarrow H_*(Y^{\text{Pin}(2)}; \mathbb{Z})$$

are isomorphic.

We can apply this corollary to the Conley index of the approximated Seiberg-Witten flow φ_λ^μ because of the following lemma:

Lemma 3.13. *Let (Y, \mathfrak{s}) be a spin^c rational homology 3-sphere and φ_λ^μ be the approximated Seiberg-Witten flow of (Y, \mathfrak{s}) . For $\lambda \ll 0$ and $\mu \gg 0$, the S^1 -equivariant Conley index $I_\lambda^\mu = N_\lambda^\mu / L_\lambda^\mu$ of $\text{Inv}(B(V_\lambda^\mu, R); \varphi_\lambda^\mu)$ is a pointed S^1 -CW complex of type SWF at level $\dim V_\lambda^0(\mathbb{R})$. Here $V_\lambda^0(\mathbb{R}) = V_\lambda^0 \cap i\Omega^1(Y)$.*

If \mathfrak{s} is spin, I_λ^μ is a pointed $\text{Pin}(2)$ -CW complex of type SWF at level $\dim V_\lambda^0(\tilde{\mathbb{R}})$. Here $V_\lambda^0(\tilde{\mathbb{R}}) := V_\lambda^0 \cap \Omega^1(Y)$, which is isomorphic to a direct sum of copies of $\tilde{\mathbb{R}}$ as a $\text{Pin}(2)$ -space.

Proof. Since the S^1 -fixed point set of V_λ^μ is $V_\lambda^\mu(\mathbb{R})$ and the S^1 -action on $V_\lambda^\mu - V_\lambda^\mu(\mathbb{R})$ is free, the S^1 -action is free on $I_\lambda^\mu - (I_\lambda^\mu)^{S^1}$. The approximated Seiberg-Witten flow φ_λ^μ on $V_\lambda^\mu(\mathbb{R})$ is generated by the linear operator $- * d$. Hence $(I_\lambda^\mu)^{S^1}$ is homotopy equivalent to $(V_\lambda^0(\mathbb{R}))^+$. Therefore I_λ^μ is of type SWF at level $\dim V_\lambda^0(\mathbb{R})$.

The proof for the spin case is similar. □

3.4. Relative Bauer-Furuta invariant. Let (X, \mathfrak{t}) be a compact, spin^c 4-manifold with boundary (Y, \mathfrak{s}) . Take a Riemann metric \hat{g} on X such that \hat{g} is isometric to $g + dt^2$ near the boundary Y , where g is a Riemann metric on Y . Assume that $b_1(X) = 0$ and $b_1(Y) = 0$. Choose a spin^c connection \hat{A}_0 on X . For $\mu > 0$, we have the Seiberg-Witten map

$$\begin{aligned} SW^\mu &: L_k^2(S_X^+) \times L_k^2(\Omega_{CC}^1(X)) \rightarrow L_{k-1}^2(S_X^-) \times L_{k-1}^2(i\Omega^+(X)) \times L_{k-\frac{1}{2}}^2(V^\mu) \\ SW^\mu(\hat{\phi}, \hat{a}) &= (D_{X, \hat{A}_0} \hat{\phi} + \rho(\hat{a})\hat{\phi}, d^+ \hat{a} + F_{\hat{A}_0}^+ - q(\hat{\phi}), p^\mu i^*(\hat{\phi}, \hat{a})). \end{aligned}$$

Here $i : Y \rightarrow X$ is the inclusion, S_X^\pm are the spinor bundles on X and $\Omega_{CC}^1(X)$ is the space of 1-forms satisfying the double Coulomb condition [Kha15]. Take a finite dimensional subspace U' in $L_{k-1}^2(S_X^-) \times L_{k-1}^2(i\Omega^+(X))$ and $\lambda < 0$ such that the image $\text{Im}(D_{X, \hat{A}_0}, d^+, p^\mu i^*)$ and $U' \times V_\lambda^\mu$ are transverse in the codomain of SW^μ . Put

$$U := (D_{X, \hat{A}_0}, d^+, p^\mu i^*)^{-1}(U' \times V_\lambda^\mu).$$

We consider a finite dimensional approximation of SW^μ defined by

$$\begin{aligned} SW_{U'}^{\lambda; \mu} &: U \rightarrow U' \times V_\lambda^\mu, \\ SW_{U'}^{\lambda; \mu} &= (p_{U'} \times id_{V^\mu}) \circ SW^\mu|_U. \end{aligned} \tag{3.4}$$

For U' large, $\lambda \ll 0$ and $\mu \gg 0$, we can take an index pair $(N_\lambda^\mu, L_\lambda^\mu)$ for the approximated Seiberg-Witten flow φ_λ^μ such that the map $SW_{U'}^{\lambda, \mu}$ induces an S^1 -map

$$f_U^{\lambda, \mu} : U^+ \rightarrow (U')^+ \wedge (N_\lambda^\mu / L_\lambda^\mu).$$

See [Man03, Proposition 6] and [Kha15, Proposition 4.5]. The map $f_U^{\lambda, \mu}$ represents a morphism

$$\Phi_{X, \mathfrak{t}} : S^{\frac{c_1(\mathfrak{t})^2 - \sigma(X)}{8}\mathbb{C}} \rightarrow \Sigma^{b^+(X)\mathbb{R}} SWF(Y, \mathfrak{s})$$

in the category \mathfrak{C}_{S^1} .

Let (X, \mathfrak{t}) be a spin^c -cobordism from (Y_0, \mathfrak{s}_0) to (Y_1, \mathfrak{s}_1) . Then the Seiberg-Witten equations on X define a morphism

$$\Phi_{X, \mathfrak{t}} : S^{\frac{c_1(\mathfrak{t})^2 - \sigma(X)}{8}\mathbb{C}} \rightarrow \Sigma^{b^+(X)\mathbb{R}} SWF(-Y_0, \mathfrak{s}_0) \wedge SWF(Y_1, \mathfrak{s}_1).$$

Composing with the duality morphism η in Proposition 3.6, we get a morphism

$$\begin{aligned} \Psi_{X, \mathfrak{t}} : \Sigma^{\frac{c_1(\mathfrak{t})^2 - \sigma(X)}{8}\mathbb{C}} SWF(Y_0, \mathfrak{s}_0) &\xrightarrow{\Phi_{X, \mathfrak{t}}} \Sigma^{b^+(X)\mathbb{R}} SWF(-Y_0, \mathfrak{s}_0) \wedge SWF(Y_1, \mathfrak{s}_1) \wedge SWF(Y_0, \mathfrak{s}_0) \\ &\xrightarrow{\eta} \Sigma^{b^+(X)\mathbb{R}} SWF(Y_1, \mathfrak{s}_1) \end{aligned}$$

in the category \mathfrak{C}_{S^1} . In the case when \mathfrak{t} is self-conjugate, we can define $\Psi_{X, \mathfrak{t}}$ as a morphism in the category $\mathfrak{C}_{\text{Pin}(2)}$, where $b^+(X)\mathbb{R}$ is replaced with $b^+(X)\mathbb{R}$.

Say \mathfrak{s} is a self-conjugate spin^c -structure on Y . For $\mathfrak{t}, \bar{\mathfrak{t}}$ a pair of conjugate spin^c structures restricting to \mathfrak{s} , with $\bar{\mathfrak{t}} \neq \mathfrak{t}$, we can still form morphisms in $\mathfrak{C}_{\text{Pin}(2)}$ by the following mechanism. For the spinor bundles $S_{X, \mathfrak{t}}^\pm, S_{X, \bar{\mathfrak{t}}}^\pm$ the (tautological) conjugation action defines a complex-antilinear isomorphism of bundles $j : S_{X, \mathfrak{t}}^\pm \rightarrow S_{X, \bar{\mathfrak{t}}}^\pm$; there is also an identification of spin^c -connections on $S_{X, \mathfrak{t}}^\pm, S_{X, \bar{\mathfrak{t}}}^\pm$, and these identifications are compatible with the double Coulomb condition. Write U', U, V_λ^μ as above, for \mathfrak{t} , and write \bar{U}', \bar{U} for the images of U', U under these identifications. We write j for the identifications $U \rightarrow \bar{U}$ and $U' \rightarrow \bar{U}'$; we also define $j : \bar{U} \rightarrow U$ and $j : \bar{U}' \rightarrow U'$ from the bundle map $-j^{-1}$.

Conjugation $j : S_{X, \mathfrak{t}}^\pm \rightarrow S_{X, \bar{\mathfrak{t}}}^\pm$ restricts on the boundary to a map $S_{Y, \mathfrak{s}} \rightarrow S_{Y, \bar{\mathfrak{s}}}$; by perhaps changing j by a harmonic gauge transformation, we may assume that j on the 4-manifold agrees with $j : S_{Y, \mathfrak{s}} \rightarrow S_{Y, \bar{\mathfrak{s}}}$ defined for the three-manifold. The restriction operation on connections agrees with the action of j on spin^c -connections on Y as well.

Indeed, if the boundary spin^c -structure \mathfrak{s} is not self-conjugate, we may also consider \bar{V}_λ^μ , which is defined similarly to the \bar{U}, \bar{U}' above. Indeed, letting $[\mathfrak{s}]$ be the orbit of \mathfrak{s} under conjugation (i.e. $[\mathfrak{s}] = \{\mathfrak{s}, \bar{\mathfrak{s}}\}$), we define a $\text{Pin}(2)$ -equivariant spectrum

$$SWF(Y, [\mathfrak{s}]) = \bigvee_{\mathfrak{s} \in [\mathfrak{s}]} SWF(Y, \mathfrak{s})$$

with j -action defined as follows. The configuration spaces V_λ^μ and \bar{V}_λ^μ both have components coming from sections of spinor bundles $\Gamma(S_{Y, \mathfrak{s}})$ and $\Gamma(S_{Y, \bar{\mathfrak{s}}})$; as before, we define j on the spinor component of V_λ^μ and \bar{V}_λ^μ to be via the complex-antilinear bundle (tautological) bundle map $j : S_{Y, \mathfrak{s}} \rightarrow S_{Y, \bar{\mathfrak{s}}}$. Also as before, there is a canonical identification of spin^c connections on $S_{Y, \mathfrak{s}}, S_{Y, \bar{\mathfrak{s}}}$, giving us a map $V_\lambda^\mu \rightarrow \bar{V}_\lambda^\mu$. As before, we use the bundle map $-j^{-1} : S_{Y, \bar{\mathfrak{s}}} \rightarrow S_{Y, \mathfrak{s}}$ to define $j : \bar{V}_\lambda^\mu \rightarrow V_\lambda^\mu$.

Then, we have a pair of morphisms as in (3.4):

$$SW_{U'}^{\lambda, \mu} : U \rightarrow U' \times V_\lambda^\mu, \quad \text{and } SW_{\bar{U}'}^{\lambda, \mu} : \bar{U} \rightarrow \bar{U}' \times V_\lambda^\mu,$$

By inspecting the Seiberg-Witten map SW , we see that $SW_{U'}^{\lambda, \mu} = j^{-1}SW_U^{\lambda, \mu}j$. The somewhat awkward definition of j on $\bar{U}' \rightarrow U'$ (resp. $\bar{U} \rightarrow U$) was dictated by the requirement that i^* be j -equivariant (in the event that \mathfrak{s} is not self-conjugate, one may construct a $S^1 \times C_2$ -equivariant map, if $SWF(Y, [\mathfrak{s}])$ is built as a $S^1 \times C_2$ -spectrum rather than as a $\text{Pin}(2)$ -spectrum).

Indeed, we obtain that for $\mathfrak{t}, \mathfrak{s}$ as above, we obtain a morphism:

$$\Phi_{X, [\mathfrak{t}]} : S^{\frac{c_1(\mathfrak{t})^2 - \sigma(X)}{8}} \mathbb{C} \vee S^{\frac{c_1(\mathfrak{t})^2 - \sigma(X)}{8}} \mathbb{C} \rightarrow \Sigma^{b^+(X)} \tilde{\mathbb{R}} SWF(Y, \mathfrak{s}) \quad (3.5)$$

in $\mathfrak{C}_{\text{Pin}(2)}$. The j -action on the left-hand side is $j(x, y) = (-y, x)$. The restriction of this morphism to either sphere factor is exactly $\Phi_{X, \mathfrak{t}}$ (resp. $\Phi_{X, \bar{\mathfrak{t}}}$ as defined previously) in \mathfrak{C}_{S^1} .

If $b_1(X) > 0$, the relative Bauer-Furuta invariant is defined as a morphism

$$\Phi_{X, \mathfrak{t}} : Th_{\text{Ind}D} \rightarrow \Sigma^{b^+(X)} \mathbb{R} SWF(Y, \mathfrak{s})$$

in \mathfrak{C}_{S^1} . Here $\text{Ind}D \in K(\text{Pic}(X))$ is the index bundle of the family of Dirac operators on X parametrized by the Picard torus $\text{Pic}(X)$ and $Th_{\text{Ind}D} \in \text{Ob}(\mathfrak{C}_{S^1})$ is the Thom spectrum of $\text{Ind}D$.

Let $Y = -Y_0 \amalg Y_1$. Composing the duality morphism η of $SWF(Y_0, \mathfrak{s})$ and $SWF(-Y_0, \mathfrak{s}_0)$ with $\Phi_{X, \mathfrak{t}}$, we obtain a morphism

$$\Psi_{X, \mathfrak{t}} : Th_{\text{Ind}D} \wedge SWF(Y_0, \mathfrak{s}_0) \rightarrow \Sigma^{b^+(X)} \mathbb{R} SWF(Y_1, \mathfrak{s}_1).$$

Restricting $\Psi_{X, \mathfrak{t}}$ to the fiber, we get a morphism

$$\Psi_{X, \mathfrak{t}}^{\text{fib}} : \Sigma^{\frac{c_1(\mathfrak{s})^2 - \sigma(X)}{8}} \mathbb{C} SWF(Y_0, \mathfrak{s}_0) \rightarrow \Sigma^{b^+(X)} \mathbb{R} SWF(Y_1, \mathfrak{s}_1).$$

If $b_1(Y) > 0$, we have the type A and type R Bauer-Furuta invariants

$$\begin{aligned} \underline{\psi}_{X, \mathfrak{t}}^A &: Th_{\text{Ind}D} \wedge \underline{swf}^A(Y_0, \mathfrak{s}_0, g_0, A_0) \rightarrow \Sigma^{b^+(X) \mathbb{R} \oplus V(Y_0)} \underline{swf}^A(Y_1, \mathfrak{s}_1, g_1, A_1), \\ \underline{\psi}_{X, \mathfrak{t}}^R &: Th_{\text{Ind}D} \wedge \underline{swf}^R(Y_0, \mathfrak{s}_0, g_0, A_0) \rightarrow \Sigma^{b^+(X) \mathbb{R} \oplus V(Y_1)} \underline{swf}^R(Y_1, \mathfrak{s}_1, g_1, A_1), \end{aligned}$$

which are morphisms in $\mathfrak{C}_{S^1}^{\text{ind}}, \mathfrak{C}_{S^1}^{\text{pro}}$. Here $V(Y_i) = \text{Coker}(H^1(X; \mathbb{R}) \rightarrow H^1(Y_i; \mathbb{R}))$ for $i = 0, 1$ and $\text{Ind}D \in K(\text{Pic}(X, Y))$ is the index bundle of a family of Dirac operators on X parametrized by the relative Picard torus

$$\text{Pic}(X, Y) = \frac{\ker(H^1(X; \mathbb{R}) \rightarrow H^1(Y; \mathbb{R}))}{\ker(H^1(X; \mathbb{Z}) \rightarrow H^1(Y; \mathbb{Z}))}.$$

Restricting $\underline{\psi}_{X, \mathfrak{t}}^A, \underline{\psi}_{X, \mathfrak{t}}^R$ to the fibers, we have morphisms

$$\begin{aligned} \underline{\psi}_{X, \mathfrak{t}}^{A, \text{fib}} &: \Sigma^{a\mathbb{C}} \underline{swf}^A(Y_0, \mathfrak{s}_0, g_0, A_0) \rightarrow \Sigma^{b^+(X) \mathbb{R} \oplus V(Y_0)} \underline{swf}^A(Y_1, \mathfrak{s}_1, g_1, A_1), \\ \underline{\psi}_{X, \mathfrak{t}}^{R, \text{fib}} &: \Sigma^{a\mathbb{C}} \underline{swf}^R(Y_0, \mathfrak{s}_0, g_0, A_0) \rightarrow \Sigma^{b^+(X) \mathbb{R} \oplus V(Y_1)} \underline{swf}^R(Y_1, \mathfrak{s}_1, g_1, A_1). \end{aligned}$$

Here $a \in \mathbb{Z}$ is the rank of $\text{Ind}D$.

If $c_1(\mathfrak{s}_0), c_1(\mathfrak{s}_1)$ are torsion, we can define the normalized Bauer-Furuta invariants

$$\begin{aligned} \underline{\Psi}_{X, \mathfrak{t}}^A &: Th_{\text{Ind}D} \wedge \underline{SWF}^A(Y_0, \mathfrak{s}_0, g_0, A_0) \rightarrow \Sigma^{b^+(X) \mathbb{R} \oplus V(Y_0)} \underline{SWF}^A(Y_1, \mathfrak{s}_1, g_1, A_1), \\ \underline{\Psi}_{X, \mathfrak{t}}^R &: Th_{\text{Ind}D} \wedge \underline{SWF}^R(Y_0, \mathfrak{s}_0, g_0, A_0) \rightarrow \Sigma^{b^+(X) \mathbb{R} \oplus V(Y_1)} \underline{SWF}^R(Y_1, \mathfrak{s}_1, g_1, A_1). \end{aligned}$$

Restricting to the fibers, we have

$$\begin{aligned} \underline{\Psi}_{X, \mathfrak{t}}^{A, \text{fib}} &: \Sigma^{\frac{c_1(\mathfrak{t})^2 - \sigma(X)}{8}} \mathbb{C} \underline{SWF}^A(Y_0, \mathfrak{s}_0) \rightarrow \Sigma^{b^+(X) \oplus V(Y_0)} \underline{SWF}^A(Y_1, \mathfrak{s}_1), \\ \underline{\Psi}_{X, \mathfrak{t}}^{R, \text{fib}} &: \Sigma^{\frac{c_1(\mathfrak{t})^2 - \sigma(X)}{8}} \mathbb{C} \underline{SWF}^R(Y_0, \mathfrak{s}_0) \rightarrow \Sigma^{b^+(X) \oplus V(Y_1)} \underline{SWF}^R(Y_1, \mathfrak{s}_1). \end{aligned}$$

3.5. Adjunction relation and blow up formula. In this subsection, we will prove adjunction relation and blow up formula of the Bauer-Furuta invariant. To do it, we will need the following lemma.

Lemma 3.14 ([BF04, Lemma 3.8]). *Let*

$$f : S^{p\mathbb{R} \oplus q\mathbb{C}} \rightarrow S^{p\mathbb{R} \oplus (q+k)\mathbb{C}}$$

be an S^1 -map such that the restriction

$$f^{S^1} : S^{p\mathbb{R}} \rightarrow S^{p\mathbb{R}}$$

has degree 1. Then $k \geq 0$ and f is S^1 -homotopic to the inclusion

$$S^{p\mathbb{R} \oplus q\mathbb{C}} \hookrightarrow S^{p\mathbb{R} \oplus (q+k)\mathbb{C}}.$$

In fact, more generally, stable S^1 -maps $S^{p\mathbb{R} \oplus q\mathbb{C}} \rightarrow S^{p\mathbb{R} \oplus (q+k)\mathbb{C}}$ up to homotopy are determined by the degree of f^{S^1} (as a map of nonequivariant spaces). See [tD87, Chapter 2, Section 4].

For an object (W, m, n) of the category \mathfrak{C}_{S^1} , let

$$U : (W, m, n) \rightarrow (\Sigma^{\mathbb{C}}W, m, n)$$

be the morphism represented by the inclusion

$$U : W \hookrightarrow \Sigma^{\mathbb{C}}W, w \mapsto (0, w).$$

For a map $f : \Sigma^{\mathbb{C}}W \rightarrow W'$, the composite

$$fU : W \rightarrow W'$$

is the restriction of f to W .

Proposition 3.15. *Let (X, \mathfrak{t}) be a spin^c cobordism from (Y_0, \mathfrak{s}_0) to (Y_1, \mathfrak{t}_1) with $b_1(X) = b_1(\partial X) = 0$. Suppose that we have an embedded sphere S in X with $S \cdot S < 0$. Let L be the complex line bundle with*

$$c_1(L) = PD[S].$$

Put

$$\mathfrak{t}' = \mathfrak{t} \otimes L, n = \frac{\langle c_1(\mathfrak{t}), [S] \rangle + [S] \cdot [S]}{2} \in \mathbb{Z}. \quad (3.6)$$

If $n \geq 0$, we have

$$\Psi_{X, \mathfrak{t}'} U^n = \Psi_{X, \mathfrak{t}},$$

and if $n < 0$, we have

$$\Psi_{X, \mathfrak{t}'} = \Psi_{X, \mathfrak{t}} U^{-n}.$$

Proof. Let N be a compact tubular neighborhood of S in X . The boundary ∂N is diffeomorphic to the lens space $L(k, 1)$, where $k = |S \cdot S|$. We have

$$b_1(\partial N) = 0, b_1(N) = 0, b^+(N) = 0.$$

Since ∂N has a positive scalar curvature metric, the Seiberg-Witten Floer spectrum $SWF(\partial N, \mathfrak{t}|_{\partial N})$ is isomorphic to $S^{a\mathbb{C}} (= (S^0, 0, -a))$ for some $a \in \mathbb{Q}$ in \mathfrak{C}_{S^1} . Since $b^+(N) = 0$, we have the relative Bauer-Furuta invariants

$$\Psi_{N, \mathfrak{t}|_N} : S^{\frac{c_1(\mathfrak{t}|_N)^2 - \sigma(N)}{8}\mathbb{C}} \rightarrow S^{a\mathbb{C}},$$

$$\Psi_{N, \mathfrak{t}'|_N} : S^{\frac{c_1(\mathfrak{t}'|_N)^2 - \sigma(N)}{8}\mathbb{C}} \rightarrow S^{a\mathbb{C}}$$

which are represented by S^1 -maps

$$\begin{aligned} f &: S^{p\mathbb{R} \oplus q\mathbb{C}} \rightarrow S^{p\mathbb{R} \oplus (q+r)\mathbb{C}}, \\ f' &: S^{p\mathbb{R} \oplus (q+n)\mathbb{C}} \rightarrow S^{p\mathbb{R} \oplus (q+r)\mathbb{C}} \end{aligned}$$

such that $f^{S^1}, (f')^{S^1} : S^{p\mathbb{R}} \rightarrow S^{p\mathbb{R}}$ are homeomorphisms. Here $p, q \in \mathbb{Z}$ with $p, q \gg 0$, $r = a - \frac{c_1(\mathfrak{t}_N)^2 - \sigma(N)}{8} \in \mathbb{Z}$, and n is the integer defined in (3.6). By Lemma 3.14, we have $r \geq \max\{0, n\}$, and f, f' are S^1 -homotopic to the inclusions. Therefore if $n \geq 0$, the maps f and $f'U^n$ are S^1 -homotopic. This means that

$$\Psi_{N, \mathfrak{t}'|_N} U^n = \Psi_{N, \mathfrak{t}|_N}.$$

Similarly, if $n < 0$,

$$\Psi_{N, \mathfrak{t}'|_N} = \Psi_{N, \mathfrak{t}|_N} U^{-n}.$$

Let Z be $\overline{X - N}$. By the gluing theorem [Man07] for the relative Bauer-Furuta invariants,

$$\begin{aligned} \Psi_{X, \mathfrak{t}} &= \eta(\Psi_{Z, \mathfrak{t}|_Z} \wedge \Psi_{N, \mathfrak{t}|_N}), \\ \Psi_{X, \mathfrak{t}'} &= \eta(\Psi_{Z, \mathfrak{t}|_Z} \wedge \Psi_{N, \mathfrak{t}'|_N}). \end{aligned}$$

Here η is the duality morphism

$$SWF(\partial N, \mathfrak{t}|_{\partial N}) \wedge SWF(-\partial N, \mathfrak{t}|_{\partial N}) \rightarrow S^0$$

of Proposition 3.6. Therefore if $n \geq 0$,

$$\Psi_{X, \mathfrak{t}'} U^n = \Psi_{X, \mathfrak{t}},$$

and if $n < 0$,

$$\Psi_{X, \mathfrak{t}'} = \Psi_{X, \mathfrak{t}} U^{-n}.$$

□

Next we will show a blow up formula for the relative Bauer-Furuta invariant, which is necessary to prove Theorem 1.2. For $k \in \mathbb{Z}$, denote by \mathfrak{t}_k the spin^c on $\overline{\mathbb{C}\mathbb{P}^2}$ with $c_1(\mathfrak{t}_k) = (2k+1)PD(E)$, where $E \in H_2(\overline{\mathbb{C}\mathbb{P}^2}; \mathbb{Z})$ is the class of the exceptional sphere. The Bauer-Furuta invariant $\Psi_{\overline{\mathbb{C}\mathbb{P}^2}, \mathfrak{t}_k}$ is represented by an S^1 -map

$$f_k : S^{p\mathbb{R} \oplus q\mathbb{C}} \rightarrow S^{p\mathbb{R} \oplus \left(q + \frac{k(k+1)}{2}\right)\mathbb{C}}$$

for some $p, q \in \mathbb{Z}$ with $p, q \gg 0$. Since the restriction

$$f_k^{S^1} : S^{p\mathbb{R}} \rightarrow S^{p\mathbb{R}}$$

is a homeomorphism, by Lemma 3.14, f_k is S^1 -homotopic to the inclusion

$$U^{\frac{k(k+1)}{2}} : S^{p\mathbb{R} \oplus q\mathbb{C}} \hookrightarrow S^{p\mathbb{R} \oplus \left(q + \frac{k(k+1)}{2}\right)\mathbb{C}}.$$

Proposition 3.16. *Let (X, \mathfrak{t}) be a spin^c cobordism from (Y_0, \mathfrak{s}_0) to (Y_1, \mathfrak{s}_1) with $b_1(X) = b_1(\partial X) = 0$. Then we have*

$$\Psi_{X \# \overline{\mathbb{C}\mathbb{P}^2}, \mathfrak{t} \# \mathfrak{t}_k} = U^{\frac{k(k+1)}{2}} \Psi_{X, \mathfrak{t}}.$$

Proof. First, note that the duality morphism

$$\eta : SWF(S^3) \wedge SWF(-S^3) (= S^0 \wedge S^0 = S^0) \rightarrow S^0$$

is the identity.

Let D be a small closed disk in X and put $X_0 := X - \text{Int}D$. The relative Bauer-Furuta invariant

$$\Psi_D : S^0 \rightarrow SWF(S^3) = S^0$$

of D is the identity. Hence by the gluing formula [Man07],

$$\Psi_{X,t} = \eta(\Psi_{X_0,t|_{X_0}} \wedge \Psi_D) = \Psi_{X_0,t|_{X_0}}.$$

Put $X_1 = \overline{\mathbb{C}\mathbb{P}^2} - \text{Int}D'$, where D' is a small closed disk in $\overline{\mathbb{C}\mathbb{P}^2}$. Similarly we have

$$U^{\frac{k(k+1)}{2}} = \Psi_{\overline{\mathbb{C}\mathbb{P}^2}, t_k} = \Psi_{X_1, t_k|_{X_1}}.$$

Therefore

$$\Psi_{X \# \overline{\mathbb{C}\mathbb{P}^2}, t \# t_k} = \eta(\Psi_{X_0,t|_{X_0}} \wedge \Psi_{X_1, t_k|_{X_1}}) = \Psi_{X,t} \wedge U^{\frac{k(k+1)}{2}} = U^{\frac{k(k+1)}{2}} \Psi_{X,t}.$$

□

3.6. Surgery exact triangle for Seiberg-Witten Floer spectra. Take a knot K in a closed, oriented 3-manifold Y and let m be the meridian of K . Choose $h \in H_1(Y - N(K); \mathbb{Z})$ with $m \cdot h = -1$, where $N(K)$ is a tubular neighborhood of K in Y . Denote by $Y_h(K)$ the 3-manifold obtained by attaching a solid torus to $Y - N(K)$ with framing associated to h . For each integer n , put

$$Y_{3n} = Y, \quad Y_{3n+1} = Y_h(K), \quad Y_{3n+2} = Y_{h+m}(K).$$

We assume that $b_1(Y_n) = 0$ for all n . Put

$$SWF(Y_n) := \bigvee_{\mathfrak{s} \in \text{Spin}^c(Y_n)} SWF(Y_n, \mathfrak{s}).$$

For each n , we have an elementary cobordism W_n from Y_n to Y_{n+1} , obtained by adding a 2-handle to $Y_n \times [0, 1]$. A computation shows

$$b_1(W_n) = 0, \quad b_2(W_n) = 1.$$

Let W'_n be the composite of the cobordisms W_n and W_{n+1} . Then W'_n includes a 2-sphere E_n with $[E_n] \cdot [E_n] = -1$. Fix a spin^c structure $\mathfrak{t}'_{n,0}$ on W'_n and generator σ_n of $H^2(W_n; \mathbb{Z})/\text{Tor} \cong \mathbb{Z}$. Define

$$\epsilon_n : \text{Spin}^c(W_n) \rightarrow \{\pm 1\}$$

as follows. For n even, put $\epsilon_n(\mathfrak{s}) = +1$ for all $\mathfrak{t} \in \text{Spin}^c(W_n)$. Let n be odd. For $\mathfrak{t} \in \text{Spin}^c(W_n)$, define

$$\epsilon_n(\mathfrak{t}) = \begin{cases} +1 & \text{if } c_1(\mathfrak{t}) = c_1(\mathfrak{t}'_{n,0}|_{W_n}) + 4k\sigma_n \text{ in } H^2(W_n; \mathbb{Z})/\text{Tor} \text{ for some integer } k, \\ -1 & \text{if } c_1(\mathfrak{t}) = c_1(\mathfrak{t}'_{n,0}|_{W_n}) + (4k+2)\sigma_n \text{ in } H^2(W_n; \mathbb{Z})/\text{Tor} \text{ for some integer } k. \end{cases}$$

Take a reduced S^1 -homology theory E_* and a positive integer N . Define a homomorphism

$$f_{n,N} : E_*(SWF(Y_n)) \rightarrow E_*(SWF(Y_{n+1}))$$

by

$$f_{n,N} := \sum_{\substack{\mathfrak{t} \in \text{Spin}^c(W_n) \\ |c_1(\mathfrak{t}), \sigma_n| \leq N}} \epsilon_n(\mathfrak{t})(\Psi_{W_n, \mathfrak{t}})_*,$$

where $\Psi_{W_n, \mathfrak{t}}$ is the relative Bauer-Furuta invariant. The collection $\{f_{n,N}\}_{N=1,2,\dots}$ induces a homomorphism

$$f_{n\bullet} : E_\bullet(SWF(Y_n)) \rightarrow E_\bullet(SWF(Y_{n+1})).$$

Here $E_\bullet(SWF(Y_n))$ is the completion with respect to a decreasing filtration $\{E_{* < -p}(SWF(Y_n))\}_{p=1,2,\dots}$:

$$E_\bullet(SWF(Y_n)) = \varprojlim_p E_*(SWF(Y_n))/E_{* < -p}(SWF(Y_n)).$$

In [SS23], the second and third authors proved the following:

Theorem 3.17. *We have the following exact sequence:*

$$\dots \xrightarrow{f_{n-1\bullet}} E_\bullet(SWF(Y_n)) \xrightarrow{f_{n\bullet}} E_\bullet(SWF(Y_{n+1})) \xrightarrow{f_{n+1\bullet}} E_\bullet(SWF(Y_{n+2})) \xrightarrow{f_{n+2\bullet}} \dots$$

Since $\tilde{H}_{-p}^{S^1}(SWF(Y_n); \mathbb{Z}) = 0$ for p large, we have $\tilde{H}_\bullet^{S^1}(SWF(Y_n); \mathbb{Z}) = \tilde{H}_*^{S^1}(SWF(Y_n); \mathbb{Z})$. Therefore we obtain the following corollary.

Corollary 3.18. *We have the following exact sequence*

$$\dots \xrightarrow{f_{n-1*}} \tilde{H}_*^{S^1}(SWF(Y_n); \mathbb{Z}) \xrightarrow{f_{n*}} \tilde{H}_*^{S^1}(SWF(Y_{n+1}); \mathbb{Z}) \xrightarrow{f_{n+1*}} \tilde{H}_*^{S^1}(SWF(Y_{n+2}); \mathbb{Z}) \xrightarrow{f_{n+2*}} \dots$$

3.7. Connected sum formula for Seiberg-Witten Floer spectra. We will prove the following:

Theorem 3.19. *Let $(Y_1, \mathfrak{s}_1), (Y_2, \mathfrak{s}_2)$ be closed, spin^c 3-manifolds with $b_1 = 0$. Then we have an isomorphism*

$$SWF(Y_1 \# Y_2, \mathfrak{s}_1 \# \mathfrak{s}_2) \cong SWF(Y_1, \mathfrak{s}_1) \wedge SWF(Y_2, \mathfrak{s}_2)$$

in \mathfrak{C}_{S^1} .

If $(Y_1, \mathfrak{s}_1), (Y_2, \mathfrak{s}_2)$ are spin, we have

$$SWF(Y_1 \# Y_2, \mathfrak{s}_1 \# \mathfrak{s}_2) \cong SWF(Y_1, \mathfrak{s}_1) \wedge SWF(Y_2, \mathfrak{s}_2)$$

in $\mathfrak{C}_{\text{Pin}(2)}$.

We have a natural spin^c cobordism (W, \mathfrak{t}) from $(Y_1, \mathfrak{s}_1) \coprod (Y_2, \mathfrak{s}_2)$ to $(Y_1 \# Y_2, \mathfrak{s}_1 \# \mathfrak{s}_2)$, which is a boundary connected sum of $(Y_1 \times [0, 1], \pi_1^* \mathfrak{s}_1)$ and $(Y_2 \times [0, 1], \pi_2^* \mathfrak{s}_2)$. Here $\pi_i : Y_i \times [0, 1] \rightarrow Y_i$ is the projection. Note that

$$SWF(Y_1 \coprod Y_2, \mathfrak{s}_1 \coprod \mathfrak{s}_2) = SWF(Y_1, \mathfrak{s}_1) \wedge SWF(Y_2, \mathfrak{s}_2).$$

We will prove that the Bauer-Furuta invariant

$$\Psi_{W, \mathfrak{t}} : SWF(Y_1, \mathfrak{s}_1) \wedge SWF(Y_2, \mathfrak{s}_2) \rightarrow SWF(Y_1 \# Y_2, \mathfrak{s}_1 \# \mathfrak{s}_2)$$

is an isomorphism.

Put

$$W' := W \cup_{Y_1 \# Y_2} (-W), \quad \mathfrak{t}' = \mathfrak{t} \cup_{Y_1 \# Y_2} \mathfrak{t}.$$

Then (W', \mathfrak{t}') is a spin^c cobordism from $(Y_1 \coprod Y_2, \mathfrak{s}_1 \coprod \mathfrak{s}_2)$ to itself. By the gluing theorem [Man07],

$$\Psi_{W', \mathfrak{t}'} = \Psi_{-W, \mathfrak{t}} \circ \Psi_{W, \mathfrak{t}}.$$

Note that (W', \mathfrak{t}') is a connected sum of $(Y_1 \times [0, 1], \pi_1^* \mathfrak{s}_1)$ and $(Y_2 \times [0, 1], \pi_2^* \mathfrak{s}_2)$. By the gluing formula and the fact that the duality morphism

$$\eta_{S^3} : SWF(S^3) \wedge SWF(-S^3) (= S^0 \wedge S^0) \rightarrow S^0$$

is the identity, we have

$$\Psi_{W', \mathfrak{t}'} = \eta_{S^3} \circ (\Psi_{Y_1 \times [0, 1], \pi_1^* \mathfrak{s}_1} \wedge \Psi_{Y_2 \times [0, 1], \pi_2^* \mathfrak{s}_2}) = id_{SWF(Y_1, \mathfrak{s}_1) \wedge SWF(Y_2, \mathfrak{s}_2)}.$$

Here we have used $\Psi_{Y_i \times [0,1], \pi_i^* \mathfrak{s}_i} = id_{SWF(Y_i, \mathfrak{s}_i)}$. See [SS23, Section 6]. Therefore we have obtained

$$\Psi_{-W, \mathfrak{t}} \circ \Psi_{W, \mathfrak{t}} = id_{SWF(Y_1, \mathfrak{s}_1) \wedge SWF(Y_2, \mathfrak{s}_2)}.$$

Put

$$W'' = (-W) \cup_{Y_1 \amalg Y_2} W, \quad \mathfrak{t}'' = \mathfrak{t} \cup_{Y_1 \amalg Y_2} \mathfrak{t}.$$

Then (W'', \mathfrak{t}'') is a spin^c cobordism from $(Y_1 \# Y_2, \mathfrak{s}_1 \# \mathfrak{s}_2)$ to itself and $b_1(W'') = 1$. Although $Y_1 \amalg Y_2$ is not connected, we can still apply arguments in the proofs of [Man07, Theorem 1], [KLS23, Theorem 1.5] to $\Psi_{W'', \mathfrak{t}''}^{\text{fib}}$ and we have

$$\Psi_{W'', \mathfrak{t}''}^{\text{fib}} = \Psi_{W, \mathfrak{t}} \circ \Psi_{-W, \mathfrak{t}}. \quad (3.7)$$

Here $\Psi_{W'', \mathfrak{t}''}^{\text{fib}}$ is the restriction of the Bauer-Furuta invariant $\Psi_{W'', \mathfrak{t}''}$ to the fiber of the Thom spectrum of the index bundle of Dirac operators on X . See Section 3.4. We take a simple closed curve c in W'' which consists of curves c_1 and c_2 . Here c_1 is a curve in $-W$ from a point p_1 on Y_1 to a point p_2 on Y_2 and c_2 is a curve in W from p_1 to p_2 . The curve c represents a generator of $H_1(W''; \mathbb{Z}) \cong \mathbb{Z}$. Take a small compact neighborhood N of c in W'' with $N \cong S^1 \times D^3$. Put $\tilde{W}'' = W'' - \text{Int}N$. Let $\mathfrak{s}_{S^1 \times S^2}$ be the spin^c structure on $S^1 \times S^2$ with $c_1 = 0$. By Theorem 1.5 of [KLS23],

$$\Psi_{\tilde{W}'', \mathfrak{t}''}^{\text{fib}} = \Psi_{W'', \mathfrak{t}''}|_{\text{Pic}(W'', \partial N)} = \eta_{S^1 \times S^2} \circ (\underline{\Psi}_{\tilde{W}'', \mathfrak{t}''|_{\tilde{W}''}}^R \wedge \underline{\Psi}_{N, \mathfrak{t}''|_N}^A). \quad (3.8)$$

Here $\eta_{S^1 \times S^2}$ is the duality morphism of $\underline{SWF}^A(S^1 \times S^2, \mathfrak{s}_{S^1 \times S^2})$ and $\underline{SWF}^R(-S^1 \times S^2, \mathfrak{s}_{S^1 \times S^2})$. Note that if we attach $D^2 \times S^2$ to \tilde{W}'' , we get the trivial cobordism:

$$\tilde{W}'' \cup_{S^1 \times S^2} D^2 \times S^2 = Y_1 \# Y_2 \times [0, 1].$$

Hence

$$\eta_{S^1 \times S^2} \circ (\underline{\Psi}_{\tilde{W}'', \mathfrak{t}''|_{\tilde{W}''}}^R \wedge \underline{\Psi}_{D^2 \times S^2, \mathfrak{t}_{D^2 \times S^2}}^A) = id_{SWF(Y_1 \# Y_2, \mathfrak{s}_1 \# \mathfrak{s}_2)}. \quad (3.9)$$

As shown in [KLS23, Example 1.4], both of $\underline{\Psi}_{N, \mathfrak{t}''|_N}^A$ and $\underline{\Psi}_{D^2 \times S^2, \mathfrak{t}_{D^2 \times S^2}}^A$ are represented by the identity $S^{p\mathbb{R} \oplus q\mathbb{C}} \rightarrow S^{p\mathbb{R} \oplus q\mathbb{C}}$. Therefore it follows from (3.7), (3.8) and (3.9) that

$$\Psi_{W, \mathfrak{t}} \circ \Psi_{-W, \mathfrak{t}} = id_{SWF(Y_1 \# Y_2, \mathfrak{t}_1 \# \mathfrak{t}_2)}.$$

We have proved Theorem 3.19.

4. REVIEW OF LATTICE HOMOLOGY

In this section, we review the definition of lattice homology and discuss several lattice-theoretic results due to Ozsváth and Szabó [OS03] and Némethi [Ném05, Ném08]. Throughout, let Γ be a negative-definite plumbing graph. Denote the corresponding plumbed 4-manifold by W_Γ and its boundary by $Y_\Gamma = \partial W_\Gamma$. Let $L_\Gamma \cong \mathbb{Z}^{|\Gamma|}$ be the lattice formally spanned by the vertices of Γ and let $(-, -)_\Gamma$ be the intersection pairing on L_Γ .

Recall that an element $k \in \text{Hom}(L_\Gamma, \mathbb{Z})$ is *characteristic* if $k(x) \equiv x^2 \pmod{2}$ for all $x \in L_\Gamma$. Denote the set of characteristic elements by Char_Γ . The set Char_Γ has an action of L_Γ which sends $k \mapsto k + 2x^*$, where x^* is the Poincaré dual $x^* = (x, -)_\Gamma$. The action of L_Γ partitions the elements of Char_Γ into equivalence classes; we denote a generic equivalence class by $[k]$. It is a standard fact that the spin^c -structures on W_Γ are in bijection with Char_Γ , and that the spin^c -structures on Y_Γ are in bijection with the set of equivalence classes $[k]$.

Extend $(-, -)_\Gamma$ to a \mathbb{Q} -valued pairing on $L_\Gamma \otimes \mathbb{Q}$. Since $(-, -)_\Gamma$ has non-zero determinant, any element $k \in \text{Hom}(L_\Gamma, \mathbb{Z})$ may be written as $(x, -)_\Gamma$ for some rational vector $x \in L_\Gamma \otimes \mathbb{Q}$.

This correspondence allows us to define an intersection pairing on $\text{Hom}(L_\Gamma, \mathbb{Z})$, which by abuse of notation we also denote by $(-, -)_\Gamma$.

Finally, note that each equivalence class $[k]$ is an affine lattice over L_Γ . This gives a cubical subdivision of $[k] \otimes \mathbb{R} \cong \mathbb{R}^{|\Gamma|}$ coming from the obvious cubical subdivision of $L_\Gamma \otimes \mathbb{R} \cong \mathbb{R}^{|\Gamma|}$:

Definition 4.1. Define the *zero-dimensional cubes* of $[k]$ to be the elements of $[k]$. In general, a *d-dimensional cube* of $[k]$ is the convex hull (in $[k] \otimes \mathbb{R}$) of a set of 2^d elements of the form

$$\left\{ k + \sum_{i=1}^d c_i(2v_i^*) \mid (c_1, \dots, c_d) \in \{0, 1\}^d \right\}$$

for some $k \in [k]$ and set of distinct vertices v_1, \dots, v_d in Γ .⁴ For example, a square in $[k]$ is the convex hull of $\{k, k+2v^*, k+2w^*, k+2v^*+2w^*\}$ for some characteristic element $k \in [k]$ and pair of distinct vertices v and w . We denote a typical cube of dimension d by \square_d . Strictly speaking, each cube (as a geometric object) is a subset of $[k] \otimes \mathbb{R}$, but we refer to these as being in $[k]$ for convenience. We often refer to zero-dimensional cubes as *lattice points* and one-dimensional cubes as *lattice edges*.

4.1. The lattice complex. Following [Ném08, Definition 3.1.8], we now recall the definition of lattice homology.

Definition 4.2. Let $[k]$ be an equivalence class in Char_Γ . Define the *weight function* w on $[k]$ as follows. For any zero-dimensional cube k in $[k]$, define

$$w(k) = \frac{1}{4} (k^2 + |\Gamma|).$$

For any d -dimensional cube \square_d in $[k]$, define $w(\square_d)$ to be the minimum over the weights of all lattice points appearing as vertices of \square_d :

$$w(\square_d) = \min_k \{w(k) \mid k \text{ a vertex of } \square_d\}.$$

Thus, w is a function on the set of all cubes (of any dimension) in $[k]$.

For any fixed equivalence class $[k]$, the weight function w takes values in a coset of $2\mathbb{Z}$ in \mathbb{Q} . To see this, note that for any pair of adjacent lattice points, we have

$$w(k + 2v^*) - w(k) = (k, v^*)_\Gamma + (v^*, v^*)_\Gamma = k(v) + v^2 \equiv 0 \pmod{2}$$

since k is characteristic.

Definition 4.3. Define the *lattice complex* $\mathbb{C}(\Gamma, [k])$ as follows. Let $\mathbb{C}_d(\Gamma, [k])$ be the free (infinitely-generated) $\mathbb{Z}[U]$ -module formally spanned by the set of d -dimensional cubes in $[k]$:

$$\mathbb{C}_d(\Gamma, [k]) = \text{span}_{\mathbb{Z}[U]} \{ \square_d \mid \square_d \text{ a } d\text{-dimensional cube in } [k] \}.$$

Set

$$\mathbb{C}(\Gamma, [k]) = \bigoplus_{d \geq 0} \mathbb{C}_d(\Gamma, [k]).$$

This has two gradings. The first is just d , which we call the *dimensional grading*. The second is the *Maslov grading*, which is defined on cubes by setting $\text{gr}(\square_d) = w(\square_d) + d$. We extend this

⁴In order to avoid an expansion of notation, we will write a generic equivalence class by $[k]$ and denote a generic element of such a class also by k .

to all of $\mathbb{C}(\Gamma, [k])$ by setting $\text{gr}(U) = -2$. The differential is given by inserting powers of U into the usual cellular/cubical differential to make $\text{gr}(\partial) = -1$. That is, let

$$\partial(\square_d) = \sum_{\square_{d-1} \in \text{cellular boundary of } \square_d} U^{(w(\square_{d-1}) - w(\square_d))/2} \epsilon(\square_{d-1}) \square_{d-1}$$

and extend $\mathbb{Z}[U]$ -linearly. Here, the signs $\epsilon(\square_{d-1}) = \pm 1$ are chosen in the usual way by thinking of the cubes of $[k]$ as coming from a cubical decomposition of $\mathbb{R}^{|\Gamma|}$ and choosing orientations. Note that ∂ drops both the dimensional and Maslov gradings by one. The homology of $(\mathbb{C}(\Gamma, [k]), \partial)$ is called the *lattice homology* and is denoted by

$$\mathbb{H}(\Gamma, [k]) = \bigoplus_{d \geq 0} \mathbb{H}_d(\Gamma, [k]),$$

where $\mathbb{H}_d(\Gamma, [k])$ is the homology in dimensional grading d . We write $\mathbb{H}(\Gamma)$ to denote the sum of $\mathbb{H}(\Gamma, [k])$ over all equivalence classes $[k]$, and similarly write $\mathbb{H}_d(\Gamma)$ to denote the analogous sum of the groups $\mathbb{H}_d(\Gamma, [k])$.

In [Ném08, Proposition 3.4.2], it is shown that the lattice homology (in fact, the homotopy equivalence class of the lattice chain complex) is an invariant of (Y_Γ, \mathfrak{s}) , rather than the plumbing graph Γ .

Remark 4.4. The definition of lattice homology we have presented here is essentially due to Némethi [Ném08], but we use slightly different conventions. For the convenience of the reader familiar with [Ném08], we translate between these conventions here:

- (1) In [OS03, Ném05, Ném08], the authors work with the lattice cohomology $\mathbb{H}^d(\Gamma, [k])$. One can show that (up to overall grading shift) $\mathbb{H}^d(\Gamma, [k])$ is dual to $\mathbb{H}_d(\Gamma, [k])$. This duality isomorphism multiplies Maslov grading by -1 , so that the action of U on $\mathbb{H}^d(\Gamma, [k])$ is still of degree -2 . Correspondingly, the isomorphism theorems of [OS03, Ném05, Ném08] are stated in terms of $HF^+(-Y_\Gamma, \mathfrak{s})$, rather than $HF^-(Y_\Gamma, \mathfrak{s})$.
- (2) In [Ném08], the weight function is defined slightly differently than in Definition 4.2. This is because in [Ném08], the weight function is defined on lattice cubes in $L_\Gamma \otimes \mathbb{R}$, rather than $[k] \otimes \mathbb{R}$. Explicitly, in [Ném08] the weight function is defined by fixing a reference characteristic element $k_0 \in [k]$ and setting

$$\tilde{w}(x) = -\frac{1}{2}(k_0(x) + x^2)$$

for any $x \in L_\Gamma$ and

$$\tilde{w}(\square_d) = \max_x \{\tilde{w}(x) \mid x \text{ a vertex of } \square_d\}$$

for any lattice cube \square_d in L_Γ ; see [Ném08, Section 3.2.1]. To see that w (as in Definition 4.2) and \tilde{w} (which we use to denote the weight function of [Ném08, Section 3.2.1]) contain the same information, note that the map $x \mapsto k_0 + 2x^*$ gives an isomorphism between L_Γ and $[k]$. Computing, we see that

$$w(k_0 + 2x^*) = \frac{1}{4}(k_0^2 + 4k_0(x) + 4x^2 + |\Gamma|) = -2\tilde{w}(x) + \frac{1}{4}(k_0^2 + |\Gamma|).$$

Although the left- and right-hand sides are not identical, the differences are cosmetic. The minus sign in front of $\tilde{w}(x)$ is due to the usage of lattice cohomology, as explained above. The factor of two is a convention: in [Ném08, Section 3.1.3], the Maslov grading is defined by doubling the weight function, whereas we have absorbed this into the definition of w . Finally, the term $(k_0^2 + |\Gamma|)/4$ is a constant grading shift depending on

the auxiliary choice of k_0 . This is cancelled out manually in [Ném08, Theorem 5.2.2], whereas we have again instead absorbed this into the definition of w .

4.2. The lattice map. In this paper, we will primarily be concerned with the lattice homology $\mathbb{H}_0(\Gamma, [k])$ in dimensional grading zero. It is a fundamental result of Némethi that if Y_Γ is an AR plumbed manifold then $\mathbb{H}_d(\Gamma, [k]) = 0$ for all $d \geq 1$ [Ném08, Theorem 4.3.3].

It will be helpful for us to re-interpret $\mathbb{H}_0(\Gamma, [k])$ more explicitly in terms of Char_Γ . We have

$$\mathbb{H}_0(\Gamma, [k]) = \text{span}_{\mathbb{Z}[U]} \{k \in [k]\} / \sim, \quad (4.1)$$

where \sim is generated as follows. Let k be any characteristic vector in $[k]$ and v be any vertex in Γ . Denote

$$n = \frac{1}{2} (w(k + 2v^*) - w(k)) = \frac{1}{2} (k(v) + v^2).$$

Then we declare

$$\begin{cases} k \sim U^n(k + 2v^*) & \text{if } n \geq 0 \\ U^{-n}k \sim k + 2v^* & \text{if } n < 0. \end{cases}$$

The fact that this $\mathbb{Z}[U]$ -module is isomorphic to $\mathbb{H}_0(\Gamma, [k])$ (as in Definition 4.3) follows from observing that \sim corresponds precisely to the relations introduced by $\text{im } \partial: \mathbb{C}_1(\Gamma, [k]) \rightarrow \mathbb{C}_0(\Gamma, [k])$.

The reason that this re-interpretation is helpful is that we may construct a map from $\mathbb{H}_0(\Gamma, [k])$ into the Floer homology of Y_Γ :

Definition 4.5. Let $[k]$ be an equivalence class in Char_Γ and let \mathfrak{s} be the spin^c-structure on Y_Γ corresponding to $[k]$. We define the *lattice homology map*

$$\mathbb{T}: \mathbb{H}_0(\Gamma, [k]) \rightarrow HF^-(Y_\Gamma, \mathfrak{s})$$

as follows. Fix, once and for all, a generator $1 \in HF^-(S^3)$. Let k be any characteristic vector in $[k]$. Consider the cobordism map

$$F_{W_\Gamma, k}: HF^-(S^3) \rightarrow HF^-(Y_\Gamma, \mathfrak{s})$$

associated to W_Γ with characteristic vector k . We then define

$$\mathbb{T}(k) = F_{W_\Gamma, k}(1),$$

extending $\mathbb{Z}[U]$ -linearly. The fact that \mathbb{T} respects \sim follows from the adjunction relations, as discussed in [OS03]. Note that the Floer-theoretic Maslov grading shift $\text{gr}(F_{W_\Gamma, k})$ is precisely $\text{gr}(k)$, so \mathbb{T} is grading-preserving.⁵

Remark 4.6. In addition to the choice of generator $1 \in HF^-(S^3)$, each cobordism map $F_{W_\Gamma, k}$ is canonically defined only up to multiplication by ± 1 unless additional data is chosen. However, it is straightforward to fix signs for each $F_{W_\Gamma, k}$ so that \mathbb{T} satisfies the adjunction relations corresponding to \sim ; see [OS03, Section 2.1].

We have used the Heegaard Floer homology HF^- in Definition 4.5, but it is clear that HF^- can be replaced by monopole Floer homology or (in light of [SS23]) by Seiberg-Witten-Floer *homology*. As discussed in Section 2, the principal idea in this paper will be to construct analogues of $\mathbb{H}_0(\Gamma, [k])$ and \mathbb{T} in the setting of Seiberg-Witten-Floer *homotopy*.

It is a fundamental result of Ozsváth and Szabó [OS03, Theorem 1.2] and Némethi [Ném05, Theorem 8.3] that \mathbb{T} is an isomorphism if Γ is (for example) an AR plumbing. The proof of this rests on certain formal properties of the Heegaard Floer package, chief among which is the

⁵Here, we use the convention that $1 \in HF^-(S^3)$ has Maslov grading zero. The original convention of Ozsváth and Szabó is that $1 \in HF^-(S^3)$ has Maslov grading -2 , in which case \mathbb{T} has grading shift -2 .

presence of a surgery exact sequence. By work of the second and third authors, a similar surgery exact sequence holds for Seiberg-Witten-Floer homology [SS23]. Following the same arguments as in [OS03, Ném05] then shows that \mathbb{T} is likewise an isomorphism in our setting. For readers unfamiliar with [OS03, Ném05], an abbreviated discussion of this is included in Section 9.

4.3. Paths and graded roots. There is one more lattice-theoretic construction which we will need in this paper:

Definition 4.7. Define a *path* in $[k]$ to be a sequence (k_i) of lattice points in $[k]$ such that:

- (1) $k_i \neq k_j$ for $i \neq j$; and,
- (2) for each i , we have $k_{i+1} = k_i + 2v^*$ for some vertex $v \in \Gamma$.

We will usually assume that the sequence (k_i) is finite. Often, we will consider the set of edges from each k_i to k_{i+1} to also be a part of the data of γ .

As discussed in Definition 4.1, we may consider the cubical subdivision of $[k] \otimes \mathbb{R} \cong \mathbb{R}^{|\Gamma|}$ as a CW complex. It is clear from the Definition 4.3 that choosing any cubical subcomplex C of $\mathbb{R}^{|\Gamma|}$ gives a subcomplex of $\mathbb{C}(\Gamma, [k])$, simply by considering the $\mathbb{Z}[U]$ -span of all lattice cubes present in C . Since any path γ is an example of such a subcomplex, we have:

Definition 4.8. Let γ be a path in $[k]$. Define the *path lattice complex* $\mathbb{C}(\gamma, [k])$ to be the subcomplex of $\mathbb{C}(\Gamma, [k])$ generated over $\mathbb{Z}[U]$ by the vertices and edges present in γ . The homology of this subcomplex is called the *path lattice homology* and is denoted by $\mathbb{H}(\gamma, [k])$.

Since γ is non-self-intersecting, $\mathbb{H}(\gamma, [k])$ is easily seen to be a submodule of $\mathbb{H}_0(\Gamma, [k])$. As in the previous section, we have a presentation of $\mathbb{H}(\gamma, [k])$ which is generated over $\mathbb{Z}[U]$ by the characteristic vectors k_i in γ , subject to the same relation \sim as in (4.1).

It is a fundamental result due to Némethi [Ném05] that if Γ is an AR plumbing, then there exists a finite path γ in $[k]$ which carries the lattice homology:

Theorem 4.9. [Ném05, Remark 9.4(a)] *Let Γ be an AR plumbing and $[k]$ be an equivalence class in Char_Γ . Then there exists a finite path γ in $[k]$ such that the obvious inclusion map*

$$((w(\square_d) - h)/2)i_*: \mathbb{C}(\gamma, [k]) \rightarrow \mathbb{C}(\Gamma, [k])$$

induces an isomorphism on homology. In particular, the restriction of \mathbb{T} to $\mathbb{H}(\gamma, [k])$ is an isomorphism:

$$\mathbb{T}|_{\mathbb{H}(\gamma, [k])}: \mathbb{H}(\gamma, [k]) \cong \mathbb{H}_0(\Gamma, [k]) \xrightarrow{\cong} HF^-(Y, \mathfrak{s}).$$

Proof. The path in question is found by repeatedly applying Laufer's algorithm, as discussed in [Ném05, Section 7]. Although [Ném05, Remark 9.4] states that the path is infinite, by [Ném05, Theorem 9.3(a)] we may cut off the path after some sufficiently high index (although this is not straightforward to determine explicitly). \square

Path lattice homology reconciles the general construction of lattice homology with the graded root picture of Section 2.1. For any path γ , the presentation (4.1) makes $\mathbb{H}(\gamma, [k])$ into a graded root R , with the lattice points of γ corresponding to the leaves of R . Technically, if R is constructed directly from (4.1), then it will have a large number of redundant generators k_i : for example, we may have pairs of relations of the form $U^m k_{i-1} \sim k_i \sim U^n k_{i+1}$. In Section 2.1, we have used a minimal presentation of R obtained by discarding such k_i and working directly with (for example) $U^m k_{i-1} \sim U^n k_{i+1}$. We view redundant generators as degenerate leaves of R , whose corresponding towers are completely glued to a tower on one or the other side. Clearly, this does not make any difference to the graded root; however, in what follows it will be notationally convenient for us to still treat k_i as a leaf.

5. LATTICE SPECTRUM

In this section, we define the lattice spectrum associated to an AR plumbing. In fact, we first give a more general construction which applies to any negative-definite plumbing, although this will not be used in the current paper. We then finish the proof of Theorem 1.1.

5.1. The general construction. Let Γ be a negative-definite plumbing and $[k]$ be an equivalence class in Char_Γ . Recall that the weight function w of Definition 4.2 is valued in a coset of $2\mathbb{Z}$ in \mathbb{Q} ; fix an auxiliary cutoff weight h lying in this coset. We write $S^{n\mathbb{C}} = (\mathbb{C}^n)^+$ as S^1 -spaces.

For each d -dimensional cube in $[k]$ with $w(\square_d) \geq h$, let

$$\mathcal{F}(\square_d) = S^{((w(\square_d)-h)/2)\mathbb{C}} \wedge \square_d^+. \quad (5.1)$$

We make $\mathcal{F}(\square_d)$ into a pointed S^1 -space by giving \square_d^+ the trivial S^1 -action. Note that $\mathcal{F}(\square_d)$ is just the product $S^{((w(\square_d)-h)/2)\mathbb{C}} \times \square_d$, except that $\{\infty\} \times \square_d$ is collapsed to a single basepoint to stay in the category of pointed S^1 -spaces. If $d = 0$, then $\mathcal{F}(\square_d)$ is just the sphere $S^{((w(\square_d)-h)/2)\mathbb{C}}$.

Now suppose \square_{d-1} is a face of \square_d , so that we have an inclusion

$$f: \square_{d-1}^+ \rightarrow \square_d^+.$$

This gives a way to glue $\mathcal{F}(\square_{d-1})$ and $\mathcal{F}(\square_d)$ together: for any $x \in S^{((w(\square_d)-h)/2)\mathbb{C}}$ and $t \in \square_{d-1}^+$, identify the points

$$(i(x), t) \sim (x, f(t)) \quad (5.2)$$

in $S^{((w(\square_{d-1})-h)/2)\mathbb{C}} \wedge \square_{d-1}^+$ and $S^{((w(\square_d)-h)/2)\mathbb{C}} \wedge \square_d^+$, respectively. Here, i is the usual inclusion map of S^1 -spheres induced by the inclusion

$$\mathbb{C}^{(w(\square_{d-1})-h)/2} \hookrightarrow \mathbb{C}^{(w(\square_d)-h)/2}$$

along the first $(w(\square_{d-1}) - h)/2$ -coordinates. Here, we are using the fact that if \square_{d-1} is a face of \square_d , then $w(\square_d) \leq w(\square_{d-1})$. We then let

$$X = \left(\bigsqcup_{\square_d \text{ in } [k] \text{ with } w(\square_d) \geq h} \mathcal{F}(\square_d) \right) / \sim, \quad (5.3)$$

where the quotient \sim glues together $\mathcal{F}(\square_{d-1})$ and $\mathcal{F}(\square_d)$ according to (5.2) whenever \square_{d-1} is a face of \square_d . See Figure 3.

It is possible to view the identification in (5.3) as a homotopy colimit [BK72] over the category whose objects are faces of the lattice, and whose morphisms $\square_i \rightarrow \square_{i-1}$ are exactly inclusions $\square_{i-1} \subseteq \square_i$ of faces. However, we will not stress this point of view. Note that we may also produce other spectra by using different inclusions maps

$$\mathbb{C}^{(w(\square_{d-1})-h)/2} \hookrightarrow \mathbb{C}^{(w(\square_d)-h)/2},$$

which may even be allowed to vary depending on the cubes \square_{d-1} and \square_d in question. In the language of Section 3.5, applying U on different factors of $S^{((w(\square_d)-h)/2)\mathbb{C}}$ is such a situation. These may result, in principle, in different spectra, although it is easily checked that all such constructions have the same S^1 -Borel homology.

Remark 5.1. It may be psychologically easier for the reader to ignore basepoints and replace (5.1) with

$$\mathcal{F}'(\square_d) = S^{((w(\square_d)-h)/2)\mathbb{C}} \times \square_d.$$

The difference is largely cosmetic: let X' be the space constructed as in (5.3) by using \mathcal{F}' instead of \mathcal{F} . Let S_h be the subset of $[k] \otimes \mathbb{R}$ consisting of the union of all cubes in $[k]$ of weight greater than or equal to h . Then the S^1 -fixed point set of X' is homeomorphic to $(\{0\} \times S_h) \sqcup (\{\infty\} \times S_h)$.

We obtain X from X' by collapsing $\{\infty\} \times S_h$ in X' to a single basepoint. As shown in [Ném08, Corollary 3.2.5], S_h is contractible for h sufficiently negative, in which case X and X' are S^1 -homotopy equivalent. Note that we can additionally collapse $\{0\} \times S_h$ to a single point in order to make the fixed-point set a literal copy of S^0 , which again does not change the homotopy type.

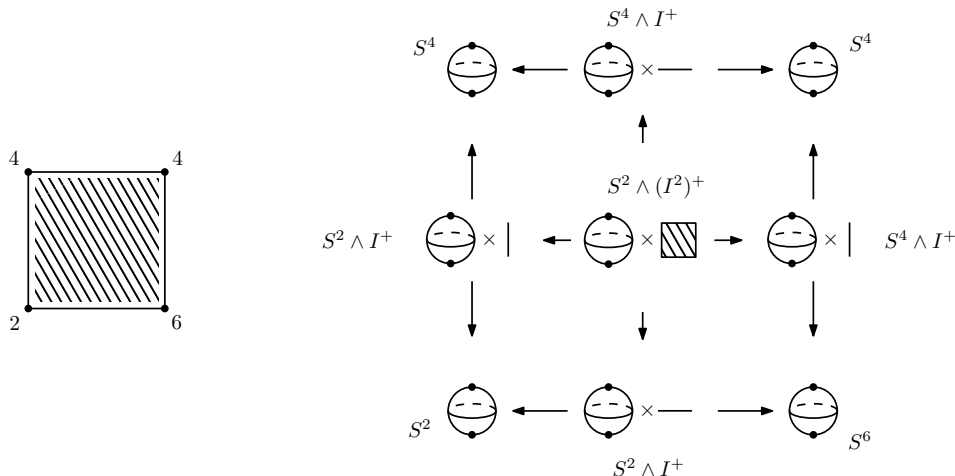

FIGURE 3. A schematic depiction of the construction (5.3) restricted to a single square in $[k]$. Left: a square in $[k]$ with example values of w on its vertices. Right: taking $h = 0$, the pointed S^1 -space constructed according to (5.3). Each arrow represents gluing a portion of the boundary of the domain to a subset (or the entirety) of the codomain. For example, the upper edge $S^2 \times I \subset \partial(S^2 \times I^2)$ of the central square is glued homeomorphically to the subset $S^2 \times I \subset S^4 \times I$ along the top row of the diagram.

For h sufficiently negative, the inclusion of S_h into S_{h-2} is a homotopy equivalence, and in fact the latter deformation retracts onto the former [Ném08, Corollary 3.2.5]. It follows that up to S^1 -homotopy equivalence, decreasing h corresponds to suspending X .

Definition 5.2. The (S^1) -lattice spectrum is defined to be

$$\mathcal{H}(\Gamma, [k]) = (X, 0, -h/2) \in \text{Ob}(\mathcal{C}_{S^1})$$

for h sufficiently negative.

Several theorems from lattice homology have analogous statements in the context of lattice homotopy. In particular, it is possible to upgrade [Ném08, Proposition 3.4.2] to show that $\mathcal{H}(\Gamma, [k])$ is an invariant of (Y_Γ, \mathfrak{s}) , rather than Γ . Although this is not difficult, a full discussion of the proof is rather tedious. Since in this paper we will not use $\mathcal{H}(\Gamma, [k])$, we leave this to the enterprising reader.

5.2. Path lattice homotopy. As in Section 4.3, it is clear that we may restrict the index set of (5.3) to any cubical subcomplex of $[k] \otimes \mathbb{R}$. In particular, let γ be a path in $[k]$ and let h be less than or equal to the minimum of w on γ . Let X be defined as in (5.3), but with index set restricted to the zero- and one-dimensional cubes present in γ . Note that these spaces X_h (depending on h) are each a colimit of a functor $F_h: C(\gamma) \rightarrow \text{Top}$ where $C(\gamma)$ is the category whose objects are vertices and edges of γ , and where morphisms are given by $e \rightarrow v$ if e is an edge and v is a vertex of e . Varying h produces different spaces; namely, the inputs $S^{(w(v_a)-h)/2}\mathcal{C}$ are all changed by a suspension. It is a standard fact that colimit commutes with smash product (in particular, suspension).

We thus obtain a well-defined S^1 -equivariant spectrum:

Definition 5.3. If γ is any path in $[k]$, the (S^1) -path spectrum is defined to be

$$\mathcal{H}(\gamma, [k]) = (X, 0, -h/2) \in \text{Ob}(\mathfrak{C}_{S^1})$$

for h sufficiently negative. The (S^1) -path homotopy type is the stable homotopy type of $\mathcal{H}(\gamma, [k])$.

We will often abuse notation, and use $\mathcal{H}(\gamma, [k])$ to refer to any of (1) the spectrum of Definition 5.3, (2) a space underlying the spectrum in Definition 5.3 or (3) the homotopy type of $\mathcal{H}(\gamma, [k])$; context should make clear what is meant. Up to S^1 -equivariant homotopy, the path spectrum gives a spectrum which is of the same form as described in Section 2.2. The spheres of (2.2) correspond to the spheres $\mathcal{F}(\square_0)$ of (5.3). To make (5.3) into (2.2), we contract along the I -factor in each edge portion $\mathcal{F}(\square_1)$ and also collapse $\{0\} \times \gamma$ to a single point, as described in Remark 5.1.

We now define the zeroth spectrum of an AR plumbed manifold to be the path spectrum associated to any path carrying the lattice homology, as in Theorem 4.9:

Definition 5.4. Let Γ be an AR plumbing and $[k]$ be an equivalence class in Char_Γ . Define the (zeroth) (S^1) -lattice spectrum to be

$$\mathcal{H}_0(\Gamma, [k]) = \mathcal{H}(\gamma, [k])$$

for γ any path carrying the lattice homology.

There are several comments to be made regarding Definition 5.4. First, it is not entirely obvious that $\mathcal{H}_0(\Gamma, [k])$ is independent of the choice of γ (or if the equivalence is canonical). This will not actually be important for us: it turns out that the proof of Theorem 1.1 does not depend on a particular choice of γ , so in fact Theorem 1.1 provides an extremely roundabout way of showing that (the homotopy type of) $\mathcal{H}_0(\Gamma, [k])$ is independent of γ . Alternatively, the fact that Definition 5.4 coincides with the construction of Section 2.2 shows that $\mathcal{H}_0(\Gamma, [k])$ depends only on the graded root $\mathbb{H}(\gamma, [k])$, rather than γ . One can prove that all paths γ which carry the lattice homology give the same graded root structure up to collapsing degenerate leaves; this shows that $\mathcal{H}_0(\Gamma, [k])$ is independent of γ .

It is also possible to show that if γ is a path carrying the lattice homology, then $\mathcal{H}(\gamma, [k]) \simeq \mathcal{H}(\Gamma, [k])$. (This again implicitly shows that Definition 5.4 is independent of γ .) Hence we in fact have

$$\mathcal{H}_0(\Gamma, [k]) = \mathcal{H}(\gamma, [k]) = \mathcal{H}(\Gamma, [k])$$

for an AR plumbed manifold. However, for defining the map \mathcal{T} in the proof of Theorem 1.1, it will be critical that $\mathcal{H}_0(\Gamma, [k])$ is constructed using a path γ . Indeed, we do not know how to define \mathcal{T} on all of $\mathcal{H}(\Gamma, [k])$; see Remark 5.8. We thus write $\mathcal{H}_0(\Gamma, [k])$ rather than $\mathcal{H}(\Gamma, [k])$ to emphasize the restricted nature of the construction, even though we will often refer to $\mathcal{H}_0(\Gamma, [k])$ as the (full) lattice homotopy type in the case of an AR plumbing.

One can likewise show that $\mathcal{H}_0(\Gamma, [k])$ is an invariant of (Y_Γ, \mathfrak{s}) , rather than Γ . Indeed, the invariance of lattice homology can be upgraded to show that the graded root structure is an invariant of (Y_Γ, \mathfrak{s}) , rather than Γ ; hence $\mathcal{H}_0(\Gamma, [k])$ is also an invariant of (Y_Γ, \mathfrak{s}) . Alternatively, one can use the fact that $\mathcal{H}_0(\Gamma, [k]) = \mathcal{H}(\Gamma, [k])$ and show that the latter is independent of Γ , as discussed in Section 5.1. Since we will not need any of these statements in the current paper, we leave the proofs to the reader. Indeed, our proof that $\mathcal{H}_0(\Gamma, [k]) \simeq SWF(Y_\Gamma, \mathfrak{s})$ does not depend on a choice of Γ , which implicitly establishes invariance.

Finally, note that in the case of path lattice homotopy, it is clear that changing the inclusion maps i used in (5.2) does not alter the S^1 -homotopy type of the resulting spectrum.

5.3. Proof of Theorem 1.1. We now turn to the proof of the main theorem. Let Γ be an AR plumbing and $[k]$ be an equivalence class in Char_Γ , with R the graded root corresponding to $\mathbb{H}(\Gamma, [k])$.

Lemma 5.5. *We have an isomorphism of $\mathbb{Z}[U]$ -modules*

$$c\tilde{H}_*^{S^1}(\mathcal{H}_0(\Gamma, [k])) \cong R \cong \mathbb{H}_0(\Gamma, [k]).$$

Proof. Let γ be a path in $[k]$ carrying the lattice homology. Denote the lattice points in γ by k_i and let e_{i-1} and e_i be the lattice edges in γ which abut k_i . Throughout the proof, we use \mathcal{F}' to construct $\mathcal{H}(\gamma, [k])$, as in Remark 5.1; we adopt notation from this remark as well.

For each lattice point $k_i \in \gamma$, let U_i be an open neighborhood of $\mathcal{F}'(k_i)$ in X' which extends slightly more than halfway over $\mathcal{F}'(e_{i-1})$ and $\mathcal{F}'(e_i)$:

$$U_i = \left(S^{((w(e_{i-1})-h)/2)\mathbb{C}} \times (1/2 - \epsilon, 1] \right) \cup S^{((w(k_i)-h)/2)\mathbb{C}} \cup \left(S^{((w(e_i)-h)/2)\mathbb{C}} \times [0, 1/2 + \epsilon) \right).$$

Clearly, U_i equivariantly deformation retracts onto $S^{((w(k_i)-h)/2)\mathbb{C}}$, while each double intersection $U_i \cap U_{i+1}$ equivariantly deformation retracts onto $S^{((w(e_i)-h)/2)\mathbb{C}}$. All other double intersections and triple intersections are empty. The generalized Mayer-Vietoris principle then gives an exact sequence:

$$\cdots \rightarrow \bigoplus_i c\tilde{H}_*^{S^1}(U_i \cap U_{i+1}) \rightarrow \bigoplus_i c\tilde{H}_*^{S^1}(U_i) \rightarrow c\tilde{H}_*^{S^1}(X') \rightarrow \cdots$$

Computing the co-Borel homology of each term gives the short exact sequence

$$0 \rightarrow \bigoplus_i \mathbb{Z}[U]_{w(e_i)-h} \rightarrow \bigoplus_i \mathbb{Z}[U]_{w(k_i)-h} \rightarrow c\tilde{H}_*^{S^1}(X') \rightarrow 0.$$

Here, the zero on the left-hand side is due to the fact that the map out of $\bigoplus_i \mathbb{Z}[U]_{w(e_i)-h}$ is easily seen to be an injection, while the zero on the right-hand side is because $\bigoplus_i \mathbb{Z}[U]_{w(e_i)-h}$ vanishes in odd gradings. This gives a presentation for $c\tilde{H}_*^{S^1}(X')$; we obtain a presentation for $c\tilde{H}_*^{S^1}(\mathcal{H}(\Gamma, [k]))$ by shifting the grading up by h . This is precisely the presentation of $\mathbb{H}_0(\Gamma, [k])$ as a graded root. \square

We now construct a map from $\mathcal{H}_0(\Gamma, [k])$ into $SWF(Y_\Gamma, \mathfrak{s})$:

Lemma 5.6. *There exists an S^1 -equivariant map*

$$\mathcal{T}: \mathcal{H}_0(\Gamma, [k]) \rightarrow SWF(Y_\Gamma, \mathfrak{s})$$

such that

$$\begin{array}{ccc} c\tilde{H}_*^{S^1}(\mathcal{H}_0(\Gamma, [k])) & & \\ \parallel & \searrow \mathcal{T}_* & \\ R & & c\tilde{H}_*^{S^1}(SWF(Y, \mathfrak{s})) \\ \parallel & \nearrow \mathbb{T} & \\ \mathbb{H}_0(\Gamma, [k]) & & \end{array}$$

commutes. Here, \mathcal{T}_* is the map on co-Borel homology induced by \mathcal{T} , the vertical isomorphisms are those of Lemma 5.5, and \mathbb{T} is the map on lattice homology from Definition 4.5.

Proof. As in the proof of Lemma 5.5, let γ be a path in $[k]$ carrying the lattice homology. Denote the lattice points in γ by k_i and let e_{i-1} and e_i be the lattice edges in γ which abut k_i .

For each k_i , consider the relative Bauer-Furuta invariant associated to (W_Γ, k_i) . As discussed in Section 3.4, this gives a homotopy class of map

$$\Psi_{W_\Gamma, k_i} : \Sigma^{(\text{gr}(k_i)/2)\mathbb{C}} SWF(S^3) \rightarrow SWF(Y, \mathfrak{s})$$

where $\text{gr}(k_i) = (k_i^2 + |\Gamma|)/4$. Recall that in the suspension $\mathcal{H}_0(\Gamma, [k]) = \Sigma^{(h/2)\mathbb{C}} X$, the lattice point k_i corresponds to a subsphere

$$\Sigma^{(h/2)\mathbb{C}}(\mathcal{F}(k_i)) = \Sigma^{(h/2)\mathbb{C}} \Sigma^{((\text{gr}(k_i)-h)/2)\mathbb{C}} S^0 = \Sigma^{(\text{gr}(k_i)/2)\mathbb{C}} S^0.$$

We thus define \mathcal{T} on $\Sigma^{(h/2)\mathbb{C}}(\mathcal{F}(k_i)) \subset \mathcal{H}_0(\Gamma, [k])$ to be Ψ_{W_Γ, k_i} .

Now let k_i and k_{i+1} be two successive lattice points in γ , so that $k_{i+1} = k_i + 2v^*$ for some vertex v of Γ . Let

$$n = \frac{1}{2}(w(k_{i+1}) - w(k_i)) = \frac{1}{2}(k_i(v) + v^2).$$

Suppose $n \geq 0$; that is, $\text{gr}(k_{i+1}) \geq \text{gr}(k_i)$. According to the adjunction relation of Proposition 3.15, we have:

$$\Psi_{W_\Gamma, k_i} \simeq U^n \Psi_{W_\Gamma, k_{i+1}} \simeq \Psi_{W_\Gamma, k_{i+1}} U^n.$$

Explicitly, this means that Ψ_{W_Γ, k_i} is homotopic to the composition

$$\Sigma^{(\text{gr}(k_i)/2)\mathbb{C}} S^0 \xleftarrow{U^n} \Sigma^{(\text{gr}(k_{i+1})/2)\mathbb{C}} S^0 \xrightarrow{\Psi_{W_\Gamma, k_{i+1}}} SWF(Y, \mathfrak{s}).$$

where U^n is the usual inclusion of spheres. Choosing representatives for Ψ_{W_Γ, k_i} and $\Psi_{W_\Gamma, k_{i+1}}$, we thus have a homotopy

$$H_t : \Sigma^{(\text{gr}(k_i)/2)\mathbb{C}} S^0 \rightarrow SWF(Y, \mathfrak{s})$$

where $H_0 = \Psi_{W_\Gamma, k_i}$ and H_1 is the restriction of $\Psi_{W_\Gamma, k_{i+1}}$ to $\Sigma^{(\text{gr}(k_i)/2)\mathbb{C}} S^0$. Recall that

$$\mathcal{F}(e_i) = S^{((w(e_i)-h)/2)\mathbb{C}} \wedge I^+ = \Sigma^{(\text{gr}(k_i)/2)\mathbb{C}} S^0 \wedge I^+,$$

where we have used the fact that $w(e_i) = \min\{w(k_i), w(k_{i+1})\} = w(k_i)$. We thus define \mathcal{T} on $\mathcal{F}(e_i)$ by setting $\mathcal{T}(x, t) = H_t(x)$; this descends to a well-defined map on the quotient (5.3). The case when $n < 0$ is similar.

The proof of Lemma 5.5 shows that $c\tilde{H}_*^{S^1}(\mathcal{H}_0(\Gamma, [k]))$ is generated by the induced images (in co-Borel homology) of the inclusions $\mathcal{F}(k_i) \hookrightarrow \mathcal{H}_0(\Gamma, [k])$. Under the isomorphism of Lemma 5.5, these correspond to the $\mathbb{Z}[U]$ -towers which generate $\mathbb{H}_0(\Gamma, [k])$. On each of these towers, the maps \mathcal{T}_* and \mathbb{T} coincide by construction. This establishes the claimed commutative diagram. \square

Finally, we have the following:

Lemma 5.7. *Let $f : X_1 \rightarrow X_2$ be a map of simply-connected, pointed S^1 -CW complexes of type SWF. Suppose that:*

- (1) *f induces a homotopy equivalence on S^1 -fixed point sets, and*
- (2) *f induces an isomorphism on Borel (or co-Borel) homology with \mathbb{Z} -coefficients:*

$$f_* : c\tilde{H}_*^{S^1}(X_1) \rightarrow c\tilde{H}_*^{S^1}(X_2).$$

Then f is an S^1 -homotopy equivalence.

Proof. We begin by noting that the second assumption may be replaced is equivalent to the same assumption for *unreduced* Borel homology. Indeed, writing $G = S^1$, we have that the unreduced and reduced Borel homologies are the second and third terms (respectively) in the long exact sequence

$$\cdots \rightarrow H_*((EG \times *)/G) \rightarrow H_*((EG \times X)/G) \rightarrow \tilde{H}_*((EG_+ \wedge X)/G) \rightarrow \cdots$$

Clearly, f induces an isomorphism on the first term; hence by the five-lemma it induces an isomorphism on unreduced Borel homology if and only if it induces an isomorphism on reduced Borel homology. We may also freely replace homology with cohomology, since a map induces an isomorphism on homology with (\mathbb{Z} -coefficients) if and only if it induces a map on cohomology (with \mathbb{Z} -coefficients).

Moreover, as discussed in [Man16a, Section 5.3], there is a natural long exact sequence relating Borel and co-Borel homology:

$$\cdots \rightarrow \tilde{H}_*^{S^1}(X_i) \rightarrow c\tilde{H}_*^{S^1}(X_i) \rightarrow t\tilde{H}_*^{S^1}(X_i) \rightarrow \cdots,$$

where $t\tilde{H}_*^{S^1}(X_i)$ is the *Tate homology*. Importantly, Tate (co)homology can be computed by localizing the Borel (co)homology of the fixed point set (here we have suppressed grading shifts):

$$t\tilde{H}_{S^1}^*(X_i) = U^{-1}\tilde{H}_{S^1}^*(X_i^{S^1}).$$

The fact that f induces a homotopy equivalence on fixed-point sets thus implies that f induces an isomorphism on the third term of the above sequence. Hence by the five-lemma, f induces an isomorphism on Borel homology if and only if it induces an isomorphism on co-Borel homology.

To establish the lemma, it suffices to show that $f_*: H_*(X_1) \rightarrow H_*(X_2)$ is an isomorphism. For this, consider the Gysin sequence associated to the circle bundle $EG \times X_i \rightarrow (EG \times X_i)/G$:

$$\cdots \rightarrow H^*((EG \times X_i)/G) \xrightarrow{\cup e} H^{*+2}((EG \times X_i)/G) \xrightarrow{\pi^*} H^{*+2}(EG \times X_i) \rightarrow \cdots.$$

The first two terms of this sequence are none other than the (unreduced) Borel cohomology of X_i . Thus f induces an isomorphism on the first two terms; the five-lemma then shows that f induces an isomorphism on $H^*(EG \times X_i)$ (at least for $* \geq 2$, but note that X_i is simply connected). Since EG is contractible, this shows that f induces an isomorphism on $H_*(X_i)$. Applying Theorem 3.9 completes the proof. \square

Putting everything together gives the proof of the main theorem:

Proof of Theorem 1.1: We have constructed a map of S^1 -spectra:

$$\mathcal{T}: \mathcal{H}_0(\Gamma, [k]) \rightarrow SWF(Y_\Gamma, \mathfrak{s}).$$

The commutative diagram of Lemma 5.6, combined with the fact that \mathbb{T} is an isomorphism, shows that \mathcal{T} induces an isomorphism on co-Borel homology. We may suspend the domain and the codomain of \mathbb{T} so that both sides are simply connected. It is clear that \mathcal{T} is a homotopy equivalence of S^1 -fixed point sets, since both the domain and codomain have S^1 -fixed point set given by S^0 . Applying Lemma 5.7 then shows that \mathcal{T} is a homotopy equivalence, as desired. \square

Remark 5.8. The authors do not know how to define a map \mathcal{T} out of $\mathcal{H}(\Gamma, [k])$ in general. As in Lemma 5.6, it is straightforward to define \mathcal{T} on $\mathcal{F}(\square_d)$ for $d = 0$ or 1 , but it is unclear how to define \mathcal{T} on $\mathcal{F}(\square_d)$ for $d \geq 2$. Explicitly, consider a lattice square \square_2 with boundary edges e_i . On each $\mathcal{F}(e_i)$, the map \mathcal{T} may be defined by using a homotopy coming from Lemma 5.6. However, it is then unclear whether \mathcal{T} can be extended over $\mathcal{F}(\square_2)$. Indeed, note that Lemma 5.6 does not even specify a preferred homotopy with which to define \mathcal{T} . While for $\mathcal{H}(\gamma, [k])$, this does not affect the homotopy class of \mathcal{T} , in general this need not be the case. It is possible that the homotopies of Lemma 5.6 must be coherently chosen in order for \mathcal{T} to extend over $\mathcal{F}(\square_2)$.

6. PIN(2)-EQUIVARIANT RESULTS

We now discuss how to upgrade our results to the $\text{Pin}(2)$ -setting. As we will see, if $[k]$ is self-conjugate, it is not difficult to put a $\text{Pin}(2)$ -action on the lattice spectrum $\mathcal{H}_0(\Gamma, [k])$. However,

it turns out that the map

$$\mathcal{T}: \mathcal{H}_0(\Gamma, [k]) \rightarrow SWF(Y_\Gamma, \mathfrak{s})$$

constructed in Lemma 5.6 is *not* obviously $\text{Pin}(2)$ -equivariant. Hence we cannot immediately generalize the proof of Theorem 1.1. We explain this subtlety below.

6.1. Almost J -invariant paths. Recall that we have identified the set of spin^c -structures on W_Γ with Char_Γ . Under this correspondence, the action of conjugation is given by the obvious negation map $J: k \mapsto -k$. Note that the weight function w (as a function on Char_Γ) is evidently J -invariant.

A self-conjugate spin^c -structure $[k]$ on Y_Γ corresponds to an equivalence class $[k]$ which is sent to itself under J . Explicitly, if $[k]$ is self-conjugate, then it is easily checked that there must exist some fixed $w_1, \dots, w_{|\Gamma|}$, each equal to zero or one, such that $[k]$ is precisely equal to

$$[k] = \left\{ \sum_{i=1}^{|\Gamma|} c_i v_i^* : c_i \equiv w_i \pmod{2} \right\}.$$

We refer to the w_i as the *Wu coefficients* associated to $[k]$ and the characteristic element $w = w_1 v_1^* + \dots + w_{|\Gamma|} v_{|\Gamma|}^* \in [k]$ as the *Wu element*. For example, if W_Γ is spin , then the restriction of this spin structure to Y_Γ corresponds to the equivalence class $[k]$ with Wu coefficients $w_1 = \dots = w_\Gamma = 0$.

Assume $[k]$ is self-conjugate. Then J induces an automorphism on the set of lattice cubes in $[k]$, simply by sending a lattice cube \square_d to its reflection $J(\square_d)$. Working over $\mathbb{F} = \mathbb{Z}/2\mathbb{Z}$ so as to disregard signs, the $\mathbb{F}[U]$ -linear extension of this automorphism defines a chain map

$$J: \mathbb{C}(\Gamma, [k]) \rightarrow \mathbb{C}(\Gamma, [k])$$

which by abuse of notation we also denote by J . This involution was studied in [Dai18] and used to compute the $\text{Pin}(2)$ -equivariant monopole Floer homology of Y_Γ . (A similar strategy was carried out in [DM19] in the setting of involutive Heegaard Floer homology.) Although we will not spell out the details here, it is possible to use J to construct a $\text{Pin}(2)$ -equivariant spectrum whose underlying S^1 -spectrum is $\mathcal{H}(\Gamma, [k])$, although it is not clear to us if the $\text{Pin}(2)$ -spectrum defined this way is suitably independent of the choices in its construction.⁶

However, in our context, we will be interested in putting a $\text{Pin}(2)$ -structure on the path lattice spectrum $\mathcal{H}_0(\Gamma, [k])$, as this is the object which admits a map into $SWF(Y_\Gamma, [k])$. Unfortunately, $\mathcal{H}_0(\Gamma, [k])$ turns out to be somewhat unnatural from the point of view of J . To understand why, observe that there is exactly one lattice cube \square_J which is sent to itself by J , but the dimension of this cube will be given by the number of non-zero Wu coefficients. Thus, in general $[k]$ may not admit any J -invariant path, in which case defining a $\text{Pin}(2)$ -structure on $\mathcal{H}_0(\Gamma, [k])$ is not entirely natural. As we will see, this leads to an important additional subtlety with the proof of Theorem 1.2. See Figure 4.

The following lemma is taken from the proof of [Dai18, Theorem 3.2]:

Lemma 6.1. [Dai18, Theorem 3.2] *The weight function w takes the same value on all vertices of the J -invariant lattice cube \square_J .*

⁶The construction of G -spectra from G -diagrams is treated in Dotto-Moi [DM16]; a very special case of this is also performed in [SZ18]. However, that framework does not apply exactly, since the diagram category here is itself sent to equivariant spectra.

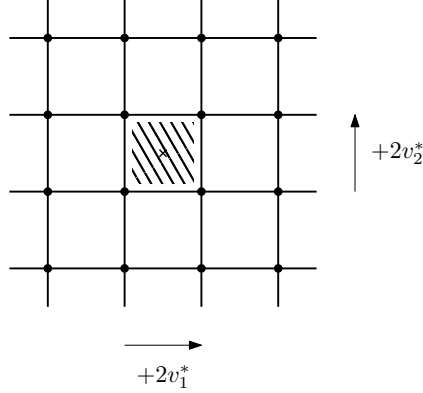

FIGURE 4. An example of the action of J on the affine lattice $[k]$. Here, the action of J is given by reflection through the center of the single J -invariant lattice square, which is shaded.

Proof. In [Dai18, Lemma 3.1], it is shown that if i and j are two distinct indices with w_i and w_j both non-zero, then v_i and v_j are not adjacent in Γ ; that is, $(v_i, v_j) = 0$. Now, the vertices of \square_J are precisely the characteristic elements

$$k = \sum_{i=1}^{|\Gamma|} \epsilon_i w_i v_i^*$$

with each $\epsilon_i \in \{-1, +1\}$. Expanding the self-pairing (k, k) and applying the above fact shows that the value of the weight function w on each of these vertices is the same. \square

Definition 6.2. We say that a path γ is *almost J -invariant* if we can decompose $\gamma = \gamma_\Theta \cup \gamma_0$, where:

- (1) The path γ_Θ connects two opposite corners k_Θ and $J(k_\Theta)$ of the invariant lattice cube \square_J . This path is contained in \square_J but may not itself be J -invariant. Note that the weight function w is constant along γ_Θ .
- (2) The subset γ_0 consists of a pair of paths that are interchanged by J . One of these has an endpoint on k_Θ , while the other has an endpoint on $J(k_\Theta)$; the paths are otherwise disjoint from \square_J .

See Figure 5.

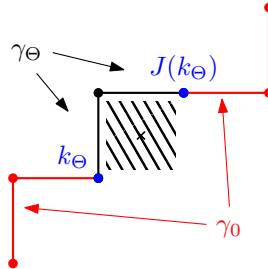

FIGURE 5. An almost J -invariant path. Note that both γ_Θ and γ_0 contain the vertices k_Θ and $J(k_\Theta)$.

Using Lemma 6.1, it is not difficult to modify the algorithm of [Ném05, Section 7] to find a path γ in $[k]$ which carries the lattice homology and is almost J -invariant.

6.2. **A Pin(2)-structure on $\mathcal{H}_0(\Gamma, [k])$.** Let γ be an almost J -invariant path carrying the lattice homology. Clearly, we have

$$\mathcal{H}(\gamma, [k]) = \mathcal{H}(\gamma_\Theta, [k]) \cup \mathcal{H}(\gamma_0, [k]),$$

glued along $\mathcal{F}(k_\Theta) \vee \mathcal{F}(J(k_\Theta))$, as shown in Figure 6. We give each of these two pieces a Pin(2)-action as follows:

- (1) $\mathcal{H}(\gamma_\Theta, [k])$: Choose the cutoff weight h so that $(w(\square_J) - h)$ is 0 mod 4; that is to say $\mathbb{C}^{(w(\square_J)-h)/2} \cong \mathbb{H}^{(w(\square_J)-h)/4}$ so that $S^{((w(\square_J)-h)/2)\mathbb{C}}$ has the structure of a Pin(2)-sphere. It follows from Lemma 6.1 that $\mathcal{H}(\gamma_\Theta, [k])$ is S^1 -homotopy equivalent to

$$S^{((w(\square_J)-h)/2)\mathbb{C}} \wedge I^+,$$

where we view $I = [-1, 1]$. Let j act on I by -1 , with the action of S^1 on I being trivial. We then give $\mathcal{H}(\gamma_\Theta, [k])$ the product Pin(2)-structure.

- (2) $\mathcal{H}(\gamma_0, [k])$: First construct half of $\mathcal{H}(\gamma_0, [k])$ by applying the usual construction of Section 5.2 to one of the two connected components of γ_0 . Instead of constructing the other half arbitrarily, we introduce it as the formal image of the first half under j . More precisely, any S^1 -sphere $(\mathbb{C}^n)^+$ may be completed to a pair of S^1 -spheres

$$(\mathbb{C}^n)^+ \vee j(\mathbb{C}^n)^+$$

such that j interchanges the two spheres and is skew-invariant with respect to the action of S^1 . (That is, $e^{i\theta}j = je^{-i\theta}$.) Let \square_0 and $J(\square_0)$ thus be a pair of lattice points in γ_0 related by J . Instead of introducing $\mathcal{F}(\square_0)$ and $\mathcal{F}(J(\square_0))$ independently, we introduce them simultaneously, so that

$$\mathcal{F}(\square_0) \vee \mathcal{F}(J(\square_0)) = S^{((w(\square_0)-h)/2)\mathbb{C}} \vee jS^{((w(\square_0)-h)/2)\mathbb{C}}$$

as Pin(2)-spaces. A similar construction for the lattice edges and the gluing maps gives $\mathcal{H}(\gamma_0, [k])$ a Pin(2)-action.

We then glue together $\mathcal{H}(\gamma_\Theta, [k])$ and $\mathcal{H}(\gamma_0, [k])$ in a Pin(2)-equivariant manner to give a Pin(2)-action on all of $\mathcal{H}(\gamma, [k])$. We stress that as an S^1 -space, the above construction is homotopy equivalent to that of $\mathcal{H}(\gamma, [k])$ in Section 5.2, as all we have done is re-parameterize $\mathcal{H}(\gamma_\Theta, [k])$ and chosen particular gluing/inclusion maps. See Figure 6.

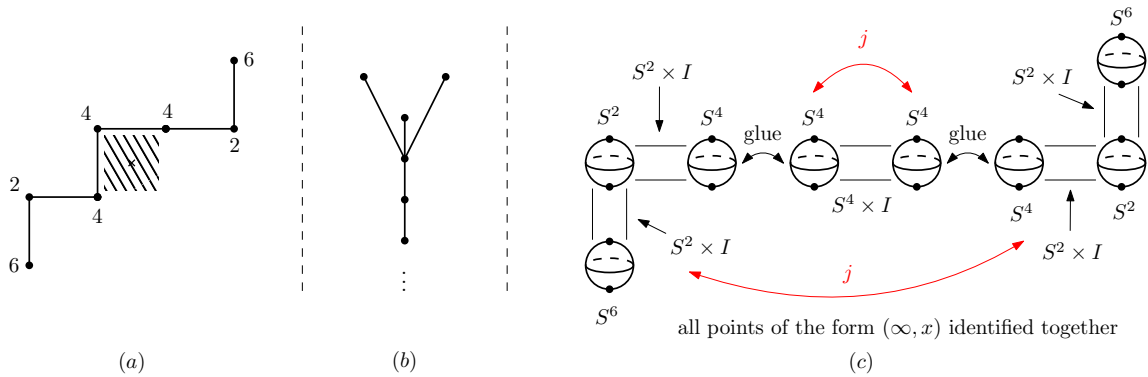

FIGURE 6. An illustration of the j -action on $\mathcal{H}(\gamma, [k])$. Left: (a) example weights on the vertices of γ . Middle: (b) the corresponding graded root. Right: (c) the decomposition of $\mathcal{H}(\gamma, [k])$ into the pieces $\mathcal{H}(\gamma_\Theta, [k])$ and $\mathcal{H}(\gamma_0, [k])$; all points of the form (∞, x) are identified together. On $\mathcal{H}(\gamma_0, [k])$, the action of j interchanges the two halves. On $\mathcal{H}(\gamma_\Theta, [k])$, the action of j is given by identifying $S^4 = \mathbb{H}^+$ and letting j on $I = [-1, 1]$ be multiplication by -1 . The product action descends to the quotient $(S^4 \times I)/(\{\infty\} \times I)$.

The following lemma shows that with these choices, the map \mathcal{T} is compatible with the $\text{Pin}(2)$ -structure:

Lemma 6.3. *The map \mathcal{T} can be chosen such that*

$$\mathcal{T}: \mathcal{H}_0(\gamma, [k]) \rightarrow \text{SWF}(Y_\Gamma, [k])$$

is $\text{Pin}(2)$ -equivariant on $\mathcal{H}(\gamma_0, [k])$.

Proof. Recall from the proof of Lemma 5.6 that \mathcal{T} is not canonically defined: we may choose any representative of the relative Bauer-Furuta invariant when defining \mathcal{T} for lattice points, and similarly any homotopy (in the adjunction relation) when defining \mathcal{T} for lattice edges. We use that, for any pair of vertices related by J , the associated pair of spheres in $\mathcal{H}(\gamma_0, [k])$ is identified with the domain of (3.5). The construction of Section 3.4 then gives a $\text{Pin}(2)$ -equivariant map on the vertices of $\mathcal{H}(\gamma_0, [k])$. The homotopies involved in the definition of \mathcal{T} are defined to be $\text{Pin}(2)$ -equivariant by defining them first on one half γ_L of γ_0 , and then reflecting to define a homotopy on $J(\gamma_L)$. \square

If W_Γ is spin and $[k]$ is the restriction of this spin structure to Y_Γ , then γ_Θ will consist of a single point corresponding to the zero characteristic element. In this case, \mathcal{T} can be made $\text{Pin}(2)$ -equivariant on all of $\mathcal{H}(\gamma, [k])$, since $\Psi_{W_\Gamma, 0}$ can be made $\text{Pin}(2)$ -equivariant. However, in general we only know that \mathcal{T} is an S^1 -equivariant map on $\mathcal{H}(\gamma_\Theta, [k])$.

6.3. Proof of Theorem 1.2: We now complete the proof of Theorem 1.2. Up to suspension, we may assume that the S^1 -homotopy type of $\mathcal{H}(\gamma_\Theta, [k])$ is S^0 ; for notational convenience, let such a suspension be fixed. For brevity, write

$$\Gamma_0 = \mathcal{H}(\gamma_0, [k]) \quad \text{and} \quad \Gamma = \mathcal{H}(\gamma, [k]).$$

Throughout, let $[X, Y]_G$ denote stable homotopy classes of G -maps between two G -spectra; for notation on G -spectra we refer to [SS21, Section 7]. To consider G -spectra, it is necessary to fix a choice of *universe*. The natural choice of universe for our $\text{Pin}(2)$ -spectra is exactly $\mathcal{U} = \mathbb{R}^\infty \oplus \tilde{\mathbb{R}}^\infty \oplus \mathbb{H}^\infty$; note that \mathcal{U} defines a S^1 -universe $\mathcal{U}_{S^1} \cong \mathbb{R}^\infty \oplus \mathbb{C}^\infty$ by restricting along the inclusion $S^1 \rightarrow \text{Pin}(2)$. A universe \mathcal{V} is called *complete* if every finite-dimensional orthogonal representation of G embeds in \mathcal{V} . Write $G - \text{Sp}$ for the category of G -spectra, with the universe suppressed from the notation.

For $H \subset G$ a closed subgroup, we will also frequently make use of the *geometric H -fixed points* functor $\Phi^H: G - \text{Sp} \rightarrow W_G H - \text{Sp}$. Here, if \mathcal{V} is the universe on the left, the universe on the right-hand side is \mathcal{V}^H , the H -fixed points of the universe \mathcal{V} . In particular, for us the S^1 -fixed points functor takes the universe \mathcal{U} to a complete C_2 -universe. All spectra we consider below come from objects of \mathfrak{C}_{S^1} and $\mathfrak{C}_{\text{Pin}(2)}$; that is, we need only suspension spectra of finite G -CW complexes X , written as $\Sigma^\infty X$ (note that when there is no risk of confusion, we may write X for the suspension spectrum associated to X). For these, $\Phi^H(\Sigma^\infty X) = \Sigma^\infty X^H$, so fixed-point spectra are much like fixed-point sets.

Finally, two objects $(W_0, m_0, n_0), (W_1, m_1, n_1)$ of $\mathfrak{C}_{\text{Pin}(2)}$ are equivalent if and only if the spectra $\Sigma^{m_i \tilde{\mathbb{R}} \oplus n_i \mathbb{H}} W_i$ are equivalent in the category of $\text{Pin}(2)$ -spectra over the universe \mathcal{U} .

We list the main tools of the proof of Theorem 1.2 here:

- (ho-1) The tom Dieck splitting [tD75, LMSM86]. For a very readable description see [LM21, Section 4]:

Theorem 6.4. *Let X be a pointed G -space (G a compact Lie group), and \mathcal{V} be a G -universe. Then there is an isomorphism:*

$$\zeta = \sum \zeta_H^G: \bigoplus_{[H]} \pi_{k, \mathcal{V}^H}^{W_G H} (EW_G H_+ \wedge X^H) \rightarrow \pi_{k, \mathcal{V}}^G(X)$$

where the sum runs over conjugacy classes of closed subgroups of G . Moreover, if $G = C_2$, the image of $\zeta_e^{C_2}$ is the kernel of the fixed-point functor $\pi_k^{C_2}(X) \rightarrow \pi_k^e(X^{C_2})$ (cf. [LM21, Lemma 4.6]). Here, the subscripts $\mathcal{V}, \mathcal{V}^H$ serve to remind us that the homotopy groups are taken in the category of G (etc.)-spectra over the universes \mathcal{V} (resp. \mathcal{V}^H).

- (ho-2) For an exact sequence of spectra $X \rightarrow Y \rightarrow Z$, there are exact sequences $[A, X] \rightarrow [A, Y] \rightarrow [A, Z]$ and $[Z, B] \rightarrow [Y, B] \rightarrow [X, B]$; the corresponding statement holds in G -spectra as well.
- (ho-3) Let H be a subgroup of G . Let $i: H \rightarrow G$ denote the inclusion and i^* be the change-of-groups functor on spectra. There are natural bijections for X a finite H -spectrum and Y a finite G -spectrum:

$$[X, i^*Y]_H \leftrightarrow [G_+ \wedge_H X, Y]_G$$

and

$$[i^*Y, X]_H \leftrightarrow [Y, G_+ \wedge_H X]_G.$$

See [Ada84, Theorem 5.1] and [Ada84, Theorem 5.2], or [May96, XVI.4]. That is, the forgetful functor i^* is adjoint to $G_+ \wedge -$. Explicitly, the construction of this adjunction is as follows: there is an H -map

$$\alpha: X \rightarrow G_+ \wedge_H X,$$

sending $x \rightarrow (e, x)$ where $e \in G$ is the identity. The first bijection

$$\alpha^*: [G_+ \wedge_H X, Y]_G \rightarrow [X, i^*Y]_H$$

is obtained by applying the forgetful map $[G_+ \wedge_H X, Y]_G \rightarrow [G_+ \wedge_H X, i^*Y]_H$, followed by pullback along α to $[X, i^*Y]_H$. For the second bijection, there is likewise an H -map

$$\alpha: G_+ \wedge_X H \rightarrow X;$$

see the proof of [Ada84, Theorem 5.2]. The bijection

$$\alpha_*: [Y, G_+ \wedge_H X]_G \rightarrow [i^*(Y), X]_H$$

is similarly obtained by applying the forgetful map and then taking the pushforward along α to $[i^*(Y), X]_H$.

The rough idea of the proof is as follows. First observe that by direct inspection of the map $\Gamma_0 \rightarrow \Gamma$, we have an exact sequence of $\text{Pin}(2)$ -spectra:

$$\cdots \rightarrow \Gamma_0 \rightarrow \Gamma \rightarrow \Sigma^{\mathbb{R}} S^0 \rightarrow \cdots . \quad (6.1)$$

As discussed in Lemma 6.3, \mathcal{T} restricts to a $\text{Pin}(2)$ -map from Γ_0 into $SWF(Y, \mathfrak{s})$. Let

$$\Theta = \text{Cone}(\Gamma_0 \xrightarrow{\mathcal{T}|_{\Gamma_0}} SWF(Y, \mathfrak{s})).$$

Note that this cone inherits a $\text{Pin}(2)$ -structure. We have an analogous sequence of $\text{Pin}(2)$ -spectra:

$$\cdots \rightarrow \Gamma_0 \xrightarrow{\mathcal{T}|_{\Gamma_0}} SWF(Y, \mathfrak{s}) \rightarrow \Theta \rightarrow \cdots . \quad (6.2)$$

Because \mathcal{T} is an S^1 -equivalence, (6.1) and (6.2) are isomorphic if we forget about the $\text{Pin}(2)$ -action and consider them as S^1 -sequences. That is, we have a commutative diagram

$$\begin{array}{ccccccc} \cdots & \longrightarrow & \Gamma_0 & \longrightarrow & \Gamma & \longrightarrow & \Sigma^{\tilde{\mathbb{R}}} S^0 \longrightarrow \cdots \\ & & \downarrow & & \downarrow \mathcal{T} & & \downarrow \\ \cdots & \longrightarrow & \Gamma_0 & \xrightarrow{\mathcal{T}|_{\Gamma_0}} & SWF(Y, \mathfrak{s}) & \longrightarrow & \Theta \longrightarrow \cdots \end{array} \quad (6.3)$$

where the first two rows are exact sequences of $\text{Pin}(2)$ -spectra, but the middle (and right) vertical maps should *a priori* be interpreted only as maps of S^1 -spectra.

Examining (6.3), we see that

$$\Sigma^{\mathbb{R}} \Gamma = \text{Cone}(\Sigma^{\tilde{\mathbb{R}}} S^0 \rightarrow \Sigma^{\mathbb{R}} \Gamma_0) \quad \text{and} \quad \Sigma^{\mathbb{R}} SWF(Y, \mathfrak{s}) = \text{Cone}(\Theta \rightarrow \Sigma^{\mathbb{R}} \Gamma_0) \quad (6.4)$$

as $\text{Pin}(2)$ -mapping cones. Moreover, the vertical maps of (6.3) are S^1 -equivalences. Hence

$$\Theta \simeq_{S^1} \Sigma^{\tilde{\mathbb{R}}} S^0$$

as S^1 -spectra. Here, we use the subscript \simeq_{S^1} to indicate that both sides should be considered as S^1 -spectra; we continue to write $\Sigma^{\tilde{\mathbb{R}}} S^0$ even though as an S^1 -spectrum this is just $\Sigma^{\mathbb{R}} S^0$. Our goal will be to show that in fact

$$\Theta \simeq_{\text{Pin}(2)} \Sigma^{\tilde{\mathbb{R}}} S^0$$

and then show the attaching maps of (6.4) coincide. This will show that \mathcal{T} admits a $\text{Pin}(2)$ -lift to a $\text{Pin}(2)$ -equivalence.

To carry out our strategy, we produce a $\text{Pin}(2)$ -map

$$M': \Theta \rightarrow \Sigma^{\tilde{\mathbb{R}}} S^0$$

which is a (nonequivariant) homotopy equivalence on $\text{Pin}(2)$ -, S^1 -, and $\{e\}$ -fixed point spectra. Applying the equivariant Whitehead theorem will then give the desired $\text{Pin}(2)$ -equivalence. It is thus important to understand the S^1 -fixed point spectrum of Θ , which has the structure of a C_2 -spectrum. The following result will be helpful for subsequent lemmas:

Lemma 6.5. *We have*

$$\Phi^{S^1} \Theta \simeq_{C_2} \Sigma^{\tilde{\mathbb{R}}} S^0.$$

Proof. Applying the S^1 -fixed point functor to (6.3) gives

$$\begin{array}{ccccccc} \cdots & \longrightarrow & \Phi^{S^1} \Gamma_0 & \xrightarrow{f} & \Phi^{S^1} \Gamma & \longrightarrow & \Phi^{S^1}(\Sigma^{\tilde{\mathbb{R}}} S^0) \longrightarrow \cdots \\ & & \downarrow & & \downarrow h & & \downarrow \\ \cdots & \longrightarrow & \Phi^{S^1} \Gamma_0 & \xrightarrow{g} & \Phi^{S^1} SWF(Y, \mathfrak{s}) & \longrightarrow & \Phi^{S^1} \Theta \longrightarrow \cdots \end{array} \quad (6.5)$$

Here, the two horizontal rows are exact sequences of C_2 -spectra, whereas the middle (and right) maps should only be interpreted as non-equivariant equivalences. Note, however, that by direct inspection

$$\Phi^{S^1} \Gamma \simeq_{C_2} S^0 \quad \text{and} \quad \Phi^{S^1} SWF(Y, \mathfrak{s}) \simeq_{C_2} S^0.$$

Hence $\Phi^{S^1} \Gamma \simeq_{C_2} \Phi^{S^1} SWF(Y, \mathfrak{s})$, even though h is not *a priori* a C_2 -map. On the other hand, it is not hard to see that h lifts to a C_2 -equivalence

$$\tilde{h}: \Phi^{S^1} \Gamma \rightarrow \Phi^{S^1} SWF(Y, \mathfrak{s}),$$

since every equivalence in $[S^0, S^0]$ lifts to an equivalence in $[S^0, S^0]_{C_2}$.

We claim that the classes of

$$f \in [\Phi^{S^1}\Gamma_0, \Phi^{S^1}\Gamma]_{C_2} \quad \text{and} \quad g \in [\Phi^{S^1}\Gamma_0, \Phi^{S^1}SWF(Y, \mathfrak{s})]_{C_2}$$

coincide. More precisely, consider the diagram:

$$\begin{array}{ccc} [\Phi^{S^1}\Gamma_0, \Phi^{S^1}\Gamma]_{C_2} & \xrightarrow{\alpha^*} & [S^0, i^*(\Phi^{S^1}\Gamma)] \\ \downarrow \tilde{h}_* & & \downarrow h_* \\ [\Phi^{S^1}\Gamma_0, \Phi^{S^1}SWF(Y, \mathfrak{s})]_{C_2} & \xrightarrow{\alpha^*} & [S^0, i^*(\Phi^{S^1}SWF(Y, \mathfrak{s}))] \end{array} \quad (6.6)$$

Here, the horizontal rows are given by (ho-3); the fact that the diagram commutes is easily proven using the definition of α^* . Due to (6.3), note that

$$h \circ i^*(f) = i^*(g)$$

where $i^*(f)$ and $i^*(g)$ are the maps f and g considered as non-equivariant morphisms. We claim that in fact

$$\tilde{h} \circ f = g.$$

This will imply that the rightmost vertical arrow in (6.5) admits a C_2 -lift. Indeed, by definition of α^* , we have

$$\alpha^*(g) = i^*(g) \circ \alpha = h \circ i^*(f) \circ \alpha = h_*(\alpha^*(f)) = \alpha^*(\tilde{h} \circ f).$$

Since α^* is a bijection, the commutativity of (6.6) gives the desired claim. \square

We now begin our construction of a $\text{Pin}(2)$ -map from Θ to $\Sigma^{\tilde{\mathbb{R}}}S^0$. We first map Θ into a high-dimensional $\text{Pin}(2)$ -sphere. Denote by

$$c: S^0 \rightarrow \Sigma^{\tilde{\mathbb{R}}}S^0$$

the inclusion of C_2 -spectra.

Lemma 6.6. *For p and q sufficiently large, there exists a $\text{Pin}(2)$ -map*

$$M: \Theta \rightarrow \Sigma^{q\tilde{\mathbb{R}}+p\mathbb{H}}S^0$$

which induces an equivalence on $\text{Pin}(2)$ -fixed point spectra.

Proof. Using [Ada84, Proposition 4.2], it follows from the cell description of Γ_0 that

$$[\Gamma_0, \Sigma^{q\tilde{\mathbb{R}}+p\mathbb{H}}S^0]_{\text{Pin}(2)} = 0$$

for p and q sufficiently large. Taking maps from the exact sequence (6.2) into $\Sigma^{q\tilde{\mathbb{R}}+p\mathbb{H}}S^0$ gives the top row of the commutative diagram:

$$\begin{array}{ccc} [\Theta, \Sigma^{q\tilde{\mathbb{R}}+p\mathbb{H}}S^0]_{\text{Pin}(2)} & \xrightarrow{\cong} & [SWF(Y, \mathfrak{s}), \Sigma^{q\tilde{\mathbb{R}}+p\mathbb{H}}S^0]_{\text{Pin}(2)} \\ \Phi^{S^1} \downarrow & & \downarrow \Phi^{S^1} \\ [\Sigma^{\tilde{\mathbb{R}}}S^0, \Sigma^{q\tilde{\mathbb{R}}}S^0]_{C_2} & \longrightarrow & [S^0, \Sigma^{q\tilde{\mathbb{R}}}S^0]_{C_2}. \end{array} \quad (6.7)$$

The top row is an isomorphism for p and q sufficiently large. The second row is obtained by applying the S^1 -fixed point functor. From Lemma 6.5, we know that the map

$$\Phi^{S^1}SWF(Y, \mathfrak{s}) \rightarrow \Phi^{S^1}\Theta$$

is equal to c . This is because f and g in the proof of Lemma 6.5 coincide, and the claim is easily seen to hold for the map from $\Phi^{S^1}\Gamma$ into $\text{Cone}(f)$. Hence the bottom horizontal arrow of (6.7) is given by precomposing with c .

Now, for p and q sufficiently large, there exists a $\text{Pin}(2)$ -map

$$N: SWF(Y, \mathfrak{s}) \rightarrow \Sigma^{q\tilde{\mathbb{R}}+p\mathbb{H}}S^0$$

such that the map on S^1 -fixed points is given by

$$\Phi^{S^1}N = c^q: S^0 \rightarrow \Sigma^{q\tilde{\mathbb{R}}}S^0.$$

This may be deduced from the fact that Y bounds some spin 4-manifold, which has a Bauer-Furuta map of this form. The map N is an element in the top-right corner of (6.7). Let M be the corresponding element of the top-left corner. By commutativity of (6.7), we have

$$(\Phi^{S^1}M) \circ c = \Phi^{S^1}N = c^q.$$

This implies that $\Phi^{\text{Pin}(2)}M$ is a homotopy equivalence since c and c^q are both equivalences of $\text{Pin}(2)$ -fixed point spectra. \square

We now use Lemma 6.6 to produce the desired map M' . Denote by

$$c: S^0 \rightarrow \Sigma^{\tilde{\mathbb{R}}}S^0 \quad \text{and} \quad V: S^0 \rightarrow \Sigma^{\mathbb{H}}S^0$$

the $\text{Pin}(2)$ -inclusions.

Lemma 6.7. *Let $q \geq 2$. Any $\text{Pin}(2)$ -map*

$$M: \Theta \rightarrow \Sigma^{q\tilde{\mathbb{R}}+p\mathbb{H}}S^0$$

which induces an equivalence on $\text{Pin}(2)$ -fixed point spectra can be factored as

$$M = c^{q-1}V^pM'$$

for some $\text{Pin}(2)$ -map

$$M': \Theta \rightarrow \Sigma^{\tilde{\mathbb{R}}}S^0$$

which induces an equivalence on $\text{Pin}(2)$ - and S^1 -fixed point spectra.

Proof. Consider the exact sequence

$$S^0 \xrightarrow{c} \Sigma^{\tilde{\mathbb{R}}}S^0 \rightarrow \Sigma^{\mathbb{R}}(C_2)_+ \tag{6.8}$$

of $\text{Pin}(2)$ -spectra. Suspend this sequence by $\tilde{\mathbb{R}}^{q-1}$ and take maps from Θ into the result. We claim that

$$[\Theta, \Sigma^{(q-1)\tilde{\mathbb{R}}}S^0]_{\text{Pin}(2)} \xrightarrow{c^*} [\Theta, \Sigma^{q\tilde{\mathbb{R}}}S^0]_{\text{Pin}(2)} \tag{6.9}$$

is surjective for $q \geq 2$. Indeed, observe that the third term in the exact sequences vanishes, since by (ho-3) we have

$$[\Theta, \Sigma^{(q-1)\tilde{\mathbb{R}}}(\Sigma^{\mathbb{R}}(C_2)_+)]_{\text{Pin}(2)} = [i^*(\Theta), \Sigma^{(q-1)\tilde{\mathbb{R}}}(\Sigma^{\mathbb{R}}S^0)]_{S^1} = [\Sigma^{\mathbb{R}}S^0, \Sigma^{q\mathbb{R}}S^0]_{S^1}$$

and this is zero whenever $q \geq 2$. This shows that M can be lifted through c^{q-1} . A similar argument applies to show that M can be lifted through V^p . Hence we can factor

$$M = c^{q-1}V^pM',$$

as claimed. Note, however, that there is an ambiguity in the choice of M' . Indeed, in the case $q = 2$, suspending (6.8) gives

$$\cdots \rightarrow \Sigma^{\tilde{\mathbb{R}}}(C_2)_+ \rightarrow \Sigma^{\tilde{\mathbb{R}}}S^0 \xrightarrow{c} \Sigma^{2\tilde{\mathbb{R}}}S^0 \rightarrow \Sigma^{\tilde{\mathbb{R}}}(\Sigma^{\mathbb{R}}(C_2)_+) \rightarrow \cdots.$$

Hence lifting through c in this case has an ambiguity given by the image of the connecting morphism:

$$[\Theta, \Sigma^{\tilde{\mathbb{R}}}(C_2)_+]_{\text{Pin}(2)} \rightarrow [\Theta, \Sigma^{\tilde{\mathbb{R}}}S^0]_{\text{Pin}(2)}. \tag{6.10}$$

We claim M' may be chosen to induce a homotopy equivalence on $\text{Pin}(2)$ - and S^1 -fixed point spectra. It is clear that M' automatically induces an equivalence on $\text{Pin}(2)$ -fixed point spectra, since this holds for M , c , and V . We thus turn to S^1 -fixed point spectra. We in fact prove

$$\Phi^{S^1} M': \Phi^{S^1} \Theta \rightarrow \Sigma^{\tilde{\mathbb{R}}} S^0$$

can be assumed to be an equivalence of C_2 -spectra. By Lemma 6.7, $\Phi^{S^1} M'$ lies in

$$[\Sigma^{\tilde{\mathbb{R}}} S^0, \Sigma^{\tilde{\mathbb{R}}} S^0]_{C_2} = [S^0, S^0]_{C_2}.$$

To understand the set of such maps, we use the tom Dieck splitting. This says that

$$[S^0, S^0]_{C_2} = \pi_0^{C_2}((EC_2)_+) \oplus \pi_0^{\{e\}}(S^0) = \mathbb{Z}\langle w, 1 \rangle. \quad (6.11)$$

Indeed, for a finite group G , $[S^0, S^0]_G = A(G)$, where $A(G)$ is the Burnside ring of G , whose elements are formal differences of finite G -sets, see [Seg71, tD87]. The group structure on $[S^0, S^0]_G$ agrees with that of $A(G)$ using product of G -sets. Under this identification, the maps which induces homotopy equivalences on C_2 -fixed point spectra are those of the form $kw \pm 1$, while the maps ± 1 are C_2 -equivalences (in addition to two other homotopy equivalences, which we shall not need). Indeed, all we need from the discussion is the splitting (6.11) and the fact that the maps called ± 1 in this decomposition are homotopy equivalences.

It is clear that $\Phi^{S^1} M'$ induces an equivalence of C_2 -fixed point spectra since M' induces an equivalence of $\text{Pin}(2)$ -fixed point spectra. Hence $\Phi^{S^1} M'$ is of the form $kw \pm 1$ under (6.11). We claim that the additional ambiguity in lifting M to M' allows us to alter the coefficient k . To see this, consider (6.10). This fits into the commutative diagram

$$\begin{array}{ccc} [\Theta, \Sigma^{\tilde{\mathbb{R}}}(C_2)_+]_{\text{Pin}(2)} & \longrightarrow & [\Theta, \Sigma^{\tilde{\mathbb{R}}} S^0]_{\text{Pin}(2)} \\ \Phi^{S^1} \downarrow & & \downarrow \Phi^{S^1} \\ [\Phi^{S^1} \Theta, \Sigma^{\tilde{\mathbb{R}}}(C_2)_+]_{C_2} & \longrightarrow & [\Phi^{S^1} \Theta, \Sigma^{\tilde{\mathbb{R}}} S^0]_{C_2}, \end{array} \quad (6.12)$$

where the vertical maps are induced by the restriction map Φ^{S^1} . By Lemma 6.5, the bottom row may be re-written

$$[\Sigma^{\tilde{\mathbb{R}}} S^0, \Sigma^{\tilde{\mathbb{R}}}(C_2)_+]_{C_2} \rightarrow [\Sigma^{\tilde{\mathbb{R}}} S^0, \Sigma^{\tilde{\mathbb{R}}} S^0]_{C_2},$$

which, after de-suspending by $\tilde{\mathbb{R}}$, is the same as a map

$$[S^0, (C_2)_+]_{C_2} \rightarrow [S^0, S^0]_{C_2}. \quad (6.13)$$

We claim that the image of (6.13) is the image of $\zeta_e^{C_2}$ in the tom Dieck splitting (6.11). Indeed, applying the tom Dieck splitting to the left-hand side of (6.13) gives

$$[S^0, (C_2)_+]_{C_2} = \pi_0^{C_2}((EC_2)_+ \wedge (C_2)_+) \oplus \pi_0^{\{e\}}(\{\text{pt}\}) = \pi_0^{C_2}((EC_2)_+ \wedge (C_2)_+) \oplus \{e\}. \quad (6.14)$$

Since the tom Dieck splitting is functorial, (6.13) is thus identified with a C_2 -map

$$\pi_0^{C_2}((EC_2)_+ \wedge (C_2)_+) \rightarrow \pi_0^{C_2}((EC_2)_+ \wedge S^0).$$

This is the same as a map (coming from the natural map of nonequivariant spaces):

$$\pi_0((EC_2)_+) \rightarrow \pi_0((BC_2)_+). \quad (6.15)$$

The map $(EC_2)_+ \rightarrow (BC_2)_+$ sends the non-basepoint component of $(EC_2)_+$ to the non-basepoint component of $(BC_2)_+$, and so (6.15) is an isomorphism. Now, by Theorem 6.4, $[S^0, (C_2)_+]_{C_2} \rightarrow [S^0, S^0]_{C_2}$ is an isomorphism from $[S^0, (C_2)_+]_{C_2}$ to the kernel of Φ^{C_2} , which is in turn identified with $\mathbb{Z}\langle w \rangle \subset [S^0, S^0]_{C_2}$. Hence changing M' by an element in the image

of the top row of (6.12) results (after taking S^1 -fixed point spectra) in changing $\Phi^{S^1} M'$ by the addition of some kw .

Finally, we claim that the left-hand vertical arrow in (6.12) is an isomorphism. To see this, observe that

$$[\Theta, \Sigma^{\tilde{\mathbb{R}}}(C_2)_+]_{\text{Pin}(2)} = [\Theta, \Sigma^{\tilde{\mathbb{R}}}S^0]_{S^1} = [\Sigma^{\mathbb{R}}S^0, \Sigma^{\mathbb{R}}S^0]_{S^1}$$

by (ho-3), and $\Phi^{S^1} : [\Sigma^{\mathbb{R}}S^0, \Sigma^{\mathbb{R}}S^0]_{S^1} \rightarrow [\Sigma^{\mathbb{R}}S^0, \Sigma^{\mathbb{R}}S^0]$ is an isomorphism by the discussion after Lemma 3.14. It follows that any change kw in $\Phi^{S^1} M'$ can be achieved via changing the lift through (6.10).

We thus see that M' may be assumed to be ± 1 under the identification (6.11). This means that $\Phi^{S^1} M'$ is a C_2 -equivalence and (in particular) a usual equivalence, as desired. \square

We finally conclude the proof of Theorem 1.2:

Proof of Theorem 1.2. We have explained already that

$$\Sigma^{\mathbb{R}}\Gamma = \text{Cone}(\Sigma^{\tilde{\mathbb{R}}}S^0 \rightarrow \Sigma^{\mathbb{R}}\Gamma_0) \quad \text{and} \quad \Sigma^{\mathbb{R}}SWF(Y, \mathfrak{s}) = \text{Cone}(\Theta \rightarrow \Sigma^{\mathbb{R}}\Gamma_0).$$

Using Lemmas 6.6 and 6.7, we have a $\text{Pin}(2)$ -map

$$M' : \Theta \rightarrow \Sigma^{\tilde{\mathbb{R}}}S^0$$

which is an equivalence on $\text{Pin}(2)$ - and S^1 -fixed point spectra. The fact that M' is an equivalence on S^1 -fixed point spectra shows that M' induces an isomorphism on Tate homology.

As we have seen, (6.3) shows that

$$\Theta \simeq_{S^1} \Sigma^{\tilde{\mathbb{R}}}S^0.$$

Hence the S^1 -Borel homology of Θ consists of a single tower. An S^1 -map from Θ to $\Sigma^{\tilde{\mathbb{R}}}S^0$ which induces an isomorphism on Tate homology thus induces an isomorphism on Borel homology. Applying Lemma 5.7, we conclude that M' induces a (non-equivariant, stable) equivalence from Θ to $\Sigma^{\tilde{\mathbb{R}}}S^0$. The equivariant Whitehead theorem then shows that M' is a $\text{Pin}(2)$ -equivalence.

It remains to identify the attaching maps in two mapping cones coming from (6.3), which we denote by

$$f \in [\Sigma^{\tilde{\mathbb{R}}}S^0, \Sigma^{\mathbb{R}}\Gamma_0]_{\text{Pin}(2)} \quad \text{and} \quad g \in [\Theta, \Sigma^{\mathbb{R}}\Gamma_0]_{\text{Pin}(2)}.$$

This follows as in the proof of Lemma 6.5, so we will be brief. Observe that

$$\Gamma_0 = \text{Pin}(2)_+ \wedge_{S^1} \mathcal{H}(\gamma_L, [k])$$

where γ_L is one of the two components of γ_0 . We thus have a diagram

$$\begin{array}{ccc} [\Sigma^{\tilde{\mathbb{R}}}S^0, \Sigma^{\mathbb{R}}\Gamma_0]_{\text{Pin}(2)} & \xrightarrow{\alpha_*} & [i^*(\Sigma^{\tilde{\mathbb{R}}}S^0), \Sigma^{\mathbb{R}}\mathcal{H}(\gamma_L, [k])]_{S^1} \\ \downarrow (M')^* & & \downarrow (i^*(M'))^* \\ [\Theta, \Sigma^{\mathbb{R}}\Gamma_0]_{\text{Pin}(2)} & \xrightarrow{\alpha_*} & [i^*(\Theta), \Sigma^{\mathbb{R}}\mathcal{H}(\gamma_L, [k])]_{S^1}. \end{array} \quad (6.16)$$

Here, the horizontal rows are given by (ho-3); the fact that the diagram commutes is proven easily from the definition of α_* . It follows from (6.3) that

$$i^*(f) \circ i^*(M') = i^*(g),$$

where $i^*(f)$ and $i^*(g)$ are the maps f and g considered as S^1 -morphisms. We claim that in fact

$$f \circ M' = g.$$

Indeed, observe that by definition of α_* , we have

$$\alpha_*(g) = \alpha \circ i^*(g) = \alpha \circ i^*(f) \circ i^*(M') = (i^*(M'))^*(\alpha_*(f)).$$

Because α_* is a bijection, commutativity of (6.16) gives the desired claim. Since now $f \circ M' = g$ as $\text{Pin}(2)$ -maps, we have that there is a $\text{Pin}(2)$ -equivariant commutative square

$$\begin{array}{ccc} \Sigma^{\mathbb{R}} S^0 & \longrightarrow & \Sigma^{\mathbb{R}} \Gamma_0 \\ \downarrow & & \downarrow \\ \Theta & \longrightarrow & \Sigma^{\mathbb{R}} \Gamma_0 \end{array}$$

lifting the corresponding (*a priori* only S^1 -equivariant) square in (6.3). It follows that \mathcal{T} admits a $\text{Pin}(2)$ -equivariant lift; the preceding calculations show that this lift may be assumed to be a $\text{Pin}(2)$ -equivalence, completing the proof. \square

7. COMPUTATIONS

We now give several consequences of Theorems 1.1 and 1.2. First, we prove that for AR homology spheres, the relation of local equivalence in the category of spectra [Sto20, Definition 2.7] coincides with the relation of local equivalence defined for chain complexes; see [Sto20, Definition 2.19] and [HM17, Definition 8.5]. Following Remark 2.1, we also show that the construction of the lattice spectrum depends only on the homology of the graded root R , rather than its combinatorial structure. Finally, we establish Corollaries 1.3 through 1.6. Throughout this section, we write $G = \text{Pin}(2)$.

7.1. Graded roots and local maps. Throughout, we assume the reader is broadly familiar with the discussion of [DM19] regarding symmetric graded roots.

Definition 7.1. Let R_1 and R_2 be two graded roots. A *graded root map* is a grading-preserving, $\mathbb{Z}[U]$ -equivariant map from the $\mathbb{Z}[U]$ -module represented by R_1 to the $\mathbb{Z}[U]$ -module represented by R_2 . If R_1 and R_2 are symmetric, then we require F to intertwine these symmetries. We denote such a map by

$$F: R_1 \rightarrow R_2.$$

Note that our construction of the lattice spectrum $\mathcal{H}(\Gamma, [k])$ factors through the graded root associated to $\mathbb{H}(\Gamma, [k])$. In general, given an arbitrary graded root R , we denote by $\mathcal{H}(R)$ the resulting S^1 -lattice homotopy type, with the understanding that if R is symmetric then $\mathcal{H}(R)$ is a $\text{Pin}(2)$ -homotopy type. The following fundamental lemma shows that any graded root map may be lifted to a map of spectra. If the original map is symmetric, then the result may be taken to be $\text{Pin}(2)$ -morphism under a mild grading hypothesis.

Lemma 7.2. *Let R_1 and R_2 be two graded roots and suppose that we have a graded root map*

$$F: R_1 \rightarrow R_2.$$

Then there exists a S^1 -equivariant morphism

$$\mathcal{F}: \mathcal{H}(R_1) \rightarrow \mathcal{H}(R_2)$$

which induces the map F on (S^1 -equivariant) co-Borel homology. Moreover, suppose R_1 and R_2 are symmetric graded roots and F is equivariant. If the uppermost J -invariant vertices of R_1 and R_2 lie in the same grading mod 4, then \mathcal{F} may be taken to be a $\text{Pin}(2)$ -morphism.

Proof. We handle the S^1 -case first. Recall from Section 2.1 that R_1 is generated (over $\mathbb{Z}[U]$) by the leaves $\{x_i\}_{i=1}^n$, subject to the relations

$$U^{(\text{gr}(x_i) - \text{gr}(\alpha_i))/2} x_i \sim U^{(\text{gr}(x_{i+1}) - \text{gr}(\alpha_i))/2} x_{i+1} \quad (7.1)$$

ranging over the angles $\{\alpha_i\}_{i=1}^{n-1}$. Then $\mathcal{H}(R_1)$ is constructed by introducing a sphere S_{x_i} for each leaf x_i ; for each angle α_i , we attach a cylinder from a subsphere of S_{x_i} to a subsphere of $S_{x_{i+1}}$ with dimension corresponding to the above relation. It follows that to construct a map $\mathcal{H}(R_1) \rightarrow \mathcal{H}(R_2)$, it suffices to construct maps $\varphi_i: S_{x_i} \rightarrow \mathcal{H}(R_2)$ together with homotopies between the maps

$$U^{(\text{gr}(x_i) - \text{gr}(\alpha_i))/2} \varphi_i \simeq U^{(\text{gr}(x_{i+1}) - \text{gr}(\alpha_i))} \varphi_{i+1} \quad (7.2)$$

for each $i \in \{1, \dots, n-1\}$.

Denote the leaves of R_2 by z_j . Given F as in the lemma statement, let F_{ij} be the component of F over $\mathbb{Z}[U]$ from x_i to z_j . For each homogeneous element c of $\mathbb{Z}[U]$, there is an evident (well-defined up to homotopy) map in $[S_{x_i}, S_{z_j}]_{S^1}$, which we will denote by c' . Since the stable homotopy category is additive, we may define a (equivariant stable homotopy class of) map

$$\varphi_i: S_{x_i} \rightarrow \bigvee_j S_{z_j}$$

by adding together F'_{ij} over j . Moreover, if $S_{\alpha_i} \times I$ is the cylinder from S_{x_i} to $S_{x_{i+1}}$, then S_{α_i} is canonically identified with a (de)suspension of both S_{x_i} and $S_{x_{i+1}}$. We claim that by construction, there is a homotopy as in (7.2). Indeed,

$$[X, \bigvee_i Y_i] = \bigoplus_i [X, Y_i],$$

so it suffices to compare φ_i and φ_{i+1} componentwise. Then (7.1) shows that the appropriate terms of (7.2) agree, giving the required homotopy. This defines \mathcal{F} . Clearly, \mathcal{F} induces the map F on co-Borel homology.

Now suppose that R_1 and R_2 are symmetric and that F is equivariant with respect to these symmetries.⁷ Using the adjunction relation (ho-3) in Section 6.3, in order to construct a $\text{Pin}(2)$ -map \mathcal{F} it suffices to:

- (1) For the uppermost J -invariant vertex x_i of R_1 construct a $\text{Pin}(2)$ -map

$$\varphi_i: S_{x_i} \rightarrow \mathcal{H}(R_2)$$

where S_{x_i} is the $\text{Pin}(2)$ -representation sphere associated to x_i . (Here, we denote the symmetry on R_1 by J . We treat the uppermost J -invariant vertex as a degenerate leaf, if needed.)

- (2) For x_i a leaf in the *left* half R_l of R_1 , construct a S^1 -map

$$S_{x_i} \rightarrow \mathcal{H}(R_2),$$

where S_{x_i} is the S^1 -representation sphere at the vertex x_i , together with S^1 -homotopies as in (7.2).

The existence of the S^1 -maps and homotopies is exactly as in the previous case. The hypothesis that F is equivariant is used implicitly to build a map satisfying (2), so that the map into $\mathcal{H}(R)$ given by doubling the collection of maps in (2) agrees, on co-Borel homology, with F . To construct the map in (1), we have two cases. Either F applied to the vertex x_i is a sum of non-symmetric vertices, in which case we are done as in (2). If $F(x_i)$ has support on a central vertex, then, by our assumption on the gradings of the central vertices, we have that $F(x_i)$ is supported by $U^\ell y$, where y is the topmost central vertex of R_2 , and ℓ is even. The sphere S_y

⁷In fact, one can show that if any homology isomorphism between two symmetric graded roots exists, then an equivariant isomorphism exists; see for example the proof of [Sto20, Theorem 3.16].

corresponding to y is then a copy of $S^{((\text{gr}(x_i)+2\ell)/4)\mathbb{H}}$, and we use for the component $S_{x_i} \rightarrow S_y$ of φ_i the inclusion map

$$S^{((\text{gr}(x_i)/4)\mathbb{H})} \rightarrow S^{((\text{gr}(x_i)+2\ell)/4)\mathbb{H}}.$$

This completes the construction of the desired $\text{Pin}(2)$ -map \mathcal{F} . \square

It is straightforward to use Lemma 7.2 to reconcile the different notions of local equivalence arising in this context. Explicitly, let (Y_1, \mathfrak{s}_1) and (Y_2, \mathfrak{s}_2) be two AR homology spheres equipped with self-conjugate spin^c -structures. There are several different settings in which to consider local equivalence:

- (1) (*spectrum*) *local equivalence* between the spectra associated to (Y_1, \mathfrak{s}_1) and (Y_2, \mathfrak{s}_2) , as discussed in [Sto20, Definition 2.7];
- (2) (*chain*) *local equivalence* between the *SWF*-type chain complexes associated to (Y_1, \mathfrak{s}_1) and (Y_2, \mathfrak{s}_2) , as discussed in [Sto20, Definition 2.19];
- (3) (*involutive Heegaard Floer*) *local equivalence* between the ι -complexes associated to (Y_1, \mathfrak{s}_1) and (Y_2, \mathfrak{s}_2) , as discussed in [HM17, Definition 8.5]; and,
- (4) (*graded root*) *local equivalence* between the symmetric graded roots associated to the lattice homologies of (Y_1, \mathfrak{s}_1) and (Y_2, \mathfrak{s}_2) .

The first of these notions is defined in terms of spectra, while the second and third are defined in terms of chain complexes. In principle, spectrum local equivalence is stronger than chain local equivalence, while involutive Heegaard Floer local equivalence should be thought of as analogous to chain local equivalence (albeit defined in the involutive Heegaard Floer setting).⁸ The fourth notion is considered implicitly in [DM19]: we say that a graded root map is local if it induces an isomorphism after inverting U ; a graded root local equivalence consists of local maps in both directions.

In our context, each graded root is the Heegaard Floer or Seiberg-Witten-Floer homology of an AR homology sphere. Thus, the difference between (for example) (3) and (4) simply consists of passing from a chain complex to its homology and remembering the action of j or ι on the result. In principle, this means that (4) is the weakest possible notion of local equivalence. However, the arguments of [DM19, Section 6] show that (in the case of a graded root) (3) and (4) are the same. There is a slight subtlety here since the notion of local equivalence in [DM19] is over $\mathbb{F}[U]$, while in our context graded roots are considered over $\mathbb{Z}[U]$. We address this in the proof of Theorem 7.3 below.

We now prove that (1) through (4) coincide in our setting. Note that (4) was studied at length in [DM19]. In particular, in [DM19, Section 6] it is shown that any symmetric graded root R admits a *monotone subroot* which is the simplest representative of its local equivalence class.

Theorem 7.3. *Let (Y_1, \mathfrak{s}_1) and (Y_2, \mathfrak{s}_2) be two AR homology spheres equipped with self-conjugate spin^c -structures. If (Y_1, \mathfrak{s}_1) and (Y_2, \mathfrak{s}_2) are locally equivalent according to any one of (1) through (4), then they are locally equivalent according all of them.*

Proof. We first remark that graded root local equivalence over $\mathbb{Z}[U]$ and $\mathbb{F}[U]$ are the same. Clearly, the former implies the latter. Conversely, it was shown in [DM19] that a graded root is locally equivalent to its monotone subroot over $\mathbb{F}[U]$; an analysis of the local equivalence

⁸Conjecturally, involutive Heegaard Floer homology corresponds to $\mathbb{Z}/4\mathbb{Z}$ -equivariant Seiberg-Witten-Floer homology. If this were true, then (3) would be weaker than (2).

maps presented in [DM19, Section 6.1] shows that these may be lifted to local maps of $\mathbb{Z}[U]$ -modules. Since two graded roots are locally equivalent over $\mathbb{F}[U]$ if and only if they have the same monotone subroot, this establishes the claim.

We thus already have that (3) and (4) are equivalent and that (1) implies (2). It is not hard to see that (2) implies (4) by passing to homology. Hence it suffices to show that (4) implies (1). This follows immediately from Lemma 7.2: if F_1 and F_2 are local equivalences between the symmetric graded roots R_1 and R_2 associated to (Y_1, \mathfrak{s}_1) and (Y_2, \mathfrak{s}_2) , then we obtain $\text{Pin}(2)$ -morphisms \mathcal{F}_1 and \mathcal{F}_2 between the lattice homotopy types $\mathcal{H}(R_1)$ and $\mathcal{H}(R_2)$. The fact that F_1 and F_2 are local implies that \mathcal{F}_1 and \mathcal{F}_2 induce isomorphisms on Tate homology, which easily shows that \mathcal{F}_1 and \mathcal{F}_2 are local. \square

A similar argument establishes Remark 2.1. Let R_1 and R_2 be two graded roots (equipped with planar embeddings, as discussed in Remark 2.1). Then:

Theorem 7.4. *Let*

$$F: R_1 \rightarrow R_2$$

be an isomorphism of graded roots. Then we have an S^1 -equivariant homotopy equivalence

$$\mathcal{F}: \mathcal{H}(R_1) \rightarrow \mathcal{H}(R_2).$$

If F is a J -equivariant isomorphism of symmetric graded roots, then this is a $\text{Pin}(2)$ -equivariant homotopy equivalence.

Proof. The lifted morphism \mathcal{F} induces an isomorphism on co-Borel homology. As in the proof of Theorem 1.1 it follows that \mathcal{F} induces a homotopy equivalence on all relevant fixed-point sets and is thus an equivariant homotopy equivalence. \square

Finally, we discuss some numerical results established in [Dai18] that will be useful in the sequel. Let Y be an AR homology sphere with self-conjugate spin^c -structure \mathfrak{s} . The Floer-theoretic invariants of (Y, \mathfrak{s}) can be read off from its symmetric graded root R as follows:

- (1) Denote the grading of the uppermost vertex in R by $2\delta(R)$. By definition of the Frøyshov invariant, we have

$$\delta(R) = \delta(Y, \mathfrak{s}). \tag{7.3}$$

- (2) Denote the grading of the uppermost J -invariant vertex in R by $2\beta(R)$. It is shown in [Dai18, Theorem 2.4] and [Dai18, Theorem 3.2] that

$$\beta(R) = \beta(Y, \mathfrak{s}) = -\bar{\mu}(Y, \mathfrak{s}). \tag{7.4}$$

In particular, note that $\delta(R)$ and $\beta(R)$ take the same value among all representatives in the (graded root) local equivalence class of R .

By Theorem 7.3, for the purposes of computing the K -theoretic cobordism invariants of $SWF(Y, \mathfrak{s}) = \mathcal{H}(R)$, it suffices to replace R with its monotone subroot. It will thus be useful for us to consider the following especially simple class of graded root:

Definition 7.5. Let X_n be the symmetric graded root given by

$$X_n = \text{span}_{\mathbb{Z}[U]} \{v, Jv\} \quad \text{with} \quad U^n v = U^n (Jv).$$

For concreteness, we set $\text{gr}(v) = \text{gr}(Jv) = 2n$. With this convention, $\delta(X_n) = n$ and $\beta(X_n) = 0$. Denote

$$A_n = \mathcal{H}(X_n).$$

Note that we allow the degenerate case $n = 0$, in which case A_0 is homotopy equivalent to S^0 .

Definition 7.6. We say that a symmetric graded root R is *projective* if its monotone subroot is given by X_n for some n (up to grading shift). If R arises from (Y, \mathfrak{s}) and R is projective, we also refer to (Y, \mathfrak{s}) as projective. By Theorem 7.3, if (Y, \mathfrak{s}) is projective, then (up to suspension) $SWF(Y, \mathfrak{s})$ is locally equivalent to A_n . It follows from the preceding discussion that in this situation

$$n = \delta(Y, \mathfrak{s}) - \beta(Y, \mathfrak{s}) = \delta(Y, \mathfrak{s}) + \mu(Y, \mathfrak{s})$$

and the suspension in question is given by

$$SWF(Y, \mathfrak{s}) = \mathcal{H}(R) \sim \Sigma^{\beta(Y, \mathfrak{s})\mathbb{C}} A_n = \Sigma^{-\mu(Y, \mathfrak{s})\mathbb{C}} A_n.$$

See [Sto20, Section 1] and [DM19, Section 1] for further discussion of Definition 7.6.

7.2. K -theory. The next lemma gives a complete calculation of the K -theory of A_n . We use notation as in [Man14, Section 3].

Lemma 7.7. *We have*

$$\tilde{K}_{\text{Pin}(2)}(A_n) = \mathfrak{J}(A_n) = (z^{\lfloor n/2 \rfloor}, w) \quad \text{and} \quad K_{\text{Pin}(2)}^1(A_n) = 0.$$

In particular,

$$\kappa(A_n) = \begin{cases} 0 & \text{if } n = 0 \\ 2 & \text{else.} \end{cases}$$

Proof. We have a cofiber sequence in spaces (or just as well, in spectra):

$$S^{n\mathbb{C}} \vee S^{n\mathbb{C}} \rightarrow A_n \rightarrow S^{\tilde{\mathbb{R}}} \rightarrow \Sigma^{\mathbb{R}}(S^{n\mathbb{C}} \vee S^{n\mathbb{C}}) \rightarrow \dots$$

where j interchanges the two wedge summands. Taking fixed points of this sequence gives

$$S^0 \vee S^0 \rightarrow A_n^{S^1} \rightarrow (S^{\tilde{\mathbb{R}}})^{S^1} \rightarrow \dots$$

Note that $(S^{\tilde{\mathbb{R}}})^{S^1} = S^{\tilde{\mathbb{R}}}$. Applying $G = \text{Pin}(2)$ -equivariant K -theory, we have the commutative diagram

$$\begin{array}{ccccccccc} \tilde{K}_G^1(S^{\tilde{\mathbb{R}}}) & \xleftarrow{\delta} & \tilde{K}_G(S^{n\mathbb{C}} \vee S^{n\mathbb{C}}) & \xleftarrow{\iota^*} & \tilde{K}_G(A_n) & \xleftarrow{\quad} & \tilde{K}_G(S^{\tilde{\mathbb{R}}}) & \xleftarrow{\quad} & \tilde{K}_G(\Sigma^{\mathbb{R}}(S^{n\mathbb{C}} \vee S^{n\mathbb{C}})) \\ \downarrow = & & \downarrow & & \downarrow \Phi^* & & \downarrow = & & \downarrow \\ \tilde{K}_G^1(S^{\tilde{\mathbb{R}}}) & \xleftarrow{\delta} & \tilde{K}_G(S^0 \vee S^0) & \xleftarrow{\quad} & R(G) & \xleftarrow{\quad} & \tilde{K}_G(S^{\tilde{\mathbb{R}}}) & \xleftarrow{\quad} & \tilde{K}_G(\Sigma^{\mathbb{R}}(S^0 \vee S^0)) \end{array} \quad (7.5)$$

Here, we have $A_n^{S^1} \simeq S^0$; we have written $R(G) = \tilde{K}_G(S^0)$ for the complex representation ring of G . We are interested in calculating both the K -theory $\tilde{K}_G(A_n)$ and the ideal $\mathfrak{J}(A_n) \subset R(G)$ given by the image of Φ^* , from which κ is derived.

We begin by determining some of the groups and maps in the above commutative diagram. We will need the following:

- (1) Since j acts freely away from the basepoint on $S^0 \vee S^0$, we have

$$\tilde{K}_G(S^0 \vee S^0) = \tilde{K}_{S^1}(S^0) = R(S^1) = \mathbb{Z}[\theta, \theta^{-1}],$$

where θ is the standard complex representation of S^1 . Likewise,

$$\tilde{K}_G(S^{n\mathbb{C}} \vee S^{n\mathbb{C}}) = \tilde{K}_{S^1}(S^{n\mathbb{C}}) = R(S^1) = \mathbb{Z}[\theta, \theta^{-1}],$$

by using Bott periodicity. Under this identification, the second vertical map is given by multiplication by the equivariant Euler class c^n , where $c = 1 - \theta$.

(2) By a similar argument,

$$\tilde{K}_G(\Sigma^{\mathbb{R}}(S^0 \vee S^0)) = \tilde{K}_{S^1}(\Sigma^{\mathbb{R}} S^0) = 0$$

and

$$\tilde{K}_G(\Sigma^{\mathbb{R}}(S^{n\mathbb{C}} \vee S^{n\mathbb{C}})) = \tilde{K}_{S^1}(\Sigma^{\mathbb{R}} S^{n\mathbb{C}}) = 0.$$

(3) In [Man14, Section 2.2] it is shown that

$$R(G) = \mathbb{Z}[z, w]/(2w - zw, w^2 - 2w).$$

Under the above identification of $\tilde{K}_G(S^0 \vee S^0)$ with $\mathbb{Z}[\theta, \theta^{-1}]$, the map

$$r: R(G) \rightarrow \tilde{K}_G(S^0 \vee S^0)$$

is given by sending $1 \rightarrow 1, z \rightarrow 2 - \theta - \theta^{-1}$, and $w \rightarrow 0$. Note that the kernel of r is equal to (w) .

Putting this together gives:

$$\begin{array}{ccccccc} \tilde{K}_G^1(S^{\mathbb{R}}) & \xleftarrow{\delta} & R(S^1) & \xleftarrow{\iota^*} & \tilde{K}_G(A_n) & \xleftarrow{\quad} & \tilde{K}_G(S^{\mathbb{R}}) \\ \downarrow = & & \downarrow c^n & & \downarrow \Phi^* & & \downarrow = \\ \tilde{K}_G^1(S^{\mathbb{R}}) & \xleftarrow{\delta} & R(S^1) & \xleftarrow{r} & R(G) & \xleftarrow{\quad} & \tilde{K}_G(S^{\mathbb{R}}) \end{array} \quad (7.6)$$

First observe that $w \in \text{im } \Phi^*$. Indeed, the map from $R(G)$ to $R(S^1)$ has w in its kernel; hence w lies in the image of the bottom-right map. The fact that the fourth column is an isomorphism then gives the claim.

We now claim that a class $y \in R(G)$ is in the image of Φ^* if and only if $r(y)$ is in the image of c^n . Indeed, if $y = \Phi^*(x)$ for some $x \in \tilde{K}_G(A_n)$, then it is clear that $r(y)$ is in the image of c^n by writing

$$r(y) = r(\Phi^*(x)) = c^n(\iota^*(x)).$$

Conversely, suppose that $r(y)$ is in the image of c^n ; say $r(y) = c^n x'$. By exactness, $r(y)$ is annihilated by δ . The fact that the first column is an isomorphism then shows that x' must also be annihilated by δ . Hence x' is in the image of ι^* ; say $x' = \iota^*(x)$. Then we have

$$r(y) = c^n(\iota^*(x)) = r(\Phi^*(x)).$$

This shows that y is in the image of Φ^* modulo the kernel of r , which is (w) . However, we have already shown that $w \in \text{im } \Phi^*$, so this establishes the claim.

In our case, it is easily computed that

$$r(z^t) = c^t \bar{c}^t$$

where $\bar{c} = 1 - \theta^{-1} = -\theta^{-1}(1 - \theta)$. This is in the image of c^n if and only if $2t \geq n$. It is then not hard to see that

$$\mathfrak{J}(A_n) = (z^{\lceil n/2 \rceil}, w),$$

as desired.

Finally, it is straightforward to check that Φ^* is injective. This follows from the fact that the fourth column of (7.6) injects into the third column of (7.6). Hence in fact

$$\tilde{K}_G(A_n) = \mathfrak{J}(A_n).$$

The assertion regarding $K_G^1(A_n)$ may be established by continuing the diagram (7.5) to the left; we leave this to the reader. The final claim follows from the definition of κ . \square

In fact, after an appropriate grading shift, the calculation of κ in Lemma 7.7 holds in general:

Lemma 7.8. *Let R be any symmetric graded root with $\beta(R) = 0$. Then*

$$\kappa(\mathcal{H}(R)) = \begin{cases} 0 & \text{if } \beta(R) = \delta(R) \\ 2 & \text{if } \beta(R) < \delta(R). \end{cases}$$

Proof. By Theorem 7.3, we may assume that R is monotone. If $\beta(R) = \delta(R)$, then R is isomorphic to $\mathbb{Z}[U]$ and the claim is trivial. Thus we assume $\beta(R) < \delta(R)$.

First suppose that the uppermost J -invariant vertex of R is not a leaf. Then it is not hard to construct roots X_m and X_n with m and n both non-zero such that there exist local maps from X_m to R and R to X_n . This procedure is depicted in Figure 7 and follows from a similar construction as in [DM19, Section 6]. Lift these local maps to maps of spectra. Then we have

$$\kappa(A_m) \leq \kappa(\mathcal{H}(R)) \leq \kappa(A_n)$$

and the claim follows from Lemma 7.7.

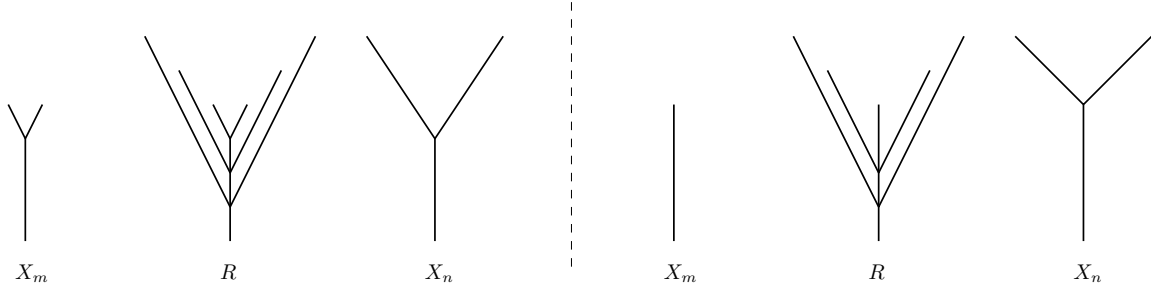

FIGURE 7. Left: sandwiching a monotone root between X_m and X_n . Right: the case when the highest-weight central vertex of R is a leaf.

In the event that the uppermost J -invariant vertex is a leaf, the local map from R to X_n again gives the inequality $\kappa(\mathcal{H}(R)) \leq 2$. In this case, however, the root X_m which maps into R is degenerate. Thus, on the other side we only obtain the inequality $0 \leq \kappa(\mathcal{H}(R))$. To complete the argument, we instead observe that we have a commutative diagram:

$$\begin{array}{ccc} K_G(\mathcal{H}(R)) & \longrightarrow & K_{S^1}(\mathcal{H}(R)) \\ \downarrow & & \downarrow \\ K_G(\mathcal{H}(R)^{S^1}) & \longrightarrow & K_{S^1}(\mathcal{H}(R)^{S^1}) \end{array}$$

The image of $K_{S^1}(\mathcal{H}(R)) \rightarrow K_{S^1}(\mathcal{H}(R)^{S^1}) = R(S^1) = \mathbb{Z}[\theta, \theta^{-1}]$ is $((1 - \theta)^{\delta(R)})$, by Bott periodicity. In particular, if $\delta(R) > \beta(R) = 0$, then $1 \in K_G(\mathcal{H}(R)^{S^1})$ cannot be in the image of $K_G(\mathcal{H}(R)) \rightarrow K_G(\mathcal{H}(R)^{S^1})$, which gives $\kappa(\mathcal{H}(R)) \geq 2$. \square

This gives:

Proof of Corollary 1.3. Let R be the symmetric graded root corresponding to (Y, \mathfrak{s}) , so that $\kappa(Y, \mathfrak{s}) = \kappa(\mathcal{H}(R))$. By Theorem 7.3, we may replace R by its monotone subroot. Suspend $\mathcal{H}(R)$ by $-\beta(Y, \mathfrak{s})\mathbb{C}$ so that the resulting monotone root has $\beta = 0$. The claim then follows from applying Lemma 7.8, undoing the suspension, and applying (7.4). \square

7.3. Connected sums. We now analyze the κ -invariant for connected sums of projective AR homology spheres. Let $\{(Y_i, \mathfrak{s}_i)\}_{i=1}^n$ be such a family. As discussed in the previous section,

$$SWF(Y_i, \mathfrak{s}_i) \sim \Sigma^{-\bar{\mu}(Y_i, \mathfrak{s}_i)\mathbb{C}} A_{n_i} \quad \text{with} \quad n_i = \delta(Y_i, \mathfrak{s}_i) - \beta(Y_i, \mathfrak{s}_i)$$

for each i . By the connected sum formula, we thus have

$$SWF(\#_{i=1}^n Y_i, \#_{i=1}^n \mathfrak{s}_i) \sim \Sigma^{-(\sum_i \bar{\mu}(Y_i, \mathfrak{s}_i))\mathbb{C}} \bigwedge_{i=1}^n A_{n_i}. \quad (7.7)$$

Hence we must analyze smash products of the A_{n_i} .

We begin by proposing a simple model for the smash product based on the discussion of Section 5.1. Each A_{n_i} may be thought of as the lattice space arising from a cubical complex homeomorphic to $[-1, 1]$. This complex consists of the three 0-cells $\{-1, 0, 1\}$, together with the two line segments between them. We define the weight function on each of these cells by setting $w(-1) = w(1) = 2n_i$ and giving the other three cells weight zero. Applying the procedure of Sections 5.1 and 6.2 to this cubical complex clearly gives the $\text{Pin}(2)$ -homotopy type A_{n_i} . Note that in the degenerate case A_0 , all five cells have weight zero.

As in [DS19, Section 3], now consider the product cubical complex $[-1, 1]^n$, where the weight of each cube $\square_d \in [-1, 1]^n$ is given by the sum of the weights of its factors. It is not hard to see that $\bigwedge_{i=1}^n A_{n_i}$ may be constructed from $[-1, 1]^n$ in the same manner as the discussion in Section 5.1, by introducing a sphere for each $\square_d \in [-1, 1]^n$ and gluing the spaces $S^{(w(\square_d)/2)\mathbb{C}} \wedge_{\square_d^+}$ together. We denote this homotopy type by

$$A = \bigwedge_{i=1}^n A_{n_i}.$$

However, there is a slight subtlety: the gluing maps between the $S^{(w(\square_d)/2)\mathbb{C}} \wedge_{\square_d^+}$ are not quite the standard ones discussed in Section 5.1. Indeed, the gluing maps of Section 5.1 come from the inclusion maps $\mathbb{C}^m \hookrightarrow \mathbb{C}^n$ along the first m coordinates, while (due to taking the smash product), the maps in A come from coordinate inclusions which vary depending on the cube $\square_d \in [-1, 1]^n$. While A has a $\text{Pin}(2)$ -action coming from the smash product, this makes explicitly identifying the action of j in coordinates slightly difficult. We discuss this further in Lemma 7.10.

It will also be helpful to consider the subset of A given by restricting the construction of Section 5.1 to the cubical subcomplex which constitutes the boundary of $[-1, 1]^n$. This also is a $\text{Pin}(2)$ -space, which we denote by M . Note that M has no (non-basepoint) $\text{Pin}(2)$ -fixed points. Let p denote the map

$$p: A \rightarrow A/M.$$

It is easily checked that

$$A/M = (\tilde{\mathbb{R}}^n)_+$$

as a $\text{Pin}(2)$ -spectrum.

We begin by bounding the κ -invariant of A :

Lemma 7.9. *Then $\mathfrak{J}(A)$ contains $w^{\lfloor n/2 \rfloor}$. In particular,*

$$\kappa(A) \leq n.$$

Proof. We first assume n is even. Let A and M be as above. Since n is even, we have $A/M = S^{n\tilde{\mathbb{R}}} = S^{(n/2)\tilde{\mathbb{C}}}$. Consider the maps in K -theory induced by the quotient map from A to A/M :

$$\begin{array}{ccc}
\tilde{K}_G(A) & \longleftarrow & \tilde{K}_G(S^{(n/2)}\tilde{\mathcal{C}}) \\
\downarrow \Phi^* & & \downarrow = \\
R(G) & \longleftarrow p^* & R(G)
\end{array} \tag{7.8}$$

Here, the bottom row is obtained by taking S^1 -fixed points; we are working in spaces as opposed to spectra. The map p^* is induced by the inclusion of $\text{Pin}(2)$ -fixed points. This is multiplication by the equivariant Euler class of $(n/2)\tilde{\mathcal{C}}$, which is $w^{n/2}$. The fact that the right-hand vertical arrow is an isomorphism then shows that $w^{n/2}$ is in the image of Φ^* . The final claim follows from the definition of κ .

Now, if n is odd, we can apply the n even case to $A \simeq A \wedge A_0$ to obtain the statement. \square

In order to obtain a sharper estimate for $\kappa(A)$, we will need to explicitly identify the j -action on A . For this, suppose that all of the n_i are even. Then all of the spheres considered in the construction of A come from quaternionic vector spaces. If we thus instead construct A by using the standard inclusion maps as discussed in Section 5.1, then the result will naturally be a subset of the $\text{Pin}(2)$ -space

$$[-1, 1]_+^n \wedge S^{(\sum n_i/2)\mathbb{H}}.$$

We denote the resulting homotopy type with the inherited j -action by \tilde{A} . As before, we may consider the subset of \tilde{A} coming from restricting the procedure of Section 5.1 to the boundary of $[-1, 1]^n$; we denote this by \tilde{M} . The following lemma asserts that in fact A and \tilde{A} coincide:

Lemma 7.10. *Let each n_i be even. Then there is a $\text{Pin}(2)$ -equivalence*

$$\bigwedge_{i=1}^n A_{n_i} = A \simeq \tilde{A}. \tag{7.9}$$

Proof. We prove (7.9) by induction on n . This amounts to showing that the U maps in the definition of the lattice spectrum always add factors *to the right*. Observe that at each stage, $\wedge_{i=1}^k A_{n_i}$ is the mapping cone of the $\text{Pin}(2)$ -map:

$$(U^{n_k} \vee U^{n_k}): S^0 \wedge \left(\bigwedge_{i=1}^{k-1} A_{n_i} \right) \rightarrow (S^{(n_k/2)\mathbb{H}} \vee S^{(n_k/2)\mathbb{H}}) \wedge \left(\bigwedge_{i=1}^{k-1} A_{n_i} \right)$$

where j interchanges the sphere factors on the right. Using (ho-3), this map is homotopically the same as an S^1 -map:

$$U^{n_k}: S^0 \wedge \left(\bigwedge_{i=1}^{k-1} A_{n_i} \right) \rightarrow S^{n_k\mathbb{C}} \wedge \left(\bigwedge_{i=1}^{k-1} A_{n_i} \right). \tag{7.10}$$

We have described $\wedge_{i=1}^{k-1} A_{n_i}$ as in Section 5.1; as a homotopy colimit over \mathcal{C} ; so that the left and right factors of (7.10) are hocolim F_0 and hocolim F_1 respectively, for functors $F_0, F_1: \mathcal{C} \rightarrow \mathfrak{C}$. The morphism in (7.10) is the homotopy colimit of a map of diagrams $\eta: F_0 \rightarrow F_1$ over \mathcal{C} ; where on each element $v \in \text{Ob}(\mathcal{C})$, $\eta(v)$ is the map $U^{n_k}: F(0) \rightarrow F(1)$ of representation spheres.

What needs to be shown is that these attaching maps η can be homotoped so that the ‘ U ’ is pointing to factors from F_1 , as opposed to the $S^{n_k\mathbb{C}}$ factor. This can be arranged by a linear transformation in the F_1 functor (i.e. applied to each object); since $GL(\mathbb{C})$ is connected, it follows that this transformation is homotopic to the identity, and so we obtain that the attaching map

(7.10) may be homotoped so that the image of the 1-dimension edges (etc.) of η in vertices of F_1 is exactly the image of 1-dimensional edges of F_1 . \square

In the case that all the n_i are even, we will thus use A and \tilde{A} interchangeably. The explicit characterization of the j -action in Lemma 7.10 will allow us to calculate the K -theoretic ideal of A in the following simplified case:

Lemma 7.11. *Let n be even. Assume that each n_i is even and that $n_i \geq 2$ for all i . Then $\mathfrak{J}(A) = (z^{\sum n_i/2}, w^{n/2})$. In particular,*

$$\kappa(A) = n.$$

Proof. Consider the K -theoretic exact sequences induced by the inclusion of M into A . This gives:

$$\begin{array}{ccccc} \tilde{K}_G(M) & \xleftarrow{\iota^*} & \tilde{K}_G(A) & \xleftarrow{\quad} & \tilde{K}_G(S^{(n/2)\tilde{C}}) \\ \downarrow & & \downarrow \Phi^* & & \downarrow = \\ \tilde{K}_G(M^{S^1}) & \xleftarrow{\quad} & R(G) & \xleftarrow{p^*} & R(G) \end{array} \quad (7.11)$$

where, as usual, the lower row is obtained by taking S^1 -fixed points. Moreover, the maps ι^* and $(\iota^{S^1})^*$ are surjective, since $\tilde{K}_G(S^{(n/2)\tilde{C}}) = 0$. Observe that M^{S^1} consists of a disjoint basepoint, together with the sphere $\tilde{S}^{n-1} = \partial[-1, 1]^n$ equipped with the antipodal j -action. It is not hard to check directly that

$$\tilde{K}_G(M^{S^1}) = R(G)/(w^{n/2}).$$

Note that as in Lemma 7.9, p^* is given by multiplication by $w^{n/2}$.

Since each $n_i \geq 2$, it is not hard to see that there is a copy of $\Sigma^{\mathbb{H}}\tilde{S}_+^{n-1}$ in M , giving rise to a commutative diagram:

$$\begin{array}{ccc} \tilde{K}_G(\Sigma^{\mathbb{H}}\tilde{S}_+^{n-1}) & \xleftarrow{\quad} & \tilde{K}_G(M) \\ \downarrow & & \downarrow \\ \tilde{K}_G(\tilde{S}_+^{n-1}) & \xleftarrow{=} & \tilde{K}_G(M^{S^1}) \end{array}$$

This required the description of Lemma 7.10. The left-hand vertical map is multiplication by z in $R(G)/(w^{n/2})$. Hence in particular, the image of the right-hand vertical map must lie in the ideal (z) of $R(G)/(w^{n/2})$. Returning to (7.11), we thus see that the image of Φ^* must lie in (z) modulo $(w^{n/2})$; that is,

$$\mathfrak{J}(A) \subseteq (z, w^{n/2}).$$

Now consider the commutative diagram

$$\begin{array}{ccc} \tilde{K}_G(A) & \longrightarrow & \tilde{K}_{S^1}(A) \\ \downarrow \Phi^* & & \downarrow \\ \tilde{K}_G(A^{S^1}) = R(G) & \xrightarrow{r} & \tilde{K}_{S^1}(A^{S^1}) = R(S^1) \end{array}$$

where the rows are induced by the inclusion of S^1 into G and the columns are given by taking S^1 -fixed points. The map r is as in the proof of Lemma 7.7; this sends

$$1 \rightarrow 1, \quad z \rightarrow 2 - \theta - \theta^{-1} = -\theta^{-1}c^2 \quad \text{and} \quad w \rightarrow 0,$$

where $c = 1 - \theta$. Now, as an S^1 -space, A is locally equivalent to $S^{(\Sigma^{n_i})\mathbb{C}}$. Hence the right-hand vertical map is given by multiplication by $c^{(\Sigma^{n_i})}$. It follows that if $p(z) + aw$ is in the image of Φ^* , we must have $p(c^2) \in (c^{(\Sigma^{n_i})})$. In particular,

$$\mathfrak{J}(A) \subset (z^{(\Sigma^{n_i/2})}, w).$$

Combining this with our previous calculation, we have

$$\mathfrak{J}(A) \subset (z^{(\Sigma^{n_i/2})}, w^{n/2}). \quad (7.12)$$

By Lemma 7.9, we already know that $w^{n/2} \in \mathfrak{J}(A)$. Hence to establish equality in (7.12), it suffices to show that $z^{(\Sigma^{n_i/2})} \in \mathfrak{J}(A)$. For this, observe that we may view

$$M \subset \Sigma^{(\Sigma^{n_i/2})\mathbb{H}} \tilde{S}_+^{n-1}$$

as in the discussion preceding Lemma 7.10. This gives a diagram:

$$\begin{array}{ccc} K_G(\Sigma^{(\Sigma^{n_i/2})\mathbb{H}}(\tilde{S}_+^{n-1})) & \longrightarrow & K_G(M) \\ \downarrow & & \downarrow \\ K_G((\Sigma^{(\Sigma^{n_i/2})\mathbb{H}}(\tilde{S}_+^{n-1}))^{S^1}) & \longrightarrow & K_G(M^{S^1}) \end{array}$$

The left-hand vertical arrow is multiplication by $z^{(\Sigma^{n_i/2})}$ in $R(G)/(w^{n/2})$, and the bottom arrow is the identity, so we obtain $z^{(\Sigma^{n_i/2})} \in \mathfrak{J}(A)$. This completes the proof. \square

We now proceed with the proofs of Corollary 1.4 through 1.6.

Proof of Corollary 1.4. We have:

$$\kappa(\#_{i=1}^n(Y_i, \mathfrak{s}_i)) \leq - \sum_{i=1}^n \bar{\mu}(Y_i, \mathfrak{s}_i) + n$$

simply by applying Lemma 7.9 after taking into account the grading shift (7.7). \square

Proof of Corollary 1.5. By Lemma 7.9, we know that

$$\kappa(\wedge_{i=1}^n A_{n_i}) \leq n.$$

On the other hand, observe that if $m < n$, then we have a local map from X_m into X_n and hence from A_m into A_n . It follows from this that

$$n = \kappa(\wedge_{i=1}^n A_2) \leq \kappa(\wedge_{i=1}^n A_{n_i}),$$

where we have applied Lemma 7.11 in the case that each $n_i = 2$. The claim then follows from taking into account the grading shift (7.7). \square

Proof of Corollary 1.6. Fix any projective (Y, \mathfrak{s}) with $-\bar{\mu}(Y, \mathfrak{s}) \leq \delta(Y, \mathfrak{s}) - 2$. Then

$$\kappa(\#_{i=1}^n(Y, \mathfrak{s})) = -n\bar{\mu}(Y, \mathfrak{s}) + n \leq n\delta(Y, \mathfrak{s}) - n$$

by Corollary 1.5. In [Sto17, Theorem 1.3], it is shown that

$$\alpha(\#_{i=1}^n(Y, \mathfrak{s})) - n\delta(Y, \mathfrak{s}), \quad \beta(\#_{i=1}^n(Y, \mathfrak{s})) - n\delta(Y, \mathfrak{s}), \quad \text{and} \quad \gamma(\#_{i=1}^n(Y, \mathfrak{s})) - n\delta(Y, \mathfrak{s})$$

are bounded functions of n . This establishes the claim. The second statement follows by duality (for K -theory this takes the form $\kappa(Y) + \kappa(-Y) \geq 0$ for all Y). \square

8. CONNECTIONS TO SINGULARITY THEORY

8.1. The vector space model. We now show that $\mathcal{H}(\Gamma, [k])$ has a close connection to the work of Némethi [Ném05, Ném08]. For this, it will be helpful to first have a minor re-phrasing of the construction of $\mathcal{H}(\Gamma, [k])$:

Definition 8.1. Let (V_1, \dots, V_n) be a sequence of (finite-dimensional) complex vector spaces. Suppose that for each consecutive pair V_i and V_{i+1} , we are either given an inclusion $i: V_i \hookrightarrow V_{i+1}$ or an inclusion $i: V_{i+1} \hookrightarrow V_i$. Define $\mathcal{H}(V_1, \dots, V_n)$ by contracting over the mapping cone of these inclusions:

$$\mathcal{H}(V_1, \dots, V_n) = \left(\bigsqcup_i V_i \right) / \sim,$$

where \sim is constructed as follows. For each consecutive pair V_i and V_{i+1} , we either have $i: V_i \hookrightarrow V_{i+1}$ or $i: V_{i+1} \hookrightarrow V_i$. In each case, glue the entire domain to the codomain via i , so that

$$\begin{cases} V_i \sim i(V_i) \subset V_{i+1} & \text{if } V_i \hookrightarrow V_{i+1} \\ V_{i+1} \sim i(V_{i+1}) \subset V_i & \text{if } V_{i+1} \hookrightarrow V_i. \end{cases}$$

This is an (unpointed) S^1 -space. Note that up to S^1 -homotopy equivalence, $\mathcal{H}(V_1, \dots, V_n)$ does not depend on the choice of inclusion map from each V_i to V_{i+1} (or vice-versa), as any two inclusions are isotopic.

It is clear that the space X of Section 5.1 is S^1 -homotopy equivalent to the one-point compactification of $\mathcal{H}(V_1, \dots, V_n)$, where $V_i = \mathbb{C}^{(w(k_i)-h)/2}$ and we consider the standard inclusion maps

$$\mathbb{C}^{(w(k_i)-h)/2} \hookrightarrow \mathbb{C}^{(w(k_{i+1})-h)/2} \quad \text{or} \quad \mathbb{C}^{(w(k_{i+1})-h)/2} \hookrightarrow \mathbb{C}^{(w(k_i)-h)/2}$$

according to whether $w(k_i) \leq w(k_{i+1})$ or $w(k_i) \geq w(k_{i+1})$. For example, $SWF(\Sigma(2, 3, 7))$ may be constructed by taking two copies of \mathbb{C}^1 , gluing a common copy of \mathbb{C}^0 to the origin in both, and then taking the one-point compactification. This construction may be viewed completely combinatorially, in the sense that the vector spaces V_i and the inclusion maps between them need not be assigned any particular meaning. However, it is natural to ask:

Question 8.2. *In the above construction, can the vector spaces and inclusions be interpreted in terms of the topology or geometry of W_Γ ?*

The impetus for Question 8.2 is the following. If W_Γ arises as the resolution of a singularity, then it inherits a preferred complex structure. As discussed in [Ném08, Section 2.2.5, Section 3.2.1], $w(k_i)$ is (up to certain convention changes) the holomorphic Euler characteristic of a certain sheaf \mathcal{O}_{x_i} on W_Γ associated to the characteristic element k_i . Hence there is already a natural candidate for V_i (at least in the stable category): the formal difference $H^0(W_\Gamma, \mathcal{O}_{x_i}) - H^1(W_\Gamma, \mathcal{O}_{x_i})$.⁹ In order to make sense of this, we consider a slight modification of Definition 8.1.

Definition 8.3. If A and B are (finite-dimensional) complex vector spaces, we call $A - B$ their *formal difference* and define $\dim(A - B) = \dim(A) - \dim(B)$. A *formal difference map*

$$f: (A - B) \rightarrow (A' - B')$$

⁹Due to these convention changes, in our case $w(k_i)$ is not quite the Euler characteristic of this sheaf, but the difference is not significant. See the proof of Theorem 8.7.

consists of a pair of linear maps (f_1, f_2) with $f_1: A \rightarrow A'$ and $f_2: B' \rightarrow B$. (Note the domain and codomain of f_2 .) This gives a map $f_1 \oplus f_2: A \oplus B' \rightarrow A' \oplus B$. We say that f is an inclusion if f_1 and f_2 are both inclusions, and so on.

Definition 8.4. Let (V_1, \dots, V_n) be a sequence of formal differences

$$V_i = A_i - B_i.$$

Suppose that for each consecutive pair V_i and V_{i+1} , we are either given an inclusion $i: V_i \hookrightarrow V_{i+1}$ or an inclusion $i: V_{i+1} \hookrightarrow V_i$, in the sense of Definition 8.3. By stabilizing, we can construct the mapping cone over these inclusions. Explicitly, consider the sequence of vector spaces

$$V'_i = A_i \oplus \left(\bigoplus_{j \neq i} B_j \right).$$

An inclusion map $i = (i_1, i_2)$ from V_i to V_{i+1} naturally induces an inclusion map from V'_i to V'_{i+1} which sends A_i to A_{i+1} via i_1 , B_{i+1} to B_i via i_2 , and B_j isomorphically to B_j via the identity map for $j \neq i$ or $i+1$. Similarly, an inclusion from V_{i+1} to V_i naturally induces an inclusion from V'_{i+1} to V'_i . Define the contracted mapping cone to be the formal desuspension of the construction from Definition 8.1:

$$\mathcal{H}(V_1, \dots, V_n) = \Sigma^{-\left(\bigoplus_{i=1}^n B_i\right)} \mathcal{H}(V'_1, \dots, V'_n).$$

This is an (unpointed) S^1 -space.

Note that if (V_1, \dots, V_n) is *any* sequence of formal differences with $\dim V_i = w(k_i) - h$, then the mapping cone $\mathcal{H}(V_1, \dots, V_n)$ is equivalent (up to suspension) to the obvious mapping cone defined by setting $V_i = \mathbb{C}^{(w(k_i) - h)}$. This follows from the fact that the construction of \mathcal{H} in Definition 8.1 does not actually depend on the precise inclusion maps. Our goal will thus be to find such a sequence of such formal differences (and inclusion maps between them) which arises naturally from the topology or geometry of W_Γ .

8.2. The work of Némethi. Our answer to Question 8.2 will follow immediately from the collected work of Némethi [Ném05, Ném08] regarding path lattice cohomology and the geometric genus. We thus review these results here. Our discussion is taken from [Ném08, Section 6.2].

Let $(X, 0)$ be a normal surface singularity and \tilde{X} be a good resolution of the origin (see for example [Ném99, Section 1] for definitions of these terms). We assume that the link of X is a rational homology sphere. Note that \tilde{X} is homeomorphic to some plumbed manifold W_Γ but is endowed with a particular complex structure. Embedded in the resolution \tilde{X} , we have a number of exceptional spheres which are in bijection with the vertices of Γ ; we denote these spheres also by v_i . For any divisor $x = \sum_i m_i v_i$ on \tilde{X} , let

$$\mathcal{O}_x = \mathcal{O}_{\tilde{X}} / \mathcal{O}_{\tilde{X}}(-x).$$

Here, $\mathcal{O}_{\tilde{X}}$ is the sheaf of holomorphic functions on \tilde{X} and $\mathcal{O}_{\tilde{X}}(-x)$ is the sheaf of holomorphic functions vanishing to order m_i along each v_i . By the Riemann-Roch theorem, we have

$$\chi(\tilde{X}, \mathcal{O}_x) = h^0(\tilde{X}, \mathcal{O}_x) - h^1(\tilde{X}, \mathcal{O}_x) = -\frac{1}{2}(x^2 + K(x)), \quad (8.1)$$

where K is the canonical characteristic element; see for example [Ném99, Appendix 2].

A fundamental analytic invariant of \tilde{X} is the *geometric genus*

$$p_g = \dim H^1(\tilde{X}, \mathcal{O}_{\tilde{X}}).$$

Although p_g is not a topological invariant of W_Γ , significant work due to Némethi has gone into bounding p_g in terms of topological invariants such as lattice homology [Ném05, Ném08]. The

most relevant idea here is the following. Let us equip the set of divisors with a natural partial order, where $x' = \sum_i m'_i v_i$ is greater than or equal to $x = \sum_i m_i v_i$ if $m'_i \geq m_i$ for each i . If $x' \geq x$, then we obtain a map of sheaves $\mathcal{O}_{x'} \rightarrow \mathcal{O}_x$. By the formal neighborhood theorem (see [Ném99, Appendix 2]),

$$p_g = \dim \left(\varprojlim_{x > 0} H^1(\tilde{X}, \mathcal{O}_x) \right).$$

That is, p_g can be computed by understanding $H^1(\tilde{X}, \mathcal{O}_x)$ for x sufficiently large.

This idea manifests itself in the following manner. Let $(x_i)_{i=0}^\infty$ be a sequence of divisors with $x_0 = 0$ and

$$x_{i+1} = x_i + v_{j(i)}$$

for some exceptional sphere $v_{j(i)}$. For i sufficiently large, $h^1(\tilde{X}, \mathcal{O}_{x_i})$ stabilizes and gives the geometric genus. The strategy of [Ném08, Section 6.2] is to estimate $h^1(\tilde{X}, \mathcal{O}_{x_{i+1}})$ in terms of $h^1(\tilde{X}, \mathcal{O}_{x_i})$, and hence obtain a cumulative estimate for $h^1(\tilde{X}, \mathcal{O}_{\tilde{X}})$. This is done as follows. Consider the cohomology exact sequence

$$\begin{aligned} 0 \rightarrow H^0(v_{j(i)}, \mathcal{M}_i) \rightarrow H^0(\tilde{X}, \mathcal{O}_{x_{i+1}}) \rightarrow H^0(\tilde{X}, \mathcal{O}_{x_i}) \rightarrow \\ H^1(v_{j(i)}, \mathcal{M}_i) \rightarrow H^1(\tilde{X}, \mathcal{O}_{x_{i+1}}) \rightarrow H^1(\tilde{X}, \mathcal{O}_{x_i}) \rightarrow 0; \end{aligned}$$

see the proof of [Ném08, Proposition 6.2.2]. Here, \mathcal{M}_i denotes the restriction of $\mathcal{O}_{v_{j(i)}}(-x_i)$ to $v_{j(i)}$. Now, since $v_{j(i)}$ is a sphere, we have that \mathcal{M}_i is completely determined by its degree over $v_{j(i)}$. As is well-known, there are two possibilities. (See for example [Ném99, Appendix 2].) If $\deg(\mathcal{M}_i) > -2$, then $H^1(v_{j(i)}, \mathcal{M}_i) = 0$. In this case, we have a surjection on H^0 and an isomorphism on H^1 :

$$\begin{aligned} H^0(\tilde{X}, \mathcal{O}_{x_{i+1}}) \twoheadrightarrow H^0(\tilde{X}, \mathcal{O}_{x_i}) \quad \text{and} \\ H^1(\tilde{X}, \mathcal{O}_{x_{i+1}}) \xrightarrow{\cong} H^1(\tilde{X}, \mathcal{O}_{x_i}). \end{aligned} \tag{8.2}$$

On the other hand, if $\deg(\mathcal{M}_i) \leq -2$, then $H^0(v_{j(i)}, \mathcal{M}_i) = 0$. In this situation, we only have the bound

$$0 \leq h^1(\tilde{X}, \mathcal{O}_{x_{i+1}}) - h^1(\tilde{X}, \mathcal{O}_{x_i}) \leq h^1(v_{j(i)}, \mathcal{M}_i). \tag{8.3}$$

Now,

$$h^1(v_{j(i)}, \mathcal{M}_i) = -\chi(v_{j(i)}, \mathcal{M}_i) = -(\chi(\tilde{X}, \mathcal{O}_{x_{i+1}}) - \chi(\tilde{X}, \mathcal{O}_{x_i})).$$

Thus the right-hand side of (8.3) is combinatorial and may be calculated as the difference of Riemann-Roch functions. Write

$$\Delta_i = \chi(\tilde{X}, \mathcal{O}_{x_{i+1}}) - \chi(\tilde{X}, \mathcal{O}_{x_i}).$$

Note that if $h^1(\tilde{X}, \mathcal{O}_{x_{i+1}}) - h^1(\tilde{X}, \mathcal{O}_{x_i}) = -\Delta_i$, so that the right-hand side of (8.3) is sharp, we have an isomorphism on H^0 in addition to having a surjection on H^1 :

$$\begin{aligned} H^0(\tilde{X}, \mathcal{O}_{x_{i+1}}) \xrightarrow{\cong} H^0(\tilde{X}, \mathcal{O}_{x_i}) \quad \text{and} \\ H^1(\tilde{X}, \mathcal{O}_{x_{i+1}}) \twoheadrightarrow H^1(\tilde{X}, \mathcal{O}_{x_i}). \end{aligned} \tag{8.4}$$

Putting (8.2) and (8.3) together, it follows that for any path $(x_i)_{i=0}^\infty$ as in the previous paragraph, we have the bound

$$p_g \leq \sum_{i=0}^{t-1} \max\{0, -\Delta_i\};$$

see [Ném08, Example 6.2.3]. As a sanity check, note that an examination of (8.1) (together with the fact that the intersection form on W_Γ is negative-definite) shows that $\Delta_i > 0$ for i sufficiently large. Thus our upper bound does not accumulate nontrivial terms after some finite cutoff index.

This leads to the following important definition:

Definition 8.5. Let Γ be a plumbing graph of spheres. We say that Γ is *extremal* if there exists an analytic structure on W_Γ and a path of divisors $(x_i)_{i=0}^n$ such that:

- (1) We have $x_0 = 0$ and $x_{i+1} = x_i + v_{j(i)}$ for all i ; and,
- (2) The sequence of characteristic vectors

$$k_i = K + 2x_i^* \in [K]$$

carries the lattice homology of $(\Gamma, [K])$ in the sense of Theorem 4.9; and,

- (3) The above bound for p_g is sharp; that is, we have

$$p_g = \sum_{i=0}^{n-1} \max\{0, -\Delta_i\}.$$

In this case, we call the given analytic structure on W_Γ an *extremal analytic structure* and the path $(x_i)_{i=0}^n$ an *extremal path*. Clearly, if $(x_i)_{i=0}^n$ is an extremal path, then each instance of inequality (8.3) is sharp. Hence for each i , we either have (8.2) or (8.4).

Némethi and Sigurdsson [NS16, Theorem 1.1.1] establish several families of graphs which are extremal; for further discussion, see [Ném08, Section 6.2]. The most familiar example from [NS16, Theorem 1.1.1] in the topological setting is the case of a Brieskorn sphere Y , which may be realized as the link of a weighted homogenous singularity. Here, the resolution of this singularity gives an extremal analytic structure on the usual negative-definite plumbing for Y .

The above discussion immediately indicates:

Lemma 8.6. *Let Γ be an extremal (almost-rational) plumbing graph equipped an extremal analytic structure. Let $(x_i)_{i=0}^n$ be an extremal path of divisors. Consider the sequence of formal differences*

$$V_i = H^1(\tilde{X}, \mathcal{O}_{x_i})^* - H^0(\tilde{X}, \mathcal{O}_{x_i})^*,$$

where $H^i(\tilde{X}, \mathcal{O}_{x_i})^*$ is the dual of $H^i(\tilde{X}, \mathcal{O}_{x_i})$. Then for each i , the map of sheaves $\mathcal{O}_{x_{i+1}} \rightarrow \mathcal{O}_{x_i}$ either induces an inclusion $V_i \hookrightarrow V_{i+1}$ or an inclusion $V_{i+1} \hookrightarrow V_i$.

Proof. As discussed above, there are two possibilities when comparing $\mathcal{O}_{x_{i+1}}$ and \mathcal{O}_{x_i} . In the first case, we have (8.2). Dualizing these maps gives

$$\begin{aligned} H^0(\tilde{X}, \mathcal{O}_{x_i})^* &\hookrightarrow H^0(\tilde{X}, \mathcal{O}_{x_{i+1}})^* \quad \text{and} \\ H^1(\tilde{X}, \mathcal{O}_{x_i})^* &\cong H^1(\tilde{X}, \mathcal{O}_{x_{i+1}})^*. \end{aligned}$$

Inverting the latter map gives an inclusion from V_{i+1} to V_i in the sense of Definition 8.4. In the second case, we have (8.4). Dualizing gives

$$\begin{aligned} H^0(\tilde{X}, \mathcal{O}_{x_i})^* &\cong H^0(\tilde{X}, \mathcal{O}_{x_{i+1}})^* \quad \text{and} \\ H^1(\tilde{X}, \mathcal{O}_{x_i})^* &\hookrightarrow H^1(\tilde{X}, \mathcal{O}_{x_{i+1}})^*. \end{aligned}$$

Inverting the former map gives an inclusion from V_i to V_{i+1} . □

Hence if $(x_i)_{i=0}^n$ is an extremal path, then the V_i of Lemma 8.6 form a sequence of formal differences as in Definition 8.4. We claim that taking the contracted mapping cone over these formal differences gives, up to suspension, the lattice homotopy type $\mathcal{H}(\Gamma, [K])$:

Theorem 8.7. *Let Γ be an extremal (almost-rational) plumbing graph equipped an extremal analytic structure. Let $(x_i)_{i=0}^n$ be an extremal path of divisors. Consider the sequence of formal differences*

$$V_i = H^1(\tilde{X}, \mathcal{O}_{x_i})^* - H^0(\tilde{X}, \mathcal{O}_{x_i})^*$$

equipped with the inclusions induced by the sheaf maps $\mathcal{O}_{x_{i+1}} \rightarrow \mathcal{O}_{x_i}$. Up to suspension, the one-point compactification of the contracted mapping cone $\mathcal{H}(V_1, \dots, V_n)$ is S^1 -homotopy equivalent to the lattice homotopy type $\mathcal{H}(\Gamma, [K])$.

Proof. All that remains is to translate between various conventions. As in Definition 8.5, let

$$k_i = K + 2x_i^*.$$

The weight function $w(k_i)$, as given in Definition 4.2, is

$$w(k_i) = \frac{1}{4}(k_i^2 + |\Gamma|) = x_i^2 + K(x_i) + \frac{1}{4}(K^2 + |\Gamma|) = -2\chi(\tilde{X}, \mathcal{O}_{x_i}) + \frac{1}{4}(K^2 + |\Gamma|).$$

Hence $\dim V_i = -\chi(\tilde{X}, \mathcal{O}_{x_i})$ differs from $w(k_i)/2$ by a constant shift, establishing the claim. \square

Remark 8.8. As discussed in [Ném08, Section 6.2], it is possible to bound $\dim H^1(\tilde{X}, \mathcal{L})$ for more general \mathcal{L} by taking the discussion of this section and replacing \mathcal{O}_{x_i} with $\mathcal{O}_{x_i} \otimes \mathcal{L}$ throughout. The presence of an extremal path in this setting gives an interpretation of the lattice homotopy type in spin^c -structures other than $[K]$. We emphasize the case presented here due to a lack of examples establishing extremality for general \mathcal{L} .

If Γ is extremal, Theorem 8.7 provides an interpretation of the lattice homotopy type $\mathcal{H}(\Gamma, [K])$ in terms of the algebraic geometry associated to a particular analytic structure on W_Γ . We stress that although $\mathcal{H}(\Gamma, [K])$ depends only on the topological type of W_Γ , Theorem 8.7 depends on a choice of extremal analytic structure. This is in fact unsurprising. Indeed, in [MOY96] it is shown that if Y is a Seifert fibered space, the critical points of the Chern-Simons-Dirac functional (and flows between them) may be interpreted in terms of the algebraic geometry of a particular ruled surface. Hence one should expect that any algebro-geometric interpretation of the Floer-theoretic invariants of Y should be specific to especially meaningful choices of complex structure on W_Γ .

9. APPENDIX

9.1. Lattice cohomology. We now briefly discuss the change in conventions between the present paper and [OS03, Ném05, Ném08]. The most notable difference is the use of lattice cohomology in [OS03, Ném05, Ném08], as opposed to our use of lattice homology. Let $\mathbb{C}_d = \mathbb{C}_d(\Gamma, [k])$ be the free $\mathbb{Z}[U]$ -module from Definition 4.3 and denote

$$\mathcal{T}_0^+ = \mathbb{Z}[U, U^{-1}]/U\mathbb{Z}[U].$$

We then set

$$\mathbb{C}_d^\vee = \text{Hom}_{\mathbb{Z}[U]}(\mathbb{C}_d, \mathcal{T}_0^+).$$

As before, d is called the *dimensional grading*. Each \mathbb{C}_d^\vee also has a *Maslov grading*, which is given by its grading shift as a map from \mathbb{C}_d to \mathcal{T}_0^+ . Explicitly, an element $\phi \in \mathbb{C}_d^\vee$ is homogenous

of Maslov grading $\text{gr}(\phi)$ if for each homogenous chain $x \in \mathbb{C}_d$, the image $\phi(x)$ is a homogenous element of \mathcal{T}_0^+ with

$$\text{gr}(\phi) = \text{gr}(\phi(x)) - \text{gr}(x). \quad (9.1)$$

Here, $\text{gr}(x)$ is the Maslov grading of x (as in Definition 4.3) and $\text{gr}(\phi(x))$ is the Maslov grading on \mathcal{T}_0^+ fixed by the fact that $\text{gr}(1) = 0$ and $\deg U = -2$. The action of U on \mathbb{C}_d^\vee is given by

$$(U\phi)(x) = \phi(Ux).$$

Note that U has grading -2 .

The *lattice cohomology* is then the homology of the cochain complex

$$\mathbb{C}_0^\vee \xrightarrow{\partial^\vee} \mathbb{C}_1^\vee \xrightarrow{\partial^\vee} \mathbb{C}_2^\vee \xrightarrow{\partial^\vee} \dots;$$

see [Ném08, Definition 3.1.3]. Following [Ném08], we denote this by $\mathbb{H}^d(\Gamma, [k])$.¹⁰ As pointed out in [OS03, Section 2] it is easy to check that

$$\mathbb{H}^0(\Gamma, [k]) \cong \text{Hom}_{\mathbb{Z}[U]}(\mathbb{H}_0(\Gamma, [k]), \mathcal{T}_0^+). \quad (9.2)$$

This follows from the fact that $\mathbb{H}_0(\Gamma, [k])$ contains no \mathbb{Z} -torsion, which we formally record:

Lemma 9.1. *The zeroth lattice homology $\mathbb{H}_0(\Gamma, [k])$ contains no \mathbb{Z} -torsion.*

Proof. This is immediate from (for example) Theorem 4.9 and an analysis of the equivalence relation \sim of (4.1). \square

Following [OS03], consider the map

$$T^+ : HF^+(-Y_\Gamma, \mathfrak{s}) \rightarrow \mathbb{H}^0(\Gamma, [k])$$

which sends $\xi \in HF^+(-Y_\Gamma, \mathfrak{s})$ to the element $\phi \in \mathbb{H}^0(\Gamma, [k])$ defined by

$$k \mapsto \phi(k) = F_{W,k}^+(\xi) \in HF^+(-S^3) \cong \mathcal{T}_0^+.$$

Here, we are viewing W as a cobordism from $-Y_\Gamma$ to $-S^3$, so that we have the associated Floer cobordism map

$$F_{W,k}^+ : HF^+(-Y_\Gamma, \mathfrak{s}) \rightarrow HF^+(S^3).$$

It is easily checked that ϕ descends to a map out of $\mathbb{H}_0(\Gamma, [k])$ due to the adjunction relations; see [OS03, Section 1]. In [OS03, Ném05], it is shown that T^+ is an isomorphism of $\mathbb{Z}[U]$ -modules in the case that Γ is a one-bad-vertex or AR plumbing. Given the surgery exact sequence for Seiberg-Witten Floer homology established by the second and third authors [SS23], the same proof applies verbatim to show that T^+ is an isomorphism in the setting of Seiberg-Witten Floer homology:

$$T^+ : \tilde{H}_*^{S^1}(SWF(-Y_\Gamma, \mathfrak{s})) \rightarrow \mathbb{H}^0(\Gamma, [k]).$$

For readers unfamiliar with the proof, we give a brief sketch of this in Section 9.3. It is then not difficult to see that T^+ is an isomorphism if and only if \mathbb{T} is an isomorphism; this is because \mathbb{T} is essentially the dual of T^+ . However, there is a slight subtlety: the lattice cohomology is defined by dualizing over $\mathbb{Z}[U]$, while usually duality in Floer homology is phrased in terms of \mathbb{Z} . We explain this minor point below.

¹⁰In [OS03], the zeroth lattice cohomology is denoted by $\mathbb{H}^+(G)$ and the zeroth lattice homology is denoted by $\mathbb{K}^+(G)$.

9.2. Duality. Let i be an arbitrary Maslov grading. Denote the lattice homology in grading i by $\mathbb{H}_{0,i}(\Gamma, [k])$ and the lattice cohomology in grading $-i$ by $\mathbb{H}^{0,-i}(\Gamma, [k])$. We then have maps

$$\mathbb{H}_{0,i}(\Gamma, [k]) \xrightarrow{\mathbb{T}} c\tilde{H}_i^{S^1}(SWF(Y_\Gamma, \mathfrak{s})) \quad (9.3)$$

and

$$\mathbb{H}^{0,-i}(\Gamma, [k]) \xleftarrow{T^+} \tilde{H}_{-i}^{S^1}(SWF(-Y_\Gamma, \mathfrak{s})). \quad (9.4)$$

We begin by considering the right-hand side of (9.3). By definition, we have

$$c\tilde{H}_i^{S^1}(SWF(Y_\Gamma, \mathfrak{s})) = \tilde{H}_{S^1}^{-i}(SWF(-Y_\Gamma, \mathfrak{s})),$$

where the latter is Borel cohomology. Since the Borel homology of $SWF(-Y_\Gamma, \mathfrak{s})$ has no \mathbb{Z} -torsion (being isomorphic to lattice cohomology), we moreover have that

$$\tilde{H}_{S^1}^{-i}(SWF(-Y_\Gamma, \mathfrak{s})) \cong \text{Hom}_{\mathbb{Z}}(\tilde{H}_{-i}^{S^1}(SWF(-Y_\Gamma, \mathfrak{s})), \mathbb{Z}).$$

Hence it follows that there is a perfect \mathbb{Z} -valued pairing $(a, b) \mapsto a(b)$ between the right-hand side of (9.3) and the right-hand side of (9.4).

As discussed in the previous section, we have $\mathbb{H}^0(\Gamma, [k]) \cong \text{Hom}_{\mathbb{Z}[U]}(\mathbb{H}_0(\Gamma, [k]), \mathcal{T}_0^+)$. Hence there is similarly a \mathbb{Z} -valued pairing $\langle c, d \rangle \mapsto d(c)$ between the left-hand side of (9.3) and the left-hand side of (9.4), given by evaluating an element of $\mathbb{H}^{0,-i}(\Gamma, [k])$ on an element of $\mathbb{H}_{0,i}(\Gamma, [k])$. Due to the definition of the Maslov grading (9.1), this gives an element in \mathcal{T}_0^+ of Maslov grading zero; that is, an element of \mathbb{Z} . We claim that this pairing is perfect.

For brevity, denote

$$H_* = \mathbb{H}_0(\Gamma, [k]), \quad H_i = \mathbb{H}_{0,i}(\Gamma, [k]), \quad H^* = \mathbb{H}^0(\Gamma, [k]), \quad \text{and} \quad H^{-i} = \mathbb{H}^{0,-i}(\Gamma, [k]),$$

so $\langle \cdot, \cdot \rangle: H_i \times H^{-i} \rightarrow \mathbb{Z}$. Since H_i and H^{-i} are free, finitely-generated \mathbb{Z} -modules, to show that $\langle \cdot, \cdot \rangle$ is perfect, it suffices to prove that the evaluation map mediates an isomorphism

$$H^{-i} \cong \text{Hom}_{\mathbb{Z}}(H_i, \mathbb{Z}). \quad (9.5)$$

Note that this is not quite the same duality statement as (9.2), which says that H^{-i} is isomorphic to the part of $\text{Hom}_{\mathbb{Z}[U]}(H_*, \mathcal{T}_0^+)$ in Maslov grading $-i$. Indeed, the elements of $\text{Hom}_{\mathbb{Z}}(H_i, \mathbb{Z})$ are homomorphisms which are only defined on elements of H_i , while the elements of $\text{Hom}_{\mathbb{Z}[U]}(H_*, \mathcal{T}_0^+)$ are defined on all of H_* . However, there is an obvious map of \mathbb{Z} -modules

$$(\text{part of } \text{Hom}_{\mathbb{Z}[U]}(H_*, \mathcal{T}_0^+) \text{ in Maslov grading } -i) \rightarrow \text{Hom}_{\mathbb{Z}}(H_i, \mathbb{Z})$$

given by restriction to $H_i \subset H_*$. We claim that this is an isomorphism.

The isomorphism is most easily seen by choosing a generating set for H_* as a $\mathbb{Z}[U]$ -module, as shown in Figure 8. This consists of elements $\{x_1, \dots, x_n\}$ where each x_j has a particular U -torsion order t_j . Here, $t_1 = \infty$, while all the other t_j are finite. This gives a \mathbb{Z} -basis for H_i in the following sense: for each x_j with $\text{gr}(x_j) - 2t_j \leq i \leq \text{gr}(x_j)$, we obtain the basis element $U^{(\text{gr}(x_j)-i)/2}x_j$; otherwise x_j contributes nothing. Then any \mathbb{Z} -morphism $\phi \in \text{Hom}_{\mathbb{Z}}(H_i, \mathbb{Z})$ extends to a $\mathbb{Z}[U]$ -morphism $\Phi \in \text{Hom}_{\mathbb{Z}[U]}(H_*, \mathcal{T}_0^+)$ of Maslov grading $-i$ by setting

$$\Phi(x_j) = U^{-(\text{gr}(x_j)-i)/2}\phi(U^{(\text{gr}(x_j)-i)/2}x_j)$$

whenever $\text{gr}(x_j) - 2t_j \leq i \leq \text{gr}(x_j)$ and $\Phi(x_j) = 0$ otherwise. Note that the latter equality is forced by the condition that the Maslov grading of Φ be $-i$. Indeed, if $\text{gr}(x_j) < i$, then we have

$$\text{gr}(\Phi(x_j)) = \text{gr}(x_j) + (-i) < 0$$

which forces $\Phi(x_j) = 0$. On the other hand, suppose $\text{gr}(x_j) - 2t_j > i$. Then

$$\text{gr}(\Phi(x_j)) = \text{gr}(x_j) + (-i) > 2t_j.$$

Since $U^{t_j+1}\Phi(x_j) = \Phi(U^{t_j+1}x_j) = \Phi(0) = 0$, combining the above grading inequality with the structure of \mathcal{T}_0^+ shows that $\Phi(x_j) = 0$. It follows that the extension Φ is unique, which easily implies $\langle \cdot, \cdot \rangle$ is a perfect pairing.

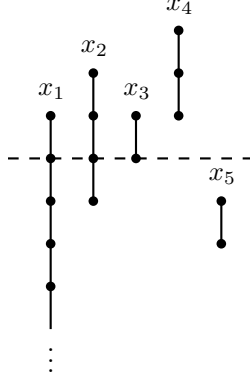

FIGURE 8. The $\mathbb{Z}[U]$ -module H_* with a set of generators $\{x_1, \dots, x_5\}$. The Maslov grading i is represented by the dotted line, so that there are three generators for H_i .

Now let $k \in \mathbb{H}_{0,i}(\Gamma, [k])$ and $\xi \in \tilde{H}_{-i}^{S^1}(SWF(-Y_\Gamma, \mathfrak{s}))$. We claim that

$$\langle k, T^+\xi \rangle = (\mathbb{T}k, \xi). \quad (9.6)$$

This is straightforward from unwinding the definitions. On the left, we have that

$$\langle k, T^+\xi \rangle = (T^+\xi)(k) = F_{W,k}^+(\xi)$$

by definition of T^+ . On the right, we have that $(\mathbb{T}k, \xi) = [F_{W,k}(1)](\xi)$, where

$$F_{W,k}: c\tilde{H}_i^{S^1}(SWF(S^3)) \rightarrow c\tilde{H}_i^{S^1}(SWF(Y_\Gamma, \mathfrak{s}))$$

and we interpret $F_{W,k}(1) \in c\tilde{H}_i^{S^1}(SWF(Y_\Gamma, \mathfrak{s}))$ as an element of $\tilde{H}_{S^1}^{-i}(SWF(-Y_\Gamma, \mathfrak{s}))$. Since this has no \mathbb{Z} -torsion, we have that $F_{W,k}$ is dual to the map

$$F_{W,k}^+: \tilde{H}_{-i}^{S^1}(SWF(-Y_\Gamma, \mathfrak{s})) \rightarrow \tilde{H}_{-i}^{S^1}(SWF(-S^3))$$

on Borel homology. Hence $[F_{W,k}(1)](\xi) = 1(F_{W,k}^+(\xi)) = F_{W,k}^+(\xi)$, as desired.

Given that (\cdot, \cdot) and $\langle \cdot, \cdot \rangle$ are perfect, it is a straightforward argument in basic algebra to show that (9.6) implies \mathbb{T} is an isomorphism if and only if T^+ is an isomorphism. This establishes the desired claim.

9.3. The isomorphism theorem. For readers unfamiliar with the proof of the lattice isomorphism theorem of [OS03, Ném08, Ném05], we give an abbreviated version of the argument in the setting of Seiberg-Witten Floer homology. The rough idea is to perform an induction on the size of Γ and the framings of its vertices. There are two important structural results which will allow us to carry out this induction.

The first is a naturality statement regarding the behavior of T^+ under blow-downs. Let Γ be a plumbing graph with a specified vertex v . Define the following:

- (1) Let Γ' be constructed from Γ by introducing an additional vertex x with framing -1 , which is attached only to v .
- (2) Let Γ_{+1} be constructed from Γ by increasing the framing of v by one.

Note that Γ_{+1} may be obtained from Γ' by blowing down the leaf x . Thus $Y_{\Gamma_{+1}}$ and $Y_{\Gamma'}$ are homeomorphic 3-manifolds. However, since Γ_{+1} and Γ' are not the same graph, it is not obvious that their corresponding lattice cohomologies are isomorphic. The following lemma asserts that $\mathbb{H}^0(\Gamma_{+1})$ and $\mathbb{H}^0(\Gamma')$ are indeed isomorphic, and that this isomorphism is natural with respect to T^+ :

Lemma 9.2. [OS03, Proposition 2.5] *We have the following commutative square:*

$$\begin{array}{ccc} \tilde{H}_*^{S^1}(SWF(-Y_{\Gamma'})) & \xrightarrow{\cong} & \tilde{H}_*^{S^1}(SWF(-Y_{\Gamma_{+1}})) \\ \downarrow T^+ & & \downarrow T^+ \\ \mathbb{H}^0(\Gamma') & \xrightarrow{\cong} & \mathbb{H}^0(\Gamma_{+1}). \end{array}$$

Proof. See [OS03, Proposition 2.5]. The map between lattice cohomologies along the bottom row is defined combinatorially and is the same as in the proof of [OS03, Proposition 2.5]. The proof of commutativity relies only on the blow-up formula, which holds for both Seiberg-Witten Floer homology and Heegaard Floer homology. \square

The second is a commuting pair of surgery sequences, one from lattice cohomology and one from Seiberg-Witten Floer homology. To this end, let Γ be a negative-definite plumbing graph with a specified vertex v . Define the following:

- (1) Let $\Gamma - v$ be the graph Γ with v deleted.
- (2) As before, let Γ' be constructed from Γ by introducing an additional vertex x with framing -1 , which is attached only to v .

Note that $Y_{\Gamma-v}$, Y_{Γ} , and $Y_{\Gamma'}$ form a surgery triple.

Lemma 9.3. [OS03, Lemmas 2.9 and 2.10] *There exist maps \mathbb{A} and \mathbb{B} such that the diagram*

$$\begin{array}{ccccccc} \cdots & \longrightarrow & \tilde{H}_*^{S^1}(SWF(-Y_{\Gamma'})) & \longrightarrow & \tilde{H}_*^{S^1}(SWF(-Y_{\Gamma})) & \longrightarrow & \tilde{H}_*^{S^1}(SWF(-Y_{\Gamma-v})) & \longrightarrow & \cdots \\ & & \downarrow T^+ & & \downarrow T^+ & & \downarrow T^+ & & \\ 0 & \longrightarrow & \mathbb{H}^0(\Gamma') & \xrightarrow{\mathbb{A}} & \mathbb{H}^0(\Gamma) & \xrightarrow{\mathbb{B}} & \mathbb{H}^0(\Gamma - v) & & \end{array}$$

*commutes up to sign and the top and bottom rows are exact.*¹¹

Proof. See [OS03, Lemmas 2.9 and 2.10]. The maps \mathbb{A} and \mathbb{B} are defined combinatorially and are the same as in the proof of [OS03, Lemmas 2.9 and 2.10], where it is shown that the bottom row is exact; see also [Gre13, Ném11]. The proof of commutativity relies only on the formal behavior of cobordism maps under composition. For a discussion of signs in the exact sequence, see the discussion at the end of [OS03, Section 2]. \square

We now sketch the inductive argument itself. The base case corresponds to a plumbing graph Γ with only a single vertex. In this situation, $-Y_{\Gamma}$ is an L-space; an easy computation shows that $\mathbb{H}^0(\Gamma)$ is likewise a copy of \mathcal{T}_0^+ in each spin^c -structure. Moreover, a calculation of the grading shift associated to W_{Γ} combined with the fact that W_{Γ} is negative-definite shows that T^+ is an isomorphism.

¹¹Note that the bottom row does *not* continue to the right.

The proof proceeds in several stages. First consider the category of zero-bad-vertex plumbings. We will need the fact that if Γ is any zero-bad-vertex plumbing, then Y_Γ is an L-space; see [OS03, Lemma 2.6]. In particular, $HF_{\text{odd}}^+(-Y_\Gamma) = 0$.¹² Invoking the isomorphism between Heegaard Floer, monopole Floer, and Seiberg-Witten Floer homology [KLT10, CGH12, LM18] shows that this holds for $\tilde{H}_*^{S^1}(SWF(-Y_\Gamma))$ also.

We now proceed by induction on the size of Γ . The base case of a single vertex has already been addressed; for the inductive step, let Γ be a zero-bad-vertex plumbing. Then:

- (1) If Γ has a leaf with framing -1 , blow down to obtain the zero-bad-vertex plumbing Γ_{+1} . Lemma 9.2 combined with the inductive hypothesis establishes that T^+ is an isomorphism for Γ .
- (2) Otherwise, select any leaf v of Γ . We proceed by a downwards sub-induction on the framing of v . The base case where the framing of v is -1 is covered above. Otherwise, $\Gamma - v$ and Γ_{+1} are also zero-bad-vertex plumbings. (These may be assumed to be negative-definite; see for example [ABDS20, Lemma 6.1].) Lemma 9.3 gives an exact sequence

$$\begin{array}{ccccccc}
0 & \longrightarrow & \tilde{H}_*^{S^1}(SWF(-Y_{\Gamma'})) & \longrightarrow & \tilde{H}_*^{S^1}(SWF(-Y_\Gamma)) & \longrightarrow & \tilde{H}_*^{S^1}(SWF(-Y_{\Gamma-v})) & \longrightarrow & 0 \\
& & \downarrow T^+ & & \downarrow T^+ & & \downarrow T^+ & & \\
0 & \longrightarrow & \mathbb{H}^0(\Gamma') & \xrightarrow{\mathbb{A}} & \mathbb{H}^0(\Gamma) & \xrightarrow{\mathbb{B}} & \mathbb{H}^0(\Gamma - v) & &
\end{array}$$

where in the top-left and top-right, we have used the fact that $\tilde{H}_*^{S^1}(SWF(-Y_{\Gamma-v}))$ and $\tilde{H}_*^{S^1}(SWF(-Y_{\Gamma'}) = \tilde{H}_*^{S^1}(SWF(-Y_{\Gamma_{+1}}))$ are zero in odd gradings. By inductive hypothesis, T^+ is an isomorphism for $\Gamma - v$. The inductive hypothesis implies that T^+ is an isomorphism for Γ_{+1} ; Lemma 9.2 then shows that T^+ is an isomorphism for Γ' . Applying the five-lemma to the above diagram shows that T^+ is an isomorphism for Γ .

This completes the proof in the case that Γ has no bad vertices.

Now suppose that Γ has a single bad vertex v . We proceed by upwards induction on the framing of v . If the framing of v is sufficiently negative, then Γ has no bad vertices and hence T^+ is an isomorphism by the previous paragraph. Otherwise, we have an exact sequence

$$\begin{array}{ccccccc}
0 & \longrightarrow & \tilde{H}_*^{S^1}(SWF(-Y_{\Gamma'})) & \longrightarrow & \tilde{H}_*^{S^1}(SWF(-Y_\Gamma)) & \longrightarrow & \tilde{H}_*^{S^1}(SWF(-Y_{\Gamma-v})) & \longrightarrow & \cdots \\
& & \downarrow T^+ & & \downarrow T^+ & & \downarrow T^+ & & \\
0 & \longrightarrow & \mathbb{H}^0(\Gamma') & \xrightarrow{\mathbb{A}} & \mathbb{H}^0(\Gamma) & \xrightarrow{\mathbb{B}} & \mathbb{H}^0(\Gamma - v) & &
\end{array}$$

Here, in the top-left corner, we have used the fact that $\Gamma - v$ has no bad vertices. (Note that, unlike the previous case, we do *not* know that the top-right corner is zero, since $-Y_{\Gamma'} \cong -Y_{\Gamma_{+1}}$ is not necessarily an L-space.) By the previous paragraph, we also know that T^+ is an isomorphism for $\Gamma - v$. The inductive hypothesis is that T^+ is an isomorphism for Γ ; by the five-lemma, T^+ is thus an isomorphism for Γ' . By Lemma 9.2, this shows that T^+ is an isomorphism for Γ_{+1} and completes the inductive step. This gives the proof for one-bad-vertex manifolds.

¹²Here, we mean that in each spin^c -structure, the Floer homology vanishes in gradings which are congruent to $(d+1) \bmod 2$.

The case when Γ is an AR plumbing is similar, as discussed in [Ném05, Section 8]. The essential point is to show that a plumbing is rational if and only if it is a lattice cohomology L-space; see [Ném05, Theorem 6.3]. Then a similar argument as in the first part of the above proof shows that T^+ is an isomorphism for all rational plumbings. Recall that an AR plumbing has a vertex v such that decreasing the framing of v makes Γ into a rational plumbing (see for example [Ném05, Section 6.2] for a definition). The same argument as for one-bad-vertex plumbings then applies to show that T^+ is an isomorphism for AR plumbings. See [Ném05, Theorem 8.3].

REFERENCES

- [AB21] Mohammed Abouzaid and Andrew J Blumberg, *Arnold conjecture and Morava K-theory*, arXiv preprint arXiv:2103.01507 (2021).
- [ABDS20] Antonio Alfieri, John Baldwin, Irving Dai, and Steve Sivek, *Instanton Floer homology of almost-rational plumbings*, 2020, preprint, arXiv:2010.03800.
- [Ada84] J. F. Adams, *Prerequisites (on equivariant stable homotopy) for Carlsson's lecture*, Algebraic topology, Aarhus 1982 (Aarhus, 1982), Lecture Notes in Math., vol. 1051, Springer, Berlin, 1984, pp. 483–532. MR 764596
- [AMS21] Mohammed Abouzaid, Mark McLean, and Ivan Smith, *Complex cobordism, Hamiltonian loops and global Kuranishi charts*, arXiv preprint arXiv:2110.14320 (2021).
- [BF04] Stefan Bauer and Mikio Furuta, *A stable cohomotopy refinement of Seiberg-Witten invariants. I*, Invent. Math. **155** (2004), no. 1, 1–19. MR 2025298
- [BK72] A. K. Bousfield and D. M. Kan, *Homotopy limits, completions and localizations*, Lecture Notes in Mathematics, Vol. 304, Springer-Verlag, Berlin-New York, 1972. MR 0365573
- [CGH12] Vincent Colin, Paolo Ghiggini, and Ko Honda, *The equivalence of Heegaard Floer homology and embedded contact homology via open book decompositions i*, 2012, preprint, arXiv:1208.1074.
- [CJS95] R. L. Cohen, J. D. S. Jones, and G. B. Segal, *Floer's infinite-dimensional Morse theory and homotopy theory*, The Floer memorial volume, Progr. Math., vol. 133, Birkhäuser, Basel, 1995, pp. 297–325.
- [Con78] Charles Conley, *Isolated invariant sets and the Morse index*, CBMS Regional Conference Series in Mathematics, vol. 38, American Mathematical Society, Providence, R.I., 1978.
- [Dai18] Irving Dai, *On the Pin(2)-equivariant monopole Floer homology of plumbed 3-manifolds*, Michigan Math. J. **67** (2018), no. 2, 423–447.
- [DM16] Emanuele Dotto and Kristian Moi, *Homotopy theory of G-diagrams and equivariant excision*, Algebr. Geom. Topol. **16** (2016), no. 1, 325–395. MR 3470703
- [DM19] Irving Dai and Ciprian Manolescu, *Involutive Heegaard Floer homology and plumbed three-manifolds*, J. Inst. Math. Jussieu **18** (2019), no. 6, 1115–1155. MR 4021102
- [DS19] Irving Dai and Matthew Stoffregen, *On homology cobordism and local equivalence between plumbed manifolds*, Geom. Topol. **23** (2019), no. 2, 865–924. MR 3939054
- [Flo87] Andreas Floer, *A refinement of the Conley index and an application to the stability of hyperbolic invariant sets*, Ergodic Theory Dynam. Systems **7** (1987), no. 1, 93–103. MR 886372
- [Flo89] ———, *Witten's complex and infinite-dimensional Morse theory*, J. Differential Geom. **30** (1989), no. 1, 207–221. MR 1001276
- [Frø96] Kim A. Frøyshov, *The Seiberg-Witten equations and four-manifolds with boundary*, Math. Res. Lett. **3** (1996), no. 3, 373–390. MR 1397685
- [Fur01] M. Furuta, *Monopole equation and the $\frac{11}{8}$ -conjecture*, Math. Res. Lett. **8** (2001), no. 3, 279–291. MR 1839478
- [Gre13] Joshua Evan Greene, *A surgery triangle for lattice cohomology*, Algebr. Geom. Topol. **13** (2013), no. 1, 441–451. MR 3031647
- [HM17] Kristen Hendricks and Ciprian Manolescu, *Involutive Heegaard Floer homology*, Duke Math. J. **166** (2017), no. 7, 1211–1299.
- [Kha15] Tirasan Khandhawit, *A new gauge slice for the relative bauer-furuta invariants*, Geom. Topol. **19** (2015), no. 3, 1631–1655.
- [KL22] Mikhail Khovanov and Robert Lipshitz, *Categorical lifting of the jones polynomial: a survey*, Bulletin of the American Mathematical Society (2022).
- [KLS18] Tirasan Khandhawit, Jianfeng Lin, and Hirofumi Sasahira, *Unfolded Seiberg-Witten Floer spectra, I: Definition and invariance*, Geom. Topol. **22** (2018), no. 4, 2027–2114.

- [KLS23] ———, *Unfolded Seiberg-Witten Floer spectra, II: relative invariants and the gluing theorem*, J. Differential Geom. **124** (2023), no. 2, 231–316. MR 4602726
- [KLT10] Cagatay Kutluhan, Yi-Jen Lee, and Clifford Henry Taubes, *HF=HM I : Heegaard Floer homology and Seiberg–Witten Floer homology*, 2010, preprint, arXiv:1007.1979.
- [KM02] Peter Kronheimer and Ciprian Manolescu, *Periodic Floer pro-spectra from the Seiberg-Witten equations*, 2002, preprint, arXiv:0203243.
- [KM07] Peter Kronheimer and Tomasz Mrowka, *Monopoles and three-manifolds*, New Mathematical Monographs, vol. 10, Cambridge University Press, Cambridge, 2007.
- [Lin17] Francesco Lin, *Pin(2)-monopole Floer homology, higher compositions and connected sums*, J. Topol. **10** (2017), no. 4, 921–969. MR 3705144
- [Lin18] ———, *A Morse-Bott approach to monopole Floer homology and the triangulation conjecture*, Mem. Amer. Math. Soc. **255** (2018), no. 1221, v+162. MR 3827053
- [LM18] Tye Lidman and Ciprian Manolescu, *The equivalence of two Seiberg-Witten Floer homologies*, Astérisque (2018), no. 399, vii+220. MR 3818611
- [LM21] Jianfeng Lin and Anubhav Mukherjee, *Family Bauer–Furuta invariant, exotic surfaces and Smale conjecture*, arXiv preprint arXiv:2110.09686 (2021).
- [LMSM86] L. G. Lewis, Jr., J. P. May, M. Steinberger, and J. E. McClure, *Equivariant stable homotopy theory*, Lecture Notes in Mathematics, vol. 1213, Springer-Verlag, Berlin, 1986, With contributions by J. E. McClure. MR 866482
- [LS14] Robert Lipshitz and Sucharit Sarkar, *A Khovanov stable homotopy type*, J. Amer. Math. Soc. **27** (2014), no. 4, 983–1042.
- [Man03] Ciprian Manolescu, *Seiberg-Witten-Floer stable homotopy type of three-manifolds with $b_1 = 0$* , Geom. Topol. **7** (2003), 889–932.
- [Man07] ———, *A gluing theorem for the relative bauer-furuta invariants*, J. Differential Geom. **76** (2007), 117–153.
- [Man14] ———, *On the intersection forms of spin four-manifolds with boundary*, Math. Ann **359** (2014), 695–728.
- [Man16a] ———, *Lectures on the triangulation conjecture*, Proceedings of the Gökova Geometry-Topology Conference 2015, Gökova Geometry/Topology Conference (GGT), Gökova, 2016, pp. 1–38. MR 3526837
- [Man16b] ———, *Pin(2)-equivariant Seiberg-Witten Floer homology and the triangulation conjecture*, J. Amer. Math. Soc. **29** (2016), no. 1, 147–176.
- [May96] J. P. May, *Equivariant homotopy and cohomology theory*, CBMS Regional Conference Series in Mathematics, vol. 91, Conference Board of the Mathematical Sciences, Washington, DC; by the American Mathematical Society, Providence, RI, 1996, With contributions by M. Cole, G. Comezana, S. Costenoble, A. D. Elmendorf, J. P. C. Greenlees, L. G. Lewis, Jr., R. J. Piacenza, G. Triantafyllou, and S. Waner. MR 1413302
- [MOY96] Tomasz Mrowka, Peter Ozsváth, and Baozhen Yu, *Seiberg-Witten monopoles on Seifert fibered spaces*, 1996, preprint, arXiv:9612221.
- [MS21] Ciprian Manolescu and Sucharit Sarkar, *A knot Floer stable homotopy type*, 2021, preprint, arXiv:2108.13566.
- [Ném99] András Némethi, *Five lectures on normal surface singularities*, Low dimensional topology (Eger, 1996/Budapest, 1998), Bolyai Soc. Math. Stud., vol. 8, János Bolyai Math. Soc., Budapest, 1999, With the assistance of Ágnes Szilárd and Sándor Kovács, pp. 269–351. MR 1747271
- [Ném05] ———, *On the Ozsváth-Szabó invariant of negative definite plumbed 3-manifolds*, Geom. Topol. **9** (2005), 991–1042. MR 2140997
- [Ném08] ———, *Lattice cohomology of normal surface singularities*, Publ. Res. Inst. Math. Sci. **44** (2008), no. 2, 507–543.
- [Ném11] ———, *Two exact sequences for lattice cohomology*, Noncommutative geometry and global analysis, Contemp. Math., vol. 546, Amer. Math. Soc., Providence, RI, 2011, pp. 249–269. MR 2815139
- [NS16] András Némethi and Baldur Sigurdsson, *The geometric genus of hypersurface singularities*, J. Eur. Math. Soc. (JEMS) **18** (2016), no. 4, 825–851. MR 3474458
- [OS03] Peter Ozsváth and Zoltán Szabó, *On the Floer homology of plumbed three-manifolds*, Geom. Topol. **7** (2003), 185–224.
- [OS06] ———, *Holomorphic triangles and invariants for smooth four-manifolds*, Adv. Math. **202** (2006), no. 2, 326–400.
- [Seg71] G. B. Segal, *Equivariant stable homotopy theory*, Actes du Congrès International des Mathématiciens (Nice, 1970), Tome 2, Gauthier-Villars, Paris, 1971, pp. 59–63. MR 0423340

- [SS21] Hirofumi Sasahira and Matthew Stoffregen, *Seiberg-Witten Floer spectra for $b_1 > 0$* , arXiv preprint arXiv:2103.16536 (2021).
- [SS23] ———, *Exact triangles in Seiberg-Witten Floer spectra*, 2023, preprint.
- [Sto17] Matthew Stoffregen, *Manolescu invariants of connected sums*, Proc. Lond. Math. Soc. (3) **115** (2017), no. 5, 1072–1117, preprint, arXiv:1510.01286.
- [Sto20] ———, *$Pin(2)$ -equivariant Seiberg-Witten Floer homology of Seifert fibrations*, Compos. Math. **156** (2020), no. 2, 199–250.
- [SZ18] Matthew Stoffregen and Melissa Zhang, *Localization in Khovahov homology*, 2018, preprint, arXiv:1810.04769.
- [tD75] Tammo tom Dieck, *Orbittypen und äquivariante Homologie. II*, Arch. Math. (Basel) **26** (1975), no. 6, 650–662. MR 436177
- [tD87] ———, *Transformation groups*, De Gruyter Studies in Mathematics, 8, Walter de Gruyter & Co., Berlin, 1987.
- [Ue22] Masaaki Ue, *Constraints on intersection forms of spin 4-manifolds bounded by Seifert rational homology 3-spheres in terms of $\bar{\mu}$ and κ invariants*, arXiv preprint arXiv:2206.05412 (2022).
- [Zem21] Ian Zemke, *The equivalence of lattice and Heegaard Floer homology*, 2021, preprint, arXiv:2111.14962.

DEPARTMENT OF MATHEMATICS, THE UNIVERSITY OF TEXAS AT AUSTIN

Email address: `irving.dai@math.utexas.edu`

FACULTY OF MATHEMATICS, KYUSHU UNIVERSITY, 744, MOTOOKA, NISHI-KU, FUKUOKA, 819-0395, JAPAN

Email address: `hsasahira@math.kyushu-u.ac.jp`

DEPARTMENT OF MATHEMATICS, MICHIGAN STATE UNIVERSITY

Email address: `stoffre1@msu.edu`