

# Normal 5-edge-coloring of some snarks superpositioned by Flower snarks

Jelena Sedlar<sup>1,3</sup>,  
Riste Škrekovski<sup>2,3</sup>

<sup>1</sup> *University of Split, FGAG, 21000 Split, Croatia*

<sup>2</sup> *University of Ljubljana, FMF, 1000 Ljubljana, Slovenia*

<sup>3</sup> *Faculty of Information Studies, 8000 Novo Mesto, Slovenia*

August 5, 2024

## Abstract

An edge  $e$  is normal in a proper edge-coloring of a cubic graph  $G$  if the number of distinct colors on four edges incident to  $e$  is 2 or 4. A normal edge-coloring of  $G$  is a proper edge-coloring in which every edge of  $G$  is normal. The Petersen Coloring Conjecture is equivalent to stating that every bridgeless cubic graph has a normal 5-edge-coloring. Since every 3-edge-coloring of a cubic graph is trivially normal, it is sufficient to consider only snarks to establish the conjecture. In this paper, we consider a class of superpositioned snarks obtained by choosing a cycle  $C$  in a snark  $G$  and superpositioning vertices of  $C$  by one of two simple supervertices and edges of  $C$  by superedges  $H_{x,y}$ , where  $H$  is any snark and  $x, y$  any pair of nonadjacent vertices of  $H$ . For such superpositioned snarks, two sufficient conditions are given for the existence of a normal 5-edge-coloring. The first condition yields a normal 5-edge-coloring for all hypohamiltonian snarks used as superedges, but only for some of the possible ways of connecting them. In particular, since the Flower snarks are hypohamiltonian, this consequently yields a normal 5-edge-coloring for many snarks superpositioned by the Flower snarks. The second sufficient condition is more demanding, but its application yields a normal 5-edge-colorings for all superpositions by the Flower snarks. The same class of snarks is considered in [S. Liu, R.-X. Hao, C.-Q. Zhang, *Berge-Fulkerson coloring for some families of superposition snarks*, *Eur. J. Comb.* 96 (2021) 103344] for the Berge-Fulkerson conjecture. Since we established that this class has a Petersen coloring, this immediately yields the result of the above mentioned paper.

*Keywords:* normal edge-coloring; cubic graph; snark; superposition; Petersen Coloring Conjecture.

*AMS Subject Classification numbers:* 05C15

# 1 Introduction

In this paper we consider simple cubic bridgeless graphs. Let  $G$  be a graph with the set of vertices  $V(G)$  and the set of edges  $E(G)$ . For a vertex  $v \in V(G)$  we denote by  $\partial_G(v)$  the set of edges in  $G$  which are incident to  $v$ . Let  $G$  and  $H$  be a pair of cubic graphs. A  $H$ -coloring of  $G$  is any mapping  $\phi : E(G) \rightarrow E(H)$  such that for every  $v \in V(G)$  there is  $w \in V(H)$  such that  $\phi(\partial_G(v)) = \partial_H(w)$ . If  $G$  admits an  $H$ -coloring, then we write  $H \prec G$ .

Let us denote by  $P_{10}$  the Petersen graph. If  $H = P_{10}$  and  $H \prec G$ , then we say that  $G$  has the Petersen coloring. The following conjecture was stated by Jaeger [9].

**Conjecture 1 (Petersen Coloring Conjecture)** *Let  $G$  be a bridgeless cubic graph. Then  $P_{10} \prec G$ .*

It is known that the Petersen Coloring Conjecture implies the classical Berge-Fulkerson Conjecture and the (5,2)-cycle-cover conjecture. Thus, it seems difficult to prove. It motivated several variants and different approaches to it [19, 21, 22], one such approach are normal colorings.

**Normal colorings.** A (*proper*)  $k$ -edge-coloring of a graph  $G$  is any mapping  $\sigma : E(G) \rightarrow \{1, \dots, k\}$  such that any pair of adjacent edges of  $G$  receives distinct colors by  $\sigma$ . Let  $\sigma$  be a  $k$ -edge-coloring of  $G$  and  $v \in V(G)$ . Then we denote  $\sigma(v) = \{\sigma(e) : e \in \partial_G(v)\}$ .

**Definition 2** *Let  $G$  be a bridgeless cubic graph,  $\sigma$  a proper edge-coloring of  $G$  and  $uv$  an edge of  $G$ . We say the edge  $uv$  is poor (resp. rich) if  $|\sigma(u) \cup \sigma(v)| = 3$  (resp.  $|\sigma(u) \cup \sigma(v)| = 5$ ).*

A proper edge-coloring of a cubic graph  $G$  is *normal*, if every edge of  $G$  is poor or rich. Normal edge-colorings were introduced by Jaeger in [10]. Notice that a normal coloring in which every edge is poor must be a 3-edge-coloring. On the other hand, a normal coloring in which every edge is rich is called a *strong edge-coloring*. The *normal chromatic index* of a cubic graph  $G$ , denoted by  $\chi'_N(G)$ , is the smallest number  $k$  such that  $G$  admits a normal  $k$ -edge-coloring. Notice that  $\chi'_N(G)$  is at least 3 and it never equals 4. The following result was established in [10].

**Proposition 3** *For a cubic graph  $G$ , it holds that  $P_{10} \prec G$  if and only if  $G$  admits a normal 5-edge-coloring.*

Proposition 3 implies that Conjecture 1 can be restated as follows.

**Conjecture 4** *Let  $G$  be a bridgeless cubic graph. Then  $\chi'_N(G) \leq 5$ .*

Since any proper 3-edge-coloring of a cubic graph  $G$  is a normal edge-coloring in which every edge is poor, Conjecture 4 obviously holds for every 3-edge colorable graph. The smallest known upper bound for  $\chi'_N(G)$  of a bridgeless cubic graph is 7 [2, 17], and for several graph classes the bound is lowered to 6 [18]. According to Vizing's theorem, every cubic graph is either 3-edge colorable or 4-edge colorable, so to prove Conjecture 4 it remains to establish that it holds for all bridgeless cubic graphs which are not 3-edge colorable.

**Superpositioning snarks.** Cubic graphs which are not 3-edge colorable are usually considered under the name of snarks [5, 20]. In order to avoid trivial cases, the definition of snark usually includes some additional requirements on the connectivity and the girth. Since in this paper such requirements are not essential, we will go with the broad definition of a *snark* being any bridgeless cubic graph which is not 3-edge colorable. The existence of a normal 5-edge-coloring for some families of snarks has already been established, see for example [4, 7].

A general method for obtaining snarks is the superposition [1, 3, 11, 12, 16]. We will focus our attention to a class of snarks obtained by some particular superpositions of edges and vertices of a cycle in a snark. So, let us first introduce the method of superposition.

**Definition 5** A multipole  $M = (V, E, S)$  is a triple which consists of a set of vertices  $V = V(M)$ , a set of edges  $E = E(M)$ , and a set of semiedges  $S = S(M)$ . A semiedge is incident either to one vertex or to another semiedge in which case a pair of incident semiedges forms a so called isolated edge within the multipole.

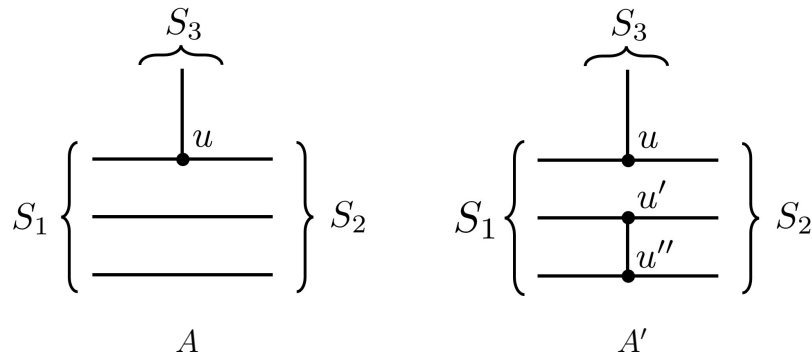

Figure 1: Multipoles  $A$  and  $A'$ . Notice that  $A$  has two isolated edges. Both  $A$  and  $A'$  are 7-poles, and if their set of semiedges is divided into three connectors  $S_1$ ,  $S_2$  and  $S_3$  as shown in the figure, then  $A$  and  $A'$  are supervertices.

For an illustration of a multipole see Figure 1. All multipoles we consider here are *cubic*, i.e. such that every vertex is incident to precisely three edges or semiedges. Notice that the notion of normal coloring can be naturally extended to multipoles. Namely, a (*proper*)  $k$ -edge-coloring of a multipole  $M = (V, E, S)$  is any mapping  $\sigma : E(M) \cup E(S) \rightarrow \{1, \dots, k\}$  such that colors of edges and semiedges which are incident to a same vertex are pairwise distinct. Further, for a cubic multipole  $M$  we define a *normal coloring* as a proper edge-coloring such that every edge is rich or poor. Notice that the definition of a normal coloring of a multipole does not have any requirements on the colors of semiedges. Finally, we need the notion of a Kempe chain in a cubic multipole. So, let  $\sigma$  be a normal coloring of a cubic multipole  $M = (V, E, S)$  and let  $P = s_1 e_2 \cdots e_{p-1} s_p$ , for  $p > 1$ ,  $e_i \in E$  and  $s_i \in S$ , be a path in  $M$  starting and ending with a semiedge. We say that  $P$  is a *Kempe*  $(i, j)$ -chain with respect to  $\sigma$ , if (semi)edges of  $P$  are alternatively colored by  $i$  and  $j$ .

Next, we wish to define special kinds of multipoles which will be of interest to us. We start with the definition of  $k$ -pole which is defined as any multipole  $M$  with  $|S(M)| = k$ . The set of semiedges of a  $k$ -pole  $M$  can be divided into several so called connectors, i.e. we define a  $(k_1, \dots, k_n)$ -pole to be  $M = (V, E, S_1, \dots, S_n)$  where  $S_1, \dots, S_n$  is a partition of the set  $S(M)$  into pairwise disjoint sets  $S_i$  such that  $|S_i| = k_i$  for  $i = 1, \dots, n$  and  $k_1 + \dots + k_n = k$ . Each set  $S_i$  is called a *connector* of  $M$ , or more precisely  $k_i$ -connector.

**Definition 6** A *supervertex* (resp. *superedge*) is a multipole with three (resp. two) connectors.

We define two particular supervertices  $A$  and  $A'$  as in Figure 1. Let  $G$  be a snark and  $u_1, u_2$  a pair of non-adjacent vertices of  $G$ . A superedge  $G_{u_1, u_2}$  is obtained from  $G$  by removing vertices  $u_1$  and  $u_2$ , and then replacing all edges incident to a vertex  $u_i$  in  $G$  by semiedges in  $G_{u_1, u_2}$  which form a connector  $S_i$ , for  $i = 1, 2$ .

**Definition 7** A *proper superedge* is either an isolated edge or a multipole  $G_{u_1, u_2}$  where  $G$  is a snark.

A proper superedge can be defined in a wider sense (see [11]), but for the purposes of the present paper this simple definition suffices. Now, let  $G = (V, E)$  be a cubic graph. Replace each edge  $e \in E$  by a superedge  $\mathcal{E}(e)$  and each vertex  $v \in V$  by a supervertex  $\mathcal{V}(v)$  so that the following holds: if  $v \in V$  is incident to  $e \in E$ , then semiedges of one connector of  $\mathcal{V}(v)$  are identified with semiedges of one connector from  $\mathcal{E}(e)$  and these two connectors must have the same cardinality. Notice that  $\mathcal{V}(v)$  (resp.  $\mathcal{E}(e)$ ) does not have to be the same for every vertex  $v$  (resp. edge  $e$ ), so  $\mathcal{V}$  (resp.  $\mathcal{E}$ ) is a mapping of the set of vertices  $V(G)$  to a set of supervertices (resp. superedges).

This procedure results in a cubic graph which is called a *superposition* of  $G$  with  $\mathcal{V}$  and  $\mathcal{E}$  and denoted by  $G(\mathcal{V}, \mathcal{E})$ . Moreover, if  $\mathcal{E}(e)$  is proper for every  $e \in E$ , then  $G(\mathcal{V}, \mathcal{E})$  is called a *proper superposition* of  $G$ . Since a multipole consisting of a single vertex and three semiedges is a supervertex, and an isolated edge is proper superedge, some of the vertices and edges of  $G$  may be superposed by themselves. The following theorem is established in [11]. There, it is stated for snarks of girth  $\geq 5$  which are cyclically 4-edge-connected, but it also holds for snarks of smaller girth and smaller edge-connectivity.

**Theorem 8** If  $G$  is a snark and  $G(\mathcal{V}, \mathcal{E})$  is a proper superposition of  $G$ , then  $G(\mathcal{V}, \mathcal{E})$  is a snark.

In this paper, we will establish that Conjecture 4 holds for snarks  $G(\mathcal{V}, \mathcal{E})$  obtained for particular supervertices  $\mathcal{V}$  and superedges  $\mathcal{E}$  superposed on vertices and edges of a cycle in  $G$ .

**Normal colorings of superpositioned snarks.** Normal colorings of a family of superpositioned snarks are considered in [23]. There, for any snark  $G$  and any even cycle  $C$  in  $G$ , a superposition  $G_C(\mathcal{A}, \mathcal{B})$  is considered. For every vertex  $u_i$  of  $C$ , a supervertex  $\mathcal{A}(u_i)$  is either  $A$  or  $A'$  from Figure 1. For every edge  $e_i$  of  $C$ , a superedge  $\mathcal{B}(e_i)$  is the supervertex  $(P_{10})_{u, v}$ . All other vertices and edges of  $G$  are superpositioned by themselves.

For many such superpositions the existence of a normal 5-edge-coloring is established, and the approach naturally extends to superposition of any even subgraph of  $G$  consisting of even length cycles. The approach of [23] could not be extended to odd cycles, since  $P_{10}$  is a small snark. Thus, in this paper we consider a similar superposition with Flower snarks taken as superedges instead of the Petersen graph. This class of superpositions by Flower snarks has already been considered in [12, 13, 14, 15], only in a different context.

Flower snarks are first introduced by Isaacs in [8], and in [7] it is established that Flower snarks have a normal 5-edge-coloring. Flower snarks are used as superedges in [12, 13] in order to obtain cyclically 6-edge-connected snarks. There, a 6-cycle of the Petersen graph is superpositioned by supervertices  $A$  or  $A'$  and by superedges obtained from Flower snarks. A generalized construction, where any snark  $G$  is taken instead of the Petersen graph and any cycle  $C$  instead of a 6-cycle, is used in [15] to obtain hypohamiltonian snarks for almost all orders. In [14] it is established that for such superposition the Berge-Fulkerson Conjecture holds.

In this paper, we first consider a superposition obtained from any snark  $G$  by superpositioning vertices of a cycle  $C$  in  $G$  by supervertices  $A$  and  $A'$ , edges of  $C$  by superedges  $H_{x,y}$ , where  $H$  is any snark and not necessarily the same for every edge of  $C$ , and  $x, y$  is any pair of nonadjacent vertices of  $H$ . For such superpositions, two sufficient conditions for the existence of a normal 5-edge-coloring are given. The first condition is applied to snarks superpositioned by hypohamiltonian snarks, which yields a normal 5-edge-coloring for many of them. To be more precise, the condition yields a normal 5-edge-coloring for all hypohamiltonian snarks used as superedges, but only for some of the possible ways of connecting them. In particular, since Flower snarks are hypohamiltonian, this consequently yields a normal 5-edge-coloring for many (but not all) snarks superpositioned by Flower snarks. The second sufficient condition is more demanding, but its application yields a normal 5-edge-colorings for all superpositions by Flower snarks.

Finally, since the existence of a Petersen coloring implies the existence of the six perfect matchings required by the Berge-Fulkerson Conjecture, the results of this paper imply the results from [14].

## 2 Preliminaries

Let  $G$  be a snark, and  $C = u_0u_1 \cdots u_{g-1}u_0$  a cycle of length  $g$  in  $G$ . Denote the edges of a cycle  $C$  by  $e_i = u_iu_{i+1}$  for  $i = 0, \dots, g-1$ , where indices are taken modulo  $g$ . Also, let  $v_i$  denote the neighbor of  $u_i$  distinct from  $u_{i-1}$  and  $u_{i+1}$ , and let  $f_i = u_iv_i$ .

Recall that we defined two particular supervertices  $A$  and  $A'$  as in Figure 1. For superedges we take  $H_{x,y}$ , where  $H$  is a snark and  $x, y$  a pair of nonadjacent vertices of  $H$ . Notice that  $H_{x,y}$  has a pair of 3-connectors, the connectors  $S_x$  and  $S_y$  containing the three semiedges which are halves of the three edges of  $H$  incident to  $x$  and  $y$ , respectively. Let  $G_C(\mathcal{A}, \mathcal{B})$  be a superposition of  $G$  such that  $\mathcal{A}(u_i) \in \{A, A'\}$ ,  $\mathcal{B}(e_i) \in \{H_{x,y} : H \text{ is a snark and } x, y \text{ a pair of nonadjacent vertices of } H\}$  for every  $i = 0, \dots, g-1$ , and all other vertices and edges of  $G$  are superpositioned by themselves. The family of such superpositions is denoted by  $\mathcal{G}_C(\mathcal{A}, \mathcal{B})$ . We will write shortly  $\mathcal{A}_i$  for  $\mathcal{A}(u_i)$  and  $\mathcal{B}_i$  for  $\mathcal{B}(e_i)$ . Notice that in general we do not obtain a same graph  $G_C(\mathcal{A}, \mathcal{B})$ , up to isomorphism, if

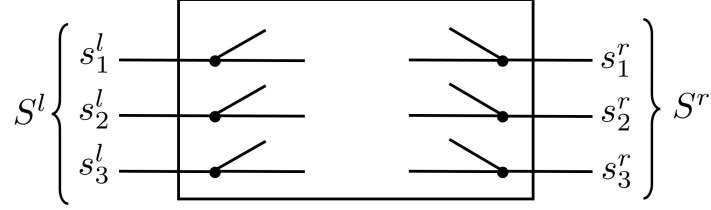

Figure 2: A schematic depiction of a superedge  $\mathcal{B}_i$  of a superposition  $G_C(\mathcal{A}, \mathcal{B})$ , with its left and right connector and their semiedges. Throughout the paper, we will assume such depiction.

the connector  $S_x$  of  $\mathcal{B}_i$  is identified with  $\mathcal{A}_i$  and  $S_y$  with  $\mathcal{A}_{i+1}$ , as when  $S_x$  is connected to  $\mathcal{A}_{i+1}$  and  $S_y$  to  $\mathcal{A}_i$ . In other words, we may consider a superedge  $\mathcal{B}_i$  as being directed from  $S_x$  to  $S_y$ . To be more precise, a connector of  $\mathcal{B}_i$  which is identified with a connector of  $\mathcal{A}_i$  (resp.  $\mathcal{A}_{i+1}$ ) will be called the *left* (resp. *right*) connector and denoted by  $S^l$  (resp.  $S^r$ ), its three semiedges will be called the *left* (resp. *right*) semiedges and denoted by  $s_1^l, s_2^l, s_3^l$  (resp.  $s_1^r, s_2^r, s_3^r$ ). A scheme of superedge which will be used throughout the paper is shown in Figure 2. For a superedge  $\mathcal{B}_i$  obtained from a snark  $H$  by removing nonadjacent vertices  $x$  and  $y$ , we write  $\mathcal{B}_i = H_{x,y}$  (resp.  $\mathcal{B}_i = H_{y,x}$ ) in case when  $S_x$  (resp.  $S_y$ ) is the left connector.

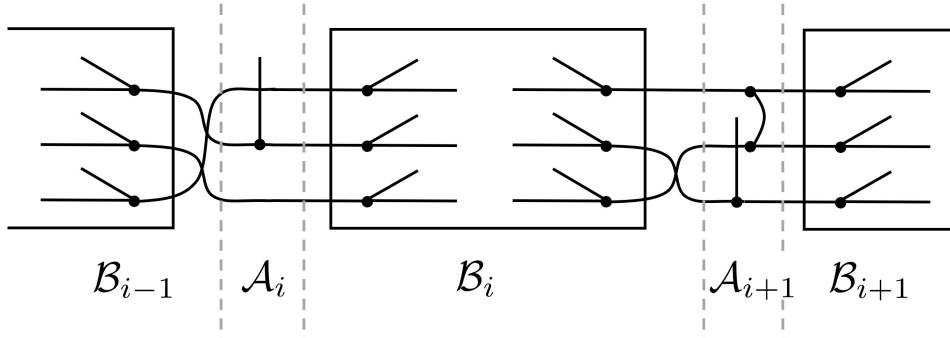

Figure 3: The figure shows how a superedge  $\mathcal{B}_i$  is connected to  $\mathcal{B}_{i-1}$  and  $\mathcal{B}_{i+1}$  given a permutation  $p_i$  and a dock  $d_i$  associated with  $\mathcal{B}_i$ . In this example,  $p_i = (1, 3, 2)$  and  $d_i = 2$ . From the figure it is also visible that  $p_{i-1} = (2, 3, 1)$  and  $d_{i+1} = 3$ .

It is convenient to assume that the connection of a supervertex  $\mathcal{A}_i$  with superedges  $\mathcal{B}_{i-1}$  and  $\mathcal{B}_i$  arises so that first the right semiedges of  $\mathcal{B}_{i-1}$  are identified with the left semiedges of  $\mathcal{B}_i$  and then one of the arising edges is subdivided to obtain the vertex  $u_i$  of  $\mathcal{A}_i$ . Since the semiedge identification of  $\mathcal{B}_{i-1}$  and  $\mathcal{B}_i$  can be done in various ways, as shown in Figure 3, we will associate a permutation  $p_{i-1}$  of the set  $\{1, 2, 3\}$  with a superedge  $\mathcal{B}_{i-1}$ , so that the right superedges  $s_1^r, s_2^r, s_3^r$  of  $\mathcal{B}_{i-1}$  are first permuted according to  $p_{i-1}$  and then identified with left semiedges  $s_1^l, s_2^l, s_3^l$  of  $\mathcal{B}_i$ , i.e. a right semiedge  $s_{p_{i-1}(j)}^r$  of  $\mathcal{B}_{i-1}$  is identified with a left  $s_j^l$  of  $\mathcal{B}_i$ . A permutation  $p_{i-1}$  will be called a *semiedge permutation*.

For example, in Figure 3 it holds that  $p_{i-1} = (2, 3, 1)$  and  $p_i = (1, 3, 2)$ . When  $p_{i-1}$  is clear from the context, we will for brevity sake denote  $p_{i-1}^{-1}(j)$  by  $j^-$ .

Assuming that  $s_{j^-}^r s_j^l$  denotes an edge arising by semiedge identification, one  $j \in \{1, 2, 3\}$  has to be chosen as the index of the edge which is to be subdivided by  $u_i$ . Since  $j$  is the index of left semiedges in  $\mathcal{B}_i$ , we will denote that choice by  $j = d_i$  and associate it with  $\mathcal{B}_i$ . The choice  $d_i$  of a left semiedge of  $\mathcal{B}_i$  to be connected to the vertex  $u_i$  of  $\mathcal{A}_i$  is called a *dock* index, and the left semiedge  $s_{d_i}^l$  is called a *dock* semiedge. For example, in Figure 3 it holds that  $d_i = 2$  and  $d_{i+1} = 3$ .

To conclude, each superedge  $\mathcal{B}_i$  is associated with a permutation  $p_i$  which determines how the right semiedges of  $\mathcal{B}_i$  connect to left semiedges of  $\mathcal{B}_{i+1}$ , and a dock index  $d_i$  which determines which of the left semiedges of  $\mathcal{B}_i$  is connected to a vertex  $u_i$  of  $\mathcal{A}_i$ .

**Submultipoles and their compatible colorings.** We will next consider normal 5-edge-colorings of a superposition  $G_C(\mathcal{A}, \mathcal{B})$ , for which purpose we first need to define the notions of submultipole and the restriction of a coloring to a submultipole. Let  $M = (V, E, S)$  be a multipole. A multipole  $M' = (V', E', S')$  is a *submultipole* of  $M$  if  $V' \subseteq V$ ,  $E' \subseteq E$  and  $S' \subseteq S \cup E_S$  where  $E_S$  is the set consisting of halves of edges from  $E$ . For a subset  $V' \subseteq V$ , we say that a multipole  $M' = M[V']$  is an *induced* submultipole of  $M$  if  $M'$  has a set of vertices  $V'$ , set of edges  $E'$  consisting of all edges  $e$  of  $M$  with both end-vertices in  $V'$ , and set of semiedges  $S'$  which consists of all semiedges of  $M$  whose only end-vertex belongs to  $V'$  and halves of all edges of  $E$  which have precisely one end-vertex in  $V'$ .

Further, let  $\sigma$  be a normal 5-edge-coloring of a cubic multipole  $M$ . Then the *restriction*  $\sigma' = \sigma|_{M'}$  of  $\sigma$  to  $M'$  is defined by  $\sigma'(e) = \sigma(e)$  for  $e \in E'$ ,  $\sigma'(s) = \sigma(s)$  for  $s \in S' \cap S$  and  $\sigma'(s) = \sigma(e_s)$  for  $s \in S' \setminus S$  where  $e_s$  denotes the edge of  $M$  such that  $s$  is a semiedge of  $e_s$ . Let  $M_1, \dots, M_k$  be cubic submultipoles of a cubic multipole  $M$ , let  $\sigma_i$  be a normal 5-edge-coloring of a submultipole  $M_i$  for  $i = 1, \dots, k$ , and let  $M'$  be a submultipole of  $M$  induced by  $\cup_{i=1}^k V(M_i)$ . Colorings  $\sigma_i$  are said to be *compatible*, if there exists a normal 5-edge-coloring  $\sigma'$  of  $M'$  such that  $\sigma'|_{M_i} = \sigma_i$  for every  $i = 1, \dots, k$ .

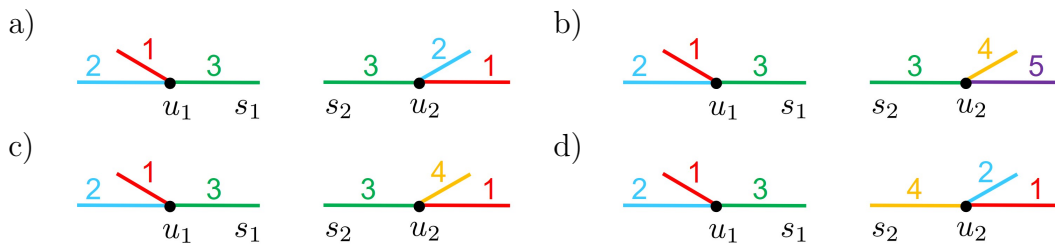

Figure 4: All four figures show the same color scheme  $\sigma_1[s_1]$  of a semiedge  $s_1$ . As for the color scheme  $\sigma_2[s_2]$ , it holds that: a)  $\sigma_2[s_2]$  is consistent with  $\sigma_1[s_1]$  since they are the same, b)  $\sigma_2[s_2]$  is consistent with  $\sigma_1[s_1]$  since they coincide on  $s_1$  and  $s_2$  and have complementary pair of incident colors, c)  $\sigma_2[s_2]$  is not consistent with  $\sigma_1[s_1]$  since they have neither the same nor complementary incident colors, d)  $\sigma_2[s_2]$  is not consistent with  $\sigma_1[s_1]$  since they do not coincide on  $s_1$  and  $s_2$ .

We introduce the notion of color schemes of semiedges, illustrated by Figure 4. Let  $M$  be a cubic multipole, and  $\sigma$  a normal 5-edge-coloring of  $M$ . For a semiedge  $s \in S(M)$  incident to a vertex  $v_s \in V(M)$ , a *color scheme*  $\sigma[s]$  is defined by  $\sigma[s] = (i, \{j, k\})$ , where  $i = \sigma(s)$  and  $j, k$  are the two remaining colors incident to the vertex  $v_s$  in  $\sigma$ .

**Definition 9** Let  $s_1$  (resp.  $s_2$ ) be a semiedge of a cubic multipole  $M_1$  (resp.  $M_2$ ) which has normal 5-edge-coloring  $\sigma_1$  (resp.  $\sigma_2$ ). *Color schemes*

$$\sigma_1[s_1] = (i_1, \{j_1, k_1\}) \quad \text{and} \quad \sigma_2[s_2] = (i_2, \{j_2, k_2\})$$

are consistent if  $i_1 = i_2$  and  $\{j_1, k_1\}$  is equal either to  $\{j_2, k_2\}$  or to  $\{1, 2, 3, 4, 5\} \setminus \{i_2, j_2, k_2\}$ . If  $\sigma_1[s_1]$  and  $\sigma_2[s_2]$  are consistent, we write  $\sigma_1[s_1] \approx \sigma_2[s_2]$ .

Now, let  $\tilde{G} \in \mathcal{G}_C(\mathcal{A}, \mathcal{B})$  be a superposition of  $G$ ,  $\mathcal{B}_i$  a superedge of  $\tilde{G}$ , and  $\tilde{\sigma}_i$  a 5-edge-coloring of  $\mathcal{B}_i$ . A *color scheme* of the left and right connector of  $\mathcal{B}_i$  is defined by

$$\tilde{\sigma}_i[S^l] = (\tilde{\sigma}_i[s_1^l], \tilde{\sigma}_i[s_2^l], \tilde{\sigma}_i[s_3^l]) \quad \text{and} \quad \tilde{\sigma}_i[S^r] = (\tilde{\sigma}_i[s_1^r], \tilde{\sigma}_i[s_2^r], \tilde{\sigma}_i[s_3^r]),$$

respectively. A *color scheme* of a superedge  $\mathcal{B}_i$  is defined by

$$\tilde{\sigma}_i[\mathcal{B}_i] = (\tilde{\sigma}_i[S^l], \tilde{\sigma}_i[S^r]).$$

Let  $\mathcal{B}_i$  be a superedge of  $G_C(\mathcal{A}, \mathcal{B})$ , and  $\tilde{\sigma}_i$  and  $\tilde{\sigma}'_i$  a pair of normal 5-edge-colorings of  $\mathcal{B}_i$ . Colorings  $\tilde{\sigma}_i$  and  $\tilde{\sigma}'_i$  are *consistent* on the left connector  $S^l$  of  $\mathcal{B}_i$ , which is denoted by  $\tilde{\sigma}_i[S^l] \approx \tilde{\sigma}'_i[S^l]$ , if  $\tilde{\sigma}_i[s_j^l] \approx \tilde{\sigma}'_i[s_j^l]$  for every  $j = 1, 2, 3$ . The consistency of  $\tilde{\sigma}_i$  and  $\tilde{\sigma}'_i$  on the right connector  $S^r$  of  $\mathcal{B}_i$  is defined and denoted analogously. Finally, colorings  $\tilde{\sigma}_i$  and  $\tilde{\sigma}'_i$  are *consistent* on  $\mathcal{B}_i$ , which is denoted by  $\tilde{\sigma}_i[\mathcal{B}_i] \approx \tilde{\sigma}'_i[\mathcal{B}_i]$ , if  $\tilde{\sigma}_i$  and  $\tilde{\sigma}'_i$  are consistent on both right and left connector of  $\mathcal{B}_i$ . If  $\tilde{\sigma}_i$  and  $\tilde{\sigma}'_i$  are consistent on  $\mathcal{B}_i$ , we also say that color schemes  $\tilde{\sigma}_i[\mathcal{B}_i]$  and  $\tilde{\sigma}'_i[\mathcal{B}_i]$  are consistent.

### 3 Sufficient conditions for the existence of a normal 5-edge-coloring of a superposition

We define a submultipole  $M_{\text{int}}$  of  $\tilde{G} \in \mathcal{G}_C(\mathcal{A}, \mathcal{B})$  as a submultipole induced by the set of vertices  $V(G) \setminus V(C) \subseteq V(\tilde{G})$ . Also, every  $\mathcal{B}_i$  is obviously a submultipole of  $\tilde{G}$ . For a given normal 5-edge-coloring  $\tilde{\sigma}$  of  $\tilde{G}$ , the corresponding colorings  $\tilde{\sigma}_{\text{int}}$  of  $M_{\text{int}}$  and  $\tilde{\sigma}_i$  of  $\mathcal{B}_i$  for all  $i$  are defined as the restrictions of  $\tilde{\sigma}$  to a corresponding multipole, i.e.  $\tilde{\sigma}_{\text{int}} = \tilde{\sigma}|_{M_{\text{int}}}$  and  $\tilde{\sigma}_i = \tilde{\sigma}|_{\mathcal{B}_i}$ . Notice that  $\tilde{\sigma}_{\text{int}}$  and  $\tilde{\sigma}_i$  are normal 5-edge-colorings, and they are compatible in the sense that there exists a normal 5-edge-coloring of  $\tilde{G}$  (that being  $\tilde{\sigma}$ , of course) such that its restriction to the corresponding multipoles is equal to  $\tilde{\sigma}_{\text{int}}$  and  $\tilde{\sigma}_i$ . Moreover,  $\tilde{\sigma}_{\text{int}}$  and all  $\tilde{\sigma}_0, \dots, \tilde{\sigma}_{g-1}$  uniquely identify  $\tilde{\sigma}$ . In our considerations, we will go in the reverse direction, we will construct colorings  $\tilde{\sigma}_{\text{int}}$  and  $\tilde{\sigma}_i$  for all  $i$ , and then establish that they are compatible and thus we will obtain a desired normal 5-edge-coloring of  $\tilde{G}$ .

We first introduce the so called right coloring, in which all three right semiedges have a same color scheme, i.e. they are mutually consistent. Also, when a normal 5-edge-coloring of a superposition cannot be constructed using only right colorings, a pair of semiedges  $\mathcal{B}_{i-1}$  and  $\mathcal{B}_i$  will be considered together, where  $\mathcal{B}_i$  will be colored by a so called left coloring, so the names "left" and "right" for colorings correspond to the position of  $\mathcal{B}_{i-1}$  and  $\mathcal{B}_i$  in illustrations.



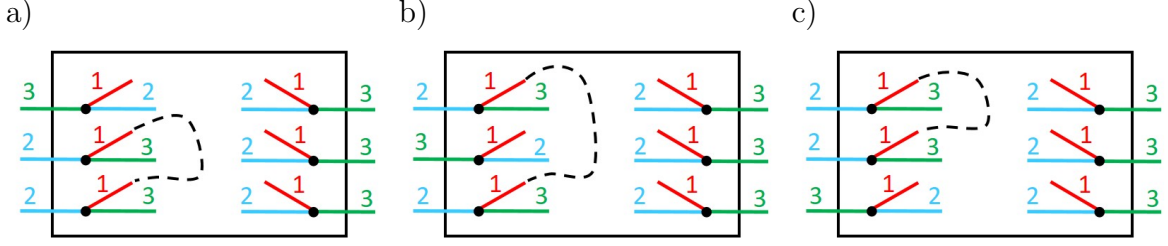

Figure 5: The figure shows a color scheme  $\kappa_j$  for: a)  $j = 1$ , b)  $j = 2$ , c)  $j = 3$ . Also, the dashed curve represents the Kempe chain  $P^l$ .

### 3.1 Right colorings and the first sufficient condition

Let  $\kappa_j$ , for  $j \in \{1, 2, 3\}$ , denote the superedge color scheme from Figure 5. A  $j$ -right coloring  $R_j^i((2, 1), 3)$  of a superedge  $\mathcal{B}_i$  is any normal 5-edge-coloring of  $\mathcal{B}_i$  consistent with a color scheme  $\kappa_j$  in which there exists a Kempe  $(2, 1)$ -chain  $P^l$  connecting the pair of left semiedges distinct from  $s_j^l$ . The Kempe chain  $P^l$  is also illustrated by Figure 5. A superedge  $\mathcal{B}_i$  is said to be  $j$ -right if it has a  $j$ -right coloring  $R_j^i((2, 1), 3)$ . In this notation  $R_j^i((2, 1), 3)$ , the number 3 denotes the color of all three right semiedges and the left semiedge  $s_j^l$ , and  $(2, 1)$  denotes the colors of Kempe chain  $P^l$  starting with color 2 which is the color of the remaining two left semiedges distinct from  $s_j^l$ . Notice that in this kind of coloring all three right semiedges are pairwise consistent. The word "right" is added the prefix " $j$ -", since precisely one of the three left semiedges, that being semiedge  $s_j^l$ , is consistent with them.

A superedge  $\mathcal{B}_i$  is called:

- *dock-right*, if it is a  $j$ -right for  $j = d_i$ ,
- *doubly-right*, if it is  $j$ -right for at least two distinct values of  $j$ ,
- *fully-right*, if it is  $j$ -right for every  $j \in \{1, 2, 3\}$ .

A coloring of  $\mathcal{B}_i$  which can be obtained from  $R_j^i((2, 1), 3)$  by replacing colors  $(2, 1)$  along the Kempe chain  $P^l$  with  $(t_1, t_2) \in \{(1, 2), (4, 5), (5, 4)\}$  will be also called a  $j$ -right coloring, and it will be denoted by  $R_j^i((t_1, t_2), 3)$ . Notice that  $R_j^i((t_1, t_2), 3)$  remains normal and it is consistent with  $R_j^i((2, 1), 3)$  on the right connector of the superedge, i.e. all three right semiedges remain pairwise consistent in all  $j$ -right colorings of  $\mathcal{B}_i$ . Finally, notice that  $j$ -right coloring is a 5-edge-coloring even though color schemes from Figure 5 contain only three colors. So, any coloring of  $\mathcal{B}_i$  which can be obtained from a  $j$ -right coloring by a color permutation  $c$ , which is a permutation of the set of 5 colors, will also be called a  $j$ -right coloring. Such a coloring is denoted by  $R_j^i((c(t_1), c(t_2)), c(3))$ .

Recall that edges of  $G$  incident to vertices  $u_i$  of the cycle  $C$  in  $G$  are denoted by  $e_i = u_i u_{i+1}$  and  $f_i = u_i v_i$ . Let  $\sigma$  be a normal 5-edge-coloring of  $G$ . A  $j$ -right coloring of  $\mathcal{B}_i$  is  $\sigma$ -compatible if on the each of the three right semiedges as well as on  $s_j^l$  it is consistent with  $(\sigma(e_i), \{\sigma(f_i), \sigma(e_{i-1})\})$ , on the remaining two left semiedges it is consistent

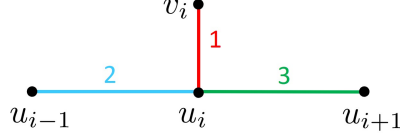

Figure 6: A coloring  $\sigma$  of the edges incident to a vertex  $u_i$  of a cycle  $C$  in  $G$ . For such a coloring  $\sigma$ , all colorings of  $\mathcal{B}_i$  consistent with color schemes from Figure 5 are  $\sigma$ -compatible.

with  $(\sigma(e_{i-1}), \{\sigma(f_i), \sigma(e_i)\})$  and there exists a Kempe  $(\sigma(e_{i-1}), \sigma(f_i))$ -chain  $P^l$  connecting these two left semiedges, i.e. a coloring  $R_j^i((\sigma(f_i), \sigma(e_{i-1})), \sigma(e_i))$ . A  $j$ -right coloring of  $\mathcal{B}_i$  which is  $\sigma$ -compatible will often be denoted only by  $R_j^i$ . For example, any  $j$ -right coloring consistent with color schemes shown in Figure 5 is  $\sigma$ -compatible with  $\sigma$  as in Figure 6.

If, for a given  $j$ , a superedge  $\mathcal{B}_i$  has a  $j$ -right coloring which is  $\sigma$ -compatible for  $\sigma$  as in Figure 6, then for any other  $\sigma$  a corresponding  $\sigma$ -compatible  $j$ -right coloring of  $\mathcal{B}_i$  is obtained by color permutation. Consequently, it is sufficient to check whether, for a given  $j$ , a superedge  $\mathcal{B}_i$  has a  $j$ -right coloring in colors 1, 2, 3 as in Figure 5.

For a  $\sigma$ -compatible  $j$ -right coloring  $R_j^i$  of  $\mathcal{B}_i$ , its *complementary*  $j$ -right coloring  $\bar{R}_j^i$  of  $\mathcal{B}_i$  is the  $j$ -right coloring which can be obtained from  $R_j^i$  by swapping colors  $\sigma(e_{i-1})$  and  $\sigma(f_i)$  along the Kempe chain  $P^l$ , i.e.

$$\bar{R}_j^i = R_j^i((\sigma(f_i), \sigma(e_{i-1})), \sigma(e_i)).$$

We are now in a position to establish the first sufficient condition for the existence of a normal 5-edge-coloring of a superposition  $\tilde{G} \in \mathcal{G}_C(\mathcal{A}, \mathcal{B})$ .

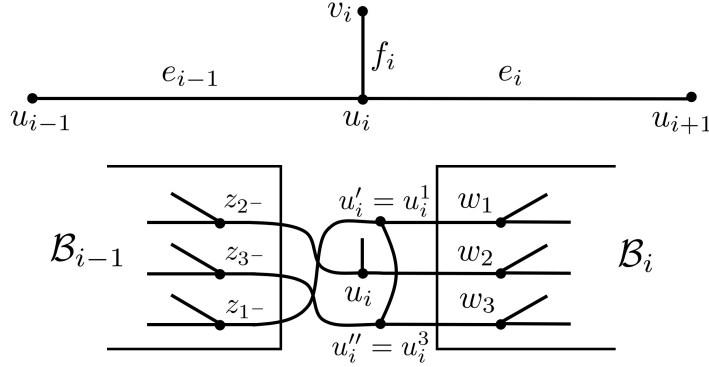

Figure 7: The figure shows a supervertex  $\mathcal{A}_i$ , and superedges  $\mathcal{B}_{i-1}$  and  $\mathcal{B}_i$  with  $p_{i-1} = (2, 3, 1)$  and  $d_i = 2$  in a superposition  $G_C(\mathcal{A}, \mathcal{B})$  and the corresponding vertex notation.

**Theorem 10** *Let  $G$  be a snark with a normal 5-edge-coloring  $\sigma$ ,  $C$  a cycle of length  $g$  in  $G$ , and  $\tilde{G} \in \mathcal{G}_C(\mathcal{A}, \mathcal{B})$  a superposition of  $G$ . If the superedge  $\mathcal{B}_i$  is dock-right for every  $i = 0, \dots, g - 1$ , then  $\tilde{G}$  has a normal 5-edge-coloring.*

**Proof.** We will construct a normal 5-edge-coloring  $\tilde{\sigma}$  of  $\tilde{G}$  by defining compatible colorings  $\tilde{\sigma}_{\text{int}}$  of  $M_{\text{int}}$  and  $\tilde{\sigma}_i$  of  $\mathcal{B}_i$  for all  $i$ . We first introduce some necessary notation. For a left semiedge  $s_j^l$  of  $\mathcal{B}_i$ , let  $w_j$  denote the vertex of  $\mathcal{B}_i$  incident to it as illustrated in Figure 7. Notice that  $s_j^l$  of  $\mathcal{B}_i$  is identified with a right semiedge  $s_{p_{i-1}^{-1}(j)}^r$  of  $\mathcal{B}_{i-1}$  in the case of  $\mathcal{A}_i = A$ , or it is a part of an incident edge in the case of  $\mathcal{A}_i = A'$ . We also introduce  $j^- = p_{i-1}^{-1}(j)$ . So, according to this simplified notation, a right semiedge  $s_{j^-}^r$  of  $\mathcal{B}_{i-1}$  connects to  $s_j^l$  of  $\mathcal{B}_i$ . Further, let  $z_{j^-}$  denote the vertex of  $\mathcal{B}_{i-1}$  to which  $s_{j^-}^r$  is incident to, see Figure 7. Finally, recall that edges of  $G$  incident to vertices of  $C$  are denoted by  $e_i = u_i u_{i+1}$  and  $f_i = u_i v_i$ .

**Claim 1.** *If  $\mathcal{A}_i = A$ , then  $\tilde{\sigma}_{\text{int}} = \sigma|_{M_{\text{int}}}$ ,  $\tilde{\sigma}_{i-1} = R_{j_{i-1}}^{i-1}$  and  $\tilde{\sigma}_i = R_{d_i}^i$  are compatible in  $\tilde{G}$  for every  $j_{i-1} \in \{1, 2, 3\}$ .*

Let  $M_i$  denote a submultipole of  $\tilde{G}$  induced by  $V(M_{\text{int}}) \cup V(\mathcal{B}_{i-1}) \cup V(\mathcal{A}_i) \cup V(\mathcal{B}_i)$ . Assume that for an edge-coloring  $\tilde{\sigma}$  of  $M_i$  it holds that  $\tilde{\sigma}|_{\mathcal{B}_{i-1}} = \tilde{\sigma}_{i-1}$ ,  $\tilde{\sigma}|_{\mathcal{B}_i} = \tilde{\sigma}_i$ , and  $\tilde{\sigma}|_{M_{\text{int}}} = \tilde{\sigma}_{\text{int}}$ . We have to establish that  $\tilde{\sigma}$  is well defined and normal. Notice that  $\tilde{\sigma}(w_{d_i} u_i) = \tilde{\sigma}_i(s_{d_i}^l) = \sigma(e_i)$ ,  $\tilde{\sigma}(z_{d_i^-} u_i) = \tilde{\sigma}_{i-1}(s_{d_i^-}^r) = \sigma(e_{i-1})$  and  $\tilde{\sigma}(u_i v_i) = \sigma(f_i)$ . We obtain

$$\tilde{\sigma}(u_i) = \{\sigma(e_{i-1}), \sigma(e_i), \sigma(f_i)\} = \sigma(u_i),$$

so  $\tilde{\sigma}$  is proper at  $u_i$  since  $\sigma$  is proper at  $u_i$ . Further, notice that for every  $j \in \{1, 2, 3\}$  it holds that

$$\tilde{\sigma}_{i-1}(z_{j^-}) = \{\sigma(e_{i-2}), \sigma(e_{i-1}), \sigma(f_{i-1})\} \quad \text{and} \quad \tilde{\sigma}_i(w_j) = \{\sigma(e_{i-1}), \sigma(e_i), \sigma(f_i)\}.$$

So, the edge  $z_{d_i^-} u_i$  is normal by  $\tilde{\sigma}$  since  $e_{i-1}$  is normal by  $\sigma$ . Also, the edge  $u_i w_{d_i}$  is poor by  $\tilde{\sigma}$  since  $\tilde{\sigma}(u_i) = \tilde{\sigma}_i(w_{d_i})$ .

For  $j \neq d_i$  it holds that

$$\tilde{\sigma}(z_{j^-} w_j) = \tilde{\sigma}_{i-1}(s_{j^-}^r) = \tilde{\sigma}_i(s_j^l) = \tilde{\sigma}(e_{i-1}).$$

So,  $\tilde{\sigma}$  is well defined. Given the values of  $\tilde{\sigma}_{i-1}(z_{j^-})$  and  $\tilde{\sigma}_i(w_j)$  noted above, it follows that  $z_{j^-} w_j$  is normal by  $\tilde{\sigma}$  since  $e_{i-1}$  is normal by  $\sigma$ . This establishes the claim.

**Claim 2.** *If  $\mathcal{A}_i = A'$ , then  $\tilde{\sigma}_{\text{int}} = \sigma|_{M_{\text{int}}}$ ,  $\tilde{\sigma}_{i-1} = R_{j_{i-1}}^{i-1}$  and  $\tilde{\sigma}_i = \bar{R}_{d_i}^i$  are compatible in  $\tilde{G}$  for any  $j_{i-1} \in \{1, 2, 3\}$ .*

Let  $M_i$  and  $\tilde{\sigma}$  be defined as in Claim 1. The properness of  $\tilde{\sigma}$  at  $u_i$  and the normality of the edges of  $\tilde{G}$  incident to  $u_i$  is established in the same way as in Claim 1. We define  $\tilde{\sigma}(u_i^l u_i^r) = \sigma(e_i)$ . For the sake of notation consistency, let us denote  $u_i^l$  (resp.  $u_i^r$ ) also by  $u_i^j$ , where  $j$  is the index of the left semiedge  $s_j^l$  of  $\mathcal{B}_i$  which connects to  $u_i^l$ , see Figure 7. Thus, for  $j \neq d_i$  we have

$$\tilde{\sigma}(u_i^j w_j) = \tilde{\sigma}_i(s_j^l) = \sigma(f_i) \quad \text{and} \quad \tilde{\sigma}(u_i^j z_{j^-}) = \tilde{\sigma}_i(s_{j^-}^r) = \sigma(e_{i-1}).$$

This implies  $\tilde{\sigma}(u_i^j) = \sigma(u_i)$ , so  $\tilde{\sigma}$  is proper at  $u_i^j$  since  $\sigma$  is proper at  $u_i$ . Moreover, from  $\tilde{\sigma}_i(w_j) = \sigma(u_i) = \tilde{\sigma}(u_i^j)$  it follows that the edge  $w_j u_i^j$  is poor by  $\tilde{\sigma}$ . Given the values of

$\tilde{\sigma}_{i-1}(z_{j-})$  and  $\tilde{\sigma}(u_i^j)$ , it also follows that the edge  $z_{j-}u_i^j$  is normal by  $\tilde{\sigma}$  since  $e_{i-1}$  is normal by  $\sigma$ . This establishes Claim 2.

Next, for every  $i = 0, \dots, g - 1$ , we define

$$\tilde{\sigma}_i = \begin{cases} R_{d_i}^i & \text{if } \mathcal{A}_i = A, \\ \bar{R}_{d_i}^i & \text{if } \mathcal{A}_i = A'. \end{cases}$$

Since  $R_{d_i}^i$  and  $\bar{R}_{d_i}^i$  are consistent on the right connector  $S^r$  of  $\mathcal{B}_i$ , Claims 1 and 2 imply that  $\tilde{\sigma}_{\text{int}}$  and  $\tilde{\sigma}_i$ , for all  $i$ , are compatible in  $\tilde{G}$ . This further implies that  $\tilde{G}$  has a normal 5-edge-coloring, and we are finished. ■

From the above theorem, we immediately have the next result as a corollary.

**Corollary 11** *Let  $G$  be a snark with a normal 5-edge-coloring  $\sigma$ ,  $C$  a cycle of length  $g$  in  $G$ , and  $\tilde{G} \in \mathcal{G}_C(\mathcal{A}, \mathcal{B})$  a superposition of  $G$ . If the superedge  $\mathcal{B}_i$  is fully-right for every  $i = 0, \dots, g - 1$ , then  $\tilde{G}$  has a normal 5-edge-coloring.*

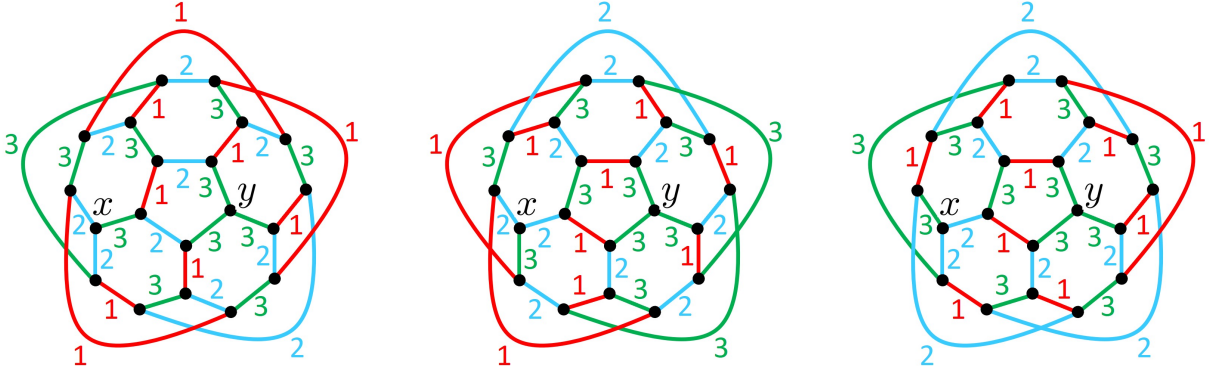

Figure 8: The figure shows three distinct edge-colorings of the Flower snark  $H$  which are neither proper nor normal, but their restriction to the superedge  $H_{x,y}$  yields a right coloring where each of the left semiedges is a dock in one of them. Thus,  $H_{x,y}$  is fully-right.

**Application to hypohamiltonian snarks.** The sufficient condition of Theorem 10 applies to many snarks  $H$  used as superedges. To see this, we first need to introduce the notion of hypohamiltonian graphs. Namely, a graph  $H$  is *hypohamiltonian* if  $H$  is not Hamiltonian and for every vertex  $v \in V(H)$  it holds that  $H - v$  is Hamiltonian. In [6], it was established that Flower snarks are hypohamiltonian, and in [15] hypohamiltonian snarks with cyclic connectivity 5 and 6 are constructed for all but finitely many even orders. Thus, there are infinitely many hypohamiltonian snarks, and for such snarks the following proposition holds.

**Proposition 12** *Let  $H$  be a hypohamiltonian snark and  $x, y$  a pair of nonadjacent vertices in  $H$ . Then  $H_{x,y}$  is  $j$ -right for at least one  $j \in \{1, 2, 3\}$ .*

**Proof.** Let  $H' = H - y$ . Since  $H$  is hypohamiltonian, it follows that  $H'$  is Hamiltonian. Let  $C'$  be a Hamiltonian cycle in  $H'$ . Since  $H$  is a cubic graph, it has an even number of vertices, so  $H'$  has an odd number of vertices. Consequently,  $C'$  is an odd length cycle in  $H'$ . Let  $x_1, x_2$ , and  $x_3$  be the three neighbors of  $x$  in  $H$ . Thus,  $C'$  contains precisely two out of the three edges  $x_jx$ , say edges  $x_1x$  and  $x_2x$ . Let  $H''$  (resp.  $C''$ ) be obtained from  $H' - x_3x$  (resp.  $C'$ ) by suppressing the vertex  $x$ . Denote by  $e_x$  the edge of  $H''$  obtained by suppressing  $x$ .

Now, notice that  $H''$  is a graph of an even order and  $C''$  is a Hamiltonian cycle in it. Color the edges of  $C''$  in  $H''$  alternately by 1 and 2 so that  $e_x$  is colored by 2, and all edges in  $E(H'') \setminus E(C'')$  are colored by 3. This yields a proper 3-edge-coloring  $\sigma''$  of  $H''$ . We construct the corresponding coloring  $\sigma$  of  $H$  in the following way. All edges  $e \in E(H) \cap E(H'')$  are colored in  $H$  as in  $H''$ , edges  $x_1x$  and  $x_2x$  are colored by 2, and the three edges of  $H$  incident to  $y$  and  $x_3x$  are colored by 3. Notice that  $\sigma$  is neither a proper nor a normal edge-coloring of  $H$ , but the restriction of  $\sigma$  to  $H_{x,y}$  yields a  $j$ -right coloring of  $H_{x,y}$  for  $j = 3$ . ■

In the above proposition, it is established that every hypohamiltonian snark is  $j$ -right for at least one  $j \in \{1, 2, 3\}$ . Let  $\tilde{G}$  be a superposition of a snark  $G$  such that every edge of a cycle  $C$  is superpositioned by a hypohamiltonian snark (which does not have to be the same one for all edges of  $C$ ) in a way that the superedge obtained from the hypohamiltonian snark is  $j$ -right for  $j = d_i$ . For such a superposition, Theorem 10 implies the existence of a normal 5-edge-coloring of the superposition  $\tilde{G}$ .

There also exist snarks  $H$  and pairs of vertices  $x, y$  in them, such that  $H_{x,y}$  is fully-right. For example, if one considers for  $H$  the so-called Flower snark  $J_5$  shown in Figure 8, and for  $x, y$  the pair of vertices designated in the figure, then it is evident from the figure that such  $H_{x,y}$  is fully-right. So, if  $\tilde{G} = G_C(\mathcal{A}, \mathcal{B})$  is a superposition such that  $\mathcal{B}_i = H_{x,y}$  for every  $i$ , then Corollary 11 implies that  $\tilde{G}$  has a normal 5-edge-coloring.

We will deal with Flower snarks in greater details in the next section. For now, let us note that hypohamiltonian snarks are always dock-right for at least one dock out of three. Yet, they are often not fully-right. Consequently, we need a refinement of the sufficient condition from Theorem 10. For that purpose, we introduce several more color schemes of a superedge in the next section.

### 3.2 Left colorings and the second sufficient condition

Let  $\tau_{j,k}$  denote a color scheme from Figure 9, for  $j, k \in \{1, 2, 3\}$ . Notice that in both the left and the right connectors of  $\tau_{j,k}$ , two semiedges have the same color and the third semiedge is in a distinct color. So,  $j$  (resp.  $k$ ) is the index of the left (resp. right) semiedge in a color distinct from the color of the other two left (resp. right) semiedges.

A  $j, k$ -left coloring  $L_{j,k}^i((1, 2), 3, (2, 1))$  of  $\mathcal{B}_i$  is any normal 5-edge-coloring of  $\mathcal{B}_i$  consistent with a color scheme  $\tau_{j,k}$  in which there exists a Kempe  $(1, 2)$ -chain  $P^l$  connecting the pair of left semiedges distinct from  $s_j^l$ . The chain  $P^l$  is also shown in Figure 9. Notice that the first ordered pair  $(1, 2)$  of the notation  $L_{j,k}^i((1, 2), 3, (2, 1))$  indicates that the two left semiedges distinct from  $s_j^l$  are colored by 1 and that  $P^l$  is a Kempe  $(1, 2)$ -chain. The middle 3 denotes the color of semiedges  $s_j^l$  and  $s_k^r$ .

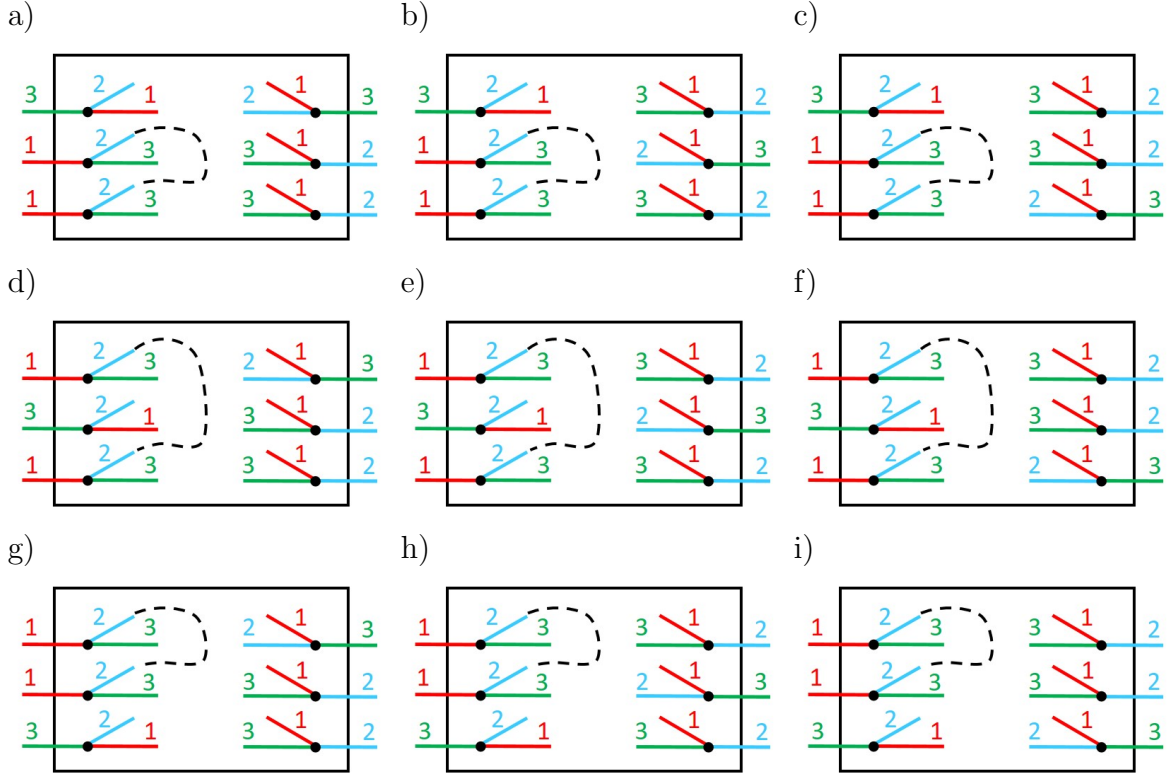

Figure 9: The figure shows a color scheme  $\tau_{j,k}$  for: a)  $(j, k) = (1, 1)$ , b)  $(j, k) = (1, 2)$ , c)  $(j, k) = (1, 3)$ , d)  $(j, k) = (2, 1)$ , e)  $(j, k) = (2, 2)$ , f)  $(j, k) = (2, 3)$ , g)  $(j, k) = (3, 1)$ , h)  $(j, k) = (3, 2)$ , j)  $(j, k) = (3, 3)$ .

The last ordered pair  $(2, 1)$  denotes that the remaining two right semiedges distinct from  $s_k^r$  are colored by 2 and are incident to color 1 beside 3. In general, a left coloring is a 5-edge-coloring. Yet, if  $L_{j,k}^i((1, 2), 3, (2, 1))$  uses only 3 colors, then the second ordered pair being  $(2, 1)$  would imply the existence of a Kempe  $(2, 1)$ -chain  $P^l$  connecting a pair of right semiedges distinct from  $s_k^r$ , such that  $P^l$  and  $P^r$  are vertex disjoint.

A superedge  $\mathcal{B}_i$  is called *doubly-left* if for every  $j \in \{1, 2, 3\}$  it holds that  $\mathcal{B}_i$  has a left coloring  $L_{j,k}^i((1, 2), 3, (2, 1))$  for at least two distinct values of  $k$ .

Again, we may assume that  $L_{j,k}^i((1, 2), 3, (2, 1)) = L_{j,k}^i(T, 3, (2, 1))$  for  $T = (1, 2)$ . Colors  $T = (1, 2)$  can be replaced along  $P^l$  by any  $T'$  from  $\{(2, 1), (4, 5), (5, 4)\}$ . The coloring of  $\mathcal{B}_i$  obtained in this way will also be called a  *$j, k$ -left coloring* and denoted by  $L_{j,k}^i(T', 3, (2, 1))$ . Notice that  $L_{j,k}^i(T', 3, (2, 1))$  remains consistent with  $L_{j,k}^i((1, 2), 3, (2, 1))$  on the right connector for any  $T'$ . Finally, any coloring of  $\mathcal{B}_i$  which can be obtained from a  *$j, k$ -left coloring* by a color permutation  $c$ , which is a permutation of the set of five colors, will be also called a  *$j, k$ -left coloring*. Similarly as with right colorings, if for a given  $j$  and  $k$  the superedge  $\mathcal{B}_i$  has one  *$j, k$ -left coloring*, then it has all  *$j, k$ -left colorings*.

Let  $\sigma$  denote a normal 5-edge-coloring of a snark  $G$ . A  *$j, k$ -left coloring* of  $\mathcal{B}_i$  is  $\sigma$ -compatible if on  $s_j^l$  and  $s_k^r$  it is consistent with  $(\sigma(e_i), \{\sigma(f_{i+1}), \sigma(e_{i+1})\})$ , on the two right semiedges distinct from  $s_k^r$  it is consistent with  $(\sigma(e_{i+1}), \{\sigma(f_{i+1}), \sigma(e_i)\})$ , and on

the two left semiedges distinct from  $s_j^l$  it is consistent with  $(\sigma(e_{i-1}), \{\sigma(e_i), \sigma(f_i)\})$  with a Kempe  $(\sigma(e_{i-1}), \sigma(f_i))$ -chain  $P^l$  connecting this pair of left semiedges. In other words, it is  $\sigma$ -compatible if it is a coloring  $L_{j,k}^i(T_1, \sigma(e_i), T_2)$ , where  $T_1 = (\sigma(e_{i-1}), \sigma(f_i))$  and  $T_2 = (\sigma(e_{i+1}), \sigma(f_{i+1}))$ . Again, for a  $\sigma$ -compatible  $j, k$ -left coloring we will often write just  $L_{j,k}^i$  without denoting the colors. For example, any coloring consistent with color schemes from Figure 9 is  $\sigma$ -compatible for any  $\sigma$  as in Figure 10.

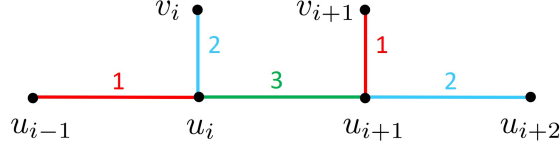

Figure 10: The figure shows a coloring  $\sigma$  of the edges incident to vertices  $u_i$  and  $u_{i+1}$  of a cycle  $C$  in  $G$ . All  $j, k$ -left colorings of  $\mathcal{B}_i$  consistent with color schemes from Figure 9 are  $\sigma$ -compatible with such a coloring  $\sigma$  of  $G$ .

For a  $\sigma$ -compatible  $j, k$ -left coloring  $L_{j,k}^i$  of  $\mathcal{B}_i$ , a *complementary*  $j, k$ -left coloring  $\bar{L}_{j,k}^i$  of  $\mathcal{B}_i$  is a  $j, k$ -left coloring which can be obtained from  $L_{j,k}^i$  by swapping colors  $\sigma(e_{i-1})$  and  $\sigma(f_{i-1})$  along  $P^l$ , i.e.

$$\bar{L}_{j,k}^i = L_{j,k}^i(T'_1, \sigma(e_i), T_2)$$

for  $T'_1 = (\sigma(f_i), \sigma(e_{i-1}))$  and  $T_2 = (\sigma(e_{i+1}), \sigma(f_{i+1}))$ . Let us first make the following observation.

**Observation 13** Colorings  $L_{j,k}^i$  and  $R_j^i$  are consistent on the left connector of  $\mathcal{B}_i$  for any  $k \in \{1, 2, 3\}$ . The same holds for complementary colorings  $\bar{L}_{j,k}^i$  and  $\bar{R}_j^i$ .

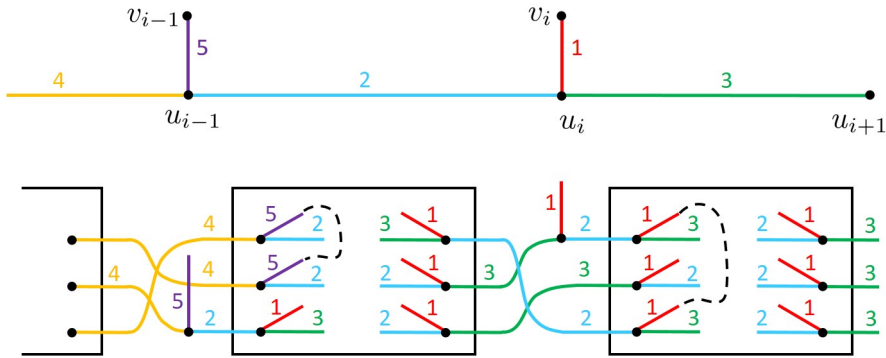

Figure 11: Considering together  $\mathcal{B}_{i-1}$  and  $\mathcal{B}_i$  in case when  $\mathcal{B}_i$  is not dock-right. Superedge  $\mathcal{B}_{i-1}$  is colored by a left coloring and  $\mathcal{B}_i$  by a right coloring.

We will also need the following lemma.

**Lemma 14** *Let  $G$  be a snark with a normal 5-edge-coloring  $\sigma$ ,  $C$  a cycle of length  $g$  in  $G$ , and  $\tilde{G} \in \mathcal{G}_C(\mathcal{A}, \mathcal{B})$  a superposition of  $G$ . Let  $\tilde{\sigma}_i$  be a coloring of  $\mathcal{B}_i$ . If  $\mathcal{A}_i = A$ , then for  $\{d_i, j_i, p_{i-1}(k_{i-1})\} = \{1, 2, 3\}$  and any  $j_{i-1} \in \{1, 2, 3\}$  it holds that  $\tilde{\sigma}|_{M_{\text{int}}} = \sigma|_{M_{\text{int}}}$ ,  $\tilde{\sigma}_{i-1} = L_{j_{i-1}, k_{i-1}}^{i-1}$  and  $\tilde{\sigma}_i = R_{j_i}^i$  are compatible in  $\tilde{G}$ .*

**Proof.** A pair of colorings  $\tilde{\sigma}_{i-1}$  and  $\tilde{\sigma}_i$  which satisfy the conditions of the lemma is illustrated by Figure 11. Let us assume that the vertices incident to the edges containing the semiedges of  $\mathcal{A}_i$  are denoted as in Figure 7. Namely, we denote indices of right semiedges in  $\mathcal{B}_{i-1}$  and their incident vertices by  $j^- = p_{i-1}^{-1}(j)$ . Assume that there exists a coloring  $\tilde{\sigma}$  such that  $\tilde{\sigma}|_{M_{\text{int}}} = \tilde{\sigma}_{\text{int}}$ ,  $\tilde{\sigma}|_{\mathcal{B}_{i-1}} = \tilde{\sigma}_{i-1}$  and  $\tilde{\sigma}|_{\mathcal{B}_i} = \tilde{\sigma}_i$ . We have to establish that  $\tilde{\sigma}$  is well defined and normal. Notice that

$$\tilde{\sigma}_i(w_j) = \tilde{\sigma}_{i-1}(z_{j^-}) = \{\sigma(e_{i-1}), \sigma(e_i), \sigma(f_i)\} = \sigma(u_i) \quad (1)$$

for every  $j \in \{1, 2, 3\}$ . Also, notice that the index  $j$ , which is used to denote the right semiedges of  $\mathcal{B}_i$ , takes its values from  $\{d_i, j_i, p_{i-1}(k_{i-1})\}$ .

Let us first consider  $j = d_i$ , which implies  $j \neq p_{i-1}(k_{i-1})$ , i.e.,  $k_{i-1} \neq j^-$ . In the left coloring  $\tilde{\sigma}_{i-1} = L_{j_{i-1}, k_{i-1}}^{i-1}$ , it holds that  $k_{i-1} \neq j^-$ . By the definition of the  $\sigma$ -compatible left coloring, we have  $\tilde{\sigma}_{i-1}(s_{j^-}^r) = \sigma(e_i)$ . In the right coloring  $\tilde{\sigma}_i = R_{j_i}^i$ , it holds that  $j_i \notin \{p_{i-1}(k_{i-1}), d_i\}$ , i.e.,  $j_i \neq j$ . By the definition of  $\sigma$ -compatible right coloring, we have  $\tilde{\sigma}_i(s_j^l) = \sigma(e_{i-1})$ . We conclude that

$$\begin{aligned} \tilde{\sigma}(u_i w_j) &= \tilde{\sigma}_i(s_j^l) = \sigma(e_{i-1}), \\ \tilde{\sigma}(u_i z_{j^-}) &= \tilde{\sigma}_{i-1}(s_{j^-}^r) = \sigma(e_i), \\ \tilde{\sigma}(u_i v_i) &= \sigma(u_i v_i) = \sigma(f_i), \end{aligned}$$

so we obtain  $\tilde{\sigma}(u_i) = \sigma(u_i)$ . Therefore,  $\tilde{\sigma}$  is proper at  $u_i$  since  $\sigma$  is proper at  $u_i$ . Combined with (1), this also yields that edges  $u_i w_j$ ,  $u_i z_{j^-}$  are poor by  $\tilde{\sigma}$ , and  $u_i v_i$  is normal by  $\tilde{\sigma}$  since it is normal by  $\sigma$ .

Let us next consider  $j = j_i \notin \{p_{i-1}(k_{i-1}), d_i\}$ . Since  $j \neq p_{i-1}(k_{i-1})$ , it holds that  $j^- \neq k_{i-1}$ . So, by the definition of  $\sigma$ -compatible left coloring, we have  $\tilde{\sigma}_{i-1}(s_{j^-}^r) = \sigma(e_i)$ . Also, since  $j = j_i$ , we have  $\tilde{\sigma}_i(s_j^l) = \sigma(e_i)$ . We conclude

$$\tilde{\sigma}(w_j z_{j^-}) = \tilde{\sigma}_i(s_j^l) = \tilde{\sigma}_{i-1}(s_{j^-}^r) = \sigma(e_i),$$

which implies  $\tilde{\sigma}$  is well defined on  $w_j z_{j^-}$ . Combined with (1), it follows that  $w_j z_{j^-}$  is poor by  $\tilde{\sigma}$ .

We finally consider  $j = p_{i-1}(k_{i-1}) \neq j_i$ . In this case,  $j = p_{i-1}(k_{i-1})$ , which means  $j^- = k_{i-1}$ . By the definition of  $\sigma$ -compatible left coloring, we have  $\tilde{\sigma}_{i-1}(s_{j^-}^r) = \sigma(e_{i-1})$ . On the other hand,  $j \neq j_i$ . Therefore, by the definition of  $\sigma$ -compatible right coloring, we have  $\tilde{\sigma}_i(s_j^l) = \sigma(e_{i-1})$ . Thus, we have

$$\tilde{\sigma}(w_j z_{j^-}) = \tilde{\sigma}_i(s_j^l) = \tilde{\sigma}_{i-1}(s_{j^-}^r) = \sigma(e_{i-1}),$$

so  $\tilde{\sigma}$  is well defined on  $w_j z_{j^-}$ . Combined with (1), it follows that  $w_j z_{j^-}$  is poor by  $\tilde{\sigma}$ . ■

We can now establish the following sufficient condition for the existence of a normal 5-edge-coloring of superpositions.



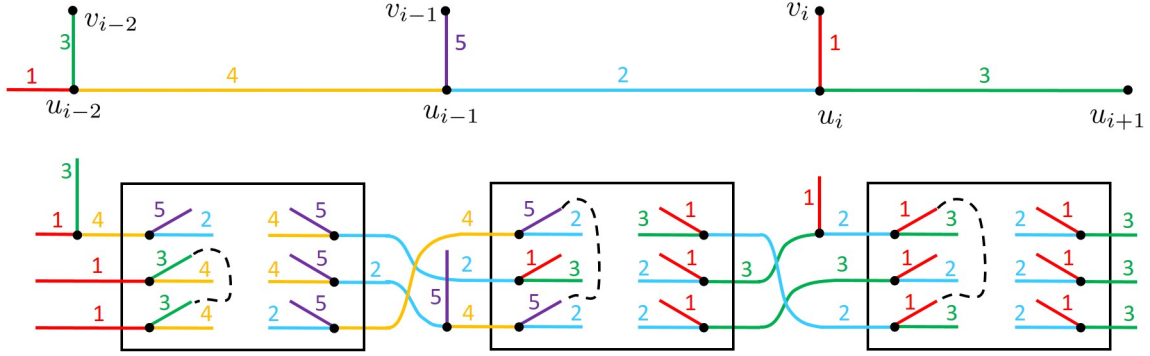

Figure 12: Considering together  $\mathcal{B}_{i-2}$ ,  $\mathcal{B}_{i-1}$ , and  $\mathcal{B}_i$ , in the case when  $\mathcal{B}_i$  is not dock-right. Superedges  $\mathcal{B}_{i-2}$  and  $\mathcal{B}_{i-1}$  are colored by a left coloring, and  $\mathcal{B}_i$  by a right coloring.

**Theorem 15** *Let  $G$  be a snark with a normal 5-edge-coloring  $\sigma$ ,  $C$  a cycle of length  $g$  in  $G$ , and  $\tilde{G} \in \mathcal{G}_C(\mathcal{A}, \mathcal{B})$  a superposition of  $G$ . If the superedge  $\mathcal{B}_i$  is both doubly-right and doubly-left for every  $i = 0, \dots, g-1$ , then  $\tilde{G}$  has a normal 5-edge-coloring.*

**Proof.** Let us first explain the idea behind this proof, so that it is later easier to follow. We will construct a normal 5-edge-coloring  $\tilde{\sigma}$  of  $\tilde{G}$  by defining a normal 5-edge-coloring of larger "chunks" which consist of two consecutive superedges. Namely, in the proof of Theorem 10, we considered single superedges and colored them by a right coloring. We proved further that the left side of such a colored superedge is compatible with the coloring of the previous superedge, and the right side is compatible with the coloring of the subsequent superedge. Here, some superedges might not have a desired right coloring. Each such superedge will be considered together with the neighboring superedge, i.e. we will consider two consecutive superedges as one larger "chunk". This "chunk" will be colored so that the left side of the leftmost superedge in the "chunk" is colored the same as the left side of a single superedge in Theorem 10. The right side of the rightmost superedge in a "chunk" will be colored the same as the right side of a single superedge in Theorem 10. Thus, these "chunks" will be mutually compatible in the same way as single superedges are in Theorem 10.

Now we distinguish the following two cases with respect to whether  $\tilde{G}$  has some superedge  $\mathcal{A}_i$  that is  $A'$ .

**Case 1:**  $\mathcal{A}_i = A$  for every  $i = 0, \dots, g-1$ . A desired coloring is obtained by the following algorithm. We first explain the details of the three procedures used in the algorithm, which are given input  $i$ , and afterwards, we describe the algorithm itself. The three procedures are the following:

**Procedure P1.** Consider the single dock-right superedge  $\mathcal{B}_i$ , set  $\tilde{\sigma}_i := R_{d_i}^i$ , and then set  $i := i-1$ .

**Procedure P2.** Consider the pair of superedges  $\mathcal{B}_{i-1}$  and  $\mathcal{B}_i$  together, where  $\mathcal{B}_i$  is not dock-right, as illustrated by Figure 11. Since  $\mathcal{B}_{i-1}$  is doubly-left, for  $j_{i-1} = d_{i-1}$  there

exists a  $k_{i-1} \neq p_{i-1}^{-1}(d_i)$  such that  $\mathcal{B}_{i-1}$  has a left coloring  $L_{j_{i-1}, k_{i-1}}^{i-1}$ . Furthermore,  $\mathcal{B}_i$  is doubly-right but not dock-right. So, for  $j_i \notin \{p_{i-1}(k_{i-1}), d_i\}$ , there exists a right coloring  $R_{j_i}^i$  of  $\mathcal{B}_i$ . Set

$$\tilde{\sigma}_{i-1} := L_{j_{i-1}, k_{i-1}}^{i-1} \quad \text{and} \quad \tilde{\sigma}_i := R_{j_i}^i.$$

Lemma 14 implies that  $\tilde{\sigma}_{\text{int}}$ ,  $\tilde{\sigma}_{i-1}$ , and  $\tilde{\sigma}_i$  are compatible in  $\tilde{G}$ . After this is defined, set  $i := i - 2$ .

**Procedure P3.** Consider the three superedges  $\mathcal{B}_{i-2}$ ,  $\mathcal{B}_{i-1}$ , and  $\mathcal{B}_i$  together, where  $\mathcal{B}_i$  is not dock-right, as illustrated by Figure 12. Since  $\mathcal{B}_{i-2}$  is doubly-left, for  $j_{i-2} = d_{i-2}$  there exists  $k_{i-2} \neq p_{i-2}^{-1}(d_{i-1})$  such that  $\mathcal{B}_{i-2}$  has a left coloring  $L_{j_{i-2}, k_{i-2}}^{i-2}$ . Similarly, since  $\mathcal{B}_{i-1}$  is doubly-left, for  $j_{i-1} \notin \{p_{i-2}(k_{i-2}), d_{i-1}\}$ , there exists  $k_{i-1} \neq p_{i-1}^{-1}(d_i)$  such that  $\mathcal{B}_{i-1}$  has a left coloring  $L_{j_{i-1}, k_{i-1}}^{i-1}$ . Finally, since  $\mathcal{B}_i$  is doubly-right but not dock-right, for the same  $j_i \notin \{p_{i-1}(d_{i-1}), d_i\}$ , there exists a right coloring  $R_{j_i}^i$  of  $\mathcal{B}_i$ . Set

$$\tilde{\sigma}_{i-2} := L_{j_{i-2}, k_{i-2}}^{i-2}, \quad \tilde{\sigma}_{i-1} := L_{j_{i-1}, k_{i-1}}^{i-1} \quad \text{and} \quad \tilde{\sigma}_i := R_{j_i}^i.$$

Lemma 14 implies that  $\tilde{\sigma}_{i-1}$ ,  $\tilde{\sigma}_i$ , and  $\tilde{\sigma}_{\text{int}}$  are compatible. Together with Observation 13, it also implies that  $\tilde{\sigma}_{i-2}$ ,  $\tilde{\sigma}_{i-1}$ , and  $\tilde{\sigma}_{\text{int}}$  are compatible. After this is defined, set  $i := i - 3$ .

Let us now describe the flow of the algorithm. The algorithm starts with  $i := g - 1$ . Suppose first that no superedge  $\mathcal{B}_i$  of  $\tilde{G}$  is dock-right. If  $g$  is even, apply **Procedure P2** repeatedly until  $i = -1$  is reached, and then the algorithm ends. If  $g$  is odd, apply **Procedure P2** until  $i = 2$ . Then apply **Procedure P3** once for the pair  $\mathcal{B}_1$  and  $\mathcal{B}_0$ , which gives  $i = -1$  at the end.

Suppose now that there exists a superedge  $\mathcal{B}_s$  in  $\tilde{G}$  which is dock-right. Without loss of generality, we may assume  $s = 0$ . While  $i \geq 3$ , if  $\mathcal{B}_i$  is dock-right, apply **Procedure P1**. If  $\mathcal{B}_i$  is not dock-right, apply **Procedure P2**. Since  $i$  is decreased by at most 2 in **Procedures P1** and **P2**, the execution will stop with the output  $i \in \{1, 2\}$ . The algorithm concludes in the following way:

- If  $i = 2$  and  $\mathcal{B}_2$  is not dock-right, apply **Procedure P3** once.
- If  $i = 2$  and both  $\mathcal{B}_2$  and  $\mathcal{B}_1$  are dock-right, apply **Procedure P1** three times.
- If  $i = 2$  and  $\mathcal{B}_2$  is dock-right and  $\mathcal{B}_1$  is not dock-right, apply first **Procedure P1** and then **Procedure P2**.
- If  $i = 1$  and  $\mathcal{B}_1$  is dock-right, apply **Procedure P1** twice.
- If  $i = 1$  and  $\mathcal{B}_1$  is not dock-right, apply **Procedure P2** once.

In each of the above possibilities, the algorithm ends with  $i = -1$ . This means that the algorithm has constructed  $\tilde{\sigma}_i$  for every  $i = 0, \dots, g - 1$ . Let  $Z$  denote the set of indices  $i$  which were inputs for **Procedures P1**, **P2** and **P3** in the execution of the algorithm.

It remains to establish that  $\tilde{\sigma}_i$  and  $\tilde{\sigma}_{i+1}$  are compatible for every  $i \in Z$ . Notice that  $\tilde{\sigma}_i = R_{j_i}^i$  for some  $j_i \in \{1, 2, 3\}$ , and also  $\tilde{\sigma}_{i+1} = R_{d_{i+1}}^{i+1}$  or  $\tilde{\sigma}_{i+1} = L_{d_{i+1}, k}^{i+1}$  for some

$k \in \{1, 2, 3\}$ . In either case, Observation 13 implies that  $\tilde{\sigma}_{i+1}$  is on the left side of  $\mathcal{B}_{i+1}$ , consistent with  $R_{d_{i+1}}^{i+1}$ . Thus,  $\tilde{\sigma}_i$  and  $\tilde{\sigma}_{i+1}$  are compatible by Claim 1 of Theorem 10.

**Case 2:**  $\mathcal{A}_i = A'$  for some  $i \in \{0, \dots, g-1\}$ . Let  $I$  denote the set of all indices  $i$  such that  $\mathcal{A}_i = A'$  in  $\tilde{G}$ , hence  $I \neq \emptyset$ . Denote by  $\tilde{G}^A$  a corresponding superposition obtained from  $\tilde{G}$  by setting  $\mathcal{A}_i = A$  for every  $i \in I$ . Let  $\tilde{\sigma}^A$  be a normal 5-edge-coloring of  $\tilde{G}^A$  constructed as in Case 1. Denote by  $K$  the set of all indices  $i$  such that  $i-1$  is an output of Steps 1, 2, or 3 in the execution of the algorithm of Case 1.

Notice that indices  $i$  of  $K$  represent the leftmost superedge  $\mathcal{B}_i$  of each "chunk" of superedges considered together in the algorithm. Thus, for every  $i \in K$  from the procedures of the algorithm, it follows that  $\tilde{\sigma}_i^A = R_{d_i}^i$  or  $\tilde{\sigma}_i^A = L_{d_i, k_i}^i$ . This means the index  $j_i$  of the corresponding right or left coloring of  $\mathcal{B}_i$  is equal to the dock  $d_i$ . This also implies that the two non-dock left semiedges of  $\mathcal{B}_i$  are connected by a Kempe chain  $P^l$ . Recall from Figure 1 that a supervertex  $\mathcal{A}_i = A$  has two isolated edges, which connect to the pair of non-dock left semiedges of  $\mathcal{B}_i$ . In the case of  $i \in K$ , it also holds that these two isolated edges are colored by the same color in  $\tilde{\sigma}^A$ , as illustrated by  $\mathcal{A}_{i-1}$  in Figure 11 and  $\mathcal{A}_{i-2}$  in Figure 12.

Let  $T = \{0, \dots, g-1\} \setminus K$ , i.e.  $T$  denotes the set of all indices not included in  $K$ . Notice that for every  $i \in T$ , the two isolated edges of  $\mathcal{A}_i = A$  are colored by different colors in  $\tilde{\sigma}^A$ , see  $\mathcal{A}_i$  in Figure 11 and  $\mathcal{A}_{i-1}$ ,  $\mathcal{A}_i$  in Figure 12 for illustration. Also, it holds that the Kempe chain  $P^l$  of  $\mathcal{B}_i$  does not connect the two non-dock vertices. Instead, it connects a dock semiedge with one of the remaining non-dock semiedge. This means that in the case of  $i \in T$ , the Kempe chain will not be of use to us, and instead we use the notion of a twist defined in what follows.

Let  $j_1$  and  $j_2$  be the two distinct indices such that  $\{1, 2, 3\} \setminus \{d_i\} = \{j_1, j_2\}$ . Notice that  $\tilde{G}^A$  contains edges  $w_{j_1} z_{j_1}^-$  and  $w_{j_2} z_{j_2}^-$ . If, in a superposition  $\tilde{G}^A$ , the edges  $w_{j_1} z_{j_1}^-$  and  $w_{j_2} z_{j_2}^-$  are replaced by  $w_{j_1} z_{j_2}^-$  and  $w_{j_2} z_{j_1}^-$ , this is called *twisting*  $\mathcal{A}_i$  in  $\tilde{G}^A$ . For a subset of indices  $X \subseteq \{0, 1, \dots, g-1\}$ , we define the graph  $\tilde{G}^{A,X}$  as the superposition obtained from  $\tilde{G}^A$  by twisting  $\mathcal{A}_i$  for every  $i \in X$ . Let  $\mathcal{G}^A$  denote the family of superpositions obtained from  $\tilde{G}^A$ , which is defined by

$$\mathcal{G}^A = \{\tilde{G}^{A,X} : X \subseteq \{0, 1, \dots, g-1\}\}.$$

Since twisting does not influence the dock edge of any  $\mathcal{B}_i$ , the algorithm of Case 1 will have the same set  $K$  for every  $\tilde{G}^{A,X} \in \mathcal{G}^A$ . Therefore, the "chunks" of superedges considered together will be the same for each  $\tilde{G}^{A,X}$  from  $\mathcal{G}^A$ .

Let  $\tilde{G}^{A,T} \in \mathcal{G}^A$  be the superposition obtained from  $\tilde{G}^A$  by twisting  $\mathcal{A}_i$  for every  $i \in T$ . Let  $\tilde{\sigma}^{A,T}$  be a normal 5-edge-coloring of  $\tilde{G}^{A,T}$  obtained by the algorithm from Case 1. Recall that  $I$  denotes the set of all indices  $i$  such that  $\mathcal{A}_i = A'$  in  $\tilde{G}$ . Let us denote  $I^K = I \cap K$  and  $I^T = I \cap T$ . We now use  $\tilde{\sigma}^{A,T}$  to construct a normal 5-edge-coloring  $\tilde{\sigma}$  of  $\tilde{G}$  in the following way. First, we define  $\tilde{\sigma}_i$  of  $\mathcal{B}_i$  by slightly modifying  $\tilde{\sigma}^{A,T}$ , where it is important that in the modification the color scheme of the right connector of  $\mathcal{B}_i$  remains the same. Then we establish the compatibility of the consecutive  $\tilde{\sigma}_i$ 's with  $\tilde{\sigma}_{\text{int}}$ . In order to do this, we distinguish the following three cases.

**Subcase 2.a:**  $i \in I^K$ . In this case,  $\tilde{\sigma}_i^{A,T} = R_{d_i}^i$  or  $\tilde{\sigma}_i^{A,T} = L_{d_i, k}^i$ , i.e.,  $j_i = d_i$ . The two isolated edges of  $\mathcal{A}_i = A$  within  $\tilde{G}^{A,T}$  are colored with the same color in  $\tilde{\sigma}_i^{A,T}$ .

Consequently, the corresponding pair of left semiedges of  $\mathcal{B}_i$  are connected by a Kempe chain  $P^l$ . This is illustrated by the coloring of  $\mathcal{A}_{i-1}$  from Figure 11, since there it holds that  $i-1 \in K$ . We define a coloring  $\tilde{\sigma}_i$  of  $\mathcal{B}_i$  within  $\tilde{G}$  as a coloring obtained from  $\tilde{\sigma}_i^{A,T}$  by swapping colors along  $P^l$ . The edge  $u'_i u''_i$  within  $\tilde{G}$  also has to be colored. For that purpose, notice that the existence of Kempe chain  $P^l$  connecting a pair of vertices  $w_j$ , for  $j \neq d_i$ , ensures that  $\tilde{\sigma}_i^{A,T}(w_j)$  is the same for every  $j \neq d_i$ . We may assume  $\tilde{\sigma}_i^{A,T}(w_j) = \{t_1, t_2, t_3\}$ , where  $t_1$  and  $t_2$  are the colors along  $P^l$ . Thus, we define  $\tilde{\sigma}_i(u'_i u''_i) = t_3$ . Notice that the color scheme of the right connector of  $\mathcal{B}_i$  remains the same in  $\tilde{\sigma}_i$  as in  $\tilde{\sigma}_i^{A,T}$ .

Let us establish that  $\tilde{\sigma}_i$ ,  $\tilde{\sigma}_{i-1}$ , and  $\tilde{\sigma}_{\text{int}} = \sigma|_{M_{\text{int}}}$  are compatible in  $\tilde{G}$ , assuming that  $\tilde{\sigma}_{i-1}$  is consistent with  $\tilde{\sigma}_{i-1}^{A,T}$  on the right connector. For the sake of notation consistency,  $u'_i$  and  $u''_i$  are denoted by  $u_i^j$  if they are adjacent to  $w_j$  of  $\mathcal{B}_i$ . It is sufficient to establish properness at  $u_i^j$  and the normality of all edges incident to them. We may assume  $\tilde{\sigma}_i(s_{j_1}^l) = t_1$  for each  $j \neq d_i$ . Thus,  $\tilde{\sigma}_i(w_j) = \tilde{\sigma}_i(u_i^j) = \{t_1, t_2, t_3\}$ . Therefore,  $\tilde{\sigma}$  is proper at  $u_i^j$  and edges  $w_j u_i^j$  and  $u'_i u''_i$  are poor in  $\tilde{\sigma}$ . This also implies that an edge  $z_{j-} u_i^j$  has the same incident colors in  $\tilde{\sigma}$  as the edge  $z_{j-} w_j$  in  $\tilde{\sigma}^{A,T}$ , which implies normality.

**Subcase 2.b:**  $i \in I^T$ . Notice that in this case edges of  $\mathcal{A}_i$  are twisted in  $\tilde{G}^{A,T}$  compared to  $\tilde{G}^A$  (or  $\tilde{G}$ ). Also, recall that in this case the two isolated edges of  $\mathcal{A}_i = A$  in  $\tilde{G}^{A,T}$  are colored by two different colors, which is illustrated by the coloring of  $\mathcal{A}_i$  from Figure 11 and also by the colorings of both  $\mathcal{A}_{i-1}$  and  $\mathcal{A}_i$  from Figure 12. We define the coloring  $\tilde{\sigma}_i$  of  $\mathcal{B}_i$  within  $\tilde{G}$  by  $\tilde{\sigma}_i = \tilde{\sigma}_i^{A,T}$ . In order to define the color of the edge  $u'_i u''_i$ , let us denote by  $j_1$  and  $j_2$  the two non-dock left indices of  $\mathcal{B}_i$ . Also, let us relabel  $u'_i$  and  $u''_i$  by  $u_i^{j_1}$  and  $u_i^{j_2}$  so that  $u_i^{j_1}$  and  $w_{j_1}$  are adjacent in  $\tilde{G}$  (see Figure 7). We may assume that  $\tilde{\sigma}_i(s_{d_i}^l) = \tilde{\sigma}_i(s_{j_1}^l) \neq \tilde{\sigma}_i(s_{j_2}^l)$ . Since  $\mathcal{B}_i$  is colored by a  $\sigma$ -compatible coloring, it holds that  $\tilde{\sigma}_i(s_{j_2}^l) = \sigma(e_i)$ . This implies that  $\tilde{\sigma}_i(w_{j_2})$  contains  $\sigma(e_i)$ . Let us denote  $\tilde{\sigma}_i[s_{j_2}^l] \approx (\sigma(e_i), \{t_1, t_2\})$ .

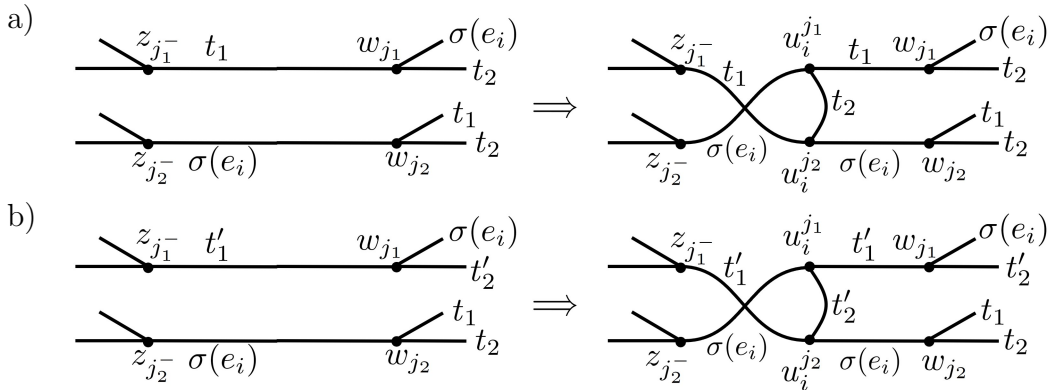

Figure 13: The figure shows the coloring  $\tilde{\sigma}_i^{A,T}$  of the superedge  $\mathcal{A}_i = A$  in  $\tilde{G}^{A,T}$  on the left, and the coloring  $\tilde{\sigma}_i$  of the twisted  $\mathcal{A}_i = A'$  in  $\tilde{G}$  on the right, where  $\tilde{\sigma}_i[s_{j_2}^l] \approx (\sigma(e_i), \{t_1, t_2\})$  and: a)  $\tilde{\sigma}_i[s_{j_1}^l] \approx (t_1, \{\sigma(e_i), t_2\})$ , b)  $\tilde{\sigma}_i[s_{j_1}^l] \approx (t'_1, \{\sigma(e_i), t'_2\})$ .

Notice that by a right or a left color scheme from Figures 5 and 9, respectively, it holds that  $\tilde{\sigma}_i[s_{j_1}^l] \approx (t_1, \{\sigma(e_i), t_2\})$ . Moreover, in the case of  $\tilde{\sigma}_i$  being a left coloring with colors along  $P^l$  replaced with the two colors not present in the scheme, it holds that

$\tilde{\sigma}_i[s_{j_1}^l] \approx (t'_1, \{\sigma(e_i), t'_2\})$ , where  $\{t'_1, t'_2\} = \{1, 2, 3, 4, 5\} \setminus \{\sigma(e_i), t_1, t_2\}$ . Now, the value of  $\tilde{\sigma}_i$  on the edge  $u_i^{j_1}u_i^{j_2}$  is defined according to the following table:

$\tilde{\sigma}_i[s_{j_2}^l]$	$\tilde{\sigma}_i[s_{j_1}^l]$	$\tilde{\sigma}_i(u_i^{j_1}u_i^{j_2})$
$(\sigma(e_i), \{t_1, t_2\})$	$(t_1, \{\sigma(e_i), t_2\})$	$t_2$
	$(t'_1, \{\sigma(e_i), t'_2\})$	$t'_2$

These two cases are illustrated by Figure 13. By carefully checking all edges incident to  $u_i^{j_1}$  and  $u_i^{j_2}$  in each of the figures, one can verify that all of them are normal by  $\tilde{\sigma}_i$ .

**Subcase 2.c:**  $i \notin I$ . Here, the coloring  $\tilde{\sigma}_i$  of  $\mathcal{B}_i$  is defined simply as  $\tilde{\sigma}_i = \tilde{\sigma}_i^{A,T}$ . In this subcase,  $\tilde{\sigma}_i$ ,  $\tilde{\sigma}_{i-1}$ , and  $\tilde{\sigma}_{\text{int}}$  are compatible in  $\tilde{G}$  since  $\tilde{\sigma}_i^{A,T}$ ,  $\tilde{\sigma}_{i-1}^{A,T}$ , and  $\tilde{\sigma}_{\text{int}}$  are compatible in  $\tilde{G}^{A,T}$ .

We are now finally in a position to define a normal 5-edge-coloring  $\tilde{\sigma}$  of  $\tilde{G}$ , and it is defined as follows:

$$\tilde{\sigma}|_{M_{\text{int}}} = \tilde{\sigma}_{\text{int}} = \sigma|_{M_{\text{int}}} \quad \text{and} \quad \tilde{\sigma}|_{\mathcal{B}_i} = \tilde{\sigma}_i$$

for  $i = 0, \dots, g-1$ , where  $\tilde{\sigma}_i$  is the coloring of  $\mathcal{B}_i$  (and the edge  $u'_i u''_i$  where needed) as in Subcases 2.a, 2.b, and 2.c. In each of the three subcases, we established that  $\tilde{\sigma}_i$ ,  $\tilde{\sigma}_{i-1}$ , and  $\tilde{\sigma}_{\text{int}}$  are compatible in  $\tilde{G}$ , so  $\tilde{\sigma}$  is a well-defined normal 5-edge-coloring of  $\tilde{G}$ . ■

Theorems 10 and 15 yield the following corollary.

**Corollary 16** *Let  $G$  be a snark with a normal 5-edge-coloring  $\sigma$ ,  $C$  an even subgraph of  $G$ , and  $\tilde{G} \in \mathcal{G}_C(\mathcal{A}, \mathcal{B})$  a superposition of  $G$ . The superposition  $\tilde{G}$  has a normal 5-edge-coloring if one of the following conditions holds:*

- i)  $\mathcal{B}_i$  is dock-right for every  $e_i \in E(C)$ ;*
- ii)  $\mathcal{B}_i$  is both doubly-right and doubly-left for every  $e_i \in E(C)$ .*

**Proof.** Since  $C$  is an even subgraph of a cubic graph, it follows that  $C$  is a collection of vertex disjoint cycles in  $G$ . Notice that a normal 5-edge-coloring  $\tilde{\sigma}$  constructed in the proofs of Theorems 10 and 15 preserves the colors of  $\sigma$  outside of the considered cycle. Thus, a coloring  $\sigma$  of  $G$  can be extended to a superposition along any vertex disjoint cycle independently. ■

## 4 Application to snarks superpositioned by Flower snarks

We will now apply sufficient conditions of Theorems 10 and 15 to snarks superpositioned by Flower snarks. Let us first define the Flower snarks. A Flower snark  $J_r$ , for  $r \geq 5$  odd, is a graph with the set of vertices  $V(J_r) = \cup_{i=0}^{r-1} \{x_i, y_i, z_i, w_i\}$  and the set of edges  $E(J_r) = \cup_{i=0}^{r-1} \{x_i x_{i+1}, x_i y_i, y_i z_i, y_i w_i, z_i w_{i+1}, w_i z_{i+1}\}$  where indices are taken modulo  $r$ . The Flower snark for  $r = 5$  is illustrated by Figure 14. We will consider a superedge  $H_{x,y}$

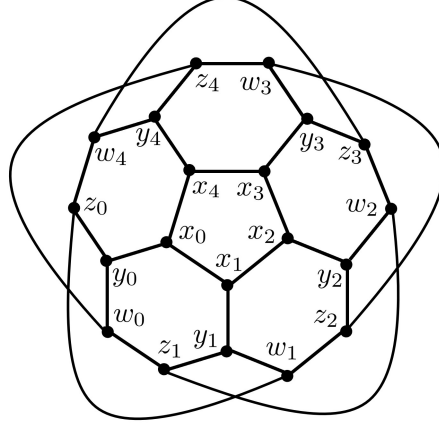

Figure 14: The Flower snark  $J_5$ .

where  $H = J_r$  and  $x, y \in V(H)$  is any pair of vertices in  $H$  at distance  $\geq 3$ . A reduction introduced in [7] makes it sufficient to consider mostly  $H = J_5$  and all pairs of vertices  $x, y$  in  $J_5$  at distance  $\geq 3$  and only a few pairs from  $J_7$ . To be more precise, the graph  $K$  shown in Figure 15 in red and its reduction is introduced by Hägglund and Steffen [7]. If  $K$  is a subgraph of a larger cubic graph  $G$ , let  $G'$  be the graph obtained from  $G$  by:

- removing vertices  $y_1$  and  $y_3$ ,
- inserting edges  $x_1x_3$ ,  $z_1z_3$ , and  $w_1w_3$ ,
- contracting triangles  $x_1x_2x_3$ ,  $z_1w_2z_3$ , and  $w_1z_2w_3$ .

Such a graph  $G'$  is called a  $K$ -reduction of  $G$ , and  $G$  is said to be  $K$ -reducible to  $G'$ . The following theorem is established in [7].

**Theorem 17** *Let  $G$  be a cubic graph that is  $K$ -reducible to a graph  $G'$ . If  $G'$  has a normal 5-edge-coloring, then  $G$  also has a normal 5-edge-coloring.*

In [7], it was also established that  $J_r$ , for  $r \geq 7$ , is  $K$ -reducible to  $J_{r-2}$ . This can be exploited in the case of a superedge  $(J_r)_{x,y}$  in the following way. Due to the symmetry of  $J_r$ , the vertex  $x$  of the pair can be chosen from  $\{x_0, y_0, z_0, w_0\}$  and the vertex  $y$  from  $\cup_{i=0}^{(r-1)/2} \{x_i, y_i, z_i, w_i\}$ , under the condition that  $x$  and  $y$  are at distance  $\geq 3$ . On the other hand, a superedge  $(J_r)_{x,y}$ , for  $r \geq 7$ , contains a subgraph  $K$  induced by vertices  $\cup_{i=r-3}^{r-1} \{x_i, y_i, z_i, w_i\}$ . More informally said, the pair  $x, y$  is always chosen in one half of the flower, and the other half contains a subgraph  $K$ . Consequently, any superposition which contains such a superedge also contains a subgraph  $K$  and it can be  $K$ -reduced. Thus, we can talk of  $K$ -reduction of a superedge  $(J_r)_{x,y}$ , for  $r \geq 7$ , to a superedge  $(J_{r-2})_{x,y}$ . Moreover, the pair  $x, y$  will remain at distance  $\geq 3$  in  $J_{r-2}$  in all cases, except for the case  $r = 7$  and only a few pairs  $(x, y)$  from it. To be more precise, we summarize all this in the following formal observation.

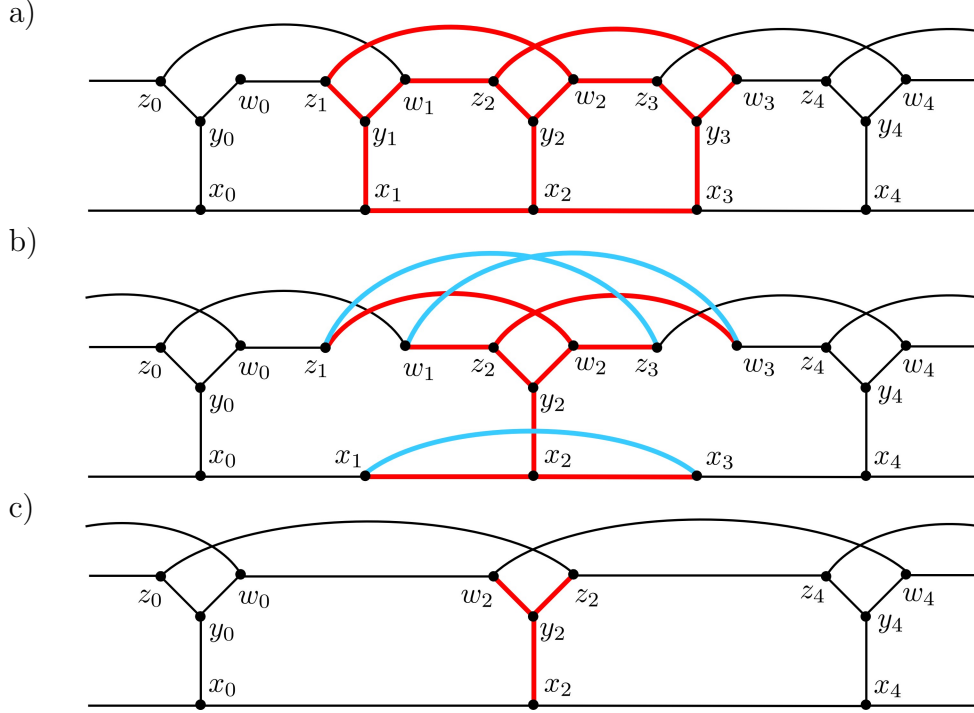

Figure 15: The figure shows: a) the graph  $K$  in red as a subgraph of a larger graph  $G$ , b)  $G$  with vertices  $y_1$  and  $y_3$  removed, and edges  $x_1x_3$ ,  $z_1z_3$ ,  $w_1w_3$  added which are the first two steps of  $K$ -reduction of  $G$ , c)  $K$ -reduced graph  $G'$  after the contraction of triangles  $x_1x_2x_3$ ,  $z_1w_2z_3$ ,  $w_1z_2w_3$  which is the third and last step of  $K$ -reduction.

**Observation 18** *Let  $J_r$  be a Flower snark for  $r \geq 7$ , and  $x, y$  a pair of vertices in  $J_r$  at distance  $\geq 3$ . A subgraph  $K$  of  $J_r$  can be chosen so that the pair  $x, y$  will remain at distance  $\geq 3$  in  $K$ -reduced  $J_{r-2}$  in all cases except in the case of  $r = 7$  and pairs  $(x, y) \in \{(x_0, x_3), (z_0, z_3), (z_3, z_0)\}$  up to a symmetry of  $J_7$ .*

Thus, to establish the existence of a normal 5-edge-coloring for superpositions by all Flower snarks it is sufficient to consider  $J_5$  and all pairs of vertices at the distance  $\geq 3$  in it, and additionally these three pairs of vertices from  $J_7$ . For the next proposition we need the notion of a 2-factor. So, a *2-factor* of a subcubic graph  $G$  is defined as any spanning 2-regular subgraph of  $G$ .

**Proposition 19** *Let  $J_5$  be a Flower snark and  $x, y$  a pair of vertices in  $J_5$  at distance  $\geq 3$ . Then, a superedge  $(J_5)_{x,y}$  is both doubly-right and doubly-left. The same holds for a superedge  $(J_7)_{x,y}$  with  $(x, y) \in \{(x_0, x_3), (z_0, z_3), (z_3, z_0)\}$ .*

**Proof.** Let us denote  $H = J_r$  and  $H' = J_r - y$ . Denote by  $x_1, x_2$  and  $x_3$  the three neighbors of  $x$  in  $H$ . A 2-factor  $F$  of  $H'$  is said to be *right-good* if it contains precisely one odd-length cycle  $C_x$  for which  $x \in V(C_x)$  and all other cycles of  $F$  are even. For example, in each of the colorings from Figure 8, edges colored by 1 and 2 induce a right-good 2-factor in  $H$ .

For each right-good  $F$ , a corresponding right coloring of  $H_{x,y}$  can be obtained in the following way. Edges of  $F$  are colored alternately by 1 and 2 so that only  $x$  is incident to a pair of edges of the same color, say color 2. All edges of  $H$  not belonging to  $F$  are colored by 3. This gives us a 3-edge-coloring  $\sigma$  of  $H$  which is neither proper nor normal. However, the restriction of  $\sigma$  to  $H_{x,y}$  is a right coloring  $R_j$ , where  $j$  denotes the left semiedge arising from the edge  $x_jx$  not contained in  $F$ . By  $F_j$  we will denote a right-good  $F$  such that  $C_x$  does not contain  $x_jx$ . To establish that  $H_{x,y}$  is doubly-left, it is sufficient to show that there exists a right-good  $F_j$  of  $H_{x,y}$  for at least two distinct values of  $j$ .

Assuming vertex notation as in Figure 16, for  $H = J_5$  this is up to symmetries done in Table 1 in Appendix, and for  $H = J_7$  in Table 2 also in Appendix. These two tables consist of four columns. The first two give the pair of vertices  $x$  and  $y$ . The third column gives the vertex  $x_j$ , and the last column gives the desired 2-factor  $F_j$  of the respective Flower snark.

To establish that  $H_{x,y}$  is doubly-left, we first introduce the following notions. Let  $y_1, y_2$  and  $y_3$  denote the neighbors of  $y$ . A 2-factor  $F$  of the snark  $H$  is said to be *left-good* if  $F$  consists of precisely two odd-length cycles  $C_x$  and  $C_y$  such that  $x \in V(C_x)$  and  $y \in V(C_y)$ , and all other cycles of  $F$  are even. For each left-good  $F$ , a corresponding left coloring of  $H_{x,y}$  can be obtained in the following way. Edges of  $F$  are colored alternately by 1 and 2 so that only  $x$  and  $y$  are incident to two edges of the same color, say  $x$  of color 1 and  $y$  of color 2. All edges of  $H$  not contained in  $F$  are colored by 3. This gives us a 3-edge-coloring  $\sigma$  of  $H$  which is neither proper nor normal. However, the restriction of  $\sigma$  to  $H_{x,y}$  is a left coloring  $L_{j,k}$ , where  $j$  denotes the left semiedge arising from the edge  $x_jx$  not contained in  $F$  and  $k$  denotes the right semiedge arising from the edge  $y_ky$  not contained in  $F$ .

By  $F_{j,k}$  we will denote a left-good  $F$  such that  $C_x$  does not contain  $x_jx$  and  $C_y$  does not contain  $y_ky$ . To establish that  $H_{x,y}$  is doubly-left, it is sufficient to show that for every  $j \in \{1, 2, 3\}$  there exists a left-good  $F_{j,k}$  for at least two distinct values of  $k$ . Assuming vertex notation as in Figure 16, for  $H = J_5$  this is done in Table 3 and for  $H = J_7$  in Table 4 in Appendix. These two tables each have five columns. The first two columns give the pair  $x$  and  $y$  in the snark. The third and the fourth columns give  $x_j$  and  $y_k$ , respectively, and the last column gives the desired 2-factor  $F_{j,k}$ . ■

The direct consequence of Proposition 19 and Corollary 16 is the following result.

**Theorem 20** *Let  $G$  be a snark which has a normal 5-edge-coloring  $\sigma$ ,  $C$  an even subgraph of  $G$ , and  $\tilde{G} \in \mathcal{G}_C(\mathcal{A}, \mathcal{B})$  a superposition of  $G$ . If  $\mathcal{B}_i \in \{(J_r)_{x,y} : x, y \in V(J_r) \text{ and } d(x, y) \geq 3\}$  for every  $e_i \in E(C)$ , then  $\tilde{G}$  has a normal 5-edge-coloring.*

Notice that according to Table 1 from Appendix, a superedge  $(J_5)_{x,y}$  is fully-right for

$$(x, y) \in \{(y_2, x_0), (y_0, y_1), (y_0, y_2), (y_0, z_2), (y_0, w_2)\}.$$

So, to establish the existence of a normal 5-edge-coloring for superpositions with such superedges, even Theorem 10 suffices. Theorem 20 implies the results of [14].



## 5 Concluding remarks

In this paper, we consider the Petersen Coloring Conjecture for a class of superpositioned snarks. Since the Petersen Coloring Conjecture is equivalent to stating that every bridgeless cubic graph has a normal 5-edge-coloring, we first introduce two sufficient conditions (in Theorems 10 and 15, respectively) for the existence of a normal 5-edge-coloring of superpositioned snarks  $G_C(\mathcal{A}, \mathcal{B})$ . These snarks are obtained from any snark  $G$  by choosing a cycle  $C$  in  $G$  and then superpositioning each vertex of  $C$  by a supervertex  $\mathcal{A}_i \in \{A, A'\}$  and each edge of  $C$  by a superedge  $\mathcal{B}_i \in \{H_{x,y} : H \text{ is a snark and } x, y \in V(H) \text{ such that } d(x, y) \geq 3\}$ . All other vertices and edges of  $G$  are superpositioned by themselves.

The sufficient condition of Theorem 10 is weaker than that of Theorem 15, but even so it applies to superpositions by infinitely many distinct snarks. For example, it applies to all hypohamiltonian snarks used as superedges but not to all possible ways of connecting them. In particular, since Flower snarks are hypohamiltonian, Theorem 10 implies that many snarks superpositioned by Flower snarks have a normal 5-edge-coloring. The condition of Theorem 15 is more demanding and thus stronger. Its application to snarks superpositioned by Flower snarks yields that all such superpositions have a normal 5-edge-coloring.

It should be noted that for Flower snark superedges, the sufficient condition of Theorem 15 is restated to involve the corresponding 2-factors, and then the existence of such 2-factors is verified in silico. An interesting question is whether the existence of the required 2-factors is due to the specific structure of Flower snarks, or the hypohamiltonian property of such snarks. In the latter case, the results of this paper would apply to all snarks superpositioned by hypohamiltonian snarks.

For a cubic graph  $G$ , let  $\text{NC}(G)$  denote the set of all normal 5-colorings of  $G$ . The Petersen Coloring Conjecture is equivalent to the claim that  $\text{NC}(G) \neq \emptyset$  for every bridgeless cubic graph  $G$ . Assuming that the Petersen Coloring Conjecture holds, i.e. that  $\text{NC}(G)$  is indeed non-empty for every bridgeless cubic graph,  $\text{poor}(G)$  is defined as the maximum number of poor edges among all colorings from  $\text{NC}(G)$ . Denote the Petersen graph by  $P_{10}$ , and by  $P_{10}^\Delta$  a graph obtained from  $P_{10}$  by replacing one vertex with a triangle. In [23], we have proposed the following conjecture.

**Conjecture 21** *Let  $G$  be a connected bridgeless cubic graph. If  $G \neq P_{10}$ , then  $\text{poor}(G) > 0$ . Moreover, if  $G \neq P_{10}, P_{10}^\Delta$ , then  $\text{poor}(G) \geq 6$ .*

The results of this paper confirm this conjecture for the class of snarks we considered. Namely, in a normal coloring constructed in the proof of Theorem 10, every superedge  $\mathcal{B}_i$  is colored by a (complementary) right coloring, and the right colorings of Flower snarks we introduced use only three colors, so each edge in a right coloring of a superedge is poor. Since a Flower snark superedge has at least 19 edges and there are at least three superedges in a superposition, the claim of Conjecture 21 follows. For a normal coloring constructed in the proof of Theorem 15, at least every other superedge is colored by a (complementary) right coloring, leading to the same conclusion. To be more precise, in each of our constructions at least  $\lfloor g/2 \rfloor \geq 1$  superedges  $\mathcal{B}_i$  of a superposition  $\tilde{G}$  are colored by  $R_j^i$  or  $\bar{R}_j^i$ , and when  $\mathcal{B}_i$  is a Flower snark superedge then all its edges are poor in both

$R_j^i$  and  $\bar{R}_j^i$ . Since every Flower snark superedge has at least 24 edges, it follows that every superposition by Flower snarks considered in this paper has at least 24 poor edges.

**Acknowledgments.** Both authors acknowledge partial support of the Slovenian research agency ARRS program P1-0383 and ARRS project J1-3002. The first author also the support of Project KK.01.1.1.02.0027, a project co-financed by the Croatian Government and the European Union through the European Regional Development Fund - the Competitiveness and Cohesion Operational Programme. The authors are also thankful to the reviewers for the careful reading of the paper and valuable suggestions.

## References

- [1] G. M. Adelson-Velskii, V. K. Titov, On edge 4-chromatic cubic graphs, *Vopr. Kibern.* **1** (1973) 5–14.
- [2] H. Bílková, Petersenové obarvení a jeho varianty, Bachelor thesis, Charles University in Prague, Prague, 2012, (in Czech).
- [3] B. Descartes, Network-colourings, *Math. Gaz.* **32** (1948) 67–69.
- [4] L. Ferrarini, G. Mazzuoccolo, V. Mkrtchyan, Normal 5-edge-colorings of a family of Loupekhine snarks, *AKCE Int. J. Graphs Comb.* **17(3)** (2020) 720–724.
- [5] M. A. Fiol, G. Mazzuoccolo, E. Steffen, Measures of edge-uncolorability of cubic graphs, *Electron. J. Comb.* **25(4)** (2018) P4.54.
- [6] S. Fiorini, Hypohamiltonian snarks, in: Graphs and Other Combinatorial Topics, Proc. 3rd Czechoslovak Symp. on Graph Theory, Prague, Aug. 24-27, 1982 (M. Fiedler, Ed.), Teubner-Texte zur Math., Bd. 59, Teubner, Leipzig, 1983, 70–75.
- [7] J. Häggglund, E. Steffen, Petersen-colorings and some families of snarks, *Ars Math. Contemp.* **7** (2014) 161–173.
- [8] R. Isaacs, Infinite families of nontrivial trivalent graphs which are not Tait colorable, *Amer. Math. Monthly* **82** (1975) 221–239.
- [9] F. Jaeger, Nowhere-zero flow problems, Selected topics in graph theory, 3, Academic Press, San Diego, CA, 1988, 71–95.
- [10] F. Jaeger, On five-edge-colorings of cubic graphs and nowhere-zero flow problems, *Ars Comb.* **20-B** (1985) 229–244.
- [11] M. Kochol, Snarks without small cycles, *J. Combin. Theory Ser. B* **67** (1996) 34–47.
- [12] M. Kochol, Superposition and constructions of graphs without nowhere-zero k-flows, *Eur. J. Comb.* **23** (2002) 281–306.

- [13] M. Kochol, A cyclically 6-edge-connected snark of order 118, *Discrete Math.* **161** (1996) 297–300.
- [14] S. Liu, R.-X. Hao, C.-Q. Zhang, Berge–Fulkerson coloring for some families of superposition snarks, *Eur. J. Comb.* **96** (2021) 103344.
- [15] E. Máčajová, M. Škoviera, Constructing Hypohamiltonian Snarks with Cyclic Connectivity 5 and 6, *Electron. J. Comb.* **14** (2007), #R18.
- [16] E. Máčajová, M. Škoviera, Superposition of snarks revisited, *Eur. J. Comb.* **91** (2021) 103220.
- [17] G. Mazzuocolo, V. Mkrтчyan, Normal edge-colorings of cubic graphs, *J. Graph Theory* **94(1)** (2020) 75–91.
- [18] G. Mazzuocolo, V. Mkrтчyan, Normal 6-edge-colorings of some bridgeless cubic graphs, *Discret. Appl. Math.* **277** (2020) 252–262.
- [19] V. Mkrтчyan, A remark on the Petersen coloring conjecture of Jaeger, *Australas. J. Comb.* **56** (2013) 145–151.
- [20] R. Nedela, M. Škoviera, Decompositions and reductions of snarks, *J. Graph Theory* **22** (1996) 253–279.
- [21] F. Pirot, J. S. Sereni, R. Škrekovski, Variations on the Petersen colouring conjecture, *Electron. J. Comb.* **27(1)** (2020) #P1.8
- [22] R. Šámal, New approach to Petersen coloring, *Electr. Notes Discrete Math.* **38** (2011) 755–760.
- [23] J. Sedlar, R. Škrekovski, Normal 5-edge-coloring of some snarks superpositioned by the Petersen graph, arXiv:2305.05981 [math.CO].

## 6 Appendix

We provide an illustration of relabeled snarks  $J_5$  and  $J_7$  in Figure 16. This labeling is more convenient for giving all the necessary 2-factors of  $J_5$  and  $J_7$  which induce right and left colorings mentioned in the proof of Proposition 19. For this labeling of snarks  $J_5$  and  $J_7$ , Table 1 has all 2-factors of the graph  $H - y$ , for  $H = J_5$ , which induce a  $j$ -right coloring of a superedge  $H_{x,y}$ . Table 2 provides the same information only for  $H = J_7$ . Tables 3 and 4 contain 2-factors of the graph  $H = J_5$  and  $H = J_7$ , respectively, which induce a  $j, k$ -left coloring of a superedge  $H_{x,y}$ .

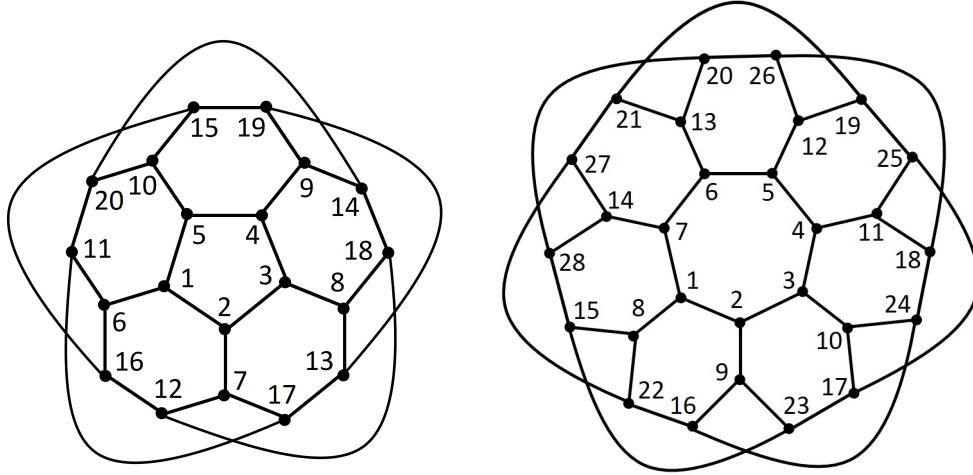

Figure 16: The Flower snarks  $J_5$  and  $J_7$  with relabeled vertices.

Table 1: A 2-factor of  $H - y$  which induces a right coloring  $R_j$  of  $H_{x,y}$  for  $H = J_5$ .

$x$	$y$	$x_j$	$F_j$
1	8	2	(1, 5, 4, 3, 2, 7, 17, 13, 19, 9, 14, 18, 12, 16, 15, 10, 20, 11, 6, 1)
1	8	6	(1, 2, 3, 4, 5, 1), (6, 11, 20, 10, 15, 16, 6), (7, 12, 18, 14, 9, 19, 13, 17, 7)
8	1	3	(2, 3, 4, 5, 10, 20, 14, 9, 19, 15, 16, 6, 11, 17, 13, 8, 18, 12, 7, 2)
8	1	13	(2, 3, 8, 18, 12, 16, 6, 11, 20, 14, 9, 4, 5, 10, 15, 19, 13, 17, 7, 2)
8	1	18	(2, 3, 8, 13, 17, 11, 6, 16, 15, 19, 9, 4, 5, 10, 20, 14, 18, 12, 7, 2)
1	12	2	(8, 13, 19, 9, 14, 18, 8), (1, 5, 4, 3, 2, 7, 17, 11, 20, 10, 15, 16, 6, 1)
1	12	6	(3, 4, 9, 14, 18, 8, 3), (1, 2, 7, 17, 13, 19, 15, 16, 6, 11, 20, 10, 5, 1)
12	1	7	(2, 3, 4, 5, 10, 15, 19, 9, 14, 20, 11, 6, 16, 12, 18, 8, 13, 17, 7, 2)
12	1	16	(2, 3, 4, 5, 10, 20, 14, 9, 19, 15, 16, 6, 11, 17, 13, 8, 18, 12, 7, 2)
1	13	5	(1, 2, 3, 8, 18, 14, 20, 10, 5, 4, 9, 19, 15, 16, 12, 7, 17, 11, 6, 1)
1	13	6	(6, 11, 17, 7, 12, 16, 6), (1, 2, 3, 8, 18, 14, 20, 10, 15, 19, 9, 4, 5, 1)
13	1	8	(2, 3, 8, 18, 12, 16, 6, 11, 20, 14, 9, 4, 5, 10, 15, 19, 13, 17, 7, 2)
13	1	19	(2, 3, 4, 5, 10, 15, 19, 9, 14, 20, 11, 6, 16, 12, 18, 8, 13, 17, 7, 2)
1	17	2	(8, 13, 19, 9, 14, 18, 8), (1, 5, 4, 3, 2, 7, 12, 16, 15, 10, 20, 11, 6, 1)
1	17	6	(3, 4, 9, 19, 13, 8, 3), (1, 2, 7, 12, 18, 14, 20, 11, 6, 16, 15, 10, 5, 1)
17	1	7	(2, 3, 4, 5, 10, 20, 14, 9, 19, 15, 16, 6, 11, 17, 13, 8, 18, 12, 7, 2)
17	1	11	(2, 3, 4, 5, 10, 15, 19, 9, 14, 20, 11, 6, 16, 12, 18, 8, 13, 17, 7, 2)
1	18	5	(1, 2, 7, 12, 16, 15, 19, 9, 14, 20, 10, 5, 4, 3, 8, 13, 17, 11, 6, 1)
1	18	6	(9, 14, 20, 10, 15, 19, 9), (1, 2, 7, 12, 16, 6, 11, 17, 13, 8, 3, 4, 5, 1)
18	1	8	(4, 5, 10, 15, 19, 9, 4), (2, 3, 8, 13, 17, 7, 2), (6, 11, 20, 14, 18, 12, 16, 6)
18	1	14	(2, 3, 8, 18, 12, 16, 6, 11, 20, 14, 9, 4, 5, 10, 15, 19, 13, 17, 7, 2)
6	7	1	(1, 2, 3, 8, 13, 17, 11, 6, 16, 12, 18, 14, 20, 10, 15, 19, 9, 4, 5, 1)
6	7	11	(1, 2, 3, 4, 5, 10, 15, 19, 9, 14, 20, 11, 17, 13, 8, 18, 12, 16, 6, 1)
6	7	16	(1, 2, 3, 4, 5, 10, 20, 14, 9, 19, 15, 16, 12, 18, 8, 13, 17, 11, 6, 1)
6	8	1	(1, 2, 3, 4, 9, 19, 13, 17, 7, 12, 18, 14, 20, 11, 6, 16, 15, 10, 5, 1)
6	8	11	(2, 3, 4, 9, 14, 18, 12, 7, 2), (1, 5, 10, 20, 11, 17, 13, 19, 15, 16, 6, 1)
6	8	16	(2, 3, 4, 9, 19, 13, 17, 7, 2), (1, 5, 10, 15, 16, 12, 18, 14, 20, 11, 6, 1)
6	13	1	(9, 14, 20, 10, 15, 19, 9), (1, 2, 7, 17, 11, 6, 16, 12, 18, 8, 3, 4, 5, 1)
6	13	11	(1, 2, 7, 17, 11, 20, 14, 9, 19, 15, 10, 5, 4, 3, 8, 18, 12, 16, 6, 1)
6	13	16	(1, 2, 3, 8, 18, 14, 20, 10, 5, 4, 9, 19, 15, 16, 12, 7, 17, 11, 6, 1)
13	6	8	(1, 2, 7, 12, 16, 15, 10, 20, 11, 17, 13, 19, 9, 14, 18, 8, 3, 4, 5, 1)
13	6	17	(1, 2, 3, 4, 9, 19, 13, 8, 18, 14, 20, 11, 17, 7, 12, 16, 15, 10, 5, 1)

6	18	1	(9, 14, 20, 10, 15, 19, 9), (1, 2, 7, 12, 16, 6, 11, 17, 13, 8, 3, 4, 5, 1)
6	18	11	(1, 2, 3, 8, 13, 19, 15, 10, 5, 4, 9, 14, 20, 11, 17, 7, 12, 16, 6, 1)
6	18	16	(1, 2, 7, 12, 16, 15, 19, 9, 14, 20, 10, 5, 4, 3, 8, 13, 17, 11, 6, 1)
18	6	8	(1, 2, 7, 17, 11, 20, 10, 15, 16, 12, 18, 14, 9, 19, 13, 8, 3, 4, 5, 1)
18	6	12	(1, 2, 3, 4, 9, 14, 18, 8, 13, 19, 15, 16, 12, 7, 17, 11, 20, 10, 5, 1)
11	12	6	(1, 5, 10, 20, 11, 17, 7, 2, 3, 4, 9, 14, 18, 8, 13, 19, 15, 16, 6, 1)
11	12	17	(3, 4, 9, 14, 18, 8, 3), (1, 2, 7, 17, 13, 19, 15, 16, 6, 11, 20, 10, 5, 1)
12	11	7	(2, 3, 8, 13, 17, 7, 2), (1, 5, 4, 9, 19, 15, 10, 20, 14, 18, 12, 16, 6, 1)
12	11	16	(1, 2, 3, 8, 13, 17, 7, 12, 18, 14, 20, 10, 5, 4, 9, 19, 15, 16, 6, 1)
11	18	6	(1, 2, 3, 8, 13, 19, 15, 10, 5, 4, 9, 14, 20, 11, 17, 7, 12, 16, 6, 1)
11	18	20	(4, 5, 10, 20, 14, 9, 4), (1, 2, 3, 8, 13, 19, 15, 16, 12, 7, 17, 11, 6, 1)
18	11	8	(2, 3, 8, 13, 17, 7, 2), (1, 5, 4, 9, 19, 15, 10, 20, 14, 18, 12, 16, 6, 1)
18	11	14	(9, 14, 20, 10, 15, 19, 9), (1, 5, 4, 3, 2, 7, 17, 13, 8, 18, 12, 16, 6, 1)
16	17	6	(1, 5, 10, 20, 11, 6, 1), (2, 3, 4, 9, 14, 18, 8, 13, 19, 15, 16, 12, 7, 2)
16	17	12	(1, 2, 7, 12, 18, 14, 9, 4, 3, 8, 13, 19, 15, 16, 6, 11, 20, 10, 5, 1)
17	16	7	(1, 5, 4, 9, 19, 15, 10, 20, 14, 18, 12, 7, 2, 3, 8, 13, 17, 11, 6, 1)
17	16	11	(4, 5, 10, 15, 19, 9, 4), (1, 2, 3, 8, 13, 17, 7, 12, 18, 14, 20, 11, 6, 1)

Table 2: A 2-factor of  $H - y$  which induces a right coloring  $R_j$  of  $H_{x,y}$  for  $H = J_7$ .

$x$	$y$	$x_j$	$F_j$
1	4	2	(2, 3, 10, 17, 23, 9, 2), (1, 7, 14, 21, 22, 16, 24, 18, 11, 25, 19, 27, 13, 6, 5, 12, 26, 20, 28, 15, 8, 1)
1	4	8	(5, 6, 13, 27, 19, 12, 5), (1, 2, 3, 10, 24, 16, 9, 23, 17, 25, 11, 18, 26, 20, 28, 15, 8, 22, 21, 14, 7, 1)
15	18	8	(12, 19, 27, 13, 20, 26, 12), (2, 3, 10, 24, 16, 9, 2), (1, 7, 6, 5, 4, 11, 25, 17, 23, 15, 28, 14, 21, 22, 8, 1)
15	18	23	(12, 19, 27, 13, 20, 26, 12), (1, 7, 6, 5, 4, 11, 25, 17, 23, 9, 2, 3, 10, 24, 16, 22, 21, 14, 28, 15, 8, 1)
18	15	11	(1, 2, 3, 10, 17, 23, 9, 16, 24, 18, 26, 12, 19, 25, 11, 4, 5, 6, 7, 14, 28, 20, 13, 27, 21, 22, 8, 1)
18	15	24	(9, 16, 24, 10, 17, 23, 9), (1, 2, 3, 4, 5, 12, 19, 25, 11, 18, 26, 20, 28, 14, 7, 6, 13, 27, 21, 22, 8, 1)

Table 3: A 2-factor of  $H$  which induces a left coloring  $L_{j,k}$  of  $H_{x,y}$  for  $H = J_5$ .

$x$	$y$	$x_j$	$y_k$	$F_{j,k}$
1	8	2	3	(1, 5, 4, 3, 2, 7, 17, 11, 6, 1), (8, 13, 19, 9, 14, 20, 10, 15, 16, 12, 18, 8)
1	8	2	13	(1, 5, 4, 9, 19, 13, 17, 11, 6, 1), (2, 3, 8, 18, 14, 20, 10, 15, 16, 12, 7, 2)
1	8	2	18	(1, 5, 4, 9, 14, 18, 12, 16, 6, 1), (2, 3, 8, 13, 19, 15, 10, 20, 11, 17, 7, 2)
1	8	5	3	(1, 2, 3, 4, 5, 10, 20, 11, 6, 1), (7, 12, 16, 15, 19, 9, 14, 18, 8, 13, 17, 7)
1	8	5	13	(3, 4, 5, 10, 15, 16, 12, 18, 8, 3), (1, 2, 7, 17, 13, 19, 9, 14, 20, 11, 6, 1)
1	8	5	18	(3, 4, 5, 10, 20, 11, 17, 13, 8, 3), (1, 2, 7, 12, 18, 14, 9, 19, 15, 16, 6, 1)
1	8	6	3	(1, 2, 3, 4, 5, 1), (6, 11, 17, 7, 12, 18, 8, 13, 19, 9, 14, 20, 10, 15, 16, 6)
1	8	6	13	(1, 2, 7, 17, 13, 19, 15, 10, 5, 1), (3, 4, 9, 14, 20, 11, 6, 16, 12, 18, 8, 3)
1	8	6	18	(1, 2, 7, 12, 18, 14, 20, 10, 5, 1), (3, 4, 9, 19, 15, 16, 6, 11, 17, 13, 8, 3)
8	1	3	2	(1, 5, 4, 3, 2, 7, 17, 11, 6, 1), (8, 13, 19, 9, 14, 20, 10, 15, 16, 12, 18, 8)
8	1	3	5	(1, 2, 3, 4, 5, 10, 20, 11, 6, 1), (7, 12, 16, 15, 19, 9, 14, 18, 8, 13, 17, 7)
8	1	3	6	(1, 2, 3, 4, 5, 1), (6, 11, 20, 10, 15, 19, 9, 14, 18, 8, 13, 17, 7, 12, 16, 6)
8	1	13	2	(1, 5, 4, 9, 19, 13, 17, 11, 6, 1), (2, 3, 8, 18, 14, 20, 10, 15, 16, 12, 7, 2)
8	1	13	5	(3, 4, 5, 10, 15, 16, 12, 18, 8, 3), (1, 2, 7, 17, 13, 19, 9, 14, 20, 11, 6, 1)
8	1	13	6	(1, 2, 7, 17, 13, 19, 15, 10, 5, 1), (3, 4, 9, 14, 20, 11, 6, 16, 12, 18, 8, 3)
8	1	18	2	(1, 5, 4, 9, 14, 18, 12, 16, 6, 1), (2, 3, 8, 13, 19, 15, 10, 20, 11, 17, 7, 2)
8	1	18	5	(3, 4, 5, 10, 20, 11, 17, 13, 8, 3), (1, 2, 7, 12, 18, 14, 9, 19, 15, 16, 6, 1)
8	1	18	6	(1, 2, 7, 12, 18, 14, 20, 10, 5, 1), (3, 4, 9, 19, 15, 16, 6, 11, 17, 13, 8, 3)
1	12	2	7	(1, 5, 4, 3, 2, 7, 17, 11, 6, 1), (8, 13, 19, 9, 14, 20, 10, 15, 16, 12, 18, 8)
1	12	2	18	(2, 3, 4, 9, 19, 15, 16, 12, 7, 2), (1, 5, 10, 20, 14, 18, 8, 13, 17, 11, 6, 1)
1	12	5	7	(9, 14, 18, 12, 16, 15, 19, 9), (1, 2, 7, 17, 13, 8, 3, 4, 5, 10, 20, 11, 6, 1)
1	12	5	16	(1, 2, 3, 4, 5, 10, 15, 16, 6, 1), (7, 12, 18, 8, 13, 19, 9, 14, 20, 11, 17, 7)
1	12	5	18	(1, 2, 3, 4, 5, 10, 20, 11, 6, 1), (7, 12, 16, 15, 19, 9, 14, 18, 8, 13, 17, 7)
1	12	6	7	(1, 2, 7, 17, 13, 8, 3, 4, 5, 1), (6, 11, 20, 10, 15, 19, 9, 14, 18, 12, 16, 6)
1	12	6	16	(1, 2, 3, 4, 5, 1), (6, 11, 17, 7, 12, 18, 8, 13, 19, 9, 14, 20, 10, 15, 16, 6)
1	12	6	18	(1, 2, 3, 4, 5, 1), (6, 11, 20, 10, 15, 19, 9, 14, 18, 8, 13, 17, 7, 12, 16, 6)
12	1	7	2	(1, 5, 4, 3, 2, 7, 17, 11, 6, 1), (8, 13, 19, 9, 14, 20, 10, 15, 16, 12, 18, 8)
12	1	7	5	(9, 14, 18, 12, 16, 15, 19, 9), (1, 2, 7, 17, 13, 8, 3, 4, 5, 10, 20, 11, 6, 1)
12	1	7	6	(1, 2, 7, 17, 13, 8, 3, 4, 5, 1), (6, 11, 20, 10, 15, 19, 9, 14, 18, 12, 16, 6)
12	1	16	5	(1, 2, 3, 4, 5, 10, 15, 16, 6, 1), (7, 12, 18, 8, 13, 19, 9, 14, 20, 11, 17, 7)
12	1	16	6	(1, 2, 3, 4, 5, 1), (6, 11, 17, 7, 12, 18, 8, 13, 19, 9, 14, 20, 10, 15, 16, 6)
12	1	18	2	(2, 3, 4, 9, 19, 15, 16, 12, 7, 2), (1, 5, 10, 20, 14, 18, 8, 13, 17, 11, 6, 1)
12	1	18	5	(1, 2, 3, 4, 5, 10, 20, 11, 6, 1), (7, 12, 16, 15, 19, 9, 14, 18, 8, 13, 17, 7)
12	1	18	6	(1, 2, 3, 4, 5, 1), (6, 11, 20, 10, 15, 19, 9, 14, 18, 8, 13, 17, 7, 12, 16, 6)
1	13	2	8	(10, 15, 19, 13, 17, 11, 20, 10), (1, 5, 4, 9, 14, 18, 8, 3, 2, 7, 12, 16, 6, 1)
1	13	2	17	(1, 5, 4, 3, 2, 7, 17, 11, 6, 1), (8, 13, 19, 9, 14, 20, 10, 15, 16, 12, 18, 8)
1	13	2	19	(1, 5, 4, 3, 2, 7, 12, 16, 6, 1), (8, 13, 17, 11, 20, 10, 15, 19, 9, 14, 18, 8)
1	13	5	8	(1, 2, 3, 8, 18, 14, 20, 11, 6, 1), (4, 5, 10, 15, 16, 12, 7, 17, 13, 19, 9, 4)
1	13	5	17	(1, 2, 3, 4, 5, 10, 15, 16, 6, 1), (7, 12, 18, 8, 13, 19, 9, 14, 20, 11, 17, 7)
1	13	5	19	(1, 2, 3, 4, 5, 10, 20, 11, 6, 1), (7, 12, 16, 15, 19, 9, 14, 18, 8, 13, 17, 7)
1	13	6	8	(1, 2, 3, 8, 18, 14, 9, 4, 5, 1), (6, 11, 20, 10, 15, 19, 13, 17, 7, 12, 16, 6)
1	13	6	17	(1, 2, 3, 4, 5, 1), (6, 11, 17, 7, 12, 18, 8, 13, 19, 9, 14, 20, 10, 15, 16, 6)
1	13	6	19	(1, 2, 3, 4, 5, 1), (6, 11, 20, 10, 15, 19, 9, 14, 18, 8, 13, 17, 7, 12, 16, 6)
13	1	8	2	(10, 15, 19, 13, 17, 11, 20, 10), (1, 5, 4, 9, 14, 18, 8, 3, 2, 7, 12, 16, 6, 1)
13	1	8	5	(7, 12, 16, 15, 19, 13, 17, 7), (1, 2, 3, 8, 18, 14, 9, 4, 5, 10, 20, 11, 6, 1)
13	1	8	6	(1, 2, 7, 12, 18, 8, 3, 4, 5, 1), (6, 11, 17, 13, 19, 9, 14, 20, 10, 15, 16, 6)
13	1	17	2	(1, 5, 4, 3, 2, 7, 17, 11, 6, 1), (8, 13, 19, 9, 14, 20, 10, 15, 16, 12, 18, 8)
13	1	17	5	(1, 2, 3, 4, 5, 10, 15, 16, 6, 1), (7, 12, 18, 8, 13, 19, 9, 14, 20, 11, 17, 7)



11	12	20	16	(1, 2, 7, 12, 18, 14, 20, 10, 5, 1), (3, 4, 9, 19, 15, 16, 6, 11, 17, 13, 8, 3)
11	12	20	18	(2, 3, 4, 9, 19, 15, 16, 12, 7, 2), (1, 5, 10, 20, 14, 18, 8, 13, 17, 11, 6, 1)
12	11	7	6	(2, 3, 4, 9, 14, 20, 11, 17, 7, 2), (1, 5, 10, 15, 19, 13, 8, 18, 12, 16, 6, 1)
12	11	7	17	(9, 14, 18, 12, 16, 15, 19, 9), (1, 2, 7, 17, 13, 8, 3, 4, 5, 10, 20, 11, 6, 1)
12	11	7	20	(1, 5, 4, 3, 2, 7, 17, 11, 6, 1), (8, 13, 19, 9, 14, 20, 10, 15, 16, 12, 18, 8)
12	11	16	6	(3, 4, 5, 10, 20, 11, 17, 13, 8, 3), (1, 2, 7, 12, 18, 14, 9, 19, 15, 16, 6, 1)
12	11	16	20	(1, 2, 7, 12, 18, 14, 20, 10, 5, 1), (3, 4, 9, 19, 15, 16, 6, 11, 17, 13, 8, 3)
12	11	18	6	(1, 5, 4, 3, 2, 7, 12, 16, 6, 1), (8, 13, 17, 11, 20, 10, 15, 19, 9, 14, 18, 8)
12	11	18	17	(1, 2, 3, 4, 5, 10, 20, 11, 6, 1), (7, 12, 16, 15, 19, 9, 14, 18, 8, 13, 17, 7)
12	11	18	20	(2, 3, 4, 9, 19, 15, 16, 12, 7, 2), (1, 5, 10, 20, 14, 18, 8, 13, 17, 11, 6, 1)
11	18	6	8	(1, 5, 4, 9, 14, 18, 12, 16, 6, 1), (2, 3, 8, 13, 19, 15, 10, 20, 11, 17, 7, 2)
11	18	6	12	(10, 15, 19, 13, 17, 11, 20, 10), (1, 5, 4, 9, 14, 18, 8, 3, 2, 7, 12, 16, 6, 1)
11	18	6	14	(2, 3, 4, 9, 14, 20, 11, 17, 7, 2), (1, 5, 10, 15, 19, 13, 8, 18, 12, 16, 6, 1)
11	18	17	8	(9, 14, 18, 12, 16, 15, 19, 9), (1, 2, 7, 17, 13, 8, 3, 4, 5, 10, 20, 11, 6, 1)
11	18	17	12	(1, 2, 3, 4, 5, 10, 20, 11, 6, 1), (7, 12, 16, 15, 19, 9, 14, 18, 8, 13, 17, 7)
11	18	17	14	(3, 4, 5, 10, 15, 16, 12, 18, 8, 3), (1, 2, 7, 17, 13, 19, 9, 14, 20, 11, 6, 1)
11	18	20	8	(10, 15, 16, 12, 18, 14, 20, 10), (1, 5, 4, 9, 19, 13, 8, 3, 2, 7, 17, 11, 6, 1)
11	18	20	12	(1, 5, 4, 9, 19, 13, 17, 11, 6, 1), (2, 3, 8, 18, 14, 20, 10, 15, 16, 12, 7, 2)
11	18	20	14	(1, 5, 4, 3, 2, 7, 17, 11, 6, 1), (8, 13, 19, 9, 14, 20, 10, 15, 16, 12, 18, 8)
18	11	8	6	(3, 4, 5, 10, 20, 11, 17, 13, 8, 3), (1, 2, 7, 12, 18, 14, 9, 19, 15, 16, 6, 1)
18	11	8	17	(9, 14, 18, 12, 16, 15, 19, 9), (1, 2, 7, 17, 13, 8, 3, 4, 5, 10, 20, 11, 6, 1)
18	11	8	20	(10, 15, 16, 12, 18, 14, 20, 10), (1, 5, 4, 9, 19, 13, 8, 3, 2, 7, 17, 11, 6, 1)
18	11	12	6	(10, 15, 19, 13, 17, 11, 20, 10), (1, 5, 4, 9, 14, 18, 8, 3, 2, 7, 12, 16, 6, 1)
18	11	12	17	(1, 2, 3, 4, 5, 10, 20, 11, 6, 1), (7, 12, 16, 15, 19, 9, 14, 18, 8, 13, 17, 7)
18	11	12	20	(1, 5, 4, 9, 19, 13, 17, 11, 6, 1), (2, 3, 8, 18, 14, 20, 10, 15, 16, 12, 7, 2)
18	11	14	6	(9, 14, 20, 11, 17, 13, 19, 9), (1, 2, 7, 12, 18, 8, 3, 4, 5, 10, 15, 16, 6, 1)
18	11	14	17	(3, 4, 5, 10, 15, 16, 12, 18, 8, 3), (1, 2, 7, 17, 13, 19, 9, 14, 20, 11, 6, 1)
18	11	14	20	(8, 13, 19, 15, 16, 12, 18, 8), (1, 5, 10, 20, 14, 9, 4, 3, 2, 7, 17, 11, 6, 1)
16	17	6	7	(2, 3, 4, 9, 19, 15, 16, 12, 7, 2), (1, 5, 10, 20, 14, 18, 8, 13, 17, 11, 6, 1)
16	17	6	11	(9, 14, 18, 12, 16, 15, 19, 9), (1, 2, 7, 17, 13, 8, 3, 4, 5, 10, 20, 11, 6, 1)
16	17	6	13	(1, 5, 4, 3, 2, 7, 17, 11, 6, 1), (8, 13, 19, 9, 14, 20, 10, 15, 16, 12, 18, 8)
16	17	12	7	(3, 4, 5, 10, 20, 11, 17, 13, 8, 3), (1, 2, 7, 12, 18, 14, 9, 19, 15, 16, 6, 1)
16	17	12	13	(1, 2, 3, 4, 5, 10, 15, 16, 6, 1), (7, 12, 18, 8, 13, 19, 9, 14, 20, 11, 17, 7)
16	17	15	7	(1, 5, 4, 3, 2, 7, 12, 16, 6, 1), (8, 13, 17, 11, 20, 10, 15, 19, 9, 14, 18, 8)
16	17	15	11	(1, 2, 7, 17, 13, 8, 3, 4, 5, 1), (6, 11, 20, 10, 15, 19, 9, 14, 18, 12, 16, 6)
16	17	15	13	(2, 3, 4, 9, 14, 20, 11, 17, 7, 2), (1, 5, 10, 15, 19, 13, 8, 18, 12, 16, 6, 1)
17	16	7	6	(2, 3, 4, 9, 19, 15, 16, 12, 7, 2), (1, 5, 10, 20, 14, 18, 8, 13, 17, 11, 6, 1)
17	16	7	12	(3, 4, 5, 10, 20, 11, 17, 13, 8, 3), (1, 2, 7, 12, 18, 14, 9, 19, 15, 16, 6, 1)
17	16	7	15	(1, 5, 4, 3, 2, 7, 12, 16, 6, 1), (8, 13, 17, 11, 20, 10, 15, 19, 9, 14, 18, 8)
17	16	11	6	(9, 14, 18, 12, 16, 15, 19, 9), (1, 2, 7, 17, 13, 8, 3, 4, 5, 10, 20, 11, 6, 1)
17	16	11	15	(1, 2, 7, 17, 13, 8, 3, 4, 5, 1), (6, 11, 20, 10, 15, 19, 9, 14, 18, 12, 16, 6)
17	16	13	6	(1, 5, 4, 3, 2, 7, 17, 11, 6, 1), (8, 13, 19, 9, 14, 20, 10, 15, 16, 12, 18, 8)
17	16	13	12	(1, 2, 3, 4, 5, 10, 15, 16, 6, 1), (7, 12, 18, 8, 13, 19, 9, 14, 20, 11, 17, 7)
17	16	13	15	(2, 3, 4, 9, 14, 20, 11, 17, 7, 2), (1, 5, 10, 15, 19, 13, 8, 18, 12, 16, 6, 1)

Table 4: A 2-factor of  $H$  which induces a left coloring  $L_{j,k}$  of  $H_{x,y}$  for  $H = J_7$ .

$x$	$y$	$x_j$	$y_k$	$F_{j,k}$
1	4	2	3	(1, 7, 14, 28, 20, 26, 12, 19, 25, 17, 23, 15, 8, 1), (2, 3, 10, 24, 18, 11, 4, 5, 6, 13, 27, 21, 22, 16, 9, 2)
1	4	2	5	(1, 7, 14, 28, 20, 26, 18, 24, 10, 17, 23, 15, 8, 1), (2, 3, 4, 11, 25, 19, 12, 5, 6, 13, 27, 21, 22, 16, 9, 2)
1	4	2	11	(2, 3, 4, 5, 6, 13, 27, 21, 22, 16, 9, 2), (1, 7, 14, 28, 20, 26, 12, 19, 25, 11, 18, 24, 10, 17, 23, 15, 8, 1)
1	4	7	3	(4, 5, 6, 7, 14, 21, 22, 16, 9, 23, 17, 25, 11, 4), (1, 2, 3, 10, 24, 18, 26, 12, 19, 27, 13, 20, 28, 15, 8, 1)
1	4	7	5	(3, 4, 11, 18, 26, 20, 13, 27, 21, 22, 16, 24, 10, 3), (1, 2, 9, 23, 17, 25, 19, 12, 5, 6, 7, 14, 28, 15, 8, 1)
1	4	7	11	(3, 4, 5, 6, 7, 14, 21, 22, 16, 24, 10, 3), (1, 2, 9, 23, 17, 25, 11, 18, 26, 12, 19, 27, 13, 20, 28, 15, 8, 1)
1	4	8	3	(1, 2, 3, 10, 17, 25, 19, 12, 26, 20, 28, 14, 7, 1), (4, 5, 6, 13, 27, 21, 22, 8, 15, 23, 9, 16, 24, 18, 11, 4)
1	4	8	5	(1, 2, 9, 16, 24, 18, 26, 20, 28, 14, 7, 1), (3, 4, 11, 25, 19, 12, 5, 6, 13, 27, 21, 22, 8, 15, 23, 17, 10, 3)
1	4	8	11	(3, 4, 5, 6, 13, 27, 21, 22, 8, 15, 23, 17, 10, 3), (1, 2, 9, 16, 24, 18, 11, 25, 19, 12, 26, 20, 28, 14, 7, 1)
15	18	8	11	(1, 2, 9, 16, 24, 18, 26, 20, 13, 27, 21, 22, 8, 1), (3, 4, 11, 25, 19, 12, 5, 6, 7, 14, 28, 15, 23, 17, 10, 3)
15	18	8	24	(5, 6, 7, 14, 28, 15, 23, 17, 25, 19, 12, 5), (1, 2, 9, 16, 24, 10, 3, 4, 11, 18, 26, 20, 13, 27, 21, 22, 8, 1)
15	18	8	26	(3, 4, 5, 6, 7, 14, 28, 15, 23, 17, 10, 3), (1, 2, 9, 16, 24, 18, 11, 25, 19, 12, 26, 20, 13, 27, 21, 22, 8, 1)
15	18	23	11	(13, 20, 26, 18, 24, 16, 22, 21, 27, 13), (1, 2, 9, 23, 17, 10, 3, 4, 11, 25, 19, 12, 5, 6, 7, 14, 28, 15, 8, 1)
15	18	23	24	(3, 4, 11, 18, 26, 20, 13, 27, 21, 22, 16, 24, 10, 3), (1, 2, 9, 23, 17, 25, 19, 12, 5, 6, 7, 14, 28, 15, 8, 1)
15	18	23	26	(11, 18, 24, 16, 22, 21, 27, 13, 20, 26, 12, 19, 25, 11), (1, 2, 9, 23, 17, 10, 3, 4, 5, 6, 7, 14, 28, 15, 8, 1)
15	18	28	11	(12, 19, 27, 13, 20, 28, 14, 21, 22, 16, 24, 18, 26, 12), (1, 7, 6, 5, 4, 11, 25, 17, 10, 3, 2, 9, 23, 15, 8, 1)
15	18	28	24	(1, 7, 6, 5, 4, 3, 2, 9, 23, 15, 8, 1), (10, 17, 25, 11, 18, 26, 12, 19, 27, 13, 20, 28, 14, 21, 22, 16, 24, 10)
15	18	28	26	(4, 5, 6, 13, 27, 21, 22, 16, 24, 18, 11, 4), (1, 7, 14, 28, 20, 26, 12, 19, 25, 17, 10, 3, 2, 9, 23, 15, 8, 1)
18	15	11	8	(1, 7, 14, 21, 27, 19, 12, 26, 18, 24, 16, 22, 8, 1), (2, 3, 10, 17, 25, 11, 4, 5, 6, 13, 20, 28, 15, 23, 9, 2)
18	15	11	23	(13, 20, 26, 18, 24, 16, 22, 21, 27, 13), (1, 2, 9, 23, 17, 10, 3, 4, 11, 25, 19, 12, 5, 6, 7, 14, 28, 15, 8, 1)
18	15	11	28	(12, 19, 27, 13, 20, 28, 14, 21, 22, 16, 24, 18, 26, 12), (1, 7, 6, 5, 4, 11, 25, 17, 10, 3, 2, 9, 23, 15, 8, 1)
18	15	24	8	(2, 3, 4, 5, 6, 13, 20, 28, 15, 23, 9, 2), (1, 7, 14, 21, 27, 19, 12, 26, 18, 11, 25, 17, 10, 24, 16, 22, 8, 1)
18	15	24	23	(3, 4, 11, 18, 26, 20, 13, 27, 21, 22, 16, 24, 10, 3), (1, 2, 9, 23, 17, 25, 19, 12, 5, 6, 7, 14, 28, 15, 8, 1)
18	15	24	28	(1, 7, 6, 5, 4, 3, 2, 9, 23, 15, 8, 1), (10, 17, 25, 11, 18, 26, 12, 19, 27, 13, 20, 28, 14, 21, 22, 16, 24, 10)
18	15	26	8	(1, 7, 6, 5, 4, 11, 18, 24, 16, 22, 8, 1), (2, 3, 10, 17, 25, 19, 12, 26, 20, 13, 27, 21, 14, 28, 15, 23, 9, 2)
18	15	26	23	(11, 18, 24, 16, 22, 21, 27, 13, 20, 26, 12, 19, 25, 11), (1, 2, 9, 23, 17, 10, 3, 4, 5, 6, 7, 14, 28, 15, 8, 1)
18	15	26	28	(4, 5, 6, 13, 27, 21, 22, 16, 24, 18, 11, 4), (1, 7, 14, 28, 20, 26, 12, 19, 25, 17, 10, 3, 2, 9, 23, 15, 8, 1)