

# BIPARTITE DETERMINANTAL IDEALS AND CONCURRENT VERTEX MAPS

LI LI

ABSTRACT. Bipartite determinantal ideals are introduced in [14] as a vast generalization of the classical determinantal ideals intensively studied in commutative algebra, algebraic geometry, representation theory and combinatorics. We introduce a combinatorial model called concurrent vertex maps to describe the Stanley-Reisner complex of the initial ideal of any bipartite determinantal ideal, and study properties and applications of this model including vertex decomposability, shelling orders, formulas of the Hilbert series and  $h$ -polynomials.

## 1. INTRODUCTION

The primary objective of this paper is to present a novel combinatorial model called “concurrent vertex maps”. This model is introduced to effectively describe the Stanley-Reisner complex of a bipartite determinantal ideal. Additionally, we use this combinatorial model to study properties of the Stanley-Reisner complex.

We begin by reviewing the classical determinantal ideals. Let  $\mathbf{k}$  be a field,  $A$  be an  $m \times n$  matrix consisting of independent variables  $x_{ij}$ ,  $r$  be a positive integer. The ideal  $I$  of  $\mathbf{k}[x_{ij}]$  generated by all  $r \times r$  minors in  $A$  is referred as a determinantal ideal. The quotient ring  $\mathbf{k}[x_{ij}]/I$  is known as a determinantal ring. Geometrically, a determinantal ideal defines an affine variety called determinantal variety, whose  $\mathbf{k}$ -points are  $m \times n$  matrices with entries in  $\mathbf{k}$  and rank at most  $r - 1$ . For example, take the case where  $m = 2, n = 3, r = 2$ . The matrix  $A$  and the determinantal ideal  $I$  are:

$$A = \begin{bmatrix} x_{11} & x_{12} & x_{13} \\ x_{21} & x_{22} & x_{33} \end{bmatrix}, \quad I = \left\langle \begin{vmatrix} x_{11} & x_{12} \\ x_{21} & x_{22} \end{vmatrix}, \begin{vmatrix} x_{11} & x_{13} \\ x_{21} & x_{23} \end{vmatrix}, \begin{vmatrix} x_{12} & x_{13} \\ x_{22} & x_{23} \end{vmatrix} \right\rangle$$

The corresponding determinantal variety consists of all  $2 \times 3$  matrices that do not have full rank. This variety is irreducible, singular, and 4-dimensional.

Determinantal ideals have been a central topic, a test field, and a source of inspiration in various areas such as commutative algebra, algebraic geometry, representation theory, and combinatorics. Researchers have extensively investigated determinantal ideals/rings, exploring topics such as minimal free resolution and syzygies (both algebraically and geometrically in terms of vector bundles), (Arithmetic) Cohen-Macaulayness, multiplicities, powers and products, Hilbert series,  $a$ -invariant,  $F$ -regularity and  $F$ -rationality, and local cohomology. The tools employed in these investigations include the Gröbner basis theory, simplicial complexes, the straightening law, the Knuth-Robinson-Schensted (KRS) correspondence,

---

2010 *Mathematics Subject Classification*. Primary 14M12; Secondary 05E40, 05E45, 13C40, 13F55, 13H10.

non-intersecting paths from algebraic combinatorics, and liaison theory from commutative algebra. Determinantal ideals/rings are closely connected to the study of Grassmannian and Schubert varieties, and there exist interesting specializations, generalizations, and variations, such as Segre varieties, linear determinantal varieties, rational normal scrolls, symmetric and skew-symmetric determinantal varieties, as well as classical, two-sided, or mixed ladder determinantal varieties. For further reading on these topics, interested readers can refer to [1, 4, 11, 17, 18, 19, 23] and the references therein.

In our previous work [14], we introduced a generalization of determinantal ideals called the bipartite determinantal ideals, and showed that the natural generators form a Gröbner basis under a suitable monomial order. Let us recall the definition and the main results.

**Definition 1.1.** (Bipartite determinantal ideal) Let  $\mathcal{Q}$  be a bipartite quiver with  $d$  vertices and the vertex set  $V_{\mathcal{Q}} = V_{\text{source}} \sqcup V_{\text{target}}$ , and with  $r$  arrows  $h_i : s(h_i) \rightarrow t(h_i)$  (for  $i = 1, \dots, r$ ) such that  $s(h_i) \in V_{\text{source}}$  and  $t(h_i) \in V_{\text{target}}$ . Let  $\mathbf{m} = (m_1, \dots, m_d)$ ,  $\mathbf{u} = (u_1, \dots, u_d)$  be two  $d$ -tuples of nonnegative integers. Let  $X = \{X^{(k)} = [x_{ij}^{(k)}]\}_{k=1}^r$  where  $X^{(k)}$  is an  $m_{t(h_k)} \times m_{s(h_k)}$  matrix consisting of independent variables. For  $\alpha \in V_{\text{target}}$  and  $\beta \in V_{\text{source}}$ , let  $r_1 < \dots < r_s$  be all the indices such that  $h_{r_1}, \dots, h_{r_s}$  are all the arrows with target  $\alpha$ , let  $r'_1 < \dots < r'_t$  be all the indices such that  $h_{r'_1}, \dots, h_{r'_t}$  are all the arrows with source  $\beta$ , and define block matrices

$$A_{\alpha} := [X^{(r_1)} | X^{(r_2)} | \dots | X^{(r_s)}], \quad A_{\beta} := \begin{bmatrix} X^{(r'_1)} \\ X^{(r'_2)} \\ \vdots \\ X^{(r'_t)} \end{bmatrix}.$$

For  $\gamma \in V_{\mathcal{Q}}$ , let  $a_{\gamma} \times b_{\gamma}$  be the size of  $A_{\gamma}$ , that is,  $(a_{\alpha}, b_{\alpha}) := (m_{\alpha}, \sum_{h: t(h)=\alpha} m_{s(h)})$  for  $\alpha \in V_{\text{target}}$ ,  $(a_{\beta}, b_{\beta}) := (\sum_{h: s(h)=\beta} m_{\alpha}, m_{t(h)})$  for  $\beta \in V_{\text{source}}$ . The *bipartite determinantal ideal*  $I_{\mathcal{Q}, \mathbf{m}, \mathbf{u}}$  is the ideal of  $\mathbf{k}[X]$  generated by  $\bigcup_{\gamma \in V_{\mathcal{Q}}} D_{u_{\gamma}+1}(A_{\gamma})$ , where  $D_{u_{\gamma}+1}(A_{\gamma})$  is the set of all  $(u_{\gamma} + 1)$ -minors of  $A_{\gamma}$ . These generators are called the *natural generators* of  $I_{\mathcal{Q}, \mathbf{m}, \mathbf{u}}$ .

As explained in [14], the bipartite determinantal ideal specializes to the classical determinantal ideal  $I_{m,n,u}^{\det}$  of  $(u+1)$ -minors in an  $m \times n$  matrix for  $\mathcal{Q} : 2 \rightarrow 1$ ,  $\mathbf{m} = (m_1, m_2) = (m, n)$ ,  $\mathbf{u} = (u_1, u_2) = (u, u)$ ; more generally, they specialize to a double determinantal ideal  $I_{m,n,u,v}^{(r)}$  for  $\mathcal{Q} : 2 \xrightarrow{r} 1$  with  $r$  arrows from 2 to 1 which we introduced in [14] and is generated by  $(u+1)$ -minors in  $A_1$  and  $(v+1)$ -minors in  $A_2$ , where

$$A_1 = [X^{(1)} | X^{(2)} | \dots | X^{(r)}], \quad A_2 = \begin{bmatrix} X^{(1)} \\ X^{(2)} \\ \vdots \\ X^{(r)} \end{bmatrix}$$

and each  $X^{(k)}$  is a variable matrix of dimension  $m \times n$ .

Define

$$v_{\alpha} := \sum_{t(h_i)=\alpha} u_{s(h_i)} \text{ for } \alpha \in V_{\text{target}}, \quad v_{\beta} := \sum_{s(h_i)=\beta} u_{t(h_i)} \text{ for } \beta \in V_{\text{source}}.$$

Without loss of generality, we assume

$$(1) \quad \forall \gamma \in V_{\mathcal{Q}} : 0 < u_{\gamma} \leq \min(a_{\gamma}, b_{\gamma}), \quad \forall \alpha \in V_{\text{target}} : u_{\alpha} \leq v_{\alpha}, \quad \forall \beta \in V_{\text{source}} : u_{\beta} \leq v_{\beta}.$$

Indeed, if  $u_{\gamma} \geq \min(a_{\gamma}, b_{\gamma})$  (resp.  $u_{\alpha} > v_{\alpha}$ ,  $u_{\beta} > v_{\beta}$ ), then we can replace  $\mu_{\gamma}$  by  $\min(a_{\gamma}, b_{\gamma})$  (resp.  $u_{\alpha}$  by  $v_{\alpha}$ ,  $u_{\beta}$  by  $v_{\beta}$ ) and  $I_{\mathcal{Q}, \mathbf{m}, \mathbf{u}}$  remains unchanged; if  $u_{\gamma} = 0$ , then let  $\mathcal{Q}'$  be the quiver obtained from  $\mathcal{Q}$  by removing the vertex  $\gamma$  and all the arrows incident to  $\gamma$ , let  $\mathbf{m}' = (m_i)_{i \neq \gamma}$ ,  $\mathbf{u}' = (u_i)_{i \neq \gamma}$ . We have  $I_{\mathcal{Q}, \mathbf{m}, \mathbf{u}} = I'_{\mathcal{Q}', \mathbf{m}', \mathbf{u}'} + \langle x_{ij}^{(k)} \in X^{(k)} \mid \text{the arrow } h_k \text{ is incident to } \gamma \rangle$  and the natural generators of  $I_{\mathcal{Q}, \mathbf{m}, \mathbf{u}}$  consists of the natural generators of  $I_{\mathcal{Q}', \mathbf{m}', \mathbf{u}'}$  together with variables  $x_{ij}^{(k)}$  where the arrow  $h_k$  is incident to  $\gamma$ . So no essential information is lost when we replace  $I_{\mathcal{Q}, \mathbf{m}, \mathbf{u}}$  by  $I_{\mathcal{Q}', \mathbf{m}', \mathbf{u}'}$ . We should point out that if  $u_{\gamma} = \min(a_{\gamma}, b_{\gamma})$ , some of the proofs in this paper need to be modified, but they always degenerate to simpler or trivial cases, so we feel it is unnecessary and redundant to explain all the modifications, and is safe to omit.

For a matrix of variables  $Y = (y_{ij})$ , we say that an order “ $>$ ” is *consistent* on  $Y$  when  $y_{ij} > y_{i,j+k}$  and  $y_{ij} > y_{i+k,j}$  for all  $i, j$ . There exists a lexicographical monomial order that is consistent on all  $A_{\gamma}$ , for example we can take the lex order “ $>$ ” such that

$$(2) \quad x_{ij}^{(r)} > x_{kl}^{(s)} \text{ if : “} r < s\text{”, or “} r = s, i < k\text{”, or “} r = s, i = k, j < l\text{”}.$$

Recall the following theorem proved in [14].

**Theorem 1.2.** [14] *Fix  $\mathcal{Q}, \mathbf{m}, \mathbf{u}$  satisfying (1). Then the set of natural generators of bipartite determinantal ideal  $I_{\mathcal{Q}, \mathbf{m}, \mathbf{u}}$ , if nonempty, forms a Gröbner basis with respect to any lexicographical monomial order that is consistent on all  $A_i$ .*

**Corollary 1.3.** *The bipartite determinantal ideals  $I_{\mathcal{Q}, \mathbf{m}, \mathbf{u}}$  are prime.*

*Proof.* It suffices to prove the statement under the assumption that  $\mathbf{k}$  is algebraically closed. By the Gröbner bases result (Theorem 1.2), the initial ideal of  $I_{\mathcal{Q}, \mathbf{m}, \mathbf{u}}$ , denoted  $\text{init}(I_{\mathcal{Q}, \mathbf{m}, \mathbf{u}})$ , is generated by the leading terms of its natural generators. Since each generator is the product of diagonal entries of a submatrix of  $A_i$  for some  $i$ , the ideal  $\text{init}(I_{\mathcal{Q}, \mathbf{m}, \mathbf{u}})$  must be a squarefree monomial, thus is radical. Therefore  $I_{\mathcal{Q}, \mathbf{m}, \mathbf{u}}$  is radical. On the other hand, there exists a nonsingular irreducible variety that maps surjectively to  $\text{Spec}(\mathbf{k}[X]/I_{\mathcal{Q}, \mathbf{m}, \mathbf{u}})$ : for example we can construct a variety similar to Nakajima’s nonsingular graded quiver variety  $\tilde{\mathcal{F}}_{v,w}$  ([15, §4]) or similar to  $\tilde{\mathcal{G}}_{v,w}$  given in [15, §6.2] (note that the construction works even if  $\mathbf{k}$  has positive characteristic). it follows that  $\text{Spec}(\mathbf{k}[X]/I_{\mathcal{Q}, \mathbf{m}, \mathbf{u}})$  is irreducible and  $I_{\mathcal{Q}, \mathbf{m}, \mathbf{u}}$  is prime.  $\square$

By Stanley-Reisner correspondence (see [17, Theorem 1.7]), there is a bijection from simplicial complexes on  $n$  vertices to squarefree monomial ideals in  $\mathbf{k}[x_1, \dots, x_n]$ , sending  $\Delta$  to

$$I_{\Delta} = \langle \mathbf{x}^{\tau} \mid \tau \notin \Delta \rangle = \bigcap_{\sigma \in \Delta} \langle x_i \mid i \notin \sigma \rangle = \bigcap_{\sigma \in \text{facets}(\Delta)} \langle x_i \mid i \notin \sigma \rangle$$

where the last one gives a minimal prime decomposition of  $I_{\Delta}$ . Let  $\Delta_{\mathcal{Q}, \mathbf{m}, \mathbf{u}}$  be the simplicial complex determined by  $I_{\mathcal{Q}, \mathbf{m}, \mathbf{u}}$  (so  $\text{init}(I_{\mathcal{Q}, \mathbf{m}, \mathbf{u}}) = I_{\Delta_{\mathcal{Q}, \mathbf{m}, \mathbf{u}}}$ ).

We will introduce a new combinatorial model, called concurrent vertex maps, as an analogue of nonintersecting lattice paths.<sup>1</sup> The precise definition is given in §2. Roughly speaking,

(a) a road map is, on each rectangular array of the size of the matrix  $A_\gamma$ , a family of nonintersecting paths  $H_p^\gamma$  (for various  $p$ ) from the left side to the right side (which we called horizontal paths), together with a family of nonintersecting paths  $V_q^\gamma$  (for various  $q$ ) from the top side to the bottom side (which we called vertical paths);

(b) a road map is called straight if each corner of a horizontal path lies in a vertical path, and each corner of a vertical path lies in a horizontal path;

(c) for a straight road map, the corresponding concurrent vertex map is the set of lattice points that are both in horizontal and vertical paths.

**Example 1.4.** Consider the bipartite determinantal ideal  $I_{\mathcal{Q}, \mathbf{m}, \mathbf{u}}$  where  $\mathcal{Q}$  is

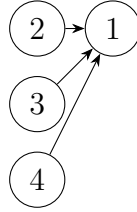

$\mathbf{m} = (3, 2, 2, 2)$ ,  $\mathbf{u} = (2, 1, 1, 1)$ . The ideal is generated by

$$\text{-- all 2 minors in } A_2 = X_1 = \begin{bmatrix} x_{11}^{(1)} & x_{12}^{(1)} \\ x_{21}^{(1)} & x_{22}^{(1)} \\ x_{31}^{(1)} & x_{32}^{(1)} \end{bmatrix}, A_3 = X_2 = \begin{bmatrix} x_{11}^{(2)} & x_{12}^{(2)} \\ x_{21}^{(2)} & x_{22}^{(2)} \\ x_{31}^{(2)} & x_{32}^{(2)} \end{bmatrix}, A_4 = X_3 = \begin{bmatrix} x_{11}^{(3)} & x_{12}^{(3)} \\ x_{21}^{(3)} & x_{22}^{(3)} \\ x_{31}^{(3)} & x_{32}^{(3)} \end{bmatrix},$$

$$\text{-- and all 3 minors in } A_1 = [X_1 \ X_2 \ X_3] = \begin{bmatrix} x_{11}^{(1)} & x_{12}^{(1)} & x_{11}^{(2)} & x_{12}^{(2)} & x_{11}^{(3)} & x_{12}^{(3)} \\ x_{21}^{(1)} & x_{22}^{(1)} & x_{21}^{(2)} & x_{22}^{(2)} & x_{21}^{(3)} & x_{22}^{(3)} \\ x_{31}^{(1)} & x_{32}^{(1)} & x_{31}^{(2)} & x_{32}^{(2)} & x_{31}^{(3)} & x_{32}^{(3)} \end{bmatrix}.$$

In Figure 1 Left, we illustrate an example of a straight road map on  $A_1$ , which consists of two

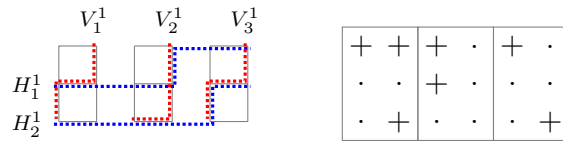

FIGURE 1. A straight road map and the corresponding concurrent vertex map.

nonintersecting horizontal paths  $H_1^1, H_2^1$  and three nonintersecting vertical paths  $V_1^1, V_2^1, V_3^1$ .

<sup>1</sup>A concurrent vertex map consists of each point that is in a common section of a horizontal path and a vertical path. The name is chosen due to its analogy with a concurrency in a road network, which refers to “an instance of one physical roadway bearing two or more different route numbers”. See Wikipedia page [https://en.wikipedia.org/wiki/Concurrency\\_\(road\)](https://en.wikipedia.org/wiki/Concurrency_(road))

It satisfies the condition that each corner of a horizontal path lies in a vertical path, and each corner of a vertical path lies in a horizontal path. Figure 1 Right is the corresponding concurrent vertex map consisting of points on both a horizontal path and a vertical path.

As we shall see in Proposition 2.5, a concurrent vertex map uniquely determines a straight road map; so there is a unique way to “connect the dots” in a concurrent vertex map to obtain the corresponding horizontal and vertical paths.

As the main results of the paper, we give a combinatorial description of  $\text{init}(I_{\mathcal{Q},\mathbf{m},\mathbf{u}})$  in Theorem 1.5 (the definitions of “ $\mathbf{u}$ -compatible” and “concurrent vertex map” are given in Definition 2.1, and the proof is given at the end of §2.3) and several properties of  $\Delta_{\mathcal{Q},\mathbf{m},\mathbf{u}}$  and  $I_{\mathcal{Q},\mathbf{m},\mathbf{u}}$  in Theorem 1.6 (proved in Proposition 3.15 and Proposition 3.18).

**Theorem 1.5.** (*Prime decomposition*) *The faces and facets of the Stanley-Reisner simplicial complex  $\Delta_{\mathcal{Q},\mathbf{m},\mathbf{u}}$  are determined as follows:*

$C \subseteq L$  is a face of  $\Delta_{\mathcal{Q},\mathbf{m},\mathbf{u}}$  if and only if  $C$  is  $\mathbf{u}$ -compatible.

$C \subseteq L$  is a facet of  $\Delta_{\mathcal{Q},\mathbf{m},\mathbf{u}}$  if and only if  $C$  is a concurrent vertex map.

Consequently,  $\text{init}(I_{\mathcal{Q},\mathbf{m},\mathbf{u}}) = \bigcap_C \langle x_{ij}^{(k)} \mid (i, j, k) \notin C \rangle$  where  $C$  runs over all concurrent vertex maps.

**Theorem 1.6.** *The Stanley-Reisner simplicial complexes  $\Delta_{\mathcal{Q},\mathbf{m},\mathbf{u}}$  are vertex decomposable (so are shellable), and homeomorphic to balls. Consequently,  $I_{\mathcal{Q},\mathbf{m},\mathbf{u}}$  is Cohen-Macaulay.*

As consequences of Theorems 1.5 and 1.6, we obtain combinatorial formulas for the Hilbert series and multiplicity of the quotient ring  $\mathbf{k}[X]/I_{\mathcal{Q},\mathbf{m},\mathbf{u}}$  (see Corollary 4.1), and recover some results on  $t$ -secant varieties by Conca, De Negri, and Stojanac [6] (see §5.2). We also obtain a combinatorially manifestly positive formula for the  $h$ -polynomial of  $\Delta_{\mathcal{Q},\mathbf{m},\mathbf{u}}$  in Corollary 4.2.

The paper is organized as follows. In §2 we introduce the notion of road maps and concurrent vertex maps. In §3 we study the combinatorial property of the simplicial complex  $\Delta_{\mathcal{Q},\mathbf{m},\mathbf{u}}$ . In §4 we provide a formula for the Hilbert series and multiplicity of the quotient ring  $\mathbf{k}[X]/I_{\mathcal{Q},\mathbf{m},\mathbf{u}}$ , and a combinatorially manifestly positive formula for the  $h$ -polynomial of  $\Delta_{\mathcal{Q},\mathbf{m},\mathbf{u}}$ . We conclude the paper with examples, algorithms, and discussions in §5. Because of their close relation with classical determinantal varieties, Nakajima’s graded quiver varieties, cluster algebras, and nonintersecting paths, we believe that the bipartite determinantal ideals and the corresponding combinatorial model will garner increased attention for further study.

We would like to point out some of the results are obtained by N. Fieldsteel and P. Klein in [7] and their unpublished preprint.

**Acknowledgments.** The author gained valuable insights from the collaborated work with Alex Yong on Kazhdan-Lusztig ideals and Schubert varieties, upon which the current work is based. He also expresses gratitude for discussions with Patricia Klein and Allen Knutson, and for valuable comments from Aldo Conca and an anonymous reader (in particular, his/her suggestion of [5, Corollary 5.1.14] which leads to the discovery of Corollary

4.2). He is very grateful to the referee for thoroughly reviewing the paper and offering numerous valuable comments and suggestions. Computer calculations were performed using Macaulay2 [10] and SageMath [20].

Data sharing not applicable to this article as no datasets were generated or analysed during the current study.

## 2. CONCURRENT VERTEX MAPS

2.1. **Notations.** First we introduce some notations:

- For  $i, j \in \mathbb{Z}$ , let  $[i, j]_{\mathbb{R}}$  be the closed interval between  $i, j$ , and let  $[i, j]_{\mathbb{Z}} = [i, j]_{\mathbb{R}} \cap \mathbb{Z}$ ; we also use similar notations for open intervals and half-open half-closed intervals.
- We think the  $r$  matrices  $X^{(1)}, \dots, X^{(r)}$  as “pages” in a “book”. The  $k$ -th page contains  $X^{(k)}$ , and we sometimes view it as a rectangle region  $\text{Page}_k := [1, m_t(h_k)]_{\mathbb{R}} \times [1, m_s(h_k)]_{\mathbb{R}}$ ; a lattice point  $(i, j)$  on  $\text{Page}_k$  corresponds to the variable  $x_{ij}^{(k)}$ . (Warning!) In this paper, we use the following (unusual) coordinate system to be consistent with the labelling of entries in a matrix:

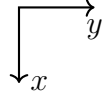

Given a matrix  $A$  and a point  $P = (i, j)$  in the lattice of integer points corresponding to  $A$ , we denote the  $x$  and  $y$  coordinates of  $P$  as  $(P)_x^A = i$ ,  $(P)_y^A = j$ . If  $A$  is clear from the context, we denote  $(P)_x^A$  as  $P_x$  and  $(P)_y^A$  as  $P_y$ .

- Define

$$L := \{(i, j, k) \in \mathbb{Z}^3 \mid 1 \leq k \leq r, (i, j) \in [1, m_t(h_k)]_{\mathbb{Z}} \times [1, m_s(h_k)]_{\mathbb{Z}}\}.$$

For  $\gamma \in V_{\mathcal{Q}}$ , define an injective map

$$\phi_{\gamma} : [1, a_{\gamma}]_{\mathbb{Z}} \times [1, b_{\gamma}]_{\mathbb{Z}} \rightarrow L, \quad (p, q) \mapsto (i, j, k) \text{ if the } (p, q)\text{-entry of } A_{\gamma} \text{ is } x_{ij}^{(k)}.$$

Note that the following two induced maps are both bijective:

$$\phi_{\text{target}} : \bigcup_{\alpha \in V_{\text{target}}} \left( \alpha, [1, a_{\alpha}]_{\mathbb{Z}} \times [1, b_{\alpha}]_{\mathbb{Z}} \right) \rightarrow L, \quad (\alpha, i, j) \mapsto \phi_{\alpha}(i, j)$$

$$\phi_{\text{source}} : \bigcup_{\beta \in V_{\text{source}}} \left( \beta, [1, a_{\beta}]_{\mathbb{Z}} \times [1, b_{\beta}]_{\mathbb{Z}} \right) \rightarrow L, \quad (\beta, i, j) \mapsto \phi_{\beta}(i, j)$$

So if  $h_k$  is an arrow  $\beta \rightarrow \alpha$ , then both  $\phi_{\alpha}^{-1}(i, j, k)$  and  $\phi_{\beta}^{-1}(i, j, k)$  are uniquely defined.

2.2. **Straight road maps.** Give a lattice point  $P \in \mathbb{Z}^2$  (note that we are not using the usual coordinate system), we say that a point  $Q = P + (i, j)$  is:

- **east** of  $P$  if  $i = 0, j > 0$  (and similarly for **west, south, north**);
- **weakly east** of  $P$  if  $i = 0, j \geq 0$  (and similarly for **weakly west/south/north**);
- **NE** of  $P$  if  $i < 0, j > 0$  (and similarly for **NW, SE, SW**);

– **weakly NE** of  $P$  if  $i \leq 0, j \geq 0$  (and similarly for **weakly NW/SE/SW**).

We define a **SW-NE path**  $P \rightsquigarrow Q$  to be a lattice path from its SW endpoint  $P$  to its NE endpoint  $Q$ , with steps either to east along vector  $(0, 1)$  or to north along vector  $(-1, 0)$ . If we reverse the orientation then we get a **NE-SW path**  $Q \rightsquigarrow P$ . By a path we mean either a SW-NE path or a NE-SW path. The length of a path refers to the number of length 1 edges in the path; a path has length 0 if its two endpoints coincide.

A **corner** of a lattice path  $H$  is a vertex  $R$  in the path that is adjacent to both a horizontal and a vertical edge of  $H$ . A corner  $R$  is called a **NW corner** of  $H$  if both points  $R + (1, 0)$  and  $R + (0, 1)$  are in  $H$ ; otherwise both  $R - (1, 0)$  and  $R - (0, 1)$  must be in  $H$ , in which case  $R$  is called a **SE corner** of  $H$ .

A collection  $\{H_i\}_{i=1}^u$  of  $u$  paths is said to be **nonintersecting** if no vertex is contained in two paths; it is said to be connecting  $(X_i)_{i=1}^u$  and  $(Y_i)_{i=1}^u$  if  $H_i$  has endpoints  $X_i$  and  $Y_i$  for each  $i$ .

The restriction of a path  $H$  to  $\text{Page}_k$  is denoted  $H|_k$ . The restriction of a point  $P$  to  $\text{Page}_k$  is denoted  $P|_k$ . Analogously, for  $C \subseteq L$ , denote  $C|_k$  the restriction of  $C$  to  $\text{Page}_k$ .

**Definition 2.1.** A **road map**  $(\{H_p^\alpha\}, \{V_q^\beta\}) = (\{H_p^\alpha\}_{\alpha \in V_{\text{target}}, 1 \leq p \leq u_\alpha}, \{V_q^\beta\}_{\beta \in V_{\text{source}}, 1 \leq q \leq u_\beta})$  of rank  $\mathbf{u}$  consists of:

- a collection of  $u_\alpha$  nonintersecting paths  $\{H_p^\alpha\}_{p=1}^{u_\alpha}$  (called horizontal paths) of  $A_\alpha$  connecting  $((a_\alpha - u_\alpha + p, 1))_{p=1}^{u_\alpha}$  and  $((p, b_\alpha))_{p=1}^{u_\alpha}$  for  $\alpha \in V_{\text{target}}$ , and
- a collection of  $u_\beta$  nonintersecting paths  $\{V_q^\beta\}_{q=1}^{u_\beta}$  (called vertical paths) of  $A_\beta$  connecting  $((1, b_\beta - u_\beta + q))_{q=1}^{u_\beta}$  and  $((a_\beta, q))_{q=1}^{u_\beta}$  for  $\beta \in V_{\text{source}}$ .

A road map is **straight** if each corner of a horizontal path lies in a vertical path, and each corner of a vertical path lies in a horizontal path.

Note that a horizontal path defined above may contain vertical edges. We say that a path is *straight horizontal* if it contains no vertical edge; a path is *straight vertical* if it contains no horizontal edge. For example, if for some  $\alpha \in V_{\text{target}}$ ,  $u_\alpha = a_\alpha$ , then the horizontal paths  $H_p^\alpha$  are straight horizontal and thus have no corners.

**Lemma 2.2.** A road map  $(\{H_p^\alpha\}, \{V_q^\beta\})$  is straight if and only if all of the following conditions hold:

(a) For each arrow  $h_k$  in  $\mathcal{Q}$ , the intersection  $H_p^{t(h_k)}|_k \cap V_q^{s(h_k)}|_k$  is a connected path  $P_{pq}^k \rightsquigarrow Q_{pq}^k$  where  $P_{pq}^k$  (resp.  $Q_{pq}^k$ ) is its SW (resp. NE) endpoint.

(b) Let  $r_1 < \dots < r_s$  be the indices such that  $h_{r_1}, \dots, h_{r_s}$  are all the arrows with target  $\alpha$ . Then  $H_p^\alpha$  is the unique path obtained by connecting the following vertices and paths from SW to NE by straight horizontal paths:  $(a_\alpha - u_\alpha + p, 1)$ ,  $P_{p,1}^{r_1} \rightsquigarrow Q_{p,1}^{r_1}$ ,  $\dots$ ,  $P_{p,u_s(h_{r_1})}^{r_1} \rightsquigarrow Q_{p,u_s(h_{r_1})}^{r_1}$ ,  $P_{p,1}^{r_2} \rightsquigarrow Q_{p,1}^{r_2}$ ,  $\dots$ ,  $P_{p,u_s(h_{r_2})}^{r_2} \rightsquigarrow Q_{p,u_s(h_{r_2})}^{r_2}$ ,  $\dots$ ,  $P_{p,1}^{r_s} \rightsquigarrow Q_{p,1}^{r_s}$ ,  $\dots$ ,  $P_{p,u_s(h_{r_s})}^{r_s} \rightsquigarrow Q_{p,u_s(h_{r_s})}^{r_s}$ ,  $(p, b_\alpha)$ . (See Figure 2.)



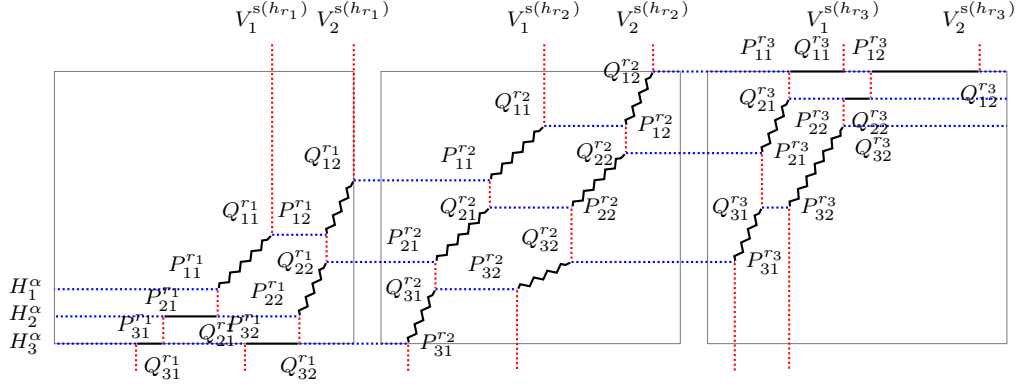

FIGURE 2. An example of  $H_p^\alpha$ 's in a straight road map

(c) Let  $r'_1 < \dots < r'_t$  be the indices such that  $h_{r'_1}, \dots, h_{r'_t}$  are all the arrows with source  $\beta$ . Then  $V_q^\beta$  is the unique path obtained by connecting the following vertices and paths from NE to SW by straight vertical paths:  $(1, b_\beta - u_\beta + q)$ ,  $Q_{1,q}^{r'_1} \rightsquigarrow P_{1,q}^{r'_1}$ ,  $\dots$ ,  $Q_{u_t(h_{r'_1}),q}^{r'_1} \rightsquigarrow P_{u_t(h_{r'_1}),q}^{r'_1}$ ,  $Q_{1,q}^{r'_2} \rightsquigarrow P_{1,q}^{r'_2}$ ,  $\dots$ ,  $Q_{u_t(h_{r'_2}),q}^{r'_2} \rightsquigarrow P_{u_t(h_{r'_2}),q}^{r'_2}$ ,  $\dots$ ,  $Q_{1,q}^{r'_t} \rightsquigarrow P_{1,q}^{r'_t}$ ,  $\dots$ ,  $Q_{u_t(h_{r'_t}),q}^{r'_t} \rightsquigarrow P_{u_t(h_{r'_t}),q}^{r'_t}$ ,  $(a_\beta, q)$ .

*Proof.* “ $\Leftarrow$ ”. Assume (a)(b)(c) are satisfied. By (b), any corner of  $H_p^\alpha$  lies in  $P_{pl}^{rk} \rightsquigarrow Q_{pl}^{rk}$  for some  $k, \ell$ , therefore lies in a vertical path. Similarly by (c), any corner of  $V_q^\beta$  lies in a horizontal path. So the road map is straight.

“ $\Rightarrow$ ”. Assume the road map is straight. We first show that (a) holds. Let  $(p, q)$  be the minimum pair in the dictionary order such that  $H_p^\alpha|_k \cap V_q^\beta|_k$  is not connected. Let  $P \rightsquigarrow Q$  and  $P' \rightsquigarrow Q'$  be the first two SW-most connected components of this intersection. Denote by  $Q \xrightarrow{H} P'$  the subpath of  $H_p^\alpha|_k$  from  $Q$  to  $P'$ ; by  $P' \xrightarrow{V} Q$  the subpath of  $V_q^\beta|_k$  from  $P'$  to  $Q$ . We consider two cases: Case 1.  $P' \xrightarrow{V} Q$  lies to the SE of  $Q \xrightarrow{H} P'$  (see Figure 3 Left). Let  $R$  be the NW corner of  $H_p^\alpha|_k$  in the interior of  $Q \xrightarrow{H} P'$  that is closest to  $Q$ . Then  $R$  lies

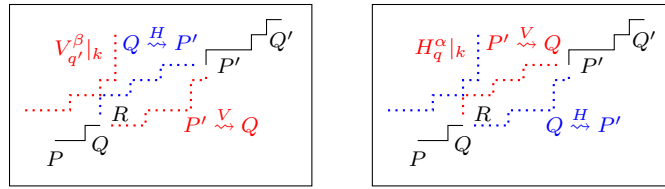

FIGURE 3. Proof of Lemma 2.2. Left: Case 1; Right: Case 2.

in  $V_{q'}^\beta|_k$  for some  $q' < q$ , and  $H_p^\alpha|_k \cap V_{q'}^\beta|_k$  is not connected, contradicting the choice of  $(p, q)$ . Case 2.  $P' \xrightarrow{V} Q$  lies to the NW of  $Q \xrightarrow{H} P'$  (see Figure 3 Right). The proof is similar to Case 1 so we skip. This proves (a). The parts (b) and (c) follow easily.  $\square$



### 2.3. Concurrent vertex maps and $\mathbf{u}$ -Compatible sets.

**Definition 2.3.** A subset  $C \subseteq L$  is called a **concurrent vertex map** if there exists a straight road map  $(\{H_p^i\}, \{V_q^j\})$  such that

$$(3) \quad C|_k = \left( \bigcup_{p=1}^{u_t(h_k)} H_p^{t(h_k)}|_k \right) \cap \left( \bigcup_{q=1}^{u_s(h_k)} V_q^{s(h_k)}|_k \right) \cap \mathbb{Z}^2, \quad \text{for } k = 1, \dots, r.$$

**Definition 2.4.** We say that a finite subset  $S \subset \mathbb{Z}^2$  is a **diagonal chain** of size  $s$  if  $S = \{(i_1, j_1), \dots, (i_s, j_s)\}$  satisfies  $i_1 < i_2 < \dots < i_s$  and  $j_1 < j_2 < \dots < j_s$ .

In the rest of the definition, fix  $C \subseteq L$ .

For each  $\alpha \in V_{\text{target}}$ , define a subset  $C^\alpha = \phi_\alpha^{-1}(C) \subseteq [1, a_\alpha]_{\mathbb{Z}} \times [1, b_\alpha]_{\mathbb{Z}}$ . For  $(i, j, k) \in \mathbb{Z}^3$ , let  $\alpha = t(h_k)$ ,  $(i, j') = \phi_\alpha^{-1}(i, j, k)$ , and define the following constants  $r_{ijk}, \bar{r}_{ijk}, \dots$  (later we may use  $r_{ijk}(C), \bar{r}_{ijk}(C), \dots$  in place of  $r_{ijk}, \bar{r}_{ijk}, \dots$  to indicate their dependence on  $C$ ; we also use  $r_P$  to denote  $r_{ijk}$  if  $P = (i, j, k)$ , and similar for others.)

$$r_{ijk} = r_{ij'}^\alpha := \text{max size of diagonal chains in } C^\alpha \text{ contained in } (-\infty, i-1]_{\mathbb{Z}} \times (-\infty, j'-1]_{\mathbb{Z}};$$

$\bar{r}_{ijk} = \bar{r}_{ij'}^\alpha := \max(r_{ijk}, \min(i-1, u_\alpha-1-\min(a_\alpha-i, b_\alpha-j')))$  = max size of diagonal chains of  $\bar{C}^\alpha := C^\alpha \cup \{(a_\alpha - u_\alpha + t, -u_\alpha + t) | 1 \leq t \leq u_\alpha\} \cup \{(t, b_\alpha - u_\alpha + t) | 1 \leq t \leq u_\alpha\}$  contained in  $(-\infty, i-1]_{\mathbb{Z}} \times (-\infty, j'-1]_{\mathbb{Z}}$ ;

$$s_{ijk} = s_{ij'}^\alpha := \text{max size of diagonal chains of } C^\alpha \text{ contained in } [i+1, \infty)_{\mathbb{Z}} \times [j'+1, \infty)_{\mathbb{Z}};$$

$\bar{s}_{ijk} = \bar{s}_{ij'}^\alpha := \max(s_{ijk}, \min(a_\alpha - i, u_\alpha - \min(i, j')))$  = max size of diagonal chains of  $C^\alpha \cup \{(a_\alpha - u_\alpha + t, t) | 1 \leq t \leq u_\alpha\} \cup \{(t, b_\alpha + t) | 1 \leq t \leq u_\alpha\}$  contained in  $[i+1, \infty)_{\mathbb{Z}} \times [j'+1, \infty)_{\mathbb{Z}}$ .

Similarly, for  $\beta \in V_{\text{source}}$ , define a subset  $C^\beta = \phi_\beta^{-1}(C) \subseteq [1, a_\beta]_{\mathbb{Z}} \times [1, b_\beta]_{\mathbb{Z}}$ . For  $(i, j, k) \in \mathbb{Z}^3$ , let  $\beta = s(h_k)$ ,  $(i', j) = \phi_\beta^{-1}(i, j, k)$ , and

$$r'_{ijk} = r'_{i'j}^\beta := \text{max size of diagonal chains in } C^\beta \text{ contained in } (-\infty, i'-1]_{\mathbb{Z}} \times (-\infty, j-1]_{\mathbb{Z}};$$

$$\bar{r}'_{ijk} = \bar{r}'_{i'j}^\beta := \max(r'_{ijk}, \min(j-1, u_\beta-1-\min(b_\beta-j, a_\beta-i')));$$

$$s'_{ijk} = s'_{i'j}^\beta := \text{max size of diagonal chains of } C^\beta \text{ contained in } [i'+1, \infty)_{\mathbb{Z}} \times [j+1, \infty)_{\mathbb{Z}};$$

$$\bar{s}'_{ijk} = \bar{s}'_{i'j}^\beta := \max(s'_{ijk}, \min(b_\beta - j, u_\beta - \min(i', j))).$$

We say that a subset  $C \subseteq L$  is  **$\mathbf{u}$ -compatible** if for each  $\gamma \in V_{\mathcal{Q}}$ ,  $C^\gamma$  does not contain any diagonal chain of size  $(u_\gamma + 1)$ . We say that  $C \subseteq L$  is **maximal  $\mathbf{u}$ -compatible** if  $C$  is  $\mathbf{u}$ -compatible and there is no  $\mathbf{u}$ -compatible  $C' \subseteq L$  satisfying  $C \subsetneq C'$ .

**Proposition 2.5.** *For  $C \subseteq L$ , the following are equivalent:*

- (i)  $C$  is a concurrent vertex map;
- (ii)  $C$  is maximal  $\mathbf{u}$ -compatible;

(iii)  $C$  is  $\mathbf{u}$ -compatible and

$$(4) \quad |C| = N_{\mathcal{Q}, \mathbf{m}, \mathbf{u}} := \sum_k u_{s(h_k)} u_{t(h_k)} + \sum_{\alpha \in V_{\text{target}}} u_{\alpha} (a_{\alpha} - u_{\alpha}) + \sum_{\beta \in V_{\text{source}}} u_{\beta} (b_{\beta} - u_{\beta})$$

(iv)  $C$  satisfies the condition that a point  $(i, j, k) \in L$  is in  $C$  if and only if  $r_{ijk} + s_{ijk} < u_{t(h_k)}$  and  $r'_{ijk} + s'_{ijk} < u_{s(h_k)}$ .

(v)  $C$  satisfies the condition that  $\bar{r}_{ijk} + \bar{s}_{ijk} \in \{u_{t(h_k)} - 1, u_{t(h_k)}\}$  and  $\bar{r}'_{ijk} + \bar{s}'_{ijk} \in \{u_{s(h_k)} - 1, u_{s(h_k)}\}$ , and  $(i, j, k) \in L$  is in  $C$  if and only if  $\bar{r}_{ijk} + \bar{s}_{ijk} = u_{t(h_k)} - 1$  and  $\bar{r}'_{ijk} + \bar{s}'_{ijk} = u_{s(h_k)} - 1$ .

Moreover, if  $C$  is a concurrent vertex map, then the corresponding road map is uniquely determined by the following conditions:

$(i, j) \in H_p^{t(h_k)}|_k$  if and only if  $\bar{r}_{ijk} = p - 1$  and  $\bar{s}_{ijk} = u_{t(h_k)} - p$ ;

$(i, j) \in V_q^{s(h_k)}|_k$  if and only if  $\bar{r}'_{ijk} = q - 1$  and  $\bar{s}'_{ijk} = u_{s(h_k)} - q$ .

Before proving the proposition, we first prove Lemmas 2.6, 2.8, 2.9.

**Lemma 2.6.** *Let  $a, b, u$  be positive integers. (See Figure 4.)*

(i) Assume  $u \leq \min(a, b)$ . Let  $X_p = (a - u + p, p)$ ,  $Y_p = (p, b - u + p)$  for  $1 \leq p \leq u$ . Let  $R_{\text{hex}} \subseteq \mathbb{R}^2$  be the closed hexagon region with vertices  $(1, 1)$ ,  $X_1$ ,  $X_u$ ,  $(a, b)$ ,  $Y_u$ ,  $Y_1$ , and let  $C \subseteq R_{\text{hex}} \cap \mathbb{Z}^2$ . Then “there exists a collection of  $u$  nonintersecting paths connecting  $(X_p)_{p=1}^u$  and  $(Y_p)_{p=1}^u$  whose union contains  $C$ ”  $\Leftrightarrow$  “all diagonal chains of  $C$  have sizes  $\leq u$ ”.

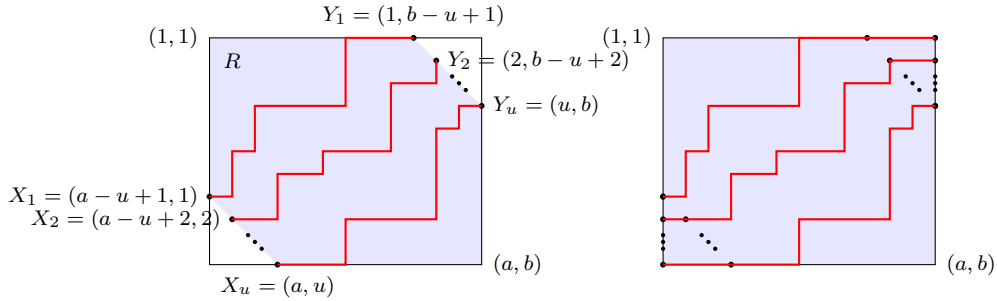

FIGURE 4. Lemma 2.6. Left is (i), the shaded hexagon region is  $R_{\text{hex}}$ ; Right is (ii).

For (ii) and (ii'), assume  $C \subseteq [1, a]_{\mathbb{Z}} \times [1, b]_{\mathbb{Z}}$ .

(ii) If  $u < a$ , then “there exists a collection of  $u$  nonintersecting paths connecting  $((a - u + p, 1))_{p=1}^u$  and  $((p, b))_{p=1}^u$  whose union contains  $C$ ”  $\Leftrightarrow$  “ $u \leq b$  and all diagonal chains of  $C$  have sizes  $\leq u$ ”. If  $u = a$ , then (regardless of  $b$ ) there exists a unique collection of  $u$  nonintersecting paths connecting  $((a - u + p, 1))_{p=1}^u$  and  $((p, b))_{p=1}^u$  whose union contains  $C$ , where each path is straight horizontal.

(ii') If  $u < b$ , then “there exists a collection of  $u$  nonintersecting paths connecting  $((1, b - u + q))_{q=1}^u$  and  $((a, q))_{q=1}^u$  whose union contains  $C$ ”  $\Leftrightarrow$  “ $u \leq a$  and all diagonal chains of

$C$  have sizes  $\leq u$ ". If  $u = b$ , then (regardless of  $a$ ) there exists a unique collection of  $u$  nonintersecting paths connecting  $((1, b - u + q))_{q=1}^u$  and  $((a, q))_{q=1}^u$  whose union contains  $C$ , where each path is straight vertical.

*Proof.* (ii) and (ii') follow easily from (i). To prove (i): " $\Rightarrow$ ": For any diagonal chain  $D \subseteq C$ , different points in  $D$  lie in different paths, thus  $|D| \leq u$ ; " $\Leftarrow$ ": assume  $C \subseteq R_{\text{hex}}$  such that all diagonal chains of  $C$  have sizes  $\leq u$ . Without loss of generality, we can further assume that  $C$  contains all  $X_p, Y_p$  for  $1 \leq p \leq u$ . Indeed, if a diagonal chain  $D$  in  $C \cup \{X_p\}$  has size  $> u$ , then it cannot contain the point  $X_p$ , otherwise  $D$  contains at most  $p - 1$  points to the NW of  $X_p$  and at most  $u - p$  points to the SE of  $X_p$  which implies  $|D| \leq (p - 1) + (u - p) + 1 = u$ .

Let  $r_{ij} := \max$  size of diagonal chains in  $C \cap ([1, i - 1] \times [1, j - 1])$  for  $i, j \in \mathbb{Z}$ . Then we get the desired nonintersecting paths by the following:

**SE-most construction:** for  $p = 1, \dots, u$ , define the path  $H_p$  to be the SE boundary of the set  $\{(i, j) \in R_{\text{hex}} : r_{ij} = p - 1\}$ , that is, a point  $(i, j) \in R_{\text{hex}}$  is in  $H_p$  if and only if " $r_{ij} = p - 1$  and  $r_{i+1, j+1} = p$ ".

Intuitively,  $H_p$  is the unique path satisfying the following: (i) it joins  $X_p$  and  $Y_p$  such that the maximal size of a diagonal chain in  $C$  to the NW of  $H_p$  is  $p - 1$ ; (ii) any other path satisfying (i) does not contain any point to the SE of  $H_p$ .  $\square$

**Remark 2.7.** Let  $s_{ij} = \max$  size of diagonal chains in  $C \cap ([i + 1, a] \times [j + 1, b])$  for  $i, j \in \mathbb{Z}$ . There is also a **NW-most construction:** for  $p = 1, \dots, u$ , define the path  $H_p$  to the NW boundary of  $\{(i, j) \in R_{\text{hex}} : s_{ij} = p - 1\}$ , that is, a point  $(i, j) \in R_{\text{hex}}$  is in  $H_p$  if and only if " $s_{ij} = p - 1$  and  $s_{i-1, j-1} = p$ ".

**Lemma 2.8.** For a subset  $C \subseteq L$ , the following are equivalent:

- (i)  $C$  is **u-compatible**;
- (ii) there exists a (not necessarily straight) road map  $(\{H_p^\alpha\}, \{V_q^\beta\})$  such that

$$(5) \quad C|_k \subseteq \left( \bigcup_{p=1}^{u_t(h_k)} H_p^{t(h_k)}|_k \right) \cap \left( \bigcup_{q=1}^{u_s(h_k)} V_q^{s(h_k)}|_k \right), \quad \text{for all } k.$$

*Proof.* (ii) $\Rightarrow$ (i): assume such a road map  $(\{H_p^\alpha\}, \{V_q^\beta\})$  exists. Then for  $\alpha \in V_{\text{target}}$ ,  $C^\alpha$  is contained in a collection of nonintersecting paths  $\{H_p^\alpha\}_{p=1}^{u_\alpha}$ , so Lemma 2.6 (ii) implies that  $C^\alpha$  does not contain any diagonal chain of size  $(u_\alpha + 1)$ ; similarly, for  $\beta \in V_{\text{source}}$ , Lemma 2.6 (ii') implies that  $C^\beta$  does not contain any diagonal chain of size  $(u_\beta + 1)$ . Thus  $C$  is **u-compatible**. (i) $\Rightarrow$ (ii): assume  $C$  is **u-compatible**. By Lemma 2.6, for  $\alpha \in V_{\text{target}}$ ,  $C^\alpha$  is contained in a collection of nonintersecting paths  $\{H_p^\alpha\}_{p=1}^{u_\alpha}$ ; for  $\beta \in V_{\text{source}}$ ,  $C^\beta$  is contained in a collection of nonintersecting paths  $\{V_q^\beta\}_{q=1}^{u_\beta}$ . This gives a desired road map  $(\{H_p^\alpha\}, \{V_q^\beta\})$ .  $\square$

**Lemma 2.9** (Straightening Lemma). Let  $u, a, b$  be positive integers,  $u \leq \min(a - 1, b)$ . Assume  $c_{pq}, d_{pq} \in [1, a]_{\mathbb{Z}}$  (for  $1 \leq p \leq u$  and  $1 \leq q \leq b$ ) satisfy the following inequalities for all  $p, q$  (whenever the inequalities make sense):  $d_{pq} \geq c_{pq}$ ,  $c_{pq} \geq d_{p, q+1}$ ,  $c_{pq} > d_{p-1, q}$ . Then there exist integers  $c'_{pq}, d'_{pq}$  ( $1 \leq p \leq u$  and  $1 \leq q \leq b$ ) satisfying

- (i)  $d'_{pq} \geq c'_{pq}$ ,  $c'_{pq} > d'_{p-1,q}$  for all  $p, q$  (whenever the inequalities make sense);
- (ii)  $c'_{pq} = d'_{p,q+1}$  for  $1 \leq p \leq u$  and  $1 \leq q \leq b-1$ ;
- (iii)  $d'_{p1} = a - u + p$  and  $c'_{pb} = p$  for  $1 \leq p \leq u$ ;
- (iv)  $\bigcup_p [c_{pq}, d_{pq}]_{\mathbb{Z}} \subseteq \bigcup_p [c'_{pq}, d'_{pq}]_{\mathbb{Z}}$  for  $q = 1, \dots, b$ ; moreover, if the “ $\subseteq$ ” is actually “ $=$ ” for all  $q$ , then  $c_{pq} = c'_{pq}$ ,  $d_{pq} = d'_{pq}$  for all  $p, q$ .

*Proof.* Define  $C := \bigcup_{p=1}^a \bigcup_{q=1}^b \{(i, q) : i \in [c_{pq}, d_{pq}]_{\mathbb{Z}}\} \subseteq [1, a]_{\mathbb{Z}} \times [1, b]_{\mathbb{Z}}$ . We claim that there exists a collection of  $u$  nonintersecting paths  $\{H_p\}_{p=1}^u$  connecting  $((a - u + p, 1))_{p=1}^u$  and  $((p, b))_{p=1}^u$  whose union contains  $C$ . Indeed, Let  $D$  be a diagonal chain of  $C$ . For every  $p \in [1, u]$ , let  $L_p$  be the broken line connecting  $(d_{p1}, 1) \rightarrow (c_{p1}, 1) \rightarrow (d_{p2}, 2) \rightarrow (c_{p2}, 2) \rightarrow \dots \rightarrow (d_{pb}, b) \rightarrow (c_{pb}, b)$ . Each  $L_p$  contains at most one point in  $D$ . Therefore  $D$  has at most  $u$  points. Then the claim follows from Lemma 2.6 (ii). Now let  $[c'_{pq}, d'_{pq}]$  be the closed interval (possibly degenerated to a point) that is the intersection of  $H_p$  and the vertical line  $y = q$ . Then obviously  $c'_{pq}, d'_{pq}$  satisfy (i)–(iv) (except the “moreover” part).

Next, we prove the “moreover” part in (iv). Consider the sum:

$$\begin{aligned} \sum_{p,q} (d_{pq} - c_{pq}) &= \sum_p \left( d_{p1} - c_{pb} - \sum_{q=1}^{b-1} (c_{pq} - d_{p,q+1}) \right) \leq \sum_p (d_{p1} - c_{pb}) \\ &\leq \left( (a - u + 1) + \dots + a \right) - \left( 1 + \dots + u \right) = (a - u)u, \end{aligned}$$

where the two equalities hold if and only if for all  $p, q$ ,  $c_{pq} = d_{p,q+1}$ ,  $d_{p1} = a - u + p$ ,  $c_{pb} = p$ . As a consequence,  $\sum_{p,q} (d'_{pq} - c'_{pq}) = (a - u)u$ . Suppose “ $\subseteq$ ” in (iv) is actually “ $=$ ” for all  $q$ , that is,

$$(6) \quad S_q := \bigcup_p [c_{pq}, d_{pq}]_{\mathbb{Z}} = \bigcup_p [c'_{pq}, d'_{pq}]_{\mathbb{Z}}.$$

So  $\sum_{p=1}^u (d_{pq} - c_{pq} + 1) = \sum_{p=1}^u (d'_{pq} - c'_{pq} + 1)$  for every  $q$ , thus  $\sum_{p,q} (d_{pq} - c_{pq}) = \sum_{p,q} (d'_{pq} - c'_{pq}) = (a - u)u$ . Then  $(\{c_{pq}\}, \{d_{pq}\})$  also satisfies (ii) and (iii). Now we prove  $c_{pq} = c'_{pq}$  and  $d_{pq} = d'_{pq}$  by induction on  $q$ : for the base case  $q = 1$ , we have  $d_{p1} = a - u + p = d'_{p1}$  for all  $p$ ;  $c_{p1} = c'_{p1} = a - u + p$  for  $p > 1$ ; taking the minimum integer on the two sides of (6) for  $q = 1$  gives  $c_{11} = c'_{11}$ . for the inductive step, let  $q \geq 2$ , assume  $c_{pq'} = c'_{pq'}$  and  $d_{pq'} = d'_{pq'}$  for  $q' < q$  and all  $p$ , we want to show that  $c_{pq} = c'_{pq}$  and  $d_{pq} = d'_{pq}$  for all  $p$ . Indeed,  $d_{pq} = c_{p,q-1} = c'_{p,q-1} = d'_{pq}$ ; taking the minimum integer on the two sides of (6) gives  $c_{1q} = c'_{1q}$ ; for  $p > 1$ ,  $c_{pq} = \min(S_q \cap [d_{p-1,q} + 1, a]) = \min(S_q \cap [c_{p-1,q-1} + 1, a]) = \min(S_q \cap [c'_{p-1,q-1} + 1, a]) = \min(S_q \cap [d'_{p-1,q} + 1, a]) = c'_{pq}$ . This completes the induction.  $\square$

Now we are ready to prove the main proposition in this section.

*Proof of Proposition 2.5.* We shall prove the statements in the following order: (i) $\Rightarrow$ (v) and “Moreover part”, (v) $\Rightarrow$ (iv) $\Rightarrow$ (ii) $\Rightarrow$ (i) $\Rightarrow$ (iii) $\Rightarrow$ (ii).

(i) $\Rightarrow$ (v) and “Moreover part”: the idea of the proof is to use the geometry of a straight road map given in Lemma 2.2, where the rectangle has been divided into curly hexagon shapes  $R_{pq}$  as illustrated in Figure 5. The proof studies two cases depending on whether the point  $(i, j') = \phi_\alpha^{-1}(i, j, k)$  lies on a horizontal path; in each case the values of  $\bar{r}_{ijk}(= \bar{r}_{ij'}^\alpha)$ ,  $\bar{s}_{ijk}(= \bar{s}_{ij'}^\alpha), \dots$  are explicitly determined and the proof follows.

Let  $C$  be a concurrent vertex map. By definition, there exists a straight road map  $(\{H_p^\alpha\}, \{V_q^\beta\})$  satisfying (3). Fix  $\alpha \in V_{\text{target}}$ . For convenience, denote

$$(7) \quad \begin{aligned} &V_1^{s(h_{r_1})}, V_2^{s(h_{r_1})}, \dots, V_{u_s(h_{r_1})}^{s(h_{r_1})}, V_1^{s(h_{r_2})}, V_2^{s(h_{r_2})}, \dots, V_{u_s(h_{r_2})}^{s(h_{r_2})}, V_1^{s(h_{r_s})}, V_2^{s(h_{r_s})}, \dots, V_{u_s(h_{r_s})}^{s(h_{r_s})} \\ &\text{as } V_1^\alpha, V_2^\alpha, \dots, V_{v_\alpha}^\alpha \end{aligned}$$

in that order, where  $r_1 < \dots < r_s$  are all indices such that  $h_{r_1}, \dots, h_{r_s}$  are all arrows with target  $\alpha$ . We also denote  $V_q^\alpha$  to be the vertical line  $y = q$  for  $q \leq 0$ .

$$(8) \quad \text{Denote } P_{pq} \rightsquigarrow Q_{pq} \text{ to be the subpath } H_p^\alpha \cap V_q^\alpha.$$

(See Figure 5 and compare the labeling therein with the original labeling in Figure 2.) Note that the region  $[1, a_\alpha]_{\mathbb{R}} \times (-\infty, b_\alpha]_{\mathbb{R}}$  has been divided into regions  $R_{pq}$  bounded by  $H_p^\alpha, H_{p+1}^\alpha, V_q^\alpha, V_{q+1}^\alpha$  for  $0 \leq p \leq u_\alpha$  and  $q \leq v_\alpha$ . So in general  $R_{pq}$  has a “curly hexagon” shape with boundary  $P_{pq}Q_{pq}P_{p,q+1}Q_{p+1,q+1}P_{p+1,q+1}Q_{p+1,q}$ , and has degenerate shape in the obvious sense for  $p = 0$  or  $p = u_\alpha$ , for  $q \leq 0$  or  $q = v_\alpha$ . Any point  $(i, j') \in [1, a_\alpha]_{\mathbb{Z}} \times [1, b_\alpha]_{\mathbb{Z}}$  must fall into

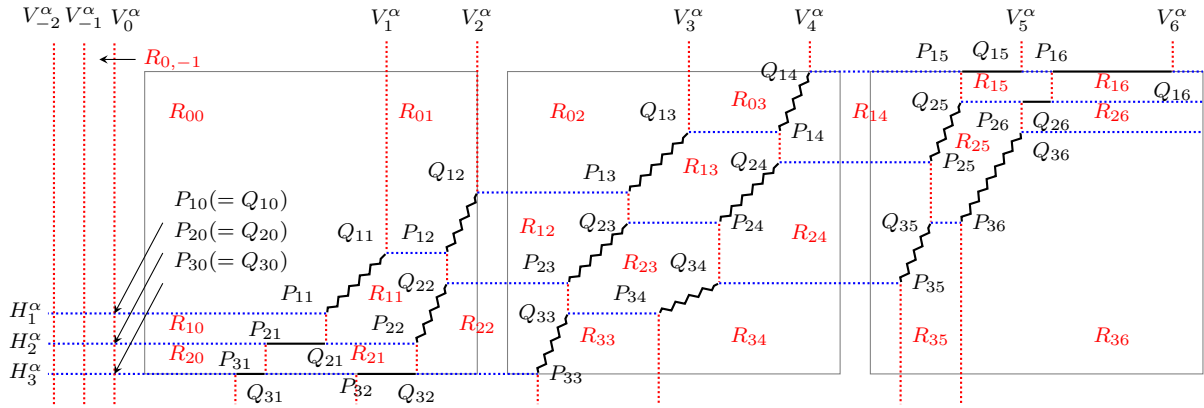

FIGURE 5. An example of the notation in (7).

one of the following two cases:

Case 1.  $(i, j')$  lies strictly between  $H_p^\alpha$  and  $H_{p+1}^\alpha$  for some  $p$ . Assume it lies in the closed region  $R_{pq}$  for some  $q$ . Recall the definition of  $\bar{C}^\alpha$  in Definition 2.4. It is clear (see Figure 5) that  $\bar{r}_{ij'}^\alpha = p$  and  $\bar{s}_{ij'}^\alpha = u_\alpha - p$ . Thus  $\bar{r}_{ij'}^\alpha + \bar{s}_{ij'}^\alpha = u_\alpha$ .

Case 2. If  $(i, j')$  lies on  $H_p^\alpha$  for some  $p$ . Then  $\bar{r}_{ij'}^\alpha = p - 1$ ,  $\bar{s}_{ij'}^\alpha = u_\alpha - p$ , thus  $\bar{r}_{ij'}^\alpha + \bar{s}_{ij'}^\alpha = u_\alpha - 1$ .

This proves that  $\bar{r}_{ijk} + \bar{s}_{ijk} = \bar{r}_{ij'}^\alpha + \bar{s}_{ij'}^\alpha = u_{t(h_k)} - 1$  or  $u_{t(h_k)}$ , and the former equality holds if and only if  $(i, j')$  (determined by  $\phi_\alpha(i, j') = (i, j, k)$ ) is on a horizontal path, that is,  $(i, j)$  is in  $\bigcup_p H_p^{t(h_k)}|_k$ .

The condition for  $V_q^{s(h_k)}|_k$  can be proved similarly. Therefore (i) implies (v) and “More-over part”.

(v) $\Rightarrow$ (iv): assume (v) holds. The idea of the proof is to use the fact that  $\bar{r}_{ijk} \geq r_{ijk}$ , and that the if  $\bar{r}_{ijk} \neq r_{ijk}$ , then we have an explicit expression of  $\bar{r}_{ijk}$ ; so we can prove (iv) on a case-by-case basis.

For the “only if” part: if  $(i, j, k) \in C$ , then  $r_{ijk} + s_{ijk} \leq \bar{r}_{ijk} + \bar{s}_{ijk} = u_{t(h_k)} - 1 < u_{t(h_k)}$ ; similarly,  $r'_{ijk} + s'_{ijk} < u_{s(h_k)}$ .

For the “if” part: we prove the contrapositive. Assuming that  $(i, j, k) \notin C$ , we need to show that it is impossible to have both  $r_{ijk} + s_{ijk} < u_{t(h_k)}$  and  $r'_{ijk} + s'_{ijk} < u_{s(h_k)}$ . Suppose both inequalities hold. By (v), we can assume  $\bar{r}_{ijk} + \bar{s}_{ijk} = u_\alpha$  (where  $\alpha = t(h_k)$ ) without loss of generality. Then either  $r_{ijk} \neq \bar{r}_{ijk}$ , or  $s_{ijk} \neq \bar{s}_{ijk}$ . Consider 3 cases:

Case 1. If  $r_{ijk} \neq \bar{r}_{ijk}$  and  $s_{ijk} = \bar{s}_{ijk}$ . Then  $\bar{r}_{ijk} = \min(i - 1, u_\alpha - 1 - \min(a_\alpha - i, b_\alpha - j')) \leq u_\alpha - 1 - \min(a_\alpha - i, b_\alpha - j')$ . On the other hand, the distance from  $(i, j')$  to the bottom (resp. right) side of the rectangle  $[1, a_\alpha]_{\mathbb{Z}} \times [1, b_\alpha]_{\mathbb{Z}}$  is  $a_\alpha - i$  (resp.  $b_\alpha - j'$ ), so  $s_{ijk} \leq \min(a_\alpha - i, b_\alpha - j')$ . Then  $\bar{r}_{ijk} + \bar{s}_{ijk} = \bar{r}_{ijk} + s_{ijk} \leq u_\alpha - 1$ , a contradiction.

Case 2. If  $r_{ijk} = \bar{r}_{ijk}$  and  $s_{ijk} \neq \bar{s}_{ijk}$ . The proof is similar to Case 1.

Case 3. If  $r_{ijk} \neq \bar{r}_{ijk}$  and  $s_{ijk} \neq \bar{s}_{ijk}$ . Then

$$(9) \quad \bar{r}_{ijk} + \bar{s}_{ijk} = \min(i - 1, u_\alpha - 1 - \min(a_\alpha - i, b_\alpha - j')) + \min(a_\alpha - i, u_\alpha - \min(i, j'))$$

We prove the contradiction that (9) is  $\neq u_\alpha$  by considering three cases separately:

If  $i \leq j'$ , then  $\bar{r}_{ijk} + \bar{s}_{ijk} \leq (i - 1) + (u_\alpha - \min(i, j')) = (i - 1) + (u_\alpha - i) = u_\alpha - 1$ ;

If  $a_\alpha - i \leq b_\alpha - j'$ , then  $\bar{r}_{ijk} + \bar{s}_{ijk} \leq (u_\alpha - 1 - (a_\alpha - i)) + (a_\alpha - i) = u_\alpha - 1$ ;

If  $i > j'$  and  $a_\alpha - i > b_\alpha - j'$ , then  $\bar{r}_{ijk} + \bar{s}_{ijk} \leq (u_\alpha - 1 - (b_\alpha - j')) + (u_\alpha - j') = 2u_\alpha - 1 - b_\alpha = u_\alpha - 1 - (b_\alpha - u_\alpha) \leq u_\alpha - 1$ , where the last inequality uses the assumption (1).

(iv) $\Rightarrow$ (ii): Assume (iv) holds. We shall first show that  $C$  is  $\mathbf{u}$ -compatible, then show that it is maximal  $\mathbf{u}$ -compatible.

To show that  $C$  is  $\mathbf{u}$ -compatible: assume for some  $\gamma \in V_{\mathcal{Q}}$  that  $C^\gamma$  contains a diagonal chain  $D$  of size  $\geq u_\gamma + 1$ , let  $(i', j')$  be the SE-most point in  $D$  and denote  $(i, j, k) = \phi_\gamma(i', j')$ . Thus  $(i, j, k) \in C$ . On the other hand,  $r_{ijk} + s_{ijk} \geq r_{ijk} \geq u_\gamma$ , which implies  $(i, j, k) \notin C$ , a contradiction.

To show that  $C$  is maximal  $\mathbf{u}$ -compatible: if  $C$  is not maximal  $\mathbf{u}$ -compatible, then there exists a  $\mathbf{u}$ -compatible  $C'$  satisfying  $C \subsetneq C' \subseteq L$ . Let  $(i, j, k) \in C' \setminus C$ . Note that  $r_{ijk}$  (resp.  $s_{ijk}, r'_{ijk}, s'_{ijk}$ ) are the same for  $C$  and  $C'$ . But then  $r_{ijk} + s_{ijk} < u_{t(h_k)}$  and  $r'_{ijk} + s'_{ijk} < u_{s(h_k)}$ , contradicting (iv).

(ii) $\Rightarrow$ (i): Assume  $C$  is maximal  $\mathbf{u}$ -compatible. The idea to show that  $C$  is a concurrent vertex map is by showing that the corresponding road map is straight; to do that, we shall verify the conditions (a)–(c) in Lemma 2.2.

By Lemma 2.8, there exists a road map  $(\{H_p^\alpha\}, \{V_q^\beta\})$  such that (5) holds; furthermore we can assume that the road map is obtained by SE-most construction. By the maximality of  $C$ , (5) becomes an equality:

$$(10) \quad C|_k = \left( \bigcup_{p=1}^{u_t(h_k)} H_p^{t(h_k)}|_k \right) \cap \left( \bigcup_{q=1}^{u_s(h_k)} V_q^{s(h_k)}|_k \right), \quad \text{for all } k.$$

It suffices to prove that  $(\{H_p^\alpha\}, \{V_q^\beta\})$  is straight; or equivalently, to prove the conditions (a)–(c) in Lemma 2.2.

To prove condition (a): assume it does not hold. The idea is that one can construct a diagonal chain  $Z_1, \dots, Z_p$  such that the  $\phi_\alpha$ -image of one of these points added to  $C$  gives a  $\mathbf{u}$ -compatible set  $C' \supsetneq C$ , contradicting the maximality of  $C$ . Below is the detail.

Similar to the proof of Lemma 2.2 (a), assume  $(p, q)$  is the minimal pair in the dictionary order such that  $H_p^\alpha|_k \cap V_q^\beta|_k$  is not connected. Let  $P \rightsquigarrow Q$  and  $P' \rightsquigarrow Q'$  be the SW-most two connected subpaths of  $H_p^\alpha|_k \cap V_q^\beta|_k$ . Without loss of generality we assume  $P' \rightsquigarrow^V Q$  lies to the SE of  $Q \rightsquigarrow^H P'$  (this is Case 1 in the Proof of Lemma 2.2). Observe that no interior lattice point of  $Q \rightsquigarrow^H P'$  is in  $C|_k$ , because if  $R$  is such a point, then  $R$  lies in some  $V_{q'}^\beta$  with  $q' < q$ , and thus  $(p, q') < (p, q)$  and  $H_p^\alpha|_k \cap V_{q'}^\beta|_k$  is not connected, contradicting the choice of  $(p, q)$ .

Now focus on  $A_\alpha$ . Since  $P'$  is to the NE of  $Q$ ,  $Q \rightsquigarrow^H P'$  has a unique highest NW corner  $Y$ . In the previous paragraph we observe that  $Y \notin \phi_\alpha^{-1}(C)$ . Since the road map is obtained by SE-most construction, we must have  $Y = Y_p = (p, b_\alpha - u_\alpha + p)$ , whose distance to the right side of  $A_\alpha$  is  $u_\alpha - p$ . So there are at most  $u_\alpha - p$  vertical paths on the right side of  $Y$ . On the other hand, the vertical paths  $V_q^\alpha, V_{q+1}^\alpha, \dots, V_{v_\alpha}^\alpha$  are on the right side of  $Y$ . So

$$(11) \quad v_\alpha - q + 1 \leq u_\alpha - p$$

It follows that  $q - p - 1 \geq v_\alpha - u_\alpha \geq 0$  by (1). So  $q \geq p + 1 \geq 2$ . For each  $1 \leq p' \leq p$ , let  $Z_{p'}$  be the rightmost point in the intersection of the horizontal line  $x = p'$  with  $V_{p'+q-p-1}^\alpha$  (see Figure 6). Since  $Z_1, \dots, Z_p$  are mutually in SE-NW position and all of them are above  $H_p^\alpha$ , there exists an integer  $p_0$  such that  $1 \leq p_0 \leq p$  and  $Z_{p_0}$  is not in  $\bigcup_{p'=1}^{p-1} H_{p'}^\alpha$ , so is not in  $\phi_\alpha^{-1}(C)$ . We claim that  $C' := C \cup \{\phi_\alpha(Z_{p_0})\}$  is  $\mathbf{u}$ -compatible thus contradicting the maximality of  $C$ . Indeed, for  $\beta \in V_{\text{source}}$ : because  $C'^\beta$  is contained in  $\bigcup_{q=1}^{u_\beta} V_q^\beta$ , it does not contain any diagonal chain of size  $(u_\beta + 1)$ ; for  $\alpha \in V_{\text{target}}$ : it suffices to show that if  $D$  is a diagonal chain in  $C'^\alpha$  containing  $\phi_\alpha(Z_{p_0})$ , then the size of  $D$  is  $\leq u_\alpha$ . Since  $\phi_\alpha(Z_{p_0})$  has  $x$ -coordinate  $p_0$ , there are at most  $p_0 - 1$  points of  $D$  that are NW of  $\phi_\alpha(Z_{p_0})$ ; meanwhile, since  $\phi_\alpha(Z_{p_0})$  is on  $V_{p_0+q-p-1}^\alpha$ , there are at most  $v_\alpha - (p_0 + q - p - 1)$  points of  $D$  that are SE of  $\phi_\alpha(Z_{p_0})$ . Thus the size of  $D$  is  $\leq (p_0 - 1) + 1 + (v_\alpha - (p_0 + q - p - 1)) = v_\alpha - (q - p - 1) \leq u_\alpha$ . This proves (a).

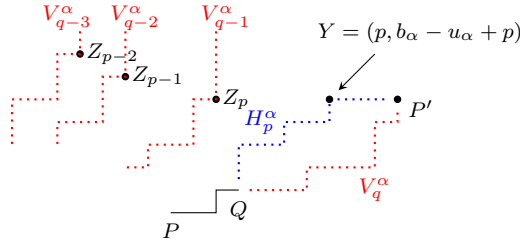

FIGURE 6. Proof of (ii) $\Rightarrow$ (i), condition (a)

To prove condition (b): we shall give an explicit construction of  $H_p^\alpha$  using Lemma 2.9. More precisely, the straightening process is described as follows. Denote the  $x$ -coordinate of  $P_{pq}$  by  $d_{pq}$ , the  $x$ -coordinate of  $Q_{pq}$  by  $c_{pq}$ . Let  $c'_{pq}, d'_{pq}$  be obtained from the Straightening Lemma 2.9. Let  $P'_{pq}$  be the leftmost point on  $V_q^\alpha$  whose  $x$ -coordinate is  $d'_{pq}$ , let  $Q'_{pq}$  be the rightmost point on  $V_q^\alpha$  whose  $x$ -coordinate is  $c'_{pq}$ . Construct  $H_p'^\alpha$  to be the path

$$(a_\alpha - u_\alpha + p, 1) \rightarrow P'_{p1} \overset{V}{\rightsquigarrow} Q'_{p1} \rightarrow P'_{p2} \overset{V}{\rightsquigarrow} Q'_{p2} \rightarrow \cdots \rightarrow P'_{p,v_\alpha} \overset{V}{\rightsquigarrow} Q'_{p,v_\alpha} \rightarrow (p, b)$$

where “ $\rightarrow$ ” denote straight horizontal paths. Define  $C'$  to be the right side of (5) with  $H_p^\alpha$  replaced by  $H_p'^\alpha$  for each  $\alpha$ . Then  $C'$  is also  $\mathbf{u}$ -compatible and  $C \subseteq C'$ ; moreover, if  $C = C'$ , then Lemma 2.9 implies  $c_{pq} = c'_{pq}, d_{pq} = d'_{pq}$  for all  $p, q$ . In particular,  $c_{pq} = d_{p,q+1}$  for all  $p, q$  whenever the equality makes sense. Then  $Q_{pq}$  and  $P_{p,q+1}$  have the same  $x$ -coordinate. This proves (b).

The proof of condition (c) is similar, so we skip.

(i) $\Rightarrow$ (iii). The idea to prove (4) is to give an explicit expression for the number of lattice points in each connected path  $P_{pq}^k \rightsquigarrow Q_{pq}^k$ , and add them up for all  $(p, q)$ . More precisely, given a concurrent vertex map  $C$  induced from a straight road map  $(\{H_p^\alpha\}, \{V_q^\beta\})$ , the number of lattice points in  $P_{pq}^k \rightsquigarrow Q_{pq}^k$  is:

$$(12) \quad 1 + |(P_{pq}^k)_x - (Q_{pq}^k)_x| + |(P_{pq}^k)_y - (Q_{pq}^k)_y|$$

It is easy to see that, the sums of the above three terms for all  $(p, q)$  are  $\sum_k u_s(h_k) u_t(h_k)$ ,  $\sum_{\alpha \in V_{\text{target}}} u_\alpha (a_\alpha - u_\alpha)$ ,  $\sum_{\beta \in V_{\text{source}}} u_\beta (b_\beta - u_\beta)$ , respectively. This proves (4). The fact that  $C$  is  $\mathbf{u}$ -compatible follows from Lemma 2.8.

(iii) $\Rightarrow$ (ii). Assume  $C$  is  $\mathbf{u}$ -compatible and  $|C| = N_{\mathcal{Q}, \mathbf{m}, \mathbf{u}}$ . Let  $C'$  be maximal  $\mathbf{u}$ -compatible set that contains  $C$ . Since it is already proved that (ii) $\Rightarrow$ (i) $\Rightarrow$ (iii), we must have  $|C'| = N_{\mathcal{Q}, \mathbf{m}, \mathbf{u}} = |C|$ , which implies  $C' = C$  and thus  $C$  is maximal.  $\square$

*Proof of Theorem 1.5.* The natural generators of  $\text{init}(I_{\mathcal{Q}, \mathbf{m}, \mathbf{u}})$  are  $(u_\gamma + 1)$ -diagonal chains in  $A_\gamma$  for all  $\gamma$ . So  $C \subseteq L$  is in  $\Delta_{\mathcal{Q}, \mathbf{m}, \mathbf{u}}$  exactly when  $C$  does not contain any  $(u_\gamma + 1)$ -diagonal chain in  $A_\gamma$  for any  $\gamma$ , or in other words, when  $C$  is  $\mathbf{u}$ -compatible. Then  $C$  is a facet of  $\Delta_{\mathcal{Q}, \mathbf{m}, \mathbf{u}}$  if and only if  $C$  is maximal  $\mathbf{u}$ -compatible. So the theorem follows from the statement (i) $\Leftrightarrow$ (ii) of Proposition 2.5.  $\square$

3. PROPERTIES OF THE SIMPLICIAL COMPLEX  $\Delta_{\mathcal{Q},m,u}$ 

3.1.  $C_{\max}(S)$ . In this subsection we will define  $C_{\max}(S)$  and study its properties. In (a) of the definition below, we use notation  $H_p^\alpha, V_q^\alpha, P_{pq}, Q_{pq}$  introduced in (7) and (8). In (b), we use the mirrored version of (7) and (8), in particular,  $r'_1 < \dots < r'_t$  are all the indices such that  $h_{r'_1}, \dots, h_{r'_t}$  are all the arrows with source  $\beta$ .

**Definition 3.1.** Let  $C$  be a concurrent vertex map.

(a) A point  $(i, j, k) \in C$  is called a **horizontal NW corner** if  $(i, j, k) = \phi_\alpha(P)$  where  $P$  is a NW corner of a path  $H_p^\alpha$  for some  $\alpha \in V_{\text{target}}$  and  $1 \leq p \leq u_\alpha$ . Such a corner is said to be **non-essential** if the corresponding  $P$  satisfies  $P = Q_{p,p+v_\alpha-u_\alpha}$  for some  $1 \leq p \leq u_\alpha$ ; otherwise the corner is said to be **essential**.

(b) A point  $(i, j, k) \in C$  is called a **vertical NW corner** if  $(i, j, k) = \phi_\beta(P)$  where  $P$  is a NW corner of a path  $V_q^\beta$  for some  $\beta \in V_{\text{source}}$  and  $1 \leq q \leq u_\beta$ . Such a corner is said to be **non-essential** if the corresponding  $P$  satisfies  $P = P_{q+v_\beta-u_\beta,q}$  for some  $1 \leq q \leq u_\beta$ ; otherwise the corner is said to be **essential**.

Note the points  $Q_{p,p+v_\alpha-u_\alpha}$  for  $p = u_\alpha, u_\alpha-1, \dots$  are just the rightmost  $Q$  on the lowest horizontal path, the 2nd rightmost  $Q$  on the 2nd lowest horizontal path,  $\dots$ , respectively. Also note that if  $(i, j, k)$  is both a horizontal and a vertical NW corner, then it is an essential horizontal NW corner and also an essential vertical NW corner.

**Example 3.2.** In Figure 7 we give an example to illustrate essential (denoted by  $\bullet$ ) and non-essential horizontal NW corners (denoted by  $\circ$ ). Here  $v_\alpha = 6, u_\alpha = 3$ , so by definition, a non-essential horizontal NW corner is a NW corner on  $H_p^\alpha$  that is not  $Q_{p,p+3}$  for  $1 \leq p \leq 3$ . In particular,  $Q_{14}$  and  $Q_{36}$  are non-essential horizontal NW corner (and that  $Q_{25}$  is not a NW corner), and all other horizontal NW corners are essential.

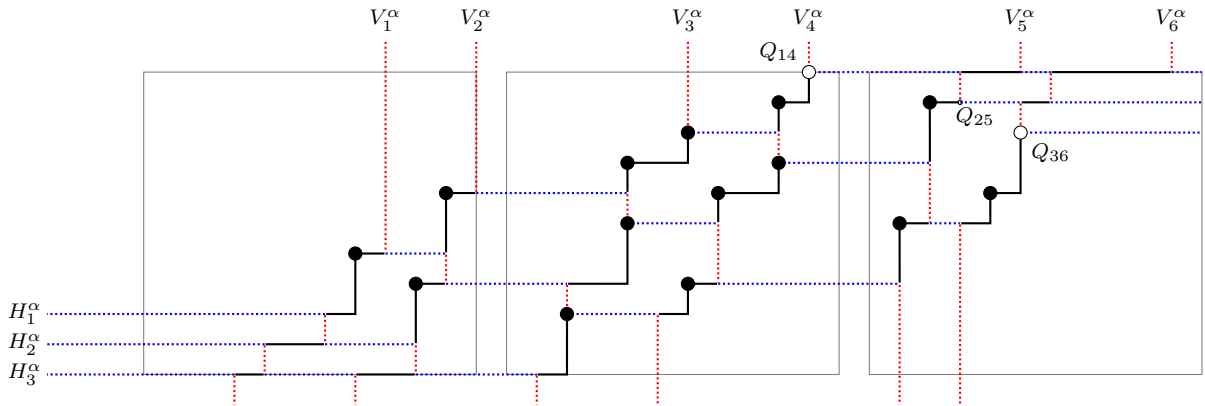

FIGURE 7. An example of essential horizontal NW corners.

**Lemma 3.3.** (a) Assume  $\alpha \in V_{\text{target}}, 1 \leq p \leq u_\alpha$ . Then  $(P_{pq'})_x^{A_\alpha} = p$  for  $q' \geq p+1+v_\alpha-u_\alpha$ ,  $(Q_{pq'})_x^{A_\alpha} = p$  for  $q' \geq p+v_\alpha-u_\alpha$ . Consequently, for  $q' \geq p+1+v_\alpha-u_\alpha$ , the subpath  $P_{pq'} \rightsquigarrow Q_{pq'}$  contains no horizontal NW corner, and  $P_{pq'} + (1, 0) = Q_{p+1,q'}$ .

(b) Assume  $\beta \in V_{\text{source}}$ ,  $1 \leq q \leq u_\beta$ . Then  $(Q_{p'q})_y^{A_\beta} = q$  for  $p' \geq q + 1 + v_\beta - u_\beta$ ,  $(P_{p'q})_y^{A_\beta} = q$  for  $p' \geq q + v_\beta - u_\beta$ . Consequently, for  $p' \geq q + 1 + v_\beta - u_\beta$ , the subpath  $Q_{p'q} \rightsquigarrow P_{p'q}$  contains no vertical NW corner; and  $Q_{p'q} + (0, 1) = P_{p',q+1}$ .

*Proof.* (a) We prove the first statement by backward induction on  $p$ . For the base case  $p = u_\alpha$ , the assertion  $(Q_{u_\alpha, v_\alpha})_x^{A_\alpha} = u_\alpha$  follows from Lemma 2.2 (b). For the inductive step, assume the statement is true for  $p + 1$ . Then for  $q' \geq p + 1 + v_\alpha - u_\alpha$ ,  $(Q_{p+1, q'})_x^{A_\alpha} = p + 1$ , thus  $(P_{pq'})_x^{A_\alpha} \leq (Q_{p+1, q'})_x^{A_\alpha} - 1 = p$ . On the other hand,  $(P_{pq'})_x^{A_\alpha} \geq p$  because it is on the path  $H_p^\alpha$ . So  $(P_{pq'})_x^{A_\alpha} = p$  for  $q' \geq p + 1 + v_\alpha - u_\alpha$ . Next,  $(Q_{pq'})_x^{A_\alpha} = (P_{p, q'+1})_x^{A_\alpha} = p$  for  $q' + 1 \geq p + 1 + v_\alpha - u_\alpha$ , that is, for  $q' \geq p + v_\alpha - u_\alpha$ . Consequently for  $q' \geq p + 1 + v_\alpha - u_\alpha$ ,  $(P_{pq'})_x^{A_\alpha} = (Q_{p, q'-1})_x^{A_\alpha} = p$ , thus the subpath of  $H_p^\alpha$  from  $Q_{p, q'-1}$  to the right endpoint  $(p, v_\alpha)$  must be contained in the horizontal line  $x = p$ , therefore the subpath  $P_{pq'} \rightsquigarrow Q_{pq'}$  contains no horizontal NW corner; meanwhile, since  $(P_{pq'})_x^{A_\alpha} = p$  and  $(Q_{p+1, q'})_x^{A_\alpha} = p + 1$ , we have  $P_{pq'} + (1, 0) = Q_{p+1, q'}$ .

(b) is just the transpose of (a) thus can be proved similarly.  $\square$

**Definition 3.4.** (i) Define a total ordering  $<_T$  on  $L$  as follows:  $(i, j, k) <_T (i', j', k')$  if and only if  $(k < k')$ , or  $(k = k'$  and  $i < i')$ , or  $(k = k'$  and  $i = i'$  and  $j < j')$ .

(ii) Given two concurrent vertex maps  $C = (P_1, \dots, P_N)$  and  $C' = (P'_1, \dots, P'_N)$ , where  $P_1 <_T P_2 <_T \dots <_T P_N$  and  $P'_1 <_T P'_2 <_T \dots <_T P'_N$ , define  $C <_T C'$  if there is an integer  $1 \leq t \leq N$  such that  $P_t <_T P'_t$  and  $P_s = P'_s$  for all  $s > t$ .

(iii) For any  $\mathbf{u}$ -compatible subset  $S \subseteq L$ , define  $C_{\max}(S)$  as follows: first initialize  $S' := S$ , then for  $P$  running from the largest vertex in  $L$  to the smallest under the order  $<_T$ , redefine  $S' := S' \cup \{P\}$  if  $S' \cup \{P\}$  is  $\mathbf{u}$ -compatible. The final  $S'$  is  $C_{\max}(S)$ . Similarly, to define  $C_{\min}(S)$ , we first initialize  $S' := S$ , then for  $P$  running from the smallest vertex in  $L$  to the largest, redefine  $S' := S' \cup \{P\}$  if  $S' \cup \{P\}$  is  $\mathbf{u}$ -compatible. The final  $S'$  is  $C_{\min}(S)$ .

Note that the order  $<_T$  is “opposite” to the order defined in (2) in the following sense:

$$x_{ij}^{(k)} > x_{i'j'}^{(k')} \text{ if and only if } (i, j, k) <_T (i', j', k').$$

Also note that  $C_{\max}(S)$  is maximal  $\mathbf{u}$ -compatible, therefore is a concurrent vertex map.

**Lemma 3.5.** Let  $(i, j, k) \in C$  be an essential (horizontal or vertical) NW corner. Then there is a unique triple  $(i', j', k') \notin C$ , such that  $(i, j, k) <_T (i', j', k')$ , and  $C' = (C \setminus \{(i, j, k)\}) \cup \{(i', j', k')\}$  is also a concurrent vertex map and  $C <_T C'$ . As a consequence, for a  $\mathbf{u}$ -compatible subset  $S \subseteq L$ , all essential NW corners of  $C_{\max}(S)$  are contained in  $S$ .

*Proof.* Without loss of generality, assume  $(i, j, k)$  is an essential horizontal NW corner. Let  $\alpha = t(h_k)$ . We consider two cases.

Case 1: if  $(i, j, k)$  is a vertical NW corner. Let  $t$  be the smallest nonnegative integer such that  $(i', j', k') := (i + t + 1, j + t + 1, k)$  is either not a horizontal NW corner or not a vertical NW corner (see Fig 8 left). It is easy to see that  $(i + t + 1, j + t + 1)$  is a valid point in  $\text{Page}_k$ , and  $(i', j', k') \notin C$ . Define  $C' = (C \setminus \{(i, j, k)\}) \cup \{(i', j', k')\}$ , and modify each  $H_{p+t'+1}^\alpha$  into  $H'_{p+t'+1}$  (resp., modify each  $V_{q+t'+1}^\alpha$  into  $V'_{q+t'+1}$ ) by replacing its NW corner

$\phi_\alpha^{-1}(i+t', j+t', k)$  by a SE corner  $\phi_\alpha^{-1}(i+t'+1, j+t'+1, k)$ , as indicated in Figure 8 right. This new road map corresponds to  $C'$ , thus  $C'$  is a concurrent vertex maps. It is obvious that  $(i, j, k) <_T (i', j', k')$  and  $C <_T C'$ .

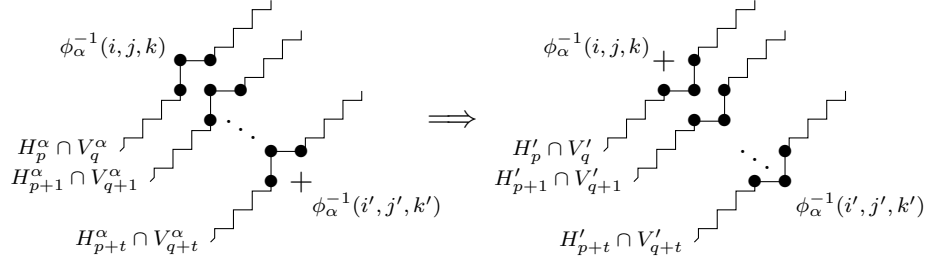

FIGURE 8. Lemma 3.5 Case 1. Left: before modification; Right: after modification

Next, we show the uniqueness of  $(i', j', k')$ . Assume  $(i'', j'', k'')$  is a point in  $C''$  satisfying the conditions that  $(i, j, k) <_T (i'', j'', k'')$  and  $C'' = (C \setminus \{(i, j, k)\}) \cup \{(i'', j'', k'')\}$  is a concurrent vertex map. The first condition implies that  $\phi_\alpha^{-1}(i'', j'', k'')$  does not lie weakly NW of  $\phi_\alpha^{-1}(i, j, k)$ . Let  $\{H_p''\}_{p=1}^{u_\alpha}$  and  $\{V_q''\}_{q=1}^{v_\alpha}$  be the horizontal and vertical paths in  $A_\alpha$  corresponding to  $C''$ . By the “Moreover” part of Proposition 2.5, since  $\phi_\alpha^{-1}(i+1, j, k)$  is on  $H_p^\alpha$ , we have  $\bar{r}_{i+1, j, k}(C) = p-1$ ; since  $\phi_\alpha^{-1}(i'', j'', k'')$  does not lie weakly NW of  $\phi_\alpha^{-1}(i, j, k)$ ,  $C$  and  $C''$  agree at every point weakly NW of  $\phi_\alpha^{-1}(i, j, k)$  except the point  $\phi_\alpha^{-1}(i, j, k)$  itself, and  $\bar{r}_{i+1, j, k}(C'') = \bar{r}_{i+1, j, k}(C) = p-1$ . Since  $(i+1, j, k)$  is in  $C$ , it is also in  $C''$ , thus  $\phi_\alpha^{-1}(i+1, j, k)$  is on  $H_p''$  because  $\bar{r}_{i+1, j, k}(C'') = p-1$ . Similarly,  $\phi_\alpha^{-1}(i, j+1, k)$  is on  $H_p''$ . If  $\phi_\alpha^{-1}(i, j, k)$  is also on  $H_p''$ , then  $(i, j, k)$  must be a horizontal NW corner, and therefore must be in  $C''$ , a contradiction. So  $\phi_\alpha^{-1}(i, j, k)$  is not on  $H_p''$ . This implies  $\phi_\alpha^{-1}(i+1, j+1, k)$  is on  $H_p''$ . Using the same argument and by induction on  $t'$ , we see that  $\phi_\alpha^{-1}(i+t'+1, j+t', k)$ ,  $\phi_\alpha^{-1}(i+t'+1, j+t'+1, k)$ ,  $\phi_\alpha^{-1}(i+t', j+t'+1, k)$  are on the same horizontal path  $H_{p+t'}''$  for every  $0 \leq t' \leq t$ . In particular,  $\phi_\alpha^{-1}(i', j', k')$  on  $H_{p+t}''$ . Similarly,  $\phi_\alpha^{-1}(i', j', k')$  is on  $V_{q+t}''$ . Thus  $(i', j', k')$  is in  $C''$ , which implies  $(i'', j'', k'') = (i', j', k')$ .

Case 2: if  $(i, j, k)$  is not a vertical NW corner. This is possible only when  $\phi_\alpha^{-1}(i, j, k) = Q_{pq}$  for some  $p, q$  and the vertical edge connecting the vertices  $\phi_\alpha^{-1}(i, j, k)$  and  $\phi_\alpha^{-1}(i+1, j, k)$  is in  $H_p^\alpha$ . By Lemma 3.3,  $q \leq p+v_\alpha-u_\alpha$ . If the equality holds, then  $(i, j, k)$  is a non-essential horizontal NW corner, contradicting our assumption. So  $q \leq p+v_\alpha-u_\alpha-1$ , thus for all  $t \leq u_\alpha-p$ ,  $q+t+1 \leq (p+v_\alpha-u_\alpha-1) + (u_\alpha-p) + 1 = v_\alpha$ . Let  $t \leq u_\alpha-p$  be the smallest nonnegative integer such that  $P_{p+t, q+t+1} + (1, 0) \notin \phi_\alpha^{-1}(C)$ . Then for  $0 \leq t' < t$ , we must have  $P_{p+t', q+t'+1} + (1, 0) = Q_{p+t'+1, q+t'+1}$ . For  $0 \leq t' \leq t$ , denote  $R_{p+t', q+t'}$  to be the leftmost vertex on  $P_{p+t'} \rightsquigarrow Q_{p+t'}$  with  $x$ -coordinate  $p+t'$ . The fact that  $Q_{pq}$  is a horizontal NW corner forces  $R_{p+t', q+t'}$  to also be a horizontal NW corner for each  $0 \leq t' \leq t$ . In particular,  $R_{p+t, q+t}$  is a horizontal NW corner, and therefore the  $x$ -coordinate of  $R_{p+t, q+t}$  is  $< a_\alpha$ . Now, let  $P' = P_{p+t, q+t+1} + (1, 0)$ ,  $(i', j', k') = \phi_\alpha(P')$ ,  $C' = (C \setminus \{(i, j, k)\}) \cup \{(i', j', k')\}$ , keep all vertical paths unchanged, and modify each horizontal path  $H_{p+t'+1}^\alpha$  into  $H_{p+t'+1}'$  by replacing its subpath  $R_{p+t', q+t'} + (1, 0) \rightarrow R_{p+t', q+t'} \rightarrow P_{p+t', q+t'+1}$  by a subpath  $R_{p+t', q+t'} + (1, 0) \rightarrow$

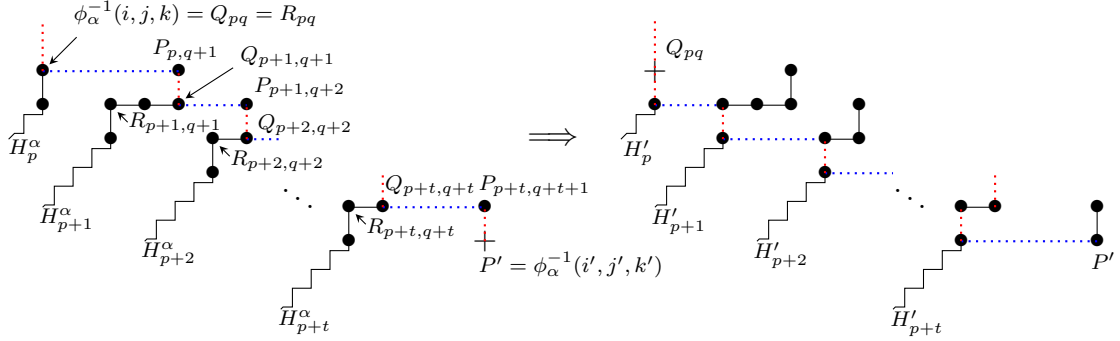

FIGURE 9. Lemma 3.5 Case 2. Left: before modification; right: after modification.

$P_{p+t',q+t'+1} + (1,0) \rightarrow P_{p+t',q+t'+1}$ , as shown in Figure 9. It is easy to see that  $C'$  is a concurrent vertex map corresponding to the modified road map, and  $C <_T C'$ .

Next, we show the uniqueness of  $(i', j', k')$ . Assume  $(i'', j'', k'')$  is a point in  $C''$  satisfying the conditions  $(i, j, k) <_T (i'', j'', k'')$  and  $C'' = (C \setminus \{(i, j, k)\}) \cup \{(i'', j'', k'')\}$  is a concurrent vertex map. Then  $P'' := \phi_\alpha^{-1}(i'', j'', k'')$  does not lie weakly NW to  $Q_{pq} = \phi_\alpha^{-1}(i, j, k)$ . Let  $\{H_p''\}_{p=1}^{u_\alpha}$  and  $\{V_q''\}_{q=1}^{v_\alpha}$  be the horizontal and vertical paths in  $A_\alpha$  corresponding to  $C''$ . We now prove the following claim by induction.

Claim: for  $0 \leq t' \leq t$ ,  $H_{p+t'}''$  contains the subpath  $R_{p+t',q+t'+1} + (1,0) \rightarrow P_{p+t',q+t'+1} + (1,0) \rightarrow P_{p+t',q+t'+1}$ .

For  $t' = 0$ , let  $x_0 := (R_{pq})_0$ . Then  $H_p''$  must pass  $R_{pq} + (1,0)$ , go east to a SE corner  $(x_0, y_0)$ , turn north to  $(x_0 - 1, y_0)$  with  $(R_{pq})_y < y_0 \leq (P_{p,q+1})_y$ . If  $y_0 = (P_{p,q+1})_y$  then we are done. If  $(R_{pq})_y < y_0 < (R_{p+1,q+1})_y$ , then  $(x_0, y_0)$  is a SE corner and  $(x_0 - 1, y_0)$  is a NW corner of  $H_p''$ , so both are in  $\phi_\alpha^{-1}(C'' \setminus C)$ , a contradiction. So we can assume  $(R_{p+1,q+1})_y \leq y_0 < (P_{p,q+1})_y$ . Then  $(x_0, y_0) \in \phi_\alpha^{-1}(C \cap C'')$ . Since  $(x_0, y_0)$  is in  $H_p''$  and  $H_{p+1}$ , we have  $\bar{s}_{\phi_\alpha(x_0, y_0)}(C'') = \bar{s}_{\phi_\alpha(x_0, y_0)}(C) + 1$ , thus  $P''$  lies SE of  $(x_0, y_0)$ . But then  $\bar{r}_{\phi_\alpha(P_{p,q+1})}(C'') = \bar{r}_{\phi_\alpha(P_{p,q+1})}(C) = p - 1$ , thus  $H_p''$  contains  $P_{p,q+1}$ , the vertex  $(x_0 - 1, y_0)$  is a NW corner of  $H_p''$ . So both  $P''$  and  $(x_0 - 1, y_0)$  are in  $\phi_\alpha^{-1}(C'' \setminus C)$ , a contradiction.

For  $t' > 0$ , the proof is similar: let  $x_0 = (R_{p+t',q+t'})_x$ . Then  $H_{p+t'}''$  must pass  $R_{p+t',q+t'} + (1,0)$ , go east to a SE corner  $(x_0, y_0)$ , turn north to  $(x_0 - 1, y_0)$  with  $(R_{p+t',q+t'})_y < y_0 \leq (P_{p+t',q+t'+1})_y$ . If  $y_0 = (P_{p+t',q+t'+1})_y$  then we are done. If  $(R_{p+t',q+t'})_y < y_0 < (R_{p+t'+1,q+t'+1})_y$ , then  $(x_0, y_0)$  is a SE corner and  $(x_0 - 1, y_0)$  is a NW corner of  $H_{p+t'}''$ , so the former is in  $\phi_\alpha^{-1}(C'' \setminus C)$  and the latter is in  $\phi_\alpha^{-1}(C)$  thus is in the horizontal segment  $R_{p+t',q+t'} \rightarrow Q_{p+t',q+t'}$ , which is a subpath of  $H_{p+t'-1}''$  by inductive hypothesis. So  $(x_0 - 1, y_0)$  is in both  $H_{p+t'}''$  and  $H_{p+t'-1}''$ , a contradiction. So we can assume  $(R_{p+t'+1,q+t'+1})_y \leq y_0 < (P_{p+t',q+t'+1})_y$ . Then  $(x_0, y_0) \in \phi_\alpha^{-1}(C \cap C'')$ . Since  $(x_0, y_0)$  is in  $H_{p+t'}''$  and  $H_{p+t'+1}$ , we have  $\bar{s}_{\phi_\alpha(x_0, y_0)}(C'') = \bar{s}_{\phi_\alpha(x_0, y_0)}(C) + 1$ , thus  $P''$  lies SE of  $(x_0, y_0)$ . But then  $\bar{r}_{\phi_\alpha(P_{p,q+1})}(C'') = \bar{r}_{\phi_\alpha(P_{p,q+1})}(C) = p - 1$ , thus  $H_{p+t'}''$  contains  $P_{p,q+1}$ , the vertex  $(x_0 - 1, y_0)$  is a NW corner of  $H_{p+t'}''$ . So  $(x_0 - 1, y_0)$  lies in  $\phi_\alpha^{-1}(C)$ , thus is contained in the horizontal segment  $R_{p+t',q+t'} Q_{p+t',q+t'}$ , which is a subpath

of  $H''_{p+t'-1}$  by the inductive hypothesis. So  $(x_0 - 1, y_0)$  has to lie in both  $H''_{p+t'}$  and  $H''_{p+t'-1}$ , a contradiction.

Now the claim is proved. In particular, when  $t' = t$ , the claim says that  $H''_{p+t}$  contains  $P_{p+t, q+t+1} + (1, 0) = P'$ . So  $(i', j', k')$  is in a horizontal path induced from  $C''$ . Similarly, it is in a vertical path induced from  $C'''$ . So it is in  $C''$ . This implies the uniqueness.  $\square$

**Proposition 3.6.** *Let  $C$  be a concurrent vertex map and  $S$  be a subset of  $C$ . Then  $C_{\max}(S) \geq_T C$ , and the equality holds if and only if  $S$  contains all the essential horizontal and vertical NW corners of  $C$ . Similarly,  $C_{\min}(S) \leq_T C$ , and the equality holds if and only if  $S$  contains all the essential horizontal and vertical SE corners of  $C$ .*

*Proof.* By symmetry, we only prove the first statement. Note that  $C_{\max}(S) \geq_T C$  is obvious, so we only need to prove the condition for the equality to hold. “ $\Rightarrow$ ” follows immediately from Lemma 3.5. For “ $\Leftarrow$ ”, assume that  $S$  contains all the essential horizontal and vertical NW corners of  $C$ , and assume the contrary that  $C' := C_{\max}(S) >_T C$ . Let

$(i, j, k)$  be the largest point in  $C' \setminus C$  under the order “ $<_T$ ”.

Note that a point  $(i', j', k')$  satisfying  $(i', j', k') >_T (i, j, k)$  lies in  $C'$  if and only if it lies in  $C$ . Then the choice of  $(i, j, k)$  guarantees

$$(13) \quad \bar{s}_{ijk}(C') = \bar{s}_{ijk}(C).$$

Let  $\alpha = t(h_k)$ ,  $\beta = s(h_k)$ ,  $p_0 = \bar{r}_{ijk}(C)$ . By Proposition 2.5, in  $A_\alpha$ ,  $\phi_\alpha^{-1}(i, j, k)$  is strictly below  $H_{p_0}^\alpha$  (if  $p_0 > 0$ ) and weakly above  $H_{p_0+1}^\alpha$  (if  $p_0 < u_\alpha - 1$ ). Let  $q_0$  be the integer in the range  $0 \leq q_0 \leq v_\alpha - 1$  such that  $\phi_\alpha^{-1}(i, j, k)$  is strictly to the right of  $V_{q_0}^\alpha$  (if  $q_0 > 0$ ) and weakly to the left of  $V_{q_0+1}^\alpha$  (if  $q_0 < v_\alpha - 1$ ). We shall construct a sequence of points

$$(14) \quad S_{p_0}^\alpha, T_{p_0}^\alpha, S_{p_0-1}^\alpha, T_{p_0-1}^\alpha, \dots, S_1^\alpha, T_1^\alpha \text{ in } A_\alpha$$

recursively as follows. Start from  $\phi_\alpha^{-1}(i, j, k)$ , walk west (for at least 1 unit) until reaching path  $H_{p_0}^\alpha$  at point  $S_{p_0}^\alpha$ , then walk north along  $H_{p_0}^\alpha$  (for at least one unit) until reaching a NW corner  $T_{p_0}^\alpha$ ; then for  $p = p_0, p_0 - 1, \dots, 2$ , once  $T_p^\alpha$  is constructed, walk west from it (for at least 1 unit) until reaching path  $H_{p-1}^\alpha$  at point  $S_{p-1}^\alpha$ , then walk north along  $H_{p-1}^\alpha$  (for at least 1 unit) until reaching a NW corner which we denote  $T_{p-1}^\alpha$ . (See Figure 10). If some point in the sequence (14) can be constructed, we call it constructable; otherwise we call it unconstructable.

**Claim.** (i) “Some point in (14) is unconstructable”  $\Leftrightarrow$  (ii) “ $S_{p_0}^\alpha$  is unconstructable”  $\Leftrightarrow$  (iii) “ $i = a_\alpha - u_\alpha + p_0 + 1$ ”.

*Proof of Claim.* For (ii) $\Rightarrow$ (iii), note that  $S_{p_0}^\alpha$  is unconstructable if walking west from  $\phi_\alpha^{-1}(i, j, k)$  will never reach  $H_{p_0}^\alpha$ . In this case, the  $x$ -coordinate of  $\phi_\alpha^{-1}(i, j, k)$  is greater than the  $x$ -coordinate of the left endpoint of  $H_{p_0}^\alpha$ , that is,  $i > a_\alpha - u_\alpha + p_0$ . Since  $\phi_\alpha^{-1}(i, j, k)$  is weakly above  $H_{p_0+1}^\alpha$ , the  $x$ -coordinate of  $\phi_\alpha^{-1}(i, j, k)$  is no larger than the  $x$ -coordinate of the left endpoint of  $H_{p_0+1}^\alpha$ , that is,  $i \leq a_\alpha - u_\alpha + p_0 + 1$ . So we must have  $i = a_\alpha - u_\alpha + p_0 + 1$ . It is obvious that (iii) $\Rightarrow$ (ii) $\Rightarrow$ (i). For (i) $\Rightarrow$ (ii), consider the case  $S_p^\alpha$  is constructable but  $S_{p-1}^\alpha$  is unconstructable for some  $2 \leq p \leq p_0$ . Then the  $x$ -coordinate of  $S_p^\alpha$  is  $> a_\alpha - u_\alpha + p$ , the



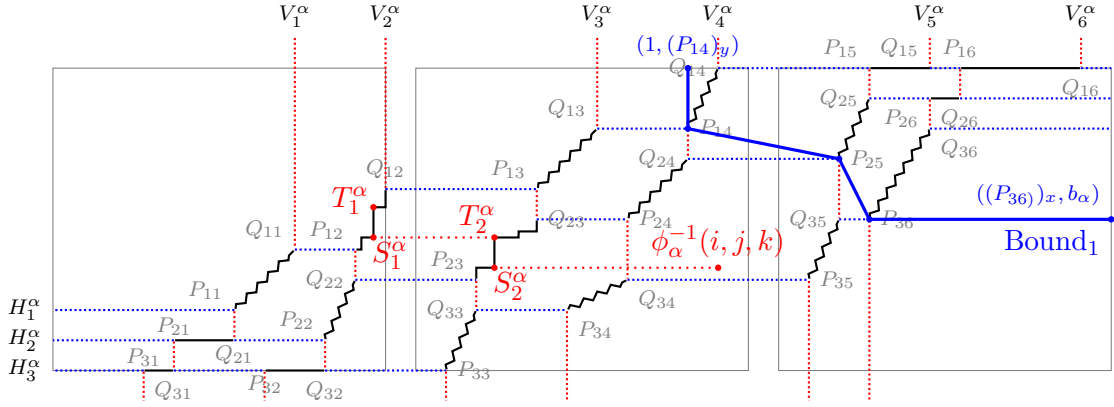

FIGURE 10. An example of the sequence in (14) with  $p_0 = 2$ . The blue broken line is  $\text{Bound}_1$ .

$x$ -coordinate of  $S_{p+1}^\alpha$  is  $> a_\alpha - u_\alpha + (p+1)$ ,  $\dots$ , the  $x$ -coordinate of  $S_{p_0}^\alpha$  is  $i > a_\alpha - u_\alpha + p_0$ . But then  $S_{p_0}^\alpha$  is unconstructable, a contradiction to the assumption that  $S_p^\alpha$  is constructable. So this case will never happen. This completes the proof of the Claim.

Assume the sequence of points in (14) are constructable. Then  $T_{p_0}^\alpha, \dots, T_1^\alpha$  are horizontal NW corners of  $C$  and form a diagonal chain in  $A_\alpha$ . It is easy to see that:

$$(15) \quad S_p^\alpha \text{ and } T_p^\alpha \text{ are on } H_p^\alpha \cap V_{e_p}^\alpha \text{ for } 1 \leq p \leq p_0, \text{ where } 1 \leq e_1 < e_2 < \dots < e_{p_0} \leq q_0.$$

Similarly, let  $q_1 = \bar{r}'_{ijk}(C)$ . The vertex  $\phi_\beta^{-1}(i, j, k)$  is strictly to the right of  $V_{q_1}^\beta$ , weakly to the left of  $V_{q_1+1}^\beta$ , strictly below  $V_{p_1}^\beta$ , weakly above  $V_{p_1+1}^\beta$ , for some  $p_1$ . We construct points  $S_{q_1}^\beta, T_{q_1}^\beta, S_{q_1-1}^\beta, T_{q_1-1}^\beta, \dots, S_1^\beta, T_1^\beta$  in  $A_\beta$  similarly to (14) by starting from  $\phi_\beta^{-1}(i, j, k)$  and walking north and west iteratively. Like the above Claim, we have “some of those points is unconstructable”  $\Leftrightarrow$  “ $S_{q_1}^\beta$  is unconstructable”  $\Leftrightarrow j = b_\beta - u_\beta + q_1 + 1$ . Assume those points are constructable. Then  $T_{q_1}^\beta, \dots, T_1^\beta$  are vertical NW corners of  $C$  and form a diagonal chain in  $A_\beta$ , and

$$(16) \quad S_q^\beta \text{ and } T_q^\beta \text{ are on } H_{f_q}^\beta \cap V_q^\beta \text{ for } 1 \leq q \leq q_1, \text{ where } 1 \leq f_1 < f_2 < \dots < f_{q_1} \leq p_1.$$

We make the following easy observation whose proof is skipped. (See Figure 10 for an example of  $\text{Bound}_1$ .)

**Observation (a):**  $T_{p_0}^\alpha, \dots, T_1^\alpha$  are essential horizontal NW corners of  $C$  if  $\phi_\alpha^{-1}(i, j, k)$  lies on the SW side of the following broken line in  $A_\alpha$ :

$$\text{Bound}_1 := (1, (P_{1,1+v_\alpha-u_\alpha})_y) \rightarrow P_{1,1+v_\alpha-u_\alpha} \rightarrow P_{2,2+v_\alpha-u_\alpha} \rightarrow \dots \rightarrow P_{u_\alpha v_\alpha} \rightarrow ((P_{u_\alpha v_\alpha})_x, b_\alpha).$$

**Observation (b):**  $T_{q_1}^\beta, \dots, T_1^\beta$  are all essential vertical NW corners of  $C$  if  $\phi_\beta^{-1}(i, j, k)$  is to the NE of the following broken line in  $A_\beta$ :

$$\text{Bound}_2 = ((Q'_{1+v_\beta-u_\beta})_x, 1) \rightarrow Q'_{1+v_\beta-u_\beta,1} \rightarrow Q'_{2+v_\beta-u_\beta,2} \rightarrow \dots \rightarrow Q'_{v_\beta u_\beta} \rightarrow (a_\beta, (Q'_{v_\beta u_\beta})_y).$$



Also observe that

$$\text{“}T_{p_0}^\alpha, \dots, T_1^\alpha \text{ are essential or unconstructable”} \Rightarrow \bar{r}_{ijk}(C') \geq p_0.$$

Indeed, if they are essential, then by the assumption that  $S$  contains all the essential NW corners of  $C$ ,  $\phi_\alpha^{-1}(S)$  must contain  $T_1^\alpha, \dots, T_{p_0}^\alpha$ , thus  $\bar{r}_{ijk}(C') \geq p_0$ ; if they are unconstructable, then  $i = a_\alpha - u_\alpha + p_0 + 1$ , and by definition,  $\bar{r}_{ijk}(C') = \max(r_{ijk}, \min(i - 1, u_\alpha - 1 - \min(a_\alpha - i, b_\alpha - j')))$   $\geq \min(i - 1, u_\alpha - 1 - \min(a_\alpha - i, b_\alpha - j')) \geq \min(i - 1, u_\alpha - 1 - (a_\alpha - i)) = \min(a_\alpha - u_\alpha + p_0, p_0) = p_0$ . Similarly we have

$$\text{“}T_1^\beta, \dots, T_{q_1}^\beta \text{ are essential or unconstructable”} \Rightarrow \bar{r}'_{ijk}(C') \geq q_1.$$

To finish the proof of Proposition 3.6, we discuss the following 4 cases separately.

Case 1: every point of  $T_1^\alpha, \dots, T_{p_0}^\alpha$  and  $T_1^\beta, \dots, T_{q_1}^\beta$  is either essential or unconstructable. As we have seen,  $\bar{r}_{ijk}(C') \geq p_0 = \bar{r}_{ijk}(C)$ . Together with (13), we have  $\bar{r}_{ijk}(C) + \bar{s}_{ijk}(C) \leq \bar{r}_{ijk}(C') + \bar{s}_{ijk}(C') = u_\alpha - 1$ . Thus the equality  $\bar{r}_{ijk}(C) + \bar{s}_{ijk}(C) = u_\alpha - 1$  holds by Proposition 2.5, and  $\bar{r}_{ijk}(C') = p_0$ . Similarly,  $\bar{r}'_{ijk}(C) + \bar{s}'_{ijk}(C) = u_\beta - 1$  and  $\bar{r}'_{ijk}(C') = q_1$ . Thus  $(i, j, k) \in C$  by Proposition 2.5, contradicting the assumption  $(i, j, k) \notin C$ .

Case 2:  $T_1^\beta, \dots, T_{q_1}^\beta$  are essential or unconstructable, but for some  $1 \leq a \leq p_0$ ,  $T_a^\alpha$  is non-essential (so  $T_a^\alpha = Q_{a, a+v_\alpha-u_\alpha}$ ). Then  $\bar{r}'_{ijk}(C) + \bar{s}'_{ijk}(C) = u_\beta - 1$  and  $\bar{r}'_{ijk}(C') = q_1$  as we have shown in Case 1. If  $\bar{r}_{ijk}(C) + \bar{s}_{ijk}(C) = u_\alpha - 1$  then  $(i, j, k) \in C$ , contradicting our assumption. So  $\bar{r}_{ijk}(C) + \bar{s}_{ijk}(C) = u_\alpha$ . By Proposition 2.5,  $(i, j) \in V_{q_1+1}^\beta|_k$ , but  $(i, j) \notin H_p^\alpha|_k$  for any  $p$ . So there are  $p, q$  such that  $\phi_\alpha^{-1}(i, j, k)$  is on a path  $V_q^\alpha$ , and strictly between the paths  $H_p^\alpha$  and  $H_{p+1}^\alpha$ ; therefore  $\phi_\alpha^{-1}(i, j, k)$  lies in the interior of a vertical line segment  $P_{p,q}Q_{p+1,q}$ . By Observation (a),  $\phi_\alpha^{-1}(i, j, k)$  is weakly on the NE side of  $\text{Bound}_1$ . So the whole segment  $P_{p,q}Q_{p+1,q}$  is weakly on the NE side of  $\text{Bound}_1$ . By the definition of  $\text{Bound}_1$ , we have  $q \geq p + 1 + v_\alpha - u_\alpha$ . By Lemma 3.3, the segment  $P_{p,q}Q_{p+1,q}$  has length 1, which contradicts the fact that  $\phi_\alpha^{-1}(i, j, k)$  lies in the interior of  $P_{p,q}Q_{p+1,q}$ .

Case 3:  $T_1^\alpha, \dots, T_{p_0}^\alpha$  are essential or unconstructable, but for some  $1 \leq b \leq q_1$ ,  $T_b^\beta$  is non-essential. The proof is similar to Case 2.

Case 4:  $T_a^\alpha = Q_{a, a+v_\alpha-u_\alpha}$  is non-essential for some  $a$  such that  $1 \leq a \leq p_0$ , and  $T_b^\beta = P_{b+v_\beta-u_\beta, b}$  is non-essential for some  $b$  such that  $1 \leq b \leq q_1$ . Without loss of generality, assume  $a$  and  $b$  are the maximal choices. Define  $D_1$  to be the number of horizontal paths in  $A_\beta$  in those blocks above  $\text{Page}_k$ ,  $D_2$  to be the number of vertical paths in  $A_\alpha$  in those blocks to the left of  $\text{Page}_k$ , that is,

$$D_1 = p_1 - p_0 = \sum_{r'_i < k} u_{t(h_{r'_i})}, \quad D_2 = q_0 - q_1 = \sum_{r_i < k} u_{s(h_{r_i})}.$$

We also have  $H_p^\alpha|_k = H_{p+D_1}^\alpha|_k$  for  $1 \leq p \leq u_\alpha$ , and  $V_q^\beta|_k = H_{q+D_2}^\beta|_k$  for  $1 \leq q \leq u_\beta$ . Since  $\phi_\alpha^{-1}(i, j, k)$  is on the weakly NE side of  $\text{Bound}_1$ ,  $\phi_\beta^{-1}(i, j, k)$  is on the weakly SE side of  $\text{Bound}_2$ , we have

$$(17) \quad q_0 \geq p_0 + v_\alpha - u_\alpha, \quad p_1 \geq q_1 + v_\beta - u_\beta.$$

so  $\sum_{r'_i < k} u_t(h_{r'_i}) + \sum_{r_i < k} u_s(h_{r_i}) = D_1 + D_2 = (p_1 - p_0) + (q_0 - q_1) \geq v_\alpha - u_\alpha + v_\beta - u_\beta$ . Since  $\alpha = t(h_k)$ ,  $\beta = s(h_k)$ ,  $v_\alpha = \sum u_s(h_{r_i})$ ,  $v_\beta = \sum u_t(h_{r'_i})$ , we have  $\sum_{r'_i \leq k} u_t(h_{r'_i}) + \sum_{r_i \leq k} u_s(h_{r_i}) \geq \sum u_s(h_{r_i}) + \sum u_t(h_{r'_i})$ ,  $\sum_{r'_i > k} u_t(h_{r'_i}) + \sum_{r_i > k} u_s(h_{r_i}) \leq 0$ . Since  $u_\gamma > 0$  for any  $\gamma$ , there should be no summand at all in the above two sums. This implies:  $r_s = r'_t = k$  (that is,  $\text{Page}_k$  is the rightmost block of  $A_\alpha$ , and is the bottommost block of  $A_\beta$ ), and  $q_0 = p_0 + v_\alpha - u_\alpha$ ,  $p_1 = q_1 + v_\beta - u_\beta$ ,  $D_1 = p_1 - p_0 = v_\beta - u_\alpha$ ,  $D_2 = q_0 - q_1 = v_\alpha - u_\beta$ . Then  $p_0 + v_\alpha - u_\alpha = q_0 = q_1 + v_\alpha - u_\beta$ , thus

$$(18) \quad p_0 - q_1 = u_\alpha - u_\beta.$$

Without loss of generality, assume  $p_0 - a \leq q_1 - b$ . Let  $b' = a + q_1 - p_0$ , then  $b \leq b' \leq q_1$  and  $p_0 - a = q_1 - b'$ . We claim that the following holds for  $d = 0, \dots, p_0 - a$ :

- (i) the subpath  $P_{p_0-d, q_0-d} \rightsquigarrow Q_{p_0-d, q_0-d}$  is in the last block of  $A_\alpha$ , and
- (ii) both  $T_{p_0-d}^\alpha$  and  $\phi_\alpha^{-1} \phi_\beta(T_{q_1-d}^\beta)$  are on  $P_{p_0-d, q_0-d} \rightsquigarrow Q_{p_0-d, q_0-d}$ , and
- (iii) the point  $T_{p_0-d}^\alpha$  is weakly SW of the point  $\phi_\alpha^{-1} \phi_\beta(T_{q_1-d}^\beta)$ .

To show (i), note that  $q_0 - d = (p_0 + v_\alpha - u_\alpha) - d \geq v_\alpha - u_\alpha + a = v_\alpha - u_\alpha + (p_0 - q_1 + b')$   $\stackrel{(18)}{=} v_\alpha - u_\alpha + (u_\alpha - u_\beta + b') = v_\alpha - u_\beta + b' > v_\alpha - u_\beta$ . Then (i) must hold because  $A_\alpha$  has  $v_\alpha$  vertical paths,  $u_\beta$  of which are in the last block. Therefore the subpath  $P_{p_0-d, q_0-d} \rightsquigarrow Q_{p_0-d, q_0-d}$ , which is contained in the  $(q_0 - d)$ -th vertical path  $V_{q_0-d}^\alpha$ , is in the last block.

To show (ii): since  $T_a^\alpha = Q_{a, a+v_\alpha-u_\alpha}$ , we have  $e_a = a + v_\alpha - u_\alpha$ , where  $e_a$  is defined in (15). Since  $a + v_\alpha - u_\alpha = e_a < e_{a+1} < \dots < e_{p_0} \leq q_0 = p_0 + v_\alpha - u_\alpha$ , for  $a \leq p \leq p_0$  we must have  $e_p = p + v_\alpha - u_\alpha$ , and  $T_p^\alpha$  must lie on  $P_{p, p+v_\alpha-u_\alpha} \rightsquigarrow Q_{p, p+v_\alpha-u_\alpha}$ , equivalently,  $T_{p_0-d}^\alpha$  lies on  $P_{p_0-d, q_0-d} \rightsquigarrow Q_{p_0-d, q_0-d}$  for  $d = 0, \dots, p_0 - a$ . Similarly, recall that  $f_q$  is defined in (16); for  $b \leq q \leq q_1$ , we must have  $f_q = q + v_\beta - u_\beta$ , and  $T_q^\beta$  must lie on  $P'_{q+v_\beta-u_\beta, q} \rightsquigarrow Q'_{q+v_\beta-u_\beta, q}$ .

Now consider those  $q$  in the range  $b' \leq q \leq q_1$ . Note that  $H_{q+v_\beta-u_\beta}^\beta$  is in the last block of  $A_\beta$  because  $q + v_\beta - u_\beta \geq b' + v_\beta - u_\beta = (a + q_1 - p_0) + v_\beta - u_\beta \stackrel{(18)}{=} (a + u_\beta - u_\alpha) + v_\beta - u_\beta = a + v_\beta - u_\alpha > v_\beta - u_\alpha = D_1$ . So  $P'_{q+v_\beta-u_\beta, q} \rightsquigarrow Q'_{q+v_\beta-u_\beta, q}$  is in the last block of  $A_\beta$ . Apply  $\phi_\alpha^{-1} \phi_\beta$ , we see that  $\phi_\alpha^{-1} \phi_\beta(T_q^\beta)$  is on  $\phi_\alpha^{-1} \phi_\beta(P'_{q+v_\beta-u_\beta, q} \rightsquigarrow Q'_{q+v_\beta-u_\beta, q}) = (P_{q+v_\beta-u_\beta-D_1, q+D_2} \rightsquigarrow Q_{q+v_\beta-u_\beta-D_1, q+D_2})$ . Let  $d = q_1 - q$ , then the indices in the last expression become  $(q + v_\beta - u_\beta - D_1, q + D_2) = (q_1 - d + v_\beta - u_\beta - (v_\beta - u_\alpha), q_1 - d + v_\alpha - u_\beta) = (p_0 - u_\alpha + u_\beta - d + v_\beta - u_\beta - (v_\beta - u_\alpha), q_0 - v_\alpha + u_\beta - d + v_\alpha - u_\beta) = (p_0 - d, q_0 - d)$ . Thus  $\phi_\alpha^{-1} \phi_\beta(T_{q_1-d}^\beta)$  is indeed on  $P_{p_0-d, q_0-d} \rightsquigarrow Q_{p_0-d, q_0-d}$ . This proves (ii).

To show (iii) by induction on  $d$ : for  $d = 0$ , since  $S_{p_0}^\alpha$  is to the west of  $\phi_\alpha^{-1}(i, j, k)$ ,  $\phi_\alpha^{-1} \phi_\beta(S_{q_1}^\beta)$  is to the north of  $\phi_\alpha^{-1}(i, j, k)$ , we see that  $S_{p_0}^\alpha$  is to the SW of  $\phi_\alpha^{-1} \phi_\beta(S_{q_1}^\beta)$ , and therefore  $T_{p_0}^\alpha$  is weakly SW to  $\phi_\alpha^{-1} \phi_\beta(T_{q_1}^\beta)$ . Now assume  $T_{p_0-(d-1)}^\alpha$  is weakly SW of  $\phi_\alpha^{-1} \phi_\beta(T_{q_1-(d-1)}^\beta)$ , similar to the above argument for  $d = 0$ , we see that  $S_{p_0-d}^\alpha$  is SW of  $\phi_\alpha^{-1} \phi_\beta(S_{q_1-d}^\beta)$ , and therefore  $T_{p_0-d}^\alpha$  is weakly SW of  $\phi_\alpha^{-1} \phi_\beta(T_{q_1-d}^\beta)$ .

Now using (i)–(iii) for  $d = p_0 - a$ , we see that the four points

$$(S, T, T', S') = (S_a^\alpha, T_a^\alpha, \phi_\alpha^{-1}\phi_\beta(T_{a+q_1-p_0}^\beta), \phi_\alpha^{-1}\phi_\beta(T_{a+q_1-p_0}^\beta))$$

are all on the path  $P_{a,a+q_0-p_0} \rightsquigarrow Q_{a,a+q_0-p_0}$ , and  $S$  is to the south of  $T$ ,  $T$  is weakly SW of  $T'$ ,  $T'$  is to the west of  $S'$ . But  $T = Q_{a,a+q_0-p_0}$  is the NE endpoint of the above path, so  $T' = T$  and there is no place for  $S'$ , a contradiction. (See Figure 11.) So in all four cases we

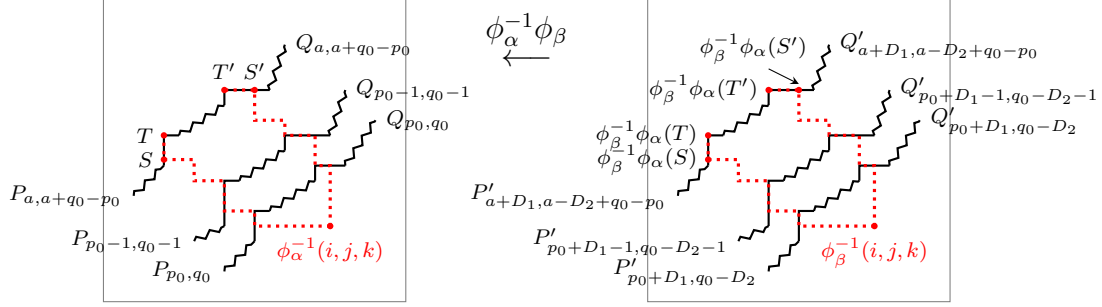

FIGURE 11. Case 4. Left: last block of  $A_\alpha$ ; Right: last block of in  $A_\beta$ . The points on the right side coincide with the points on the left side under the map  $\phi_\alpha^{-1}\phi_\beta$ .

get the desired contradiction. This completes the proof of Proposition 3.6.  $\square$

**3.2. Chute moves.** Recall the classical chute moves of pipe dreams (for example, see [17, §16.1]), where a “+” is moved from the NE corner to the SW corner, as shown in Figure 12. Chute moves can be used to generate all reduced pipe dreams. We shall modify the definition

$$\begin{array}{c} + + \cdots + + + \\ + + \cdots + + \end{array} \implies \begin{array}{c} + + \cdots + + \\ + + \cdots + + \end{array}$$

FIGURE 12. Classical chute move.

of chute move described in [17, Definition 16.6], and use it to generate all concurrent vertex maps from a special one (see Proposition 3.14).

**Definition 3.7.** Let  $C \subseteq L$ . We denote the points in  $C$  by “.” and points in  $L \setminus C$  by “+”. For  $\alpha \in V_{\text{target}}$ , a **horizontal chutable rectangle** is a  $2 \times r$  block inside  $A_\alpha$  consisting of “+” and “.” such that  $r \geq 2$ , and the only “.” in the block are its NE, SE, SW corners, that is, there is a rectangle  $[i, i+1]_{\mathbb{R}} \times [j, j+r-1]_{\mathbb{R}} \subseteq [1, a_\alpha]_{\mathbb{R}} \times [1, b_\alpha]_{\mathbb{R}}$  such that

$$\phi_\alpha^{-1}(C) \cap ([i, i+1]_{\mathbb{R}} \times [j, j+r-1]_{\mathbb{R}}) = \{(i+1, j), (i, j+r-1), (i+1, j+r-1)\}.$$

Applying a **horizontal chute move** to  $C$  at  $(i+1, j+r-1)$  (or  $\phi_\alpha^{-1}(i+1, j+r-1)$ ) is accomplished by placing a “.” in the NW corner of a horizontal chutable rectangle and removing the “.” from the SE corner of that rectangle; in other words,

$$C' = C \cup \{\phi_\alpha((i, j))\} \setminus \{\phi_\alpha(i+1, j+r-1)\}.$$

where  $i, j, r$  are as above. We denote the above horizontal chute move by  $C \rightarrow C'$ . Reversely, we say that  $C' \dashrightarrow C$  is an **inverse horizontal chute move**. We say that  $(i+1, j+r-1)$

(or  $\phi_\alpha(i+1, j+r-1)$ ) is **horizontal chute movable**. Similarly, we can define a **vertical chutable rectangle**, a **vertical chute move**, an **inverse vertical chute move**, and **vertical chute movable**. (See Figure 13.)

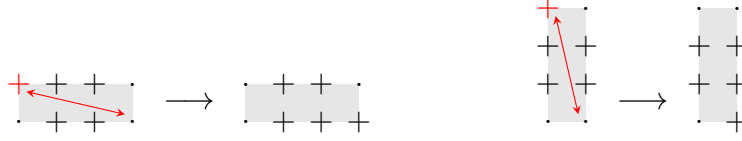

FIGURE 13. Left: a horizontal chutable rectangle and a horizontal chute move; Right: a vertical chutable rectangle and a vertical chute move.

**Remark 3.8.** (i) Note that if  $P \in C$  is chute movable, then there is no ambiguity in determining which chute move to apply. Indeed, if both horizontal and vertical chute moves can be applied to  $C$  at  $P$ , then the chutable rectangle is a  $2 \times 2$  block and the horizontal chute move coincides with the vertical one.

(ii) A horizontal (resp. vertical) move defined here is analog to a chute move (resp. ladder move) defined by Bergeron and Sara Billey; see [2] and [9, Def 3.7.2].

(iii) Under the order “ $<_T$ ”, a (horizontal or vertical) chute move decreases an element, and an inverse (horizontal or vertical) chute move increases an element.

**Lemma 3.9.** *A (horizontal or vertical) chute move sends a  $\mathbf{u}$ -compatible subset of  $L$  to a  $\mathbf{u}$ -compatible subset of  $L$ . In particular, it sends a concurrent vertex map  $C$  to a concurrent vertex map  $C'$  where  $C' <_T C$ . The analog holds for an inverse (horizontal or vertical) chute move, except that  $C'$  satisfies  $C' >_T C$  instead.*

*Proof.* We only prove that if an inverse horizontal chute move sends a  $\mathbf{u}$ -compatible subset  $C$  to  $C'$ , then  $C'$  is  $\mathbf{u}$ -compatible; the rest can be proved similarly. Let  $\alpha, i, j, r$  be defined in Definition 3.7. We assume by contradiction that there exists  $\gamma \in V_{\mathcal{Q}}$  such that  $C'^\gamma$  contains a diagonal chain  $D = \{P_1, \dots, P_{u_\gamma+1}\}$ . Since  $D$  cannot be a diagonal chain in  $C^\gamma$ , the point  $\phi_\gamma^{-1}\phi_\alpha(i+1, j+r-1)$  must coincide with a point  $P_\ell$  in  $D$ . Assume  $P_\ell$  is in  $\text{Page}_k$  and the arrow  $h_k$  is  $\beta \rightarrow \alpha$ . Define  $P_\ell'' = \phi_\gamma^{-1}\phi_\alpha(i, j+r-1)$ , and define (if possible)  $P_\ell' = \phi_\gamma^{-1}\phi_\alpha(i+1, j)$ ,  $P_\ell''' = \phi_\gamma^{-1}\phi_\alpha(i, j)$ . We claim that either  $D \cup \{P_\ell'\} \setminus \{P_\ell\}$  or  $D \cup \{P_\ell''\} \setminus \{P_\ell\}$  is a diagonal chain in  $C$  of size  $(u_\gamma+1)$ , contradicting the assumption that  $C$  is a concurrent vertex map. We prove the claim by considering the following two cases separately.

Case 1: either  $\gamma = \alpha$ , or “ $\gamma = \beta$  and  $P_\ell'''$  is defined and lies in the same block of  $A_\beta$  with  $P_\ell$ ”. Then  $D \cup \{P_\ell'\} \setminus \{P_\ell\}$  is a diagonal chain if  $P_{\ell-1}$  is NW of  $P_\ell'$ ;  $D \cup \{P_\ell''\} \setminus \{P_\ell\}$  is a diagonal chain if  $P_{\ell-1}$  is NW of  $P_\ell''$ . If none of these two conditions hold, then  $P_{\ell-1}$ , which is a point in  $\phi_\alpha^{-1}(C')$ , must be weakly SE of  $P_\ell''$  and (strongly) NW of  $P_\ell$ , which gives the desired contradiction because such a point does not exist. See Figure 14 Left.

Case 2:  $\gamma = \beta$ , and either  $P_\ell'''$  is undefined or  $P_\ell'''$  and  $P_\ell$  lie in different blocks of  $A_\beta$ . In this case,  $\phi_\beta^{-1}(C')$  has no point to the left of  $P_\ell''$ . Note that  $D \cup \{P_\ell''\} \setminus \{P_\ell\}$  is a diagonal

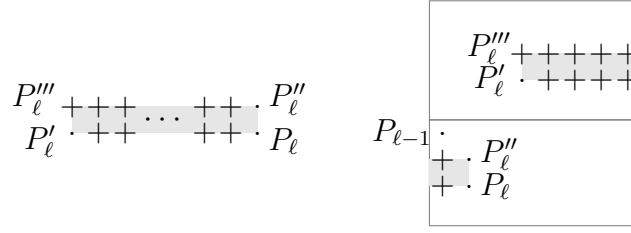
 FIGURE 14. Lemma 3.9. Pictures of  $C'$ . Left: Case 1; Right: Case 2.

chain in  $C^\gamma$  of size  $(u_\gamma + 1)$ ; otherwise,  $(P_{\ell-1})_x = (P_\ell)_x - 1$ , thus  $P_{\ell-1}$  is a point in  $\phi_\beta^{-1}(C')$  and lies to the left of  $P_\ell''$ , a contradiction. See Figure 14 Right.  $\square$

**Definition 3.10.** We define the **initial concurrent vertex map** to be  $C_{\max}(\emptyset)$ .

**Lemma 3.11.** Let  $C$  be a concurrent vertex map. The following are equivalent.

- (i)  $C = C_{\max}(\emptyset)$ ;
- (ii)  $C$  has no essential NW corners;
- (iii)  $C$  is not inverse chute movable;
- (iv) for each  $k$  with  $h_k : \beta \rightarrow \alpha$ , define  $S_k^\alpha := \sum_{\beta' \succeq_k^\alpha} u_{\beta'}$ , where the sum is over all arrows  $h_{k'} : \beta' \rightarrow \alpha$  satisfying  $k' > k$  and  $\mathfrak{t}(h_k) = \alpha$ ; define  $S_k^\beta := \sum_{\alpha' \succeq_k^\beta} u_{\alpha'}$ , where the sum is over all arrows  $h_{k'} : \beta \rightarrow \alpha'$  satisfies the condition that  $k' > k$  and  $\mathfrak{s}(h_k) = \beta$ ; then

$$(19) \quad C|_k = \left( \left( \text{the bottom } u_\alpha \text{ rows} \right) \cup \left( \text{the rightmost } [u_\alpha - S_k^\alpha]_+ \text{ columns} \right) \right) \cap \left( \left( \text{the bottom } [u_\beta - S_k^\beta]_+ \text{ rows} \right) \cup \left( \text{the rightmost } u_\beta \text{ columns} \right) \right).$$

It can be pictured in two cases as shown in Figure 15.

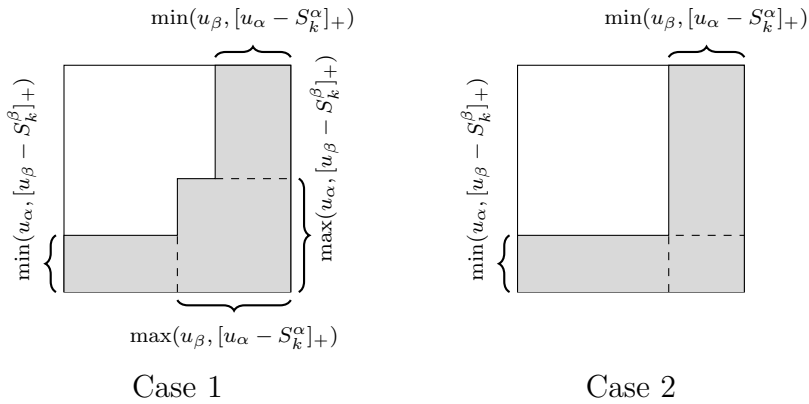

FIGURE 15. Lemma 3.11 (iv)  $C|_k$  consists of the lattice points in the gray region. Case 1 is when  $(u_\alpha - [u_\beta - S_k^\beta]_+)(u_\beta - [u_\alpha - S_k^\alpha]_+) \geq 0$ . Case 2 is when  $(u_\alpha - [u_\beta - S_k^\beta]_+)(u_\beta - [u_\alpha - S_k^\alpha]_+) \leq 0$ .

(v) The straight road map  $(\{H_p^\alpha\}, \{V_q^\beta\})$  corresponding to  $C$  is as follows. For  $\alpha \in V_{\text{target}}$  and  $1 \leq p \leq u_\alpha$ , let  $k$  be the unique integer such that the target of  $h_k$  is  $\alpha$ , and

$$(20) \quad (S_k^\alpha =) \sum_{\beta' \xrightarrow{k} \alpha} u_{\beta'} < u_\alpha - p + 1 \leq \sum_{\beta' \xrightarrow{\geq k} \alpha} u_{\beta'}.$$

Define  $j_p^\alpha := p - u_\alpha + \sum_{\beta' \xrightarrow{\leq k} \alpha} b_{\beta'} + \sum_{\beta' \xrightarrow{\geq k} \alpha} u_{\beta'}$ . Then  $H_p^\alpha$  is the path obtained by connecting vertices  $(a_\alpha - u_\alpha + p, 1)$ ,  $(a_\alpha - u_\alpha + p, j_p^\alpha)$ ,  $(p, j_p^\alpha)$ ,  $(p, b_\alpha)$ . (See Figure 16 Left.)

For  $\beta \in V_{\text{source}}$  and  $1 \leq q \leq u_\beta$ , let  $k$  be the unique integer such that the source of  $h_k$  is  $\beta$ , and

$$(S_k^\beta =) \sum_{\alpha' \xrightarrow{k} \beta} u_{\alpha'} < u_\beta - q + 1 \leq \sum_{\alpha' \xrightarrow{\geq k} \beta} u_{\alpha'}.$$

Define  $j_q^\beta := q - u_\beta + \sum_{\alpha' \xrightarrow{\leq k} \beta} a_{\alpha'} + \sum_{\alpha' \xrightarrow{\geq k} \beta} u_{\alpha'}$ . Then  $V_q^\beta$  is the path obtained by connecting vertices  $(1, b_\beta - u_\beta + q)$ ,  $(j_q^\beta, b_\beta - u_\beta + q)$ ,  $(j_q^\beta, q)$ ,  $(a_\beta, q)$ . (See Figure 16 Right.)

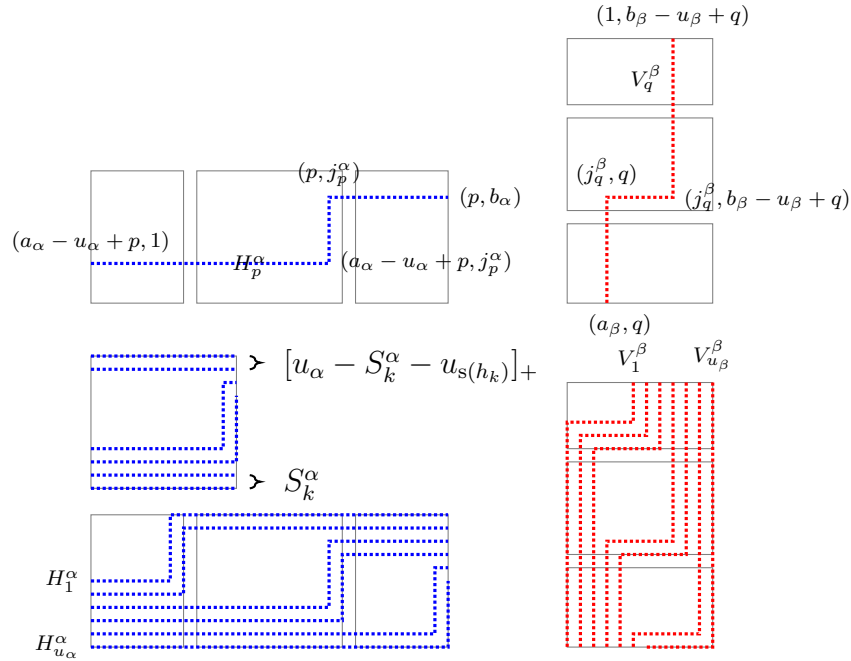

FIGURE 16. Lemma 3.11 (v),  $H_p^\alpha$  and  $V_q^\beta$ . Left Top: a horizontal path  $H_p^\alpha$ ; Left Middle: all horizontal paths in  $\text{Page}_k$ ; Left Bottom: all horizontal paths in  $A_\alpha$ ; Right Top: a vertical path  $V_q^\beta$ ; Right Bottom: all vertical paths in  $A_\beta$ .

*Proof.* We first show that the road map  $(\{H_p^\alpha\}, \{V_q^\beta\})$  given in (v) is straight. Fix an arrow  $h_k : \beta \rightarrow \alpha$ . Note that if  $u_\alpha - S_k^\alpha \leq u_\beta$ , then  $\cup_p H_p^\alpha$  covers the bottom  $u_\alpha$  rows and the rightmost  $[u_\alpha - S_k^\alpha]_+ = \min([u_\alpha - S_k^\alpha]_+, u_\beta)$  columns of  $\text{Page}_k$ ; if  $u_\alpha - S_k^\alpha > u_\beta$ , then  $\cup_p H_p^\alpha$  covers the top  $u_\alpha - S_k^\alpha - u_\beta$  rows, the bottom  $u_\beta + S_k^\alpha$  rows, and the rightmost  $u_\beta = \min([u_\alpha - S_k^\alpha]_+, u_\beta)$  columns of  $\text{Page}_k$ . Consequently,  $\cup_p H_p^\alpha$  covers the bottom  $\min(u_\alpha, u_\beta + S_k^\alpha)$  rows; if

the corners of  $H_p^\alpha$  are on  $\text{Page}_k$ , they must lie in the rightmost  $\min([u_\alpha - S_k^\alpha]_+, u_\beta)$  columns. Similarly,  $\cup_q V_q^\beta$  covers the rightmost  $\min(u_\beta, u_\alpha + S_k^\beta)$  columns; if the corners of  $V_q^\beta$  are on  $\text{Page}_k$ , they must lie in the bottom  $\min([u_\beta - S_k^\beta]_+, u_\alpha)$  rows. To show the corners of  $H_p^\alpha$  are contained in vertical paths, it suffices to show that  $\min([u_\alpha - S_k^\alpha]_+, u_\beta) \leq \min(u_\beta, u_\alpha + S_k^\beta)$ , which is obviously true. Similarly, any corner of a vertical path lies in a horizontal path. Thus the road map is straight.

(iv) $\Leftrightarrow$ (v). Since a concurrent vertex map uniquely determines the road map by Proposition 2.5, we just need to show that  $C$  given in (iv) is induced by the road map given in (v). The proof is easy so we skip.

(v) $\Rightarrow$ (ii). We shall show that the NW corner  $(p, j_p^\alpha)$  of  $H_p^\alpha$  is  $Q_{p, p+v_\alpha-u_\alpha}$ , so is non-essential. Assume  $(p, j_p^\alpha)$  is in  $\text{Page}_k$ . Then it lies in the  $q'$ -th column from the right in  $\text{Page}_k$ , where  $q' = \sum_{\beta' \leq_k^\alpha} b_{\beta'} - j_p^\alpha + 1$ . Let  $\beta = s(h_k)$  and  $V_q^\beta$  be the  $q'$ -th vertical path in  $A_\beta$  counting from the right side. So  $q = u_\beta + 1 - q' = u_\beta - \sum_{\beta' \leq_k^\alpha} b_{\beta'} + j_p^\alpha = u_\beta - \sum_{\beta' \leq_k^\alpha} b_{\beta'} + (p - u_\alpha + \sum_{\beta' \leq_k^\alpha} b_{\beta'} + \sum_{\beta' \geq_k^\alpha} u_{\beta'}) = p - u_\alpha + \sum_{\beta' \geq_k^\alpha} u_{\beta'}$ .

We claim that the point  $\phi_\beta^{-1} \phi_\alpha(p, j_p^\alpha) = (\sum_{\alpha' \leq_k^\beta} a_{\alpha'} + p, b_\beta - q' + 1)$  is contained in  $V_q^\beta$ . Indeed, note that in  $A_\beta$ , the corners of  $V_q^\beta$  (whose  $x$ -coordinate is  $j_q^\beta$ ) are weakly below the horizontal line  $x = \sum_{\alpha' \leq_k^\beta} a_{\alpha'} + p$  (which contains the point  $\phi_\beta^{-1} \phi_\alpha(p, j_p^\alpha)$ ) because  $j_q^\beta - (\sum_{\alpha' \leq_k^\beta} a_{\alpha'} + p) = (q - u_\beta + \sum_{\alpha' \leq_k^\beta} a_{\alpha'} + \sum_{\alpha' \geq_k^\beta} u_{\alpha'}) - \sum_{\alpha' \leq_k^\beta} a_{\alpha'} - p = q - u_\beta + a_\alpha + \sum_{\alpha' \geq_k^\beta} u_{\alpha'} - p = a_\alpha - u_\alpha + \sum_{\beta' \geq_k^\alpha} u_{\beta'} + \sum_{\alpha' \geq_k^\beta} u_{\alpha'} \geq a_\alpha - u_\alpha \geq 0$ . Since  $V_q^\beta$  contains all the points whose  $x$ -coordinate is  $\leq j_q^\beta$  and  $y$ -coordinate is  $b_\beta - q' + 1$ , it contains the point  $\phi_\beta^{-1} \phi_\alpha(p, j_p^\alpha)$ . this proves the claim, which then implies that  $(p, j_p^\alpha)$  is contained in  $\phi_\alpha^{-1}(V_q^\beta|_k)$ .

Next, we show that

$$(21) \quad V_{p+v_\alpha-u_\alpha}^\alpha = \phi_\alpha^{-1}(V_q^\beta|_k) \text{ with } q = p - u_\alpha + \sum_{\beta' \geq_k^\alpha} u_{\beta'}.$$

Indeed,  $V_q^\beta|_k$  is the  $q$ -th vertical path in  $\text{Page}_k$ , and there are another  $\sum_{\beta' \leq_k^\alpha} u_{\beta'}$  vertical path in the blocks left to  $\text{Page}_k$  in  $A_\alpha$ , so the index of the vertical path  $\phi_\alpha^{-1}(V_q^\beta|_k)$  in  $A_\alpha$  is  $q + \sum_{\beta' \leq_k^\alpha} u_{\beta'} = (p - u_\alpha + \sum_{\beta' \geq_k^\alpha} u_{\beta'}) + \sum_{\beta' \leq_k^\alpha} u_{\beta'} = p + v_\alpha - u_\alpha$ . Therefore,  $(p, j_p^\alpha) = Q_{p, p+v_\alpha-u_\alpha}$ , thus the NW corner of  $H_p^\alpha$  is nonessential. Similarly we can show that the NW corner of a vertical path is non-essential. Thus (v) $\Rightarrow$ (ii).

(ii) $\Rightarrow$ (v). Let  $C$  be a concurrent vertex map without essential NW corners,  $(\{H_p^\alpha\}, \{V_q^\beta\})$  be the corresponding road map. Each  $H_p^\alpha$  contains exactly one NW corner:  $Q_{p, p+v_\alpha-u_\alpha}$ . So  $H_p^\alpha$  consists of only three segments: two horizontal segments connected by a vertical segment. Each  $V_q^\beta$  satisfies a similar condition.

Now fix  $\alpha$  and  $p$ . Assume  $Q_{p, p+v_\alpha-u_\alpha}$  is in  $\text{Page}_k$ . Then  $h_k$  must have target  $\alpha$ , so we denote  $h_k : \beta \rightarrow \alpha$ . By (21),  $V_{p+v_\alpha-u_\alpha}^\alpha = \phi_\alpha^{-1}(V_q^\beta|_k)$  where  $p, q$  satisfy  $p - q = u_\alpha - \sum_{\beta' \geq_k^\alpha} u_{\beta'}$ . Note that  $Q_{p, p+v_\alpha-u_\alpha}$  is not a corner of  $V_{p+v_\alpha-u_\alpha}^\alpha$ ; otherwise  $Q_{p, p+v_\alpha-u_\alpha}$  must be a SE corner



of  $V_{p+v_\alpha-u_\alpha}^\alpha$  as well as a NW corner of  $H_p^\alpha$ , which is impossible. Consequently,  $V_q^\beta$  goes through  $\phi_\beta^{-1}\phi_\alpha(Q_{p,p+v_\alpha-u_\alpha})$  vertically without turn. So the horizontal segment of  $V_q^\beta$  is either strictly below or strictly above  $\phi_\beta^{-1}\phi_\alpha(Q_{p,p+v_\alpha-u_\alpha})$ . We claim that the latter cannot hold. Otherwise, in  $A_\beta$ ,  $(P'_{q+v_\beta-u_\beta,q})_y < (\phi_\beta^{-1}\phi_\alpha(Q_{p,p+v_\alpha-u_\alpha}))_y$ , so the path  $H_{q+v_\beta-u_\beta}^\beta$  is above the path  $\phi_\beta^{-1}(H_p^\alpha|_k) = H_{p+\sum_{\alpha' \prec^k \beta} u_{\alpha'}}^\beta$ . Thus  $q + v_\beta - u_\beta < p + \sum_{\alpha' \prec^k \beta} u_{\alpha'}$ . Since  $v_\beta = \sum_{\alpha' \prec \beta} u_{\alpha'}$ , the above inequality implies  $p - q > \sum_{\alpha' \succ^k \beta} u_{\alpha'} - u_\beta$ , thus  $u_\alpha - \sum_{\beta' \succ^k \alpha} u_{\beta'} = p - q > \sum_{\alpha' \succ^k \beta} u_{\alpha'} - u_\beta$ , which implies a contradiction that  $\sum_{\alpha' \succ^k \beta} u_{\alpha'} + \sum_{\beta' \succ^k \alpha} u_{\beta'} < 0$ .

The claim implies that the  $y$ -coordinate of  $Q_{p,p+v_\alpha-u_\alpha}$  is uniquely determined, since  $\phi_\beta^{-1}\phi_\alpha(Q_{p,p+v_\alpha-u_\alpha})$  is on the vertical line  $y = b_\beta - u_\beta + q$ . In other words, each  $H_p^\alpha$  is uniquely determined. Similarly, each  $V_q^\beta$  is uniquely determined. Thus the road map has to be the unique one given by (v).

(iv) $\Rightarrow$ (i). Indeed, by Lemma 3.5,  $C_{\max}(\emptyset)$  has no essential NW corners, so it satisfies (ii). By the proof of (ii) $\Rightarrow$ (v),  $C_{\max}(\emptyset)$  coincides with  $C$  defined in (iv).

(iii) $\Rightarrow$ (ii). We show the contrapositive, that is, if  $C$  has an essential NW corner, then it is inverse chute movable. Indeed, consider the two cases given in Lemma 3.5. In Case 1 (see Figure 8), the point  $\phi_\alpha^{-1}(i', j', k') - (1, 1)$  in  $C$  can be inverse chute moved to  $\phi_\alpha^{-1}(i', j', k')$ . In Case 2 (see Figure 9), the point  $R_{p+t,q+t}$  in  $C$  can be inverse chute moved to  $R_{p+t,q+t} + (1, 1)$  if  $R_{p+t,q+t} \neq Q_{p+t,q+t}$ , or to  $\phi_\alpha^{-1}(i', j', k')$  if  $R_{p+t,q+t} = Q_{p+t,q+t}$ .

(i) $\Rightarrow$ (iii). Indeed, if  $C$  is inverse chute movable, then after a inverse chute move we get  $C' >_T C_{\max}(\emptyset)$ , contradicting the definition of  $C_{\max}(\emptyset)$ .

Now we have proved that (iv) $\Leftrightarrow$ (v) $\Leftrightarrow$ (ii) $\Leftarrow$ (iii) $\Leftarrow$ (i) $\Leftarrow$ (iv). This completes the proof of Lemma 3.11.  $\square$

**Remark 3.12.** (a) We describe the initial concurrent vertex map  $C_{\max}(\emptyset)$  for double determinantal ideals  $I_{m,n,u,v}^{(r)}$  for  $\mathcal{Q} : 2 \xrightarrow{r} 1$  which has  $r$  arrows from 2 to 1. Assume without loss of generality that  $u \geq v$ . It is easy to check that the region for  $C_{\max}(\emptyset)$  given in Lemma 3.11 (iv) becomes Figure 17.

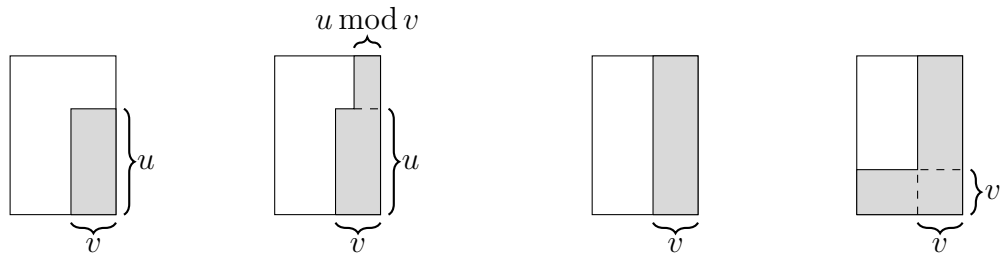

Pages  $1, \dots, r - \lfloor \frac{u}{v} \rfloor - 1$ . Page  $r - \lfloor \frac{u}{v} \rfloor$ . Pages  $r - \lfloor \frac{u}{v} \rfloor + 1, \dots, r - 1$ . Page  $r$ .

FIGURE 17.  $C_{\max}(\emptyset)$  for a double determinantal ideal (the grey region).

(b) In the special case of (a) when  $u = v$ , Figure 17 specializes to Figure 18.

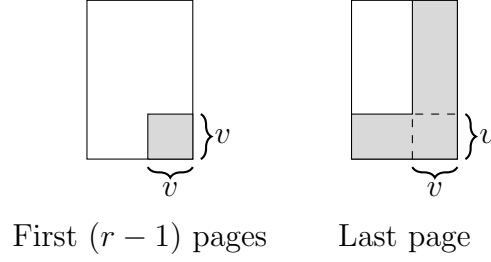

FIGURE 18.  $C_{\max}(\emptyset)$  for a double determinantal ideal in the special case  $u = v$ .

**Lemma 3.13.** *If  $(i, j, k) \in C$  is an essential horizontal (resp. vertical) NW corner and  $C'$  is obtained as in Lemma 3.5, then  $C'$  can be obtained from  $C$  by a sequence of inverse horizontal (resp. vertical) chute moves. A similar statement holds for an essential SE corner.*

*Proof.* We only prove the first statement. Use the notations in the proof of Lemma 3.5. Without loss of generality, assume  $(i, j, k)$  is an essential horizontal NW corner. If  $(i, j, k)$  is a vertical NW corner (see Fig 8): we obtain  $C'$  from  $C$  by applying inverse horizontal chute moves to  $(i' - 1, j' - 1, k)$ ,  $(i' - 2, j' - 2, k)$ ,  $\dots$ ,  $(i, j, k)$  in order. Otherwise (see Fig 9): we obtain  $C'$  from  $C$  by applying inverse horizontal moves to the following points in order:  $R_{p+t, q+t}$ ,  $R_{p+t, q+t} + (0, 1)$ ,  $\dots$ ,  $Q_{p+t, q+t}$ ;  $R_{p+t-1, q+t-1}$ ,  $R_{p+t-1, q+t-1} + (0, 1)$ ,  $\dots$ ,  $Q_{p+t-1, q+t-1}$ ;  $\dots$ ;  $R_{p+1, q+1}$ ,  $R_{p+1, q+1} + (0, 1)$ ,  $\dots$ ,  $Q_{p+1, q+1}$ ;  $Q_{pq}$ .  $\square$

**Proposition 3.14.** *Every concurrent vertex map  $C \neq C_{\max}(\emptyset)$  can be obtained from  $C_{\max}(\emptyset)$  by a sequence of (horizontal or vertical) chute moves. A similar statement holds for  $C_{\min}(\emptyset)$  with chute moves replaced by inverse chute moves.*

*Proof.* We only prove the first statement. Start with  $C$  and iteratively apply inverse chute movables if possible, we will get  $C_{\max}(\emptyset)$  by Lemma 3.11. The proposition is proved by reversing the process.  $\square$

**3.3. Vertex-decomposable.** First recall the definition of (pure) vertex-decomposable (see [9, Def 1.8.5] or [17, Definition 16.41]). Given a vertex  $v$  in a simplicial complex  $\Delta$ , we define the deletion operator  $\text{del}_v \Delta = \{G \in \Delta \mid v \notin G\}$  and the link operator  $\text{link}_v \Delta = \{G \in \Delta \mid v \notin G, G \cup \{v\} \in \Delta\}$ . (Note that  $\text{del}_v \Delta$  and  $\text{link}_v \Delta$  are undefined if  $v$  is not a vertex in  $\Delta$ .) Then  $\Delta$  is called vertex-decomposable if  $\Delta$  is pure and either (i)  $\Delta = \{\emptyset\}$ , or (ii) for some vertex  $v \in \Delta$ , both  $\text{del}_v \Delta$  and  $\text{link}_v \Delta$  are vertex-decomposable.

**Proposition 3.15.** *The simplicial complex  $\Delta_{\mathcal{Q}, \mathbf{m}, \mathbf{u}}$  is vertex-decomposable. Consequently,  $\Delta_{\mathcal{Q}, \mathbf{m}, \mathbf{u}}$  is pure, shellable, and the bipartite determinantal ideal  $I_{\mathcal{Q}, \mathbf{m}, \mathbf{u}}$  is Cohen-Macaulay.*

*Proof.* Write  $L = \{v_1, \dots, v_{|L|}\}$  such that  $v_1 <_T v_2 <_T \dots <_T v_{|L|}$ . We claim that for any  $0 \leq \ell \leq |L|$  and any subset  $S \subseteq \{v_1, \dots, v_\ell\}$ , the simplicial complex  $\Delta_{\ell, S} := F_{v_\ell} \dots F_{v_2} F_{v_1} \Delta_{\mathcal{Q}, \mathbf{m}, \mathbf{u}}$  is pure if it defined, where

$$F_{v_i} := \begin{cases} \text{link}_{v_i}, & \text{if } v_i \in S; \\ \text{del}_{v_i}, & \text{if } v_i \notin S. \end{cases}$$

The claim implies that all the well-defined  $\Delta_{\ell,S}$  are vertex-decomposable, in particular (when  $\ell = 0$ )  $\Delta_{\mathcal{Q},\mathbf{m},\mathbf{u}}$  is vertex-decomposable. Note that  $\Delta_{\ell,S}$  is well-defined if and only if  $v_i \in F_{v_{i-1}} \cdots F_{v_1} \Delta_{\mathcal{Q},\mathbf{m},\mathbf{u}}$  for  $1 \leq i \leq \ell$ . The idea to prove the claim is that, for each well-defined  $\Delta_{\ell,S}$ , we construct a facet  $C_{\ell,S}$  such that any facet of  $\Delta_{\ell,S}$  can be converted into  $C_{\ell,S}$  by repeatedly applying inverse chute moves. Thus all facets of  $\Delta_{\ell,S}$  have the same dimension, which implies that  $\Delta_{\ell,S}$  is pure.

To prove the claim, first note that the faces of  $\Delta_{\ell,S}$  have the following easy description:

$$(22) \quad \Delta_{\ell,S} = \{C_2 \subseteq \{v_{\ell+1}, \dots, v_{|L|}\} \mid C_2 \cup S \text{ is } \mathbf{u}\text{-compatible}\}.$$

Indeed this can be proved by induction on  $\ell$ . For the base case  $\ell = 0$ , we have  $S = \emptyset$ , the faces of  $\Delta_{\ell,S} = \Delta_{\mathcal{Q},\mathbf{m},\mathbf{u}}$  are exactly those  $\mathbf{u}$ -compatible sets. For the inductive step, assume  $\ell > 0$  and the (22) holds for  $\ell - 1$ . We consider two cases separately. If  $v_\ell \in S$ , then  $\Delta_{\ell,S} = \text{link}_{v_\ell} \Delta_{\ell-1, S \setminus \{v_\ell\}} = \{G \mid v_\ell \notin G, G \cup \{v_\ell\} \in \Delta_{\ell-1, S \setminus \{v_\ell\}}\} = \{G \mid v_\ell \notin G, G \cup \{v_\ell\} \subseteq \{v_\ell, \dots, v_{|L|}\}, G \cup \{v_\ell\} \cup (S \setminus \{v_\ell\}) \text{ is } \mathbf{u}\text{-compatible}\} = \{G \subseteq \{v_{\ell+1}, \dots, v_{|L|}\} \mid G \cup S \text{ is } \mathbf{u}\text{-compatible}\}$ . If  $v_\ell \notin S$ , then  $\Delta_{\ell,S} = \text{del}_{v_\ell} \Delta_{\ell-1, S} = \{G \in \Delta_{\ell-1, S} \mid v_\ell \notin G\} = \{G \subseteq \{v_\ell, \dots, v_{|L|}\} \mid v_\ell \notin G, G \cup S \text{ is } \mathbf{u}\text{-compatible}\} = \{G \subseteq \{v_{\ell+1}, \dots, v_{|L|}\} \mid G \cup S \text{ is } \mathbf{u}\text{-compatible}\}$ . So the inductive step is done in both cases.

Note that  $\Delta_{\ell,S}$ , if well-defined, contains  $\emptyset$ . Define  $C_{\ell,S} := C_{\max}(S) \cap \{v_{\ell+1}, \dots, v_{|L|}\}$ , which is obviously a face of  $\Delta_{\ell,S}$ . Fix a facet  $C_2$  of  $\Delta_{\ell,S}$ . We shall show that

$$(23) \quad |C_2| = |C_{\ell,S}|.$$

Note that

$$(24) \quad C_2 = C_{\max}(S \cup C_2) \cap \{v_{\ell+1}, \dots, v_{|L|}\}$$

Indeed, let  $C := C_{\max}(S \cup C_2)$ . The inclusion “ $\subseteq$ ” is obvious; the right side is a face of  $\Delta_{\ell,S}$  containing the facet  $C_2$ , thus the equality must hold. Denote  $C_1 = C \setminus C_2 = C \cap \{v_1, \dots, v_\ell\}$ . So  $C$  is the disjoint union  $C_1 \cup C_2$ , and  $S \subseteq C_1$ .

To prove (23), we first reduce to the case when  $C$  is not inverse chute movable at any point in  $C_2$ . Indeed, assume that  $C \dashrightarrow C'$  is an inverse chute move that moves  $P \in C_2$  to  $P' \in C'$ . Then  $P' \notin C_2$ ,  $P' >_T P >_T v_\ell$ ,  $C_1 \subseteq C \setminus \{P\} \subset C \setminus \{P\} \cup \{P'\} = C'$ . Define

$$(25) \quad C'_2 := C' \setminus C_1 = C_2 \setminus \{P\} \cup \{P'\}.$$

Then  $P' \in C'_2 \subseteq \{v_{\ell+1}, \dots, v_{|L|}\}$ ,  $C' = C_1 \cup C'_2$ . Without loss of generality, assume  $C \dashrightarrow C'$  is a horizontal inverse chute move that occurs in  $A_\alpha$ . The corresponding horizontal chute rectangle  $R$  has  $\phi_\alpha^{-1}(P)$  as its NW vertex and  $\phi_\alpha^{-1}(P')$  as its SE vertex. Since  $C'_2 \cup S \subseteq C'$  is  $\mathbf{u}$ -compatible,  $C'_2$  is a face of  $\Delta_{\ell,S}$ .

**Claim  $\star$ :** If  $C_2$  is a facet of  $\Delta_{\ell,S}$ , then  $C'_2$  constructed in (25) is also a facet of  $\Delta_{\ell,S}$ .

**Proof of Claim  $\star$ .** Assume  $C'_2$  is not a facet. Then there exists a larger face  $C''_2 = C'_2 \cup \{P''\} \supsetneq C'_2$  of  $\Delta_{\ell,S}$ . So  $S \cup C'_2 \cup \{P''\}$  is  $\mathbf{u}$ -compatible. We consider three cases depending on the position of  $P''$ .

Case 1:  $\phi_\alpha^{-1}(P'')$  lies outside the horizontal chute rectangle  $R$ . In this case,  $S \cup C'_2 \cup \{P''\} \rightarrow S \cup C_2 \cup \{P''\}$  is a horizontal chute move. By Lemma 3.9,  $S \cup C_2 \cup \{P''\}$  is  $\mathbf{u}$ -compatible, contradicting the assumption that  $C_2$  is a facet of  $\Delta_{\ell,S}$ .

Case 2:  $\phi_\alpha^{-1}(P'')$  lies in the first row of  $R$ . We shall show that this case will not occur by proving the statement that  $C_2 \cup \{P'\}$  ( $= C_2' \cup \{P\}$ ) is a face of  $\Delta_{\ell,S}$ , which contradicts the assumption that  $C_2$  is a facet. The proof is similar to the one of Lemma 3.9. We prove by contradiction by assuming  $S \cup C_2 \cup \{P'\}$  ( $= S \cup C_2' \cup \{P\}$ ) is not  $\mathbf{u}$ -compatible. Then there exists  $\gamma \in V_{\mathcal{Q}}$  such that  $D = \{P_1, \dots, P_{u_\gamma+1}\} \subseteq (S \cup C_2' \cup \{P\})^\gamma$  is a diagonal chain of size  $u_\gamma + 1$ . Since  $S \cup C_2$  and  $S \cup C_2'$  are  $\mathbf{u}$ -compatible,  $\phi_\gamma^{-1}(P')$  and  $\phi_\gamma^{-1}(P)$  must both be in  $D$ . Assume  $\phi_\gamma^{-1}(P') = P_\ell$ , and  $P'$  is in  $\text{Page}_k$ . Then  $h_k$  must have target  $\alpha$  so we denote  $h_k : \beta \rightarrow \alpha$ . Note that  $\gamma = \alpha$  or  $\beta$ . Write  $(i, j) = \phi_\alpha^{-1}(P)$ ,  $(i+1, j+r-1) = \phi_\alpha^{-1}(P')$ . Define  $P_\ell'' = \phi_\gamma^{-1}\phi_\alpha(i, j+r-1)$ , and if possible, define  $P_\ell' = \phi_\gamma^{-1}\phi_\alpha(i+1, j)$ ,  $P_\ell''' = \phi_\gamma^{-1}\phi_\alpha(i, j)$ . We need to consider two subcases:

–Subcase 1: either  $\gamma = \alpha$ , or “ $\gamma = \beta$  and  $P_\ell'''$  is defined and lies in the same block of  $A_\beta$  with  $P_\ell$ ”. Then  $\phi_\gamma^{-1}(P) = P_{\ell-1}$ , and  $D \setminus \{P_{\ell-1}\} \cup \{\phi_\gamma^{-1}(P'')\} \subseteq (S \cup C_2' \cup \{P''\})^\gamma$  is a diagonal chain of size  $u_\gamma + 1$  because  $\phi_\gamma^{-1}(P'')$  is to the east of  $P_{\ell-1}$  and to the NW of  $P_\ell$ . But that contradicts the assumption that  $S \cup C_2' \cup \{P''\}$  is  $\mathbf{u}$ -compatible.

–Subcase 2:  $\gamma = \beta$ , and either  $P_\ell'''$  is undefined or  $P_\ell'''$  lies in different blocks of  $A_\beta$  with  $P_\ell$ . As we have shown in the proof of Lemma 3.9,  $(P_{\ell-1})_x \neq (P_\ell)_x - 1$ . Then  $(P_{\ell-1})_x \leq (P_\ell)_x - 2$ , thus  $D \setminus \{P_\ell\} \cup \{P_\ell''\} \subseteq (S \cup C_2)^\gamma$  is a diagonal chain of size  $u_\gamma + 1$ , contradicting the assumption that  $S \cup C_2$  is  $\mathbf{u}$ -compatible.

Case 3:  $\phi_\alpha^{-1}(P'')$  lies in the second row of  $R$ . In this case, let  $Q$  be the point determined by  $\phi_\alpha^{-1}(Q) = \phi_\alpha^{-1}(P'') - (1, 0)$  be the point above  $\phi_\gamma^{-1}(P'')$ . Then  $C_1 \cup C_2'' = C' \cup \{P''\} \rightarrow C' \cup \{P'', Q\} \setminus \{P'\}$  and  $C' \cup \{P'', Q\} \setminus \{P'\} \rightarrow C' \cup \{P, Q\} \setminus \{P'\} = C \cup \{Q\}$  are both horizontal chute move. By Lemma 3.9,  $C \cup \{Q\}$  is  $\mathbf{u}$ -compatible. Then  $C_2 \cup \{Q\}$  is a face of  $\Delta_{\ell,S}$ , contradicting the assumption that  $C_2$  is a facet. (See Figure 19.)

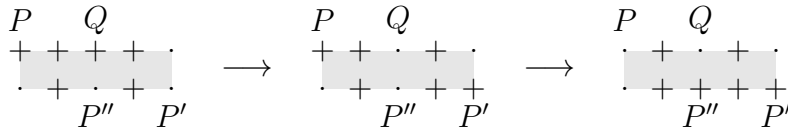

FIGURE 19. Claim  $\star$  Case 3,  $C_1 \cup C_2'' \rightarrow C' \cup \{P'', Q\} \setminus \{P'\} \rightarrow C \cup \{Q\}$ .

This completes the proof of Claim  $\star$ . Thanks for this claim, we can apply inverse chute move repeatedly to  $C_2$  until no more inverse chute move can be applied. So we only need to prove (23) under the assumption that the facet  $C_2$  is not inverse chute movable. Since  $C_2$  is a facet of  $\Delta_{\ell,S}$ , we have  $C_2 = C_{\max}(S \cup C_2) \cap \{v_{\ell+1}, \dots, v_{|L|}\}$  by (24). Let  $T$  be the set of all essential NW corners of  $C_{\max}(S \cup C_2)$ . By Lemma 3.5,  $T \subseteq S \cup C_2$ ; on the other hand,  $C_2$  contains no inverse movable points, so by Lemma 3.13, it contains no essential NW corners. That implies  $T \subseteq S$ . Now we have a chain of inequalities:  $C_{\max}(S) \geq_T C_{\max}(S \cup C_2) = C_{\max}(T) \geq_T C_{\max}(S)$ . So  $C_{\max}(S \cup C_2) = C_{\max}(S)$ . Therefore  $C_2 = C_{\max}(S \cup C_2) \cap \{v_{\ell+1}, \dots, v_{|L|}\} = C_{\max}(S) \cap \{v_{\ell+1}, \dots, v_{|L|}\} = C_{\ell,S}$ . This completes the proof of (23). Therefore  $\Delta_{\ell,S}$  is pure, and the proposition follows.  $\square$

**Corollary 3.16.** *The increasing order under  $<_T$  given in Definition 3.4 (ii) is a shelling order of  $\Delta_{\mathcal{Q},\mathbf{m},\mathbf{u}}$ .*

*Proof.* We shall give two proofs.

Proof 1 (as a corollary of Proposition 3.15). From the proof of the previous proposition we get the shelling order by a recursive argument. First shelling  $\text{del}_{v_1}\Delta_{\mathcal{Q},\mathbf{m},\mathbf{u}} = \{S \in \Delta_{\mathcal{Q},\mathbf{m},\mathbf{u}} | v_1 \notin S\}$  then shelling  $\{S \in \Delta_{\mathcal{Q},\mathbf{m},\mathbf{u}} | v_1 \in S\}$ . The shelling order of the former is obtained by first shelling  $\{S \in \Delta_{\mathcal{Q},\mathbf{m},\mathbf{u}} | v_1, v_2 \notin S\}$  then shelling  $\{S \in \Delta_{\mathcal{Q},\mathbf{m},\mathbf{u}} | v_1 \notin S, v_2 \in S\}$ ; the shelling order of the latter is obtained by first shelling  $\{S \in \Delta_{\mathcal{Q},\mathbf{m},\mathbf{u}} | v_1 \in S, v_2 \notin S\}$  then shelling  $\{S \in \Delta_{\mathcal{Q},\mathbf{m},\mathbf{u}} | v_1, v_2 \in S\}$ . Following this argument, the shelling order we obtain is the decreasing lex order: for  $C = (P_1, \dots, P_N)$  and  $C' = (P'_1, \dots, P'_N)$ , where  $P_1 <_T P_2 <_T \dots <_T P_N$  and  $P'_1 <_T P'_2 <_T \dots <_T P'_N$ ,  $C$  is before  $C'$  if there is an integer  $1 \leq t \leq N$  such that  $P_t >_T P'_t$  and  $P_s = P'_s$  for all  $s < t$ . By symmetry, another valid shelling order is: (following the above notations of  $C$  and  $C'$ )  $C$  is before  $C'$  if there is an integer  $1 \leq t \leq N$  such that  $P_t <_T P'_t$  and  $P_s = P'_s$  for all  $s > t$ . This order coincides with the increasing order under  $<_T$  given in Definition 3.4 (ii).

Proof 2 (as a corollary of Proposition 3.6). It suffices to show that  $\bigcup_{C' <_T C} C' \cap C$  is a union of codimension 1 faces of  $C$  for each  $C$ . Alternatively, let  $C' <_T C$  and  $S = C' \cap C$ ; it suffices to prove the existence of  $C''$  such that  $C'' <_T C$ ,  $|C'' \cap C| = |C| - 1$  and  $S \subseteq C'' \cap C$ .

First we assert that  $S$  does not contain at least one essential SE corner, say  $(i, j, k)$ , of  $C$ . Otherwise by Proposition 3.6, we have the equality  $C_{\min}(S) = C$ ; then  $C_{\min}(S) >_T C'$ . But by definition of  $C_{\max}(S)$  and the fact that  $S \subseteq C'$ , we must have  $C' \geq_T C_{\min}(S)$ , a contradiction.

Next, let  $C'' = C_{\min}(C \setminus \{(i, j, k)\})$ . Again by Proposition 3.6,  $C'' <_T C$ . Note that  $|C'' \cap C| = |C \setminus \{(i, j, k)\}| = |C| - 1$ , so  $C'' \cap C$  is a codimension 1 face of  $C$  which contains  $S$ . Therefore  $\Delta_{\mathcal{Q},\mathbf{m},\mathbf{u}}$  is shellable.  $\square$

**3.4. Ball.** Recall [3, Proposition 4.7.22] (the readers are also referred to [8, Lemma 3.6 and Theorem 3.7] to see how it is applied) asserts that, if every codimension 1 face of a shellable simplicial complex  $\Delta$  is contained in at most two facets, then  $\Delta$  is a topological manifold-with-boundary that is homeomorphic to a ball or a sphere. The facets of the topological boundary are codimension-1 faces contained in exactly one facet. In particular, if  $\Delta$  has a nonempty boundary (that is, there exists a codimension-1 face contained in exactly one facet) then it is homeomorphic to a ball.

**Lemma 3.17.** *Each codimension-1 face  $S$  of  $\Delta_{\mathcal{Q},\mathbf{m},\mathbf{u}}$  is contained in facets  $C_{\max}(S)$  and  $C_{\min}(S)$ , and is not contained in other facets. Consequently, “ $S$  is contained in exactly one facet”  $\Leftrightarrow C_{\max}(S) = C_{\min}(S) \Leftrightarrow S$  contains all the essential SE corners of  $C_{\max}(S) \Leftrightarrow S$  contains all the essential NW corners of  $C_{\min}(S)$ .*

*Proof.* Assume the contrary that there is a  $C$  such that  $C_{\min}(S) <_T C <_T C_{\max}(S)$ . By Proposition 3.6,

$C <_T C_{\max}(S)$  implies  $S$  does not contain at least one essential NW corner  $P$  of  $C$ ;

$C >_T C_{\min}(S)$  implies  $S$  does not contain at least one essential SE corner  $Q$  of  $C$ .

Note that  $P \neq Q$  since  $C$  uniquely determines the horizontal and vertical paths, and NW corner and SE corner do not coincide (indeed, since a NW corner in a horizontal path cannot also be a SE corner of a horizontal path, we can assume  $P$  is a NW corner of a horizontal path,  $Q$  is a SE corner of a vertical path; but this still cannot happen according to the description of straight road map given in Lemma 2.2). Thus  $|S| \leq |C \setminus \{P, Q\}| = |C| - 2$  contradicting the assumption  $|S| = N_{\mathcal{Q}, \mathbf{m}, \mathbf{u}} - 1 = |C| - 1$ . This proves the first statement.

The consequence follows from Proposition 3.6.  $\square$

**Proposition 3.18.**  $\Delta_{\mathcal{Q}, \mathbf{m}, \mathbf{u}}$  is homeomorphic to a ball of dimension  $N_{\mathcal{Q}, \mathbf{m}, \mathbf{u}} - 1$ . (Recall that  $N_{\mathcal{Q}, \mathbf{m}, \mathbf{u}}$  is defined in (4), and equals to the cardinality of any concurrent vertex map.)

*Proof.* By Lemma 3.17, each codimension-1 face of  $\Delta_{\mathcal{Q}, \mathbf{m}, \mathbf{u}}$  is inside at most 2 facets. It then suffices to show that some codimension-1 face of  $\Delta_{\mathcal{Q}, \mathbf{m}, \mathbf{u}}$  is contained in exactly one facet. To show that, it suffices to show the existence of a codimension-1 face  $S$  inside of the facet  $C_{\max}(\emptyset)$  that is not contained in any other facet. Assume that such a face does not exist. Then for any  $P \in C_{\max}(\emptyset)$ , let  $S = C_{\max}(\emptyset) \setminus \{P\}$ , we have  $C_{\min}(S) <_T C_{\max}(\emptyset)$ . Then  $S$  does not contain at least one essential SE corner of  $C_{\max}(\emptyset)$ , which implies that  $P$  is an essential SE corner of  $C_{\max}(\emptyset)$ . Therefore, every point in  $C_{\max}(\emptyset)$  is an essential SE corner. Let  $P_{\text{SW}}^{(r)} = (m_{t(h_r)}, 1, r)$ ,  $P_{\text{NE}}^{(r)} = (1, m_{s(h_r)}, r)$ . Then  $P_{\text{SW}}^{(r)}, P_{\text{NE}}^{(r)}$  are in  $C_{\max}(\emptyset)$  by Lemma 3.11 (see Figure 15 Case 2). We claim that  $P_{\text{SW}}^{(r)}$  and  $P_{\text{NE}}^{(r)}$  cannot both be SE corners of  $C_{\max}(\emptyset)$ . Since  $P_{\text{SW}}^{(r)}$  is at the left-most column of  $A_{s(h_r)}$ , it cannot be a SE corner of any vertical path; it is at the bottom row of  $A_{t(h_r)}$ , so is in the bottom-most horizontal path which has only one SE corner (the NE-most point of page  $r$ ), this is only possible if page  $r$  has one column, that is,  $m_{s(h_k)} = 1$ . Then  $P_{\text{NE}}^{(r)}$  is not a SE corner of any horizontal path (for the same reason as before), and not a SE corner of any vertical path (because  $A_{s(h_r)}$  has only one column, so a vertical path in it has not SE corner). So we conclude that  $\Delta_{\mathcal{Q}, \mathbf{m}, \mathbf{u}}$  is always a ball.  $\square$

#### 4. HILBERT SERIES, MULTIPLICITY, AND $h$ -POLYNOMIAL

**Corollary 4.1.** The Hilbert series for  $\mathbf{k}[X]/\text{init}(I_{\mathcal{Q}, \mathbf{m}, \mathbf{u}})$ , which is defined as the sum of all monomials that lie outside  $\text{init}(I_{\mathcal{Q}, \mathbf{m}, \mathbf{u}})$ , is

$$(26) \quad \text{Hilb}(\mathbf{k}[X]/\text{init}(I_{\mathcal{Q}, \mathbf{m}, \mathbf{u}}); \mathbf{X}) = \sum_C \frac{\prod_{(i,j,k) \in C} x_{ij}^{(k)} \prod_{(i,j,k) \in L \setminus C} (1 - x_{ij}^{(k)})}{\prod_{(i,j,k) \in L} (1 - x_{ij}^{(k)})},$$

where  $C$  runs through all (not necessarily maximal)  $\mathbf{u}$ -compatible subsets of  $L$ . (Note that  $C$  could be the empty set.) In particular, the  $\mathbb{Z}$ -graded Hilbert series is

$$(27) \quad \text{Hilb}(\mathbf{k}[X]/I_{\mathcal{Q}, \mathbf{m}, \mathbf{u}}; t) = \text{Hilb}(\mathbf{k}[X]/\text{init}(I_{\mathcal{Q}, \mathbf{m}, \mathbf{u}}); t) = \sum_C \left( \frac{t}{1-t} \right)^{|C|},$$

where  $C$  runs through all (not necessarily maximal)  $\mathbf{u}$ -compatible subsets of  $L$ ; the multiplicity of the bipartite determinantal ideal is

$$\text{mult}(\mathbf{k}[X]/I_{\mathcal{Q}, \mathbf{m}, \mathbf{u}}) = \text{the number of concurrent vertex maps.}$$



Moreover, we have

$$(28) \quad \text{Hilb}(\mathbf{k}[X]/\text{init}(I_{\mathcal{Q},\mathbf{m},\mathbf{u}}); \mathbf{X}) = \sum_C \frac{(-1)^{N_{\mathcal{Q},\mathbf{m},\mathbf{u}}-|C|} \prod_{(i,j,k) \in L \setminus C} (1 - x_{ij}^{(k)})}{\prod_{(i,j,k) \in L} (1 - x_{ij}^{(k)})},$$

where  $C$  runs through all interior faces. In particular,

$$(29) \quad \text{Hilb}(\mathbf{k}[X]/I_{\mathcal{Q},\mathbf{m},\mathbf{u}}; t) = \sum_C \frac{(-1)^{N_{\mathcal{Q},\mathbf{m},\mathbf{u}}-|C|}}{(1-t)^{|C|}},$$

where  $C$  runs through all interior faces.

*Proof.* The only nontrivial statement is (28), its proof is similar to [8, Theorem 4.1]. A key ingredient is that  $\Delta_{\mathcal{Q},\mathbf{m},\mathbf{u}}$  is homeomorphic to a ball, which we proved in Proposition 3.18.  $\square$

The Hilbert series of the bipartite determinantal ideal  $I_{\mathcal{Q},\mathbf{m},\mathbf{u}}$  can be written as

$$\text{Hilb}(\mathbf{k}[X]/I_{\mathcal{Q},\mathbf{m},\mathbf{u}}; t) = \frac{H(t)}{(1-t)^{N_{\mathcal{Q},\mathbf{m},\mathbf{u}}}}$$

where  $H(t) = h_0 + h_1 t + \dots$  is called the  $h$ -polynomial and  $(h_0, h_1, \dots)$  is called the  $h$ -vector of  $\Delta_{\mathcal{Q},\mathbf{m},\mathbf{u}}$ . Since  $\mathbf{k}[X]/I_{\mathcal{Q},\mathbf{m},\mathbf{u}}$  is Cohen-Macaulay, its  $h$ -polynomial must be positive, that is, be contained in  $\mathbb{Z}_{\geq 0}[t]$  (see [21, Chapter II §3]). Such polynomials are studied for local rings of Schubert varieties in [16]. It is natural to look for a combinatorially manifestly positive formula for  $H(t)$ . This can be answered as follows:

**Corollary 4.2.** *The  $h$ -polynomial  $h_0 + h_1 t + \dots$  of  $\Delta_{\mathcal{Q},\mathbf{m},\mathbf{u}}$  is determined as follows: for  $i = 0, 1, \dots, N_{\mathcal{Q},\mathbf{m},\mathbf{u}}$ ,*

$$\begin{aligned} h_i &= \text{the number of concurrent vertex maps that contain exactly } i \text{ essential SE corners} \\ &= \text{the number of concurrent vertex maps that contain exactly } i \text{ essential NW corners.} \end{aligned}$$

*Proof.* Arrange the facets of  $\Delta_{\mathcal{Q},\mathbf{m},\mathbf{u}}$  as  $C_1, C_2, \dots, C_N$  sasdb by the increasing order under  $<_T$ . By Corollary 3.16, this is a shelling order of  $\Delta_{\mathcal{Q},\mathbf{m},\mathbf{u}}$ . By a result of McMullen and Walkup (see [5, Corollary 5.1.14]),  $h_i = |\{j : r_j = i\}|$  where  $r_1 = 0$  and  $r_j$  is the number of facets of  $\langle C_j \rangle \cap \langle C_1, \dots, C_{j-1} \rangle$  for  $2 \leq j \leq N$ . Note that  $S$  is a facet of  $\langle C_j \rangle \cap \langle C_1, \dots, C_{j-1} \rangle$  if and only if  $|S| = N_{\mathcal{Q},\mathbf{m},\mathbf{u}} - 1$  and  $S = F_j \cap F_i$  for some  $i < j$ . Let  $S$  be such a facet. By Lemma 3.5 and 3.17,  $C_i = C_{\min}(S) = S \cup \{P\}$  and  $C_j = C_{\max}(S) = S \cup \{P'\}$ , where  $P$  is an essential NW corner of  $C_i$ ,  $P'$  is an essential SE corner of  $C_j$ . Note that  $P$  and  $P'$  uniquely determine each other. So  $S$  is a desired facet if and only if  $S$  is obtained from  $C_j$  by removing an essential SE corner of  $C_j$ . Therefore  $r_j$  is the number of essential SE corners of  $C_j$ , and thus the first equality holds. The second equality holds by symmetry.  $\square$

It is relatively fast for a computer to generate all concurrent vertex maps, in particular to compute the multiplicity, by applying chute moves iteratively to  $C_{\max}(\emptyset)$ . It is slow to compute the Hilbert series using (27) or (29). Instead, it is relatively fast to compute the Hilbert series using Corollary 4.2. For the readers convenience, the related Sagemath codes used for study the concurrent vertex maps are available at



<https://sites.google.com/oakland.edu/bipartite-determinantal>

5. EXAMPLES, ALGORITHMS, AND BEYOND

5.1. Some examples.

**Example 5.1.** Consider a determinantal ideal  $I_{m,n,u+1}^{\det}$  of  $(u+1)$ -minors in an  $m \times n$  matrix. It is bipartite determinantal ideal for  $\mathcal{Q} : 2 \rightarrow 1$ ,  $\mathbf{m} = (m_1, m_2) = (m, n)$ ,  $\mathbf{u} = (u_1, u_2) = (u, u)$ . Each concurrent vertex map  $C$  consists of lattice points in the union of  $u$  nonintersecting paths  $(m - u + i, i) \rightsquigarrow (i, n - u + i)$  for  $1 \leq i \leq u$  (see Figure 4 Left) and points in the two triangles at the SW and NE corners:

$$\{(i, j) \in [1, m] \times [1, n] \mid j \leq i - (m - u) \text{ or } i \leq j - (n - u)\}.$$

The corresponding road map  $(\{H_i^1\}, \{V_i^2\})_{1 \leq i \leq u}$  can be obtained as follows:

$H_i^1$  is obtained by joining  $(m - u + i, 1), (m - u + i, i) \rightsquigarrow (i, n - u + i), (i, n)$ ;

$V_i^2$  is obtained by joining  $(1, n - u + 1), (i, n - u + i) \rightsquigarrow (m - u + i, i), (m, i)$ .

So in this case, we can view  $C$  as lattice points in the union of  $H_i^1$ , or view as lattice points in the union of  $V_i^2$ . See Figure 20 for the concurrent vertex maps and the corresponding road maps when  $m = 3, n = 3, u = 2$ .

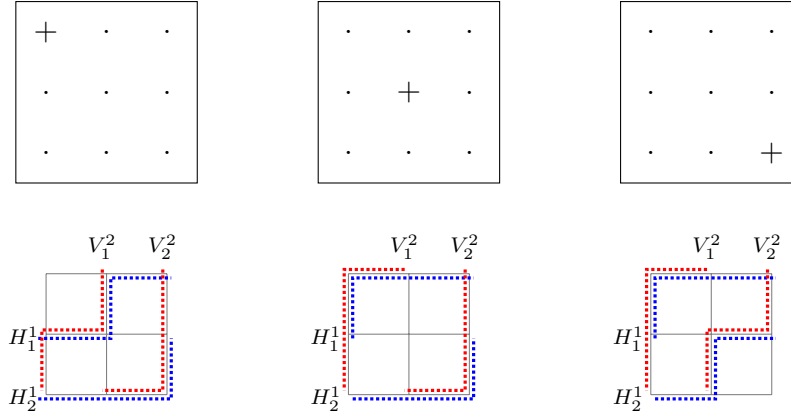

FIGURE 20. Example 5.1.

**Example 5.2.** Consider the double determinantal ideal  $I_{m,n,u,v}^{(r)}$  where  $r = 2, m = 3, n = 2, u = v = 1$ . Denote the corresponding quiver to be  $\mathcal{Q} : 2 \xrightarrow{r} 1$  with  $r$  arrows. The ideal is generated by 2 minors in the following two matrices:

$$A_1 = \begin{bmatrix} x_{11}^{(1)} & x_{12}^{(1)} & x_{11}^{(2)} & x_{12}^{(2)} \\ x_{21}^{(1)} & x_{22}^{(1)} & x_{21}^{(2)} & x_{22}^{(2)} \\ x_{31}^{(1)} & x_{32}^{(1)} & x_{31}^{(2)} & x_{32}^{(2)} \end{bmatrix}, \quad A_2 = \begin{bmatrix} x_{11}^{(1)} & x_{12}^{(1)} \\ x_{21}^{(1)} & x_{22}^{(1)} \\ x_{31}^{(1)} & x_{32}^{(1)} \\ x_{11}^{(2)} & x_{12}^{(2)} \\ x_{21}^{(2)} & x_{22}^{(2)} \\ x_{31}^{(2)} & x_{32}^{(2)} \end{bmatrix}.$$

The facets of its Stanley-Reisner complex  $\Delta$  are illustrated in Figure 21, where arrows denote all possible chute moves, red “+”s indicate where the chute move can apply, the numbers indicate the shelling order given by the decreasing order under  $<_T$ . So  $N_{\mathcal{Q},\mathbf{m},\mathbf{u}} =$

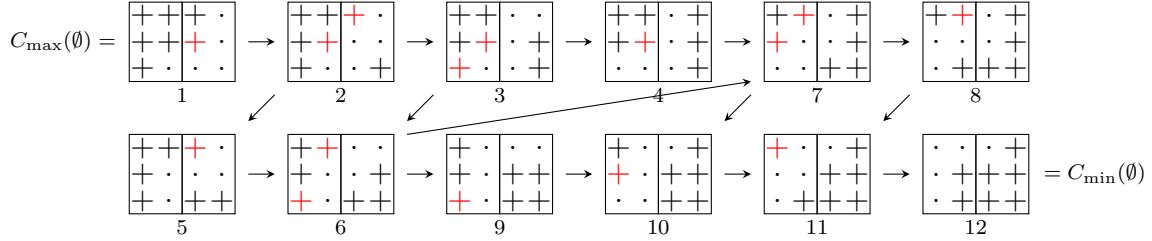

FIGURE 21. Example 5.2.

the number of dots = 5,  $\dim \Delta = N_{\mathcal{Q},\mathbf{m},\mathbf{u}} - 1 = 4$ , multiplicity = the number of facets of  $\Delta$  = the number of concurrent vertex maps = 12. The numbers of  $d$ -faces in  $\Delta$  are easily counted by a computer:

$d$	-1	0	1	2	3	4	total
# of $d$ -faces	1	12	42	64	45	12	176
# of interior $d$ -faces	0	0	0	4	15	12	31

Consequently, by (27),

$$\begin{aligned} \text{Hilb}(\mathbf{k}[X]/I_{\mathcal{Q},\mathbf{m},\mathbf{u}}; t) &= \sum_{\text{faces } C} \left(\frac{t}{1-t}\right)^{|C|} = \sum_d (\# \text{ of } d\text{-faces}) \left(\frac{t}{1-t}\right)^{d+1} \\ &= 1 \left(\frac{t}{1-t}\right)^0 + 12 \left(\frac{t}{1-t}\right)^1 + 42 \left(\frac{t}{1-t}\right)^2 + 64 \left(\frac{t}{1-t}\right)^3 + 45 \left(\frac{t}{1-t}\right)^4 + 12 \left(\frac{t}{1-t}\right)^5 \\ &= \frac{1 + 7t + 4t^2}{(1-t)^5}. \end{aligned}$$

Alternatively, by (29),

$$\begin{aligned} \text{Hilb}(\mathbf{k}[X]/I_{\mathcal{Q},\mathbf{m},\mathbf{u}}; t) &= \sum_{\text{interior faces } C} \frac{(-1)^{N_{\mathcal{Q},\mathbf{m},\mathbf{u}} - |C|}}{(1-t)^{|C|}} = \sum_d (\# \text{ of interior } d\text{-faces}) \frac{(-1)^{5-(d+1)}}{(1-t)^{d+1}} \\ &= 4 \frac{1}{(1-t)^3} + 15 \frac{-1}{(1-t)^4} + 12 \frac{1}{(1-t)^5} = \frac{1 + 7t + 4t^2}{(1-t)^5}. \end{aligned}$$

Alternatively, by Corollary 4.2, the number of essential SE corners of the concurrent vertex maps in Figure 21 are 1, 2, 2, 1, 2, 1; 1, 2, 1, 1, 1, 0, respectively; the number of essential NW corners of the concurrent vertex maps in Figure 21 are 0, 1, 1, 1, 2, 1; 1, 2, 1, 2, 2, 1, respectively. So the  $h$ -polynomial is  $1 + 7t + 4t^2$ .

**Example 5.3.** Continue Example 1.4. Figure 22 illustrates those facets of the Stanley-Reisner complex obtained from  $C_{\max}(\emptyset)$  by applying at most two chute moves; the arrows denote chute moves, red “+”s indicate where the chute move can apply. So  $N_{\mathcal{Q},\mathbf{m},\mathbf{u}} = 11$ ,  $\dim \Delta = 10$ . The numbers of  $d$ -faces in  $\Delta$  are easily counted by a computer:

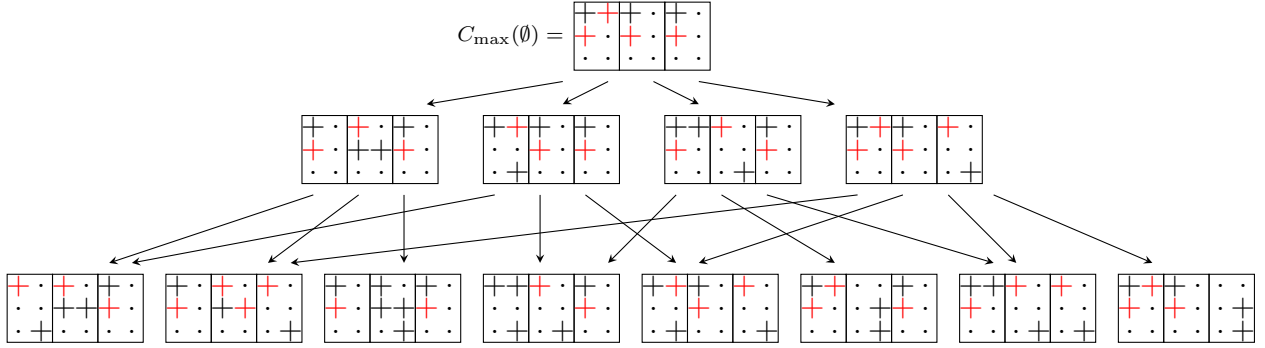

FIGURE 22. Example 5.3.

$d$	-1	0	1	2	3	4	5	6	7	8	9	10	total
# of $d$ -faces	1	18	144	670	2013	4110	5837	5784	3930	1748	459	54	24768
# of interior $d$ -faces	0	0	0	0	0	0	1	12	57	128	135	54	387

So multiplicity = 54. By (27) or (29),

$$\text{Hilb}(\mathbf{k}[X]/I_{\mathcal{Q},\mathbf{m},\mathbf{u}}; t) = \frac{1 + 7t + 19t^2 + 19t^3 + 7t^4 + t^5}{(1-t)^{11}} = \frac{(1+t)(1+6t+13t^2+6t^3+t^4)}{(1-t)^{11}}.$$

**5.2. Secant varieties.** In the special case when  $r = 2$ ,  $u = v$ , we recover some results on  $t$ -secant varieties by Conca, De Negri, and Stojanac [6, Theorem 3.2, Theorem 4.1, Proposition 4.7]. Recall the notation therein:  $I_{t+1} = I_{t+1}(\mathcal{X}^{\{2\}}) + I_{t+1}(\mathcal{X}^{\{3\}})$  is the defining ideal of the  $t$ -secant variety  $\sigma_t(2, a, b)$  of the Segre variety  $\text{Seg}(2, a, b)$ . This ideal is, in our terminology, the double determinantal ideal  $I_{a,b,t,t}^{(2)}$ . It is easy to obtain the following corollary:

**Corollary 5.4** ([6]). (i) *The natural generators of  $I_{a,b,t,t}^{(2)}$  are a Gröbner basis (with respect to an appropriate monomial order).*

(ii)  $\mathbf{k}[X]/I_{a,b,t,t}^{(2)}$  *is a Cohen-Macaulay domain.*

(iii) *The corresponding simplicial complex  $\Delta$  is shellable.*

(iv) *Each facet of  $\Delta$  can be expressed by a collection of  $t$  disjoint paths  $F_1, \dots, F_t$  such that  $F_i$  is a lattice path starting in  $(1, b + h_i)$  and ending in  $(a, h_i)$ , from NW to SE, and walk along the direction  $(1, 0)$  or  $(0, -1)$  in each step, for some integers  $h_1, \dots, h_t$  satisfying  $1 \leq h_1 < \dots < h_t \leq b$ .*

*Proof.* (i) follows from Theorem 1.2, (ii) and (iii) follow from Theorem 1.6. To show (iv), consider  $\mathcal{Q} : 2 \xrightarrow{2} 1$ ,  $A_1 = [X^{(1)}, X^{(2)}]$ ,  $A_2 = \begin{bmatrix} X^{(1)} \\ X^{(2)} \end{bmatrix}$ . For  $p = 1, \dots, t$ , let the segment joining  $(c_p, b)$  and  $(c_p, b + 1)$  be the horizontal segment of  $H_p^1$  in  $A_1$  that crosses the two pages. For  $q = 1, \dots, t$ , let the segment joining  $(a, d_q)$  and  $(a + 1, d_q)$  be the vertical segment of  $V_q^2$  in  $A_2$  that crosses the two pages. We use our previous notation as in Figure 5 (taking  $\alpha = 1$ ) to denote the path  $P_{pq} \rightsquigarrow Q_{pq} = H_p^1 \cap V_q^1$  for  $1 \leq p \leq t$ ,  $1 \leq q \leq 2t$ . Note that for

$1 \leq p \leq t$ ,  $H_p^1$  contains no vertical segment between the two vertices  $(a - t + p, 1)$  and  $P_{pp}$ ,  $V_p^1$  contains no horizontal segment between the two vertices  $(1, b - t + p)$  and  $Q_{pp}$ , by Lemma 2.2. So in the first block, for  $p > q$ , the points  $P_{pq}, Q_{pq}$  have the same  $x$ -coordinate  $a - t + p$ ; for  $p < q$ , the points  $P_{pq}, Q_{pq}$  have the same  $y$ -coordinate  $b - t + q$ . Similarly in the second block, where  $t + 1 \leq q \leq 2t$ , for  $p > q - t$ , the points  $P_{pq}, Q_{pq}$  have the same  $y$ -coordinate  $q$ ; for  $p < q - t$ , the points  $P_{pq}, Q_{pq}$  have the same  $x$ -coordinate  $p$ . For  $1 \leq i \leq t$ , define  $F_i$  to be the unique path that, if walking from SW to NE, contains the following subpaths in order:

$$\begin{aligned} P_{pi} &\rightsquigarrow Q_{pi} \text{ for } p = t, t - 1, \dots, i \text{ (in decreasing order);} \\ P_{iq} &\rightsquigarrow Q_{iq} \text{ for } q = i, i + 1, \dots, i + t \text{ (in increasing order);} \\ P_{p,i+t} &\rightsquigarrow Q_{p,i+t} \text{ for } p = i - 1, i - 2, \dots, 1 \text{ (in decreasing order);} \end{aligned}$$

In other words, if we walk in the direction from SW to NE, then  $F_i$  starts at the point  $P_{ti}$ , follows  $V_i^1$ , then follows  $H_i^1$ , then follows  $V_{t+i}^1$ , and ends at the point  $Q_{1,i+t}$ . To be consistent with the convention in [6], we reverse the direction of  $F_i$  by walking from NE to SW instead; then  $F_i$  starts in  $(1, b + h_i) = Q_{1,i+t}$ , and ends in  $(a, h_i) = P_{ti}$ . Note that the  $(Q_{1,i+t})_y = b + (P_{ti})_y$  because  $\phi_2^{-1}\phi_1(V_i^1)$  and  $\phi_2^{-1}\phi_1(V_{i+t}^1)$  have to merge into a vertical path  $V_i^2$  in  $A_2$ . Also note that  $Q_{1,1+t}, Q_{1,2+t}, \dots, Q_{1,2t}$  are ordered from left to right between  $(1, b + 1)$  and  $(1, 2b)$ , so  $1 \leq h_1 < \dots < h_t \leq b$ .  $\square$

**Example 5.5.** Let  $a = b = 4, t = 2$ . An example of straight road map is given in Figure 23, where  $h_1 = 2, h_2 = 4$ .

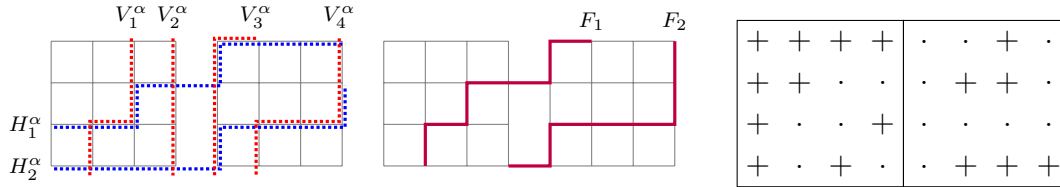

FIGURE 23. Left: an example of straight road map; Middle: the corresponding disjoint paths  $F_i$ 's; Right: the corresponding concurrent vertex map.

**5.3. Some questions to explore further.** There are many algebraic, geometric, or combinatorial questions we may ask about the bipartite determinantal ideals. To name a few:

**5.3.1. Reduced Gröbner basis.** Recall that the natural generators of a classical determinantal ideal forms a reduced Gröbner basis [22]. Similar statements are false in general for bipartite determinantal varieties, or even for double determinantal varieties. Consider the double determinantal ideal  $I_{m,n,u,v}^{(r)}$  with  $r = 2, m = n = 2, u = v = 1$ . Denote

$$X^{(1)} = \begin{bmatrix} a & b \\ c & d \end{bmatrix}, X^{(2)} = \begin{bmatrix} a' & b' \\ c' & d' \end{bmatrix}.$$

The reduced Gröbner basis of  $I_{m,n,u,v}^{(r)}$  is

$$\{a'd' - b'c', cd' - dc', cb' - da', bd' - db', bc' - da', ac' - ca', ab' - ba', ad - bc, ad' - da'\}$$

Note that the last generator in the above list is not a natural generator. It is natural to ask

**Question:** Can we combinatorially characterize the reduced Gröbner basis?

5.3.2. *Multiplicity formula in terms of determinants.* The multiplicity of a determinantal ideal, which is the number of nonintersecting paths with certain fixed starting and ending points, can be written as a determinant (see [12]). Similar formulas are found for more general ideals, for example see [13] and the references therein.

**Question:** Can we find a multiplicity formula for a bipartite determinantal ideal in terms of determinants, or equivalently, a determinantal formula for the number of concurrent vertex maps?

5.3.3. *Gorenstein property.* (We thank Aldo Conca for suggesting the question on Gorenstein property.) Given a Cohen-Macaulay standard graded domain, it has a symmetric  $h$ -polynomial if and only if it is Gorenstein (by a theorem of Stanley; see [5, Corollary 4.4.6]). In Example 5.3, the  $h$ -polynomial is symmetric (also called palindromic); so  $\mathbf{k}[X]/I_{\mathcal{Q},\mathbf{m},\mathbf{u}}$  is Gorenstein for that example. In [6, Conjecture 4.9], Conca, Negri and Stojanac proposed a conjecture about the Gorenstein property in their setting.

**Question:** Can we explicitly identify all bipartite determinantal ideals with Gorenstein property?

## REFERENCES

- [1] Baetica, C. (2006). Combinatorics of determinantal ideals (p. x+141). Nova Science Publishers, Inc., Hauppauge, NY. 2
- [2] N. Bergeron, S. Billey, RC-graphs and Schubert polynomials. *Experiment. Math.* 2 (1993), no. 4, 257–269. 26
- [3] A. Björner, M. Las Vergnas, B. Sturmfels, N. White, G. M. Ziegler, *Oriented matroids*, second ed., Cambridge University Press, Cambridge, 1999. 34
- [4] W. Bruns, A. Conca, C. Raicu, M. Varbaro, *Determinants, Gröbner Bases and Cohomology*, Springer Monographs in Mathematics, 2022. 2
- [5] W. Bruns, J. Herzog, *Cohen-Macaulay rings*. Cambridge Studies in Advanced Mathematics, 39. Cambridge University Press, Cambridge, 1993. 5, 36, 41
- [6] A. Conca, E. De Negri, and Ž. Stojanac. A characteristic free approach to secant varieties of triple segre products. *Algebr. Comb.* 3 (2020), no. 5, 1011–1021. 5, 39, 40, 41
- [7] N. Fieldsteel and P. Klein. Gröbner bases and the Cohen-Macaulay property of Li’s double determinantal varieties. *Proc. Amer. Math. Soc. Ser. B.* 7 pp. 142–158 (2020) 5
- [8] A. Knutson, E. Miller, Subword complexes in Coxeter groups. *Adv. Math.* 184 (2004), no. 1, 161–176. 34, 36
- [9] A. Knutson, E. Miller, Gröbner geometry of Schubert polynomials. *Ann. of Math. (2)* 161 (2005), no. 3, 1245–1318. 26, 31
- [10] D. Grayson, M. Stillman, Macaulay2, a software system for research in algebraic geometry. (Available at <http://www.math.uiuc.edu/Macaulay2/>) 6
- [11] J. Harris, *Algebraic geometry*. (Springer-Verlag, New York,1992), A first course 2
- [12] J. Herzog, N. V. Trung, Gröbner bases and multiplicity of determinantal and Pfaffian ideals. *Adv. Math.* 96 (1992), no. 1, 1–37. 41
- [13] C. Krattenthaler, M. Prohaska, A remarkable formula for counting nonintersecting lattice paths in a ladder with respect to turns. *Trans. Amer. Math. Soc.* 351 (1999), no. 3, 1015–1042. 41

- [14] J. Illian and L. Li. Gröbner basis for the double determinantal ideals. arXiv:2305.01724 [1](#), [2](#), [3](#)
- [15] L. Li. Nakajima's quiver varieties and triangular bases of rank-2 cluster algebras. arXiv:2208.12307 [3](#)
- [16] L. Li, A. Yong, Kazhdan-Lusztig polynomials and drift configurations, *Algebra Number Theory* 5 (2011), no. 5, 595–626. [36](#)
- [17] E. Miller and B. Sturmfels. *Combinatorial Commutative Algebra*, volume 227 of *Graduate Texts in Mathematics*. Springer-Verlag, 2004. [2](#), [3](#), [25](#), [31](#)
- [18] R. Miró-Roig, Determinantal ideals. *Progress in Mathematics*, 264. Birkhäuser Verlag, Basel, 2008. xvi+138 pp. [2](#)
- [19] H. Narasimhan. The irreducibility of ladder determinantal varieties. *J. Algebra*, 165:162–185, 1986. [2](#)
- [20] The Sage Developers, *SageMath, the Sage Mathematics Software System (Version 9.2)*, 2020, <https://www.sagemath.org>. [6](#)
- [21] R. Stanley, *Combinatorics and commutative algebra*. Second edition. *Progress in Mathematics*, 41. Birkhäuser Boston, Inc., Boston, MA, 1996. x+164 pp. [36](#)
- [22] B. Sturmfels, Gröbner bases and Stanley decompositions of determinantal rings. *Math. Z.* 205 (1990), no. 1, 137–144. [40](#)
- [23] Weyman, J. *Cohomology of vector bundles and syzygies*. (Cambridge University Press, Cambridge,2003) [2](#)

DEPARTMENT OF MATHEMATICS AND STATISTICS, OAKLAND UNIVERSITY, ROCHESTER, MI 48309-4479, USA

*Email address:* [li2345@oakland.edu](mailto:li2345@oakland.edu)