

Rate-Distortion Theory in Coding for Machines and its Applications

Alon Harell, *Student Member, IEEE*, Yalda Foroutan, *Student Member, IEEE*, Nilesh Ahuja, Parual Datta, Bhavya Kanzariya, V. Srinivasa Somayaulu, Omesh Tickoo, Anderson de Andrade, *Student Member, IEEE*, Ivan V. Bajić, *Senior Member, IEEE*,

Abstract—Recent years have seen a tremendous growth in both the capability and popularity of automatic machine analysis of images and video. As a result, a growing need for efficient compression methods optimized for machine vision, rather than human vision, has emerged. To meet this growing demand, several methods have been developed for image and video coding for machines. Unfortunately, while there is a substantial body of knowledge regarding rate-distortion theory for human vision, the same cannot be said of machine analysis. In this paper, we extend the current rate-distortion theory for machines, providing insight into important design considerations of machine-vision codecs. We then utilize this newfound understanding to improve several methods for learnable image coding for machines. Our proposed methods achieve state-of-the-art rate-distortion performance on several computer vision tasks such as classification, instance segmentation, and object detection.

Index Terms—Rate-Distortion Theory, Collaborative Intelligence, Image Coding, Coding for Machines, Learnable Compression, Compression for Machines, Split Computing.

I. INTRODUCTION

IN machine analysis, an automated system processes an input to provide some semantically meaningful information. Common examples include object detection in images, action recognition in video, and speech-to-text conversion in audio. Recent advancements in deep neural networks (DNNs) have resulted in a rapid increase in the accuracy and reliability of automated machine analysis. As a result, DNN models (often known simply as deep models) have become ubiquitous in many tasks such as object detection [1]–[3] and segmentation [3]–[5], machine translation [6], [7], and speech-recognition [8], [9]. Unfortunately, alongside their tremendous improvements, DNN based models have very high computational cost both in terms of memory and floating point operations [10]. The resulting complexity, coupled with the growing diversity of deep models, is a significant limiting factor in the deployment of such models, especially to devices such as smart speakers or wearable devices with limited computing resources.

Beyond the simple improvement of edge-device hardware capabilities, several different approach are used to deploy resource-intensive deep models to end users. One approach,

known as edgification, is to directly reduce the complexity of the DNN models in the design process. This reduction can be the result of changes to the model architecture [11], the use of lower numerical precision [12], or via the simplification of existing models to match the computational capabilities of edge devices [13]. Although these methods and more, hold great promise, they are not always adequate, and are in limited use today. In practice, the most common approach today [14] is simply to avoid deployment of computationally demanding models on edge devices altogether. Instead, the majority of the computation is offloaded to remote servers with tremendous computational capacity (“the cloud”), which often utilize graphics processing units (GPU) or tensor processing units (TPU).

In order for the computation to be performed remotely, the edge device must transmit information to the cloud. The most common solution in use today is the straightforward approach, wherein the input itself is compressed and sent to the cloud using coding methods developed for humans (for example a video codec such as VVC [15], or an audio codec such as AAC [16]). In recent work, this naive approach has been shown to be sub-optimal both theoretically [17] and empirically [17], [18]. Furthermore, in a growing number of applications such as traffic monitoring or home security, the majority of inputs are never observed by a human, and thus there is no reason to preserve them in their original, human-friendly form. As a result *coding for machines*, also known as *compression for machines*, an umbrella term used for methods of transmitting information to facilitate automated analysis (rather than human consumption), has garnered increasing attention of late.

Another important development in coding for machines is the emergence of learnable compression (sometimes referred to as neural compression), most commonly used for images [19]–[24] and video, [25]–[27]. In this setup, complex hand-engineered codecs (such as JPEG [28], VVC [15], and HEVC [29]), are replaced with trainable models (often DNNs). The most common optimization objective (L) used in training learnable codecs is derived from the information bottleneck [30], and is of the following Lagrange multiplier form:

$$L = R + \lambda D, \quad (1)$$

where R is an estimate of the rate required for encoding (the entropy model), D is some measure of distortion for the resulting reconstructed output, and λ is the Lagrange multiplier that controls the trade-off between rate and distortion. Using

Alon Harell, Yalda Foroutan, Anderson de Andrade, and Ivan V. Bajić are with Simon Fraser University, 8888 University Drive, Burnaby, BC, V5S1A6, Canada. Email communications to Alon Harell: aharell@sfu.ca

Nilesh Ahuja, Parual Datta, Bhavya Kanzariya, Srinivasa Somayaulu, and Omesh Tickoo are with Intel Labs.

This work was funded by Intel Labs and NSERC.

this approach, a codec for machines can be created by simply choosing a distortion metric corresponding to the performance of some desired task model as was done, for example, in the work of [31].

Generally, information theory [32] allows us to discuss ultimate bounds on the amount of bits needed to describe a random variable (RV). As such, its understanding is crucial in the development of efficient compression methods for complex signals such as audio, images, or video. More specifically within information theory, rate-distortion [33], [34] describes the inherent trade-off between the size allocated to the description of an RV (the rate) and the fidelity, or conversely the distortion, with which it can be reconstructed. In the case of coding for machines, however, the traditional, well-developed rate-distortion (RD) theory does not apply directly, because we are no longer required to reconstruct the RV in its original form. Thus, extending the rate-distortion theory to cases where input reconstruction is no longer needed is key to understanding the limits of codecs for machines.

We focus on three main approaches for coding for machines that have been presented in the literature so far: the *full-input* approach, the *model-splitting* approach, and the *direct* approach. In the full-input approach, an input signal is encoded and reconstructed before being passed to the machine task model for analysis. Note that this approach can differ from the naive approach presented above, because the codec used to encode and reconstruct the input may be specifically optimized for machine analysis. In the model-splitting approach, sometimes also known as *collaborative intelligence* [18] or *collaborative inference* [14], the initial part (*frontend*) of the task model is run on the edge device, yielding a latent representation of the input specific to a given task. This representation is then encoded, whether by using traditional codecs [18], [35], or by purpose-built learnable methods [36], [37] and transmitted to the cloud. There, the remainder (*backend*) of the task model is used to perform the desired analysis. Finally, in direct coding for machines, an asymmetric approach is used. The input signal is encoded and transmitted to the cloud, but instead of the input itself being reconstructed on the cloud, the decoder recreates the desired latent representation directly. Then, as in the model-splitting approach, the reconstructed latent representation is passed on to the backend of the task model, which performs the task. Fig. 1 provides a visual representation of these three approaches.

In this paper, we develop and utilize rate-distortion theory for machines, with specific attention to coding for deep models. The main contributions of our work are as follows:

- We present a framework that allows for theoretical analysis of coding for machines.
- We prove multiple theorems governing the optimal performance of the aforementioned approaches, as well as important design considerations.
- Where our theory does not provide concrete proofs, we motivate our design considerations through empirically demonstrated hypotheses.
- Using the new theoretic understanding, we either improve upon or better explain our previously published work

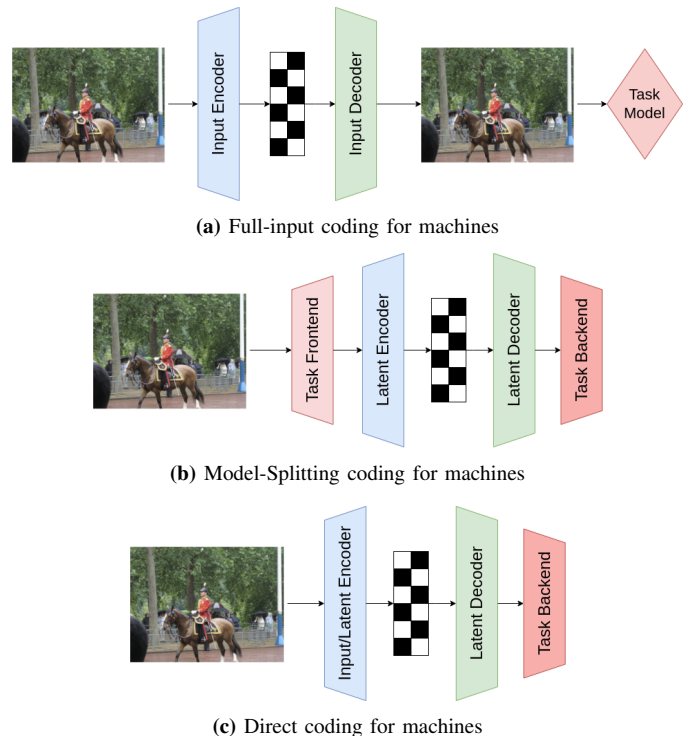

Fig. 1: Three common approaches for coding for machines.

in image coding for machines in several settings. The resulting codecs all achieve, to the best of our knowledge, state-of-the-art (SOTA) rate-distortion performance on their corresponding tasks.

We present our work in the following order: Section II presents background on rate-distortion, including prior theory in coding for machines, followed by our formulation and theoretic results; Section III discusses design considerations in cases beyond the scope of our theory, including evidence-based motivating hypotheses; In Section IV, we demonstrate the benefits of our theory in practice, achieving state-of-the-art rate-distortion performance on several computer-vision tasks; Finally, Section V provides summary and conclusions. Throughout the paper, upper case variables X, Y, T represent random variables (RVs), their lower case counterparts x, y, t represent single observations, sets and spaces are represented by script letter such as \mathcal{P}, \mathcal{R} , and other notation is explained when introduced. For ease of reading, we present all theorems and corollaries in the main body of the paper, and all proofs in Appendix A of the supplemental material.

II. RATE-DISTORTION THEORY FOR MACHINES

Due to its emerging nature, theory governing rate-distortion in *coding for machines* is still evolving. Recently, [38] proposed “ \mathcal{V} -Information”, a theoretic structure for measuring information in terms of its usability by a downstream family of models. While this framework allows for better understanding of the inner workings of deep models, it does not relate directly to compression because the resulting measure cannot be used for encoding a desired RV. Meanwhile, [39] present a theory of rate-distortion for machine tasks, based on the invariance of a task (or a group tasks) to certain changes in the input.

Using their formulation, the authors in [39] are able to show that significant degradation of the input is possible without affecting the task performance. Furthermore, they demonstrate a closed form for rate-distortion for certain tasks when using a log-loss as their distortion metric. An important conclusion of this work is that utilizing a measure of distortion directly related to the task is preferable to simply attempting to create a high-fidelity reconstruction of the input. In another example of a multi-task setting, [40] examine bit allocation optimality in coding for machines. The proposed method achieves multi-objective optimality in settings where the codec and task model are fixed, only allowing for bit allocation via changing of quantization coefficients for various tensors.

More directly related to our formulation is the work of [17], where the authors propose a scalable codec for both humans and machines. Importantly, in [17], the authors present a formulation which allows comparing the performance of the full-input method and the model-splitting method. Furthermore, the authors prove that the model-splitting approach achieves a rate no worse than the full-input approach for equivalent task performance (including the lossless case). Our own previous work [41], extends the work of [17], discussing the importance of the choice of splitting point, as well as the chosen measure of distortion.

The results proven in [17], [41] are directly referenced in this section, and form an important basis of our newfound formulation. Nonetheless, we will show that in many settings, those results are insufficient in explaining (and thus optimizing) rate-distortion behaviour in coding for machines. We present our formulation step by step, beginning with introducing the reader to traditional rate-distortion theory. Next, we restate the formulation presented in [17], while adding important nuance, including the introduction of notation to support the direct coding for machines approach. Lastly, we prove several important results regarding the rate-distortion behaviour of the various methods, as well as define and discuss the difference between supervised and unsupervised coding for machines.

A. Traditional Rate-Distortion Theory

In traditional digital compression settings, an input $x \in \mathcal{X}$ (such as an image, video, or audio) is encoded, usually for the purpose of storage or transmission. It is common to separate between lossless compression, where the input is perfectly reconstructed after decoding, and lossy compression where some level of distortion is acceptable after decoding. In both settings, a coding scheme should minimize the size of the encoded representation, often measured in bits per sample (known as bit-rate, or simply rate). The minimum achievable bit-rate for lossless coding of a discrete RV X is given by its entropy [33]:

$$H(X) = - \sum_{x \in \mathcal{X}} p_X(x) \log_2(p_X(x)),$$

where $p_X(x)$ is the probability of occurrence of the input x .¹ In lossy compression, the rate clearly depends on the acceptable level of distortion, leading to the following formulation: given an input $X \in \mathcal{X}$, an approximation $\hat{X} \sim p_{\hat{X}|X}(\hat{x}|x)$, and a measure of distortion between two observations $d(x, \hat{x})$, the minimal achievable rate [33] that allows an expected distortion no more than D is given by:

$$R(D) = \min_{p_{\hat{x}|x}(\hat{x}|x) : \mathbb{E}[d(X, \hat{X})] \leq D} I(X; \hat{X}). \quad (2)$$

Above, $I(X; \hat{X})$ is the Mutual Information (MI) [33] between the reconstruction and the input, and $R(D)$ is commonly known as the rate-distortion function. In traditional rate-distortion analysis, the distortion function is chosen to reflect the perceptual degradation in the quality of *input* reconstruction, for example the squared ℓ_2 error: $\|x - \hat{x}\|_2^2$.

As explained in the introduction, in many modern settings there is no necessity to reconstruct the original input. Instead, on the decoder side, the only requirement is that some downstream task, such as voice recognition in audio, or object detection in images, be performed successfully. Thus, a coding scheme for machines is required to create a minimal encoded representation of the input such that the downstream task performance output is compromised as little as possible (or not at all, resulting in lossless coding for machines).

B. Problem Formulation

We begin by defining a task $T = f(X)$, $f : \mathcal{X} \rightarrow \mathcal{T}$, defined by the model $f(\cdot)$, and some corresponding measure of distortion $d_T(f(X), \hat{T})$, where \hat{T} represents the reconstructed output of the task-model, accounting for compression. The reconstructed task output, denoted: $\hat{T}(\cdot)$ can be calculated in a variety of ways, corresponding to the different coding for machines approaches explained in Section I, and detailed below. Next, we assume that the task model can be decomposed into two parts $f = h \circ g$, where we refer to $g : \mathcal{X} \rightarrow \mathcal{Y}$ as a *feature extractor* (as is commonly the case), and to $h : \mathcal{Y} \rightarrow \mathcal{T}$ as the *task backend*. We then define $Y = g(X) \in \mathcal{Y}$ to be the resulting intermediate representation of the input, to which we refer to as a *feature tensor*, as illustrated by the graphic below:

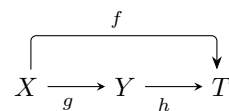

In full-input compression (Fig. 1(a)), which remains the most common approach used in practice as of today, the input X is compressed and then decoded into \hat{X} , yielding $\hat{T}(\hat{X}) = f(\hat{X})$. This can be accomplished either using traditional codecs [42] or learnable ones [43]. The model-splitting approach (Fig. 1(b)) utilizes the existing feature extractor to obtain the latent representation Y and then proceed to encode it, whether by using traditional codecs [18], [35], or by purpose-built learnable methods [36], [37], [44]. Next, the intermediate representation is decoded, giving $\hat{Y} \sim$

¹The use of \log_2 here ensures that the entropy is measured in bits. Other bases for the logarithm, such as e or 10, are acceptable as well, and lead to different units for the entropy such as nats and bans respectively.

$p_{\hat{Y}|Y}(\hat{y}|y)$ which is passed onto the task backend resulting in $\hat{T}(\hat{Y}) = h(\hat{Y})$. Finally, in direct coding for machines [17], [31] (Fig. 1(c)), the feature encoder is not used, but instead the input is encoded directly by a learnable codec. On the decoder side however, the input itself is not reconstructed but rather the latent representation of the task model $\tilde{Y} \sim q_{\tilde{Y}|X}(\tilde{y}|x)$. This representation is subsequently passed on to the task backend, resulting in $\hat{T}(\tilde{Y}) = h(\tilde{Y})$.

Next we present, and extend, the notation introduced by [17] for the rate-distortion function in coding for machines, which is used as a foundation for our notation. We begin with sets of conditional distributions (sometimes referred to as *quantizers*), that achieve some desired average level of distortion $D > 0$ measured at the task T :

$$\mathcal{P}_X(D; T) = \left\{ p(\hat{x}|x) : \mathbb{E} \left[d_T \left(f(X), f(\hat{X}) \right) \right] \leq D \right\}, \quad (3)$$

$$\mathcal{P}_Y(D; T) = \left\{ p(\hat{y}|y) : \mathbb{E} \left[d_T \left(h(Y), h(\hat{Y}) \right) \right] \leq D \right\}. \quad (4)$$

The difference between (3) and (4) lies in the RV that is quantized: the input X or the feature tensor Y . Next, we define the rate-distortion function corresponding to each of the quantizers, analogously to the traditional approach [33]. That is, we minimize the mutual information between the compressed RV and the original RV, while preserving the distortion requirement:

$$R_X(D; T) = \min_{p(\hat{x}|x) \in \mathcal{P}_X(D; T)} I(X; \hat{X}). \quad (5)$$

$$R_Y(D; T) = \min_{p(\hat{y}|y) \in \mathcal{P}_Y(D; T)} I(Y; \hat{Y}). \quad (6)$$

The definitions in (5) and (6) result in the minimal achievable rate [33] for compressing X , Y , respectively, while maintaining average distortion no higher than D (as measured at the task T). Note the use of $(D; T)$ to clarify the use of the task distortion as opposed to distortion related to the input X . In [17], the authors have proven that $R_Y(D; T) \leq R_X(D; T)$, meaning that, for a given task distortion, the lowest achievable rate for the model splitting approach is no worse than the full-input compression approach. We expand on this notation to include a rate-distortion function for direct coding for machines as follows:

$$\mathcal{Q}_{XY}(D; T) = \left\{ q(\hat{y}|x) : \mathbb{E} \left[d_T \left(f(X), h(\hat{Y}) \right) \right] \leq D \right\}, \quad (7)$$

$$R_{XY}(D; T) = \min_{q(\hat{y}|x) \in \mathcal{Q}_{XY}(D; T)} I(X; \hat{Y}). \quad (8)$$

Using this formulation, we are able to prove several important results in the remainder of this section. As mentioned earlier, we only state the results in the main body of the paper; the proofs are provided in Appendix A of the supplemental material.

Theorem 1. *The minimal achievable rates for direct coding for machines and model splitting are identical, that is, $R_{XY}(D; T) = R_Y(D; T)$*

Importantly, in practical settings, there may nonetheless be a significant difference between the direct approach and

the model splitting approach, because practical codecs are generally sub-optimal. An important benefit of Theorem 1 is that, moving forward, any theoretic discussion of rate-distortion for machines need not differentiate between model-splitting and the direct approach. Next, we show that, under reasonable conditions, the inequality proven in [17] is in fact an equality. The only necessary constraints are that the output of the task backend for any given approximation of a feature layer,² be in the image of the function f representing the task model.

Theorem 2. *Let $\mathcal{I}_f(\mathcal{X}) \subseteq \mathcal{T}$ be the image of the function f (the task model) on all possible inputs, and let $\hat{\mathcal{Y}} \subseteq \mathcal{Y}$ be the set of all possible approximations of Y . If $h(\hat{\mathcal{Y}}) \subseteq \mathcal{I}_f(\mathcal{X})$ then, for any given distortion $D > 0$, the minimal achievable rate for model splitting is equal to the minimal achievable rate for full-input compression:*

$$R_X(D; T) = R_Y(D; T). \quad (9)$$

The constraint $h(\hat{\mathcal{Y}}) \subseteq \mathcal{I}_f(\mathcal{X})$ holds trivially for classification-like problems (such as object detection and semantic/object segmentation) since the output must be in the set of defined classes. In regression problems, where this condition does not trivially hold, the result above remains true if for any specific value of y , any approximation \hat{y} whose task output is not in the image of f (the task model) is sub-optimal in terms of distortion. For such cases we provide the following result.

Theorem 2.A. *Let $\hat{y} : h(\hat{y}) \notin \mathcal{I}_f(\mathcal{X})$ be an approximation of a specific value of y for which the output of the task backend is not contained in the image set of f (the original task model). If, for any such \hat{y} , there exists an alternative approximation, \tilde{y} such that $h(\tilde{y}) \in \mathcal{I}_f(\mathcal{X})$ and $d_T(h(y), h(\tilde{y})) \leq d_T(h(y), h(\hat{y}))$ then Equation (9) still holds.*

C. Multiple Splitting Options

In some cases, and especially when the task model is a neural network, there are multiple options for decomposing the model into a feature extractor and task backend. In such a case we can analyze two alternative decompositions of the task model by defining $f = h_1 \circ g_1 = h_2 \circ g_2 \circ g_1$, and correspondingly $Y_1 = g_1(X)$, $Y_2 = g_2(Y_1)$, as can be seen below:

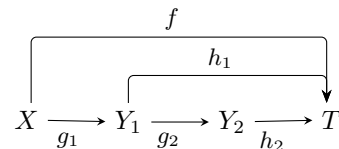

Under this notation we refer to Y_2 as a *deeper* feature tensor than Y_1 or, equivalently, Y_2 as a *deeper* split point than Y_1 . In our previous work [41], we had proven that choosing a deeper split point yields no worse rate-distortion performance: $R_{Y_2}(D; T) \leq R_{Y_1}(D; T)$. However, we can apply Theorem 2

²In fact, it is sufficient to require this for any approximation \hat{y} derived from a quantizer, $p(\hat{y}|y) \in \mathcal{P}_Y(D; T)$, that achieves the optimal rate $I(\hat{Y}; Y) = R_Y(D; T)$.

under equivalent conditions in Y_2 and Y_1 to show the following.

Corollary 2.1. *If $h(\widehat{\mathcal{Y}}_1) \subseteq \mathcal{I}_f(\mathcal{X})$ and $h(\widehat{\mathcal{Y}}_2) \subseteq \mathcal{I}_f(\mathcal{X})$, then for any given task distortion $D > 0$, there is no difference in the minimum achievable rate when encoding either intermediate feature:*

$$R_{Y_2}(D; T) = R_{Y_1}(D; T) = R_X(D; T).$$

Furthermore, applying Theorem 1 means that this is also true when using the direct coding for machine approach, resulting in the following:

Corollary 2.2. *Under the conditions of Corollary 2.1, and for any given task distortion $D > 0$, encoding directly from the input has the same minimum achievable rate as either choice of intermediate layer, that is:*

$$R_{Y_2}(D; T) = R_{XY_2}(D; T) = R_{XY_1}(D; T) = R_{Y_1}(D; T).$$

The combination of the theorems and corollaries presented up to this point can be summarized into the following important conclusion: ***In the theoretically optimal case, the only consideration that affects rate-distortion for machines is the task and its corresponding distortion metric.*** This important fact is a central point of both the rest of our theoretical discussion as well as the bulk of our experimental work.

1) *Alternative Distortion:* Up to this point, we have always considered distortion at the output of our task T . However, in general, we may also be interested in measuring distortion elsewhere in the model. To denote distortion measured some point other than T , we simply replace T in d_T and $(D; T)$ with a symbol indicating the point at which distortion is measured. We refer to the point at which we measure distortion as the *distortion target*. Consider, for example the case of measuring the distortion at some intermediate layer Y . In that case we denote:

$$\mathcal{P}_X(D; Y) = \left\{ p(\hat{x}|x) : \mathbb{E} \left[d_Y \left(g(X), g(\widehat{X}) \right) \right] \leq D \right\} \quad (10)$$

$$R_X(D; Y) = \min_{p(\hat{x}|x) \in \mathcal{P}_X(D; Y)} I(X; \widehat{X}). \quad (11)$$

Using this notation we can equivalently define $R_X(D; X)$, $R_X(D; Y_1)$, $R_{Y_1}(D; Y_1)$, $R_{Y_1}(D; Y_2)$, $R_{Y_2}(D; Y_2)$, and more. In some cases we may be interested in two feature tensors. The first, which we will call the *cut point* or *split-point*, is used for model splitting or direct coding for machines. The other, deeper layer, which we call *distillation point*, will be used to measure the distortion. Importantly, the same logic used to prove all theorems up to this point holds when changing the definition of distortion ***so long as the same distortion is used whenever making comparisons.*** This leads to the following results:

Corollary 2.3. *The model-splitting approach and the direct coding for machines approach have equal minimal rates for achieving distortion at some intermediate layer Y . That is, for any given $D > 0$:*

$$R_{XY}(D; Y) = R_Y(D; Y).$$

Corollary 2.4. *Under equivalent conditions to Theorem 2 or 2.A, the model-splitting approach, the direct coding for machines, and the full-input compression all have equal minimal rate for achieving distortion $D > 0$ at some intermediate layer Y_2 (the distillation point). That is:*

$$R_{XY_2}(D; Y_2) = R_{Y_2}(D; Y_2) = R_X(D; Y_2).$$

Furthermore, cases where the cut-point Y_1 is different from the distillation point are also equivalent:

$$R_{XY_1}(D; Y_2) = R_{Y_1}(D; Y_2) = R_{Y_2}(D; Y_2).$$

One notable conclusion from the corollaries above is that one may choose a cut point different from the distillation point without, in the theoretic limit, diminishing rate-distortion performance. In practice, as we will show in Section IV, this result allows for the use of deeper distillation points without having to change the structure of the codec.

D. Unsupervised Setting

An important aspect of measuring distortion at points other than the task output is that it allows us to design a coding scheme without access to the full model $f(X)$ or, equivalently, the task labels. In particular, when our coding scheme is learned from data, measuring the distortion at some intermediate representation Y , (in other words, using Y as a *distillation point*), allows unsupervised training of our compression model. Unfortunately, when performing coding for machines, the objective generally still remains to perform well on the entire task, rather than just match some intermediate representation well. This means that in order to truly discuss unsupervised training of learned coding for machines, we must account for the statistical relationship between the distortion at the input X : $d_X(X, \widehat{X})$, at an intermediate point Y : $d_Y(Y, \widehat{Y})$, and the full task-distortion $d_T(T, \widehat{T})$.

We begin by noting that intuition suggests that an unsupervised approach cannot achieve better rate-distortion performance than the fully-supervised equivalent. To prove this formally, we first define the set of all possible approximations of X that achieve some desired input-distortion $D > 0$ with a rate equal to $R_X(D; X)$:

$$\mathcal{R}_X(D; X) = \left\{ p(\hat{x}|x) : p(\hat{x}|x) \in \mathcal{P}_X(D; X), \right. \\ \left. I(\widehat{X}; X) = R_X(D; X) \right\}$$

We call the distributions in this set *X-optimal* for the corresponding distortion D . When this set contains more than one distribution, we have multiple alternative approximations of the input, which are indistinguishable when evaluated by their rate-distortion at X . Next, we define the *X-optimal induced distortion set of T* as the set of all possible task distortion values corresponding to these aforementioned distributions:

$$\mathcal{D}_T^*(D_X; X) = \left\{ \mathbb{E} \left[d_T(f(x), f(\hat{x})) \right] : p(\hat{x}|x) \in \mathcal{R}_X(D_X; X) \right\}$$

Note the added subscript to D_X , denoting the difference in the numerical values of the average distortion at the input and in the set \mathcal{D}_T^* . These values are generally different due

to X and T being different RVs and may be in completely different scales or units, depending on the RVs themselves and the distortion metrics d_X and d_T .

Similarly, we can define equivalent sets for some intermediate representation Y : $\mathcal{R}_T(D_Y; Y)$ and $\mathcal{D}_T^*(D_Y; Y)$ ³. We observe the X -optimal distortion set and note the following: if $|\mathcal{D}_T^*(D_X; X)| > 1$, then two (or more) indistinguishably optimal solutions (in terms of input rate-distortion) will perform differently at the task output. In other words, even though one such distribution may perform better at our desired task, we have no way of preferring it over other solutions when looking only at the input distortion. Of course, this is also true for the Y -optimal distortion set as well. Although this is a clear advantage of the supervised approach, we show next that there are further benefits compared with the unsupervised approach.

Consider a situation where we have some way to pick the best alternative in terms of task distortion from our X -optimal (or Y -optimal) compression methods. We show next that even under these conditions, optimising directly at the task remains no worse in terms of rate-distortion.

Theorem 3. *For a given input distortion $D_X > 0$, and the corresponding lowest possible task distortion achievable by an X -optimal approximation, $D_T^{min} = \min \mathcal{D}_T^*(D_X; X)$, the minimal achievable rate of the supervised approach is upper-bounded by the input rate-distortion (for the corresponding distortion values). Formally:*

$$R_X(D_T^{min}; T) \leq R_X(D_X; X).$$

All of this also holds when using an intermediate representation for optimising our coding scheme, directly resulting in the following.

Corollary 3.1. *For a given distortion $D_Y > 0$ measured at an intermediate representation Y , and the corresponding lowest possible task distortion achievable by a Y -optimal approximation, $D_T^{min} = \min \mathcal{D}_T^*(D_Y; Y)$, the minimal achievable rate of the supervised approach is upper-bounded by the intermediate-representation rate-distortion (for the corresponding distortion values). Formally:*

$$R_Y(D_T^{min}; T) \leq R_X(D_Y; Y) = R_Y(D_Y; Y).$$

Equivalently, and of interest when choosing which layer to use for distillation, we can use the same logic as in Theorem 3, but consider the latent representation Y as our target:

Corollary 3.2. *For a given input distortion $D_X > 0$, and the corresponding lowest possible intermediate distortion achievable by an X -optimal approximation, $D_Y^{min} = \min \mathcal{D}_Y^*(D_X; X)$, the minimal achievable rate of distilling the intermediate layer directly is upper-bounded by the input rate-distortion (for the corresponding distortion values). Formally:*

$$R_X(D_Y^{min}; Y) \leq R_X(D_X; X).$$

Up to this point we have only shown that the supervised approach achieves no worse rate-distortion performance, we

³In some cases we may also consider the intermediate representation as our target giving us $\mathcal{D}_Y^*(D_X; X)$.

show next that under very reasonable conditions, the supervised approach is strictly better.

Theorem 4. *Begin with a set of X -optimal distributions $\mathcal{R}_X(D_X; X)$, and a corresponding lowest possible task distortion, $D_T^{min} = \min \mathcal{D}_T^*(D_X; X)$. If, for any $p(\hat{x}|x) \in \mathcal{R}_X(D_X; X)$, there exist two points $\hat{x}_1 \neq \hat{x}_2$ with non-zero probabilities, $p(\hat{x}_1), p(\hat{x}_2) \neq 0$, for which the task output is identical,⁴ $f(\hat{x}_1) = f(\hat{x}_2)$, and at least one input x for which $p(x|\hat{x} = x_1) \neq p(x|\hat{x} = x_2)$, then the minimal achievable rate of the supervised approach is strictly lower than the input rate-distortion (for the corresponding distortion values). Formally:*

$$R_X(D_T^{min}; T) < R_X(D_X; X).$$

Once again, the logic of Theorem 4 can be applied to distillation of an intermediate layer, giving the following result.

Corollary 4.1. *Under equivalent conditions to Theorem 4, for two points \hat{y}_1, \hat{y}_2 , the minimal achievable rate corresponding to distilling an intermediate layer Y directly, is strictly higher than that of the supervised approach (for corresponding distortion values). Formally:*

$$R_Y(D_T^{min}; T) < R_Y(D_Y; Y).$$

Of course, as in Corollary 3.2, we can consider the intermediate representation as our actual target, which would lead to the following result.

Corollary 4.2. *For two inputs \hat{x}_1, \hat{x}_2 with identical intermediate representation $g(\hat{x}_1) = g(\hat{x}_2)$, and under equivalent conditions⁵ to Theorem 4, the minimal achievable rate corresponding to distilling an intermediate layer Y directly, is strictly lower than the input-rate-distortion (for corresponding distortion values):*

$$R_X(D_Y^{min}; Y) < R_X(D_X; X).$$

Summarising our theoretic results we can draw some important conclusions, at least *in the limits of optimal encoding*:

- When training a compression method to optimise rate alongside task-distortion, all three considered approaches for coding for machines (full-input, model splitting, and direct) are equivalent.
- Optimising the compression model using the desired task labels will achieve better rate-distortion performance than what is achievable by attempting to use any unsupervised proxy, which is intuitively expected.
- The choice of the cut point does not affect rate-distortion performance, but the choice of the distillation point does. The latter means that we might be inclined to choose the cut point based on practical considerations for a given task, hardware platform, etc.

⁴In fact this only has to hold for $p(\hat{x}|x) \in \mathcal{R}_X(D; X)$, which also satisfy $\mathbb{E} [d_T(f(X), f(\hat{X}))] = D_T^{min}$

⁵It is important to note, that for practical task deep-models, these conditions are far less likely to hold for an intermediate representation than they are for the task labels.

III. DESIGN CONSIDERATIONS

Besides the conclusions presented above, a natural question to ask is whether deeper distillation points lead to better rate-distortion? Although the intuitive answer seems to be affirmative, the theory presented above does not yet provide a definitive proof, except in the special case when one of the points is the task output (i.e., the supervised case in Corollaries 3.1, 4.1). The question was tackled in our previous work [41], where affirmative answer was proved under certain conditions. Unfortunately, those conditions may be too restrictive in practice, and the search for the less-restrictive proof continues. In the meantime, we believe the benefits of using deeper points can be explained by further investigating the distortions used for distillation and their relationship with task labels.

A. Distillation, Distortion, and Task Performance

We explore the relationship above by considering the case of classification, which can be generalized to include many popular computer vision (CV) tasks such as object detection and instance/semantic segmentation. In classification, we can consider the task labels (and thus the optimal task-model) to be a clustering of the inputs such that each cluster contains all the inputs corresponding to that label. Given a classification problem with C classes, we can denote the clusters as follows:

$$\mathcal{X}_T^{(i)} = \{x \in \mathcal{X} : f(x) = i\}, \quad i = 1, 2, \dots, C. \quad (12)$$

Next, using our input distortion $d_X(x, \hat{x})$, define the expected distortion of cluster i relative to \bar{x} as

$$d_X^{(i)}(\bar{x}) = \sum_{x \in \mathcal{X}_T^{(i)}} p(x|X \in \mathcal{X}_T^{(i)}) d_X(x, \bar{x}). \quad (13)$$

Then intra-cluster distortion can be defined as follows:

$$D_X^{(i)} = d_X^{(i)}(\bar{x}^{(i)}), \quad \text{where } \bar{x}^{(i)} = \arg \min_{\bar{x} \in \mathcal{X}_T^{(i)}} d_X^{(i)}(\bar{x}). \quad (14)$$

Here, $\bar{x}^{(i)}$ is the centroid of the cluster in terms of the distortion metric $d_X(\cdot, \cdot)$. If, for example, the distortion is mean square error (MSE), a common metric for image compression, then $\bar{x}^{(i)} = \mathbb{E}[X|X \in \mathcal{X}_T^{(i)}]$ is the cluster mean, and $D_X^{(i)} = \text{var}(X|X \in \mathcal{X}_T^{(i)})$ is the cluster variance. Similarly, we can define the inter-cluster distortion of two clusters using their respective centroids:

$$D_X^{(i,j)} = d_X(\bar{x}^{(i)}, \bar{x}^{(j)}). \quad (15)$$

Finally, to get a measure of how well the task clustering coincides with the distortion on the input itself, we can use a variation of the silhouette score [45] as follows:

$$\rho_X^{(i,j)} = \frac{D_X^{(i,j)}}{\sqrt{D_X^{(i)} D_X^{(j)}}} \quad (16)$$

$$\rho_X^{(i)} = \min_{j \in \{1, 2, \dots, C\}} \rho_X^{(i,j)} \quad (17)$$

$$\rho_X = \mathbb{E} \left[\rho_X^{(i)} \right] = \sum_{j=1}^C \Pr(X \in \mathcal{X}_T^{(i)}) \rho_X^{(i)} \quad (18)$$

Under this formulation, the higher $\rho_X^{(i,j)}$ is, the easier it is to distinguish between the two clusters $\mathcal{X}_T^{(i)}, \mathcal{X}_T^{(j)}$ using the input distortion d_X and consequently $\rho_X^{(i)}$ is high if the cluster $\mathcal{X}_T^{(i)}$ is easily distinguishable from all other clusters. We name the final expression, ρ_X , the *task-appropriateness* of the distortion $d_X(\cdot, \cdot)$. When ρ_X is high, it means that by simply minimizing the distortion on X we can get good clustering with respect to our task T .

Next we examine the effect of optimizing distortion at the input compared to doing so at an intermediate layer Y , and analogously, between different layers Y_1 and Y_2 . We can do this by defining an equivalent clustering for the intermediate representations of each input:

$$\mathcal{Y}_T^{(i)} = \{y \in \mathcal{Y} : h(y) = i\}, \quad i = 1, 2, \dots, C. \quad (19)$$

Using this clustering we can now define the same set of metrics defined above: the centroid $\bar{y}^{(i)}$, the inter and intra cluster distortions $D_Y^{(i)}, D_Y^{(i,j)}$, and the silhouette-like scores $\rho_Y^{(i,j)}, \rho_Y^{(i)}, \rho_Y$. Once again, importantly, the higher the value of ρ_Y , the more appropriate the distortion metric d_Y is for clustering according to our task labels.

We claim that in many deep classification models, it can be shown that using equivalent distortion, such as MSE, the task-appropriateness of intermediate representations improves as we proceed deeper into the model. That is, given our previous notation of X, Y_1, Y_2 :

$$\rho_X \leq \rho_{Y_1} \leq \rho_{Y_2} \quad (20)$$

In our experiments presented in Section III-B, we demonstrate that this holds in practice: first for a toy problem, and subsequently for several classification datasets and DNN models. Later, in Section IV, we will show that in a practical system, this allows us to improve rate-distortion by choosing a deeper distillation point.

B. Empirical Evidence

1) *Toy Example:* We begin in a setting where optimal quantization can be analytically derived. Consider the classification task of two classes, which we will call ‘‘circles’’ and ‘‘squares’’, located in a two-dimensional space (which, to distinguish from our previous notation, we label u, v). For both classes, u values are uniformly distributed in $[0, 10]$, but v values differ: for the ‘‘squares’’, v values are uniformly distributed in $[0.8, 1.2]$, whereas for the ‘‘circles’’, v values are uniformly distributed in $[2.8, 3.2]$. In both cases, u, v values are independent. Next, we design a task model with two steps, similar to our formulation: $f = h \circ g$, such that $T = f(X)$ and $Y = g(X)$, where:

$$g(u, v) = \begin{cases} (2.5 + \text{sgn}(u-5) \cdot \sqrt{|0.2^2 - (v-3)^2|}, v), & v > 2, \\ (7.5 + \text{sgn}(u-5) \cdot \sqrt{|0.2^2 - (v-1)^2|}, v), & v \leq 2, \end{cases}$$

$$h(u, v) = \begin{cases} \text{‘‘circle’’}, & v > 2, \\ \text{‘‘square’’}, & v \leq 2. \end{cases}$$

Fig. 2 shows the distribution of the two classes at the input X and the intermediate layer Y . By using MSE⁶ as

⁶We use MSE using the ℓ_2 norm squared, meaning $d^{MSE}((u_1, v_1), (u_2, v_2)) = (u_1 - u_2)^2 + (v_1 - v_2)^2$.

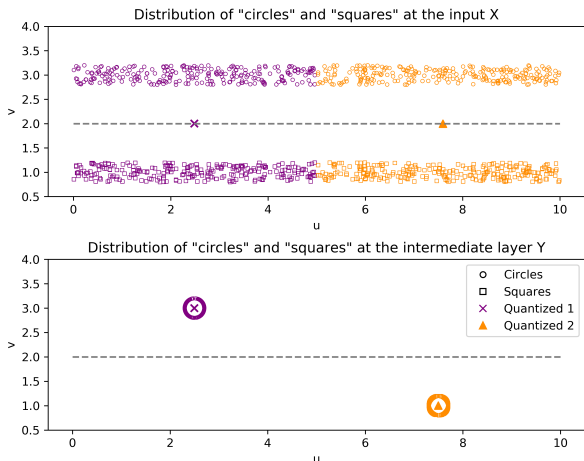

Fig. 2: Distribution and quantization of “circles” and “squares” at both the input and the intermediate layer. The marker symbol corresponds to the class of each point, whereas the color corresponds to the 1-bit bin to which each point is quantized to minimize MSE.

our distortion for both the input X and the intermediate layer Y we can calculate the task-appropriateness of MSE at each layer. We get $\rho_X = \rho_X^{\text{squares}} = \rho_X^{\text{circles}} \approx 0.48$, and $\rho_Y = \rho_Y^{\text{squares}} = \rho_Y^{\text{circles}} = 725$.

Next, we consider the optimal 1-bit quantization, and observe how the choice of distillation point affects task performance under such rate-constrained quantization.⁷ It is simple to show that in the input space X , the optimal 1-bit quantization in terms of MSE is simply to use the two bins $u \leq 5$, $u > 5$ and quantized values $\hat{x}_1 = (2.5, 2)$, $\hat{x}_2 = (7.5, 2)$. In intermediate layer Y , the points in each class are distributed on the circumference of a circle with different centers, with “circles” centered at $(2.5, 3)$ and “squares” centered at $(7.5, 1)$. Here there are many equivalent optimal bin choices (due to the large empty space between the two distributions) but for simplicity, the same bins as in the input space can be used, leading to the quantized values $\hat{y}_1 = (2.5, 3)$, $\hat{y}_2 = (7.5, 1)$. The quantization bins are indicated in Fig. 2 by the color of each point, with the quantized values described by correspondingly colored marker.

By observing Fig. 2 we can see clearly that using quantization optimized for MSE at the input leads to a classification error of 50%. This is because each bin contains an equal amount of observations from both classes. Since each bin is assigned a single corresponding value, the task-model f can only output one label for it (in fact, both bins are assigned “square”), leading to the aforementioned classification error. In contrast, when optimizing quantization for MSE at the intermediate layer Y , we can see that all observations in each of the two bins are from the same class, and their representative values are such that the task back-end h will assign them the correct label, leading to perfect classification. Thus, under the 1-bit rate constraint and using MSE distortion, a deeper representation (Y) offers better performance for the

classification task than the input (X).

Although highly contrived, the example above is helpful in understanding the relationship between task-appropriateness of a distillation point, the distortion metric,⁸ and rate-distortion. In general, however, we do not know the exact distribution of inputs in each class, nor do we have an optimal task model or optimal compression. Instead, we first demonstrate (Section III-B2) that the behaviour of task-appropriateness remains consistent with our claim in practical deep classification models. Later in Section IV, we will show how this translates to improved rate-distortion in the unsupervised training of learnable codecs for machines.

2) *Deep Classification Models:* In order to examine the behaviour of task-appropriateness in practical models, we consider two well known classification models - VGG16 [46] and ResNet50 [47], and two well known datasets - CIFAR-10 and CIFAR-100 [48]. We use MSE as our distortion metric, which allows us to use $\bar{x}^{(i)} = \mathbb{E}[X|X \in \mathcal{X}_T^{(i)}]$. We replace the expectation with a sample mean, and calculate the average task-appropriateness score for several layers along each model. Because the representations are very high dimensional, we utilize t-SNE [49] to help visualize the relationship between the spatial clusters and the class labels. Fig. 3 shows this relationship for several layers of VGG16, using MSE, for the CIFAR-10 dataset. Additional similar figures are included in Appendix C-B of the supplemental material. As seen in Table I, where bold type indicates the highest value for a given (model, dataset) pair, in both models and both datasets, our claim regarding the behaviour of the task-appropriateness holds. This result, combined with the toy-example, suggests that there is good reason to expect that distilling deeper layers results in improved rate-distortion for machines using deep task-models.

TABLE I: Task-Appropriateness Using Mean Squared Error for Various Layers in Deep Classification Models

Dataset	Model	Layer	Task-Appropriateness ρ
CIFAR-10	-	Input	0.038
	VGG16	Features.19	0.052
		Features.26	0.517
		Features.32	1.0
	ResNet50	Layer2	0.021
Layer3		0.102	
Layer4		1.0	
CIFAR-100	-	Input	0.036
	VGG16	Features.19	0.046
		Features.26	0.120
		Features.32	0.555
	ResNet50	Layer2	0.032
		Layer3	0.050
Layer4		0.997	

⁷We choose to start at the rate, which is equivalent to investigating the distortion-rate, rather than the rate-distortion, for convenience, as the two are equivalent.

⁸The toy classification problem would have been easy to solve even in the input space if we used a distortion metric other than MSE.

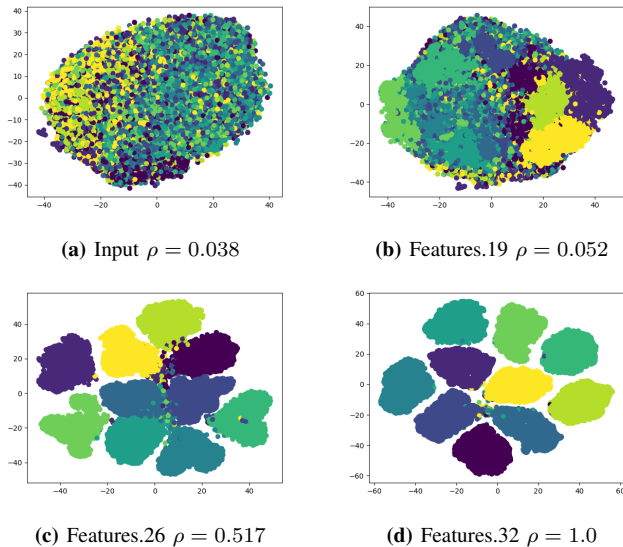

Fig. 3: Task appropriateness and t-SNE visualization for various tasks. Instead, we use modified BD metrics replacing the PSNR with an appropriate task metric such as classification accuracy, mean average precision, etc. Considering the significant number of different experimental setups we present, the description of each one in this section will be limited, with further details regarding task-models, as well as training procedures available in Appendix B of the supplemental material. Furthermore, because of the difference between the CV tasks and compression settings, we present comparable work for each experiment individually.

IV. IMAGE CODING FOR MACHINES

The theoretical analysis alongside our motivating hypotheses and corresponding empirical evidence can be combined to inform critical design choices in coding for machines. In this section we demonstrate how these conclusions can be put into effect for several different settings in image coding for machines, using a variety of computer vision tasks. We explore the performance of both the model-splitting approach and direct coding for machines on a combination of supervised and unsupervised optimization settings. In all settings we use learnable image codecs, with a loss function introduced earlier in (1):

$$L = R + \lambda D,$$

where R is the rate and D is the task-related distortion.

In our supervised setting experiments, we have access to task labels and thus use task-distortion directly as D . On the other hand, in all unsupervised experiments, task-labels are assumed to be unavailable, meaning we must use some feature tensor as a target. In such cases we refer to D as distillation loss, and the training process as model distillation (sometimes known as knowledge-distillation [13]). We draw upon the results of Corollaries 2.1, 2.2, and 2.4, and decouple the choice of cut point from that of the distillation point. Furthermore, we utilize pretrained layers from the original task-model, which we refer to as the *mid-model*, as part of the decoding process. Model distillation is thus performed as a two-step procedure, which can be seen in Fig. 4. First our codec is used to recreate the output of the chosen cut point; the resulting quantized feature tensor is then passed to the mid-model to obtain the reconstructed distillation point, which is then compared to its uncompressed equivalent derived from the same input.

In all tasks we present rate-accuracy curves (rather than rate-distortion) and utilize the Bjøntegaard Delta (BD) metric [50],

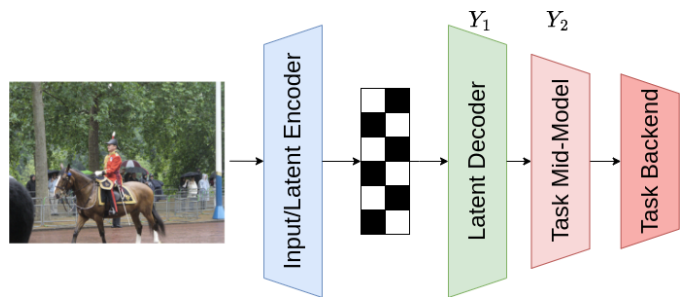

Fig. 4: Model distillation approach - Note that our latent decoder only recreates the cut-point Y_1 . To obtain the distillation loss at the point Y_2 , we make use of pre-trained layers of the original task-model, which we denote the task mid-model.

[51], a well-established metric for estimating the average difference between two such curves. The original BD metric is design using peak signal to noise ratio (PSNR), which of course is not available in the case of most computer vision tasks. Instead, we use modified BD metrics replacing the PSNR with an appropriate task metric such as classification accuracy, mean average precision, etc. Considering the significant number of different experimental setups we present, the description of each one in this section will be limited, with further details regarding task-models, as well as training procedures available in Appendix B of the supplemental material. Furthermore, because of the difference between the CV tasks and compression settings, we present comparable work for each experiment individually.

A. Model Splitting

We have seen, in Theorems 3 and 4, that supervised optimization of compression models for machines has better theoretic rate-distortion performance. We also showed that the choice of cut point does not, in the optimal case, change rate-distortion performance. Furthermore, in Section III we showed that classification task-appropriateness of MSE distortion on feature tensors increases as we go deeper into the task-model, suggesting that distilling deeper model layers is preferable in unsupervised optimization. Thus, our first experiment aims to compare the compression performance of various supervised and unsupervised variations of an otherwise equivalent model-splitting coding scheme.

Our model-splitting coding scheme is used to evaluate rate-distortion performance for an image classification task. To make our approach viable in a real-world setting we impose the following additional constraints:

- 1) The latent encoder and decoder should have low computational complexity compared to the original DNN model being considered (which comprises the task frontend and backend in Fig. 1b) so that the overhead introduced by our method during actual deployment is low.
- 2) The parameters (weights etc.) of the original DNN model remain frozen throughout the entire process. Thus, whenever the compression model is trained using the loss-term in Equation (1) – either for a different cut-point, or for a different λ value – it is only the parameters

of the latent encoder and decoder that are updated, not those of the original model.

Such constraints have been considered in our recent work [36], [52] and are motivated by conditions that exist in practical real-world setups. To abide by these constraints, we restrict the latent encoder to be a single depth-wise separable convolutional layer. We do this because this method has the fewest parameters and lowest complexity compared to other topologies [53] that transform an intermediate tensor of size $H \times W \times C$ into a lower dimensional tensor of size $H_r \times W_r \times C_r$, such that $H_r \leq H, W_r \leq W, C_r \leq C$. W_r and H_r are related to W and H by $W_r = W/S$ and $H_r = H/S$, where S is the stride factor of the convolutional kernel.

The encoder is followed by quantization with step size Q , and an entropy coder. The decoder contains an entropy decoder followed by a simple mirror image of the encoder. As explained in [36], the rate-distortion performance is influenced by architectural hyper-parameters of the latent encoder such as the stride S , and number of output channels C_r , and also by compression-related hyperparameters such as the Lagrange multiplier λ and the quantization step-size Q . These hyperparameters interact in complex ways to determine the eventual rate-distortion performance. We therefore have to search this hyperparameter space to arrive at an optimal set. We follow the search space procedure described in [36] to arrive at a set of Pareto-optimal design points for the latent encoder and decoder. More details are provided in Appendix B-A of the supplemental material.

We test our model-splitting scheme on an image classification task using both supervised and unsupervised approaches. The models are trained with a rate-distortion loss objective from Equation (1). In the unsupervised approach, the distortion term D is essentially an MSE-based distillation loss, while for the supervised approach, the distortion loss is the usual cross-entropy loss used for classification. For the rate-loss R , we use a neural rate estimator from our previous work [52] to estimate the rate at the output of the latent encoder. Briefly, the lower-dimensional latent encoder outputs Z (y in [52]) are interpreted as reduced-dimension latent-representation of the feature tensor at the split point Y (x in [52]). Inspired by [54], we derived a set of hyper-latents Z_h from Z by using an additional variational auto-encoder model for the hyperprior. We use a Gaussian scale-hyperprior, meaning $Z|Z_h \sim \mathcal{N}(0, \sigma(Z_H))$ where σ is the output of the hyperprior decoder. The overall rate is estimated as the sum of the rates of the Z and Z_h respectively, i.e.

$$\mathcal{R} = \mathbb{E}[-\log_2 p(Z_h) - \log_2 p(Z|Z_h)] \quad (21)$$

More details are provided in Appendix B-A of the supplemental material.

We select a ResNet50 [47] network trained on the ImageNet dataset [55] as our task model and perform the evaluation as follows. First, we expand on results from [52] by comparing our approach against state-of-the-art benchmarks which include two machine-learning-based compression methods – variational image compression [54] and Entropic Student [31] – and two standards based compression – the previously reported HEVC and newly included VVC. We see from Fig. 5

that our method easily outperforms these benchmarks by achieving lower bit-rates for any given accuracy level. Note that because our method achieves significantly lower bit-rates than the benchmark curves, there is insufficient overlap to calculate BD-metrics.

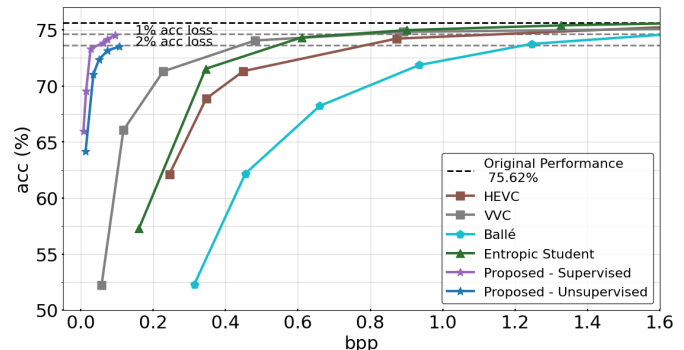

Fig. 5: Benchmark comparison for image classification in a model-splitting setup using ResNet50, on the Imagenet validation set.

Next, to validate the theory developed in Section II, we evaluate in greater depth the impact of the choice of distillation layer for different cut-points (as opposed to selecting the only the last layer as the distillation layer for unsupervised training as was done in [52]). Here, we select two different cut-points (C_1 and C_2), and two different distillation points (M_1 and M_2 in order of depth) for each of the cut-points. We also reproduce some of the curves from [52] for the supervised approach which uses a supervised training loss (cross-entropy) for the task T . For each cut-point, therefore, we generate three curves: two using an unsupervised distillation loss, and one using a supervised task loss. These results are shown in Fig. 6. We observe that as predicted by our theoretical analysis, choosing deeper distillation points leads to improved rate-distortion performance for both cut-points, and that using a supervised loss outperforms the unsupervised alternatives.

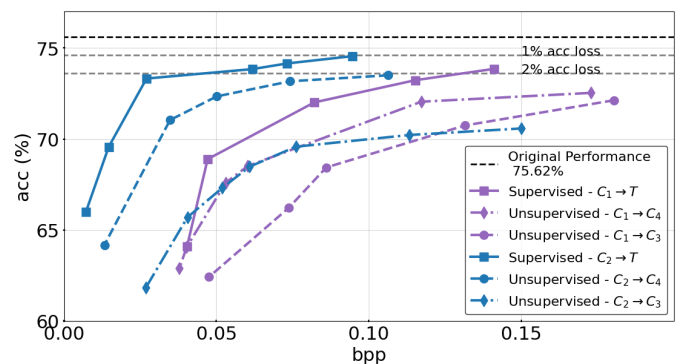

Fig. 6: Impact of choice of distillation points for classification using Resnet50 on the Imagenet validation set. Note that as predicted by our theoretical analysis, deeper distillation points yield better performance curves.

Interestingly, though, we see that under this experimental setup the cut point does in fact change rate-distortion performance, with deeper cut points achieving better performance. Clearly this is a result of the design and computational constraints we have chosen for our coding scheme. To ensure

this is in fact the case, we increase the computational capacity and complexity of the compression model in our next set of experiments, and re-evaluate the effect of the different cut points in that setting.

B. Direct Coding for Machines

Having established that our theory regarding the choice of distillation point lends itself well to design considerations in a model-splitting coding scheme, we move on to the direct coding approach. As in the model-splitting experiments, we compare the rate-distortion performance of multiple possible choices of either cut point or distillation point in an otherwise identical model. Importantly, in the direct-coding approach, we do not include the supervised optimization, and focus on the more difficult unsupervised setting. Additionally, as explained above, we remove the computational constraints on the coding scheme, to more closely approach the optimal limit of our theoretic formulation, especially regarding the effects of the choice of cut point. We perform this experiment for three CV tasks-models - object detection using Faster R-CNN [2] as well as YOLOv3 [1], and image segmentation using Mask R-CNN [4].

It is important to note that more complex CV tasks, such as the ones in question, are often best performed by multi-scale models, which process an input image at several resolutions at once. Often, doing this involves multi-stream processing in which shallower feature tensors are still needed for the task backend, even in the presence of deeper ones. This means that when we perform model distillation on a multi-stream model, we must take special care in choosing our distillation points such that they adequately cover all processing streams. For example, we may choose an early layer, before the computation has split into multiple streams, but this greatly limits the depth of our distillation point. Alternatively, we may choose several feature tensors which together ensure all processing streams are accounted for, allowing us to effectively select a deeper distillation point.

In all 3 tasks experiments, we use an identical compression model, similar to the "base-layer" of the scalable codec in [17], which in turn is largely based on [21]. First, a synthesis transform is used to produce a latent representation. This transform is comprised of downsampling blocks, as well as residual convolutional blocks, all using generalized divisive normalization (GDN [56]) activations. Next the latent representation is quantized and encoded using an autoregressive hyperprior entropy model [19], followed by arithmetic encoding. After decoding the resulting bitstream, the recreated latent representation is processed by a latent decoder⁹ comprised of residual blocks and inverse GDN activations, as well as upsampling blocks. The output of the latent decoder is used as our recreated cut point, which can then be fed to the mid-model to obtain the distillation point during training, or to the full task backend during inference. Further details on the architecture of our direct-coding model can be seen in Appendix B-C of the supplemental material.

1) *Object Detection Using Faster R-CNN*: Our first task-model used for direct-coding is Faster R-CNN [2], a well established benchmark in object detection. The Faster R-CNN architecture is comprised of a feature proposal network (FPN) based on a backbone model, followed by region proposal network (RPN), and finally Region of Interest (RoI) pooling to provide bounding boxes and class labels. More detail regarding the full architecture of the Faster R-CNN, and specifically the FPN, can be seen in Appendix B-D of the supplemental material. Notably, this model is an example of a multi-stream model, which means our distillation points must be carefully chosen as explained above. On the other hand, Corollary 2.2 suggests that the choice of cut point does not have a strong impact on our rate-distortion performance. Thus we can greatly simplify our approach by choosing our cut points from the shallower, single-stream portion of the model.

For our experiments we use on ResNet50 [47] as the backbone model and compare 3 possible distillation points and 2 cut points, all taken from the FPN portion of Faster R-CNN. Our cut points, in order of depth, are labeled C_3 , and C_4 (to distinguish from those used in the classification experiments), and our distillation points include the two cut points, as well as the deeper M_3 . We use MSE as our distillation loss metric, and compare the rate-distortion performance of the various configurations. For obvious reasons, we cannot use a deeper cut point than the corresponding distillation point, leading to 5 possible combinations. Importantly, because the point M_3 consists of 5 tensors of different dimensions, we chose to use the unweighted average of the 5 MSE losses as our distillation loss when using C_3 :

$$MSE(M_3, \widehat{M}_3) = \frac{1}{5} \sum_{i=1}^5 MSE(Y_i, \widehat{Y}_i) \quad (22)$$

where Y_i are the tensors which comprise M_3 . For details on the location of C_3, C_4, M_3 and the architecture of Faster R-CNN see Appendix B-D of the supplemental material.

Training is performed in two stages using a combination of CLIC [57], JPEG-AI [58], and VIMEO-90K [59] datasets. For full details, including hyper parameters see Appendix B-D of the supplemental material. The Faster R-CNN task model in all experiments was pretrained with the weights taken from the DetectronV2 [60] implementation. Since benchmark performance in DetectronV2 is reported using the COCO2017 [61] validation set, we evaluate our models using the same dataset. For our accuracy metric, we choose the commonly used mean average precision, averaged over a range of intersection of union (IoU) thresholds between 50 – 95%, which we denote mAP for brevity.

As mentioned earlier, we choose 2 cut points and 3 distillation points for Faster R-CNN model as the machine task. After training, we evaluated the model's performance on the COCO2017 validation set, which contains 5000 RGB images. The results, shown in Figure 7, demonstrate that the cut and distillation points have a significant impact on the model's performance. The BD-rates corresponding to the curves in Fig. 7, calculated using our $C_3 \rightarrow C_3$ model as the anchor, are reported in Table II. Analysing these results demonstrates, that

⁹This decoder was referred to as the latent space transform (LST) in [17].

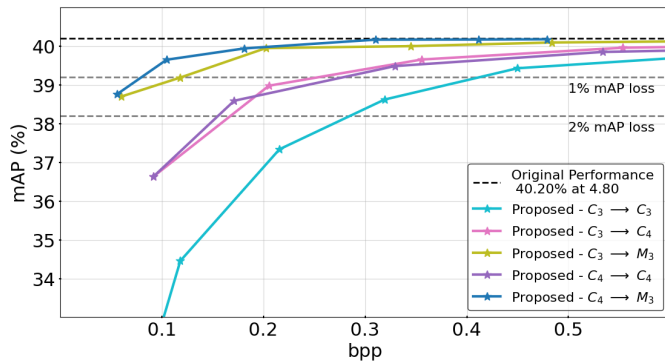

Fig. 7: Comparison of multiple choices of cut and distillation points for object detection using Faster R-CNN on the COCO2017 validation set. Note that as predicted by our theoretical analysis, the effects of the choice of cut point on rate-distortion are far smaller than those of the choice of distillation point. The baseline bit-rate is calculated using the original format of the dataset (JPEG).

as our theory suggests, using deeper distillation points results in BD-rate and BD-mAP improvements, while changing the cut point does not change RD performance much. Changing the distillation point from C_3 to C_4 results in a 36.57% BD-rate saving, while also changing the cut point to C_4 adds a mere 2% more savings in BD-rate with nearly identical BD-mAP. Lastly, using our deepest distillation point, M_3 (with C_4 as the cut point), we observe an 82.34% BD-rate savings and 4.38% BD-mAP improvement, compared with the shallowest. This strengthens our hypothesis that deepening the distillation point contributes significantly to improving the RD performance.

TABLE II: Rate-Distortion Performance of Various Cut and Distillation Points for Faster R-CNN and Mask R-CNN

Model	Faster R-CNN		Mask R-CNN	
	BD-Rate	BD-mAP	BD-Rate	BD-mAP
$C_3 \rightarrow C_3$	0	0	0	0
$C_3 \rightarrow C_4$	-36.57	1.46	-44.02	1.47
$C_3 \rightarrow M_3$	-77.43	3.53	-65.41	2.67
$C_4 \rightarrow C_4$	-38.50	1.35	-45.58	2.040
$C_4 \rightarrow M_3$	-82.34	4.38	-78.45	3.28
Choi2022	0	0	0	0
$C_4 \rightarrow M_3$	-36.58	0.27	-18.95	0.14
VVC	239.37	-2.33	241.85	-2.33
HEVC	268.01	-3.07	278.26	-2.98
Cheng2020	305.83	-3.62	266.13	-3.49

After observing the results of our study regarding the effects of the various cut and distillation points, we proceed to compare our best performing configuration ($C_4 \rightarrow M_3$) with three traditional compression benchmarks: VVC [15] using the VTM 12.3 [62] reference software, HEVC [29] using the HM16.20 reference software [63], as well as the learnable codec of [21] (which we refer to as Cheng2020), as implemented in CompressAI [64]. Additionally, we also include the base layer from scalable human and machine codec presented in [17] (to which we refer as Choi2022) as one of our benchmarks.

Observing the results, shown in Fig. 8 and the corre-

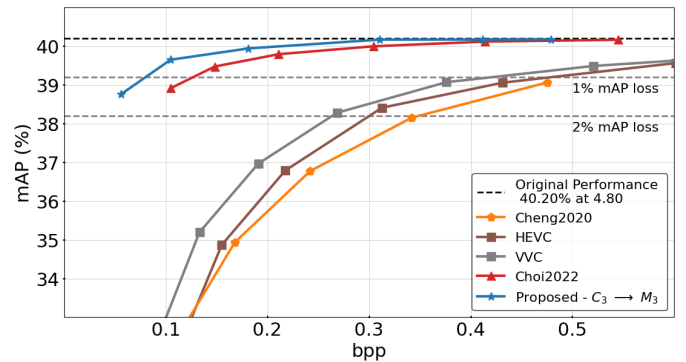

Fig. 8: Benchmark comparison for object detection using Faster R-CNN, on the COCO2017 validation set.

sponding BD-metrics in Table II, we see that our proposed method represents significant improvement over the various benchmarks. For example our model remains within 1% mAP at rates of lower than 0.1 bits per pixel, where traditional compression methods already suffer over 6% of degradation. Even when compared with the previous SOTA, the proposed method achieves BD-rate savings of over 36%, representing a significant improvement.

As its title suggests [17], the previous state of the art in compression for YOLOv3, Faster R-CNN, and Mask R-CNN was established by a scalable codec. Choi *et al.* use a single synthesis transform to produce two latent representations: the base layer which is used for both machine analysis and image reconstruction, and an enhancement layer which is used alongside base for human vision only. This dual usage of the base layer means that during optimization, its features must support both the CV task and image reconstruction, which may be a source of suboptimality in RD performance for the base. Interestingly, the base layer distillation loss in [17] is calculated equivalently to our $C_4 \rightarrow M_3$ model, and still yields better RD performance compared with task-only models using shallower distillation. For example, when compared with our $C_4 \rightarrow C_4$ model, [17] achieves BD-rate savings of close to 55%. This means that the effects of a deeper distillation point are strong enough to overcome a secondary task.

2) *Instance Segmentation Using Mask R-CNN:* Our second task-model for the direct coding for machines approach is Mask R-CNN [4], a well established benchmark for instance segmentation. This model shares many characteristics with Faster R-CNN, of which the most important for our experiments is the FPN. Because the FPN for Mask R-CNN is identical in architecture to that of Faster R-CNN, we are able to select the same cut and distillation points, C_2, C_3, M_3 , as well as the same distortion loss for M_3 as in Equation (22). For further details on the full architecture of Mask R-CNN see Appendix B-D of the supplemental material.

Training for our Mask R-CNN models was also performed in an identical manner to that of Faster R-CNN, with the pretrained task-model taken from DetectronV2. Once again, we begin with the ablation study observing the effects of our choice of cut and distillation point before picking the most successful configuration to compare with the benchmarks. Although several different metrics are commonly used in

instance segmentation literature such as mean intersection over union (mIOU), we choose to use the same metric as in object detection for convenience in comparing the two experiments.

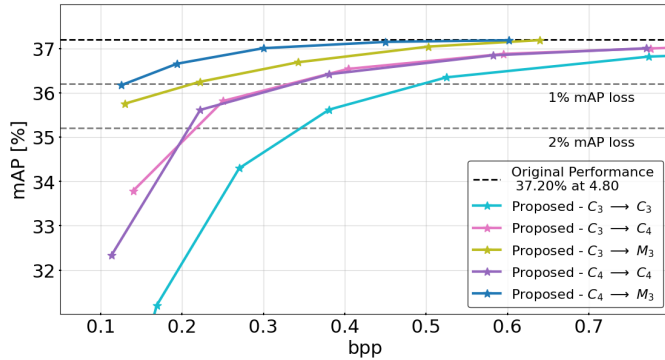

Fig. 9: Comparison of multiple choices of cut and distillation points for instance segmentation using Mask R-CNN on the COCO2017 validation set. Once again we see the increased importance of the choice of distillation point compared to the choice of cut point.

Figure 9 and Table II demonstrate that the RD-performance trend seen with Faster R-CNN and suggested by our theoretic analysis holds for Mask R-CNN. Here too we see a significant boost in RD-performance by using deeper distillation point, and very little change due to cut point. Specifically, calculating the distortion based on C₄ (with C₃ as the cut point) leads to 44% savings in BD-rate and 1.47% better mAP on average, while using deepest distillation point M₃ results in 78.45% BD-rate savings and a 3.28% improvement in BD-mAP when the model is split at C₄. Here too we compare our deepest, best performing configuration C₄ → M₃ to the same benchmarks used in the Faster R-CNN experiment. Once again, we see that the proposed method outperforms traditional methods by a large margin, and shows BD-rate savings of close to 20% over the previous SOTA of [17].

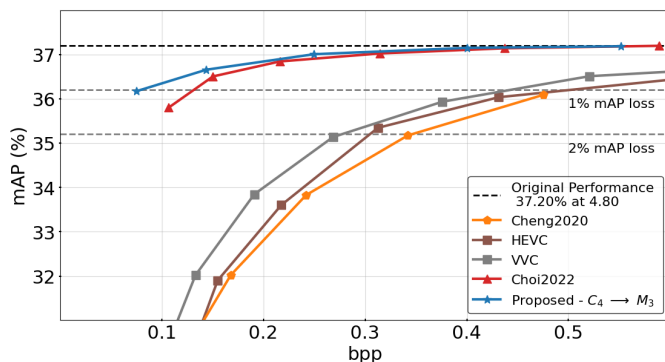

Fig. 10: Benchmark comparison for instance segmentation using Mask R-CNN, on the COCO2017 validation set.

3) *Object Detection Using YOLOv3:* Our third and final task-model is YOLOv3 [1], another well established method for object detection. Having established the relative insignificance of the choice of the cut point in the Faster R-CNN and Mask R-CNN experiments (as expected from Corollary 2.2), we pick a single cut point and focus on 4 different distillation

points. Our different distillation points are labeled C₅, M₄, M₅, O, representing the cut point, 2 different choices of the mid-model, and the final multi-scale output of YOLOv3 (which is not identical to the task labels T). For more details on the exact location of the different model layers see Appendix B-E of the supplemental material. Similarly to the previous two experiments, distillation points M₄, M₅ and O are comprised of multiple tensors. For the case of YOLOv3, we found it beneficial to average the MSE loss of the multiple tensors by weighting each tensor by the number of elements it contains, leading to:

$$MSE(Y, \hat{Y}) = \frac{1}{\sum_{i=1}^K E_i} \sum_{i=1}^K \|Y_i - \hat{Y}_i\|_2^2, \quad (23)$$

where $Y_i, i = 1, \dots, K$ are the tensor in the distillation point, E_i is the number of elements in the tensor Y_i , and $\|\cdot\|_2^2$ is the squared l_2 norm¹⁰.

Training is performed using the same two stage approach used in the R-CNN experiments (including datasets and learning rate strategy), using the same loss from Equation (1). Nonetheless there were slight differences in hyper-parameters, which are reported in Appendix B-E of the supplemental material. Here too, the task model is maintained fixed throughout training and uses pretrained weights, this time from the Darknet implementation [65], [66], which was also used for performing inference in all configurations and benchmarks. All models were evaluated using 5000 images from the COCO2014 [61] dataset, using the mean average precision at 50% IOU, which we denote mAP@50, as was done in the previous SOTA [17].

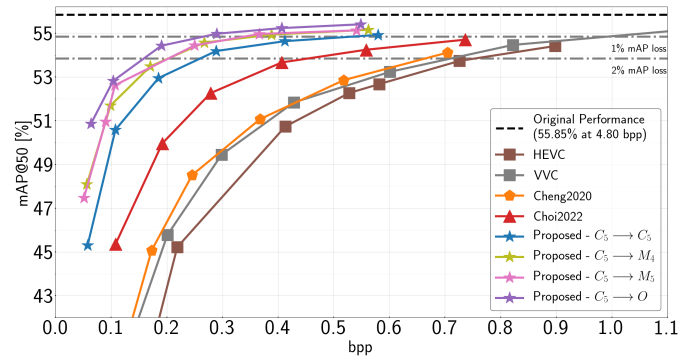

Fig. 11: Benchmark comparison for Object detection using YOLOv3, on 5000 images from the COCO2014 validation set. The baseline bit-rate is calculated using the original format of the dataset (JPEG).

Our results, as shown in Fig. 11 and summarized in Table III demonstrate that in the case of YOLOv3, as in the previous experiments, using deeper distillation points leads to improved rate-distortion, with BD-Rate savings of 43.1% for distillation point O when compared with distillation point C₅, and BD-Rate saving of 67.5% when compared with the previously SOTA base layer from [17]. Interestingly, even our models with earlier distillation points achieve better RD performance than the previous SOTA (which is equivalent to

¹⁰In practice this is implemented by flattening and concatenating the tensors, followed by a standard element-wise MSE

our $C_5 \rightarrow C_5$ setup). This likely means that our improvements result from a combination of the deeper distillation point and our models not having to balance the performance of the machine vision task with the quality of image reconstruction (the enhancement layer in [17]). In our previous work [41], we isolated the effects of the distillation point by comparing otherwise identical scalable coding models, only separated by their choice of distillation point. For completeness, a full detailing of this experiment alongside the results can be found in Appendix C-A of the supplemental material.

TABLE III: Rate-Distortion Performance for YOLOv3

Model	BD-Rate[%]	BD-mAP[%]
$C_5 \rightarrow C_5$	-44.2	2.44
$C_5 \rightarrow M_4$	-58.1	3.14
$C_5 \rightarrow M_5$	-59.7	3.32
$C_5 \rightarrow O$	-67.4	3.65
Choi2022	0	0
VVC	66.4	-3.90
HEVC	89.3	-5.86
Cheng2020	54.5	-3.47

V. SUMMARY AND CONCLUSION

The field of coding for machines is rapidly evolving with promising developments and a growing number of potential applications. In this work we have presented a formulation of rate-distortion theory as it pertains to coding for machines, with specific attention to coding for deep models. We have proven, that in the optimal case, three of the most commonly used approaches today are essentially equivalent in terms of their optimal RD performance.

Furthermore, we have shown both theoretically and empirically, that using a supervised approach leads to superior RD performance and were able to achieve SOTA compression for image classification using this insight. In the unsupervised case, where one does not have access to task labels, we argue that distilling deeper layers is preferable. While our theory does not provide definitive proof of this claim, we provide strong empirically-based hypotheses for the cause at the root of our claim. Furthermore, by selecting deeper distillation points for our model we are able to achieve SOTA rate-distortion performance for several CV tasks, all trained in an unsupervised manner.

We believe that grounding the research in coding for machines with relevant sound theoretical background is crucial to ensure the longevity of resulting methods. At the same time, using theoretical insights enables the creation of stronger, more efficient coding schemes, as is evident by the state-of-the-art empirical performance of our proposed methods.

REFERENCES

- [1] J. Redmon and A. Farhadi, "YOLOv3: An incremental improvement," *arXiv preprint:1804.02767*, Apr. 2018.
- [2] S. Ren, K. He, R. Girshick, and J. Sun, "Faster r-cnn: Towards real-time object detection with region proposal networks," in *Proc. NeuRIPS*, C. Cortes, N. Lawrence, D. Lee, M. Sugiyama, and R. Garnett, Eds., vol. 28. Curran Associates, Inc., Dec. 2015.
- [3] Z. Liu, Y. Lin, Y. Cao, H. Hu, Y. Wei, Z. Zhang, S. Lin, and B. Guo, "Swin transformer: Hierarchical vision transformer using shifted windows," in *Proc. ICCV*, Oct. 2021, pp. 10012–10022.
- [4] K. He, G. Gkioxari, P. Dollár, and R. Girshick, "Mask R-CNN," in *Proc. ICCV*, Oct. 2017, pp. 2961–2969.
- [5] A. Kirillov, E. Mintun, N. Ravi, H. Mao, C. Rolland, L. Gustafson, T. Xiao, S. Whitehead, A. C. Berg, W.-Y. Lo *et al.*, "Segment anything," *arXiv preprint:2304.02643*, 2023.
- [6] J. Devlin, M.-W. Chang, K. Lee, and K. Toutanova, "BERT: Pre-training of deep bidirectional transformers for language understanding," in *Proc. NAACL-HLT 2019*, vol. 1, June 2019, pp. 4171–4186.
- [7] T. Brown, B. Mann, N. Ryder, M. Subbiah, J. D. Kaplan, P. Dhariwal, A. Neelakantan, P. Shyam, G. Sastry, A. Askell *et al.*, "Language models are few-shot learners," *Proc. NeuRIPS*, vol. 33, pp. 1877–1901, 2020.
- [8] A. Radford, J. W. Kim, T. Xu, G. Brockman, C. McLeavey, and I. Sutskever, "Robust speech recognition via large-scale weak supervision," *arXiv preprint:2212.04356*, Sept. 2022.
- [9] A. Baevski, W.-N. Hsu, A. CONNEAU, and M. Auli, "Unsupervised speech recognition," in *Proc. NeuRIPS*, vol. 34, Dec. 2021, pp. 27826–27839.
- [10] J. Dean, D. Patterson, and C. Young, "A new golden age in computer architecture: Empowering the machine-learning revolution," *IEEE Micro*, vol. 38, no. 2, pp. 21–29, Apr. 2018.
- [11] A. Howard, M. Sandler, G. Chu, L.-C. Chen, B. Chen, M. Tan, W. Wang, Y. Zhu, R. Pang, V. Vasudevan, Q. V. Le, and H. Adam, "Searching for mobilenetv3," in *Proc. ICCV*, Oct. 2019.
- [12] F. F. dos Santos, P. Navaux, L. Carro, and P. Rech, "Impact of reduced precision in the reliability of deep neural networks for object detection," in *Proc. ETS*. IEEE, 2019, pp. 1–6.
- [13] J. Gou, B. Yu, S. J. Maybank, and D. Tao, "Knowledge distillation: A survey," *Int. J. Comput. Vis.*, vol. 129, pp. 1789–1819, Mar. 2021.
- [14] N. Shlezinger and I. V. Bajić, "Collaborative inference for AI-empowered IoT devices," *IEEE Internet Things Mag. IoTM*, vol. 5, no. 4, pp. 92–98, Dec. 2022.
- [15] "Versatile video coding," rec. ITU-T H.266 and ISO/IEC 23090-3, 2020, Int. Telecomm. Union-Telecomm. (ITU-T) and Int. Standards Org./Int/Electrotech. Comm. (ISO/IEC JTC 1).
- [16] "ISO/IEC 14496-3:2005 - information technology — coding of audiovisual objects — part 3: Audio," ISO/IEC JTC 1/SC 29 Coding of audio, picture, multimedia and hypermedia information.
- [17] H. Choi and I. V. Bajić, "Scalable image coding for humans and machines," *IEEE Trans. Image Process.*, vol. 31, pp. 2739–2754, Apr. 2022.
- [18] Y. Kang, J. Hauswald, C. Gao, A. Rovinski, T. Mudge, J. Mars, and L. Tang, "Neurosurgeon: Collaborative intelligence between the cloud and mobile edge," *ACM SIGARCH Comput. Archit. News*, vol. 45, no. 1, pp. 615–629, Apr. 2017.
- [19] D. Minnen, J. Ballé, and G. D. Toderici, "Joint autoregressive and hierarchical priors for learned image compression," *Proc. NeuRIPS*, vol. 31, pp. 10771–10780, Dec. 2018.
- [20] J. Ballé, V. Laparra, and E. Simoncelli, "End-to-end optimized image compression," in *Proc. ICLR*, Apr. 2017.
- [21] Z. Cheng, H. Sun, M. Takeuchi, and J. Katto, "Learned image compression with discretized gaussian mixture likelihoods and attention modules," in *Proc. CVPR*. IEEE/CVF, June 2020.
- [22] D. He, Z. Yang, W. Peng, R. Ma, H. Qin, and Y. Wang, "Elic: Efficient learned image compression with unevenly grouped space-channel contextual adaptive coding," in *Proc. CVPR*. IEEE/CVF, June 2022, pp. 5718–5727.
- [23] W. Jiang, J. Yang, Y. Zhai, and R. Wang, "Multi-reference entropy model for learned image compression," *arXiv preprint:2211.07273*, 2022.
- [24] Y.-H. Ho, C.-C. Chan, W.-H. Peng, H.-M. Hang, and M. Domański, "ANFIC: Image compression using augmented normalizing flows," *IEEE Open J. Circuits Syst.*, vol. 2, pp. 613–626, Nov. 2021.
- [25] O. Rippel, S. Nair, C. Lew, S. Branson, A. G. Anderson, and L. Bourdev, "Learned video compression," in *Proc. ICCV*, Oct. 2019.
- [26] Y.-H. Ho, C.-P. Chang, P.-Y. Chen, A. Gnutti, and W.-H. Peng, "Canfvc: Conditional augmented normalizing flows for video compression," in *Proc. ECCV*, 2022, pp. 207–223.
- [27] S. Kim, S. Yu, J. Lee, and J. Shin, "Scalable neural video representations with learnable positional features," in *Proc. NeuRIPS*, Dec. 2022.
- [28] G. K. Wallace, "The jpeg still picture compression standard," *IEEE Trans. Consum.*, vol. 38, no. 1, pp. xviii–xxxiv, Feb. 1992.
- [29] "High efficiency video coding," rec. ITU-T H.265 and ISO/IEC 23008-2, 2019, Int. Telecomm. Union-Telecomm. (ITU-T) and Int. Standards Org./Int/Electrotech. Comm. (ISO/IEC JTC 1).
- [30] N. Tishby and N. Zaslavsky, "Deep learning and the information bottleneck principle," in *Proc. ITW*, Apr. 2015.

- [31] Y. Matsubara, R. Yang, M. Levorato, and S. Mandt, "Supervised compression for resource-constrained edge computing systems," in *Proceedings WACV*, Jan. 2022, pp. 2685–2695.
- [32] C. E. Shannon, "A mathematical theory of communication," *The Bell system technical journal*, vol. 27, no. 3, pp. 379–423, July 1948.
- [33] T. M. Cover and J. A. Thomas, *Elements of Information Theory*, 2nd ed. Wiley, July 2006.
- [34] L. Davisson, "Rate distortion theory: A mathematical basis for data compression," *IEEE Transactions on Communications*, vol. 20, no. 6, pp. 1202–1202, Dec. 1972.
- [35] H. Choi and I. V. Bajić, "Deep feature compression for collaborative object detection," in *Proc. ICIP*, Oct. 2018.
- [36] P. Datta, N. Ahuja, V. S. Somayazulu, and O. Tickoo, "A low-complexity approach to rate-distortion optimized variable bit-rate compression for split dnn computing," in *Proc. ICPR*. IEEE, Aug. 2022, pp. 182–188.
- [37] H. Choi and I. V. Bajić, "Near-lossless deep feature compression for collaborative intelligence," in *Proc. IEEE MMSP*, Aug. 2018.
- [38] Y. Xu, S. Zhao, J. Song, R. Stewart, and S. Ermon, "A theory of usable information under computational constraints," in *Proc. ICLR*, Apr. 2020.
- [39] Y. Dubois, B. Bloem-Reddy, K. Ullrich, and C. J. Maddison, "Lossy compression for lossless prediction," *Proc. NeurIPS*, vol. 34, pp. 14 014–14 028, Dec. 2021.
- [40] S. R. Alvar and I. V. Bajić, "Pareto-optimal bit allocation for collaborative intelligence," *IEEE Trans. Image Process.*, vol. 30, pp. 3348–3361, Feb. 2021.
- [41] A. Harell, A. De Andrade, and I. V. Bajić, "Rate-distortion in image coding for machines," in *Proc. PCS*, Dec. 2022, pp. 199–203.
- [42] H. Choi and I. V. Bajić, "High efficiency compression for object detection," in *Proc. ICASSP*, Apr. 2018, pp. 1792–1796.
- [43] L. D. Chamain, F. Racapé, J. Bégaint, A. Pushparaja, and S. Feltman, "End-to-end optimized image compression for machines, a study," in *Proc. IEEE DCC*, Mar. 2021, pp. 163–172.
- [44] R. A. Cohen, H. Choi, and I. V. Bajić, "Lightweight compression of neural network feature tensors for collaborative intelligence," in *Proc. ICME*, Jul. 2020.
- [45] P. J. Rousseeuw, "Silhouettes: a graphical aid to the interpretation and validation of cluster analysis," *J. Comput. Appl. Math.*, vol. 20, pp. 53–65, Nov. 1987.
- [46] K. Simonyan and A. Zisserman, "Very deep convolutional networks for large-scale image recognition," *arXiv preprint:1409.1556*, Sep. 2014.
- [47] K. He, X. Zhang, S. Ren, and J. Sun, "Deep residual learning for image recognition," *Proc. CVPR*, pp. 770–778, June 2016.
- [48] A. Krizhevsky and G. Hinton, "Learning multiple layers of features from tiny images," *Computer Science Department, University of Toronto, Tech. Rep.*, vol. 4, Apr 2009.
- [49] L. Van der Maaten and G. Hinton, "Visualizing data using t-sne." *J. Mach. Learn. Res.*, vol. 9, no. 11, Nov. 2008.
- [50] G. Bjøntegaard, "Calculation of average PSNR differences between RD-curves," [Online]: https://www.itu.int/wftp3/av-arch/video-site/0104_{ }Aus/VCEG-M33.doc, Apr. 2001.
- [51] C. Hollmann, S. Liu, W. Gao, and X. Xu, "[VCM] On VCM reporting template," iSO/IEC JTC 1/SC 29/WG 2, m56185, Jan. 2021.
- [52] N. Ahuja, P. Datta, B. Kanzariya, V. S. Somayazulu, and O. Tickoo, "Neural rate estimator and unsupervised learning for efficient distributed image analytics in split-dnn models," in *Proc. CVPR*, June 2023, accepted for future publication.
- [53] A. G. Howard, M. Zhu, B. Chen, D. Kalenichenko, W. Wang, T. Weyand, M. Andreetto, and H. Adam, "Mobilenets: Efficient convolutional neural networks for mobile vision applications," *arXiv preprint:1704.04861*, Apr. 2017.
- [54] J. Ballé, D. Minnen, S. Singh, S. J. Hwang, and N. Johnston, "Variational image compression with a scale hyperprior," in *Proc. ICLR*, May 2018.
- [55] O. Russakovsky *et al.*, "ImageNet Large Scale Visual Recognition Challenge," *Int. J. Comput. Vision*, vol. 115, no. 3, pp. 211–252, Dec. 2015.
- [56] J. Ballé, V. Laparra, and E. P. Simoncelli, "Density modeling of images using a generalized normalization transformation," *arXiv preprint:1511.06281*, Nov. 2015.
- [57] "Challenge on learned image compression (CLIC)," [Online]: <http://www.compression.cc/>, accessed: 2020-10-26.
- [58] "JPEG AI dataset," [Online]: <https://jpeg.org/jpegai/dataset.html>, accessed: 2020-10-26.
- [59] T. Xue, B. Chen, J. Wu, D. Wei, and W. T. Freeman, "Video enhancement with task-oriented flow," *Int. J. Comput. Vis.*, vol. 127, no. 8, pp. 1106–1125, Feb. 2019.
- [60] Y. Wu, A. Kirillov, F. Massa, W.-Y. Lo, and R. Girshick, "Detectron2," <https://github.com/facebookresearch/detectron2>, 2019.
- [61] T.-Y. Lin, M. Maire, S. Belongie, J. Hays, P. Perona, D. Ramanan, P. Dollár, and C. L. Zitnick, "Microsoft COCO: Common objects in context," in *Proc. ECCV*, Sept. 2014.
- [62] "VVC reference software (VTM 12.3)," [Online]: https://vcgit.hhi.fraunhofer.de/jvet/VVCSoftware_{ }VTM/-/tags/VTM-12.3, [Accessed: 2021-12-10].
- [63] "HEVC reference software (HM 16.20)," [Online]: http://hevc.hhi.fraunhofer.de/svn/svn_{ }HEVCSoftware/tags/HM-16.20+SCM-8.8, accessed: 2019-12-12.
- [64] J. Bégaint, F. Racapé, S. Feltman, and A. Pushparaja, "CompressAI: a PyTorch library and evaluation platform for end-to-end compression research," *arXiv preprint:2011.03029*, Nov. 2020.
- [65] A. Bochkovskiy, "darknet," [Online]: <https://github.com/AlexeyAB/darknet/tree/8c80ba6>, accessed: 2020-09-23.
- [66] J. Redmon, "Darknet: Open source neural networks in C," [Online]: <https://pjreddie.com/darknet>, accessed: 2020-09-23.
- [67] T.-Y. Lin, P. Dollár, R. Girshick, K. He, B. Hariharan, and S. Belongie, "Feature pyramid networks for object detection," in *Proc. CVPR*, 2017, pp. 936–944.
- [68] D. P. Kingma and J. Ba, "Adam: A method for stochastic optimization," *arXiv preprint:1412.6980*, Dec. 2014.
- [69] A. Paszke, S. Gross, F. Massa, A. Lerer, J. Bradbury, G. Chanan, T. Killeen, Z. Lin, N. Gimelshein, L. Antiga, A. Desmaison, A. Kopf, E. Yang, Z. DeVito, M. Raison, A. Tejani, S. Chilamkurthy, B. Steiner, L. Fang, J. Bai, and S. Chintala, "Pytorch: An imperative style, high-performance deep learning library," in *Proc. Neurips*, vol. 32, Dec. 2019.
- [70] E. Linder-Norén, "Pytorch-YOLOv3: Minimal PyTorch implementation of YOLOv3," [Online]: <https://github.com/eriklindernoren/PyTorch-YOLOv3>, May 2018, accessed: 2020-10-30.
- [71] "Kodak lossless true color image suite (PhotoCD PCD0992)," [Online]: <http://r0k.us/graphics/kodak>, accessed: 2019-03-19.

SUPPLEMENT TO
Rate-Distortion Theory in Coding for Machines and its Applications

APPENDIX A
THEOREM PROOFS

Theorem 1. *The minimal achievable rates for direct coding for machines and model splitting are identical, that is,*

$$R_{XY}(D; T) = R_Y(D; T)$$

Proof. We begin by proving that $R_{XY}(D; T) \leq R_Y(D; T)$. Let $p^*(\tilde{y}|y) \in \mathcal{P}_{\tilde{Y}}(D; T)$ be a conditional distribution of \tilde{y} on y which achieves the rate-distortion function of the model splitting approach $R_Y(D; T)$. By definition, $y = g(x)$ for some x , so we can re-write $p^*(\tilde{y}|y) = p^*(\tilde{y}|g(x)) = q(\tilde{y}|x)$. We know that $q(\tilde{y}|x) \in \mathcal{Q}_{X\tilde{Y}}(D; T)$ because

$$\mathbb{E} \left[d_T \left(f(X), h(\tilde{Y}) \right) \right] = \mathbb{E} \left[d_T \left(h(Y), h(\tilde{Y}) \right) \right] \leq D.$$

The equality comes from $f = h \circ g$ and the definition of Y , and the inequality is true because $p^*(\tilde{y}|y) \in \mathcal{P}_{\tilde{Y}}(D; T)$. Next we note that $X \rightarrow Y \rightarrow \tilde{Y}$ is a Markov chain and thus we can apply the data processing inequality to learn that $I(X; \tilde{Y}) \leq I(Y; \tilde{Y}) = R_Y(D; T)$. However, because $R_{XY}(D; T)$ is the minimum of $I(X; \tilde{Y})$ for all $q(\tilde{y}|x) \in \mathcal{Q}_{X\tilde{Y}}(D; T)$ we know that $R_{XY}(D; T) \leq I(X; \tilde{Y}) \leq R_Y(D; T)$.

To finish our proof we show that $R_Y(D; T) \leq R_{XY}(D; T)$. Analogously to the first part of our proof, let $q^*(\tilde{y}|x) \in \mathcal{Q}_{X\tilde{Y}}(D; T)$ be a conditional distribution of \tilde{y} on x which achieves the rate-distortion function of direct coding for machines $R_{XY}(D; T)$. For a given observation of x we get an exact value of $y = g(x)$ by definition, which induces a distribution $q(y) = \sum_{x \in g^{-1}(y)} p(x)$ (here $g^{-1}(y) = \{x : y = g(x)\}$ is the set inverse of g , and $p(x)$ is the density of x). This, alongside $q^*(\tilde{y}|x)$ induces a conditional distribution $p(\tilde{y}|y)$. We know that $p(\tilde{y}|y) \in \mathcal{P}_{\tilde{Y}}(D; T)$ because:

$$\begin{aligned} \mathbb{E} \left[d_T \left(h(Y), h(\tilde{Y}) \right) \right] &= \sum_{y, \tilde{y}} p(\tilde{y}|y) q(y) d_T(y, \tilde{y}) \\ &\stackrel{(a)}{=} \sum_{x, y, \tilde{y}} d_T(y, \tilde{y}) q(y) q(\tilde{y}|x, y) p(x|y) \\ &\stackrel{(b)}{=} \sum_{x, y, \tilde{y}} d_T(y, \tilde{y}) q(y) q^*(\tilde{y}|x) p(y|x) \frac{p(x)}{q(y)} \\ &= \sum_{x, \tilde{y}} q^*(\tilde{y}|x) p(x) \sum_y d_T(y, \tilde{y}) p(y|x) \\ &\stackrel{(c)}{=} \sum_{x, \tilde{y}} q^*(\tilde{y}|x) p(x) d_T(g(x), \tilde{y}) \\ &= \mathbb{E} \left[d_T \left(f(X), h(\tilde{Y}) \right) \right] \leq D. \end{aligned} \tag{24}$$

(a) comes from the law of total probability; (b) includes Bayes' law alongside the fact that $q(\tilde{y}|x, y) = q^*(\tilde{y}|x)$ because y is completely determined by x ; (c) is simply a result of $p(y|x) = 1$ whenever $y = g(x)$ and zero otherwise. The final inequality is true because $q^*(\tilde{y}|x) \in \mathcal{Q}_{X\tilde{Y}}(D; T)$. Trivially, $X \rightarrow Y$ is a Markov chain and thus its inverse $\tilde{Y} \rightarrow X$ is also one. We can now add the processing step $Y = G(X)$ to get the Markov chain $\tilde{Y} \rightarrow X \rightarrow Y$. We apply the DPI to the last chain to get $I(\tilde{Y}; Y) \leq I(\tilde{Y}; X) = R_{XY}(D; T)$. Finally, once again we note that as the minimum over all distributions $p(\hat{y}|y) \in \mathcal{P}_Y(D_T)$, we have $R_Y(D; T) \leq I(\tilde{Y}; Y) \leq R_{XY}(D; T)$ concluding our proof. \square

Theorem 2. *Let $\mathcal{I}_f(\mathcal{X}) \subseteq \mathcal{T}$ to be the image of a task model on all possible inputs, and let $\hat{\mathcal{Y}} \subseteq \mathcal{Y}$ be the set of all possible approximations of Y . If $h(\hat{\mathcal{Y}}) \subseteq \mathcal{I}_f(\mathcal{X})$ then, for any given distortion $D > 0$, the minimal achievable rate for model splitting is equal to the minimal achievable rate for the classical approach:*

$$R_X(D; T) = R_Y(D; T)$$

Proof. From [17] we already know that $R_Y(D; T) \leq R_X(D; T)$, which means it is enough to show that $R_X(D; T) \leq R_Y(D; T)$ to show equality. Let $p^*(\hat{y}|y) \in \mathcal{P}_Y(D; T)$ be a distribution which achieves the corresponding rate-distortion $R_Y(D; T)$. Next, define the indirect inverse of g through h as: $g_h^{-1}(y) = f^{-1}(h(y))$, where $f^{-1}(t) = \{x : f(x) = t\}$ is the set inverse of f . We can now define an approximation of X as the median¹¹ of the indirect inverse of g through h applied to \hat{y} , that is $\hat{x} = \text{median}(g_h^{-1}(\hat{y}))$.

¹¹We use a convention for the median such that it is always a member of the set. Additionally, the choice of the median here is arbitrary, any member of the set $(f^{-1}(h(\hat{y})))$ is a suitable choice.

First, by the conditions of the theorem, we know that the set $g_h^{-1}(\hat{y})$ is not empty for any value of \hat{y} , and thus \hat{x} is well defined. Next, we note that the following is a Markov chain: $X \rightarrow Y \rightarrow \hat{Y} \rightarrow \hat{X}$. Applying the DPI, we see that $I(X; \hat{X}) \leq I(Y; \hat{Y}) = R_Y(D; T)$. The definition above (along with the Markov chain) induces a conditional distribution $p(\hat{x}|x)$, which satisfies $p(\hat{x}|x) \in \mathcal{P}_X(D; T)$ because:

$$\begin{aligned} \mathbb{E} \left[d_T \left(f(X), f(\hat{X}) \right) \right] &= \mathbb{E} \left[d_T \left(h(g(X)), f \left(g_h^{-1}(\hat{Y}) \right) \right) \right] \\ &= \mathbb{E} \left[d_T \left(h(Y), h(\hat{Y}) \right) \right] \leq D \end{aligned} \quad (25)$$

Where the last inequality is because $p^*(\hat{y}|y) \in \mathcal{P}_Y(D; T)$. Finally, because because of its definition as the minimum over all approximations in $\mathcal{P}_X(D; T)$ we know that $R_X(D; T) \leq I(\hat{X}; X) \leq R_Y(D; T)$ concluding the proof. \square

Theorem 2.A. *Let $\hat{y} : h(\hat{y}) \notin \mathcal{I}_f(\mathcal{X})$ be an approximation of a specific value of y for which the output of the task backend is not contained in the image of the original task model. If for any such \hat{y} there exists an alternative approximation, \tilde{y} such that $h(\tilde{y}) \in \mathcal{I}_f(\mathcal{X})$ and $d_T(h(y), h(\tilde{y})) \leq d_T(h(y), h(\hat{y}))$ then Equation (9) still holds.*

Proof. First, define the restriction of \mathcal{Y} to values for which the output of the task backend is in the image of the task model, $\tilde{\mathcal{Y}} = \{y \in \mathcal{Y} : h(y) \in \mathcal{I}_f(\mathcal{X})\}$. Any approximation for which the output of the task backend is not in the image of the original task model satisfies $\hat{y} \in \mathcal{Y} \setminus \tilde{\mathcal{Y}}$. Next, denote $\tilde{y}(\hat{y}) \in \tilde{\mathcal{Y}}$ to be the alternative approximation corresponding a specific value of \hat{y} . Now we can define the following mapping $\tilde{g} : \mathcal{Y} \rightarrow \tilde{\mathcal{Y}}$ so that:

$$\tilde{Y} = \tilde{g}(\hat{y}) = \begin{cases} \tilde{y}(\hat{y}) & , \hat{y} \notin \tilde{\mathcal{Y}} \\ \hat{y} & , \text{otherwise} \end{cases}$$

By the conditions of this corollary such a mapping exists, and the following is a Markov chain: $Y \rightarrow \hat{Y} \rightarrow \tilde{Y}$. Applying the DPI we see that $I(Y; \tilde{Y}) \leq I(Y; \hat{Y})$, and because every point in \tilde{Y} achieves no worse distortion than its equivalent in \hat{Y} , we also know $\mathbb{E} \left[d_T(h(Y), h(\tilde{Y})) \right] \leq \mathbb{E} \left[d_T(h(Y), h(\hat{Y})) \right]$. Thus, for any value of $D > 0$, if $p(\hat{y}|y)$ achieves $R_Y(D; T)$ then so does $p(\tilde{y}|y)$. Finally, since $\tilde{Y} \subseteq \tilde{\mathcal{Y}}$, for any $D > 0$ there exists a distribution which achieves the rate-distortion function $R_Y(D; T)$ while still meeting the conditions of the proof of Theorem 2. \square

Theorem 3. *For some input distortion, $D_X > 0$, and the corresponding lowest possible task distortion achievable by an X -optimal approximation, $D_T^{min} = \min D_T^*(D_X; X)$, the minimal achievable rate of the supervised approach is upper bound by the input rate-distortion (for the corresponding distortion values). Formally:*

$$R_X(D_T^{min}; T) \leq R_X(D_X; X)$$

Proof. Let $p^*(\tilde{x}|x) \in \mathcal{R}_X(D_X; X)$ be the best possible X -optimal distribution in terms of task distortion, meaning $\mathbb{E} \left[d_T \left(f(X), f(\tilde{X}) \right) \right] = D_T^{min}$. By definition this means that $p^*(\tilde{x}|x) \in \mathcal{P}_X(D_T^{min}; T)$, and recall that because $p^*(\tilde{x}|x) \in \mathcal{R}_X(D_X; X)$, we know that $I(X; \tilde{X}) = R_X(D_X; X)$. Finally, also by definition:

$$R_X(D_T^{min}; T) = \min_{p(\hat{x}|x) \in \mathcal{P}_X(D_T^{min}; T)} I(X; \hat{X}),$$

which gives us $R_X(D_T^{min}; T) \leq I(X; \tilde{X}) = R_X(D_X; X)$, concluding the proof. \square

Theorem 4. *Begin with a set of X -optimal distributions $\mathcal{R}_X(D_X; X)$, and a corresponding lowest possible task distortion, $D_T^{min} = \min \mathcal{D}_T^*(D_X; X)$. If, for any $p(\hat{x}|x) \in \mathcal{R}_X(D_X; X)$ there exist two points $\hat{x}_1 \neq \hat{x}_2$ with non-zero probabilities, $p(\hat{x}_1), p(\hat{x}_2) \neq 0$, for which the task output is identical¹², $f(\hat{x}_1) = f(\hat{x}_2)$, and at least one input x for which $p(x|\hat{x} = \hat{x}_1) \neq p(x|\hat{x} = \hat{x}_2)$, then the minimal achievable rate of the supervised approach is strictly lower than the input rate-distortion (for the corresponding distortion values):*

$$R_X(D_T^{min}; T) < R_X(D_X; X).$$

Proof. Let $p^*(\hat{x}|x) \in \mathcal{R}_X(D; X)$ be the best possible X -optimal distribution in terms of task distortion, meaning $\mathbb{E} \left[d_T \left(f(X), f(\hat{X}) \right) \right] = D_T^{min}$. Next, consider \tilde{X} which is defined by applying the following transformation to \hat{X} :

$$\tilde{X} = \begin{cases} \hat{X} & , \hat{X} \neq \hat{x}_2 \\ \hat{x}_1 & , \hat{X} = \hat{x}_2 \end{cases}$$

¹²In fact this only has to hold for $p(\hat{x}|x) \in \mathcal{R}_X(D_X; X)$, which also satisfy $\mathbb{E} \left[d_T \left(f(X), f(\hat{X}) \right) \right] = D_T^{min}$

First, note that the task-distortion for \tilde{X} is unchanged because $f(\tilde{X}) = f(\hat{X})$, which means $p(\tilde{x}|x) \in \mathcal{P}_X(D_T^{min}; T)$. Next note the minimum rate needed to encode \tilde{X} , equal to $I(X; \tilde{X})$ is strictly lower than the equivalent for \hat{X} :

$$\begin{aligned}
I(X; \hat{X}) - I(X; \tilde{X}) &\stackrel{(a)}{=} H(X|\tilde{X}) - H(X|\hat{X}) \\
&\stackrel{(b)}{=} \sum_x \sum_{\hat{x}} p(x, \hat{x}) \log(p(x|\hat{x})) - \sum_x \sum_{\tilde{x}} p(x, \tilde{x}) \log(p(x|\tilde{x})) \\
&\stackrel{(c)}{=} \sum_x \left[p(x, \hat{x} = \hat{x}_1) \log\left(\frac{p(x, \hat{x} = \hat{x}_1)}{p(\hat{x} = \hat{x}_1)}\right) + p(x, \hat{x} = \hat{x}_2) \log\frac{p(x, \hat{x} = \hat{x}_2)}{p(\hat{x} = \hat{x}_2)} \right] - \\
&\quad \sum_x \left[(p(x, \hat{x} = \hat{x}_1) + p(x, \hat{x} = \hat{x}_2)) \log\left(\frac{p(x, \hat{x} = \hat{x}_1) + p(x, \hat{x} = \hat{x}_2)}{p(\hat{x} = \hat{x}_1) + p(\hat{x} = \hat{x}_2)}\right) \right] \\
&\stackrel{(d)}{>} 0,
\end{aligned} \tag{26}$$

where (a) is a result of $I(U; V) = H(U) - H(U|V)$, and (b) is simply the definition of conditional entropy. The step (c) involves a few parts: first, we use the definition of conditional probability $p(u|v) = \frac{p(u,v)}{p(v)}$; next we note that for any $x^* \notin \{\hat{x}_1, \hat{x}_2\}$ we have $p(x, \hat{x} = x^*) = p(x, \tilde{x} = x^*)$ as well as $p(x|\hat{x} = x^*) = p(x|\tilde{x} = x^*)$; and finally, we know that $p(x, \tilde{x} = \hat{x}_1) = p(x, \hat{x} = \hat{x}_1) + p(x, \hat{x} = \hat{x}_2)$, which also means that $p(\tilde{x} = \hat{x}_1) = p(\hat{x} = \hat{x}_1) + p(\hat{x} = \hat{x}_2)$. Step (d) is true because of the *log-sum inequality* - Theorem 2.7.1 in [33], where the condition that there exists at least one input x for which $p(x|\hat{x} = x_1) \neq p(x|\hat{x} = x_2)$, makes the log-sum inequality strict. Finally, recall that $R_X(D_T^{min}; T)$ is the minimum of mutual information over all potential approximations of X in $\mathcal{P}_X(D_T^{min}; T)$ and thus specifically is no greater than $I(X; \tilde{X})$ giving us: $R_X(D_T^{min}; T) \leq I(X; \tilde{X}) < I(X; \hat{X}) = R_X(D; X)$ concluding our proof. \square

APPENDIX B MODEL ARCHITECTURES AND CONFIGURATIONS

The following appendix contains more detailed description of the model architectures used in our experiments, including the task models. Of course, since these task-models are taken from previously published work, we limit the presentation here to an overview, and the reader to explore the original publication for any additional detail.

A. Model splitting

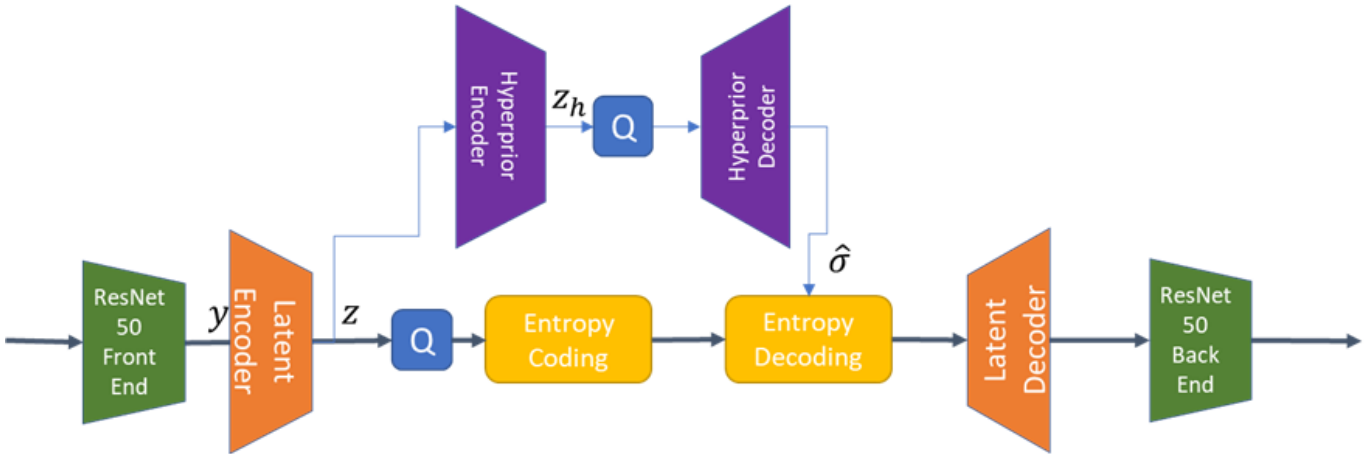

Fig. 12: Overall block diagram of our model splitting approach showing the latent encoder and decoder and the hyperprior network.

Training of the compression unit: We follow the approach of Datta *et al.* [36] for the design and training of the latent encoder and decoder. The procedure involves exploring a joint space of hyperparameters related to the architecture of the latent encoder, and those related to compression and encoding (recall that the latent decoder is the mirror image of the latent encoder and hence shares the same architectural hyperparameters). The architectural hyper-parameters we tune for are the number of channels C_r at the output of the latent encoder and the stride S of the convolutional kernels used therein. The compression hyper-parameters include the Lagrange multiplier λ in Eq. (1), and the quantization step size, Q , used to discretize the output of the latent encoder.

As we did in our previous work [36], [52] We perform the hyperparameter search as follows: first, a random sample is generated from the joint hyperparameter space which fixes the topology of the latent encoder (and decoder) and the compression related parameters. A training run is then performed to train the compression unit and the resultant classification accuracy

is measured along with the average bit-rate (measured, as explained earlier in bits-per-pixel). This process is then repeated multiple times – each time with a different sample from the joint hyperparameter space – to generate sufficient number of such candidates. From this set, Pareto optimal set of points are determined. The points lying on the Pareto frontier correspond to the set of trained bottleneck layers that yield the optimal accuracy vs compression performance.

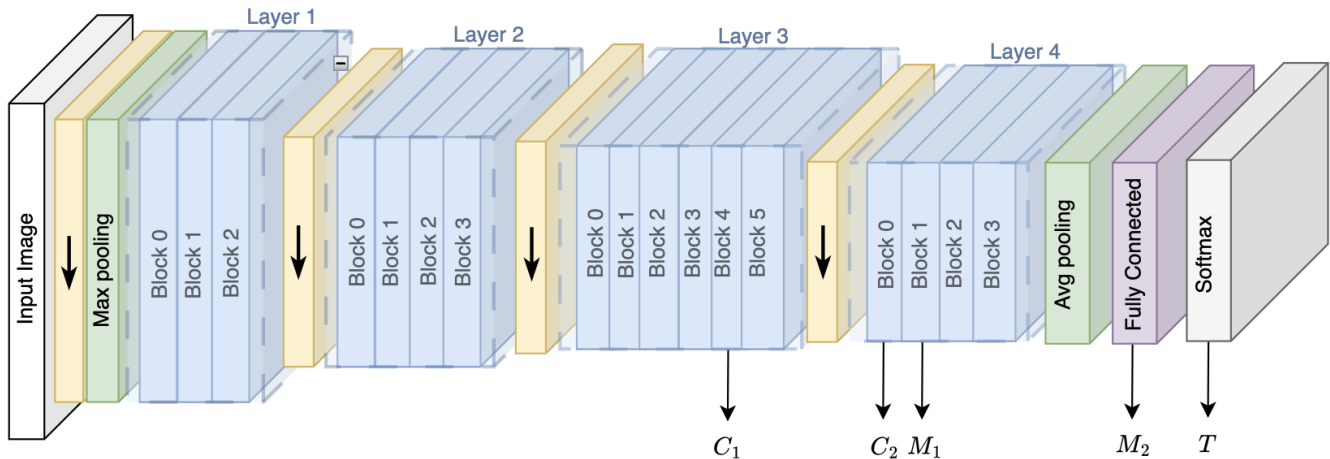

Fig. 13: ResNet50 architecture. The potential cut and distillation (middle) points are indicated with C_i 's and M_i 's respectively. The blocks marked with a \downarrow represent down-sampling blocks, which are implemented with strided convolutions. Each block is comprised of several convolutional layers with residual connections, not pictured here.

B. ResNet50

For the classification task using a model-splitting approach, we use the standard ResNet50 architecture [47] that has been trained on the ImageNet dataset. The main body of the ResNet50 network comprises four units (Layer1 to Layer4), each comprising multiple residual blocks as shown in Fig. 13 (refer [47] for additional details). The two cut-points C_1, C_2 , and distillation points M_1, M_2 which are used in our evaluation are at the outputs of various blocks as shown in the figure. Importantly, when training in a supervised manner, the ground truth labels T , are used, and not the model output (though T is shown in Fig. 13 at the output for simplicity).

C. Direct Coding For Machines Model

In all 3 direct coding for machines we use the following learnable compression model, based on the "base-layer" of the scalable codec in [17], which in turn is largely based on [21], shown in Fig. 14. On the encoder side, we begin by creating a latent representation Z using a synthesis transform g_a , which is comprised of downsampling blocks as well as convolutional layers, all with a fixed amount of channels (192 in [17]), and generalized divisive normalization (GDN) activations [56]. We use a slightly modified g_a because although we need a relatively smaller of channels for Z than 192, we found reducing the number of channels immediately leads to inferior performance. Instead, we keep the width of synthesis transform layers at 192, reducing dimensionality at the final layer to our desired size, which depends on the task-model and thus detailed in the following sections.

In the next step, we model the elements of the latent representation Z as conditionally independent Gaussian similarly to [19], [20], conditioned on their mean and scale, which are calculated as follows. The latent representation Z is input into a second analysis transform h_a , known as the hyperprior model to produce the side information Z_h . This side information is then quantized and encoded using an entropy bottleneck [30] followed by an arithmetic encoder, producing the side bitstream. The quantized side information is then used to produce estimates for mean and scale of each element in the quantized latent representation Z . In parallel to the side information, a second estimate of the mean and scale is produced by the autoregressive context model of [19]. The two representations are then merged using the entropy parameter (EP) estimation block, before being used in an arithmetic encoder to produce the main bitstream.

After decoding the resulting bitstreams, the reconstructed side information \hat{Z}_h is used alongside previously decoded elements of \hat{Z} to recreate the necessary means and scaled to support the arithmetic decoding of \hat{Z} . The recreated latent representation is then processed by a latent decoder, referred to as the latent space transform (LST) in [17], comprised of residual blocks and inverse GDN activations, as well as upsampling blocks. The output of the latent decoder is used as our recreated cut point, \hat{Y}_1 which can then be fed to the mid-model to obtain the distillation point \hat{Y}_2 during training, or to the full task backend during inference. Importantly, when training our codec, we replace all quantization with uniform random noise of magnitude 1, as is commonly done for learned compression.

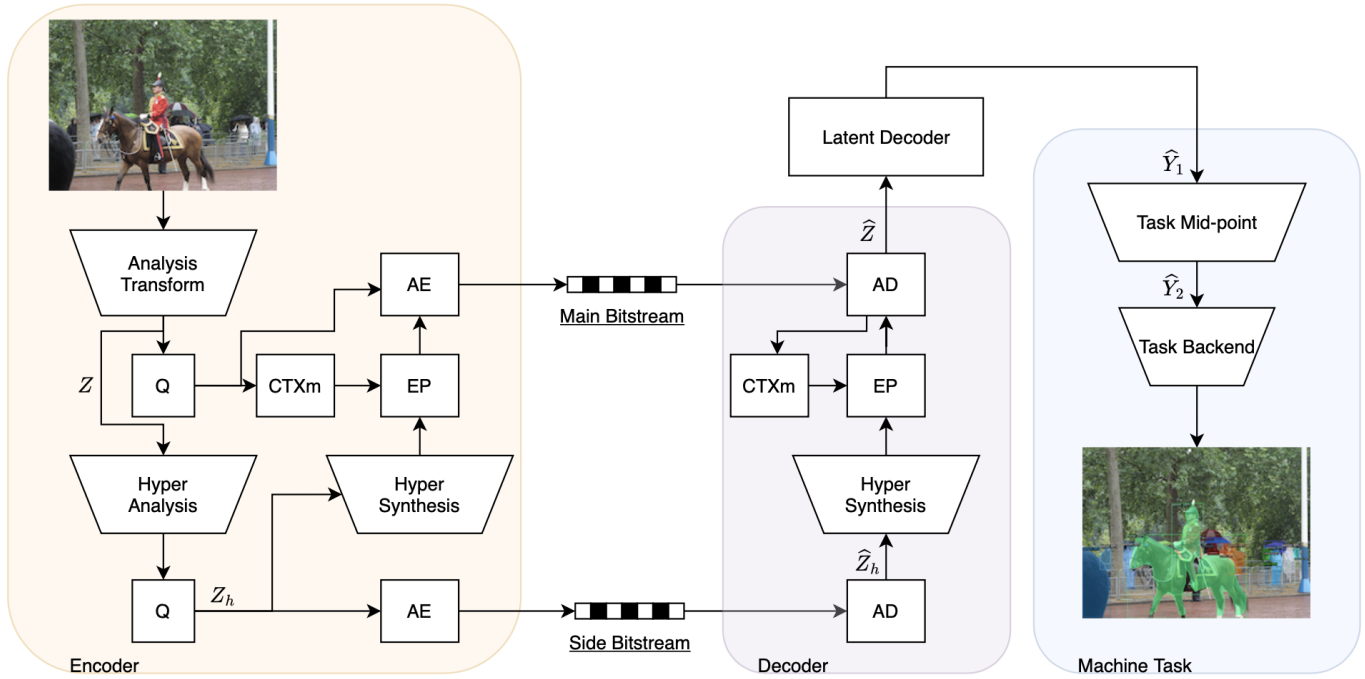

Fig. 14: Architecture of our codec model for direct coding for machines. CTX and EP denote the context model and entropy parameters, respectively. AE/AD stands for arithmetic encoder/decoder.

D. Faster R-CNN & Mask R-CNN

Faster R-CNN is a region-based convolutional neural network that identifies objects within an image, providing their corresponding bounding boxes, class labels. The architecture of Faster R-CNN comprises a backbone that generates feature maps used by a region proposal network to create region proposals. These proposals and feature maps are then passed through a Region of Interest (RoI) pooling layer to predict bounding boxes and class labels, as shown in Figure 15. Mask R-CNN is an extension of Faster R-CNN that benefits from an additional branch comprising a Fully Convolutional Network, which is used to predict segmentation masks on the RoIs.

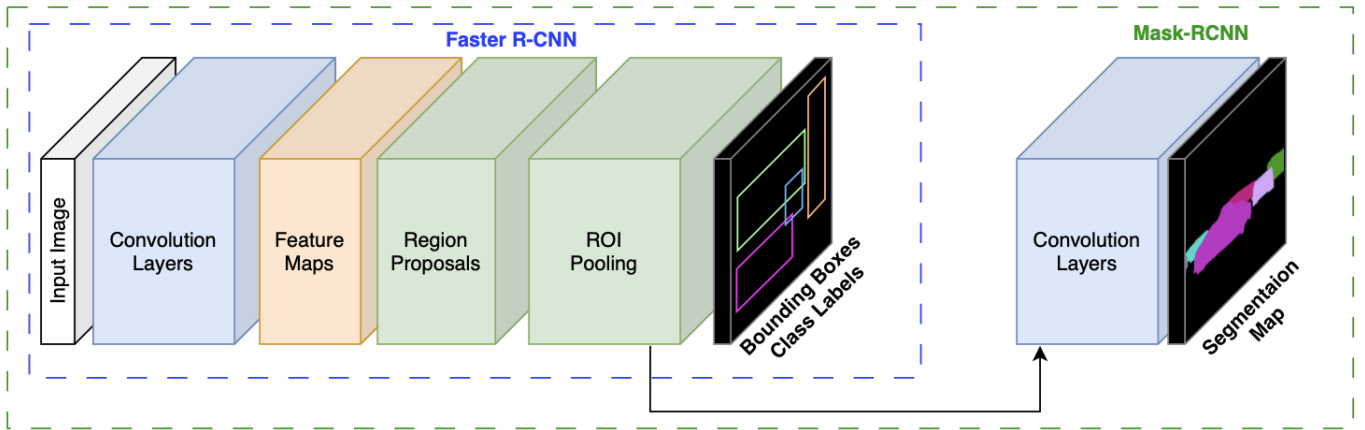

Fig. 15: Faster R-CNN [2] and Mask R-CNN [4] architectures. Mask R-CNN extends Faster R-CNN with an additional branch for generating the segmentation map.

As seen in Figure 15, both Faster R-CNN and Mask R-CNN networks share the same backbone architecture, for example utilizing from ResNet50 and FPN. ResNet50 is composed of residual blocks and down-sampling blocks, while the Feature Pyramid Network (FPN) includes convolutional layers and up-sampling blocks to generate multi-scale feature maps, (see Figure 16).

As the first cut and distillation point C_1 , we select the output of “Stem” or the input of the residual block 2. For the next cut and distillation point, C_2 , we choose the output of the same residual block, referred to as “Layer 4”, which is also an input to the FPN. Finally, we select the outputs of “P2-P6” as the last distillation point, C_3 , although it should be noted that since this includes five tensors, so for simplicity, we only utilize it as a distillation point.

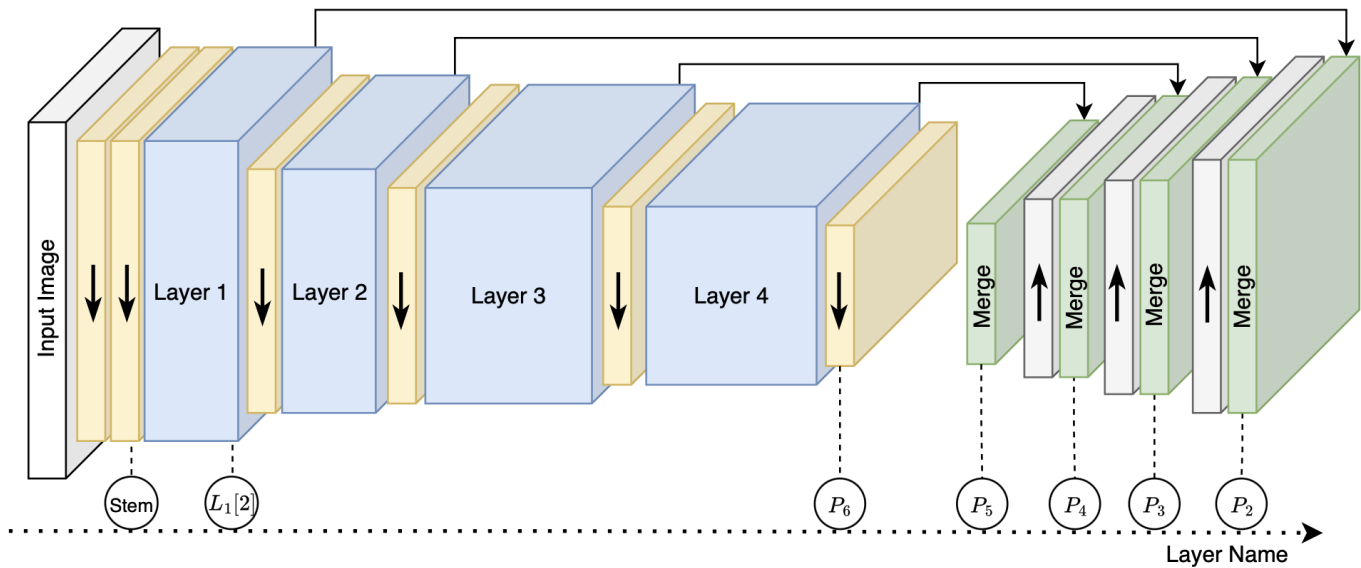

Fig. 16: Faster and Mask R-CNN backbone using ResNet50 [47] and FPN [67]. The potential cut and distillation points are indicated by circles. The blocks marked with a \downarrow and \uparrow represent down-sampling and up-sampling blocks, respectively.

Thus in our various configurations for both object detection with Faster R-CNN and instance segmentation with Mask R-CNN, models are split from the cut points, while the distortion is calculated based on the distillation points, and Equation (22) is used whenever using M_3 for distillation. For instance, in one experiment, we split the Faster R-CNN model from Stem, and the distortion is then calculated based on the MSE between pre-trained and estimated values of the Layer 4 tensor.

Training is performed in two stages, in an unsupervised manner (without the object detection labels) using the loss from Equation (1). In the first stage we use randomly cropped image patches of size 256×256 from a combination of the CLIC [57] and JPEG-AI [58] datasets. In the second stage we use the same size patches taken from the VIMEO-90K [59] dataset. In both stages we use a batch size of 16, and the ADAM [68] optimizer. In the first stage of training, we use a fixed learning rate of 10^{-4} , while in the second stage we employ a polynomial decay for the learning rate after every 10 epochs. The number of channels in the latent representation Z used by the compression model differs slightly between the two models, with Faster R-CNN and Mask R-requiring 96 and 128 channels, respectively. For exact values of these and other hyper-parameters see Table IV.

TABLE IV: Hyper parameter values for direct compression models

Task model	λ						Z Channels	First stage epochs	Second stage epochs
Faster R-CNN	$1.28e-5$	$3.2e-5$	$8e-5$	$2e-4$	$4e-4$	$5.5e-4$	96	400	500
Mask R-CNN	$1.28e-5$	$3.2e-5$	$8e-5$	$2e-4$	$4e-4$	$5.5e-4$	128	400	500
YOLOv3 $C_5 \rightarrow O$	$1e-5$	$2.5e-5$	$5e-5$	$1e-4$	$2e-4$	$4e-4$	64	300	350
YOLOv3 - Others	$2.5e-5$	$5e-5$	$1e-4$	$2e-4$	$4e-4$	$1e-3$	64	300	350

E. YOLOv3

YOLOv3 is a popular model of object detection as it combines high accuracy with efficient computation. Its architecture is comprised of residual blocks, downsampling and upsampling blocks, as well as detection blocks, which we refer to as YOLO blocks. Residual blocks are comprised of multiple sub-blocks of convolutions followed by skip connection and additions. The width of residual blocks in the Fig. 17 correlates roughly to the amount of convolutional layers, though it is not to scale. YOLO blocks, shown in purple in Fig. 17 are comprised of more convolutional blocks followed by detection layers and each output a 3-D tensor containing a bounding box, an objectness score (an estimate of the likelihood that the box contains any object), and probability estimates for each of the target classes. The final output of YOLOv3 is comprised of three such detection outputs, which we denote O_1, O_2, O_3 , as seen in Fig. 17.

As detailed in [1], and explained in section IV, YOLOv3 is a multi-scale, multi-stream model. This means that output of certain layers is used as input in multiple downstream computational branches, without being subsequently merged by some addition or concatenation. We refer to such tensors, which are used by downstream layers as branching points, and they are denoted with numbered circles in Fig. 17, corresponding to their PyTorch [69] implementation [70]. In practice, the multi-stream nature of YOLOv3 means that whenever choosing a distillation point for YOLOv3 that is deeper than layer 13

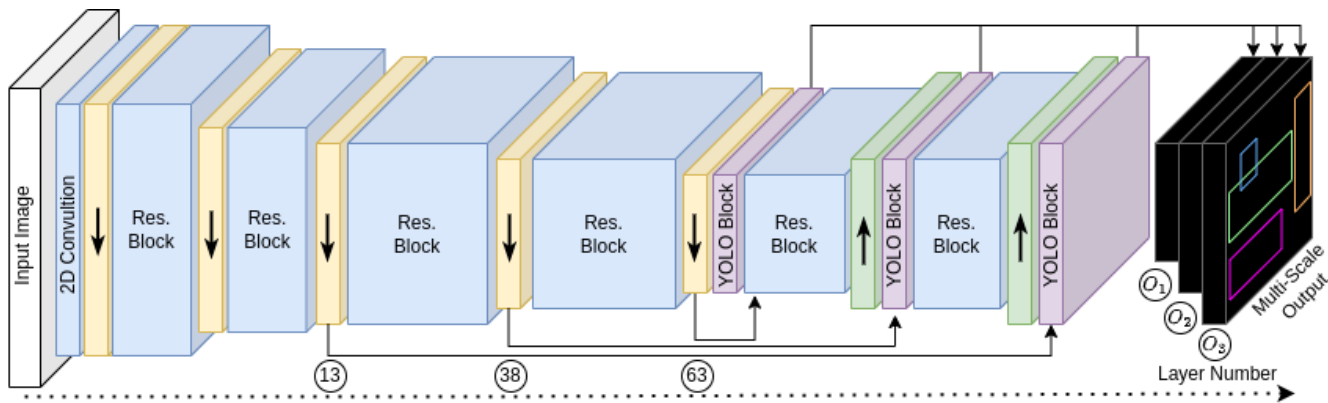

Fig. 17: YOLOv3 [1] architecture. The potential distillation points are marked with numbered circles. Blocks marked with a \downarrow and \uparrow are downsampling and upsampling blocks.

(the earliest branching point), we need to also include the branching point itself, or at least one tensor from each downstream branch.

In all experiments we use layer 13 as the cut point, with distillation points taken as deep as possible from each branch leading to the following choice of tensors layers: L_{13} , L_{38} , L_{63} , O_1 , O_2 and O_3 . As explained above, we must keep earlier branching point as part of distillation point whenever going deeper, which gives the following final distillation points (labeled to distinguish from points used in previous models): $C_5 = \{L_{13}\}$, $M_4 = \{L_{13}, L_{38}\}$, $M_5 = \{L_{13}, L_{38}, L_{63}\}$, $O = \{O_1, O_2, O_3\}$. In order to calculate a scalar loss value, we choose to flatten and concatenate the relevant tensors before simply using an element-wise MSE loss, which is equivalent to the calculation shown in Equation (23). Training is performed identically to the R-CNN experiments other than the difference in hyperparameters which is summarized in Table IV above.

APPENDIX C ADDITIONAL EXPERIMENTAL RESULTS

A. Scalable Coding for Humans and Machines

In order to showcase the advantages of deeper distillation points more directly, we explore their effects in a scalable setting identical to that presented in [17]. Because our compression now performs optimization for both human vision and machine analysis the loss terms must change slightly:

$$L = R + \lambda \cdot (D_{enh} + w \cdot D_{base}). \quad (27)$$

Here, $D_{enh} = MSE(X, \hat{X})$ is the distortion for the input reconstruction task, while D_{base} is a distillation loss identical to Equation (23). λ determines the balance between rate and distortion as before, and w controls the balance between machine analysis and human vision tasks.

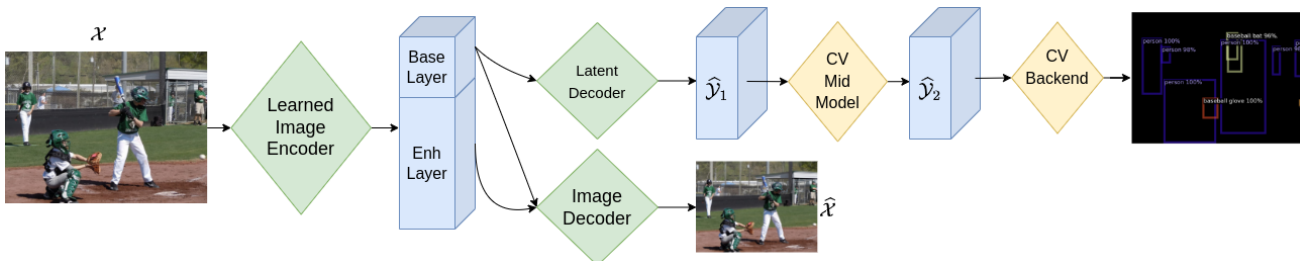

Fig. 18: Block diagram of the scalable setting. Note that in [17], the mid model is not used and the cut and distillation points are identical.

Training here follows the same procedure as our direct compression models, though we use a subset of approximately 30% of the VIMEO-90K dataset in our second stage of training due to the larger size of models to be trained. We use the same cut and distillation points as in our direct-compression experiment with YOLOv3. In order to maintain a fair comparison, we also retrain the models of Choi *et al.* using an identical procedure. Furthermore, because changing the distillation point may produce a similar effect to changing the balance between the base and enhancement task, we train two instances of the Choi22 benchmark with $w = 0.06, 0.12$.

Evaluation in for the base task is performed identically to Section IV-B3. For the enhancement task however, we use PSNR as our evaluation metric, and use the Kodak [71] dataset which consists of 24 high quality uncompressed images. To summarise rate-distortion performance we once again use the BD metrics, using Choi2022 with $w = 0.06$ as the anchor for BD-rate and

BD-mAP for the machine task. While human vision is not the focus of our work, we include the results for input reconstruction to allow a more comprehensive analysis. Here too we use BD-rate, and BD-PSNR (since that is our accuracy metric) with VVC used as the anchor. We compare our models with the same benchmarks as before, with the important exception that we now have two versions of Choi22.

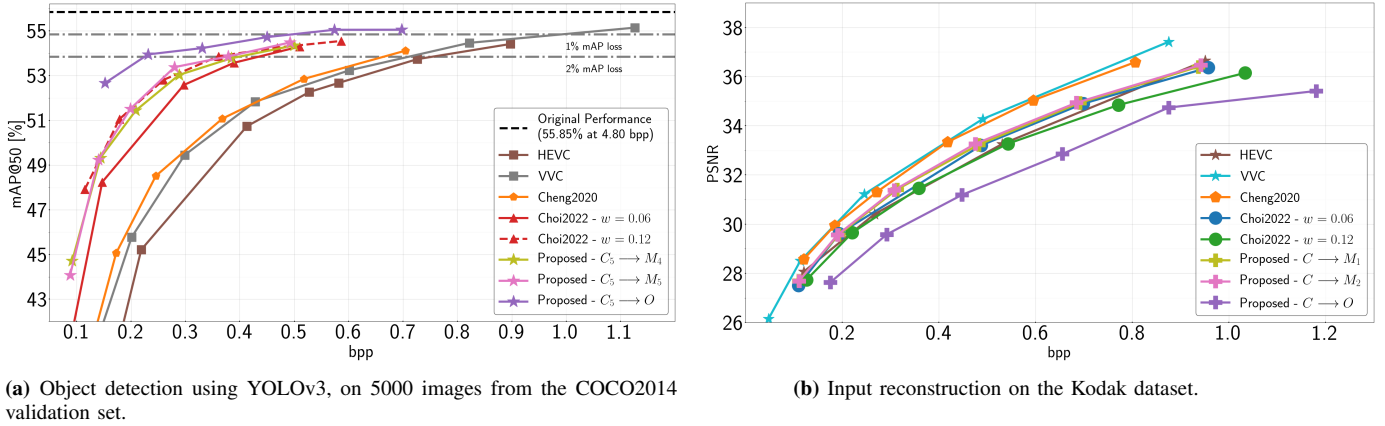

Fig. 19: Benchmark comparison for the scalable codec

TABLE V: Rate-Distortion Performance for the Scalable Compression scenario

Model	YOLOv3		Input Reconstruction	
	BD-Rate[%]	BD-mAP[%]	BD-Rate[%]	BD-PSNR[dB]
$C \rightarrow M_1$	-12.11	0.92	23.4	-0.88
$C \rightarrow M_2$	-13.87	1.16	21.9	-0.83
$C \rightarrow O$	-50.44	1.94	83.5	-2.56
Choi2022 $w = 0.06$	0	0	24.9	-0.92
Choi2022 $w = 0.12$	-13.89	0.96	39.1	-1.37
VVC	66.4	-3.90	0	0
HEVC	89.3	-5.86	29.8	-1.04
Cheng	54.5	-3.47	5.28	-0.22

Observing the results for the object-detection task, shown in Fig. 19a and Table V, we see once more that the use of the deepest distillation point O has resulted in the best RD performance, achieving a Bd-rate improvement of over 50% over previous SOTA. Interestingly, the effect of using distillation points M_1, M_2 was nearly identical, with very small difference between the two in terms of BD-mAP. Furthermore, we notice that putting a stronger emphasis on the task in the model of [17] using $w = 0.12$, gives comparable RD performance to using distillation points M_1, M_2 . Thus, in order to observe the benefits of the deeper distillation point we can turn to the enhancement task, seen in Fig. 19b, as well as Table V. There, we see that our proposed models, using deeper distillation points, achieve better reconstruction RD performance for identical object detection RD (or vice-versa). For example, our model using C_2 achieves approximately 13% BD-rate savings for input reconstruction when compared directly with the model from [17] trained with $w = 0.12$. Conversely, our model using M_2 achieves slightly better input reconstruction RD compared to [17] trained with $w = 0.06$, while achieving 12% BD-rate improvement in object detection RD.

B. Additional Task-Appropriateness Visualization

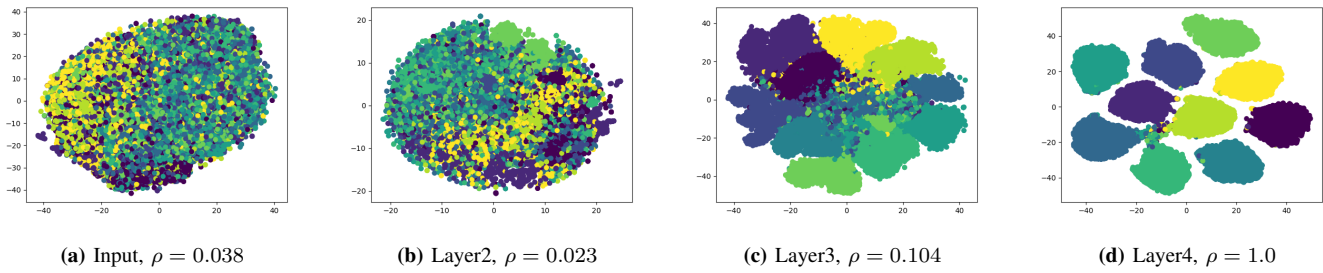

Fig. 20: Task appropriateness and t-SNE visualization for various layers in ResNet50, using the CIFAR-10 dataset and MSE distortion.

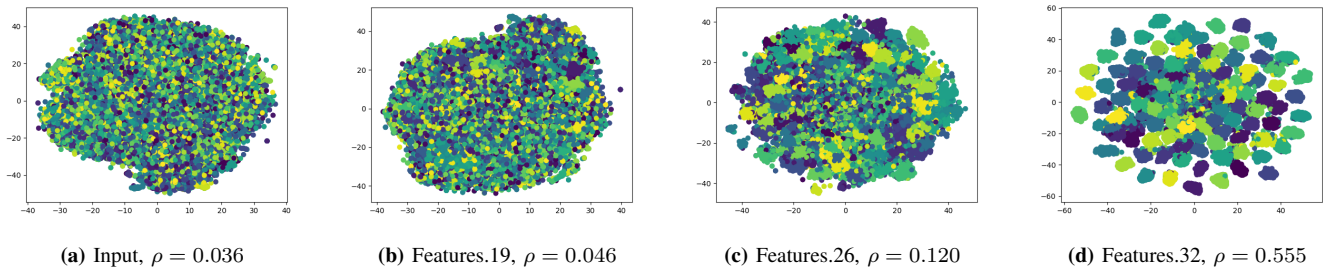

Fig. 21: Task appropriateness and t-SNE visualization for various layers in VGG16, using the CIFAR-100 dataset and MSE distortion.

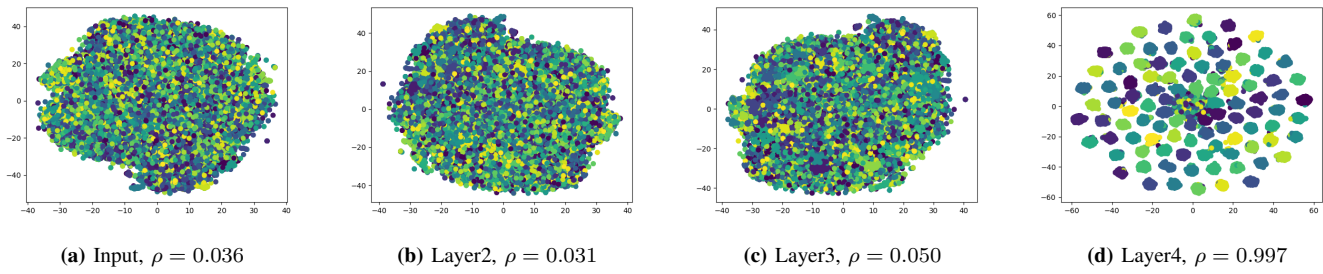

Fig. 22: Task appropriateness and t-SNE visualization for various layers in ResNet50, using the CIFAR-100 dataset and MSE distortion.