

# Resilient distributed integral control for multimachine power systems with inherent input constraint satisfaction

Theodoros E. Kavvathas, George C. Konstantopoulos, and Charalambos Konstantinou

**Abstract**—In this paper, a novel distributed controller for multimachine power systems is proposed to guarantee grid frequency restoration and accurate real and reactive power sharing among the generator units, while maintaining the generator inputs (mechanical torque and field excitation voltage) within given bounds. The boundedness of the controller outputs (generator inputs) is rigorously proven using vector field theory. It is additionally shown that even if one generator input reaches its upper/lower limit, the remaining units can still accomplish the desired control tasks without modifying the controller structure or dynamics; hence introducing enhanced system resilience using the proposed approach. This has been accomplished in a unified control structure while using neighbour-to-neighbour communication, thus maintaining the distributed nature of the controller. An example of a 10-bus, 4-machine power system is simulated to verify the proposed controller performance under sudden changes of the load demand.

## I. INTRODUCTION

Modern electricity networks integrate monitoring, control, and communication technologies into the physical infrastructure (power network, i.e., energy resources, loads, transmission/distribution lines, etc.); thus forming a cyber-physical architecture [1]–[3]. The bidirectional flow of power and information among the energy resources (conventional generators, distributed energy resources - DERs, flexible/responsive loads) introduces advanced control and optimisation properties for the power system that can be utilised in a centralised, decentralized, or distributed manner [4].

Although the integration of DERs (renewable energy systems, energy storage systems, intelligent loads) continuously increases driven by efforts of grid decarbonisation strategies in different regions of the world, at the transmission level, conventional synchronous generators still play a key role in maintaining system stability (frequency and voltage regulation) [5], [6]. Hence, a multimachine power network should be suitably coordinated to ensure restoration of the system frequency at the rated value and optimal load flow, which is often achieved by proportionally sharing real and reactive power among the generators [4], [7].

Since centralised coordination of multiple synchronous generators becomes more and more vulnerable to cyber

attacks [8], distributed control design based on neighbour-to-neighbour communication has been widely established as a suitable alternative [9]. In such frameworks, the design of resilient networked control has been extensively studied under scenarios of loss of communication, package drop, and time varying delays [9]–[12]. Additional scenarios that can lead the entire multimachine power system to instability include sudden changes of the load demand [13], sensor/actuator faults [14], or setpoint attacks [15]. Although several resilient controllers have been introduced in literature, in the majority of the cases, the physical/technical/operational constraints of the synchronous generators, e.g., actuator limits (mechanical torque or field excitation voltage limits), are not taken into consideration. These constraints can be handled by typical saturation units, but as it has been shown in [16], [17], conventional distributed integral control with saturation units at the mechanical torque input of each generator can lead to instabilities. Hence, according to the authors' knowledge, a resilient distributed control approach that takes into consideration all of the input constraints of each generator and continues to regulate the frequency at its nominal value and maintains the power sharing, even when at least one of the generator is forced to reach its operating limits, has not been developed yet.

In this paper, a novel distributed control design for multimachine power networks is proposed that has a unique and unified structure under both normal operation and under scenarios that cause some of the generators to operate at their limits (e.g., sudden change of load demand). Using vector field analysis, it is analytically proven that the proposed distributed controller maintains the controller outputs (generator mechanical torque and field excitation voltage inputs) within a given range. At the same time, the controller ensures grid frequency restoration to the rated value and accurate real and reactive power sharing among the generator units based only on neighbour-to-neighbour communication. This unique control scheme is resilient in the sense that the desired tasks (frequency restoration and power sharing) are still accomplished among the generators which operate within their bounded range, even if one or more of the generators force their inputs to the upper or lower limit. As demonstrated in this work, the controller does not need to modify its structure to accomplish it; hence offering a unified solution under normal and abnormal conditions. The effectiveness of the proposed control is verified using a 10-bus, 4-machine power network under sudden changes of the load demand real and reactive power.

The paper is structured as follows: In Section II, the dy-

This work was supported under Grant 81359 from the Research Committee of the University of Patras via "C.CARATHEODORY" program. T. E. Kavvathas and G. C. Konstantopoulos are with the Department of Electrical and Computer Engineering, University of Patras, Rion 26504, Greece. C. Konstantinou is with the CEMSE Division, King Abdullah University of Science and Technology (KAUST), Thuwal 23955-6900, Saudi Arabia. Emails: up1066602@upnet.gr, g.konstantopoulos@ece.upatras.gr, charalambos.konstantinou@kaust.edu.sa

dynamic model of the multimachine power system is presented and the main control problem is formulated. In Section III, the proposed structure of the resilient distributed controller is presented and mathematically analysed. The boundedness of the controller states is rigorously proven and it is analytically shown how the controller accomplishes accurate frequency restoration to the rated value and both real and reactive power sharing among the generators, while ensuring that the generator inputs remain within some predefined ranges at all times. Simulation results of the proposed scheme are given in Section IV and the final conclusions are provided in Section V.

## II. PROBLEM FORMULATION

### A. System modelling

We consider a generic multimachine power network with  $N$  buses and  $n$  generators where, for simplicity, the  $i$ -th generator is described by the well-known 3rd-order dynamic model:

$$\frac{d\delta_i}{dt} = \omega_b(\omega_i - \omega_s) \quad (1)$$

$$2H_i \frac{d\omega_i}{dt} = T_{mi} - T_{ei} - D_i(\omega_i - \omega_s) \quad (2)$$

$$T'_{d0i} \frac{dE'_{qi}}{dt} = E_{fi} - E'_{qi} + (X_{di} - X'_{di})i_{di} \quad (3)$$

where  $\delta_i$  is the rotor angle,  $\omega_b$  is the base angular velocity,  $\omega_i$  is the generator angular velocity,  $\omega_s$  is the synchronous angular velocity (i.e.,  $\omega_i - \omega_s$  defines the slip),  $H_i$  is the inertia constant,  $D_i$  is the generator motor damping,  $T_{mi}$  and  $T_{ei}$  are the mechanical and electrical torques, respectively,  $T'_{d0i}$  is the  $d$ -axis open circuit transient time constant,  $E'_{qi}$  is the  $q$ -axis transient emf,  $E_{fi}$  is the field excitation voltage,  $X_{di}$  and  $X'_{di}$  are the  $d$ -axis synchronous and transient reactances, and  $i_{di}$  is the  $d$ -axis component of the stator current. Note that the electrical torque is given as

$$T_{ei} = \psi_{di}i_{qi} - \psi_{qi}i_{di}, \quad (4)$$

where  $i_{qi}$  is the  $q$ -axis component of the stator current,  $\psi_{di}$  and  $\psi_{qi}$  are the  $d$ - and  $q$ -axis flux of the damper windings, respectively, and are linked to the stator currents and the  $q$ -axis transient emf as

$$\psi_{di} = X'_{di}i_{di} + E'_{qi} \quad (5)$$

$$\psi_{qi} = X'_{qi}i_{qi}, \quad (6)$$

where  $X'_{qi}$  is the  $q$ -axis transient reactance. Furthermore, the relationship between the generator stator current and voltages is

$$i_{qi} = \frac{1}{r_{ai}}(\psi_{di} - v_{qi}) \quad (7)$$

$$i_{di} = \frac{1}{r_{ai}}(-\psi_{qi} - v_{di}) \quad (8)$$

where  $r_{ai}$  is the armature resistance.

In order to obtain the model of the entire multimachine power network, we need to rotate the generator current and

voltages by the rotor phase angle  $\delta_i$ , resulting in the generator current and voltages in a common reference frame, i.e.,

$$i_{Qi} + ji_{Di} = (i_{qi} + ji_{di})e^{j\delta_i} \quad (9)$$

$$v_{Qi} + jv_{Di} = (v_{qi} + jv_{di})e^{j\delta_i}. \quad (10)$$

In order to combine the generator equations with the network, we consider each generator as a current injection source given below

$$i_{gi} = i_{Qi} + ji_{Di} + \frac{1}{r_{ai}}v_{gi} = i_{Qi} + ji_{Di} + \frac{1}{r_{ai}}(v_{Qi} + jv_{Di}). \quad (11)$$

Now, by defining the vector  $I_{N \times 1}$  consisting of the elements  $I_j$  where  $I_j = i_{gi}$  if the  $i$ -th generator is connected to the  $j$ -th node, otherwise  $I_j = 0$  (load buses), and similarly the vector  $V_{N \times 1}$  of the bus voltages, then there is

$$I = YV \quad (12)$$

where  $Y$  is the admittance matrix that includes the summation of the line, generator and load admittance matrices. By combining the equations (4)-(12) and replacing into the dynamic model of each generator (1)-(3), one can conclude that the dynamic equations of the entire multimachine power network with  $N$  buses and  $n$  generators are given in the generic nonlinear form

$$\dot{x} = f(x, u) \quad (13)$$

where the state vector is  $x = [\delta_1 \dots \delta_n \omega_1 \dots \omega_n E'_{q1} \dots E'_{qn}]^T$  and the control input vector is  $u = [T_{m1} \dots T_{mn} E_{f1} \dots E_{fn}]^T$ . Hence, the control inputs are the mechanical torque and the field excitation voltage of each generator. Note that when the  $j$ -th generator bus is considered as the reference bus, then  $\delta_j = 0$  and the state vector size is reduced by one.

### B. Control task

The main goal in a multimachine power network is to ensure that the grid frequency is maintained at  $1pu$  and the bus voltages remain as close to  $1pu$  as possible. These are accomplished by suitable control design at the mechanical torque and field excitation voltage of each generator respectively. However, since  $n$  generators are available to accomplish the above tasks, it is often required to additionally share the network load demand (including line losses) in a proportional manner, i.e.,  $n_1P_1 \approx \dots \approx n_nP_n$ , and  $m_1Q_1 \approx \dots \approx m_nQ_n$ , where  $P_i$ ,  $Q_i$  are the real and reactive powers delivered by the  $i$ -th generator and  $n_i$ ,  $m_i$  are the gains that achieve the desired power sharing.

For the latter, a communication network is established between the generators in order for the neighbouring units to exchange information on their real and reactive power. Hence, some necessary properties for the communication network are denoted. In particular, the communication network is represented by a connected, undirected and unweighted graph  $G(\mathcal{V}, \mathcal{E}, \mathcal{A})$ , with a set of vertices  $\mathcal{V} = [v_1 \ v_2 \ \dots \ v_n]$ , connected by a set of edges  $\mathcal{E} \subset \mathcal{V} \times \mathcal{V}$  and

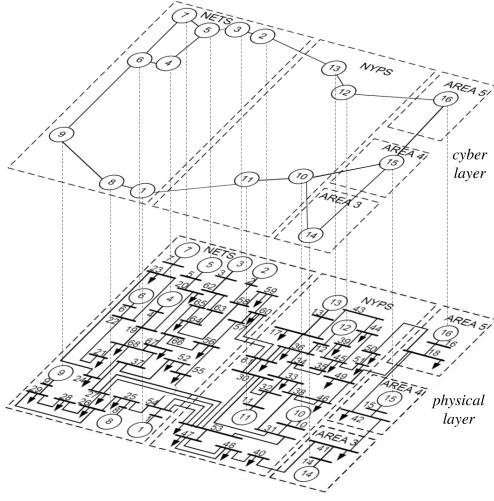

Fig. 1: Example of the IEEE 68-bus 16-machine power system in a cyber-physical framework.

induced by an adjacency matrix  $A$ . The resulting Laplacian matrix is given as  $L = [A\mathbf{1}_n] - A$ , where  $\mathbf{1}_n$  is the vector all elements equal to 1 and the notation  $[w]$  of any vector  $w$  represents a diagonal matrix with diagonal entries the elements of vector  $w$ . An example of a multimachine power system with a communication network among the generators is depicted in Fig. 1, where the physical layer includes the IEEE benchmark 68 bus, 16 machine power system and the cyber layer includes the communication network among the generator units.

Although the frequency restoration and power sharing can be accomplished using neighbour-to-neighbour communication with a conventional distributed integral controller, as widely applied in power networks and microgrids [2], [9], the constraints of the input signals (mechanical torque and field excitation voltage) are often ignored. In particular, both control input signals should remain within prescribed bounds, i.e.,  $T_{mi} \in [T_{mi}^{min}, T_{mi}^{max}]$  and  $E_{fi} \in [E_{fi}^{min}, E_{fi}^{max}]$ , which are given according to the operating limits of the governor and the operating/thermal limits of the excitation system in order to maintain synchronism for each generator. Although typical saturation units can be added to the control inputs, these may result to integrator windup and instability, while in the case where the system remains stable, the entire network will no longer operate based on the desired power sharing operation if the input of one or more generator units reach the saturation limit. A novel distributed controller that offers advanced level of resilience in such cases, without requiring a modification of its dynamics, is presented next.

### III. RESILIENT DISTRIBUTED CONTROL DESIGN AND ANALYSIS

#### A. Proposed controller

Consider, initially, the nominal values of the mechanical torque input  $T_{mi}^n$  and the field excitation voltage  $E_{fi}^n$  of each generator, for which it obviously holds that  $T_{mi}^n \in$

$(T_{mi}^{min}, T_{mi}^{max})$  and  $E_{fi}^n \in (E_{fi}^{min}, E_{fi}^{max})$ . In order to accomplish the desired input constraints without the need of a saturation unit, the main concept of the original Bounded Integral Control (BIC), proposed in [18], is adopted but should be modified accordingly to achieve the desired control tasks in a distributed manner, and reduce the number of integral states; thus simplifying the control implementation. Since the control tasks (frequency restoration and power sharing) should be accomplished independently of any generator input reaching its upper or lower limit, the proposed resilient distributed controller takes the form:

$$T_m = T_m^n + \sigma_T \quad (14)$$

$$E_f = E_f^n + \sigma_E \quad (15)$$

$$\dot{\sigma}_T = k_T ([g_T] (\omega_S \mathbf{1}_n - \omega) - k_P L_T n P) - k \sigma_T \quad (16)$$

$$\dot{\sigma}_E = -k_E L_E m Q - k \sigma_E \quad (17)$$

where  $T_m = [T_{m1} \dots T_{mn}]^T$ ,  $E_f = [E_{f1} \dots E_{fn}]^T$ ,  $\sigma_T = [\sigma_{T1} \dots \sigma_{Tn}]^T$ ,  $\sigma_E = [\sigma_{E1} \dots \sigma_{En}]^T$ ,  $T_m^n = [T_{m1}^n \dots T_{mn}^n]^T$ ,  $E_f^n = [E_{f1}^n \dots E_{fn}^n]^T$ ,  $\omega = [\omega_1 \dots \omega_n]^T$ ,  $P = [P_1 \dots P_n]^T$ ,  $Q = [Q_1 \dots Q_n]^T$ ,  $n = \text{diag}(n_1, \dots, n_n)$ ,  $m = \text{diag}(m_1, \dots, m_n)$ , scalars  $k_T, k_P, k_E$  are positive constants and  $k$  is selected as an arbitrarily small positive constant. Furthermore,

$$g_T = \begin{bmatrix} \left(1 - \frac{\sigma_{T1}}{\Delta T_{m1}^{max}}\right) \left(1 + \frac{\sigma_{T1}}{\Delta T_{m1}^{min}}\right) \\ \vdots \\ \left(1 - \frac{\sigma_{Tn}}{\Delta T_{mn}^{max}}\right) \left(1 + \frac{\sigma_{Tn}}{\Delta T_{mn}^{min}}\right) \end{bmatrix}, \quad (18)$$

$$g_E = \begin{bmatrix} \left(1 - \frac{\sigma_{E1}}{\Delta E_{f1}^{max}}\right) \left(1 + \frac{\sigma_{E1}}{\Delta E_{f1}^{min}}\right) \\ \vdots \\ \left(1 - \frac{\sigma_{En}}{\Delta E_{fn}^{max}}\right) \left(1 + \frac{\sigma_{En}}{\Delta E_{fn}^{min}}\right) \end{bmatrix}, \quad (19)$$

with  $\Delta T_{mi}^{max} = T_{mi}^{max} - T_{mi}^n$ ,  $\Delta T_{mi}^{min} = T_{mi}^n - T_{mi}^{min}$ ,  $\Delta E_{fi}^{max} = E_{fi}^{max} - E_{fi}^n$ ,  $\Delta E_{fi}^{min} = E_{fi}^n - E_{fi}^{min}$ , where  $\Delta T_{mi}^{max}, \Delta T_{mi}^{min}, \Delta E_{fi}^{max}, \Delta E_{fi}^{min} > 0$ , and

$$L_T = [g_T][Ag_T] - [g_T]A[g_T] \quad (20)$$

$$L_E = [g_E][Ag_E] - [g_E]A[g_E], \quad (21)$$

where  $A$  is the adjacency matrix of the communication network. Note that in order to have  $T_{mi} \in [T_{mi}^{min}, T_{mi}^{max}]$  and  $E_{fi} \in [E_{fi}^{min}, E_{fi}^{max}]$ , from (14)-(15), there should be  $\sigma_{Ti} \in [-\Delta T_{mi}^{min}, \Delta T_{mi}^{max}]$  and  $\sigma_{Ei} \in [-\Delta E_{fi}^{min}, \Delta E_{fi}^{max}]$ . Although the boundedness of the controller states within these sets will be analytically shown in the next subsection, it is worth noting that if  $\sigma_{Ti}$  and  $\sigma_{Ei}$  are maintained within their given bounds, then all the elements of vectors  $g_T$  and  $g_E$  are positive. In this case, one can easily observe that matrices  $L_T$  and  $L_E$ , given in (20)-(21), are symmetric Laplacian matrices.

To further elaborate, let us investigate matrix  $L_T$ . All diagonal elements are given by the diagonal matrix  $[g_T][Ag_T]$  and are positive, while the non-diagonal elements are provided from the symmetric matrix  $-[g_T]A[g_T]$  and are non-positive. In fact,  $[g_T]A[g_T]$  takes the form of a weighted adjacency matrix and has zero diagonal terms due to the

adjacency matrix  $A$ . Hence, the diagonal elements of  $L_T$  are  $L_{T(i,i)} = g_{T_i} \sum_{j=1}^n g_{T_j}$  and the non-diagonal elements are  $L_{T(i,j)} = -g_{T_i}g_{T_j}$ , indicating that  $L_T$  is a symmetric Laplacian matrix. The same holds for  $L_E$ .

As for the proposed controller dynamics, the controller for the  $i$ -th generator unit takes the form:

$$T_{mi} = T_{mi}^n + \sigma_{T_i} \quad (22)$$

$$E_{fi} = E_{fi}^n + \sigma_{E_i} \quad (23)$$

$$\begin{aligned} \dot{\sigma}_{T_i} = & k_T g_{T_i} \left( \omega_S - \omega_i - k_P \sum_{\substack{j=1 \\ (i,j) \in \mathcal{E}}}^n (n_i P_i - n_j P_j) g_{T_j} \right) \\ & - k \sigma_{T_i}, \quad \forall i = 1, \dots, n \end{aligned} \quad (24)$$

$$\begin{aligned} \dot{\sigma}_{E_i} = & -k_E g_{E_i} \left( \sum_{\substack{j=1 \\ (i,j) \in \mathcal{E}}}^n (m_i Q_i - m_j Q_j) g_{E_j} \right) \\ & - k \sigma_{E_i}, \quad \forall i = 1, \dots, n \end{aligned} \quad (25)$$

The initial conditions of the controller states should satisfy  $\sigma_{T_i}(0) \in (-\Delta T_{mi}^{min}, \Delta T_{mi}^{max})$  and  $\sigma_{E_i}(0) \in (-\Delta E_{fi}^{min}, \Delta E_{fi}^{max})$ .

In order to explain how the proposed distributed controller accomplished the frequency restoration and power sharing when all control inputs are within their prescribed limits (normal operation), let us consider the steady-state operation of the system and the control dynamics where  $\omega_{1e} = \dots = \omega_{ne}$ , the real and reactive power values are  $P_{1e}, \dots, P_{ne}, Q_{1e}, \dots, Q_{ne}$  and the controller states are regulated at the values  $\sigma_{T_{1e}}, \dots, \sigma_{T_{ne}}, \sigma_{E_{1e}}, \dots, \sigma_{E_{ne}}$ , where  $T_{mie} = T_{mi}^n + \sigma_{T_{ie}} \in (T_{mi}^{min}, T_{mi}^{max})$  and  $E_{fie} = E_{fi}^n + \sigma_{E_{ie}} \in (E_{fi}^{min}, E_{fi}^{max})$ , for all  $i = 1, \dots, n$ . Then from (16) and (17) at the steady state, it leads to

$$\begin{aligned} [g_{T_e}] (\omega_S \mathbf{1}_n - \omega_e) - k_P L_T n P_e &= \frac{k}{k_T} \sigma_T \\ -L_E m Q_e &= \frac{k}{k_E} \sigma_E \end{aligned}$$

For an arbitrarily small value of  $k$ , it yields

$$[g_{T_e}] (\omega_S \mathbf{1}_n - \omega_e) - k_P L_T n P_e \approx 0 \quad (26)$$

$$L_E m Q_e \approx 0. \quad (27)$$

Since  $L_T$  is a Laplacian matrix and  $L_T = L_T^T$ , then  $\mathbf{1}_n^T L_T = \mathbf{0}_n^T$ . By left multiplying (26) with  $\mathbf{1}_n^T$  there is

$$\begin{aligned} \mathbf{1}_n^T [g_{T_e}] (\omega_S \mathbf{1}_n - \omega_e) &\approx 0 \\ g_{T_e}^T (\omega_S \mathbf{1}_n - \omega_e) &\approx 0. \end{aligned} \quad (28)$$

Given that  $\omega_{1e} = \dots = \omega_{ne}$  and all the elements of  $g_{T_e}$  are positive, then from (28) one obtains that

$$\omega_{1e} = \dots = \omega_{ne} \approx \omega_S \quad (29)$$

leading to the desired frequency restoration. Now from (28), after taking into consideration (29), there is  $L_T n P_e \approx$

$\mathbf{0}_n$  which consequently leads to the desired power sharing  $n_1 P_1 \approx \dots \approx n_n P_n$ . Similarly from (27) it yields  $m_1 Q_1 \approx \dots \approx m_n Q_n$  which confirms the desired reactive power sharing.

### B. Controller boundedness and resilience properties

To explain how the proposed distributed controller ensures that both generator inputs  $T_{mi}$  and  $E_{fi}$ , and consequently the controller states  $\sigma_{T_i}$  and  $\sigma_{E_i}$ , are maintained within the desired bounds  $T_{mi} \in [T_{mi}^{min}, T_{mi}^{max}]$  and  $E_{fi} \in [E_{fi}^{min}, E_{fi}^{max}]$  (equivalently  $\sigma_{T_i} \in [-\Delta T_{mi}^{min}, \Delta T_{mi}^{max}]$  and  $\sigma_{E_i} \in [-\Delta E_{fi}^{min}, \Delta E_{fi}^{max}]$ ), for every generator unit, the controller dynamics (24) and (25) are analysed. It is reminded that initially there is  $\sigma_{T_i}(0) \in (-\Delta T_{mi}^{min}, \Delta T_{mi}^{max})$  and  $\sigma_{E_i}(0) \in (-\Delta E_{fi}^{min}, \Delta E_{fi}^{max})$ .

Let us start with the dynamics (24) of  $\sigma_{T_i}$ . At the upper limit, i.e., when  $\sigma_{T_i} = \Delta T_{mi}^{max}$ , the vector field from (24) becomes

$$f(\sigma_{T_i})|_{\sigma_{T_i} = \Delta T_{mi}^{max}} = -k \Delta T_{mi}^{max}. \quad (30)$$

Expression (30) obviously describes a vector pointing towards the origin, i.e., inwards towards the closed set  $S_{T_i} = \{\sigma_{T_i} \in R : -\Delta T_{mi}^{min} \leq \sigma_{T_i} \leq \Delta T_{mi}^{max}\}$ . Furthermore, at the lower limit, i.e., when  $\sigma_{T_i} = -\Delta T_{mi}^{min}$ , the vector field becomes

$$f(\sigma_{T_i})|_{\sigma_{T_i} = -\Delta T_{mi}^{min}} = k \Delta T_{mi}^{min}, \quad (31)$$

which also points inwards to  $S_{T_i}$ . Hence, since initially  $\sigma_{T_i}(0)$  belongs in the interior of  $S_{T_i}$ , then the trajectory  $\sigma_{T_i}(t)$  will remain in the interior of  $S_{T_i}$  for all future time, i.e.,  $\sigma_{T_i} \in [-\Delta T_{mi}^{min}, \Delta T_{mi}^{max}]$ ,  $\forall t \geq 0$ . A similar vector field analysis for the controller state  $\sigma_{E_i}$  can show that  $\sigma_{E_i} \in [-\Delta E_{fi}^{min}, \Delta E_{fi}^{max}]$ ,  $\forall t \geq 0$ , resulting in the boundedness of the controller states, and equivalently the control inputs of the generators, within the predefined ranges. An illustration of the controller state vector fields at the upper and lower limits of their bounds is shown in Fig. 2.

In order to analyse the resilience property of the proposed distributed controller, let us consider the case where, at the steady state, due to a load change, the controller of  $l$ -th generator (where  $l \in \{1, \dots, n\}$ ) leads its mechanical torque input to the upper limit, i.e.  $T_{ml} = T_{ml}^{max}$  or equivalently  $\sigma_{T_{le}} = \Delta T_{ml}^{max}$ , while the remaining equations satisfy the entire load demand and their mechanical torque inputs remain within the interior of their predefined set. From (18), there is

$$g_{T_l} = 0 \text{ and } g_{T_i} \neq 0, \quad \forall i = 1, \dots, n, \text{ with } i \neq l.$$

Then, at the steady state, (24) yields for an arbitrarily small  $k$  that

$$\omega_S - \omega_i - k_P \sum_{\substack{j=1, j \neq l \\ (i,j) \in \mathcal{E}}}^n (n_i P_i - n_j P_j) g_{T_j} \approx 0. \quad (32)$$

This expression is similar to (26) where the  $l$ -th equation is missing. In addition, the  $l$ -th generator is automatically removed from the power sharing since  $g_{T_l} = 0$  and the

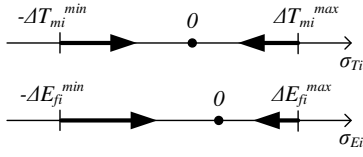

Fig. 2: Illustration of the controller state vector field.

corresponding terms are removed from the summation in (32). Hence, the same analysis conducted in Section III-A simply proves that the remaining generators, i.e., for  $i = 1, \dots, n$ , with  $i \neq l$ , achieve the desired frequency restoration and power sharing among them, verifying the resilience property of the proposed distributed controller. It is underlined that the same would occur if the mechanical torque input of the  $l$ -the generator reaches its lower limit, and consequently the same holds for the field excitation voltage and the reactive power sharing. The boundedness and the resilient operation of the entire system is validated in the simulation scenarios that follow in the next section.

#### IV. SIMULATION RESULTS

In order to assess the effectiveness of the proposed controller, a power system with 4 generators and 10 buses is considered. The system's physical and communication layers are shown in Fig. 3, while the parameters of the transmission lines are shown in Table I. Given the communication graph in Fig. 3 the adjacency matrix of the system is  $A = [0, 1, 0, 1; 1, 0, 1, 0; 0, 1, 0, 1; 1, 0, 1, 0]$  and the Laplacian matrices  $L_T, L_E$  are calculated using (20)-(21).

For the given multimachine power system, we consider the case where the torque limits of the generators are set to  $\Delta T_m^{max} = [2 \ 7 \ 0.5 \ 10]^T$  and  $\Delta T_m^{min} = [2 \ 4.36 \ 4.8 \ 6.1521]^T$ , while the field voltage limits are  $\Delta E_f^{max} = [2 \ 0.2 \ 2 \ 2]^T$  and  $\Delta E_f^{min} = [0.5 \ 0.5 \ 0.5 \ 0.5]^T$  (all values in pu). The gains of the controller are set to  $k_T = 160$ ,  $k_P = 0.0025$ ,  $k_E = 0.1$  and  $k = 10^{-6}$ . The rated frequency is  $\omega_s = 1pu$  and the gains for the real and reactive power sharing are  $n = \text{diag}(\frac{1}{2}, \frac{1}{4}, \frac{1}{6}, \frac{1}{8})$  and  $m = \text{diag}(1, 1, 1, 1)$ , respectively, aiming at the desired sharing of  $P_1 : P_2 : P_3 : P_4 = 1 : 2 : 3 : 4$  and  $Q_1 : Q_2 : Q_3 : Q_4 = 1 : 1 : 1 : 1$ , respectively.

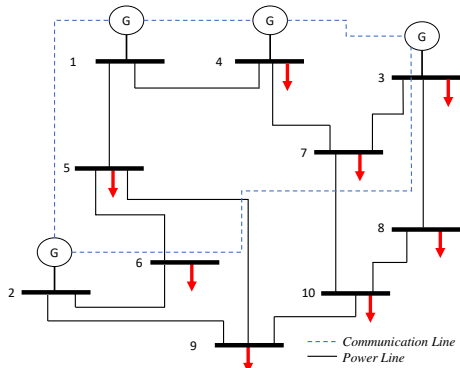

Fig. 3: 10-bus, 4-generator power system with the cyber and physical connections.

Line	Line Impedance (pu)
1-5	0.0000+j0.0181
1-4	0.0000+j0.0250
2-6	0.0000+j0.0200
2-9	0.0007+j0.0142
3-7	0.0009+j0.0180
3-8	0.0005+j0.0272
4-7	0.0000+j0.0143
5-6	0.0005+j0.0272
7-10	0.0009+j0.0250
8-10	0.0005+j0.0272
9-5	0.0005+j0.0272
9-10	0.0005+j0.0272

TABLE I: Power Lines Data

At the beginning of the simulation, the power system is at the steady state with each generator operating at the rated frequency  $\omega_s$  based on constant inputs  $T_{mi}$  and  $E_{fi}$  calculated from the load flow analysis. At time  $t = 10s$  the proposed distributed controller is activated. At time  $t = 300s$ , the load demand is increased, represented by increasing the load in terms of real power at bus 4 by  $5pu$ , which is then disconnected (load shedding) at time  $t = 600s$ .

As shown in Figs. 4, 5a, and 5b, when the controller is activated, the real and reactive power sharing is achieved based on the specified droop gains and the generators operate at rated frequency  $\omega_s$ . When the load increases, the torque input of generator 3 reaches its upper bound without exceeding it, as already proven in the theory and demonstrated in Fig. 6a. Generator 3 is automatically excluded from the power sharing procedure, while the remaining generators continue sharing real power with  $P_1 : P_2 : P_4 = 1 : 2 : 4$  and restore the frequency back to its rated value ( $1pu$ ), as is evident in Figs. 4 and 5a. Similarly, the increase of the load causes generator 2 to reach its upper field voltage limit (Fig. 6b) and generator 2 is automatically excluded from the reactive power sharing procedure, while generators 1, 3 and 4 preserve the reactive power sharing among them, i.e.  $Q_1 : Q_3 : Q_4 = 1 : 1 : 1$  (Fig. 5b). This verifies the resilient operation of the proposed controller. Finally, as shown in Figs. 5a and 5b, when the load decreases back to its initial value, the active and reactive power sharing between all four generators is restored and the frequency is also restored to its rated value.

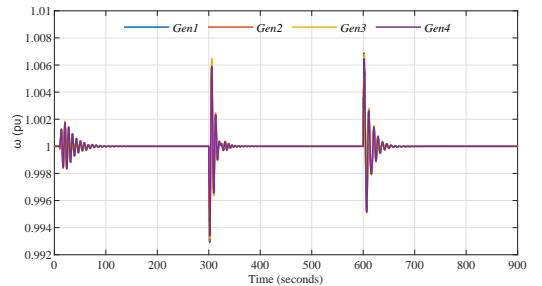
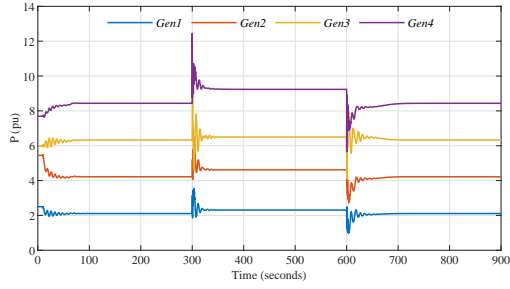
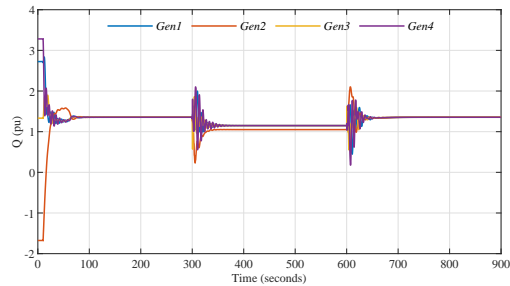

Fig. 4: Generator frequencies.



(a) Generator real power output



(b) Generator reactive power output

Fig. 5: Generator outputs.

## V. CONCLUSIONS

A resilient distributed integral controller is introduced in this paper in order to achieve frequency restoration and power sharing among multiple generator units and at the same time ensure that all generator inputs remain within prescribed bounds. Even under scenarios that force a generator input to operate at its limit, the proposed controller ensures that the remaining generators share the entire load proportionally and restore the grid frequency without requiring any modification of the controller structure or dynamics. The controller's efficiency and resiliency have been analytically proven and then validated in a simulated environment of a 10-bus, 4-generator system.

## REFERENCES

- [1] G. C. Konstantopoulos, A. T. Alexandridis, and P. C. Papageorgiou, "Towards the integration of modern power systems into a cyber-physical framework," *Energies*, vol. 13, no. 9, 2020.
- [2] T. Wang, D. O'Neill, and H. Kamath, "Dynamic control and optimization of distributed energy resources in a microgrid," *IEEE Transactions on Smart Grid*, vol. 6, no. 6, pp. 2884–2894, 2015.
- [3] V. C. Gungor, D. Sahin, T. Kocak, S. Ergut, C. Buccella, C. Cecati, and G. P. Hancke, "Smart grid technologies: Communication technologies and standards," *IEEE Transactions on Industrial Informatics*, vol. 7, no. 4, pp. 529–539, 2011.
- [4] L. D. Marinovici, J. Lian, K. Kalsi, P. Du, and M. Elizondo, "Distributed hierarchical control architecture for transient dynamics improvement in power systems," *IEEE Transactions on Power Systems*, vol. 28, no. 3, pp. 3065–3074, 2013.
- [5] J. Machowski, S. Robak, J. Bialek, J. Bumby, and N. Abi-Samra, "Decentralized stability-enhancing control of synchronous generator," *IEEE Transactions on Power Systems*, vol. 15, no. 4, pp. 1336–1344, 2000.
- [6] H. Liu, J. Su, Y. Yang, Z. Qin, and C. Li, "Compatible decentralized control of avr and pss for improving power system stability," *IEEE Systems Journal*, vol. 15, no. 2, pp. 2410–2419, 2021.
- [7] H. Kim, M. Zhu, and J. Lian, "Distributed robust adaptive frequency control of power systems with dynamic loads," *IEEE Transactions on Automatic Control*, vol. 65, no. 11, pp. 4887–4894, 2020.

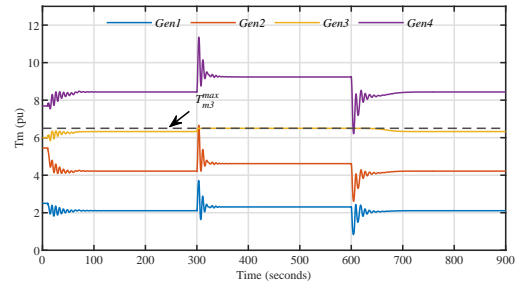

(a) Generator mechanical torque

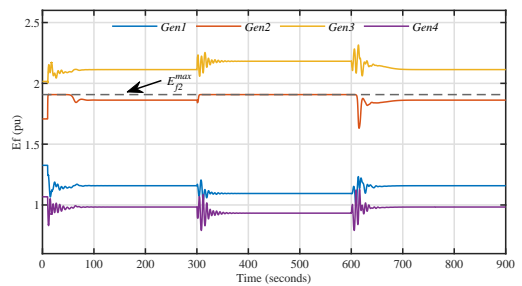

(b) Generator field voltage

Fig. 6: Generator inputs.

- [8] P. Ge, F. Teng, C. Konstantinou, and S. Hu, "A resilience-oriented centralised-to-decentralised framework for networked microgrids management," *Applied Energy*, vol. 308, p. 118234, 2022.
- [9] M. Mottaghizadeh, F. Aminifar, T. Amraee, and M. Sanaye-Pasand, "Distributed robust secondary control of islanded microgrids: Voltage, frequency, and power sharing," *IEEE Transactions on Power Delivery*, vol. 36, no. 4, pp. 2501–2509, 2021.
- [10] A. D. Dominguez-Garcia, C. N. Hadjicostis, and N. H. Vaidya, "Resilient networked control of distributed energy resources," *IEEE Journal on Selected Areas in Communications*, vol. 30, no. 6, pp. 1137–1148, 2012.
- [11] M. H. Nazari, L. Y. Wang, S. Grijalva, and M. Egerstedt, "Communication-failure-resilient distributed frequency control in smart grids: Part i: Architecture and distributed algorithms," *IEEE Transactions on Power Systems*, vol. 35, no. 2, pp. 1317–1326, 2020.
- [12] —, "Communication-failure-resilient distributed frequency control in smart grids: Part ii: Algorithmic implementation and system simulations," *IEEE Transactions on Power Systems*, vol. 35, no. 4, pp. 3192–3202, 2020.
- [13] S. Amini, F. Pasqualetti, and H. Mohsenian-Rad, "Dynamic load altering attacks against power system stability: Attack models and protection schemes," *IEEE Transactions on Smart Grid*, vol. 9, no. 4, pp. 2862–2872, 2016.
- [14] N. M. Dehkordi and S. Z. Moussavi, "Distributed resilient adaptive control of islanded microgrids under sensor/actuator faults," *IEEE Transactions on Smart Grid*, vol. 11, no. 3, pp. 2699–2708, 2020.
- [15] J. Giraldo and M. Parvania, "Resilient operating constraints for power distribution systems under setpoint attacks," in *2022 IEEE 61st Conference on Decision and Control (CDC)*, 2022, pp. 7180–7185.
- [16] I. G. Perantonis, Z. A. Alexakis, G. C. Konstantopoulos, and A. T. Alexandridis, "Distributed bounded integral control for multimachine power systems," in *2022 30th Mediterranean Conference on Control and Automation (MED)*, 2022, pp. 797–802.
- [17] J. Liu, B. H. Krogh, and M. D. Ilic, "Saturation-induced frequency instability in electric power systems," in *2008 IEEE Power and Energy Society General Meeting - Conversion and Delivery of Electrical Energy in the 21st Century*, 2008, pp. 1–7.
- [18] G. C. Konstantopoulos, Q. C. Zhong, B. Ren, and M. Krstic, "Bounded integral control of input-to-state practically stable nonlinear systems to guarantee closed-loop stability," *IEEE Transactions on Automatic Control*, vol. 61, no. 12, pp. 4196–4202, Dec 2016.