

UNIVERSITY OF CALGARY

Dagger Linear Logic and Categorical Quantum Mechanics

by

Priyaa Varshinee Srinivasan

A THESIS
SUBMITTED TO THE FACULTY OF GRADUATE STUDIES
IN PARTIAL FULFILLMENT OF THE REQUIREMENTS FOR THE
DEGREE OF DOCTOR OF PHILOSOPHY

GRADUATE PROGRAM IN COMPUTER SCIENCE

CALGARY, ALBERTA

September, 2021

© Priyaa Varshinee Srinivasan 2021

arXiv:2303.14231v1 [math.CT] 24 Mar 2023

Abstract

This thesis develops the categorical proof theory for the non-compact multiplicative dagger (\dagger) linear logic, and investigates its applications to Categorical Quantum Mechanics (CQM).

The existing frameworks of CQM are categorical proof theories of compact \dagger -linear logic, and are motivated by the interpretation of quantum systems in the category of finite dimensional Hilbert spaces. This thesis describes a new non-compact framework called Mixed Unitary Categories which can accommodate infinite dimensional systems, and develops models for the framework. To this end, it builds on linearly distributive categories, and $*$ -autonomous categories which are categorical proof theories of (non-compact) multiplicative linear logic. The proof theory of non-compact \dagger -linear logic is obtained from the basic setting of an LDC by adding a dagger functor satisfying appropriate coherences to give a \dagger -LDC.

From every (isomix) \dagger -LDC one can extract a canonical “unitary core” which up to equivalence is the traditional CQM framework of \dagger -monoidal categories. This leads to the framework of Mixed Unitary Categories (MUCs): every MUC contains a (compact) unitary core which is extended by a (non-compact) isomix \dagger -LDC. Various models of MUCs based on Finiteness Spaces, Chu spaces, Hopf modules, etc., are developed in this thesis. This thesis also generalizes the key algebraic structures of CQM, such as observables, measurement, and complementarity, to MUC framework. Furthermore, using the MUC framework, this thesis establishes a connection between the complementary observables of quantum mechanics and the exponential modalities of linear logic.

Acknowledgements

I thank my supervisor Dr. Robin Cockett for the trust he placed in me even though I was not a mathematician and had no clue about Category Theory when I joined his group. I am eternally grateful for his unwavering support and patience in helping me refine my *art of learning*, and, dually, *my art of teaching*. I am also grateful to him for providing an inclusive, safe and a comfortable environment for me to learn Mathematics and to do research. Thank you, Robin, for all the proofs we worked out over a cup of tea and the group hikes.

I am thankful to Jonathan, my friend, for the countless hours he spent in teaching me Category Theory and helping me write proofs in the initial days of my Ph.D., without which this journey would not have been possible. Thank you, Jonathan!

I thank my co-supervisor Dr. Gilad Gour for his patience and kind support throughout my degree. I thank Dr. Kristine Bauer for her support as my interim supervisor during Dr. Cockett's sabbatical and for all the fun conversations we shared during the weekly seminars and symposiums. I thank Dr. Renate Scheidler for her excellent mentorship during the practicum of my SAGES teaching certification. I thank Dr. Jalal Kawash for the kind guidance I received as his teaching assistant. I thank Dr. Barry Sanders for the financial support he provided me during the first three years of my degree. I thank Dr. Bob Coecke, Dr. Jamie Vicary, and Dr. Chris Heunen for hosting me at the University of Oxford and at the University of Edinburgh during my Mitacs Globallink internship. I thank my examiners Dr. Peter Selinger, Dr. Philipp Woelfel, Dr. Carlo Maria Scandolo, and Dr. Kristine Bauer immensely for their time and effort in reading my thesis, and their feedback.

I thank my friend and colleague Jean Simon Lemay (JS) for many examples in this thesis, and for making my research visit to Oxford quite enjoyable. Thank you, JS, for lending me your bicycle during the visit! Thank you, Jonathan, Amolak, JS, and Ben for proof-reading my thesis. Thank you, Cole, for the fun and successful collaborations on the CNOT and the dagger linear logic papers. A big thanks to all my colleagues, in the past and in the present, from Dr. Cockett's and Dr. Gour's group for all the enlightening conversations and support. It was an honour for me to work with you all.

A ton of thanks to my friends, for making me feel home in Calgary and for all the

beautiful memories - Sunday afternoons at coffee shops, night walks at the Confederation park, dumpling parties, road trip to Okanagan, hiking in the Rockies, hot tea, home-made delicacies, shared lunch, weeding bees, and many more. I thank all my overseas friends for being there for me over Skype and other mediums whenever I was in need of you.

Many thanks to Maryam, Jackie, and Katie at the front office of the Computer Science Department for providing excellent administrative support throughout my degree, and for their gentle smile whenever I turned up at their desk with a request.

Last, but most of all, I thank my family for their extra-ordinary support, and encouragement in all my endeavors, and for making possible this first ever doctorate degree in my family tree.

*To my parents Shanthi and Srinivasan,
and to all the front-line workers in this world and in heaven (COVID-19).*

Symbols, abbreviations and nomenclature

Symbol	Definition
\cup, \bigcup	Set union
\sqcup	Disjoint union of sets
\cap, \bigcap	Set intersection
\in	A member of
$\llbracket x_1, x_2, \dots, x_n \rrbracket$	finite multiset
\emptyset	Empty set
$\{*\}$	Singleton set
$\{x \mid \text{Condition on } x\}$	defining a set by a condition
\mathbb{X}, \mathbb{Y}	Categories except for \mathbb{C} and \mathbb{R} which sometimes mean complex numbers, and real numbers respectively
A, B, C, \dots	Objects in a category
$A \simeq B$	Object A is isomorphic to object B
f, g, h	Maps in a category
F, G	Functors between categories
\otimes	Tensor product
\oplus	Par product (in linear logic)

Symbol	Definition
\prod	Product
\coprod	Coproduct
a_{\otimes}	Associator natural isomorphism for the tensor product
a_{\oplus}	Associator natural isomorphism for the par product
u_{\otimes}^l	Left unitor natural isomorphism for the tensor product
\top	Unit of the tensor product
\perp	Unit of the par product
∂^L	Left linear distributor
∂^R	Right linear distributor
m, ∇	Multiplication for a monoid
u, Υ	Unit for a monoid
d, Δ	Comultiplication for a comonoid
e, \lrcorner	Counit for a comonoid
\dagger, \ddagger	Dagger functor
$(-)^*$	Dual functor
$\overline{(-)}$	Conjugation functor
$:=$	The left-hand side is defined to the right-hand side of the equation
\implies	Implication
\Leftrightarrow	If and only if
\exists	there exists
\forall	For all
\mathbb{N}	Natural numbers
\mathbb{Z}	Integers

Table of Contents

Abstract	ii
Acknowledgements	iii
Dedication	v
Table of Contents	viii
List of Figures and Illustrations	xii
Epigraph	xiii
1 Introduction	1
1.1 From linear logic to quantum mechanics	2
1.1.1 Linear logic	2
1.1.2 Categorical semantics for linear logic	3
1.1.3 Categorical quantum mechanics (CQM)	4
1.1.4 Towards arbitrary dimensions in CQM	6
1.1.5 Non-compact multiplicative \dagger -linear logic	7
1.1.6 Linearly distributive categories	8
1.2 Thesis outline	10
1.2.1 Part I: Dagger linear logic	11
1.2.2 Part II: Application to dagger linear logic to CQM	13
1.3 Prerequisites	14
1.4 Notation	15
I Dagger Linear Logic	16
2 Categorical semantics for linear logic	17
2.1 Linearly Distributive Categories (LDCs)	17
2.1.1 Linearly distributive categories	17
2.1.2 Graphical calculus	22
2.1.3 Mix, isomix and compact LDCs	25
2.1.4 $*$ -autonomous categories	26
2.2 Linear functors and transformations	29
2.2.1 Linear functors and transformations	30
2.2.2 Linear functors for isomix categories	35
2.2.3 Frobenius functors	36

2.3	Motivating examples	45
2.3.1	Finiteness relations \mathbf{FRel} and finiteness matrices $\mathbf{FMat}(R)$	45
2.3.2	Products, coproducts and biproducts in \mathbf{FRel} and $\mathbf{FMat}(R)$	51
2.3.3	The tensor structure in \mathbf{FRel} and $\mathbf{FMat}(R)$	52
2.3.4	The core of \mathbf{FRel} and $\mathbf{FMat}(R)$	56
3	Dagger linearly distributive categories	58
3.1	Dagger for LDCs	58
3.1.1	Dagger linearly distributive categories	58
3.1.2	Sequent calculus for \dagger -linear logic	63
3.1.3	Dagger functor box	64
3.1.4	Functors for \dagger -linearly distributive categories	65
3.2	Examples: \dagger -LDCs	67
3.2.1	Every \dagger -monoidal category is a \dagger -LDC	67
3.2.2	Finite dimensional framed vector spaces	67
3.2.3	Category of abstract state spaces	69
3.3	Dagger, duals, and conjugation	71
3.3.1	Duals	71
3.3.2	Conjugation	73
3.3.3	Dagger and conjugation	76
3.4	Examples: Dagger and conjugation	80
3.4.1	A group with conjugation considered as a category	80
3.4.2	Finiteness matrices and finiteness relations	82
3.4.3	Chu spaces	82
3.4.4	Category of Hopf modules in a $*$ -autonomous category	85
4	Mixed unitary categories (MUCs)	90
4.1	Unitary categories	90
4.1.1	Unitary structure	90
4.1.2	Unitary categories	98
4.1.3	The unitary construction	101
4.2	Examples: The unitary construction	104
4.2.1	Category of abstract state spaces	105
4.2.2	Category of a group with involution	105
4.2.3	Category of Hopf modules in a $*$ -autonomous category	106
4.3	Mixed unitary categories	107
4.3.1	Mixed unitary category	107
4.3.2	Canonical mixed unitary categories	109
4.4	Examples: Mixed unitary categories	110
4.4.1	Finite dimensional framed vector spaces	110
4.4.2	Finiteness matrices	112
4.4.3	The embedding of finite dimensional Hilbert Spaces into Chu Spaces	112
5	Summary	115

II Application of dagger linear logic to categorical quantum mechanics 116

6	Categorical Quantum Mechanics	117
6.1	Dagger monoidal categories	117
6.1.1	Graphical calculus for monoidal categories	117
6.1.2	Dagger monoidal categories	119
6.2	Examples	121
6.2.1	Categories of sets and relations, Rel	121
6.2.2	Categories of Hilbert spaces and bounded linear maps, Hilb	122
6.2.3	Categories of finite matrices over a commutative rig R , Mat (R)	123
6.3	Complete positivity	123
6.3.1	The CPM construction	124
6.3.2	The \mathbf{CP}^∞ construction	125
6.3.3	Environment structures	126
6.4	Measurement and complementarity	129
6.4.1	Quantum observables	129
6.4.2	Strong complementarity	133
7	Completely positive maps	138
7.1	String calculus for MUCs	138
7.1.1	Unitary structure map	138
7.1.2	Inverse of the mixor	139
7.2	Quantum channels for MUCs	139
7.2.1	Kraus maps	139
7.2.2	\mathbf{CP}^∞ -construction for MUCs	143
7.3	Environment structure for MUCs	151
7.3.1	Environment structure	151
7.3.2	Characterizing the \mathbf{CP}^∞ construction	154
8	Linear monoids, comonoids, and bialgebras	157
8.1	Linear monoids	157
8.1.1	Duals	157
8.1.2	Linear monoids	163
8.1.3	The endomorphism linear monoid	169
8.1.4	Being Frobenius	175
8.2	Linear comonoids	179
8.3	Linear bialgebras	184
9	Measurement and complementarity	186
9.1	Compaction	186
9.2	Binary idempotents	190
9.2.1	For linear monoids	190
9.2.2	For linear comonoids	196
9.2.3	For linear bialgebras	198
9.3	Complementary linear bialgebras	199
9.4	Exponential modalities	202
9.4.1	Exponential modalities for monoidal categories	203
9.4.2	Exponential modalities for \dagger -LDCs	204

9.4.3	Sequent calculus for exponential \dagger -linear logic	208
9.4.4	Complementarity from free exponential modalities	210
10	Examples	215
10.1	Duals and linear monoids	215
10.1.1	Duals in \mathbf{FRel} and $\mathbf{FMat}(R)$	215
10.1.2	Linear monoids in \mathbf{FHilb}	218
10.2	Exponential Modalities	221
10.2.1	The free exponential modalities for \mathbf{Rel}	221
10.2.2	The free exponential modalities for \mathbf{FRel} and $\mathbf{FMat}(R)$	222
10.2.3	The free exponential modalities in Chu spaces	226
10.3	The free infinite linear monoids in \mathbf{FRel} and $\mathbf{FMat}(R)$	227
11	Summary	233
12	Conclusion and future work	235
12.1	Conclusion	235
12.2	Future work	237
12.2.1	Models of physical systems	237
12.2.2	Joyal's Bicompletion construction	238
12.2.3	Clifford algebras in linear settings	239
	Bibliography	241

List of Figures and Illustrations

1.1	\dagger -compact closed categories for quantum mechanics	4
1.2	Sequent rules for multiplicatives	8
1.3	Sequent rules for negation	9
1.4	(a) Binary mix axiom (b) Nullary mix axiom	10
2.1	Schematic diagram of LDC properties	26
2.2	Linear functor family	37
2.3	Finiteness matrix	50
3.1	Sequent rules for \dagger	63
3.2	Sequent proof:- ι is an isomorphism	63
3.3	Derivation of the \oplus -laxor	63
3.4	Derivation of \perp -laxor	64
4.1	∂_L is a unitary isomorphism	99
4.2	Schematic diagram for MUC	108
8.1	Sequent rules for right \dagger -duals	159
9.1	Sequent rules for exponential modality	208
9.2	Derivation of $(!, ?)$ linear functor	208
9.3	Sequent rules for \dagger -exponential modality	208
9.4	Derivation of the isomorphism $\mathfrak{s} : (?A)^\dagger \rightarrow !(A^\dagger)$	209
9.5	Derivation of the isomorphism $\mathfrak{t} : (!A)^\dagger \rightarrow ?(A^\dagger)$	209
9.6	Sequent proof:- $!A$ is a \dagger -dual if A is a \dagger -dual	209

Epigraph

Every journey begins with a single step

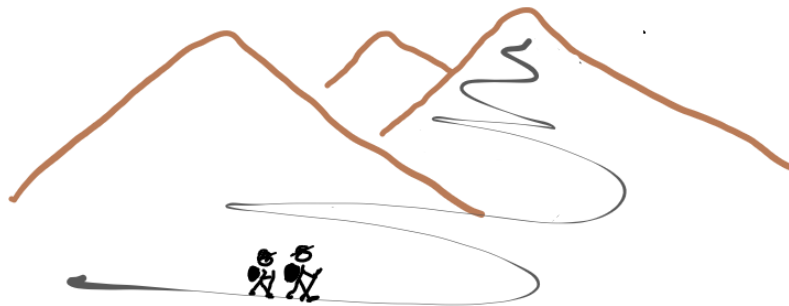

*And is almost **never** a straight line*

© 2021 Priyaa Varshinee

Chapter 1

Introduction

The programme of Categorical Quantum Mechanics (CQM) [47, 76] initiated by Abramsky and Coecke’s seminal paper [4] employs a graphical calculus to study quantum processes within the \dagger -compact closed category (\dagger -KCC) of finite dimensional Hilbert spaces (FHilb). From the perspective of logic, the graphical calculus is the proof theory of a compact fragment of multiplicative \dagger -linear logic [59]. Thus, CQM provides a novel approach to quantum mechanics with its use of a graphical calculus backed by the rigor of Categorical Proof Theory.

A well-known limitation of compact closed categories is that they model finite dimensional Hilbert spaces, but they do not model infinite dimensional spaces [74]. A categorical generalization of compact closed categories, in which infinite dimensional spaces can be modelled are $*$ -autonomous categories. This can be taken a step further by generalizing to linearly distributive categories (LDCs) in which the existence of dual objects is not assumed. These linear settings come with a proof theory (for non-compact multiplicative linear logic) which is a graphical calculus. Thus, one does not abandon this attractive feature of CQM in these more general settings. In fact, the graphical calculus of linearly distributive and $*$ -autonomous categories subsume the graphical calculus of compact closed categories. Thus, from a categorical perspective, an inviting direction to accommodate infinite dimensional quantum processes is to utilize $*$ -autonomous and linearly distributive categories as extensions of the compact closed settings used in CQM. The advantage of such a foundational approach is that it encompasses many of the earlier approaches and allows for a structural positioning of the different approaches.

The aim of this thesis is to lay the foundations of generalization in this direction. Towards this aim, the first part of this thesis develops the categorical proof theory of non-compact \dagger -linear logic using linearly distributive and $*$ -autonomous categories, and shows that one can always extract the usual settings for compact \dagger -linear logic from this new framework of

†-isomix categories. The first part also describes models for the new framework. The second part of this thesis explores the applicability of †-isomix categories to CQM and studying quantum processes of arbitrary dimensions.

1.1 From linear logic to quantum mechanics

1.1.1 Linear logic

Linear logic was introduced by Girard in [68] as a logic of resources manipulation. Unlike classical logic which treats logical statements as truth values, linear logic treats logical statements as resources which cannot be duplicated or destroyed. For example, consider the following statements, p and q :

$$\begin{aligned} p &: \text{to spend a dollar} \\ q &: \text{to buy an apple} \end{aligned}$$

Then, in linear logic, the compound statement “ $p \Rightarrow q$ ” has the meaning that if a dollar is spent then an apple can be bought. This means that a person can either have *a dollar* or *an apple* at a given time but not both. The word “linear” refers to this resource sensitivity of the logic: thus, a proof of a statement in linear logic may be regarded as a series of resource transformations.

The types (formulae) of linear logic can be defined inductively as follows (“|” is to be read as “or”):

$$\begin{aligned} A &:= p \mid A^\perp \\ &\mid A \otimes A \mid 1 \mid A \wp A \mid \perp \\ &\mid A \& A \mid \top \mid A \oplus A \mid 0 \\ &\mid !A \mid ?A \end{aligned}$$

In the inductive definition of A , p is an atomic formula such as “to spend a dollar” and p^\perp is the negation of the formula which in this case will be “to receive a dollar”. The **negation** is an involution, hence, $(p^\perp)^\perp = p$.

The connectives \otimes , 1 , \wp , and \perp are called the **multiplicatives**. A statement, $A \otimes B$ (read as *A tensor B*) allows the resources A and B to be available at the same time. For example, consider the statement r : *an orange*. Then, $p \Rightarrow q \otimes r$ refers to the fact that spending a dollar buys an apple and an orange at the same time. The formula 1 is the multiplicative truth, hence, $A \otimes 1 = 1 \otimes A = A$. The connective, \wp , read as *par*, is the

multiplicative disjunction and is dual to tensor. This means that, $(A^\perp \otimes B^\perp)^\perp = A \wp B$. Similarly, 1 and \top are duals to one another ($1^\perp = \top$).

The connectives $\&$, \top , \oplus , and 0 are called the **additives**. The statement, $A \& B$ (read as *A with B*), means that either A or B is available at a time. For example, the statement, $p \Rightarrow q \& r$, refers to the fact that spending a dollar buys either an apple or an orange with the freedom to choose either. In computer science $\&$, represents non-determinism. The formula 0 is the additive false: $A \wp 0 = 0 \wp A = A$. The additive disjunction \wp (read as the *plus*) and $\&$ are dual to one another. Similarly, 0 and \perp are duals.

Finally, the **exponential operators** - $!$ read as *of course* or *bang* and $?$ read as *why not* or *whimper* - allow for the duplication and destruction of resources. For any resource A , $!A$ models an *unlimited* store from which the resource A can be extracted 0 or more times. Moreover, the storage itself can be duplicated or even destroyed. The *why not* operator, $?$ encodes the notion of infinite demand, and is dual to the $!$, that is, $(?A)^\perp = !(A^\perp)$.

Interested readers can refer to [69, 68] for more details on linear logic.

1.1.2 Categorical semantics for linear logic

Linear logic, being a logic of resources, emphasizes the structure of proofs rather than provability, that is, one is more interested to know how a statement can be proved, rather than, merely if the statement is provable. Proofs in sequent calculus often contain extraneous details due the sequential nature of the calculus. For example, in a sequent proof, in order to apply a set of rules to a sequent, one must choose an order for the application of the rules, even if the rules are independent (that is, the order in which the rules are applied does not affect the final result).

In order to remove such unuseful information, Girard [68] introduced proof-nets to represent proofs of linear logic, specifically for the multiplicative fragment without units i.e., only the \otimes and \wp . Proof-nets are formalized as circuits. The study of algorithms to decide if a given circuit corresponds to a valid proof-net paved the way to the study of the categorical semantics for multiplicative linear logic (MLL). An overview of the categorical proof theories for different fragments of MLL is provided in the table below:

Linear logic fragment	Categorical proof theory
MLL	Linearly distributive categories [38]
MLL with negation	*-autonomous categories [14]
Compact MLL ($\otimes = \wp$, $1 = \perp$)	Monoidal categories [84]
Compact MLL with negation	Compact closed categories [85]

Table 1.1: Categorical semantics for multiplicative linear logic

The above listed semantics are sound and complete in the sense that there exists a one-to-one correspondence between the proof-nets of a fragment and the morphisms of its corresponding categorical setting. The proof-nets provide a graphical calculus to these categorical settings, thereby, enabling a string diagrammatic presentation of the morphisms in these categories.

The proof theory of compact MLL based on the graphical calculus of monoidal categories [109] is used to derive an elegant description of quantum mechanics [47, 76] .

1.1.3 Categorical quantum mechanics (CQM)

Traditionally, Hilbert spaces [102] or more generally von Neumann Algebras [56] are used as the mathematical framework of quantum mechanics [101] . While these frameworks support detailed computation, they do not support an intuition for the problem: this leads to an approach described as “shut up and calculate” [99]. The programme of Categorical Quantum Mechanics (CQM) [4, 47, 76] emerged out of the desire to develop a more intuitive framework to represent and reason about quantum processes.

Linear logic captures [106, 5, 4, 59, 31] the essence of quantum mechanics owing to its resource-sensitive character. In particular, linear logic does not allow duplication of an arbitrary type: in quantum mechanics, this is referred to as the *no-cloning theorem* [102] which states that it is impossible to duplicate an arbitrary quantum state. Motivated by this connection, CQM uses the compact multiplicative linear logic as the base framework for its purpose, and added the notion of ‘dagger’ to this fragment, thus giving rise to compact \dagger -linear logic. The ‘dagger’ abstracts the notion of ‘adjoint’ which is crucial to quantum mechanics: measurable properties of a quantum system are given by self-adjoint operators on a separable Hilbert space, that is, a Hilbert space with countable orthonormal basis.

While monoidal categories provide the semantics for compact MLL, \dagger -monoidal categories provide the categorical semantics for compact \dagger -linear logic. CQM uses \dagger -monoidal categories, specifically, \dagger -compact closed categories (See Chapter 6) to develop a high-level, intuitive, formal language for quantum mechanics by abstracting the standard, traditionally-used, analytical framework of Hilbert spaces, as illustrated in Figure 1.1.

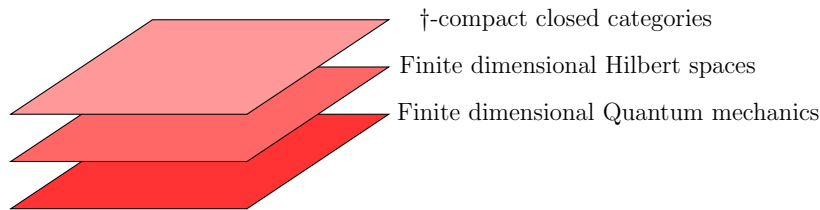
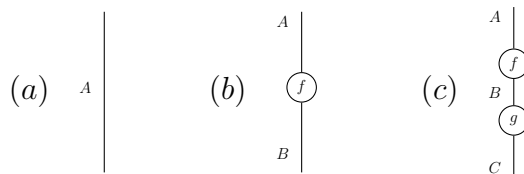
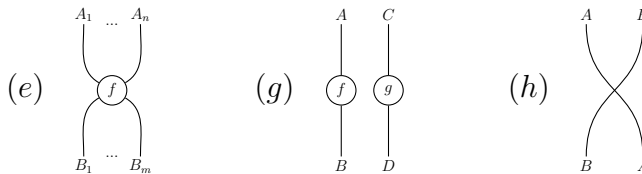

Figure 1.1: \dagger -compact closed categories for quantum mechanics

In 2004, Abramsky and Coecke [4] described the fundamental axioms of quantum mechanics within the framework of \dagger -compact closed categories (\dagger -KCCs). This was quite significant as it meant that the proof theory based on string diagrams of monoidal categories [109], could be deployed to reason about quantum processes. For example, in CQM, physical systems are represented as wires and processes as circles. The label of a wire represents its type. Diagram (a) represents a system A , and diagram (b) represents a transformation from system A to system B . Processes can be composed sequentially by connecting the wires with matching types. Note that the string diagrams are to be read from top to bottom (following the direction of gravity), and from left to right.



Moreover, the wires and the boxes can be composed in parallel leading to processes as shown in diagrams (e) and (f). Moreover, the wires are allowed to cross one another as shown in diagram (g).



It is far simpler to reason about processes using string diagrams since the human brain is good at processing visual information. For example, it is quite easy to see that the diagrams below represent the same process: one can prove the diagrams equal by fixing the ends of the wires and moving the circles.

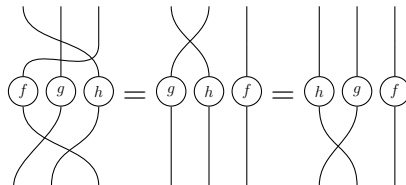

In compact closed categories, one can additionally bend wires into a cap and a cup as follows, thus adding to the expressive power of the language:



Around the same time that Coecke and Abramsky applied the graphical calculus of

monoidal categories to study quantum mechanics, Selinger used structures in monoidal categories for designing a quantum programming language [112]. In 2007, Selinger [110] refined and extended the framework of Abramsky and Coecke to account for mixed quantum states, and coined the term ‘Dagger(\dagger) compact closed categories’ for the categorical framework of quantum mechanics. The \dagger -compact closed categories faithfully abstract the structure of finite-dimensional Hilbert spaces, thereby enabling a diagrammatic but rigorous reasoning technique for quantum processes and protocols within the category of finite-dimensional Hilbert spaces and linear maps, \mathbf{FHilb} . The category of all Hilbert spaces and linear maps, \mathbf{Hilb} , is \dagger -monoidal but not compact closed.

1.1.4 Towards arbitrary dimensions in CQM

CQM has been applied to study problems in areas such as quantum foundations, quantum information theory and quantum computing. CQM techniques have been used to study causality [87, 43] and non-locality [51, 45] in quantum foundations. In quantum information theory, it has been used to construct structures like quantum Latin squares [100] which are crucial to many protocols in quantum information theory. Perhaps, the most significant outcome of CQM is in the field of quantum computation namely the ZX-calculus [44] which is a fine-grained diagrammatic calculus providing a set of generators and rewrite rules for designing and optimizing quantum circuits.

Because the compact closed setting is restricted to finite dimensional Hilbert spaces, practical applications of CQM, so far, have been limited to the areas such as quantum computing and quantum information theory which are off-shoots of finite dimensional quantum mechanics. This is because the base framework of CQM namely the compact closed categories impose finite dimensionality on the Hilbert Spaces [74]. Hence, the category of all Hilbert spaces is \dagger -monoidal and not \dagger -compact closed. The success of CQM in the study of finite-dimensional processes has inspired researchers to explore strategies for extending CQM to infinite dimensional processes.

One approach was to identify the algebraic structures which can characterize the key components of quantum mechanics without imposing any restriction on dimensionality. For example, in CQM, dagger Frobenius algebras (See Section 6.4.1) provide a precise algebraic characterization of quantum observables in the category of finite dimensional Hilbert Spaces [49] (A quantum observable is a measurable physical property of a quantum system).

With the aim of extending this idea to quantum observables of arbitrary dimensions, Abramsky and Heunen, in [6], showed how Ambrose’s H^* -algebras [8] could be used to characterize orthonormal bases, hence quantum observables, in infinite dimensional Hilbert spaces. However, the move from \dagger -Frobenius to H^* -algebras comes at a cost - an H^* -algebra

is modelled as a semi-Frobenius algebra, that is, Frobenius algebras without the units.

Gogioso and Genovese [70] proposed an interesting approach to reinstating the units using techniques from non-standard analysis [107]. They considered $\ast\mathbf{Hilb}$, the category of non-standard separable Hilbert Spaces and linear maps. This they claimed is a \dagger -compact closed category, in which, among other things, the semi-Frobenius algebras of Abramsky and Heunen can be modelled. Furthermore, the counit can be reinstated because formal infinite sums are permitted.

In [46], Coecke and Heunen, in order to model infinite dimensional quantum processes, took the simple step of dropping the requirement that the category is compact closed and worked in dagger symmetric monoidal categories (\dagger -SMCs). The category of all Hilbert spaces, \mathbf{Hilb} , is the prototypical example of a \dagger -SMC. In CQM, quantum processes are modelled as completely positive maps in the category of finite-dimensional Hilbert Spaces. Coecke and Heunen showed how to build a category of completely positive maps for an arbitrary \dagger -SMC. A downside of this approach is that by moving to \dagger -SMCs, one loses the structural richness provided by duals.

In [77], Heunen and Reyes considered a different \dagger -SMC, namely, the category of Hilbert \mathbb{C}^* -modules. Its objects can be equivalently viewed as bundles of Hilbert spaces over a locally compact Hausdorff space. They characterized the special commutative \dagger -Frobenius algebras in this category as bundles of finite dimensional Hilbert spaces (with dimensions that are uniformly bounded). These objects, while being far from finite, do retain a (uniform) locally finite nature. This example, by using vector bundles and ideas from differential geometry, enters the domain of traditional theoretical physics, and serves as a reminder that \dagger -Frobenius algebras are not only of interest for Hilbert spaces.

In [117], Vicary attempted to model a quantum harmonic oscillator, which is inherently an infinite-dimensional quantum system in \dagger -monoidal categories using free exponential modalities. He proposed a notion of \dagger -exponentials in \dagger -symmetric monoidal categories with \dagger -biproducts and used it to derive an abstract Fock Space and the ladder operators of Fock Spaces. He conjectured that the category of countable dimensional inner product spaces and everywhere-defined linear maps is a model for this categorical setting.

1.1.5 Non-compact multiplicative \dagger -linear logic

While various strategies have been tried for modelling systems of arbitrary dimensions, it is a general consensus in the CQM community, that the dimensionality constraint of the structures used in CQM is yet to be satisfactorily addressed. In this thesis, a different approach is taken by shifting focus beyond Hilbert spaces and other models, and by moving to non-compact \dagger -linear logic.

Rather than insisting that the infinite dimensional structures are concretely related to Hilbert spaces, it is considered that there may be a system of formal types which extend the existing compact logic of CQM. An example of such a setting is the embedding of the category of finite dimensional Hilbert spaces (which is \dagger -compact) into the (\dagger) - $*$ -autonomous category of Chu Spaces over complex vector spaces, $\mathbf{Chus}_{\mathbf{Vec}(\mathbb{C})}(I)$, where I , the tensor unit of $\mathbf{Vec}(\mathbb{C})$, is the dualizing object (See Section 3.4.3). Yet another example is the embedding of finite dimensional complex matrices into the (\dagger) - $*$ -autonomous category of finiteness spaces and finiteness matrices over complex numbers [64] (see Section 3.4.2).

We begin our explorations with linearly distributive categories (LDCs) and $*$ -autonomous categories rather than monoidal categories to first obtain a semantics for non-compact \dagger -linear logic. This idea is not new. Models for quantum mechanics in $*$ -autonomous categories are often described as “toy models” [2] and were, in particular discussed by Pavlovic [104] where some very similar directions were advocated. Indeed, Egger [61], in initiating the development of “involutive” categories, implicitly suggested that a dagger functor is not stationary ($A \neq A^\dagger$) on objects in an LDC setting.

1.1.6 Linearly distributive categories

Linearly distributive categories (LDCs) [38] provide the categorical semantics (so they are the proof theory) for the non-compact multiplicative fragment of linear logic (MLL) containing the \otimes , 1 , \wp , and \perp . The sequent rules for the multiplicatives are shown in Figure 1.2. In the linear logic community the multiplicative disjunction is often denoted by \wp , however this thesis follows the convention in [38] and shall use \oplus . Under the same convention, we write the unit of \otimes as top \top rather than 1 as in the linear logic community. The unit of \oplus is a bottom, \perp .

$$\begin{array}{c}
(\top L) \frac{\Gamma_1, \Gamma_2 \vdash \Delta}{\Gamma_1, \top, \Gamma_2 \vdash \Delta} \quad (\top R) \frac{}{\vdash \top} \\
(\otimes L) \frac{\Gamma_1, A, B, \Gamma_2 \vdash \Delta}{\Gamma_1, A \otimes B, \Gamma_2 \vdash \Delta} \quad (\otimes R) \frac{\Gamma_1 \vdash \Gamma_2, A, \Gamma_3 \quad \Delta_1 \vdash \Delta_2, B, \Delta_3}{\Gamma_1, \Delta_1 \vdash \Gamma_2, \Delta_2, A \otimes B, \Gamma_3, \Delta_3} \\
(\perp L) \frac{}{\perp \vdash} \quad (\perp R) \frac{\Gamma \vdash \Delta_1, \Delta_2}{\Gamma \vdash \Delta_1, \perp, \Delta_2} \\
(\oplus L) \frac{\Gamma_1, A, \Gamma_2 \vdash \Gamma_3 \quad \Delta_1, B, \Delta_2 \vdash \Delta_3}{\Gamma_1, \Delta_1, A \oplus B, \Gamma_2, \Delta_2 \vdash \Gamma_3, \Delta_3} \quad (\oplus R) \frac{\Gamma \vdash \Delta_1, A, B, \Delta_2}{\Gamma \vdash \Delta_1, A \oplus B, \Delta_2}
\end{array}$$

Figure 1.2: Sequent rules for multiplicatives

We assume that the sequent calculus is commutative (the order of premises and an-

tecedents does not matter). This is accommodated by the exchange rules which allows the neighboring premises and antecedents to be swapped:

$$(exch.L) \frac{\Gamma_1, A, B, \Gamma_2 \vdash \Delta}{\Gamma_1, B, A, \Gamma_2 \vdash \Delta} \quad (exch.R) \frac{\Gamma \vdash \Delta_1, C, D, \Delta_2}{\Gamma \vdash \Delta_1, D, C, \Delta_2}$$

Since LDCs are the proof theory of MLL, they come equipped with two distinct tensor products called the “tensor”, \otimes , and the “par”, \oplus corresponding to the multiplicative conjunction and disjunction of linear logic respectively. The tensor and the par are related by two natural transformations called linear distributors:

$$\partial^L : A \otimes (B \oplus C) \rightarrow (A \otimes B) \oplus C \quad \partial^R : (A \oplus B) \otimes C \rightarrow A \oplus (B \otimes C)$$

The distributors are not isomorphisms. The following is the sequent derivation of ∂^L :

$$\frac{\frac{\frac{}{B \oplus C \vdash B, C} id, \oplus L, cut}{A, B \oplus C \vdash A \otimes B, C} cut}{A \otimes (B \oplus C) \vdash (A \otimes B) \oplus C} (\otimes L), (\oplus R)$$

The multiplicative fragment with negation (A^\perp) has its categorical semantics in $*$ -autonomous categories. The sequent rules for negation allow premises to be flipped to the opposite side of the entailment:

$$(Neg.L) \frac{\Gamma, B^\perp \vdash \Delta}{\Gamma \vdash \Delta, B} \quad (Neg.R) \frac{\Gamma \vdash \Delta, B}{\Gamma, B^\perp \vdash \Delta}$$

Figure 1.3: Sequent rules for negation

In an LDC, negation of an object is given by its categorical dual. An object A has a dual A^\perp (negation of A) if there exists two maps, $\eta : \top \rightarrow A \oplus A^\perp$, and $A^\perp \otimes A \rightarrow \perp$ satisfying the ‘snake’ equations, see Definition 2.8. An LDC in which every object has a chosen dual is a $*$ -autonomous category [16], see Section 2.1.4. The following proofs show the derivations of the η and the ϵ maps respectively from the negation rules:

$$\begin{array}{c} \frac{\frac{}{A \vdash A} (id)}{\vdash A^\perp, A} Neg.R \\ \frac{\vdash A \oplus A^\perp}{\top \vdash A \oplus A^\perp} (\oplus R) \\ \frac{}{\top \vdash A \oplus A^\perp} (\top L) \\ \text{Proof for } \eta \end{array} \quad \begin{array}{c} \frac{\frac{}{A \vdash A} (id)}{A^\perp, A \vdash} Neg.L \\ \frac{}{A^\perp \otimes A \vdash} (\otimes L) \\ \frac{}{A^\perp \otimes A \vdash \perp} (\perp R) \\ \text{Proof for } \epsilon \end{array}$$

An **isomix category** is an LDC with an isomorphism, called the mix map, $m : \perp \rightarrow \top$, satisfying the ‘mix law’ [25, Definition 6.2], see Section 2.1.3. The mix law provides

a natural transformation, $\mathbf{mx} : A \otimes B \rightarrow A \oplus B$, from the multiplicative conjunction to the multiplicative disjunction, called the **mixor**, see Section 2.1.3. The mix law corresponds to the sequent rules shown in Figure 1.4 (a)-(b).

$$(a) \quad \frac{\Gamma \vdash \Delta \quad \Gamma' \vdash \Delta'}{\Gamma, \Gamma' \vdash \Delta, \Delta'} \quad (b) \quad \frac{}{\top \vdash \perp}$$

Figure 1.4: (a) Binary mix axiom (b) Nullary mix axiom

In the presence of the cut rule, the rule (a) is equivalent to the axiom $\perp \vdash \top$ [37, Lemma 6.1], see below.

$$\frac{\frac{\Gamma \vdash \Delta}{\Gamma \vdash \Delta, \perp} (\perp L) \quad \frac{}{\perp \vdash \top} id}{\Gamma \vdash \Delta, \top} cut \quad \frac{\Gamma' \vdash \Delta'}{\top, \Gamma' \vdash \Delta'} (\top L)}{\Gamma, \Gamma' \vdash \Delta, \Delta'} cut$$

Derivation of the binary mix axiom in the presence of the cut rule

In an isomix category, an object U for which the natural transformations, $\mathbf{mx}_{(-,U)}$ and $\mathbf{mx}_{(U,-)}$ are isomorphisms (that is for any object A , $A \otimes U \simeq A \oplus U$ and $U \otimes A \simeq U \oplus A$) is said to be in the **core** of the category. The core of an isomix category determined by such objects forms a full subcategory.

An isomix category in which the mixor is a natural isomorphism ($\otimes \simeq \oplus$) is called a **compact LDC**. The core of an isomix category is always a compact LDC. Compact LDCs are linearly equivalent to a monoidal categories. Conversely, **monoidal** categories [95] can be viewed as being degenerate compact LDCs in which the mixor is the identity map ($\otimes = \oplus$). A monoidal category in which every object has a dual, is a compact closed category [85]. From this perspective, a compact closed category can be viewed as a compact *-autonomous category.

1.2 Thesis outline

The aim of this thesis is to lay the categorical foundations for non-compact \dagger -linear logic and to apply it to categorical quantum mechanics. With this goal in mind, the thesis is divided into two parts:

Part 1: composed of chapters 2 - 5 is focused on developing the **categorical semantics** of non-compact \dagger -linear logic.

Part 2: composed of chapters 6 - 11, is focused on **developing structures for CQM** in the categorical setting developed in Part 1.

The rest of the section outlines the contents of this thesis and indicates the contributions.

1.2.1 Part I: Dagger linear logic

This first part begins with Chapter 2 which provides an introduction to LDCs and its variants, linear functors and transformations. This chapter also discusses the Ehrhard’s Finiteness spaces in detail, which is used as an example throughout this thesis. Chapters 3 and 4 chapters are derived from the article titled ‘Dagger linear logic for categorical quantum mechanics’ [34]: it was presented at the Symposium on Compositional Structures (SYCO I) in Birmingham (U.K.) and as a poster at the 15th international conference in Quantum Physics and Logic (QPL), Halifax, Canada. The contributions of chapters 3 and 4 are outlined below. Chapter 5 summarizes the first part of this thesis.

Dagger linearly distributive categories

It is standard in CQM to interpret the dagger as a contravariant functor which is stationary on objects ($A = A^\dagger$) and an involution for maps ($f^{\dagger\dagger} = f$). However, in an LDC with two tensor products - a tensor \otimes , and a par \oplus - the dagger has to flip the tensor and par so that $(A \oplus B)^\dagger = A^\dagger \otimes B^\dagger$. Without such a flip, daggering the linear distributor would produce a non-permissible map.

This implies that the dagger can no longer be viewed as being stationary on objects in an LDC. A non-stationary dagger implies that one has to address the coherence issues determining how the dagger interacts with the structures of an LDC. Moreover, one can replace the equality above by a natural isomorphism $\lambda_\otimes : A^\dagger \otimes B^\dagger \rightarrow (A \oplus B)^\dagger$, and the involution by a natural isomorphism $\iota_A : A \rightarrow A^{\dagger\dagger}$. We deal with these natural isomorphisms and define \dagger -LDC, \dagger -mix and \dagger -isomix categories in Section 3.1. The sequent calculus for \dagger -linear logic is discussed in Section 3.1.2.

Unitary isomorphisms for \dagger -isomix categories

In CQM, the dagger functor determines the notion of a unitary isomorphism which is an isomorphism $f : A \rightarrow B$ such that $f^\dagger = f^{-1}$. These isomorphisms are particularly important since they model the unitary evolution of a quantum system. Applying this idea directly to \dagger -LDCs is not feasible, because the maps, $f^{-1} : B \rightarrow A$ and $f^\dagger : B^\dagger \rightarrow A^\dagger$ now have different types, hence cannot be directly equal. However, minimally, if there exist isomorphisms, $\varphi_A : A \simeq A^\dagger$ and $\varphi_B : B \simeq B^\dagger$, then one can define a unitary isomorphism to be a map f satisfying the following commuting diagram:

$$\begin{array}{ccc} A & \xrightarrow{f} & B \\ \varphi_A \downarrow & & \downarrow \varphi_B \\ A^\dagger & \xleftarrow{f^\dagger} & B^\dagger \end{array}$$

Note that, in a \dagger -monoidal category, the isomorphisms φ_A and φ_B are simply the identity maps.

In a \dagger -isomix category, the isomorphism φ_A is referred to as a *unitary structure* map if A resides in the core, and behaves coherently with the natural isomorphisms of the category. In this case, A is referred to as unitary objects. The unitary objects of \dagger -isomix category forms a sub compact- \dagger -isomix category. Such a compact \dagger -isomix category in which every object is unitary is called a *unitary category*. Unitary categories are \dagger -linearly equivalent to a \dagger -monoidal categories. Moreover, when unitary categories have unitary duals, the category is \dagger -linearly equivalent to \dagger -compact closed categories. These ideas are developed in Section 4.1.

Unitary construction

Having defined the \dagger -LDCs and the unitary structure for \dagger -isomix categories, our next objective is to extract a unitary category, that is the traditional CQM setting, from any \dagger -isomix category. For this, one collects the ‘pre-unitary’ objects of a \dagger -isomix category. An object A is **pre-unitary** if A is in the core and there exists an isomorphism $\varphi_A : A \rightarrow A^\dagger$ and the isomorphism behaves coherently with the involutor ι as shown in the following commuting diagram:

$$\begin{array}{ccc} A & & \\ \varphi_A \downarrow & \searrow \iota & \\ A^\dagger & \xrightarrow{\varphi_A^{-1\dagger}} & A^{\dagger\dagger} \end{array}$$

The unitary category thus extracted using the ‘unitary construction’ is referred to as the **canonical unitary core** of the \dagger -isomix category. See Section 4.1.3 for details.

Mixed unitary categories

Collecting the structures we have developed so far, namely the \dagger -isomix categories and the unitary categories, we arrive at a general framework of ‘Mixed Unitary categories’ (MUCs). MUCs embed a unitary category in a larger \dagger -isomix category via a \dagger -isomix-functor from the unitary category to the core of the \dagger -isomix category:

$$M : \mathbb{U} \rightarrow \text{Core}(\mathbb{C}) \hookrightarrow \mathbb{C}$$

where \mathbb{U} is the unitary category and \mathbb{C} is the \dagger -isomix category. Thus, a MUC is a general framework which encompasses the traditional CQM framework within its core. The unitary category of a MUC acting on the larger \dagger -isomix category is analogous to a field K acting on a K -algebra as scalars. Sections 4.3 and 4.4 are dedicated towards developing these ideas.

1.2.2 Part II: Application to dagger linear logic to CQM

The second part of this thesis is concerned with applying the MUC framework to quantum mechanics. To this end, we generalize the key algebraic structures of CQM to the MUC setting and study the implications of this generalization.

This part begins with Chapter 6 which provides an introduction to \dagger -monoidal categories and the other key algebraic structures used by CQM. Chapter 7 is derived from my coauthored article titled ‘Complete positivity for Mixed Unitary Categories’ [40], which was presented as a talk at the QPL 2019 held in California, USA, and at SYCO II held in Glasgow, UK. Chapters 8 and 9 are derived from my coauthored paper titled ‘Exponential modalities and complementarity’ [39]. This work was presented at the 4th International Conference on Applied Category Theory held in July 2021. Chapter 10 presents examples for the structures introduced in Chapters 8 and 9. Chapter 11 summarizes the second part of the thesis.

The contributions of chapters 7 - 9 are outlined below.

Completely positive maps in MUCs

In a \dagger -monoidal settings, completely positive maps abstract the notion of quantum processes. Coecke and Heunen [46] developed the CP^∞ construction which produces the category of completely positive maps when applied to any \dagger -symmetric monoidal category. We define the completely positive maps and the CP^∞ construction for a MUC based on the Coecke and Heunen’s construction [46]. We also characterize the CP^∞ construction on MUCs using the notion of environment structures and purification. The characterization of CP^∞ construction for MUCs led to an elegant observation that it suffices for the unitary core to have environment maps to characterize the CP^∞ construction for MUCs. Chapter 7 covers this discussion.

Measurement in MUCs

Coecke and Pavlovic provided an algebraic description of quantum measurements in \dagger -monoidal categories [48]. In a MUC, measurement happens in two steps: first the system to be measured must be *compacted* into the unitary core (i.e., the traditional CQM core), and then the usual measurement process [48] as described by Coecke and Pavlovic must be applied within the core. In order to characterize the compaction process, we introduce *binary idempotents* and \dagger -binary idempotents. Compaction of an object in a \dagger -isomix category precisely corresponds to the splitting of certain \dagger -binary idempotents on the object, See Section 9.1. The \dagger -binary idempotents generalize Selinger’s [111] \dagger -idempotents in \dagger -monoidal categories which \dagger -splits to produce classical types.

Complementary systems in isomix categories

The notion of complementary observables is central to quantum mechanics. An observable is a measurable property of a quantum system. Two observables are complementary if measuring (knowing) the value of one observable increases the uncertainty of the value of the other. A classic example of complementary observables is the position and momentum of an electron.

In CQM, quantum observables are algebraically presented as special commutative \dagger -Frobenius algebras [49] in \dagger -monoidal categories. Moreover, complementary observables are two such \dagger -Frobenius algebras on the same object interacting bialgebraically to produce two Hopf algebras¹ [44].

In LDCs, linear monoids with a \otimes -monoid and a \oplus -monoid provide a general version of Frobenius algebras. In fact, Frobenius algebras in monoidal categories can be viewed as linear monoids satisfying an extra property. Linear monoids lead to the new notion of a “linear comonoid”, which can interact bialgebraically with a linear monoid to give a “linear bialgebra”. Using these structures in a (\dagger -)isomix category, one can define a complementary system as a (\dagger -)linear bialgebra satisfying a few extra equations. Chapter 8 is dedicated to developing linear comonoids and linear bialgebras. Complementary systems in isomix categories are described in Section 9.3.

Relating complementarity and exponential modalities

A final but a significant contribution of this thesis is to establish the connection between exponential modalities of linear logic and complementarity of quantum mechanics using our MUC framework. For this, we define ($!$, $?$)- \dagger -LDCs, i.e., a \dagger -LDC with exponential modalities, and also provide the sequent rules for the corresponding logic, see Sections 9.4.2, and 9.4.3. We prove that every complementary system in a (\dagger -)isomix category arises as a compaction of a (\dagger -)linear bialgebra induced on the **free** exponential modalities, see Section 9.4.

Chapter 12 concludes this thesis and discusses future directions.

1.3 Prerequisites

We assume that the reader has a basic understanding of category theory including the definition of categories, functors, natural transformations, duality, isomorphisms, and adjunctions. We refer the reader to a few excellent sources [9, 17, 32, 42, 12, 95], particularly, references [42, 12] are well-suited for someone with a Physics background while [32] is geared towards

¹This is often referred to as *strong* complementarity in CQM.

audience in computer science.

1.4 Notation

Composition is written in diagrammatic order: fg means apply f followed by g . The string diagrams are to be read from top to bottom (following the direction of gravity) and left to right.

Part I

Dagger Linear Logic

Chapter 2

Categorical semantics for linear logic

Linear logic [68] was introduced by Girard in 1987 as a resource sensitive logic in which logical statements were treated as resources. Hence, proving statements in linear logic involves manipulating these resources, most of which cannot be duplicated or destroyed. Linear logic has been considered to be the logic of quantum information theory due to its resource sensitivity [11, 59]. In this chapter, a categorical semantics of linear logic is reviewed using linearly distributive categories. We also provide an interpretation of the linear logic structures in finiteness spaces [64] which is used as a running example in the rest of the thesis.

2.1 Linearly Distributive Categories (LDCs)

Linearly distributive categories, introduced by Cockett and Seely [38] in 1997, provide a categorical semantics of Multiplicative Linear Logic (MLL). These categories were originally referred to as Weakly distributive categories and were later renamed to linearly distributive categories (LDCs).

2.1.1 Linearly distributive categories

Informally, a linearly distributive category is a category having two monoidal structures linked by a linear distributor. We first recall the definition of monoidal categories before moving on to LDCs:

Definition 2.1. A monoidal category $(\mathbb{X}, \otimes, I, a_\otimes, u_\otimes^l, u_\otimes^r)$ is a category, \mathbb{X} , consisting of:

- a bifunctor, $\otimes : \mathbb{X} \times \mathbb{X} \rightarrow \mathbb{X}$, called tensor product;
- a designated object, $I \in \mathbb{X}$, called the unit object;
- a natural isomorphism, $(a_\otimes)_{A,B,C} : A \otimes (B \otimes C) \xrightarrow{\cong} (A \otimes B) \otimes C$, called the associator;

- a natural isomorphism, $(u_\otimes^l)_A : I \otimes A \xrightarrow{\cong} A$, called the left unitor;
- a natural isomorphism, $(u_\otimes^r)_A : A \otimes I \xrightarrow{\cong} A$, called the right unitor;

such that the following coherence diagrams commute [84]:

- *Maclane's pentagon diagram:*

$$\begin{array}{ccc}
 & A \otimes (B \otimes (C \otimes D)) & \\
 \swarrow^{1 \otimes a_\otimes} & & \searrow^{a_\otimes} \\
 A \otimes ((B \otimes C) \otimes D) & & (A \otimes B) \otimes (C \otimes D) \\
 \downarrow^{a_\otimes} & & \downarrow^{a_\otimes} \\
 (A \otimes (B \otimes C)) \otimes D & \xrightarrow{a_\otimes \otimes 1} & ((A \otimes B) \otimes C) \otimes D
 \end{array}$$

- *Kelly's unit diagram:*

$$\begin{array}{ccc}
 (A \otimes I) \otimes B & \xrightarrow{u_\otimes^r \otimes 1_B} & (A \otimes B) \\
 \downarrow^{a_\otimes} & \searrow & \\
 A \otimes (I \otimes B) & \xrightarrow{1_A \otimes u_\otimes^l} & (A \otimes B)
 \end{array}$$

A monoidal category in which the associator, the left unitor and the right unitor are identity arrows is called a **strict monoidal category**.

A **symmetric monoidal category** (SMC) is a monoidal category with a natural isomorphism:

$$(c_\otimes)_{A,B} : A \otimes B \xrightarrow{\cong} B \otimes A$$

such that the following equations hold:

- (Hexagon law) $a_\otimes c_\otimes a_\otimes = (1 \otimes c_\otimes) a_\otimes (c_\otimes \otimes 1)$

$$\begin{array}{ccccc}
 A \otimes (B \otimes C) & \xrightarrow{a_\otimes} & (A \otimes B) \otimes C & \xrightarrow{c_\otimes} & C \otimes (A \otimes B) \\
 \downarrow^{1 \otimes c_\otimes} & & & & \downarrow^{a_\otimes} \\
 \otimes(C \otimes B) & \xrightarrow{a_\otimes} & (A \otimes C) \otimes B & \xrightarrow{a_\otimes (c_\otimes \otimes 1)} & (C \otimes A) \otimes B
 \end{array}$$

- (Inverse law) $(c_\otimes)_{A,B} = (c_\otimes)_{B,A}^{-1}$

$$\begin{array}{ccc}
 A \otimes B & & \\
 \downarrow^{(c_\otimes)_{A,B}} & \searrow & \\
 B \otimes A & \xrightarrow{(c_\otimes)_{A,B}} & A \otimes B
 \end{array}$$

- (Unit law) $c_{\otimes} u_{\otimes}^l = u_{\otimes}^r$

$$\begin{array}{ccc} A \otimes I & \xrightarrow{c_{\otimes}} & I \otimes A \\ & \searrow u^r & \downarrow u^l \\ & & A \end{array}$$

In an LDC, there exists two tensor products which are related by natural transformations called linear distributors:

Definition 2.2. [38] A **linearly distributive category**, $(\mathbb{X}, \otimes, \top, \oplus, \perp)$ is a category \mathbb{X} consisting of:

- a monoidal structure, $(\otimes, \top, a_{\otimes}, u_{\otimes}^L, u_{\otimes}^R)$
(\otimes is referred to as ‘the tensor’ and its unit, \top , ‘the top’)
- a monoidal structure, $(\oplus, \perp, a_{\oplus}, u_{\oplus}^L, u_{\oplus}^R)$
(\oplus is referred to as ‘the par’ and its unit, \perp , ‘the bottom’)
- The tensor and the par are related by the following natural transformations which are called the left and the right linear **distributors** respectively:

$$\partial^l : A \otimes (B \oplus C) \rightarrow (A \otimes B) \oplus C$$

$$\partial^r : (A \oplus B) \otimes C \rightarrow A \oplus (B \otimes C)$$

satisfying the following coherence conditions:

- The associators and the unitors for the \otimes and the \oplus satisfy MacLane’s pentagon diagram and Kelly’s unit diagram, See Definition 2.1.
- Coherence conditions for unit natural transformations and linear distributors:

LDC. 1 (a) $\partial^l(u_{\otimes}^l \oplus 1_B) = u_{\otimes}^l$

$$\begin{array}{ccc} \top \otimes (A \oplus B) & & \\ \partial^l \downarrow & \searrow u_{\otimes}^l & \\ (\top \otimes A) \oplus B & \xrightarrow{u_{\otimes}^l \oplus 1_B} & A \oplus B \end{array}$$

(b) $u_{\otimes}^r = \partial^r; 1 \oplus u_{\otimes}^l$

(c) $\partial^r u_{\oplus}^l = u_{\oplus}^l \otimes 1_B$

$$(d) 1 \otimes u_{\oplus}^r = \partial^l; u_{\oplus}^l$$

$$\begin{array}{ccc} (\perp \oplus A) \otimes B & \xrightarrow{\partial^r} & \perp \oplus (A \otimes B) \\ & \searrow^{u_{\oplus}^l \otimes 1_B} & \downarrow u_{\oplus}^l \\ & & A \otimes B \end{array}$$

- *Coherences for associativity natural transformations and the distributors:*

$$\text{LDC. 2 (a) } a_{\otimes}(1_A \otimes \partial^l)\delta^l = \delta^l(a_{\otimes} \oplus 1_D)$$

$$\begin{array}{ccc} (A \otimes B) \otimes (C \oplus D) & \xrightarrow{a_{\otimes}} & A \otimes (B \otimes (C \oplus D)) \\ \downarrow \partial^l & & \downarrow 1_A \otimes \partial^l \\ & & A \otimes ((B \otimes C) \oplus D) \\ & & \downarrow \partial^l \\ ((A \otimes B) \otimes C) \oplus D & \xrightarrow{a_{\otimes} \oplus 1_D} & (A \otimes (B \otimes C)) \oplus D \end{array}$$

$$(b) \partial^l(a_{\otimes} \oplus 1) = a_{\otimes}(1 \otimes \partial^l)\partial^l$$

$$(c) \partial^r a_{\oplus} = (a_{\oplus} \otimes 1_D)\partial^r(1_A \otimes \partial^r)$$

$$(d) (1 \otimes a_{\oplus})\partial^l = \partial^l(1 \oplus \partial^l)a_{\oplus}$$

- *Coherences between the left and the right linear distributors:*

$$\text{LDC. 3 (a) } \partial^r(1_A \oplus \partial^l) = \partial^l(\partial^r \oplus 1_D)a_{\otimes}$$

$$\begin{array}{ccc} & (A \oplus B) \otimes (C \oplus D) & \\ \swarrow \partial^l & & \searrow \partial^r \\ ((A \oplus B) \otimes C) \oplus D & & A \oplus (B \otimes (C \oplus D)) \\ \downarrow \partial^r \oplus 1_D & & \downarrow 1_A \oplus \partial^l \\ (A \oplus (B \otimes C)) \oplus D & \xrightarrow{a_{\otimes}} & A \oplus ((B \otimes C) \oplus D) \end{array}$$

$$(b) a_{\otimes}(1 \otimes \partial^r)\partial^l = (\partial^l \otimes 1)\partial^r$$

A **symmetric LDC** is an LDC in which both the tensor products are symmetric, with symmetry maps c_{\otimes} and c_{\oplus} , such that $\partial^R = c_{\otimes}(1 \otimes c_{\oplus})\partial^L(c_{\otimes} \oplus 1)c_{\oplus}$. For a symmetric LDC, the left linear distributor determines the right linear distributor and vice versa.

Linearly distributive categories (LDCs) provide a categorical semantics for Multiplicative Linear Logic (MLL). The two tensor products, \otimes and \oplus , in an LDC corresponds to the multiplicative conjunction and multiplicative disjunction in linear logic respectively.

The following are some examples of LDCs:

- Every monoidal category is also an LDC where the tensor and the par coincide, and the distributor is the associator natural isomorphism. An LDC with the linear distributors being isomorphisms is not necessarily monoidal. The next two examples elucidate the point.
- A **bounded distributive lattice** is a lattice $(L, \leq, \wedge, \top, \vee, \perp)$ with a greatest element, \top , and a least element, \perp , such that for all $a \in L$, $\perp \leq a \leq \top$, and the join (\wedge) and meet (\vee) operations distribute over one another:

$$a \wedge (b \vee c) = (a \wedge b) \vee (a \wedge c) \quad a \vee (b \wedge c) = (a \vee b) \wedge (a \vee c)$$

A distributive lattice regarded as a category whose objects are lattice elements and the maps given by the preorder, is an LDC. The tensor is given by \wedge with unit object \top , and the par is given by \vee with unit object \perp . Both the tensor products are symmetric. The right linear distributor is given as follows:

$$(a \vee b) \wedge c = (a \wedge c) \vee (b \wedge c) \leq a \vee (b \wedge c)$$

Any Boolean algebra is an example of a distributive lattice.

- Let M be any set. A **shift monoid** is a commutative monoid, $(M, +, 0)$ with a designated element s such that there exists an inverse to s i.e, $s - s = 0$. A second multiplication can be defined on the set M as follows: for all $x, y \in M$, $x \circ y = (x + y) - s$. The unit of the second multiplication is s . A shift monoid considered as a discrete category (the elements of the monoid are the objects and the maps are identity maps) is an LDC with $\otimes := +$, and $\oplus := \circ$. The unit objects are given by the units of the respective multiplications. The linear distributor is given by the following equality:

$$x \circ (y + z) := (x + (y + z)) - s = ((x + y) - s) + z = (x \circ y) + z$$

Note that the distributors are identity maps but \otimes and \oplus are distinct.

- $*$ -autonomous categories are LDCs with a dualizing object. See Section [2.1.4](#).
- The category of bialgebra modules and module homomorphisms of a $*$ -autonomous category is an LDC. The tensor products are inherited from the base category [\[38\]](#). The category of Hopf modules and module homomorphisms from a $*$ -autonomous category is $*$ -autonomous [\[103\]](#). We discuss the category of Hopf Modules in section [3.4.4](#).

- Girard’s Coherence spaces [68], Ehrhard’s finiteness spaces [64], and Chu Spaces [18] are linearly distributive categories that are also $*$ -autonomous. Indeed, \mathbf{FRel} , the category of finiteness spaces and finiteness relations, and $\mathbf{FMat}(\mathbb{C})$, the category of finiteness spaces and finiteness matrices are used as primary examples for structures introduced in this thesis. See Section 2.3 for discussion of these categories.
- Bicompleting a monoidal category (adding arbitrary limits and colimits) gives an LDC. A procedure for bicompletion of monoidal categories has been described by Joyal in [82]. Joyal also proved in the same article that if the base category is compact closed, then the resulting category is $*$ -autonomous.

2.1.2 Graphical calculus

LDCs come equipped with a graphical calculus [30] that contains the calculus for monoidal categories. Every sequent rule and derivation in MLL corresponds to a circuit in the graphical calculus of LDCs, and vice versa. In this section, we review the fundamentals of the graphical calculus for LDCs. For detailed exposition, see [30, 38]. The following are the generators of LDC circuits: wires represent objects and circles represent maps. The input wires of a map are tensored (with \otimes), and the output wires are “par”ed (with \oplus). The following diagram represents a map $f : A \otimes B \rightarrow C \oplus D$.

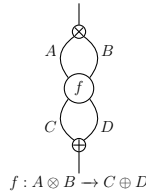

The \otimes -associator, the \oplus -associator, the left linear distributor, and the right linear distributors are, respectively, drawn as follows:

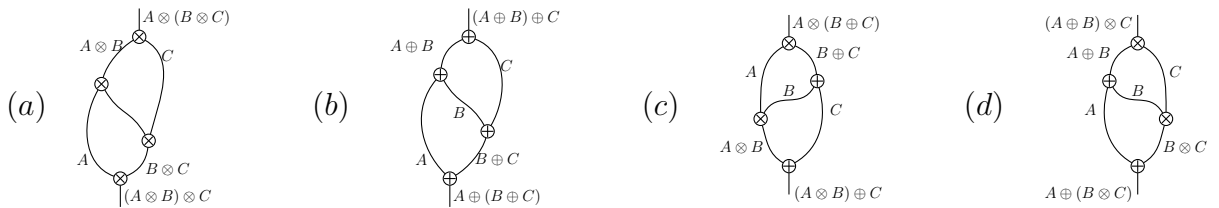

$\begin{array}{c} \cup \\ \oplus \end{array}$ is the \oplus -introduction ($\oplus I$) rule, $\begin{array}{c} \cup \\ \otimes \end{array}$ is \otimes -introduction ($\otimes I$) rule, $\begin{array}{c} \otimes \\ \cup \end{array}$ is the \otimes -elimination ($\otimes E$) rule, $\begin{array}{c} \oplus \\ \cup \end{array}$ is the \oplus -elimination ($\oplus E$) rule. As shown below, the rules, ($\otimes I$) and ($\otimes E$), correspond to the sequent rules for tensor introduction, $\otimes L$ and $\otimes R$ in

Figure 1.2:

$$\frac{\Gamma, A, B, \Gamma' \vdash \Delta}{\Gamma, A \otimes B, \Gamma' \vdash \Delta} (\otimes L) \quad \frac{\Gamma_1 \vdash \Gamma_2, A, \Gamma_3 \quad \Delta_1 \vdash \Delta_2, B, \Delta_3}{\Gamma_1, \Delta_1 \vdash \Gamma_2, \Delta_2, A \otimes B, \Gamma_3, \Delta_3} (\otimes R)$$

Similarly, $\oplus I$ and $\oplus E$ correspond to $\oplus L$ and $\oplus R$ respectively, see Figure 1.2.

The unitors are drawn as follows:

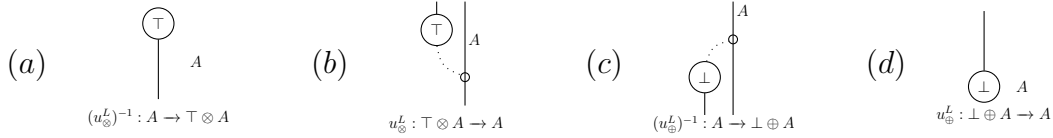
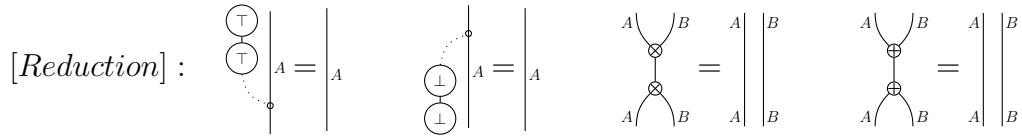
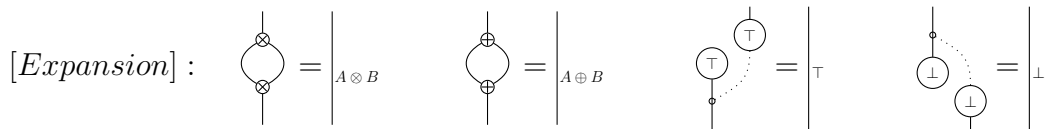

Diagram (a) is called the left \top -introduction, (b) is called the left \top -elimination, (c) is the left \perp -introduction, and (d) is the left \perp -elimination which correspond to the sequent rules $(\top R)$, $(\top L)$, $(\perp R)$, $(\perp L)$ in Figure 1.2 respectively. The unit \top is introduced, and the counit \perp is eliminated using the thinning links which are shown using dotted wires in the diagrams. See [30, Section 2.3] for details on the thinning links.

The following are a set of circuit equalities (which when oriented become reduction rewrite rules):



The following are also circuit equalities (and when oriented become expansion rules):



As in linear logic, not all circuit diagrams constructed from these basic components represent a valid LDC circuit. In his seminal paper on linear logic, [68], Girard introduced a criterion for the correctness of his representation of proofs using proof nets based on switching links. A valid proof structure must be connected and acyclic for all the switching link choices. Using this correctness criterion has the disadvantage of requiring exponential time in the number of switching links. Danos and Regnier [54] improved this situation significantly by providing an algorithm for correctness which takes linear time (see [72]) on the size of the circuit. To verify the validity of the circuit diagrams of LDCs, Blute et.al. [30], provided a boxing algorithm which was based on Danos and Regnier's more efficient algorithm which we now describe.

In order to verify that an LDC circuit is valid, circuit components are “boxed” using the rules below. The primitive generating maps are automatically boxed.

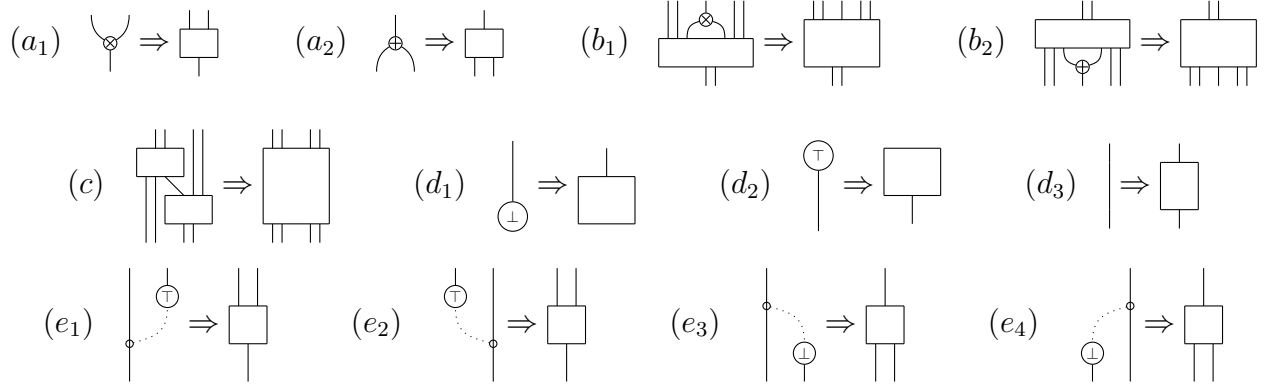

Double lines refer to multiple number of wires. The boxes contain circuit components including maps. \otimes -introduction and \oplus -elimination are boxed in (a_1) and (a_2) respectively. In (b_1) , it is shown how a box ‘eats’ the \otimes -elimination: in (b_2) the dual rule shows a \oplus -introduction being eaten. (c) shows how boxes can be amalgamated when they are connected by a single wire. \perp -elimination, \top -introduction, and identity maps are boxed in (d_1) , (d_2) , and (d_3) respectively. In (e_1) - (e_4) , it is shown how the thinning links can be boxed. By progressively enclosing the components of the circuit in boxes using these rules, if we end up with a single box (or a wire), precisely when the circuit is valid. As an example, we verify the validity of the left linear distributor:

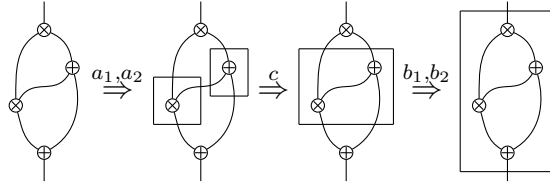

In the first step the \otimes -introduction and \oplus -elimination are boxed. In the second step the boxes are amalgamated along the single wire joining them. In the third step, the box absorbs the \otimes -elimination and \oplus -introduction.

In contrast, we now show that the reverse of the linear distributor is invalid as the boxing process gets stuck (there are no rules to box \otimes -elimination and \oplus -introduction):

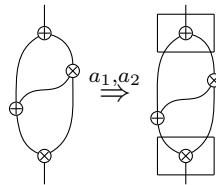

2.1.3 Mix, isomix and compact LDCs

In this thesis, we are predominately concerned with LDCs which have a mix map:

Definition 2.3. [37] *A mix category is an LDC with a mix map $m : \perp \rightarrow \top$ such that:*

$$\begin{array}{ccccc}
 A \otimes B & \xrightarrow{1 \otimes u_{\oplus}^{L^{-1}}} & A \otimes (\perp \oplus B) & \xrightarrow{1 \otimes (m \oplus 1)} & A \otimes (\top \oplus B) \\
 (u_{\oplus}^R)^{-1} \otimes 1 \downarrow & & & \searrow^{mx_{A,B}} & \downarrow \partial^L \\
 (A \oplus \perp) \otimes B & & & & (A \otimes \top) \oplus B \\
 \partial^R \downarrow & & & & \downarrow u_{\otimes}^R \oplus 1 \\
 A \oplus (\perp \otimes B) & \xrightarrow{1 \oplus (m \otimes 1)} & A \oplus (\top \otimes B) & \xrightarrow{1 \oplus u_{\otimes}^L} & A \oplus B
 \end{array}$$

The map $mx_{A,B}$ is a natural transformation and is called the **mixmap**. The coherence condition for the mix map has the following form in string diagrams (where the mix map is represented by an empty box):

$$mx_{A,B} := \begin{array}{c} \text{---} \otimes \text{---} \\ \text{---} \oplus \text{---} \\ \text{---} \otimes \text{---} \end{array} = \begin{array}{c} \text{---} \otimes \text{---} \\ \text{---} \oplus \text{---} \\ \text{---} \otimes \text{---} \end{array}$$

In a mix category, the associator, the distributor and the mix maps interact as follows. See Lemma 2, and proposition 3 in [25] for a proof.

$$\begin{array}{ccc}
 \text{[mix.]} & (A \oplus B) \otimes C \xrightarrow{\delta^R} A \oplus (B \otimes C) & (A \otimes B) \otimes C \xrightarrow{mx} A \oplus (B \otimes C) \\
 & \downarrow mx \quad (a) \quad \downarrow 1 \oplus mx & \downarrow a_{\otimes} \quad (b) \quad \uparrow \delta^L \\
 & (A \oplus B) \oplus C \xrightarrow{a_{\oplus}} A \oplus (B \oplus C) & A \otimes (B \otimes C) \xrightarrow{1 \otimes mx} A \otimes (B \oplus C) \\
 \\
 & C \otimes (A \oplus B) \xrightarrow{\delta^L} (C \otimes A) \oplus B & A \otimes (B \otimes C) \xrightarrow{mx} A \oplus (B \otimes C) \\
 & \downarrow mx \quad (c) \quad \downarrow mx \oplus 1 & \downarrow a_{\otimes}^{-1} \quad (d) \quad \uparrow \delta^R \\
 & C \oplus (A \oplus B) \xrightarrow{a_{\oplus}^{-1}} (C \oplus A) \oplus B & (A \otimes B) \otimes C \xrightarrow{mx \otimes 1} (A \oplus B) \otimes C
 \end{array}$$

There are many examples of mix categories including coherence spaces [68], and finiteness spaces [64].

Definition 2.4. *An LDC with a mix map, $m : \perp \rightarrow \top$ which is an isomorphism is said to be an isomix category.*

When m is an isomorphism, the coherence requirement for the mixmap is automatically satisfied (see [37, Lemma 6.6]). Moreover, the mix map, m , being an isomorphism does not imply that the mixmap, mx , is an isomorphism. Finiteness spaces [64] and Chu spaces with the tensor unit as the dualizing object [18] provide examples of isomix categories.

Definition 2.5. A compact LDC is an isomix category in which each mixor, $\text{mx}_{A,B}$ is an isomorphism.

An important way in which compact LDCs arise is from the “core” of an isomix category

Definition 2.6. [25] An object U is in the **core** of a mix category if and only if the following natural transformations are isomorphisms:

$$U \otimes (-) \xrightarrow{\text{mx}_{U,(-)}} U \oplus (-) \quad \text{and} \quad (-) \otimes U \xrightarrow{\text{mx}_{(-),U}} (-) \oplus U$$

Therefore, the core of a mix category, $\text{Core}(\mathbb{X}) \subseteq \mathbb{X}$, is the full subcategory of \mathbb{X} with the mixor being an isomorphism. It follows that $\text{Core}(\mathbb{X})$ is a compact LDC.

Proposition 2.7. [25, Proposition 3] If \mathbb{X} is a mix-LDC and $A, B \in \text{Core}(\mathbb{X})$ then $A \oplus B$ and $A \otimes B \in \text{Core}(\mathbb{X})$ (and $A \oplus B \simeq A \otimes B$). If \mathbb{X} is an isomix-LDC, then $\top, \perp \in \text{Core}(\mathbb{X})$.

A monoidal category is a compact LDC with the mix, and the mixor maps coinciding with the identity. Hence, the tensor and the par coincide in a monoidal category. In fact, any compact LDC is linearly equivalent to a monoidal category. A detailed description of this linear equivalence is given in the section on linear functors and transformations.

The following schematic diagram summarizes different properties of LDCs:

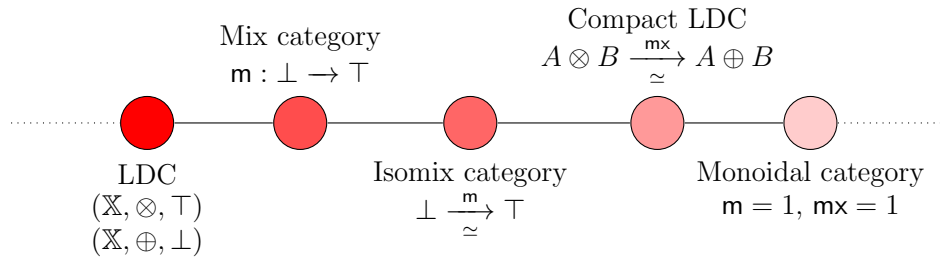

Figure 2.1: Schematic diagram of LDC properties

2.1.4 *-autonomous categories

A key notion in the theory of LDCs is the notion of a linear adjoint [35]. Here we shall refer to linear adjoints as “duals” in order to avoid any confusion with an adjunction of linear functors.

Definition 2.8. Suppose \mathbb{X} is a LDC and $A, B \in \mathbb{X}$, then B is **left dual** (or **left linear adjoint**) to A – or A is **right dual** (right linear adjoint) to B – written $(\eta, \epsilon) : B \dashv A$, if

there exists a unit map, $\eta : \top \rightarrow B \oplus A$ and a counit map, $\epsilon : A \otimes B \rightarrow \perp$ such that the following diagrams commute:

$$\begin{array}{ccc}
 B \xrightarrow{(u_{\otimes}^L)^{-1}} \top \otimes B \xrightarrow{\eta \otimes 1} (B \oplus A) \otimes B & & A \xrightarrow{(u_{\otimes}^R)^{-1}} A \otimes \top \xrightarrow{1 \otimes \eta} A \otimes (B \oplus A) \\
 \parallel & & \parallel \\
 B \xleftarrow{u_{\oplus}^R} B \oplus \perp \xleftarrow{1 \oplus \epsilon} B \oplus (A \otimes B) & & A \xleftarrow{u_{\oplus}^L} \perp \oplus A \xleftarrow{\epsilon \oplus 1} (A \otimes B) \oplus A
 \end{array}$$

The unit map unit and the counit maps of a dual are drawn in string diagrams as a cap and a cup:

$$\eta := \begin{array}{c} \eta \\ \text{cap} \end{array} \quad \text{and} \quad \epsilon := \begin{array}{c} \text{cup} \\ \epsilon \end{array}$$

The commuting diagrams are called often referred to as “snake diagrams” because of their shape in graphical calculus:

$$\begin{array}{c} \eta \\ \text{snake} \end{array} = \left| \begin{array}{c} \eta \\ \text{cup} \end{array} \right. \quad \begin{array}{c} \text{cup} \\ \eta \end{array} = \left| \begin{array}{c} \eta \\ \text{cup} \end{array} \right.$$

The linear distributor is hidden in the above circuit diagrams due to the use to circuit expansion, and circuit reduction rules, see Section 2.1.2.

Lemma 2.9. [25]

- (i) In an LDC if $(\eta, \epsilon) : B \dashv A$ and $(\eta', \epsilon') : C \dashv A$, then B and C are isomorphic;
- (ii) In a symmetric LDC $(\eta, \epsilon) : B \dashv A$ if and only if $(\eta c_{\oplus}, c_{\otimes} \epsilon) : A \dashv B$;
- (iii) In a mix category if $B \in \text{Core}(\mathbb{X})$ and $B \dashv A$, then $A \in \text{Core}(\mathbb{X})$.

In a monoidal category, duals coincide with the usual notion of duals. Next we define the homomorphism of duals:

Definition 2.10. A homomorphism of duals, $(f, f') : (\eta, \epsilon) \rightarrow (\tau, \gamma)$, is given by a pair of maps

$$\begin{array}{ccc}
 A & \xrightarrow{(\eta, \epsilon)} & B \\
 \downarrow f & & \uparrow f' \\
 A' & \xrightarrow{(\tau, \gamma)} & B'
 \end{array}$$

such that the following equations hold:

$$(a) \quad \begin{array}{c} \tau \\ \text{cup} \end{array} = \begin{array}{c} \eta \\ \text{cup} \end{array} \quad (b) \quad \begin{array}{c} \text{cup} \\ \gamma \end{array} = \begin{array}{c} \text{cup} \\ \epsilon \end{array}$$

$$\begin{array}{ccc}
(A \otimes B)^* & \xrightarrow{\psi} & *(A \otimes B) \\
\downarrow & \text{[C.4]} & \downarrow \\
(B^* \oplus A^*) & \xrightarrow{\psi \oplus \psi} & *B \oplus *A
\end{array}
\qquad
\begin{array}{ccc}
(A \oplus B)^* & \xrightarrow{\psi} & *(A \oplus B) \\
\downarrow & \text{[C.5]} & \downarrow \\
(B^* \otimes A^*) & \xrightarrow{\psi \otimes \psi} & *B \otimes *A
\end{array}$$

A $*$ -autonomous category with a cyclor is said to be **cyclic**.

The coherence conditions are not independent of each other: being cyclic is equivalent to any one of the following four pairs of coherences: ([C.1], [C.5]), ([C.2], [C.5]), ([C.4], [C.2]) and ([C.4], [C.3]) [63].

Condition [C.2] which is used extensively in Section 3.3 is represented graphically as follows:

The maps in [C.2] are invertible:

Symmetric $*$ -autonomous categories always have a canonical cyclor:

We shall use the cyclor in Section 3.3 to show how conjugation and dagger are related in the presence of dualization.

2.2 Linear functors and transformations

Functors between LDCs are referred to as linear functors [36]. Following the same pattern that LDCs generalize monoidal categories, linear functors generalize monoidal functors. Moreover, these general functors also account for the structures in linear logic such as exponential modalities (!, ?) and additive connectives (+, &) which are linear functors satisfying additional properties.

2.2.1 Linear functors and transformations

In order to introduce linear functors, we first recall the definition of monoidal functors. A functor $F : \mathbb{X} \rightarrow \mathbb{Y}$ between monoidal categories is a monoidal functor if its equipped with natural transformations $m_\otimes : F(A) \otimes F(B) \rightarrow F(A \otimes B)$ and $m_I : I \rightarrow F(I)$ such that the following diagrams commute:

$$\begin{array}{ccccc} (F(A) \otimes F(B)) \otimes F(C) & \xrightarrow{m_\otimes \otimes 1} & F(A \otimes B) \otimes F(C) & \xrightarrow{m_\otimes} & F((A \otimes B) \otimes C) \\ a_\otimes \downarrow & & & & \downarrow F(a_\otimes) \\ F(A) \otimes (F(B) \otimes F(C)) & \xrightarrow{1 \otimes m_\otimes} & F(A) \otimes F(B \otimes C) & \xrightarrow{m_\otimes} & F(A \otimes (B \otimes C)) \end{array}$$

$$\begin{array}{ccc} F(A) \otimes I & \xrightarrow{u_\otimes^R} & \\ 1 \otimes m_I \downarrow & & \\ F(A) \otimes F(I) & \xrightarrow{m_\otimes} & F(A \otimes I) \xrightarrow{F(u_\otimes^L)} F(A) \end{array} \qquad \begin{array}{ccc} I \otimes F(A) & \xrightarrow{u_\otimes^L} & \\ m_I \otimes 1 \downarrow & & \\ F(I) \otimes F(A) & \xrightarrow{m_\otimes} & F(I \otimes A) \xrightarrow{F(u_\otimes^L)} F(A) \end{array}$$

The first diagram for the monoidal functor is the associative law, and the other two diagrams are the right and the left unit laws respectively. Dually, a functor $(F, n_\otimes, n_I) : \mathbb{X} \rightarrow \mathbb{Y}$ between monoidal categories is comonoidal if $(F, n_\otimes, n_I) : \mathbb{X}^{\text{op}} \rightarrow \mathbb{Y}^{\text{op}}$ is monoidal. Monoidal functors preserve monoids and the comonoidal functors preserve comonoids.

Definition 2.13. [36, Definition 1] *Given linearly distributive categories \mathbb{X} and \mathbb{Y} , a **linear functor** $F : \mathbb{X} \rightarrow \mathbb{Y}$ consists of*

- (i) *a pair of functors $F = (F_\otimes, F_\oplus) ; (F_\otimes, m_\otimes, m_\top) : \mathbb{X} \rightarrow \mathbb{Y}$ which is monoidal with respect to \otimes and $(F_\oplus, n_\oplus, n_\perp) : \mathbb{X} \rightarrow \mathbb{Y}$ which is comonoidal with respect to \oplus . We refer to m_\otimes and n_\oplus as **tensor laxors**, and m_\top and n_\perp as **unit laxors**.*

- (ii) *natural transformations:*

$$\begin{aligned} \nu_\otimes^R &: F_\otimes(A \oplus B) \rightarrow F_\oplus(A) \oplus F_\otimes(B) \\ \nu_\otimes^L &: F_\otimes(A \oplus B) \rightarrow F_\otimes(A) \oplus F_\oplus(B) \\ \nu_\oplus^R &: F_\otimes(A) \otimes F_\oplus(B) \rightarrow F_\oplus(A \otimes B) \\ \nu_\oplus^L &: F_\oplus(A) \otimes F_\otimes(B) \rightarrow F_\oplus(A \otimes B) \end{aligned}$$

such that the following coherence conditions hold:

[LF.1] (a) $F_{\otimes}(u_{\oplus}^L) = \nu_{\otimes}^R(n_{\perp} \oplus 1)u_{\oplus}^L$

$$\begin{array}{ccc} F_{\otimes}(\perp \oplus A) & \xrightarrow{F_{\otimes}(u_{\oplus}^L)} & F_{\otimes}(A) \\ \nu_{\otimes}^R \downarrow & & \uparrow u_{\oplus}^L \\ F_{\oplus}(\perp) \oplus F_{\otimes}(A) & \xrightarrow{n_{\perp} \oplus 1} & \perp \oplus F_{\otimes}(A) \end{array}$$

(b) $\nu_{\otimes}^L(1 \oplus n_{\perp})u_{\oplus}^R = F_{\otimes}(u_{\oplus}^R)$

(c) $(u_{\otimes}^L)^{-1}(m_{\top} \otimes 1)\nu_{\oplus}^R = F_{\oplus}((u_{\otimes}^L)^{-1})$

(d) $(u_{\otimes}^R)^{-1}(m_{\top} \otimes 1)\nu_{\oplus}^L = F_{\oplus}((u_{\otimes}^R)^{-1})$

[LF.2] (a) $F_{\otimes}(a_{\oplus})\nu_{\otimes}^R(1 \oplus \nu_{\otimes}^R) = \nu_{\otimes}^R(n_{\oplus} \oplus 1)a_{\oplus}$

$$\begin{array}{ccc} F_{\otimes}((A \oplus B) \oplus C) & \xrightarrow{F_{\otimes}(a_{\oplus})} & F_{\otimes}(A \oplus (B \oplus C)) \\ \nu_{\otimes}^R \downarrow & & \downarrow \nu_{\otimes}^R \\ F_{\oplus}(A \oplus B) \oplus F_{\otimes}(C) & & F_{\oplus}(A) \oplus F_{\otimes}(B \oplus C) \\ n_{\oplus} \oplus 1 \downarrow & & \downarrow 1 \oplus \nu_{\otimes}^R \\ (F_{\oplus}(A) \oplus F_{\oplus}(B)) \oplus F_{\otimes}(C) & \xrightarrow{a_{\oplus}} & F_{\oplus}(A) \oplus (F_{\oplus}(B) \oplus F_{\otimes}(C)) \end{array}$$

(b) $F_{\otimes}(a_{\oplus})\nu_{\otimes}^L(1 \oplus n_{\oplus}) = \nu_{\oplus}^L(\nu^L \oplus 1)a_{\oplus}$

(c) $(m_{\otimes} \otimes 1)\nu_{\oplus}^R F_{\oplus}(a_{\otimes}) = a_{\otimes}(1 \otimes \nu_{\oplus}^R)\nu_{\oplus}^R$

(d) $(\nu_{\oplus}^R \otimes 1)\nu_{\oplus}^L F_{\oplus}(a_{\otimes}) = a_{\otimes}(1 \otimes m_{\otimes})\nu_{\oplus}^L$

[LF.3] (a) $F_{\otimes}(a_{\oplus})\nu_{\otimes}^R(1 \oplus \nu_{\otimes}^L) = \nu_{\otimes}^L(\nu_{\otimes}^R \oplus 1)a_{\oplus}$

$$\begin{array}{ccc} F_{\otimes}((A \oplus B) \oplus C) & \xrightarrow{F_{\otimes}(a_{\oplus})} & F_{\otimes}(A \oplus (B \oplus C)) \\ \nu_{\otimes}^L \downarrow & & \downarrow \nu_{\otimes}^R \\ F_{\otimes}(A \oplus B) \oplus F_{\oplus}(C) & & F_{\oplus}(A) \oplus F_{\otimes}(B \oplus C) \\ \nu_{\otimes}^R \oplus 1 \downarrow & & \downarrow 1 \oplus \nu_{\otimes}^L \\ (F_{\oplus}(A) \oplus F_{\otimes}(B)) \oplus F_{\oplus}(C) & \xrightarrow{a_{\oplus}} & F_{\oplus}(A) \oplus (F_{\otimes}(B) \oplus F_{\oplus}(C)) \end{array}$$

(b) $(\nu_{\oplus}^R \otimes 1)\nu_{\oplus}^L F_{\oplus}(a_{\otimes}) = a_{\otimes}(1 \otimes \nu_{\oplus}^L)\nu_{\oplus}^R$

$$[\mathbf{LF.4}] \quad (a) \quad (1 \otimes \nu_{\otimes}^R) \partial^L (\nu_{\oplus}^R \oplus 1) = m_{\otimes} F_{\otimes} (\partial^L) \nu_{\otimes}^R$$

$$\begin{array}{ccc} F_{\otimes}(A) \otimes F_{\otimes}(B \oplus C) & \xrightarrow{1 \otimes \nu_{\otimes}^R} & F_{\otimes}(A) \otimes (F_{\oplus}(B) \oplus F_{\otimes}(C)) \\ m_{\otimes} \downarrow & & \downarrow \partial^L \\ F_{\otimes}(A \otimes (B \oplus C)) & & (F_{\otimes}(A) \otimes F_{\oplus}(B)) \oplus F_{\otimes}(C) \\ F_{\otimes}(\partial^L) \downarrow & & \downarrow \nu_{\oplus}^R \oplus 1 \\ F_{\otimes}((A \otimes B) \oplus C) & \xrightarrow{\nu_{\otimes}^R} & F_{\oplus}(A \oplus B) \oplus F_{\otimes}(C) \end{array}$$

$$(b) \quad (\nu_{\otimes}^L \otimes 1) \partial^R (1 \oplus \nu_{\oplus}^L) = m_{\otimes} F_{\otimes} (\partial^R) \nu_{\otimes}^L$$

$$(c) \quad (1 \otimes \nu_{\otimes}^L) \partial^L (\nu_{\oplus}^L \oplus 1) = \nu_{\oplus}^L F_{\oplus} (\partial^L) n_{\oplus}$$

$$(d) \quad (\nu_{\otimes}^R \otimes 1) \partial^R (1 \oplus \nu_{\oplus}^R) = \nu_{\oplus}^R F_{\oplus} (\partial^R) n_{\oplus}$$

$$[\mathbf{LF.5}] \quad (a) \quad (1 \otimes \nu_{\otimes}^L) \partial^L (m_{\otimes} \oplus 1) = m_{\otimes} F_{\otimes} (\partial^L) \nu_{\otimes}^L$$

$$\begin{array}{ccc} F_{\otimes}(A) \otimes F_{\otimes}(B \oplus C) & \xrightarrow{1 \otimes \nu_{\otimes}^L} & F_{\otimes}(A) \otimes (F_{\otimes}(B) \oplus F_{\oplus}(C)) \\ m_{\otimes} \downarrow & & \downarrow \partial^L \\ F_{\otimes}(A \otimes (B \oplus C)) & & (F_{\otimes}(A) \otimes F_{\otimes}(B)) \oplus F_{\oplus}(C) \\ F_{\otimes}(\partial^L) \downarrow & & \downarrow m_{\otimes} \oplus 1 \\ F_{\otimes}((A \otimes B) \oplus C) & \xrightarrow{\nu_{\otimes}^L} & F_{\otimes}(A \otimes B) \oplus F_{\otimes}(C) \end{array}$$

$$(b) \quad (\nu_{\otimes}^R \otimes 1) \partial^R (1 \oplus m_{\otimes}) = m_{\otimes} F_{\otimes} (\partial^R) \nu_{\otimes}^R$$

$$(c) \quad (1 \otimes n_{\oplus}) \partial^L (\nu_{\oplus}^R \oplus 1) = \nu_{\oplus}^R F_{\oplus} (\partial^L) n_{\oplus}$$

$$(d) \quad (n_{\oplus} \otimes 1) \partial^R (1 \oplus \nu_{\oplus}^L) = \nu_{\oplus}^L F_{\oplus} (\partial^R) n_{\oplus}$$

In the graphical calculus, functors are represented by linear functor boxes [36]. A linear functor box can either be monoidal or comonoidal. When the functor box is monoidal (F_{\otimes}), it has one principal output wire (of F_{\otimes} type) represented by a port where the wire exits the box and the other wires (of F_{\oplus} type) are auxiliary. When the box is comonoidal (F_{\oplus}), it has one principal input wire with a port (of F_{\oplus} type) and the other wires (of F_{\otimes} type) are auxiliary. The functor boxes are subject to a very natural “box eats box” calculus described in [36]. A box can eat another box only when a ported wire meets an auxiliary wire. The linear strengths are drawn in the graphical calculus as follows:

$$\begin{array}{cccc} \nu_{\oplus}^L = & \begin{array}{c} F_{\otimes}(A) \quad F_{\otimes}(B) \\ \diagdown \quad \diagup \\ \boxed{F_{\oplus}} \\ \diagup \quad \diagdown \\ F_{\oplus}(A \otimes B) \end{array} & \nu_{\oplus}^R = & \begin{array}{c} F_{\otimes}(A) \quad F_{\otimes}(B) \\ \diagdown \quad \diagup \\ \boxed{F_{\oplus}} \\ \diagup \quad \diagdown \\ F_{\oplus}(A \otimes B) \end{array} & \nu_{\otimes}^L = & \begin{array}{c} F_{\otimes}(A \oplus B) \\ \diagdown \quad \diagup \\ \boxed{F_{\oplus}} \\ \diagup \quad \diagdown \\ F_{\otimes}(A) \quad F_{\otimes}(B) \end{array} & \nu_{\otimes}^R = & \begin{array}{c} F_{\otimes}(A \oplus B) \\ \diagdown \quad \diagup \\ \boxed{F_{\oplus}} \\ \diagup \quad \diagdown \\ F_{\otimes}(A) \quad F_{\otimes}(B) \end{array} \end{array}$$

$\alpha = (\alpha_{\otimes}, \alpha_{\oplus})$ such that $\alpha_{\otimes} : F_{\otimes} \rightarrow G_{\otimes}$ is a monoidal transformation and $\alpha_{\oplus} : G_{\oplus} \rightarrow F_{\oplus}$ is a comonoidal transformation satisfying the following coherence conditions:

[LT.1] $a_{\otimes} \nu_{\otimes}^R(a_{\oplus} \oplus 1) = \nu_{\otimes}^R(1 \oplus a_{\otimes})$

$$\begin{array}{ccc}
 F_{\otimes}(A \oplus B) & \xrightarrow{\alpha_{\otimes}} & G_{\otimes}(A \oplus B) \\
 \nu_{\otimes}^R \downarrow & & \downarrow \nu_{\otimes}^R \\
 F_{\oplus}(A) \oplus F_{\otimes}(B) & & G_{\oplus}(A) \oplus G_{\otimes}(B) \\
 \searrow^{1 \oplus \alpha_{\otimes}} & & \swarrow_{\alpha_{\oplus} \oplus 1} \\
 & F_{\oplus}(A) \oplus G_{\otimes}(B) &
 \end{array}$$

[LT.2] $\alpha_{\otimes} \nu_{\otimes}^L(1 \oplus \alpha_{\oplus}) = \nu_{\otimes}^L(\alpha_{\otimes} \oplus 1)$

[LT.3] $(1 \otimes \alpha_{\otimes}) \nu_{\oplus}^L(\alpha_{\oplus}) = (\alpha_{\oplus} \otimes 1) \nu_{\oplus}^L$

[LT.4] $(\alpha_{\otimes} \otimes 1) \nu_{\oplus}^R \alpha_{\oplus} = (1 \otimes \alpha_{\oplus}) \nu_{\oplus}^R$

Conditions [LT.1] - [LT.4] are represented graphically as follows:

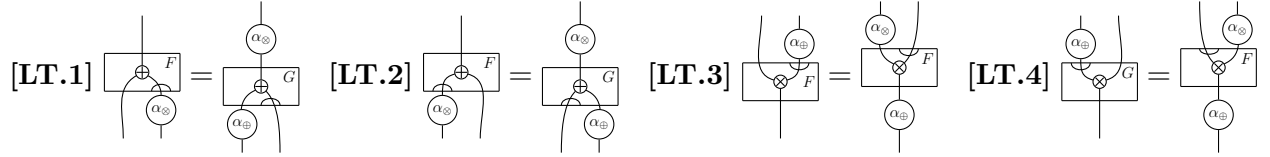

An adjunction of linear functors, $(\eta, \epsilon) : F \dashv G$ is an adjunction in the usual sense (i.e. satisfying the triangle equalities) in the 2-category of LDCs with linear functors and linear natural transformations. In particular, such an adjunction yields a pair of adjunctions: $(\eta_{\otimes}, \epsilon_{\otimes}) : F_{\otimes} \dashv G_{\otimes}$ which is a monoidal adjunction, and $(\epsilon_{\oplus}, \eta_{\oplus}) : G_{\oplus} \dashv F_{\oplus}$ which is a comonoidal adjunction. By Kelly's results [86], a functor with a right adjoint is comonoidal if and only if its right adjoint is monoidal. This leads to the observation that:

Lemma 2.16. *If $(\eta, \epsilon) : F \dashv G$ is an adjunction of linear functors, then F_{\otimes} is iso-monoidal (or strong) with respect to \otimes and F_{\oplus} is iso-comonoidal making the linear functor F strong.*

Proof. Since $(\eta_{\otimes}, \epsilon_{\otimes}) : F_{\otimes} \dashv G_{\otimes}$ is a monoidal adjunction, the left adjoint $(F_{\otimes}, m_{\otimes}, m_{\top})$ is a strong monoidal functor. Similarly, since $(\epsilon_{\oplus}, \eta_{\oplus}) : G_{\oplus} \dashv F_{\oplus}$ is a comonoidal adjunction, the right adjoint $(F_{\oplus}, n_{\oplus}, n_{\perp})$ is a strong comonoidal functor. \square

A **linear equivalence** is a linear adjunction in which the unit and counit are linear natural isomorphisms.

2.2.2 Linear functors for isomix categories

Any isomix category, $(\mathbb{X}, \otimes, \oplus)$ always has two linear functors $\mathbf{Mx}_\downarrow : (\mathbb{X}, \otimes, \otimes) \rightarrow (\mathbb{X}, \otimes, \oplus)$ and $\mathbf{Mx}_\uparrow : (\mathbb{X}, \oplus, \oplus) \rightarrow (\mathbb{X}, \otimes, \oplus)$ given by the identity functor, that is $(\mathbf{Mx}_\uparrow)_\otimes = (\mathbf{Mx}_\uparrow)_\oplus = \text{Id} = (\mathbf{Mx}_\downarrow)_\otimes = (\mathbf{Mx}_\downarrow)_\oplus$. The linear strengths and monoidal maps are given by the inverse of the mix map and the mixior. These mix functors take the degenerate linear structure on the tensor (respectively the par) and spread it out over both the tensor structures.

Lemma 2.17. *For any isomix category \mathbb{X} the functors $\mathbf{Mx}_\downarrow : (\mathbb{X}, \otimes, \otimes) \rightarrow (\mathbb{X}, \otimes, \oplus)$ and $\mathbf{Mx}_\uparrow : (\mathbb{X}, \oplus, \oplus) \rightarrow (\mathbb{X}, \otimes, \oplus)$ are linear functors.*

Proof. We show that $\mathbf{Mx}_\downarrow : (\mathbb{X}, \otimes, \otimes) \rightarrow (\mathbb{X}, \otimes, \oplus)$ is a linear functor: the monoidal and comonoidal components of the functor are given by $(1, 1, 1)$ and $(1, \text{mx}, \mathbf{m}^{-1})$ respectively. The linear strengths are $\nu_\otimes^L = \nu_\otimes^R : A \otimes B \rightarrow A \oplus B := \text{mx}$ and $\nu_\oplus^L = \nu_\oplus^R : A \oplus B \rightarrow A \otimes B := 1$.

First we show $(1, \text{mx}, \mathbf{m}^{-1}) : (\mathbb{X}, \otimes, \otimes) \rightarrow (\mathbb{X}, \otimes, \oplus)$ is a monoidal functor:

- The associative law for monoidal functors, $(\text{mx} \otimes 1) \text{mx} a_\oplus = a_\otimes (1 \otimes \text{mx}) \text{mx}$, is satisfied:

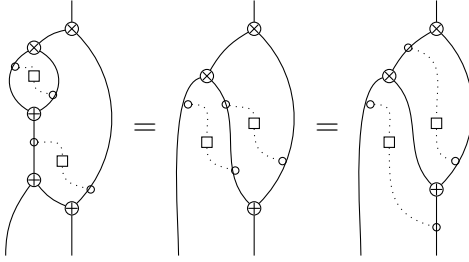

- The unit laws for monoidal functors hold. Here is the pictorial proof of $(1 \otimes \mathbf{m}^{-1}) \text{mx} = u_\otimes^L (u_\oplus^L)^{-1}$, where the filled rectangles represent \mathbf{m}^{-1} :

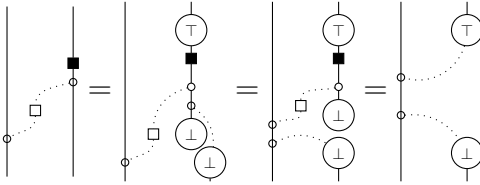

The other unit law holds similarly.

$\mathbf{Mx}_\downarrow : (\mathbb{X}, \otimes, \otimes) \rightarrow (\mathbb{X}, \otimes, \oplus)$ satisfies all the coherence requirements of a linear functor: **[LF.1]**, **[LF.2]**, and **[LF.3]** hold because $(\mathbf{Mx}_\downarrow)_\otimes$ and $(\mathbf{Mx}_\downarrow)_\oplus$ are monoidal and comonoidal

respectively, [LF.4](a) becomes $\mathbf{m}x_{\oplus}^{-1} = \partial^L(\mathbf{m}x \oplus 1)$ and holds because:

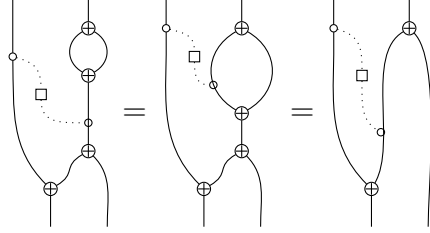

[LF.4] (b) - (d) and [LF.5] (a) - (d) are satisfied similarly.

Thus, $\mathbf{M}x_{\downarrow}$ is a linear functor.

The proof that $\mathbf{M}x_{\uparrow}$ is a linear functor is (linearly) dual □

Corollary 2.18. *When \mathbb{X} is a compact LDC, the mix functors, $\mathbf{M}x_{\downarrow}$ and $\mathbf{M}x_{\uparrow}$, are linear isomorphisms. Consequently, compact LDCs are linearly equivalent to monoidal categories.*

We shall denote the inverse of $\mathbf{M}x_{\downarrow}$ by $\mathbf{M}x_{\downarrow}^* : (\mathbb{X}, \otimes, \oplus) \rightarrow (\mathbb{X}, \oplus, \otimes)$: this is the identity functor as a mere functor, strict on the par structure, and on the tensor structure having as the unit laxor \mathbf{m} and as the tensor laxor $\mathbf{m}x^{-1}$. Similarly, we shall denote the inverse of $\mathbf{M}x_{\uparrow}$ by $\mathbf{M}x_{\uparrow}^*$.

The linear functors $\mathbf{M}x_{\downarrow}$ and $\mathbf{M}x_{\uparrow}$ are examples of *isomix Frobenius functors*, which we shall introduce formally in the next section.

2.2.3 Frobenius functors

In this thesis, we will be interested in linear functors between LDCs called the Frobenius functors which come in various flavours, including mix functors and isomix functors, as illustrated in Figure 2.2. These functors are directly related to the Frobenius monoidal functors of [55] and they are referred to as degenerate linear functors in [27]. Furthermore, we have already seen two rather basic examples, namely, $\mathbf{M}x_{\uparrow}$ and $\mathbf{M}x_{\downarrow}$.

Frobenius functors preserve duals and with an additional coherence condition they preserve the mix map. The coherence requirements for a dagger on an LDC are implied by requiring that the dagger functor be a Frobenius involutive equivalence. Once the dagger is understood we can consider \dagger -mix categories and their functors which we shall take to be mix Frobenius functors with a further requirement concerning the preservation of the dagger.

Definition 2.19. *Let \mathbb{X} and \mathbb{Y} to LDCs. A **Frobenius functor** is a linear functor $F : \mathbb{X} \rightarrow \mathbb{Y}$ such that:*

$$[\mathbf{FLF.1}] \quad F_{\otimes} = F_{\oplus}$$

$$[\mathbf{FLF.2}] \quad m_{\otimes} = \nu_{\oplus}^R = \nu_{\oplus}^L$$

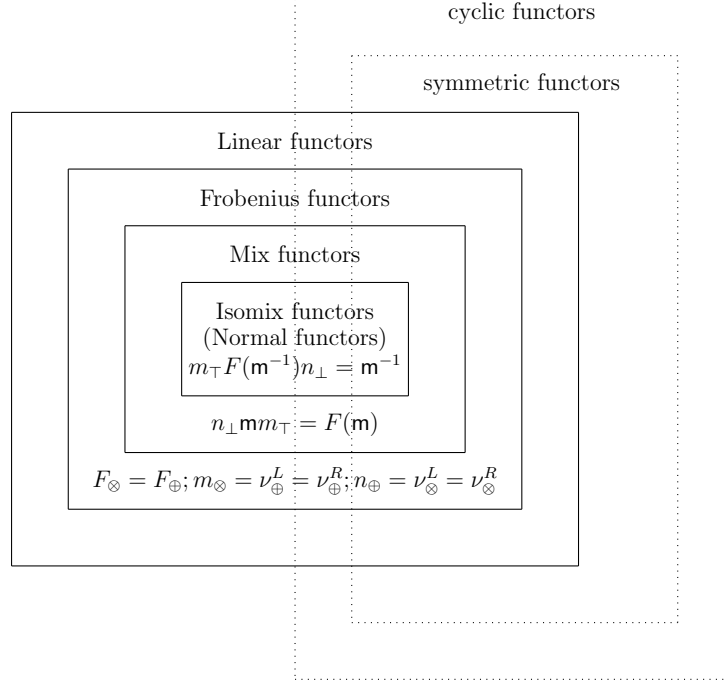

Figure 2.2: Linear functor family

[FLF.3] $n_{\oplus} = \nu_{\otimes}^L = \nu_{\otimes}^R$

The left and right linear strengths of \otimes and \oplus coinciding with the m_{\otimes} and n_{\oplus} respectively means that in the diagrammatic calculus, ports can be moved around freely:

$$\begin{array}{ccc}
 \begin{array}{c} F_{\oplus}(A) \\ \diagdown \\ \text{---} \otimes \text{---} \\ \diagup \\ F_{\oplus}(B) \\ \text{---} \\ F_{\oplus}(A \otimes B) \end{array} & = & \begin{array}{c} F_{\otimes}(A) \\ \diagdown \\ \text{---} \otimes \text{---} \\ \diagup \\ F_{\otimes}(B) \\ \text{---} \\ F_{\otimes}(A \otimes B) \end{array} & = & \begin{array}{c} F_{\otimes}(A) \\ \text{---} \\ \text{---} \otimes \text{---} \\ \text{---} \\ F_{\otimes}(A \otimes B) \end{array} \\
 \nu_{\oplus}^L & = & \nu_{\oplus}^R & = & m_{\otimes}
 \end{array}
 \qquad
 \begin{array}{ccc}
 \begin{array}{c} F_{\otimes}(A \oplus B) \\ \text{---} \\ \text{---} \oplus \text{---} \\ \text{---} \\ F_{\otimes}(A) \\ \diagup \\ \text{---} \oplus \text{---} \\ \diagdown \\ F_{\otimes}(B) \end{array} & = & \begin{array}{c} F_{\oplus}(A \oplus B) \\ \text{---} \\ \text{---} \oplus \text{---} \\ \text{---} \\ F_{\oplus}(A) \\ \diagup \\ \text{---} \oplus \text{---} \\ \diagdown \\ F_{\oplus}(B) \end{array} & = & \begin{array}{c} F_{\oplus}(A \oplus B) \\ \text{---} \\ \text{---} \oplus \text{---} \\ \text{---} \\ F_{\oplus}(A) \\ \text{---} \\ \text{---} \oplus \text{---} \\ \text{---} \\ F_{\oplus}(B) \end{array} \\
 \nu_{\otimes}^L & = & \nu_{\otimes}^R & = & n_{\oplus}
 \end{array}$$

This implies that the ports can be omitted in the circuits.

A Frobenius functor is **symmetric** if as a linear functor it preserves the symmetries of the tensor and par.

Lemma 2.20. *Suppose \mathbb{X} and \mathbb{Y} are LDCs. The following are equivalent:*

- (a) $F : \mathbb{X} \rightarrow \mathbb{Y}$ is a Frobenius linear functor.

(b) F is \otimes -monoidal and \oplus -comonoidal such that

$$\begin{array}{ccc}
F(A) \otimes F(B \oplus C) & \xrightarrow{1 \otimes n_{\oplus}} & F(A) \otimes (F(B) \oplus F(C)) \\
m_{\otimes} \downarrow & \text{[F.1]} & \downarrow \delta^L \\
F(A \otimes (B \oplus C)) & & (F(A) \otimes F(B)) \oplus F(C) \\
F(\delta^L) \downarrow & & \downarrow m_{\otimes \oplus 1} \\
F((A \oplus B) \oplus C) & \xrightarrow{n_{\oplus}} & F(A \oplus B) \oplus F(C)
\end{array}$$

$$\begin{array}{ccc}
F(A \oplus B) \otimes F(C) & \xrightarrow{n_{\oplus} \otimes 1} & (F(A) \oplus F(B)) \otimes F(C) \\
m_{\otimes} \downarrow & \text{[F.2]} & \downarrow \delta^R \\
F((A \oplus B) \otimes C) & & F(A) \oplus (F(B) \otimes F(C)) \\
F(\delta^R) \downarrow & & \downarrow 1 \oplus m_{\otimes} \\
F(A \oplus (B \otimes C)) & \xrightarrow{n_{\oplus}} & F(A) \oplus F(B \otimes C)
\end{array}$$

Proof. For (a) \Rightarrow (b), fix $F := F_{\otimes} = F_{\oplus}$, then F is \otimes -monoidal and \oplus -comonoidal. Conditions [F.1] and [F.2] are given by [LF.5]-(a) and [LF.5]-(b). For the other direction, define $F_{\otimes} = F_{\oplus} := F$. Then it is straightforward to check that all the axioms of Frobenius linear functors are satisfied by $(F_{\otimes}, F_{\oplus})$. \square

Conditions [F.1] and [F.2] in Lemma 2.20 are diagrammatically represented as follows:

$$\text{[F.1]} \quad \begin{array}{c} \text{Diagram 1} \\ \text{Diagram 2} \end{array} = \begin{array}{c} \text{Diagram 3} \\ \text{Diagram 4} \end{array} \quad \text{[F.2]} \quad \begin{array}{c} \text{Diagram 5} \\ \text{Diagram 6} \end{array} = \begin{array}{c} \text{Diagram 7} \\ \text{Diagram 8} \end{array}$$

Frobenius functors compose: the composition is defined as the usual composition of linear functors [38].

It is immediate from Lemma 2.14 that Frobenius functors preserve linear duals. In fact if $F : \mathbb{X} \rightarrow \mathbb{Y}$ is a Frobenius functor and $A \dashv B$ is a linear dual, as the duals $F_{\otimes}(A) \dashv F_{\oplus}(B)$ and $F_{\oplus}(A) \dashv F_{\otimes}(B)$ now coincide, we just obtain the one dual $F(A) \dashv F(B)$. In the case when the Frobenius functor is between cyclic $*$ -autonomous categories we expect the functor to be **cyclor-preserving** in the following sense:

$$\text{[CFF]} \quad \begin{array}{ccc}
F(X^*) & \xrightarrow{F(\psi)} & F(*X) \\
\cong \downarrow & & \downarrow \cong \\
F(X)^* & \xrightarrow{\psi} & *F(X)
\end{array}$$

(i) One of **[nat.1](a)** or **[nat.1](b)** holds, and one of α_\otimes or α_\oplus is an isomorphism.

$$\text{[nat.1]} \quad \begin{array}{ccc} \top & \xrightarrow{m_\top} & G(\top) \\ & \searrow^{(a)} & \downarrow \alpha_\oplus \\ & & F(\top) \end{array} \quad \text{or} \quad \begin{array}{ccc} F(\perp) & \xrightarrow{\alpha_\otimes} & G(\perp) \\ & \searrow^{(b)} & \downarrow n_\perp \\ & & \perp \end{array}$$

(ii) One of **[nat.1](a)** or **[nat.1](b)** holds and one of the following commuting diagrams holds.

$$\text{[nat.2]} \quad \begin{array}{ccc} G(A) \otimes F(B) & \xrightarrow{1 \otimes \alpha_\otimes} & G(A) \otimes G(B) \\ \alpha_\oplus \otimes 1 \downarrow & & \downarrow m_\otimes^G \\ F(A) \otimes F(B) & \xrightarrow{(a)} & F(A) \otimes G(B) \\ m_\otimes^F \downarrow & & \downarrow m_\otimes^G \\ F(A \otimes B) & \xrightarrow{\alpha_\otimes} & G(A \otimes B) \end{array} \quad \text{or} \quad \begin{array}{ccc} F(A) \otimes G(B) & \xrightarrow{\alpha_\otimes \otimes 1} & G(A) \otimes G(B) \\ 1 \otimes \alpha_\oplus \downarrow & & \downarrow m_\otimes^G \\ F(A) \otimes F(B) & \xrightarrow{(b)} & F(A) \otimes G(B) \\ m_\otimes^F \downarrow & & \downarrow m_\otimes^G \\ F(A \otimes B) & \xrightarrow{\alpha_\otimes} & G(A \otimes B) \end{array}$$

$$\text{or} \quad \begin{array}{ccc} G(A \oplus B) & \xrightarrow{n_\oplus^G} & G(A) \oplus G(B) \\ \alpha_\oplus \downarrow & & \downarrow 1 \oplus \alpha_\oplus \\ F(A \oplus B) & \xrightarrow{(c)} & F(A) \oplus F(B) \\ n_\oplus^F \downarrow & & \downarrow \alpha_\oplus \oplus 1 \\ F(A) \oplus F(B) & \xrightarrow{\alpha_\oplus \oplus 1} & G(A) \oplus F(B) \end{array} \quad \text{or} \quad \begin{array}{ccc} G(A \oplus B) & \xrightarrow{n_\oplus^G} & G(A) \oplus G(B) \\ \alpha_\oplus \downarrow & & \downarrow \alpha_\oplus \oplus 1 \\ F(A \oplus B) & \xrightarrow{(d)} & F(A) \oplus G(B) \\ n_\oplus \downarrow & & \downarrow 1 \otimes \alpha_\otimes \\ F(A) \oplus F(B) & \xrightarrow{1 \otimes \alpha_\otimes} & F(A) \oplus G(B) \end{array}$$

(iii) $\alpha_\otimes^{-1} = \alpha_\oplus$

(iv) $\alpha' := (\alpha_\oplus, \alpha_\otimes) : G \Rightarrow F$ is a linear transformation.

Conditions **[nat.2]** are as follows in the graphical calculus:

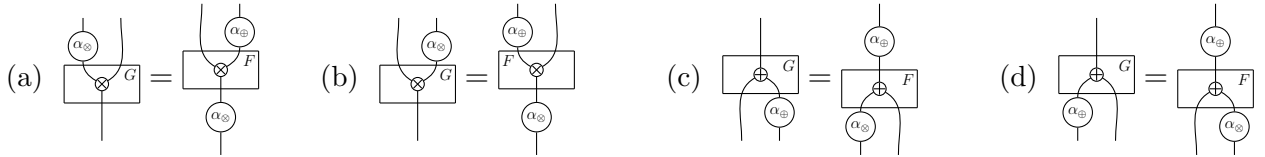

Proof. (i) \Rightarrow (iii): Here is the proof assuming **[nat.1](a)** that $\alpha_\otimes \alpha_\oplus = 1$:

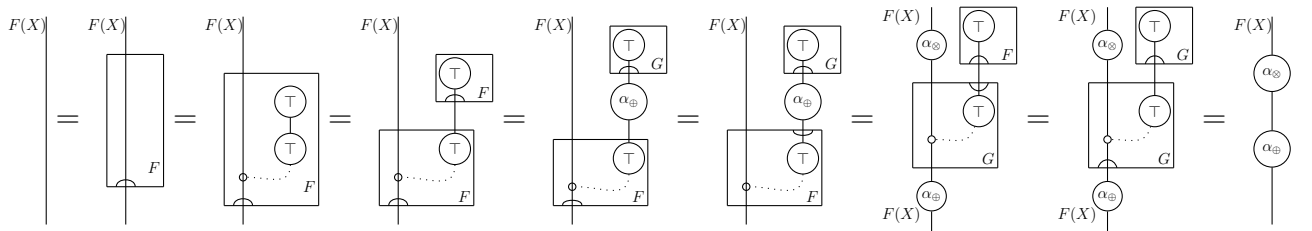

if either α_\otimes or α_\oplus are isomorphisms this implies $\alpha_\oplus \alpha_\otimes = 1$.

(ii) \Rightarrow (iii): The assumption of [nat.1](a) or (b) yields, as above, that $\alpha_{\otimes}\alpha_{\oplus} = 1$. Using [nat.2](c) for example gives $\alpha_{\oplus}\alpha_{\otimes} = 1$:

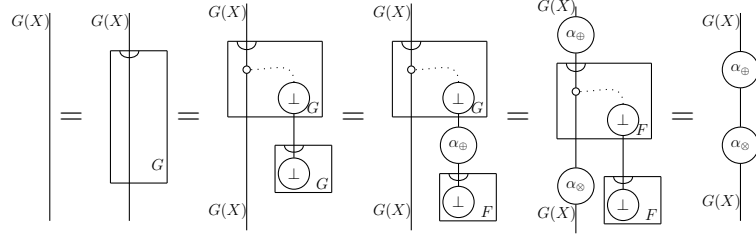

Since, $\alpha_{\otimes}\alpha_{\oplus} = 1$ and $\alpha_{\oplus}\alpha_{\otimes} = 1$ we have $\alpha_{\otimes} = \alpha_{\oplus}^{-1}$. The other combinations of rules are used in similar fashion.

(iii) \Rightarrow (iv): If $\alpha_{\otimes} = \alpha_{\oplus}^{-1}$, then

$$(\alpha_{\oplus} \otimes \alpha_{\oplus})m_{\otimes}^F = m_{\otimes}^G\alpha_{\otimes} : G(A) \otimes G(B) \rightarrow F(A \otimes B)$$

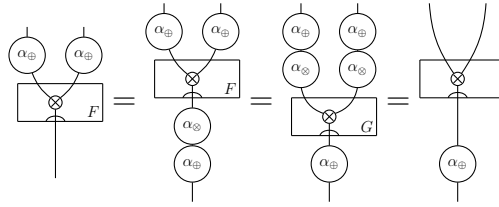

$$m_{\top}^F = m_{\top}^G\alpha_{\oplus} : \top \rightarrow F(\top)$$

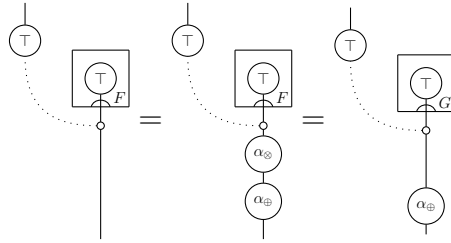

Thus, α_{\otimes} is comonoidal. Similarly, it can be proven that α_{\oplus} is monoidal. The axioms [LT.4] (a)-(d) for a linear transformation are satisfied for $(\alpha_{\oplus}, \alpha_{\otimes})$ because $\alpha_{\oplus} = \alpha_{\otimes}^{-1}$.

(iv) \Rightarrow (i) and (ii): The axioms [nat.1] and [nat.2] are given by the fact that $(\alpha_{\oplus}, \alpha_{\otimes})$ is a linear transformation.

□

Frobenius functors between isomix categories are especially important in the development of dagger linearly distributive categories and they often satisfy an additional property:

Definition 2.25. A Frobenius functor between isomix categories is an **isomix functor** in

case it is a mix functor which satisfies, in addition, the following diagram:

$$\begin{array}{ccc}
 \text{[isomix-FF]} & \top & \xrightarrow{\quad m^{-1} \quad} \perp \\
 & \searrow m_{\top} & \nearrow n_{\perp} \\
 & F(\top) & \xrightarrow{F(m^{-1})} F(\perp)
 \end{array}$$

Recall that a linear functor is **normal** in case both m_{\top} and n_{\perp} are isomorphisms. We observe:

Lemma 2.26. *For a mix Frobenius functor, $F : \mathbb{X} \rightarrow \mathbb{Y}$, between isomix categories the following are equivalent:*

- (i) $n_{\perp} : F(\perp) \rightarrow \perp$ or $m_{\top} : \top \rightarrow F(\top)$ is an isomorphism;
- (ii) F is a normal functor;
- (iii) F is an isomix functor.

Proof.

(i) \Rightarrow (ii): Note that, as F is a mix functor $F(\mathbf{m}) = n_{\perp} \mathbf{m} m_{\top}$. As the mix map \mathbf{m} is an isomorphism so is $F(\mathbf{m})$ which implies that if n_{\perp} is an isomorphism then m_{\top} must be an isomorphism and vice versa. Thus, F will be a normal functor.

(ii) \Rightarrow (iii): If F is normal then n_{\perp} and m_{\top} are isomorphisms and so

$$\begin{array}{c}
 F(\mathbf{m}) = n_{\perp} \mathbf{m} m_{\top} \\
 \hline
 F(\mathbf{m}^{-1}) = m_{\top}^{-1} \mathbf{m}^{-1} n_{\perp}^{-1} \\
 \hline
 m_{\top} F(\mathbf{m}^{-1}) n_{\perp} = \mathbf{m}^{-1}
 \end{array}$$

(iii) \Rightarrow (i): The mix-preservation for F makes n_{\perp} a section (and m_{\top} a retraction) while the isomix-preservation makes m_{\perp} a retraction (and m_{\top} a section. This means n_{\perp} is an isomorphism (m_{\top} is an isomorphism).

□

Corollary 2.27. $\alpha := (\alpha_{\otimes}, \alpha_{\oplus})$ is a linear natural isomorphism between isomix Frobenius linear functors if and only if $\alpha_{\otimes} = \alpha_{\oplus}^{-1}$.

Proof. Note that if we can establish **[nat.1](a)** or **(b)** then we can prove that $\alpha_{\otimes} \alpha_{\oplus} = 1$ and, as α_{\otimes} is an isomorphism it follows that $\alpha_{\oplus} \alpha_{\otimes} = 1$. Thus, it suffices to show that **[nat.1](a)** holds:

$$m_{\top} \alpha_{\oplus} G(\mathbf{m}^{-1}) n_{\perp} = m_{\top} F(\mathbf{m}^{-1}) \alpha_{\oplus} n_{\perp} = m_{\top} F(\mathbf{m}^{-1}) n_{\perp} = \mathbf{m}^{-1} = m_{\top} G(\mathbf{m}^{-1}) n_{\perp}$$

However, as $G(m^{-1})n_{\perp}$ is an isomorphism, it follows that $m_{\top}\alpha_{\oplus} = m_{\top}$. \square

Lemma 2.24 and Corollary 2.27 are generalizations of [55, Proposition 7]. [55, Proposition 7] states the following:

Let \mathbb{X} and \mathbb{Y} be monoidal categories and $(\eta, \epsilon) : A \dashv B \in \mathbb{X}$. If $F, G : \mathbb{X} \rightarrow \mathbb{Y}$ are Frobenius monoidal functors with a natural transformation $\alpha : F \Rightarrow G$ which is both monoidal and comonoidal, then α_A is invertible.

In Lemma 2.24, when $A \dashv B \in \mathbb{X}$, then α_{\oplus} is defined as follows:

$$\alpha_{\oplus} : G(A) \rightarrow F(A) = \begin{array}{c} \begin{array}{c} G(A) \\ \downarrow \\ \begin{array}{c} \boxed{\begin{array}{c} \eta \\ \downarrow \\ F(B) \\ \downarrow \\ \alpha_{\otimes} \\ \downarrow \\ G(B) \\ \downarrow \\ \epsilon \\ \downarrow \\ G \end{array}} \\ \downarrow \\ F(A) \end{array} \end{array} \end{array}$$

For these special linear isomorphisms with $\alpha_{\otimes} = \alpha_{\oplus}^{-1}$ we can simplify the coherence requirements:

Lemma 2.28. *Suppose F and G are Frobenius functors and $\alpha : F \rightarrow G$ is a natural isomorphism then:*

- (i) *If $\alpha : F \rightarrow G$ is \otimes -monoidal and \oplus -comonoidal then (α, α^{-1}) is a linear transformation;*
- (ii) *If F and G are strong Frobenius functors and α is \otimes -monoidal and \oplus -monoidal then (α, α^{-1}) is a linear transformation.*

Proof.

- (i) If α is \otimes -monoidal and \oplus -comonoidal then so is α^{-1} supporting the possibility that it is a component of a linear transformation. Considering [LT.1] we show that (α, α^{-1}) satisfies this requirement as:

$$\begin{array}{ccc} F(A \oplus B) & \xrightarrow{\alpha_{\otimes}} & G(A \oplus B) \\ n_{\oplus} = \nu_{\otimes}^R \downarrow & & \downarrow n_{\oplus} = \nu_{\otimes}^R \\ F(A) \oplus F(B) & \xrightarrow{\alpha_{\oplus}} & G(A) \oplus G(B) \\ \swarrow 1 \oplus \alpha & & \nwarrow \alpha^{-1} \oplus 1 \\ & F(A) \oplus G(B) & \end{array}$$

The remaining requirements follow similarly.

- (ii) When the laxors for the functors are isomorphisms then being monoidal implies being comonoidal. \square

2.3 Motivating examples

In Section 2.1, we listed a few examples of linearly distributive categories. In this section, we present the categories of finiteness relations, \mathbf{FRel} and finiteness matrices over a commutative rig R , $\mathbf{FMat}(R)$, and discuss their properties. These isomix categories are closely related to categorical quantum mechanics because the core of these categories are used as the standard categorical models to study quantum processes in finite dimensions: the core of $\mathbf{FMat}(R)$ is equivalent to the category finite dimensional matrices over a commutative rig R , and the core of \mathbf{FRel} is the category of finite sets and relations.

The categories \mathbf{FRel} and $\mathbf{FMat}(R)$ are used as running examples throughout this thesis. Consequently, the purpose of this section is to revisit the results of [64] in which these categories were introduced.

2.3.1 Finiteness relations \mathbf{FRel} and finiteness matrices $\mathbf{FMat}(R)$

Finiteness spaces were introduced by Ehrhard [64] as a categorical model of Girard's linear logic [68]. A finiteness space $(X, \mathcal{A}, \mathcal{B})$ may be regarded as a set, X , called the **web** of X , equipped with two sets of subsets, $\mathcal{A} \subseteq \mathcal{P}(X)$ the **finitary** sets of X , and $\mathcal{B} \subseteq \mathcal{P}(X)$ the **cofinitary** sets of X . The finitary and cofinitary sets must be finiteness complements of each other (as described below) and so determine each other. This means that a finiteness space is often presented with just the finitary sets. Morphisms of a finiteness spaces are relations between the webs that preserve the finitary sets and reflect the cofinitary sets. The category of finiteness spaces with finiteness relations is an isomix $*$ -autonomous category. In this section, we aim to give a reasonably self-contained account of \mathbf{FRel} , the category of finitary relations, and of $\mathbf{FMat}(R)$ the category of finiteness matrices with entries in a commutative rig R , and to establish that these categories are symmetric \dagger - $*$ -isomix categories.

Let X be any set and $A, B \subseteq X$ then A is **finiteness orthogonal** [64] [64, Section 1] to B , written $A \perp_f B$, in case $A \cap B$ is finite. Given a set of subsets of X , $\mathcal{A} \subseteq \mathcal{P}(X)$ set,

$$\mathcal{A}^\perp = \{B \subseteq X \mid \forall A \in \mathcal{A}, B \perp_f A\}$$

Thus \mathcal{A}^\perp is the set of all subsets of X which intersects with all the sets in \mathcal{A} finitely. Observe that:

Lemma 2.29. *For $\mathcal{A}, \mathcal{B} \subset \mathcal{P}(X)$:*

$$(i) \quad \mathcal{A} \subseteq \mathcal{B} \Rightarrow \mathcal{B}^\perp \subseteq \mathcal{A}^\perp;$$

$$(ii) \quad \mathcal{A} \subseteq \mathcal{A}^{\perp\perp};$$

(iii) $\mathcal{A}^{\perp\perp\perp} = \mathcal{A}^\perp$;

(iv) \mathcal{A}^\perp is downset closed and closed under finite unions;

(v) if $\mathcal{A} = \mathcal{A}^{\perp\perp}$ then $\mathcal{P}_f(X) \subseteq \mathcal{A}$ (that is \mathcal{A} contains all finite subsets);

(vi) If $\mathcal{A}_i = \mathcal{A}_i^{\perp\perp}$ for $i \in I$ then $\bigcap_{i \in I} \mathcal{A}_i = (\bigcup_{i \in I} \mathcal{A}_i^\perp)^\perp$
(so $\bigcap_{i \in I} \mathcal{A}_i = (\bigcap_{i \in I} \mathcal{A}_i)^{\perp\perp}$).

The first two observations establish a Galois connection on the subsets of $\mathcal{P}(X)$ from which the next observation is standard. The last two are easy consequences of the form of the finiteness orthogonality.

Definition 2.30. A finiteness space is a triple $(X, \mathcal{A}, \mathcal{B})$ where X is a set, called the **web** of the space, and $\mathcal{A}, \mathcal{B} \subseteq \mathcal{P}(X)$, such that the two subsets are finiteness complements, that is $\mathcal{A}^\perp = \mathcal{B}$ and $\mathcal{B}^\perp = \mathcal{A}$. Elements of \mathcal{A} are the **finitary** sets of the finiteness space, while elements of \mathcal{B} are called the **cofinitary** sets.

Because the cofinitary sets are completely determined by the finitary sets it is often convenient to write a finiteness space as $(X, F(X), F(X)^\perp)$, making clear that the structure is completely determined by the web and the finitary sets. The finitary and cofinitary sets are downward closed, that is $F(X) = \downarrow F(X)$, and are closed under arbitrary intersections and finite unions. As finite sets always intersect finitely both with the finitary and cofinitary sets, the finitary and cofinitary sets of every finiteness space must always include all the finite subsets. In particular this means that a finiteness set with a finite web must have every subset both finitary and cofinitary. Furthermore, every set, X , always carries two ‘‘trivial’’ finiteness structures (which coincide for a finite set): $(X, \mathcal{P}_f(X), \mathcal{P}(X))$ and $(X, \mathcal{P}(X), \mathcal{P}_f(X))$, where $\mathcal{P}_f(X)$ is the set of finite subsets of X . On the other hand, as we now observe, an infinite set always has infinitely many non-trivial finiteness structures:

Lemma 2.31.

(i) A finiteness space, $(X, F(X), F(X)^\perp)$, with a finite web, has its finitary and cofinitary sets completely determined to be $F(X) = F(X)^\perp = \mathcal{P}(X) = \mathcal{P}_f(X)$;

(ii) Every infinite set carries infinitely many non-trivial finiteness structures;

(iii) The set of finiteness structures carried by X form a complete (non-distributive) lattice with $(X, \mathcal{A}, \mathcal{B}) \leq (X, \mathcal{A}', \mathcal{B}')$ if and only if $\mathcal{A} \subseteq \mathcal{A}'$ (equivalently $\mathcal{B}' \subseteq \mathcal{B}$). The lattice

structure is given by:

$$\begin{aligned} \top &:= (X, \mathcal{P}(X), \mathcal{P}_f(X)) & \perp &:= (X, \mathcal{P}_f(X), \mathcal{P}(X)) \\ \bigwedge_i A_i &:= \left(X, \bigcap_i \mathcal{A}_i, \left(\bigcup_i \mathcal{A}_i \right)^{\perp\perp} \right) & \bigvee_{i \in I} A_i &:= \left(X, \left(\bigcup_i \mathcal{A}_i \right)^{\perp\perp}, \bigcap_i \mathcal{B}_i \right) \end{aligned}$$

Proof.

(i) This is immediate.

(ii) There are, of course, many different possible finiteness structures for an infinite set: to see this consider the finiteness space $(X, \{A\}^{\perp\perp}, \{A\}^\perp)$, generated by insisting that an infinite subset, $A \subseteq X$, whose complement, $\neg A$, is also infinite, is finitary. Notice that, in this case:

$$\{A\}^\perp = \{Y \mid Y \cap A \text{ is finite}\} = \{Y \mid Y \subseteq \neg A \cup F \text{ where } F \text{ is finite}\}$$

$$\{A\}^{\perp\perp} = \{X \mid X \subset A \cup F \text{ where } F \text{ is finite}\}$$

It is then sufficient to show that there are infinitely many of these sets which are distinct by more than a finite set: for this note that having chosen an infinite set one can split it again recursively in the same manner.

(iii) It suffices to show that the two sets $\bigwedge_{i \in I} \mathcal{A}_i$ and $\bigvee_{i \in I} \mathcal{B}_i$ are complementary. Note that each set $B_i \in \mathcal{B}_i$ is in $\bigvee_{i \in I} \mathcal{B}_i$ so any set in the complement must be in the complement of each \mathcal{B}_i and so must be in $\bigwedge_{i \in I} \mathcal{A}_i$. Conversely, a set in $\bigwedge_{i \in I} \mathcal{A}_i$ is necessarily orthogonal to each finite union $\bigcup_{i \in F} B_i$ as it intersects with each B_i finitely. Thus, $(\bigvee_{i \in I} \mathcal{B}_i)^\perp = \bigwedge_{i \in I} \mathcal{A}_i$.

□

To complete the description of the category **FRel**, we describe the morphisms between these spaces:

Definition 2.32. A finiteness relation $R : (X, F(X), F(X)^\perp) \rightarrow (Y, F(Y), F(Y)^\perp)$ between two finiteness spaces, is a relation $X \xrightarrow{R} Y$ such that:

(i) for all $A \in F(X)$, $A \triangleright R := \{y \mid \exists x \in A \text{ such that } xRy\} \in F(Y)$

(ii) for all $B \in F(Y)^\perp$, $R \triangleleft B := \{x \mid \exists y \in B \text{ such that } xRy\} \in F(X)^\perp$

Here we are using a notation which can be translated into allegorical notation, see [67], where it is possible to do most of these proofs more generally and so can be made formal for general categories of relations: we, of course, will have in mind sets and relations. In this notation a finitary set in $F(X)$ is a subrelation of the identity relation $A \subseteq 1_X$ while a cofinitary set, $B \in F(X)^\perp$, is a subrelation $B \subseteq 1_Y$. The orthogonality relation $A \perp_f A'$ is then the requirement that $A \cap A' = AA'$ is finite. A finiteness relation is a map $R : X \rightarrow Y$ with $A \triangleright R := \text{cod}(AR) \in F(Y)$, for every $A \in F(X)$, and $R \triangleleft B := \text{dom}(RB) \in F(X)^\perp$ for every $B \in F(Y)^\perp$ (recall that $\text{dom}(R) = 1_X \cap RR^\circ$ and $\text{cod}(R) = 1_Y \cap R^\circ R$, where R° is the converse of R).

Finite relations are determined by having finite domains and codomains: so that $R : X \rightarrow Y$ is finite if and only if $\text{cod}(R) \subseteq_f 1_Y$ and $\text{dom}(R) \subseteq_f 1_X$. Thus R is a finiteness relation if and only if ARB is a finite relation for every $A \in F(X)$ and $B \in F(Y)^\perp$.

Notice that once we require that $A \triangleright R \in F(Y)$ for every $A \in F(X)$ then each $B \in F(Y)^\perp$ has a finite intersection with $A \triangleright R$ so that there are finitely many $b \in (A \triangleright R) \cap B$ and whence

$$\begin{aligned} ARB &= AR((A \triangleright R) \cap B) = AR \bigcup_{b \in A \triangleright R \cap B} \{b\} \\ &= \bigcup_{b \in A \triangleright R \cap B} AR\{b\} = \bigcup_{b \in A \triangleright R \cap B} (A \cap R \triangleleft \{b\})R\{b\} \end{aligned}$$

This means that so long as $R \triangleleft \{b\} \in F(X)^\perp$ each $A \cap R \triangleleft \{b\}$ will be finite, so, as the union over $b \in A \triangleright R \cap B$ is a finite union, this ensures that ARB is a finite relation and, thus, that R is a finiteness relation.

This discussion gives the following important simplifications (see Ehrhard [64]) of the conditions of being a finiteness relation:

Lemma 2.33. *The following are equivalent:*

- (i) $R : X \rightarrow Y$ is a finiteness relation;
- (ii) ARB is a finite relation for all $A \in F(X)$ and $B \in F(Y)^\perp$;
- (iii) $R : X \rightarrow Y$ has $A \triangleright R \in F(Y)$ for all $A \in F(X)$ and for every $y \in Y$, $R \triangleleft \{y\} \in F(X)^\perp$;
- (iv) $R : X \rightarrow Y$ has $R \triangleleft B \in F(X)^\perp$ for all $B \in F(Y)^\perp$ and for every $x \in X$, $\{x\} \triangleright R \in F(Y)$.

Proof. The above discussion proves that (i) is equivalent to (ii). That (ii) implies (iii) is now immediate (by converse symmetry this also gives (ii) implies (iv)). Finally we have shown above that (iii) implies (ii) (and by converse symmetry that (iv) implies (ii)). \square

The category of finiteness relations, \mathbf{FRel} , has objects finiteness spaces and maps finiteness relations with composition as in the category of relations:

Lemma 2.34. *Finiteness spaces with finiteness relations, \mathbf{FRel} , forms a category with composition the usual composition of relations and identities the diagonal relations.*

Proof. Suppose $X \xrightarrow{R} Y$, and $Y \xrightarrow{S} Z$ are finiteness relations. Then, for $A \in F(X)$ we know $A \triangleright R \in F(Y)$ and whence $A \triangleright (RS) = (A \triangleright R) \triangleright S \in F(Z)$. Similarly for $B \in F(Z)^\perp$ we have $S \triangleleft B \in F(Y)^\perp$ and, therefore, $(RS) \triangleleft B = (R \triangleleft (S \triangleleft B)) \in F(X)^\perp$.

Clearly the identity relation is always a finiteness relation. \square

We record an obvious yet important fact: there is a faithful functor $|_|_ : \mathbf{FRel} \rightarrow \mathbf{Rel}$ which takes a finiteness space to its web and a finiteness relation to its underlying relation. This functor, we shall see, preserves the structure of \mathbf{FRel} as an isomix *-autonomous category on the nose so that we can use the known coherence properties of \mathbf{Rel} to obtain the corresponding coherence properties of \mathbf{FRel} .

With finiteness relations in hand one can build the category of finiteness matrices, $\mathbf{FMat}(R)$, for an arbitrary commutative rig, R . While R can be any commutative rig, we are most interested in the case when R is the complex numbers, and, thus, in the category $\mathbf{FMat}(\mathbb{C})$.

The category $\mathbf{FMat}(R)$, where R is any commutative rig is defined as follows:

Objects: Finiteness spaces;

Maps: Finiteness matrices $M : X \rightarrow Y$ where $M = [M_{i,j}]_{i \in X, j \in Y}$ where each $M_{i,j} \in R$ and the support, $|M|$, is a finiteness relation, that is $|M| = \{(i, j) \mid M_{i,j} \neq 0\}$ is a finiteness relation;

Composition: Matrix multiplication – where we note all the non-zero sums are finite (see Lemma 2.35 below), $\sum_j r_{i,j} s_{j,k} = \sum_{j \in \{i\} \triangleright r \cap |s| \triangleleft \{k\}} r_{i,j} s_{j,k}$.

Identities: Identity matrices.

Observe that, although finiteness matrices may be infinite dimensional, to form the composition of two finiteness matrices only requires the ability to multiply a finite number of entries and, thus, to sum only a finite number of elements. This is because the support of each matrix is always a finiteness relation, thus, for composition one only need compute the products of non-zero elements and these lie in the intersection of a finite and cofinite set, so is finite. This explicitly is the observation:

Lemma 2.35. *If $X \xrightarrow{R} Y \xrightarrow{S} Z$ is a finiteness relation, then*

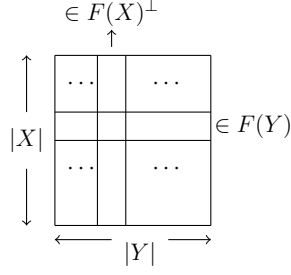

Figure 2.3: Finiteness matrix

(i) for all $x \in X$, $\{x\} \triangleright R \in F(Y)$, and

(ii) for all $y \in Y$, $S \triangleleft \{z\} \in F(Y)^\perp$

(iii) for all $x \in X$ and $z \in Z$, $\{x\} \triangleright R \perp_f S \triangleleft \{z\}$, that is $\{x\} \triangleright R \cap S \triangleleft \{z\}$ is finite.

In a finiteness matrix $X \xrightarrow{M} Y$, each row of the matrix has support a finitary set of Y , and each column has a cofinitary set of X as shown in Figure 2.3.

Lemma 2.36. *Finiteness spaces with finiteness matrices over any commutative rig, R , form a category, $\mathbf{FMat}(R)$.*

Proof. We must show that finiteness matrices compose. We already know that, even though finiteness matrices can be infinite-dimensional, two such matrices can be multiplied using only finite sums of elements because their supports are finiteness relations. However, we still have to show that the product of two finiteness matrices is a finiteness matrix.

Suppose $X \xrightarrow{P} Y$ and $Y \xrightarrow{Q} Z$, $[PQ]_{x,z} = \sum_{y \in Y} [P]_{x,y} [Q]_{y,z}$ can only be non-zero if $\exists y \in Y$, such that $[P]_{x,y}$, and $[Q]_{y,z}$ are non-zero, although, even if there exists $y \in Y$, such that $[P]_{x,y}$ and $[Q]_{y,z}$ are non-zero, $[PQ]_{x,z}$ may still be zero. This means the support $|PQ| \subseteq |P||Q|$. Since, any subset of a finitary relation is finitary, PQ is a finiteness matrix. \square

The proof shows that taking the support of matrices gives, in general, a colax 2-functor $|-| : \mathbf{FMat}(R) \rightarrow \mathbf{FRel}$ as $|MN| \leq |M||N|$. In general if $f : R \rightarrow S$ is a morphism of rigs then we obtain a functor $\mathbf{FMat}(f) : \mathbf{FMat}(R) \rightarrow \mathbf{FMat}(S)$: if S is an ordered rig and f is suitably colax then $\mathbf{FMat}(f)$ is a colax functor. Recall that the two element lattice $\mathbb{2}$ with join as addition and meet as multiplication has $\mathbf{FMat}(\mathbb{2}) = \mathbf{FRel}$.

2.3.2 Products, coproducts and biproducts in FRel and FMat(R)

We now begin to explore the properties of FRel, and FMat(R). First we observe that there is an obvious involution on FRel given by swapping the finitary and cofinitary sets:

$$\begin{array}{ccc}
 (X, \mathcal{A}, \mathcal{B}) & \longmapsto & X^* = (X, \mathcal{B}, \mathcal{A}) \\
 \downarrow R & \longmapsto & \uparrow R^\circ \\
 (X', \mathcal{A}', \mathcal{B}') & \longmapsto & X'^* = (X', \mathcal{B}', \mathcal{A}')
 \end{array}$$

$(-)^* : \text{FRel}^{\text{op}} \rightarrow \text{FRel};$

For FMat(R) this involution is given by transposing the matrix:

$$\begin{array}{ccc}
 (X, \mathcal{A}, \mathcal{B}) & \longmapsto & X^* = (X, \mathcal{B}, \mathcal{A}) \\
 \downarrow (r_{i,j})_{i \in X, j \in X'} & \longmapsto & \uparrow (r_{j,i})_{j \in X', i \in X} \\
 (X', \mathcal{A}', \mathcal{B}') & \longmapsto & X'^* = (X', \mathcal{B}', \mathcal{A}')
 \end{array}$$

$(-)^* : \text{FMat}(R)^{\text{op}} \rightarrow \text{Mat}(R);$

This involution clearly has the property that $(X^*)^* = X$. This symmetry means that we can take a “one-sided” approach to establishing structures using the involution to automatically produce the dual structure. Shortly we will see that this involution is actually the duality of the $*$ -autonomous structure of both categories.

The first observation is:

Lemma 2.37. *FRel and FMat(R), for any commutative rig R , have arbitrary products and coproducts.*

Proof. Let $(X_i, F(X_i), F(X_i)^\perp)$ be a set of finiteness spaces. We shall work for the coproduct as the argument for the product is dual. The coproduct $\coprod_{i \in I} X_i$ of finiteness spaces has its web given by the disjoint union of the webs with injections $\sigma_i : X_i \rightarrow \sqcup_{i \in I} X_i$. Its finitary sets are given by $\mathcal{A} = \{\bigcup_{i \in I'} A_i \sigma_i \mid A_i \in F(X_i) \text{ \& } I' \subseteq_f I\}$ while the cofinitary sets are given by $\mathcal{B} = \{\bigcup_{i \in I} B_i \sigma_i \mid B_i \in F(X_i)^\perp\}$. First note that the injections $\sigma_i : X_i \rightarrow \sqcup_{i \in I} X_i$ are certainly finiteness relations. As a relation the comparison map for a family of relations, $R_i : X_i \rightarrow Y$, is unique and given by $\bigcup_{i \in I} \sigma_i^\circ R_i : \sqcup_{i \in I} X_i \rightarrow Y$: we must check this is a finiteness relation assuming each R_i is. Note that if $B \in F(Y)^\perp$ then

$$B \left(\bigcup_{i \in I} \sigma_i^\circ R_i \right)^\circ = \bigcup_{i \in I} B R_i^\circ \sigma_i$$

where $B R_i^\circ \in F(X_i)^\perp$ so this is in \mathcal{B} . Conversely, given $\bigcup_{i \in I'} A_i \sigma_i \in \mathcal{A}$ mapping this forward

gives:

$$\left(\bigcup_{i \in I'} A_i \sigma_i \right) \left(\bigcup_{i \in I} \sigma_i^\circ R_i \right) = \bigcup_{i \in I'} A_i R_i$$

which is a finite union of finitary sets of Y and so a finitary set.

Finally, we must check that, as we have defined it, $\coprod_{i \in I} X_i$ is a finiteness set, that is $\mathcal{A}^\perp = \mathcal{B}$ and $\mathcal{B}^\perp = \mathcal{A}$. Toward this end suppose $H \subseteq \bigsqcup_{i \in I} X_i$ is orthogonal to \mathcal{B} then, restricting to each X_i , $H \sigma_i^\circ \cap A_i$ is finite for each $A_i \in F(X_i)^\perp$ and there can only be finitely i for which this is non-empty. But this means $H \in \mathcal{A}$. Conversely, suppose $K \subseteq \bigsqcup_{i \in I} X_i$ is orthogonal to \mathcal{A} then restricting to X_i means that each $K \sigma_i^\circ \in F(X_i)^\perp$ which means $K = \bigcup_{i \in I} B_i \sigma$ and so is in \mathcal{B} .

For $\mathbf{FMat}(R)$ the coproduct has the same underlying finiteness space: it is then straightforward to check that all the required maps have the appropriate support. \square

Note that in both \mathbf{FRel} and $\mathbf{FMat}(R)$ finite products are the same as finite coproducts. Thus, both categories have biproducts and so are additively enriched (that is, they are enriched in commutative monoids).

Corollary 2.38. *Both \mathbf{FRel} and $\mathbf{FMat}(R)$ have (finite) biproducts.*

In \mathbf{FRel} the additive enrichment is given by the union of the underlying relations. In $\mathbf{FMat}(R)$ the additive enrichment is given by the pointwise addition of matrices.

2.3.3 The tensor structure in \mathbf{FRel} and $\mathbf{FMat}(R)$

\mathbf{FRel} has a symmetric tensor product and this can be used to obtain a corresponding tensor product on $\mathbf{FMat}(R)$. We shall start by focusing on \mathbf{FRel} and define $X \otimes Y := (X \times Y, F(X \otimes Y), F(X \otimes Y)^\perp)$, where

$$F(X \otimes Y) := \downarrow \{A \times B \mid A \in F(X), B \in F(Y)\}$$

where $\downarrow \mathcal{A} := \{A' \mid A' \subseteq A, A \in \mathcal{A}\}$ is the downward closure of the set of subsets \mathcal{A} . To show this is well-defined we must prove that $F(X \otimes Y) = F(X \otimes Y)^{\perp\perp}$ (this is essentially [64, Lemma 2]):

Lemma 2.39. *For any finiteness spaces X and Y , $X \otimes Y = (X, F(X \otimes Y), F(X \otimes Y)^\perp)$, as defined above, is a well-defined finiteness space.*

Proof. We must show that any $Q \subseteq X \times Y$ which intersects finitely with any $P \subseteq X \times Y$ which, in turn, intersects finitely with all $R \in F(X \otimes Y)$ must already be in $F(X \otimes Y)$. Suppose for contradiction that Q is not in $F(X \otimes Y)$, as defined; this means there is no

$A \in F(X)$ and $B \in F(Y)$ such that $Q \subseteq A \times B$. This, in turn, means that $\text{dom}(Q) \notin F(X)$ or $\text{cod}(Q) \notin F(Y)$. Without the loss of generality, we may assume the former: this means that there is a $C \in F(X)^\perp$ with $C \cap \text{dom}(Q)$ infinite. We may “thicken” $C \cap \text{dom}(Q)$ to $C' : X \rightarrow Y$ by choosing for each $c \in C \cap \text{dom}(Q)$ a $y_c \in Y$ so that $(c, y_c) \in Q$. Then $C' \cap Q$ is certainly infinite, however, $C' \in F(X \otimes Y)$ as intersecting with any $A \times B$ with $A \in F(X)$ and $B \in F(Y)$ is finite as $C \cap A$ is finite. But this means Q cannot be in $F(X \otimes Y)^{\perp\perp}$. \square

By the discussion above Lemma 2.33, as $Q \in F(X \cap Y)^\perp$ precisely when $Q \cap A \times B$ is finite for all $A \in F(X)$ and $B \in F(Y)$, Q may be characterized as a finiteness relation $Q : X^* \rightarrow Y$ or $Q^\circ : Y^* \rightarrow X$. This immediately gives:

Lemma 2.40. *Let X and Y be a finiteness spaces then $P \subseteq X \times Y$ then the following are equivalent:*

- (i) $P \in F(X \otimes Y)^\perp$;
- (ii) $P \cap A \times B$ is finite for all $A \in F(X)$ and $B \in F(Y)$;
- (iii) For all $A \in F(X)$, $A \triangleright P \in F(Y)^\perp$ and, for all $B \in F(Y)$, $P \triangleleft B \in F(X)^\perp$;
- (iv) For all $A \in F(X)$, $A \triangleright P \in F(Y)^\perp$ and, for every $y \in Y$, $P \triangleleft \{y\} \in F(X)^\perp$;
- (v) For every $x \in X$, $\{x\} \triangleright P \in F(Y)^\perp$ and, for all $B \in F(Y)$, $P \triangleleft B \in F(X)^\perp$.

The unit of tensor is given by the one element set with only finiteness structure possible:
 $\top := (\{\star\}, \mathcal{P}(\{\star\}), \mathcal{P}(\{\star\}))$.

Given finiteness relations, $X \xrightarrow{R} X'$, and $Y \xrightarrow{S} Y'$, then:

$$R \otimes S := \{((x, y), (x', y')) \mid xRx', ySy'\}$$

as in **Rel**, is clearly a finiteness relation. The associator and unitors for this tensor product are the same as in **Rel**. Thus, the associator is the following relation:

$$a_\otimes := (((x, y), z), (x, (y, z))) \mid x \in X, y \in Y, z \in Z$$

and this clearly gives a bijection between $F((X \otimes Y) \otimes Z) = \downarrow\{(a, b), c) \mid a \in A \in F(X), b \in B \in F(Y), c \in C \in F(Z)\}$, and $F(X \otimes (Y \otimes Z)) = \downarrow\{(a, (b, c)) \mid a \in A \in F(X), b \in B \in F(Y), c \in C \in F(Z)\}$.

The tensor product is also symmetric, with the symmetry relation as in **Rel**.

If M and N are finiteness matrices, $M \otimes N$ is given by the outer product, while the finiteness matrices for the associators, and the unitors are given by the characteristic matrices

(where the entries are either 0 or 1) of the corresponding coherence relations in \mathbf{FRel} . The commutativity of the rig makes the tensor products symmetric.

Lemma 2.41. \mathbf{FRel} and $\mathbf{FMat}(R)$ have a symmetric tensor product $-\otimes-$ and by de Morgan duality a further symmetric tensor product, called the **par**, $-\oplus-$ where $X \oplus Y := (X^* \otimes Y^*)^*$.

The tensor and par do not coincide in general, however, note that, as

$$\begin{aligned} F(X \oplus Y) &:= F((X^* \otimes Y^*)^*) = F(X^* \otimes Y^*)^\perp = \{A' \times B' \mid A' \in F(X)^\perp, B' \in F(Y)^\perp\}^\perp \\ &= \{G \mid \forall A' \in F(X)^\perp, B' \in F(Y)^\perp. G \cap A' \times B' \text{ is finite}\} \end{aligned}$$

for $A \in F(X)$ and $B \in F(Y)$ we therefore have $A \times B \in F(X \oplus Y)$ as $A \times B \cap A' \times B'$ is finite. This means the map $\mathbf{mx} : A \otimes Y \rightarrow A \oplus Y$, called the mix map, which is the identity map on the webs is a finiteness relation. It is, as we shall see, not generally an isomorphism. The unit for the par is $\perp := \top^* = (\{\star\}, \mathcal{P}(\{\star\}), \mathcal{P}(\{\star\})) = \top$. Thus, the units for the two tensors coincide. This suggests the structure of an isomix category. Next, we show that there is a linear distributor in both \mathbf{FRel} and $\mathbf{FMat}(R)$. Preliminary to this we observe:

Lemma 2.42. For any finiteness spaces X, Y , and Z , the following hold:

- (i) $F(X \otimes Y) \subseteq F(X \oplus Y)$;
- (ii) $F(X^* \otimes Y^*) \subseteq F(X \otimes Y)^\perp$;
- (iii) $F((X^* \otimes Y^*) \otimes Z) \subseteq F((X \otimes Y)^* \otimes Z)$.

Proof.

- (i) As discussed above.
- (ii) $F(X \otimes Y)^\perp = F((X \otimes Y)^*) = F((X^{**} \otimes Y^{**})^*) = F(X^* \oplus Y^*) \supseteq F(X^* \otimes Y^*)$.
- (iii) $F((X^* \otimes Y^*) \otimes Z) = F((X^* \otimes Y^*)^{**} \otimes Z) = F((X \oplus Y)^* \otimes Z) \subseteq F((X \otimes Y)^* \otimes Z)$.

□

Proposition 2.43. \mathbf{FRel} , and $\mathbf{FMat}(R)$ are symmetric LDCs.

Proof. The linear distributor for \mathbf{FRel} , $\partial^L : X \otimes (Y \oplus Z) \rightarrow (X \otimes Y) \oplus Z$ on the webs is the associator in \mathbf{Rel} . To show this is a finiteness relation (although it is not an isomorphism) it is sufficient to prove that if $A \in F(X \otimes (Y \oplus Z))$ then $\mathbf{cod}(Aa_\times) \in F((X \otimes Y) \oplus Z)$ as a_\times certainly has the preimage of singleton sets in $F(X \otimes (Y \oplus Z))^\perp$ as they are singleton sets.

Observe that

$$\begin{aligned}
F(X \otimes (Y \oplus Z)) &= F(X \otimes (Y^* \otimes Z^*)^*) \\
&= F((X)^{**} \otimes (Y^* \otimes Z^*)^*) && \text{(as } X^{**} = X) \\
&\subseteq F(X^* \otimes (Y^* \otimes Z^*))^\perp && \text{(Lemma 2.42(ii))} \\
&\simeq F((X^* \otimes Y^*) \otimes Z^*)^\perp && \text{(Associativity of tensor)} \\
&\subseteq F((X \otimes Y)^* \otimes Z^*)^\perp && \text{(Lemma 2.42(iii))} \\
&= F((X \otimes Y) \oplus Z) \\
&\text{(as } (X, F(X), F(X)^\perp)^* = (X^*, F(X^*), F(X^*)^\perp) := (X, F(X)^\perp, F(X)))
\end{aligned}$$

For $\mathbf{FMat}(R)$, the left distributor is the characteristic matrix of ∂^L . \square

Proposition 2.44. *\mathbf{FRel} , and $\mathbf{FMat}(R)$ are symmetric isomix $*$ -autonomous categories with respect to the involution $(-)^*$.*

Proof. By Lemma 2.43, \mathbf{FRel} is an LDC. It is an isomix category because $\mathbf{m} : \top \rightarrow \perp = 1_{\{\star\}}$ is an isomorphism.

To show this we must demonstrate that we have a “cap” $\top \rightarrow A \oplus A^*$ and a “cup” $A^* \otimes A \rightarrow \perp$: on the webs these are the corresponding maps in \mathbf{Rel} given by the diagonal subset seen as a relation in two ways. It suffices to show that these maps (which are dual) are finiteness relations. As the required duality identities are satisfied by the underlying relations, they are also satisfied in \mathbf{FRel} .

Consider $\eta : \top \rightarrow A \otimes A^*$ where $\eta := \{(\star, (a, a)) \mid a \in A\}$ as the finitary sets of \top are just $\{\}$ and $\{\star\}$ and η° certainly has preimages of cofinitary sets cofinitary it remain only to show that $\Delta_A := \{(a, a) \mid a \in A\}$ is finitary in $A \otimes A^*$. However, this is so if and only if Δ_A is a finiteness relation from $A \rightarrow A$ (by Lemma 2.40 suitably dualized) ... which it certainly is as it is the identity relation!

This argument translates into $\mathbf{FMat}(R)$ using the characteristic matrices of these relations and the fact that all the coherence maps are given by the corresponding characteristic matrices. \square

As \mathbf{FRel} is $*$ -autonomous, it is self-enriched. The internal hom is given as usual by $X \multimap Y = X^* \otimes Y = (X \otimes Y^*)^*$. Thus, $X \multimap Y = (X \times Y, F(X \otimes Y^\perp)^\perp, F(X \otimes Y^\perp))$. The same argument applies to $\mathbf{FMat}(R)$.

Lemma 2.45. *Let X , and Y be finiteness spaces, then $A \in F(X \multimap Y)$ if and only if $A : X \rightarrow Y$ is a finiteness relation.*

2.3.4 The core of FRel and FMat(R)

Recall that, for any isomix category \mathbb{X} , the **core** of \mathbb{X} , $\text{Core}(\mathbb{X}) \subseteq \mathbb{X}$, is the full subcategory consisting of objects U such that for any object $X \in \mathbb{X}$, $\text{mx} : U \otimes X \rightarrow U \oplus X$ (and $\text{mx} : X \otimes U \rightarrow X \oplus U$) is an isomorphism. The core is always closed to tensor and par and the units. Thus, the core of an isomix category is an isomix category with $\text{mx} : U \otimes V \rightarrow U \oplus V$ is a natural isomorphism.

In FRel, the mix map is given by the identity map on the webs and in FMat(R) it is given by the characteristic function of this identity map. Our objective in this subsection is to give a complete description of the core of FRel and FMat(R):

Proposition 2.46. *$U \in \text{Core}(\text{FRel})$ if and only if U is finite. Similarly, $U \in \text{Core}(\text{FMat}(R))$ if and only if U is finite.*

Proof. Suppose U is a finite set then $U = U^*$ as $F(U) = F(U)^\perp = \mathcal{P}(U)$. We shall prove that $F(U \otimes Y) = F(U \oplus Y)$ for all Y . We first prove this for FRel:

U finite $\Rightarrow U \in \text{Core}(\text{FRel})$: It suffices to show that $R \in F(U \oplus Y)$ then $R \in F(U \otimes Y)$.

However, $R \in F(U \oplus Y) = F(U^* \oplus Y)$ if and only if $R : U \rightarrow Y$ is a finiteness relation. As R is a finiteness relation, because $U \in F(U)$, $\text{cod}(R) \in F(Y)$ but then $R \subseteq U \times \text{cod}(R)$ showing $R \in F(U \otimes Y)$.

$U \in \text{Core}(\text{FRel}) \Rightarrow U$ is finite: We prove the converse statement: if U is infinite set, that there is a finiteness space, Y , such that $F(X \otimes Y) \subseteq F(X \oplus Y)$. Choose $Y = (Y, \mathcal{P}(Y), \mathcal{P}_f(Y))$ such that there is an injective function $\alpha : U \rightarrow Y$: this forces Y to be infinite. Because $|U|$ is infinite, there is an infinite $Q \subseteq U$ such that $Q \in F(U)^\perp$ or $Q \in F(U)$. Without loss of generality, we may assume that $Q \in F(U)^\perp$.

Define $R := \{(x, \alpha(x)) \mid x \in Q\}$, then $R \in F(U \otimes Y)$ because the following two conditions hold:

- (i) For all $A \in F(U)^\perp$, $A \triangleright R \in F(Y)$ as $F(Y) \in \mathcal{P}(Y)$.
- (ii) For all $y \in Y$, $R \triangleleft \{y\} \in F(X)^\perp$, as α is a monic, either $R \triangleleft \{y\} = \emptyset$, or $R \triangleright \{y\} = \{x\}$ where $\alpha(x) = y$. Since, $R \triangleright \{y\}$ is a finite, $R \triangleright \{y\} \in F(X)^\perp$.

Next we show, to complete the proof, that $R \notin F(X \otimes Y)$. $R \in F(X \otimes Y)$ if and only $R \subseteq A \times B$, where $A \in F(U)$ and $B \in F(Y)$. However, $\text{dom}(R) = Q \in F(U)^\perp$. Since, Q is infinite, Q cannot also be a member of $F(U)$. Thus, $R \notin F(X \otimes Y)$.

The same proof applies to FMat(R) by transposing to the characteristic functions of the finiteness relationships. □

Corollary 2.47.

(i) $\text{Core}(\text{FRel})$ is the category of finite sets and relations.

(ii) $\text{Core}(\text{FMat}(R))$ is (equivalent to) the category of finite-dimensional matrices over the rig R .

Chapter 3

Dagger linearly distributive categories

In this chapter we define dagger linearly distributive categories, dagger linear functors and transformations, and provide examples. We also explore the relationship among dual, dagger and conjugation functors for LDCs.

3.1 Dagger for LDCs

Conventionally, in categorical quantum mechanics a dagger is defined as a contravariant endofunctor which is stationary on objects ($A^\dagger = A$) and an involution ($f^{\dagger\dagger} = f$). However, in an LDC, the dagger must minimally flip the tensor products to maintain the directionality of the distributor maps. Recall that, $\partial^\dagger : (A \otimes B) \oplus C \rightarrow A \otimes (B \oplus C)$ is not a valid map in an LDC. Hence, for LDCs we cannot expect the dagger to be stationary on objects, however, it is still possible for it to be an involution. This section deals with the coherences of \dagger -functor for LDC and its variants, that is, mix and isomix categories.

3.1.1 Dagger linearly distributive categories

Before proceeding to define the dagger functor for LDCs, the notion of the opposite LDC and the notion of a contravariant linear functors have to be developed.

If $(\mathbb{X}, \otimes, \top, \oplus, \perp)$ is a linearly distributive category, the **opposite linear distributive category** is $(\mathbb{X}, \otimes, \top, \oplus, \perp)^{\text{op}} := (\mathbb{X}^{\text{op}}, \oplus, \perp, \otimes, \top)$ where \mathbb{X}^{op} is the usual opposite category with the monoidal structures flipped as follows:

$$\otimes^{\text{op}} := \oplus \quad \top^{\text{op}} := \perp \quad \oplus^{\text{op}} := \otimes \quad \perp^{\text{op}} := \top$$

$(_)^{\text{op}}$ is an endo functor for the category of LDCs and linear functors. It is also an involution:

$$(\mathbb{X}, \otimes, \top, \oplus, \perp)^{\text{op op}} = (\mathbb{X}, \otimes, \top, \oplus, \perp).$$

Let $(F_{\otimes}, F_{\oplus}) : (\mathbb{X}, \otimes, \top, \oplus, \perp)^{\text{op}} \rightarrow (\mathbb{X}, \otimes, \top, \oplus, \perp)$ be a linear functor. The opposite linear functor $(F_{\otimes}, F_{\oplus})^{\text{op}} : (\mathbb{X}, \otimes, \top, \oplus, \perp) \rightarrow (\mathbb{X}, \otimes, \top, \oplus, \perp)^{\text{op}}$ given by the pair of opposite functors $(F_{\oplus}^{\text{op}}, F_{\otimes}^{\text{op}})$. Observe that F^{op} is a mix Frobenius linear functor if and only if F is.

Definition 3.1. A **dagger linearly distributive category** (\dagger -LDC), is an LDC, \mathbb{X} , with a contravariant Frobenius linear functor $(-)^{\dagger} : \mathbb{X}^{\text{op}} \rightarrow \mathbb{X}$ which is a linear involutive equivalence $(-)^{\dagger} \dashv (-)^{\dagger\text{op}} : \mathbb{X}^{\text{op}} \rightarrow \mathbb{X}$.

We unfold this definition in Proposition 3.2. However, first note that saying the dagger is an **involutive** equivalence asserts that the unit and counit of the equivalence are the same (although one is in the opposite category). Thus, the adjunction expands to take the form $(\iota, \iota) : (-)^{\dagger} \dashv (-)^{\dagger\text{op}} : \mathbb{X}^{\text{op}} \rightarrow \mathbb{X}$. However, the unit and counit are linear natural transformations so ι expands to $\iota = (\iota_{\otimes}, \iota_{\oplus})$. As the dagger functor is a left adjoint, it is strong and, thus, is normal. Furthermore, as the unit of an equivalence, ι is a linear natural isomorphism, this means $\iota = (\iota_{\otimes}, \iota_{\oplus})$ satisfies the requirements of Lemma 2.24, implying that $\iota_{\otimes}^{-1} = \iota_{\oplus}$. Simplifying notation we shall set $\iota := \iota_{\oplus}$ so the unit linear transformation is $\iota := (\iota^{-1}, \iota)$. We then can simplify the requirements of ι to the map $\iota : A \rightarrow (A^{\dagger})^{\dagger}$ which we refer to as the **involutor**.

A **symmetric \dagger -LDC** is a \dagger -LDC which is a symmetric LDC for which the dagger is a symmetric linear functor. A **cyclic \dagger -*-autonomous category** is a \dagger -LDC with chosen left and right duals, and a cyclor which is preserved by the dagger. A **\dagger -mix** category is a \dagger -LDC for which $(-)^{\dagger} : \mathbb{X}^{\text{op}} \rightarrow \mathbb{X}$ is a mix functor. As the dagger functor is strong (and so normal) if the category is an isomix category then being **\dagger -mix** already implies that the dagger is an isomix functor. Thus, a **\dagger -isomix** category is a \dagger -mix category which happens to be an isomix category.

In the remainder of the section, we unfold the definition of a \dagger -isomix category and give the coherence requirements explicitly.

Proposition 3.2. A dagger linearly distributive category is an LDC with a functor $(-)^{\dagger} : \mathbb{X}^{\text{op}} \rightarrow \mathbb{X}$ and natural isomorphisms

$$\begin{array}{ccc} \mathbf{laxors:} & A^{\dagger} \otimes B^{\dagger} \xrightarrow{\lambda_{\otimes}} (A \oplus B)^{\dagger} & A^{\dagger} \oplus B^{\dagger} \xrightarrow{\lambda_{\oplus}} (A \otimes B)^{\dagger} \\ & \top \xrightarrow{\lambda_{\top}} \perp^{\dagger} & \perp \xrightarrow{\lambda_{\perp}} \top^{\dagger} \\ \mathbf{involutor:} & A \xrightarrow{\iota} (A^{\dagger})^{\dagger} & \end{array}$$

such that the following coherences hold:

[†-ldc.1] *Interaction of $\lambda_{\otimes}, \lambda_{\oplus}$ with associators:*

$$\begin{array}{ccc}
A^\dagger \otimes (B^\dagger \otimes C^\dagger) \xrightarrow{a_{\otimes}^{-1}} (A^\dagger \otimes B^\dagger) \otimes C^\dagger & & A^\dagger \oplus (B^\dagger \oplus C^\dagger) \xrightarrow{a_{\oplus}^{-1}} (A^\dagger \oplus B^\dagger) \oplus C^\dagger \\
1 \otimes \lambda_{\otimes} \downarrow & & \downarrow \lambda_{\otimes} \otimes 1 \\
A^\dagger \otimes (B \oplus C)^\dagger & & (A \oplus B)^\dagger \otimes C^\dagger \\
\lambda_{\otimes} \downarrow & & \downarrow \lambda_{\otimes} \\
(A \oplus (B \oplus C))^\dagger \xrightarrow{a_{\oplus}^\dagger} ((A \oplus B) \oplus C)^\dagger & & (A \otimes (B \otimes C))^\dagger \xrightarrow{a_{\otimes}^\dagger} ((A \otimes B) \otimes C)^\dagger
\end{array}$$

[†-ldc.2] *Interaction of $\lambda_{\top}, \lambda_{\perp}$ with unitors:*

$$\begin{array}{ccc}
\top \otimes A^\dagger \xrightarrow{\lambda_{\top} \otimes 1} \perp^\dagger \otimes A^\dagger & & \perp \oplus A^\dagger \xrightarrow{\lambda_{\perp} \oplus 1} \top^\dagger \oplus A^\dagger \\
u_{\otimes}^R \downarrow & & \downarrow \lambda_{\otimes} \\
A^\dagger \xrightarrow{(u_{\oplus}^R)^\dagger} (\perp \oplus A)^\dagger & & A^\dagger \xrightarrow{(u_{\otimes}^R)^\dagger} (\top \otimes A)^\dagger
\end{array}$$

and two symmetric diagrams for u_{\otimes}^L and u_{\oplus}^L must also be satisfied.

[†-ldc.3] *Interaction of $\lambda_{\otimes}, \lambda_{\oplus}$ with linear distributors:*

$$\begin{array}{ccc}
A^\dagger \otimes (B^\dagger \oplus C^\dagger) \xrightarrow{\partial^L} (A^\dagger \otimes B^\dagger) \oplus C^\dagger & & (A^\dagger \oplus B^\dagger) \otimes C^\dagger \xrightarrow{\partial^R} A^\dagger \oplus (B^\dagger \otimes C^\dagger) \\
1 \otimes \lambda_{\oplus} \downarrow & & \lambda_{\otimes} \oplus 1 \downarrow \\
A^\dagger \otimes (B \otimes C)^\dagger & & (A \oplus B)^\dagger \otimes C^\dagger \\
\lambda_{\otimes} \downarrow & & \downarrow \lambda_{\oplus} \\
(A \oplus (B \otimes C))^\dagger \xrightarrow{(\partial^R)^\dagger} ((A \oplus B) \otimes C)^\dagger & & ((A \otimes B) \oplus C)^\dagger \xrightarrow{(\partial^L)^\dagger} (A \otimes (B \oplus C))^\dagger
\end{array}$$

[†-ldc.4] *Interaction of $\iota : A \rightarrow A^{\dagger\dagger}$ with $\lambda_{\otimes}, \lambda_{\oplus}$:*

$$\begin{array}{ccc}
A \oplus B \xrightarrow{\iota} ((A \oplus B)^\dagger)^\dagger & & A \otimes B \xrightarrow{\iota} ((A \otimes B)^\dagger)^\dagger \\
\iota_{\oplus} \downarrow & & \downarrow \lambda_{\otimes}^\dagger \\
(A^\dagger)^\dagger \oplus (B^\dagger)^\dagger \xrightarrow{\lambda_{\oplus}} (A^\dagger \otimes B^\dagger)^\dagger & & (A^\dagger)^\dagger \otimes (B^\dagger)^\dagger \xrightarrow{\lambda_{\otimes}} (A^\dagger \oplus B^\dagger)^\dagger
\end{array}$$

[†-ldc.5] *Interaction of $\iota : A \rightarrow A^{\dagger\dagger}$ with $\lambda_{\top}, \lambda_{\perp}$:*

$$\begin{array}{ccc}
\perp \xrightarrow{\iota} (\perp^\dagger)^\dagger & & \top \xrightarrow{\iota} (\top^\dagger)^\dagger \\
\lambda_{\perp} \searrow & & \downarrow \lambda_{\top}^\dagger \\
& & \top^\dagger
\end{array}$$

[†-ldc.6] $\iota_{A^\dagger} = (\iota_A^{-1})^\dagger : A^\dagger \rightarrow A^{\dagger\dagger\dagger}$

The dagger structure is obtained from the previous proposition using strong monoidal laxors: to form a linear functor the laxor λ_{\oplus} needs to be reversed by taking its inverse. Then, we have $\nu_{\otimes}^l = \nu_{\otimes}^r := \lambda_{\oplus}^{-1}$ and $\nu_{\oplus}^l = \nu_{\oplus}^r := \lambda_{\otimes}$. Once this adjustment is made all the required coherences for \dagger to be a linear functor are present. Note that **[†-ldc.6]** equivalently expresses the triangle identities of the adjunction $(\iota, \iota) :: \dagger^{\text{op}} \dashv \dagger : \mathbb{X}^{\text{op}} \rightarrow \mathbb{X}$. The coherences for the involutor asserts that it is a monoidal transformation for both the tensor and par: by Lemma 2.28 (ii) this suffices to show that it is a linear transformation.

A **symmetric †-LDC** is a †-LDC which is a symmetric LDC and for which the following additional diagrams commute:

[†-ldc.7] Interaction of $\lambda_{\otimes}, \lambda_{\oplus}$ with symmetry maps:

$$\begin{array}{ccc} A^{\dagger} \otimes B^{\dagger} & \xrightarrow{\lambda_{\otimes}} & (A \oplus B)^{\dagger} & A^{\dagger} \oplus B^{\dagger} & \xrightarrow{\lambda_{\oplus}} & (A \otimes B)^{\dagger} \\ c_{\otimes} \downarrow & & \downarrow c_{\oplus}^{\dagger} & c_{\oplus} \downarrow & & \downarrow c_{\otimes}^{\dagger} \\ B^{\dagger} \otimes A^{\dagger} & \xrightarrow{\lambda_{\otimes}} & (B \oplus A)^{\dagger} & B^{\dagger} \oplus A^{\dagger} & \xrightarrow{\lambda_{\oplus}} & (B \otimes A)^{\dagger} \end{array}$$

A **†-mix category** is a †-LDC which has a mix map and satisfies the following additional coherence:

$$\text{[†-mix]} \quad \begin{array}{ccc} \perp & \xrightarrow{m} & \top \\ \lambda_{\perp} \downarrow & & \downarrow \lambda_{\top} \\ \top^{\dagger} & \xrightarrow{m^{\dagger}} & \perp^{\dagger} \end{array}$$

If m is an isomorphism, then \mathbb{X} is a **†-isomix category** and, since $(-)^{\dagger}$ is normal, $(-)^{\dagger}$ is an isomix Frobenius functor.

Lemma 3.3. *Suppose \mathbb{X} is a †-mix category then the following diagram commutes:*

$$\begin{array}{ccc} A^{\dagger} \otimes B^{\dagger} & \xrightarrow{m^{\times}} & A^{\dagger} \oplus B^{\dagger} \\ \lambda_{\otimes} \downarrow & & \downarrow \lambda_{\oplus} \\ (A \oplus B)^{\dagger} & \xrightarrow{m^{\times \dagger}} & (A \otimes B)^{\dagger} \end{array}$$

Proof. The proof follows directly from Lemma 2.23. □

With respect to its applications to quantum theory, this thesis primarily focuses on †-isomix categories. As we will see in Section 4.1, the notion of unitary objects and unitary isomorphisms is supported only within a †-isomix category.

It is useful to observe that the core of a mix category is closed under taking the dagger and duals.

Lemma 3.4. *Suppose \mathbb{X} is a †-mix category and $A \in \text{Core}(\mathbb{X})$ then $A^{\dagger} \in \text{Core}(\mathbb{X})$.*

Proof. The natural transformation $A^\dagger \otimes X \xrightarrow{\text{mx}} A^\dagger \oplus X$ is an isomorphism as follows:

$$\begin{array}{ccccc}
 A^\dagger \otimes X & \xrightarrow{1 \otimes \iota} & A^\dagger \otimes X^{\dagger\dagger} & \xrightarrow{\lambda_\otimes} & (A \oplus X^\dagger)^\dagger \\
 \text{mx} \downarrow & (\text{nat. mx}) & \text{mx} \downarrow & \text{lem. 3.3} & \downarrow \text{mx}^\dagger \\
 A^\dagger \oplus X & \xrightarrow{1 \oplus \iota} & A^\dagger \oplus X^{\dagger\dagger} & \xrightarrow{\lambda_\oplus} & (A \otimes X^\dagger)^\dagger
 \end{array}$$

□

Lemma 3.5. *Let \mathbb{X} be \dagger -LDC. If $A \dashv B$ then $B^\dagger \dashv A^\dagger$.*

Proof. The statement follows from Lemma 2.14: Frobenius functors preserve linear adjoints. Explicitly, if $(\eta, \epsilon) : A \dashv B$ then $(\lambda_\top \epsilon^\dagger \lambda_\oplus^{-1}, \lambda_\otimes \eta^\dagger \lambda_\perp^{-1}) : B^\dagger \dashv A^\dagger$. □

Suppose \mathbb{X} is a \dagger -*-autonomous category and $(\eta^*, \epsilon^*) : A^* \dashv A$, then $((\epsilon^*)^\dagger, (\eta^*)^\dagger) : A^\dagger \dashv (A^*)^\dagger$, where $((\epsilon^*)^\dagger, (\eta^*)^\dagger) := (\lambda_\top \epsilon^* \lambda_\oplus^{-1}, \lambda_\otimes \eta^* \lambda_\perp^{-1})$. We draw $(\epsilon^*)^\dagger$ and $(\eta^*)^\dagger$ as dagger cups, and $(\eta^*)^\dagger$ and $(\epsilon^*)^\dagger$ as dagger caps which are pictorially represented as follows:

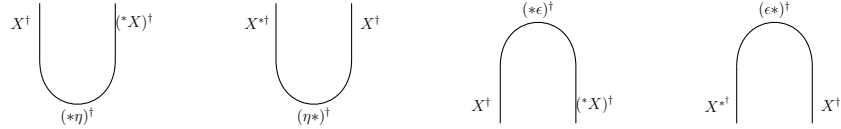

A \dagger -*-autonomous category is a **cyclic** \dagger -*-autonomous category when the dagger preserves the cyclor in the following sense.

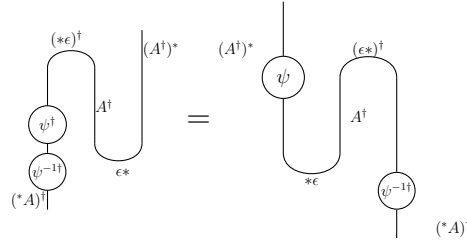

Lemma 3.6. *In a cyclic, \dagger -*-autonomous category,*

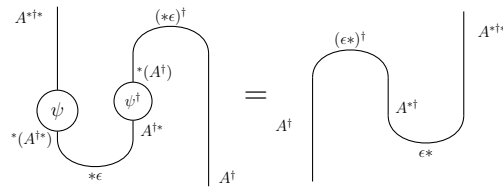

Proof. Proved by direct application of Lemma 2.21. □

3.1.2 Sequent calculus for †-linear logic

†-LDCs provide a categorical semantics for the proof theory for multiplicative linear logic with the dagger (†-MLL). Along with the sequent rules of MLL, †-MLL includes the additional rules (†), and (ι), as shown in Figure 3.1.

$$(\dagger) \frac{\Gamma \vdash \Delta}{\Delta^\dagger \vdash \Gamma^\dagger} \quad (\iota L) \frac{\Gamma_1, A, \Gamma_2 \vdash \Delta}{\Gamma_1, A^{\dagger\dagger}, \Gamma_2 \vdash \Delta} \quad (\iota R) \frac{\Gamma \vdash \Delta_1, A, \Delta_2}{\Gamma \vdash \Delta_1, A^{\dagger\dagger}, \Delta_2}$$

where, if $\Gamma = A_1, A_2, A_3, \dots, A_n$, then $\Gamma^\dagger = A_1^\dagger, A_2^\dagger, A_3^\dagger, \dots, A_n^\dagger$

Figure 3.1: Sequent rules for †

The rule (†) corresponds to the contravariance of the †-functor, and the rules (ιL) and (ιR) correspond to the involutor natural isomorphism, $\iota : A \rightarrow A^{\dagger\dagger}$. The derivation of (ιL)⁽⁻¹⁾ and (ιR)⁽⁻¹⁾ are shown in Figure 3.2.

$$\frac{A \vdash A}{A \vdash A^{\dagger\dagger}} \iota R \quad \frac{A \vdash A}{A^{\dagger\dagger} \vdash A} \iota L$$

Figure 3.2: Sequent proof:- ι is an isomorphism

One can derive the unit and the tensor laxors using the sequent rules, (†), (ιL), and (ιR). For example, Figure 3.3 shows the derivation of the ⊕-laxor, and Figure 3.4 shows the derivation of the ⊥-laxor. The steps labelled (*) in Figure 3.3 involve a cut. This leads to the question of whether to system satisfies cut elimination: with the current presentation, the system not appear to satisfy cut elimination.

$$\frac{\frac{\frac{A \vdash A \text{ id}}{A, B \vdash A \otimes B} \otimes R \quad \frac{B \vdash B \text{ id}}{(A \otimes B)^\dagger \vdash A^\dagger, B^\dagger} \oplus R}{(A \otimes B)^\dagger \vdash A^\dagger \oplus B^\dagger} \oplus R \quad \frac{\frac{\frac{\frac{A^\dagger \vdash A^\dagger \text{ id}}{A^\dagger \oplus B^\dagger \vdash A^\dagger, B^\dagger} \dagger \quad \frac{B^\dagger \vdash B^\dagger \text{ id}}{A^{\dagger\dagger}, B^{\dagger\dagger} \vdash (A^\dagger \oplus B^\dagger)^\dagger} \dagger}{A, B \vdash (A^\dagger \oplus B^\dagger)^\dagger} (*) \quad 2 \times \iota L^{(-1)} \quad \frac{A \otimes B \vdash (A^\dagger \oplus B^\dagger)^\dagger}{A \otimes B \vdash (A^\dagger \oplus B^\dagger)^\dagger} \otimes L}{\frac{(A^\dagger \oplus B^\dagger)^{\dagger\dagger} \vdash (A \otimes B)^\dagger}{(A^\dagger \oplus B^\dagger) \vdash (A \otimes B)^\dagger} \iota L (*) \quad \iota L^{(-1)}}{}$$

Figure 3.3: Derivation of the ⊕-laxor

$$\begin{array}{c}
\frac{\frac{\frac{}{\vdash \top} \text{id}}{\top^\dagger \vdash} \dagger}{\top^\dagger \vdash \perp} \perp\text{R}}{\vdash \top} \\
\frac{\frac{\frac{}{\perp \vdash \perp} \text{id}}{\perp \vdash \perp^\dagger} \iota\text{R}}{\perp \vdash \top^\dagger} \text{Cut}}{\vdash \top} \\
\frac{\frac{\frac{\frac{}{\perp \vdash} \perp\text{L}}{\vdash \perp^\dagger} \dagger}{\top \vdash \perp^\dagger} \top\text{L}}{\perp^\dagger \vdash \top^\dagger} \dagger}{\perp \vdash \top^\dagger}
\end{array}$$

Figure 3.4: Derivation of \perp -laxor

3.1.3 Dagger functor box

Suppose \mathbb{X} is a \dagger -LDC and $f : A \rightarrow B \in \mathbb{X}$. Then, the map $f^\dagger : B^\dagger \rightarrow A^\dagger$ is graphically depicted as follows:

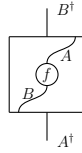

The rectangle is a functor box for the \dagger -functor. Notice how we use vertical mirroring to express the contravariance of the \dagger -functor. By the functoriality of $(-)^{\dagger}$, we have: $\boxplus = \boxdot$.

These contravariant functor boxes compose contravariantly. Given maps $f : A \rightarrow B$ and $g : B \rightarrow C$:

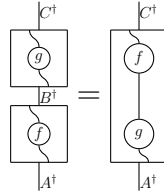

The following are the representations of the basic natural isomorphisms of a \dagger -LDC:

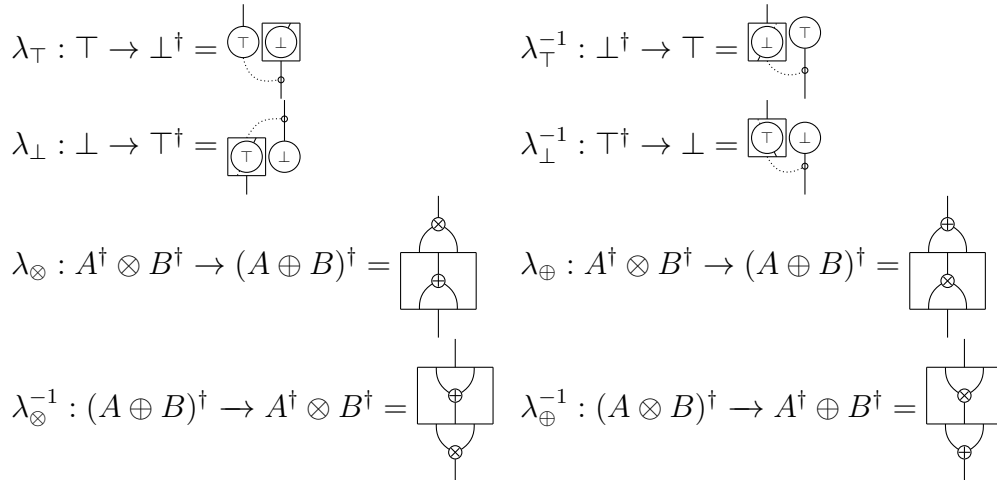

Dagger boxes interact with involutor $A \xrightarrow{\iota} A^\dagger$ as follows:

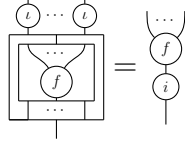

It is worth noting that one need not have a legal proof net inside a \dagger -box. This complicates the correctness criterion. However, the required correctness criterion is discussed in [96].

3.1.4 Functors for \dagger -linearly distributive categories

Clearly the functors and transformations between \dagger -LDCs must “preserve” the dagger in some sense. Precisely we have:

Definition 3.7. $F : \mathbb{X} \rightarrow \mathbb{Y}$ is a \dagger -linear functor between \dagger -LDCs when F is a linear functor equipped with a linear natural isomorphism $\rho^F = (\rho_{\otimes}^F : F_{\otimes}(A^\dagger) \rightarrow F_{\oplus}(A)^\dagger, \rho_{\oplus}^F : F_{\otimes}(A)^\dagger \rightarrow F_{\oplus}(A^\dagger))$ called the **preservator**, such that the following diagrams commute:

$$\begin{array}{ccc}
 F_{\otimes}(X) \xrightarrow{\iota} F_{\otimes}(X)^\dagger & & F_{\oplus}(X) \xrightarrow{\iota} F_{\oplus}(X)^\dagger \\
 F_{\otimes}(\iota) \downarrow & \text{[†-LF.1]} & \uparrow (\rho_{\oplus}^F)^\dagger \\
 F_{\otimes}(X^\dagger) \xrightarrow{\rho_{\otimes}^F} F_{\oplus}(X^\dagger)^\dagger & & F_{\oplus}(X^\dagger) \xleftarrow{\rho_{\oplus}^F} F_{\otimes}(X^\dagger)^\dagger \\
 & & \downarrow (\rho_{\otimes}^F)^\dagger \\
 & & F_{\oplus}(X) \xrightarrow{\iota} F_{\oplus}(X)^\dagger
 \end{array}$$

In case that F is a normal mix functor between \dagger -isomix categories, then by Lemma 2.26, F is an isomix functor and, therefore by Corollary 2.27, the preservators become inverses, $\rho_{\otimes}^F = (\rho_{\oplus}^F)^{-1}$. This means the squares [†-LF.1] and [†-LF.2] coincide to give a single condition for the tensor preservator:

$$\begin{array}{ccc}
 F(X) \xrightarrow{\iota} F(X)^\dagger & & \\
 F(\iota) \downarrow & \text{[†-isomix]} & \downarrow (\rho_{\otimes}^F)^\dagger \\
 F(X^\dagger) \xrightarrow{\rho_{\otimes}^F} F(X^\dagger)^\dagger & &
 \end{array}$$

In case when F is an isomix functor, by Lemma 2.24, $\rho := \rho_{\otimes}$ is monoidal on \otimes and comonoidal on \oplus :

$$\begin{array}{ccc}
\text{[P.1]} & F(A^\dagger) \otimes F(B^\dagger) \xrightarrow{\rho \otimes \rho} F(A)^\dagger \otimes F(B)^\dagger & \begin{array}{c} \top \\ \begin{array}{l} \swarrow \lambda_\top \\ m_\top \downarrow \\ F(\top) \end{array} \\ \begin{array}{l} \searrow \lambda_\top \\ \perp^\dagger \\ \downarrow F(\lambda_\top) \end{array} \\ F(\lambda_\otimes) \downarrow & \downarrow \lambda_\otimes & \downarrow n_\perp^\dagger \\ F(A^\dagger \otimes B^\dagger) & (a) \quad (F(A) \otimes F(B))^\dagger & F(\perp^\dagger) \xrightarrow{\rho} (F(\perp))^\dagger \\ F(\lambda_\otimes) \downarrow & \downarrow n_\oplus^\dagger & \\ F((A \oplus B)^\dagger) & \xrightarrow{\rho} (F(A \oplus B))^\dagger & \end{array}
\end{array}$$

$$\begin{array}{ccc}
\text{[P.2]} & F((A \otimes B)^\dagger) \xrightarrow{\rho} F(A \otimes B)^\dagger & \begin{array}{c} F(\top^\dagger) \\ \downarrow \rho \\ F(\top)^\dagger \end{array} \\ F(\lambda_\oplus^{-1}) \downarrow & \downarrow m_\otimes^\dagger & \begin{array}{c} \searrow F(\lambda_\perp^{-1}) \\ F(\perp) \\ \downarrow n_\perp \end{array} \\ F(A^\dagger \oplus B^\dagger) & (a) \quad (F(A) \otimes F(B))^\dagger & F(\top)^\dagger \xrightarrow{m_\top^\dagger} \top^\dagger \xrightarrow{\lambda_\perp^{-1}} \perp \\ n_\oplus^F \downarrow & \downarrow \lambda_\oplus^{-1} & \\ F(A^\dagger) \oplus F(B^\dagger) & \xrightarrow{\rho \oplus \rho} F(A)^\dagger \oplus F(B)^\dagger & \end{array}$$

Pictorial representation of [P.2]-(a) is as follows:

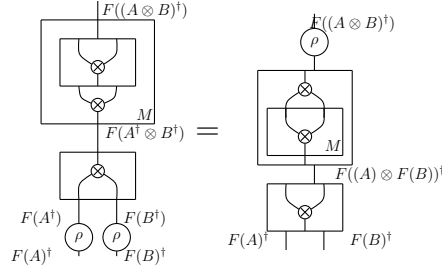

For linear natural transformations $(\beta_\otimes, \beta_\oplus) : F \rightarrow G$ between \dagger -linear functors, we demand that β_\otimes and β_\oplus are related by:

$$\begin{array}{ccc}
F_\otimes(A^\dagger) \xrightarrow{\beta_\otimes} G_\otimes(A^\dagger) & (G_\otimes(X))^\dagger \xrightarrow{\beta_\otimes^\dagger} (F_\otimes(X))^\dagger \\ \rho_\otimes^F \downarrow & \downarrow \rho_\otimes^G & \rho_\oplus^G \downarrow & \downarrow \rho_\oplus^F \\ (F_\oplus(X))^\dagger \xrightarrow{\beta_\oplus^\dagger} (G_\oplus(X))^\dagger & G_\oplus(A^\dagger) \xrightarrow{\beta_\oplus} F_\oplus(A^\dagger)
\end{array}$$

Notice that this means that β_\otimes is completely determined by β_\oplus in the following sense:

$$\begin{array}{ccc}
F_\otimes(A) \xrightarrow{\beta_\otimes} G_\otimes(A) & & \\ F_\otimes(\iota) \downarrow & & \downarrow G_\otimes(\iota) \\ F_\otimes(A^{\dagger\dagger}) \xrightarrow{\beta_\otimes} G_\otimes(A^{\dagger\dagger}) & & \\ \rho_\otimes^F \downarrow & & \downarrow \rho_\otimes^G \\ F_\oplus(A^\dagger)^\dagger \xrightarrow{\beta_\oplus^\dagger} G_\oplus(A^\dagger)^\dagger & & \end{array}$$

Because the vertical maps are isomorphisms, this diagram can be used to express β_{\otimes} in terms of β_{\oplus} . Similarly β_{\oplus} can be expressed in terms of β_{\otimes} . Thus, it is possible to express the coherences in terms of just one of these transformations.

3.2 Examples: †-LDCs

In this section, we discuss a few basic examples of †-isomix categories. The first two are compact LDCs. All these examples have a non-stationary dagger functor. More examples of †-isomix categories can be found in the next chapter when we discuss the dagger and the conjugation functor.

3.2.1 Every †-monoidal category is a †-LDC

A †-monoidal category [110] is defined as a symmetric monoidal category, \mathbb{X} , with a contravariant functor $\dagger : \mathbb{X}^{\text{op}} \rightarrow \mathbb{X}$ which is stationary on objects ($A = A^\dagger$) such that:

- (i) for all f , $f^{\dagger\dagger} = f$
- (ii) for all f and g , $(f \otimes g)^\dagger = f^\dagger \otimes g^\dagger$
- (iii) $a_{\otimes}^\dagger = a_{\otimes}^{-1}$
- (iv) $(u_{\otimes}^l)^\dagger = (u_{\otimes}^l)^{-1}$
- (v) $(u_{\otimes}^r)^\dagger = (u_{\otimes}^r)^{-1}$

Note that every †-monoidal category is a compact †-LDC in which the the laxors and the involutor are identity transformations.

3.2.2 Finite dimensional framed vector spaces

In this section we describe the category of “framed” finite dimensional vector spaces, where a frame in this context is just a choice of basis. Thus, the objects in this category are vector spaces with a chosen basis while the maps, ignoring the basis, are simply homomorphisms of the vector spaces.

The category of finite dimensional framed vectors spaces, FFVec_K , is a monoidal category defined as follows:

Objects: The objects are pairs (V, \mathcal{V}) where V is a finite dimensional K -vector space and $\mathcal{V} = \{v_1, \dots, v_n\}$ is a basis.

Maps: A map $(V, \mathcal{V}) \xrightarrow{f} (W, \mathcal{W})$ is a linear map $V \xrightarrow{f} W$ in FdVec_K .

Tensor: $(V, \mathcal{V}) \otimes (W, \mathcal{W}) = (V \otimes W, \{v \otimes w | v \in \mathcal{V}, w \in \mathcal{W}\})$ where $V \otimes W$ is the usual tensor product. The unit is $(K, \{e\})$ where e is the unit of the field K .

To define the “dagger” we must first choose a conjugation $\overline{(-)} : K \rightarrow K$ (see more details in Section 3.3.2), that is a field homomorphism with $k = \overline{\overline{k}}$. The canonical example of conjugation is conjugation of the complex numbers, however, the conjugation can be arbitrarily chosen – so could also, for example, be the identity. This conjugation then can be extended to a (covariant) functor:

$$\overline{(-)} : \text{FFVec}_K \rightarrow \text{FFVec}_K; \quad \begin{array}{ccc} (V, \mathcal{V}) & & \overline{(V, \mathcal{V})} \\ \downarrow f & \mapsto & \downarrow \overline{f} \\ (W, \mathcal{W}) & & \overline{(W, \mathcal{W})} \end{array}$$

where $\overline{(V, \mathcal{V})}$ is the vector space with the same basis but with the conjugate action $c \cdot v = \overline{c} \cdot v$. The conjugate homomorphism, \overline{f} , is then the same underlying map which is homomorphism between the conjugate spaces.

FFVec_K is also a compact closed category with $(V, \mathcal{B})^* = (V^*, \{\tilde{b}_i | b_i \in \mathcal{B}\})$ where

$$V^* = V \multimap K \quad \text{and} \quad \tilde{b}_i : V \rightarrow K; \left(\sum_j \beta_j \cdot b_j \right) \mapsto \beta_i$$

This makes $(-)^* : \text{FFVec}_K^{\text{op}} \rightarrow \text{FFVec}_K$ a contravariant functor whose action is determined by precomposition. Finally, we define the “dagger” to be the composite $(V, \mathcal{B})^\dagger = \overline{(V, \mathcal{B})^*}$.

This is a monoidal category with tensor and par being identified (so the linear distribution is the associator) and is isomix. We must show that it is a \dagger -LDC. Towards this aim we define the required natural transformations on the basis:

$$\lambda_\otimes = \lambda_\oplus : (V, \mathcal{V})^\dagger \otimes (W, \mathcal{W})^\dagger \rightarrow ((V, \mathcal{V}) \otimes (W, \mathcal{W}))^\dagger; \tilde{v}_i \otimes \tilde{w}_j \mapsto \widetilde{v_i \otimes w_j}$$

$$\lambda_\top = \lambda_\perp : (K, \{e\}) \rightarrow (K, \{e\})^\dagger; k \mapsto \overline{k}$$

$$\iota : (V, \mathcal{V}) \rightarrow ((V, \mathcal{V})^\dagger)^\dagger; v \mapsto \lambda f.f(v)$$

Note that the last transformation is given in a basis independent manner. Importantly, it may also be given in a basis dependent manner as $\iota(v_i) = \tilde{\tilde{v}}_i$ as the behaviour of these two

maps is the same when applied to the basis of $(V, \mathcal{V})^\dagger$ namely the elements \tilde{v}_j :

$$\iota(v_i)(\tilde{v}_j) = (\lambda f.f(v_i))\tilde{v}_j = \tilde{v}_j v_i = \partial_{i,j} = \widetilde{\tilde{v}_i}(\tilde{v}_j)$$

Also note that $\widetilde{v_i \otimes w_j} = (\tilde{v}_i \otimes \tilde{w}_j)u_\otimes$, where $u_\otimes : K \otimes K \rightarrow K$ is the multiplication of the field. With these definitions in hand it is straightforward to check that this gives a \dagger -LDC by checking the required coherences on basis elements. To demonstrate the technique consider the coherence [\dagger -**ldc.4**]:

$$\begin{array}{ccc} A \oplus B & \xrightarrow{\iota} & ((A \oplus B)^\dagger)^\dagger \\ \iota \oplus \iota \downarrow & & \downarrow \lambda_\otimes^\dagger \\ (A^\dagger)^\dagger \oplus (B^\dagger)^\dagger & \xrightarrow{\lambda_\oplus} & (A^\dagger \otimes B^\dagger)^\dagger \end{array}$$

We must show (identifying tensor and par) that $\lambda_\otimes^\dagger(\iota(a_i \otimes b_j)) = \lambda_\otimes(\iota \otimes \iota(a_i \otimes b_j))$. Now the result is a higher-order term so it suffices to show the evaluations on basis elements are the same. This means we need to show: $\lambda_\otimes^\dagger(\iota(a_i \otimes b_j))(\tilde{a}_p \otimes \tilde{b}_q) = \lambda_\otimes(\iota \otimes \iota(a_i \otimes b_j))(\tilde{a}_p \otimes \tilde{b}_q)$

$$\begin{aligned} (\lambda_\otimes(\iota \otimes \iota(a_i \otimes b_j)))(\tilde{a}_p \otimes \tilde{b}_q) &= (\lambda_\otimes(\widetilde{\tilde{a}_i \otimes \tilde{b}_j}))(\tilde{a}_p \otimes \tilde{b}_q) \\ &= (\widetilde{\tilde{a}_i \otimes \tilde{b}_j})(\tilde{a}_p \otimes \tilde{b}_q) \\ &= (\tilde{a}_p \otimes \tilde{b}_q)(\widetilde{\tilde{a}_i \otimes \tilde{b}_j})u_\otimes \quad (\text{diagrammatic order}) \\ &= \partial_{p,i} \partial_{q,j} \\ (\lambda_\otimes^\dagger(\iota(a_i \otimes b_j)))(\tilde{a}_p \otimes \tilde{b}_q) &= (\lambda_\otimes^\dagger(\widetilde{\tilde{a}_i \otimes \tilde{b}_j}))(\tilde{a}_p \otimes \tilde{b}_q) \\ &= (\tilde{a}_p \otimes \tilde{b}_q)\lambda_\otimes^\dagger(\widetilde{\tilde{a}_i \otimes \tilde{b}_j}) \quad (\text{diagrammatic order}) \\ &= \widetilde{\tilde{a}_p \otimes \tilde{b}_q} \widetilde{\tilde{a}_i \otimes \tilde{b}_j} \\ &= \partial_{p,i} \partial_{q,j} \end{aligned}$$

Thus, FFVec_K is a compact \dagger -isomix category where the \dagger functor shifts objects i.e., $A \neq A^\dagger$.

3.2.3 Category of abstract state spaces

This source of examples for \dagger -isomix categories is inspired by the category of convex operational models [13]. The following is a way to construct a new \dagger -isomix category, the category of abstract state spaces, from an existing one.

Definition 3.8. *Let \mathbb{X} be a \dagger -isomix category. Define $\text{Asp}(\mathbb{X})$ as follows:*

Objects: $(A, e_A : A \rightarrow \perp, u_A : \top \rightarrow A)$

Arrows: $f : A \rightarrow B \in \mathbb{X}$ such that the following diagram commutes:

$$\begin{array}{ccc}
 & \top & \\
 u_A \swarrow & & \searrow u_B \\
 A & \xrightarrow{f} & B \\
 e_A \searrow & & \swarrow e_B \\
 & \perp &
 \end{array}$$

Identity arrow and composition are inherited directly from \mathbb{X} . $\mathbf{Asp}(\mathbb{X})$ is a LDC:

\otimes **on objects:** $(A, e_A, u_A) \otimes (B, e_B, u_B) := (A \otimes B, e', u')$ where, $e' := \mathbf{mx}(e_A \oplus e_B)u_{\oplus}$ and $u' := u_{\otimes}^{-1}(u_A \otimes u_B)$. The unit of \otimes is given by $(\top, \mathbf{m}^{-1} : \top \rightarrow \perp, 1_{\top})$.

\oplus **on objects:** $(A, e_A, u_A) \oplus (B, e_B, u_B) := (A \oplus B, e', u')$ where, $e' := (e_A \oplus e_B)u_{\oplus}$ and $u' := u_{\oplus}^{-1}(u_A \otimes u_B)\mathbf{mx}$. The unit of \oplus is $(\perp, 1_{\perp}, \mathbf{m}^{-1} : \top \rightarrow \perp)$

$\mathbf{Asp}(\mathbb{X})$ is also \dagger -isomix category with

$$(A, e, u)^{\dagger} := (A^{\dagger}, u^{\dagger}\lambda_{\perp}^{-1}, \lambda_{\top}e^{\dagger})$$

All the basic natural isomorphisms are inherited from \mathbb{X} . Hence, $\mathbf{Asp}(\mathbb{X})$ is a \dagger -isomix category.

3.3 Dagger, duals, and conjugation

The goal of this section is to review the interaction of the dualizing, conjugation and dagger functors. In dagger compact closed categories, the dagger functor $(-)^{\dagger}$, and the dualizing functor $(-)^*$ commute with each other and their composite gives the conjugate functor $(-)_*$. Similarly, $(-)_*$ and $(-)^*$ when composed gives the dagger functor. Our aim is to generalize these interactions to \dagger -LDCs and to achieve this at a reasonable level of abstraction. To achieve this we shall need the notion which we here refer to as “conjugation” but was investigated by Egger in [61] under the moniker of “involution” (which clashes with our usage).

3.3.1 Duals

The reverse of an LDC, \mathbb{X} , written $\mathbb{X}^{\text{rev}} := (\mathbb{X}, \otimes, \top, \oplus, \perp)^{\text{rev}} = (\mathbb{X}, \otimes^{\text{rev}}, \top, \oplus^{\text{rev}}, \perp)$ where,

$$A \otimes^{\text{rev}} B := B \otimes A \quad A \oplus^{\text{rev}} B := B \oplus A$$

and the associators and distributors are adjusted accordingly. Similar to the opposite of an LDC, we have $(\mathbb{X}^{\text{rev}})^{\text{rev}} = \mathbb{X}$.

In a $*$ -autonomous category, taking the left (or right) linear dual of an object extends to a Frobenius linear functor as follows:

$$(-)^* : (\mathbb{X}^{\text{op}})^{\text{rev}} \rightarrow \mathbb{X}; \quad A \mapsto A^*; \quad \begin{array}{c} |A \\ \boxed{f} \\ |B \end{array} \mapsto \begin{array}{c} |B^* \\ \boxed{f} \\ |A^* \end{array}$$

The $(-)^*$ functor is both contravariant and, op-monoidal and op-comonoidal:

$$\begin{array}{ll} m_{\otimes} : A^* \otimes B^* \rightarrow (B \oplus A)^* := \begin{array}{c} |B^* \otimes A^* \\ \text{---} \oplus \text{---} \\ |B^* \quad |A^* \\ \text{---} \oplus \text{---} \\ |A \oplus B \end{array} & m_{\top} : \top \rightarrow \perp^* := \begin{array}{c} | \top \\ \text{---} \oplus \text{---} \\ | \perp \end{array} \\ n_{\oplus} : (A \otimes B)^* \rightarrow B^* \oplus A^* := \begin{array}{c} |A \otimes B \end{array} & n_{\perp} : \top^* \rightarrow \perp := \begin{array}{c} | \top^* \\ \text{---} \oplus \text{---} \\ | \perp \end{array} \end{array}$$

These maps are op-monoidal and op-comonoidal laxors, hence are isomorphisms, which satisfy the obvious coherences. Thus, $(-)^*$ is a strong Frobenius linear functor.

In the rest of the section, we will write $(\mathbb{X}^{\text{op}})^{\text{rev}}$ as $\mathbb{X}^{\text{oprev}}$.

Lemma 3.9. *If \mathbb{X} is an isomix category, then $(-)^* : \mathbb{X}^{\text{oprev}} \rightarrow \mathbb{X}$ is an isomix functor.*

Proof. Because $(-)^*$ is a strong Frobenius functor, by Lemma 2.26, it suffices to prove that $(-)^*$ preserves mix, i.e., $(-)^*$ is a mix functor i.e., we need to show that $n_{\perp} m m_{\top} : \top^* \rightarrow \perp^* = m^*$. The proof is as follows:

$$n_{\perp} m m_{\top} = \begin{array}{c} \text{Diagram 1: } n_{\perp} m m_{\top} \text{ with } \top \text{ and } \perp \text{ objects} \\ \text{Diagram 2: } \text{Simplified version of Diagram 1} \\ \text{Diagram 3: } \text{Diagram 2 with } \text{mx} \text{ label} \\ \text{Diagram 4: } \text{Diagram 3 with } \text{m}^* \text{ label} \end{array} = m^*$$

□

Lemma 3.10. $(\eta, \epsilon) :: (-)^* \dashv \ast (-)^{\text{oprev}} : \mathbb{X}^{\text{oprev}} \rightarrow \mathbb{X}$

$$\eta_{\otimes} : X \rightarrow \ast(X^*) := \begin{array}{c} X \\ | \\ X^* \\ \text{---} \eta \\ | \\ \ast(X^*) \\ \text{---} \epsilon^* \end{array} \in \mathbb{X} \quad \eta_{\oplus} := \eta_{\otimes}^{-1}$$

$$\epsilon_{\oplus} : X \rightarrow (\ast X)^* := \begin{array}{c} X \\ \text{---} \eta^* \\ | \\ \ast X \\ \text{---} \ast \epsilon \\ | \\ (\ast X)^* \end{array} \in \mathbb{X} \quad \epsilon_{\otimes} := \epsilon_{\oplus}^{-1}$$

is a linear equivalence of Frobenius linear functors.

Proof. The proof is straightforward in the graphical calculus. □

For a cyclic \ast -autonomous category, we can straighten out this equivalence to be a dualizing involutive equivalence (i.e. so that the unit and counit are equal):

Lemma 3.11. $(\eta', \epsilon') :: (-)^* \dashv \ast ((-)^*)^{\text{oprev}} : \mathbb{X}^{\text{oprev}} \rightarrow \mathbb{X}$ where $\eta'_{\otimes} = \eta'_{\oplus}^{-1} := \eta_{\otimes} \psi^{-1}$, $\epsilon'_{\otimes} = \epsilon'_{\oplus} := \epsilon \psi^*$ and $\eta' = \epsilon'$.

Proof. The unit and counit are drawn as follows:

$$\eta'_{\otimes} = \begin{array}{c} X \\ | \\ X^* \\ \text{---} \eta \\ | \\ \ast(X^*) \\ \text{---} \epsilon^* \\ | \\ \psi^{-1} \\ | \\ X^{\ast\ast} \end{array} \in \mathbb{X} \quad \epsilon'_{\otimes} = \begin{array}{c} X^* \\ | \\ \psi \\ | \\ \ast(X^*) \\ \text{---} \ast \epsilon \\ | \\ X^{\ast\ast} \end{array} = \begin{array}{c} X^* \\ | \\ \psi \\ | \\ \ast(X^*) \\ \text{---} \ast \epsilon \\ | \\ X^{\ast\ast} \end{array} \stackrel{[\mathbf{C.2}]}{=} \begin{array}{c} X \\ | \\ X^* \\ \text{---} \eta \\ | \\ \ast(X^*) \\ \text{---} \epsilon^* \\ | \\ \psi^{-1} \\ | \\ X^{\ast\ast} \end{array} \in \mathbb{X}$$

The cyclor is a linear transformation which is an isomorphism as it is monoidal with respect to both tensor and par and adjoints are determined only upto isomorphism. It remains to check that the triangle identities hold:

$$\eta_{\otimes' X^*}(\epsilon'_{\otimes})^* = \begin{array}{c} X^* \\ \downarrow \epsilon^* \\ \text{---} \psi^{-1} \text{---} \\ \downarrow \epsilon^* \\ X^* \end{array} \begin{array}{c} \text{---} \eta^* \text{---} \\ \downarrow \epsilon^* \\ \text{---} \psi^{-1} \text{---} \\ \downarrow \epsilon^* \\ X^* \end{array} = \begin{array}{c} X^* \\ \downarrow \eta^* \\ \text{---} \psi \text{---} \\ \downarrow \epsilon^* \\ X^* \end{array} \begin{array}{c} \text{---} \eta^* \text{---} \\ \downarrow \epsilon^* \\ \text{---} \psi^{-1} \text{---} \\ \downarrow \epsilon^* \\ X^* \end{array} = \begin{array}{c} X^* \\ \downarrow \eta^* \\ \text{---} \psi^{-1} \text{---} \\ \downarrow \epsilon^* \\ X^* \end{array} \begin{array}{c} \text{---} \eta^* \text{---} \\ \downarrow \epsilon^* \\ \text{---} \psi \text{---} \\ \downarrow \epsilon^* \\ X^* \end{array} = 1$$

The other triangle identity holds similarly. \square

The equality of η' and ϵ' is immediate from [C.2] for cyclors with the map $\eta' = \epsilon'$ being the **dualizer**. In the symmetric case, the dualizer of this equivalence may be drawn as:

$$\begin{array}{c} A \\ \downarrow \epsilon^* \\ \text{---} \eta^* \text{---} \\ \downarrow \epsilon^* \\ A^* \end{array} \begin{array}{c} \text{---} \eta^* \text{---} \\ \downarrow \epsilon^* \\ \text{---} \psi^{-1} \text{---} \\ \downarrow \epsilon^* \\ A^* \end{array} = \begin{array}{c} A \\ \downarrow \eta^* \\ \text{---} \epsilon^* \text{---} \\ \downarrow \epsilon^* \\ A^* \end{array} = \begin{array}{c} A \\ \downarrow \eta^* \\ \text{---} \psi \text{---} \\ \downarrow \epsilon^* \\ A^* \end{array}$$

3.3.2 Conjugation

Recall the following structure from Egger [61]:

Definition 3.12. A **conjugation** for a monoidal category (X, \otimes, I) consists of a functor $\overline{(-)} : \mathbb{X}^{\text{rev}} \rightarrow \mathbb{X}$ with natural isomorphisms:

$$\overline{A} \otimes \overline{B} \xrightarrow{\chi} \overline{B \otimes A} \quad \overline{\overline{A}} \xrightarrow{\varepsilon} A$$

called respectively the (tensor reversing) **conjugating laxor** and the **conjugator** such that

$$\overline{\overline{\overline{A}}} \xrightarrow{\overline{\varepsilon_A} = \varepsilon_{\overline{A}}} \overline{A}$$

and

$$\begin{array}{ccc} (\overline{A} \otimes \overline{B}) \otimes \overline{C} & \xrightarrow{a_{\otimes}} & \overline{A} \otimes (\overline{B} \otimes \overline{C}) \\ \chi \otimes 1 \downarrow & & \downarrow 1 \otimes \chi \\ \overline{(B \otimes A)} \otimes \overline{C} & \xrightarrow{[\text{CF.1}]_{\otimes}} & \overline{A} \otimes (\overline{C \otimes B}) \\ \chi \downarrow & & \downarrow \chi \\ \overline{C \otimes (B \otimes A)} & \xrightarrow{\overline{a_{\otimes}^{-1}}} & \overline{(C \otimes B) \otimes A} \end{array} \quad \begin{array}{ccc} \overline{\overline{A}} \otimes \overline{\overline{B}} & \xrightarrow{\chi} & \overline{\overline{B \otimes A}} \\ \varepsilon \otimes \varepsilon \downarrow & & \downarrow \overline{\chi} \\ A \otimes B & \xleftarrow{\varepsilon} & \overline{\overline{A \otimes B}} \end{array}$$

A monoidal category is **conjugative** when it has a conjugation functor.

A symmetric monoidal category, which is conjugative, is **symmetric conjugative** in case it satisfies the additional coherence:

$$\begin{array}{ccc} \overline{A} \otimes \overline{B} & \xrightarrow{\chi} & \overline{B} \otimes \overline{A} \\ c_{\otimes} \downarrow & [\mathbf{CF.3}]_{\otimes} & \downarrow c_{\otimes} \\ \overline{B} \otimes \overline{A} & \xrightarrow{\chi} & \overline{A} \otimes \overline{B} \end{array}$$

No coherences have been specified for the unit I because the expected coherences are automatic:

Lemma 3.13. [61, Lemma 2.3] *For every conjugative monoidal category, there exists a unique isomorphism $I \xrightarrow{\chi} \overline{I}$ such that*

$$\begin{array}{ccc} I \otimes \overline{A} & \xrightarrow{\chi \otimes 1} & \overline{I} \otimes \overline{A} & \quad & \overline{A} \otimes I & \xrightarrow{1 \otimes \chi} & \overline{A} \otimes \overline{I} & \quad & I & \xrightarrow{\chi} & \overline{I} \\ u_{\otimes} \downarrow & [\mathbf{CF.4}]_{\top} & \downarrow \chi & & u_{\otimes} \downarrow & [\mathbf{CF.5}]_{\top} & \downarrow \chi & & \parallel & [\mathbf{CF.6}]_{\top} & \downarrow \overline{\chi} \\ \overline{A} & \xrightarrow{u_{\otimes}^{-1}} & \overline{A} \otimes \overline{I} & & \overline{A} & \xrightarrow{u_{\otimes}^{-1}} & \overline{I} \otimes \overline{A} & & I & \xrightarrow{\varepsilon^{-1}} & \overline{I} \end{array}$$

Definition 3.14. [61] *A conjugative LDC is a linearly distributive category $(\mathbb{X}, \otimes, \top, \oplus, \perp)$ together with a conjugating functor $\overline{(-)} : \mathbb{X} \rightarrow \mathbb{X}$ and natural isomorphisms:*

$$\overline{A} \otimes \overline{B} \xrightarrow{\chi_{\otimes}} \overline{B \otimes A} \quad \overline{A \oplus B} \xrightarrow{\chi_{\oplus}} \overline{B \oplus A} \quad \overline{\overline{A}} \xrightarrow{\varepsilon} A$$

such that $(\mathbb{X}, \otimes, \top, \chi_{\otimes}, \varepsilon)$ and $(\mathbb{X}, \oplus, \perp, \chi_{\oplus}^{-1}, \varepsilon)$ are conjugative (symmetric) monoidal categories with respect to the conjugating functor and the following diagrams commute:

$$\begin{array}{ccc} \overline{B \oplus C} \otimes \overline{A} & \xrightarrow{\chi_{\oplus} \otimes 1} & \overline{(C \oplus B) \otimes A} & \quad & \overline{A} \otimes \overline{C \oplus B} & \xrightarrow{\chi_{\otimes}} & \overline{(C \oplus B) \otimes A} \\ \chi_{\otimes} \downarrow & & \downarrow \partial & & 1 \otimes \chi_{\oplus} \downarrow & & \downarrow \overline{\partial} \\ \overline{(A \otimes (B \oplus C))} & [\mathbf{CF.7}] & \overline{C \oplus (B \otimes A)} & & \overline{A} \otimes \overline{(B \oplus C)} & [\mathbf{CF.8}] & \overline{C \oplus (B \otimes A)} \\ \overline{\partial} \downarrow & & \downarrow 1 \oplus \chi_{\otimes} & & \partial \downarrow & & \downarrow \chi_{\oplus} \\ \overline{((A \otimes B) \oplus C)} & \xrightarrow{\chi_{\oplus}} & \overline{C \oplus A \otimes B} & & \overline{(A \otimes B) \oplus C} & \xrightarrow{\chi_{\oplus \oplus 1}} & \overline{(B \otimes A) \oplus C} \end{array}$$

Note, by Lemma 3.13, there exists canonical isomorphisms $\top \xrightarrow{\chi_{\top}} \overline{\top}$ and $\perp \xrightarrow{\chi_{\perp}} \overline{\perp}$, hence conjugation is a normal functor. However, the conjugation is not necessarily a mix functor when \mathbb{X} is a mix category. For conjugation to be a mix functor, the following extra condition

must be satisfied:

$$[\mathbf{CF.9}] \quad \begin{array}{ccc} \overline{\perp} & \xrightarrow{\quad \overline{m} \quad} & \overline{\top} \\ & \searrow^{(\chi_{\perp})^{-1}} & \nearrow^{\chi_{\top}} \\ & \perp \xrightarrow{m} \top & \end{array}$$

Proposition 3.15. *A conjugative LDC is precisely a LDC, \mathbb{X} , with a Frobenius adjoint $(\epsilon^{-1}, \epsilon) : \overline{(-)} \dashv \overline{(-)}^{\text{rev}} : \mathbb{X}^{\text{rev}} \rightarrow \mathbb{X}$ where $\epsilon := (\epsilon, \epsilon^{-1})$. Furthermore, if \mathbb{X} is an isomix category and conjugation is a mix functor then conjugation is an isomix equivalence.*

Proof. It is clear that $\overline{(-)}$ is a strong Frobenius functor so being mix implies isomix. Also, ϵ is clearly monoidal for tensor and par. The triangle equalities give $\overline{\epsilon^{-1}}\epsilon = 1 : \overline{A} \rightarrow \overline{A}$ thus $\epsilon = \overline{\epsilon}$. \square

Clearly conjugation should flip left duals into right duals:

Lemma 3.16. *If $B \dashv A$ is a linear dual then $\overline{A} \dashv \overline{B}$ is a linear dual.*

Proof. Suppose $(\eta, \epsilon) : B \dashv A$. Then, $(\chi_{\top}^{\circ} \overline{\eta} \chi_{\oplus}, \chi_{\otimes} \overline{\epsilon} \chi_{\perp}^{\circ}) : \overline{A} \dashv \overline{B}$. \square

When a $*$ -autonomous category is cyclic one expects that conjugation should interact with the cyclor in a coherent fashion:

Definition 3.17. [63] *A conjugative cyclic $*$ -autonomous category is a conjugative $*$ -autonomous category together with a cyclor $A^* \xrightarrow{\psi} {}^*A$ such that*

$$\begin{array}{ccc} (\overline{A})^* & \xrightarrow{\psi} & {}^*(\overline{A}) \\ \simeq \downarrow & & \downarrow \simeq \\ \overline{{}^*A} & \xrightarrow{\overline{\psi^{-1}}} & \overline{A^*} \end{array}$$

which gives a map $\sigma : (\overline{A})^* \rightarrow \overline{A^*}$.

The above condition is drawn as follows:

$$\sigma = \begin{array}{c} \overline{\eta} \\ \uparrow \\ \overline{A} \\ \downarrow \\ \psi^{-1} \\ \downarrow \\ \overline{A^*} \end{array} \begin{array}{c} \overline{A} \\ \downarrow \\ \epsilon^* \\ \downarrow \\ \overline{A^*} \end{array} \begin{array}{c} (\overline{A})^* \end{array} = \begin{array}{c} (\overline{A})^* \\ \downarrow \\ \psi \\ \downarrow \\ \overline{A} \\ \downarrow \\ \eta^* \\ \downarrow \\ \overline{A^*} \end{array}$$

When the $*$ -autonomous category is symmetric, conjugation automatically preserves the canonical cyclor.

equivalence, in addition, requires that the unit and counit of the equivalence be inverses of each of other. The unit and counit of the equivalence are given by (a) and (b) respectively;

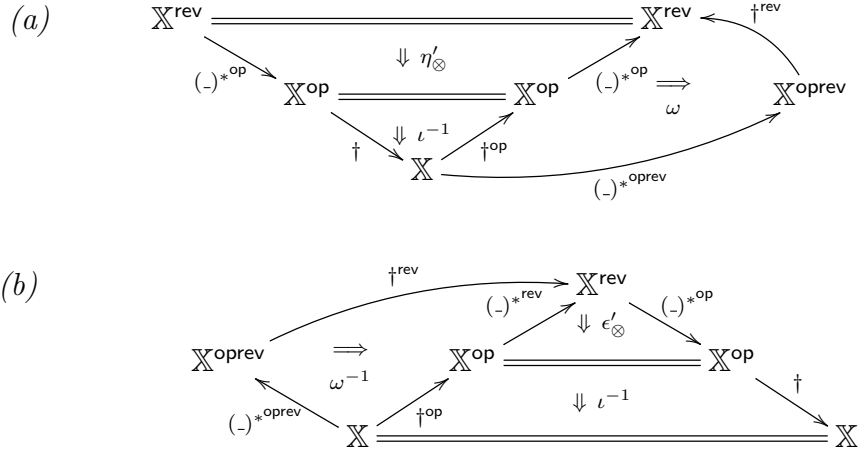

where the isomorphism $\omega : (_)^\dagger * \rightarrow (_)^{*\dagger}$ is from the cyclor preserving condition, **[CFF]**, for Frobenius linear functors:

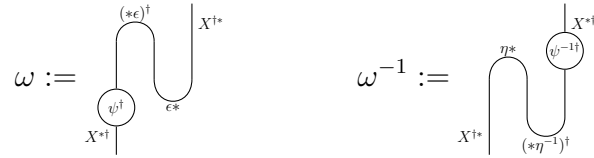

It remains to show that the unit and the counit maps are inverses of each other in \mathbb{X} :

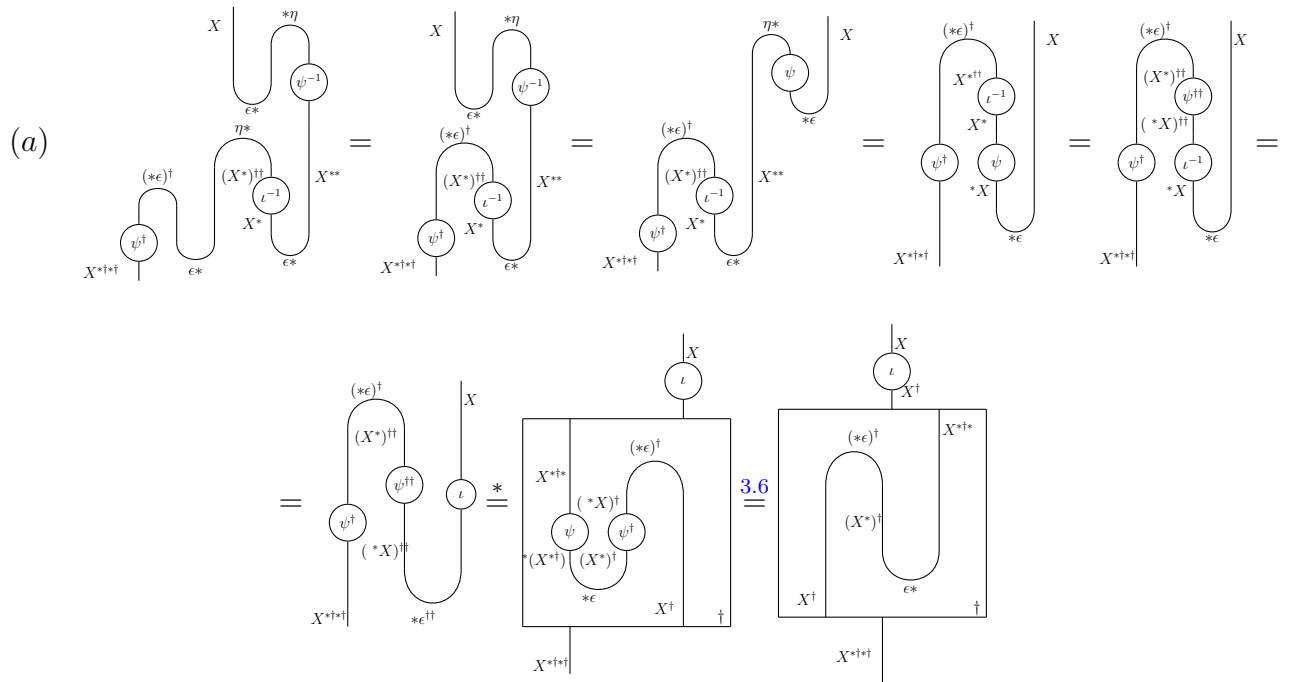

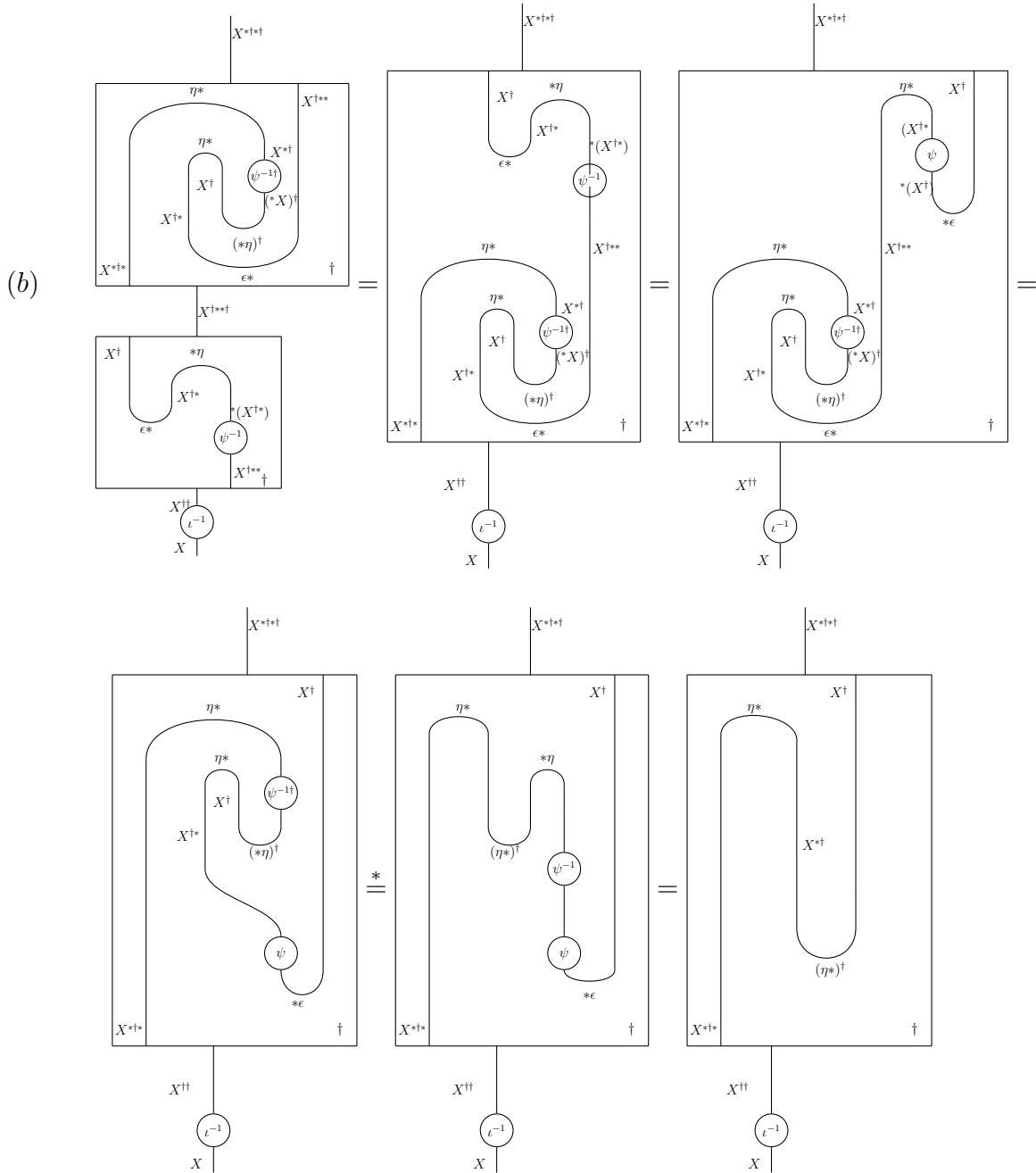

(*) holds because \dagger preserves the cyclor. Thus, (a) and (b) are inverses of each other. \square

Next, we show that a conjugation functor together with a dualizing functors gives a \dagger :

Proposition 3.20. *Every cyclic, conjugative $*$ -autonomous category is also a \dagger - $*$ -autonomous category.*

Proof. Let \mathbb{X} be a cyclic, conjugative $*$ -autonomous category then $\overline{(-)}^* \dashv \overline{(-)}^*$ is an equivalence. To build a dagger we need an equivalence on the same functor: we obtain this by using

the natural equivalence $\sigma : \overline{(-)}^* \rightarrow \overline{(-)}^*$ from Definition 3.17. An involutive equivalence, in addition, requires the unit and counit of the (contravariant) equivalence to be the same map (which we called the involutor, ι). We show that this is the case:

The unit and counit of the equivalence is given by (a) and (b) respectively;

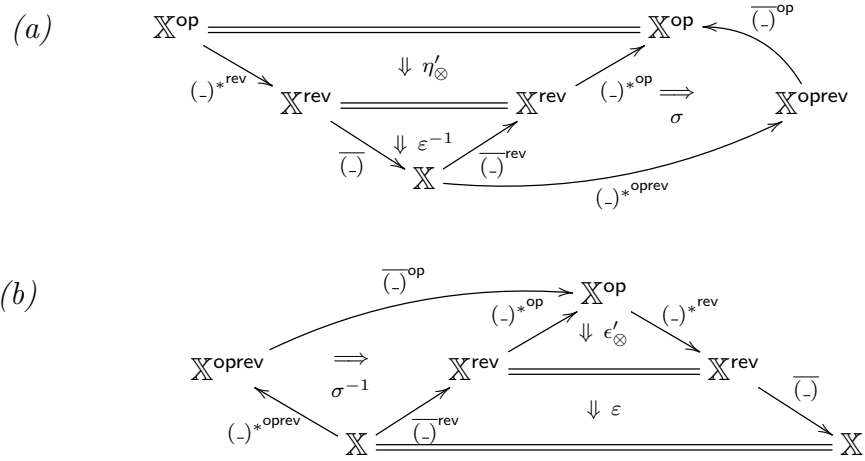

where $\sigma : \overline{A}^* \rightarrow \overline{A}^*$ is given in Definition 3.17. Below we show that the unit and counit coincide in \mathbb{X} .

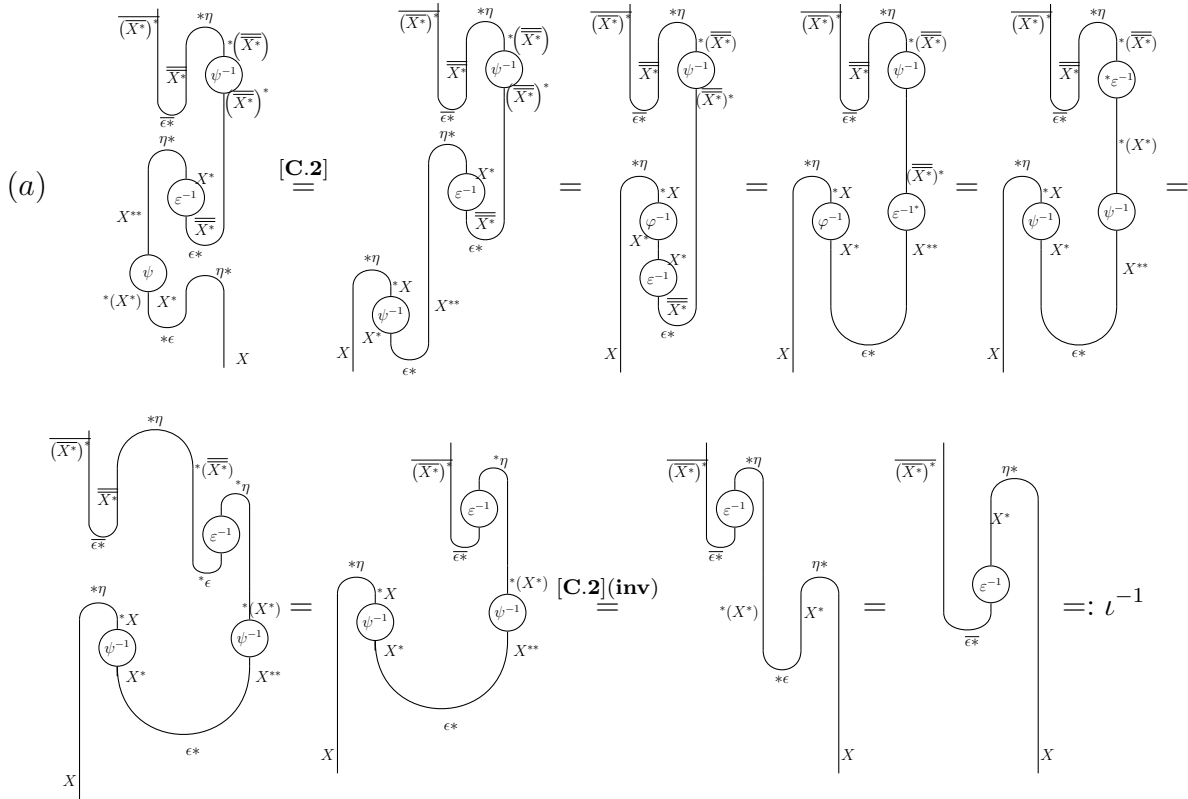

(b)

□

Observe that for composition of the dualizing functor and the conjugation functor to yield a dagger, and vice versa, a $*$ -autonomous category is required to be cyclic with the cyclor being preserved by the conjugation (see Definition 3.17) and the dagger (see just before Lemma 3.6).

Combining Propositions 3.19 and 3.20, we get:

Theorem 3.21. *Every cyclic $*$ -autonomous category is conjugative $*$ -autonomous if and only if it is \dagger - $*$ -autonomous.*

3.4 Examples: Dagger and conjugation

Let us now look at some examples of \dagger -isomix categories in which the dagger is given by dualizing and conjugation functors.

3.4.1 A group with conjugation considered as a category

Definition 3.22. *A group with conjugation is a group (G, \cdot, e) together with a function $\overline{(\cdot)} : G \rightarrow G$ such that, for all $g \in G$, $\overline{\overline{g}} = g$, and for all $g, h \in G$, $\overline{g \cdot h} = \overline{h} \overline{g}$, and $\overline{e} = e$.*

Let (G, \cdot, e) be a group with conjugation. The discrete category $\mathbb{D}(G, \cdot, e)$ whose objects are the elements of the group is a monoidal category with the tensor product given by $g \otimes h := g.h$, and the monoidal unit e . Moreover, $\mathbb{D}(G, \cdot, e)$ is a compact closed category where $g^* := g^{-1}$, and it has a trivial conjugative cyclor (see Definition 3.17). Thus, $\mathbb{D}(G, \cdot, e)$ which is a compact \dagger -isomix- $*$ -autonomous category with $g^\dagger := \overline{g^*}$ is an example of how the conjugation gives rise to a dagger.

Here are some examples of groups with conjugation and the discrete categories given by them:

- Suppose we fix the group to be $(\mathbb{C}, +, 0)$ where the objects are complex numbers and the tensor product is addition. The dual and conjugation of complex numbers are given as follows: $(a + ib)^* = -a - ib$ and $\overline{a + ib} := a - ib$. Hence,

$$(a + ib)^\dagger := \overline{(a + ib)^*} = \overline{-a - ib} = -a + ib$$

- Consider the multiplicative group $(\mathbb{C}^*, \cdot, 1)$ where the objects are non-zero complex numbers and the tensor product is given by multiplication. The dualizing and the conjugation functors are given as follows:

$$(a + ib)^* = c + id, \text{ where } ac - bd = 1 \text{ and } ad + bc = 0$$

$$\overline{a + ib} := a - ib$$

$(a + ib)^\dagger$ is given by $\overline{(a + ib)^*}$.

- Suppose the group is fixed to be $\mathbb{D}(P(x), +, 0)$ where $P(x)$ is a polynomial ring. $\mathbb{D}(P(x), +, 0)$ is a conjugative compact closed category: $P(x)^* = -P(x)$ and $\overline{P(x)} = P(-x)$. Then, $P(x)^\dagger = -P(-x)$.

- Consider the general linear group of degree 2, $(\mathbb{M}_2, \cdot, I_2)$ over complex numbers. Then, the discrete category $\mathbb{D}(\mathbb{M}_2, \cdot, I_2)$ has a dualizing functor given by matrix inverse and

conjugation is given by conjugate transpose: $\overline{\begin{pmatrix} a + ib & m + in \\ c + id & p + iq \end{pmatrix}} := \begin{pmatrix} a - ib & c - id \\ m - in & p - iq \end{pmatrix}$.

Then, $\mathbb{D}(\mathbb{M}_2, \cdot, I_2)$ is a \dagger -isomix $*$ -autonomous category with:

$$\begin{pmatrix} a + ib & m + in \\ c + id & p + iq \end{pmatrix}^\dagger := \overline{\begin{pmatrix} a + ib & m + in \\ c + id & p + iq \end{pmatrix}^*} = \begin{pmatrix} a - ib & c - id \\ m - in & p - iq \end{pmatrix}^{-1}$$

3.4.2 Finiteness matrices and finiteness relations

We now describe the conjugation, $\overline{(-)}$ and, thus, the dagger functor, $(-)^{\dagger}$, for \mathbf{FRel} , and $\mathbf{FMat}(R)$. Recall that the dagger functor is obtained by composing the conjugacy dualizing functors: $X^{\dagger} = \overline{X^*}$.

Lemma 3.23. \mathbf{FRel} , $\mathbf{FMat}(R)$, where R is a conjugative rig, are conjugative isomix $*$ -autonomous categories.

A conjugative rig is a rig with a conjugation $\overline{(-)} : R \rightarrow R$ such that $r = \overline{\bar{r}}$ and the conjugation preserves addition, $\overline{0} = 0$ and $\overline{r + s} = \overline{r} + \overline{s}$, and preserves the multiplication $\overline{1} = 1$ and $\overline{r_1 \cdot r_2} = \overline{r_1} \cdot \overline{r_2}$.

Proof. For \mathbf{FRel} the conjugation functor is identity on objects and arrows and thus the dagger is the duality, $X^{\dagger} = X^*$. \mathbf{FRel} is a conjugative $*$ -autonomous category with the required natural isomorphisms defined as follows:

- $\overline{X} \otimes \overline{Y} \xrightarrow{\chi_{\otimes}} \overline{Y \otimes X}$ and χ_{\oplus} are the symmetry maps.
- $\overline{A} \xrightarrow{\varepsilon} A$ is the identity map.

For $\mathbf{FMat}(R)$ the conjugation functor for is determined by the conjugation on the rig. The functor is still identity on the objects and the symmetry map is used to provide χ_{\otimes} and χ_{\oplus} . For a finiteness matrix, M , \overline{M} is given by conjugating all the elements of M . χ_{\otimes} , χ_{\oplus} , ε are the characteristic function of their corresponding finiteness relations.

Both are a conjugative isomix category because $\top = \perp$. □

3.4.3 Chu spaces

Applications of Chu Spaces to represent quantum systems have been studied in [2], [3]. In this section we show that the Chu construction over a closed conjugative monoidal category, which has pullbacks, produces a \dagger -isomix LDC, $\mathbf{Chu}_{\mathbb{X}}(I)$. To get the $*$ -autonomous category and \dagger -structure on $\mathbf{Chu}_{\mathbb{X}}(I)$ we shall start by explaining how one can produce conjugative structure on the \mathbf{Chu} category. To achieve this we develop the structure of this category, starting with a conjugative closed monoidal category, \mathbb{X} , which is not necessarily symmetric. Note that the fact that it is conjugative means that it is both left and right closed which allows us to consider the non-commutative Chu construction: in this regard we shall follow Jürgen Koslowski's construction [88] using simplified “Chu-cells” on the same dualizing object to obtain not a $*$ -linear bicategory but a cyclic $*$ -autonomous category. Furthermore, we shall choose a dualizing object which is conjugative in order to obtain a conjugative cyclic $*$ -autonomous category.

A conjugative object is an object D of \mathbb{X} with an isomorphism $d : \overline{D} \rightarrow D$ such that $\overline{d}d = \varepsilon : D \rightarrow \overline{D}$. We can then define $\text{Chu}_{\mathbb{X}}(D)$ as follows:

Objects: (A, B, ψ_0, ψ_1) where $\psi_0 : A \otimes B \rightarrow D$ and $\psi_1 : B \otimes A \rightarrow D$ in \mathbb{X} (these are the simplified Chu cells).

Arrows: $(f, g) : (A, B, \psi_0, \psi_1) \rightarrow (A', B', \psi'_0, \psi'_1)$ where $f : A \rightarrow A'$ and $g : B' \rightarrow B$ and the following diagrams commutes:

$$\begin{array}{ccc}
 & A \otimes B' & \\
 1 \otimes g \swarrow & & \searrow f \otimes 1 \\
 A \otimes B & & A' \otimes B' \\
 \psi_0 \searrow & & \swarrow \psi'_0 \\
 & D &
 \end{array}
 \qquad
 \begin{array}{ccc}
 & B' \otimes A & \\
 g \otimes 1 \swarrow & & \searrow 1 \otimes f \\
 B \otimes A & & B' \otimes A' \\
 \psi_1 \searrow & & \swarrow \psi'_1 \\
 & D &
 \end{array}$$

Compositon: $(f, g)(f', g') := (ff', g'g)$. Composition is well-defined as:

$$\begin{array}{ccccc}
 & & A \otimes B'' & & \\
 & & \swarrow 1 \otimes g' & & \searrow f \otimes 1 \\
 & A \otimes B' & & & A' \otimes B'' \\
 1 \otimes g \swarrow & & & & \searrow f' \otimes 1 \\
 A \otimes B & & A' \otimes B' & & A'' \otimes B'' \\
 \psi_0 \searrow & & \downarrow \psi'_0 & & \swarrow \psi''_0 \\
 & & D & &
 \end{array}$$

and similarly for the reverse Chu-maps: ψ_1, ψ'_1 and ψ''_1 . The **identity maps** are $(1_A, 1_B) : (A, B, \psi_0, \psi_1) \rightarrow (A, B, \psi_0, \psi_1)$ as expected.

Tensor product \otimes : $(A, B, \psi_0, \psi_1) \otimes (A', B', \psi'_0, \psi'_1) := (A \otimes A', E, \gamma_0, \gamma_1)$, where E is the pullback in the following diagram:

$$\begin{array}{ccc}
 & E & \\
 \pi_0 \swarrow & & \searrow \pi_1 \\
 A' \circ B & & B' \circ A \\
 1 \circ \tilde{\psi}_1 \searrow & & \swarrow \tilde{\psi}'_1 \circ A \\
 A' \circ (D \circ A) & \xrightarrow{\cong} & (A' \circ D) \circ A
 \end{array}$$

with

$$\begin{array}{ccc}
 B \xrightarrow{\tilde{\psi}_1} D \circ A & & B' \xrightarrow{\tilde{\psi}'_1} A' \circ D \\
 B \otimes A \xrightarrow{\psi_1} B & & A' \otimes B' \rightarrow D
 \end{array}$$

and,

$$\gamma_0 := (A \otimes A') \otimes E \xrightarrow{1 \otimes \pi_0} (A \otimes A') \otimes (A' \multimap B) \xrightarrow{a_\otimes} A \otimes (A' \otimes A' \multimap B) \xrightarrow{1 \otimes \text{eval}_\multimap} A \otimes B \xrightarrow{\psi'_0} D$$

$$\gamma_1 := E \otimes (A \otimes A') \xrightarrow{\pi_1 \otimes 1} (B' \multimap A) \otimes (A \otimes A') \xrightarrow{a_\otimes^{-1}} (B' \multimap A \otimes A) \otimes A' \xrightarrow{\text{eval}_\multimap \otimes 1} B' \otimes A' \xrightarrow{\psi'_1} D$$

The tensor unit is $(I, D, u_\otimes^l, u_\otimes^r)$.

It is standard that $\mathbf{Chu}_\mathbb{X}(D)$ is a (non-commutative) $*$ -autonomous category. Furthermore, it is cyclic because

$$*(A, B, \psi_0, \psi_1) = (A, B, \psi_0, \psi_1)^* = (B, A, \psi_1, \psi_0).$$

In addition, $\mathbf{Chu}_\mathbb{X}(D)$ is conjugative with

$$\overline{(A, B, \psi_0, \psi_1)} := (\overline{A}, \overline{B}, \chi \overline{\psi_1} d, \chi \overline{\psi_0} d)$$

and $\overline{(f, g)} = (\overline{f}, \overline{g})$. Finally being conjugative cyclic $*$ -autonomous implies that one has a dagger!

In the case that \mathbb{X} is a symmetric monoidal closed category we may recapture the usual Chu construction [18], which we denote $\mathbf{Chus}_\mathbb{X}(D)$. Consider the full subcategory of Chu-objects with special Chu-cells of the form $(A, B, \psi, c_\otimes \psi)$ in which the symmetry map is used to obtain the second cell, this gives an inclusion $\mathbf{Chus}_\mathbb{X}(D) \rightarrow \mathbf{Chu}_\mathbb{X}(D)$.

We observe that \mathbb{X} is symmetric conjugative when this subcategory is closed under the conjugation:

Lemma 3.24. *If \mathbb{X} is an conjugative symmetric monoidal closed category and $d : \overline{D} \rightarrow D$ is an involutive object, then $\mathbf{Chus}_\mathbb{X}(D)$ is a conjugative symmetric $*$ -autonomous category.*

Proof. It suffices to observe that the Chu-cells of $\overline{(A, B, \psi, c_\otimes \psi)}$ have the right form. Using the coherence of the involution with symmetry, the first Chu-cell of this object has $\chi \overline{c_\otimes \psi} d = c_\otimes \chi \overline{\psi} d$ which is exactly the symmetry map applied to the second Chu-cell of the object as desired. \square

To obtain an isomix category one can choose $D = I$. $\mathbf{Chus}_\mathbb{X}(I)$ is an isomix category because the unit for tensor and par are the same (namely $\top = \perp = (I, I, u_\otimes^l = u_\otimes^r)$). The tensor unit is always a conjugative object since $(\chi)^{-1} : \overline{I} \rightarrow I$; therefore, this is immediately a conjugative symmetric $*$ -autonomous category. Composing the conjugation with the dualizing functor gives us a dagger.

3.4.4 Category of Hopf modules in a $*$ -autonomous category

In this example¹, we start with any symmetric $*$ -autonomous category, \mathbb{X} , and build the category of modules over a Hopf Algebra which is in turn a \dagger - $*$ -autonomous category.

First of all, it has been already proven in [103], that the category of Hopf modules over a \otimes -Hopf algebra in any symmetric $*$ -autonomous category is also a $*$ -autonomous category. Then we note that, whenever the Hopf Algebra is cocommutative, the resulting $*$ -autonomous category has a conjugation functor. One can construct the dagger functor by composing the conjugation functor and dualizing functor as in Theorem 3.20. We establish some basic definitions before describing the category of modules over a Hopf Algebra, $\mathbf{H}\text{-Mod}_{\mathbb{X}}$.

Definition 3.25. A **bialgebra** in a symmetric monoidal category is a 4-tuple

$$(\nabla : B \otimes B \rightarrow B, e : I \rightarrow B, \Delta : B \rightarrow B \otimes B, u : B \rightarrow I)$$

such that (A, ∇, e) is a monoid and (A, Δ, u) is a comonoid and ∇ and e are coalgebra homomorphisms with respect to the comultiplication and the counit.

Note that instead of requiring that ∇ and e are coalgebra homomorphisms, one could equivalently require Δ and u are algebra homomorphisms with respect to the multiplication and the unit.

The components of a bialgebra are graphically depicted as follows:

$$\begin{array}{cccc} \begin{array}{c} \diagup \\ \diagdown \end{array} : A \otimes A \rightarrow A & \begin{array}{c} \diagdown \\ \diagup \end{array} : A \rightarrow A \otimes A & \begin{array}{c} | \\ \triangle \end{array} : A \rightarrow I & \begin{array}{c} \nabla \\ | \end{array} : I \rightarrow A \end{array}$$

This gives a succinct graphical depiction of the coalgebra homomorphism laws; namely:

$$\begin{array}{cccc} \begin{array}{c} \diagup \quad \diagup \\ \diagdown \quad \diagdown \end{array} = \begin{array}{c} \diagup \\ \diagdown \end{array} & \begin{array}{c} \diagdown \\ \diagup \end{array} = \begin{array}{c} \nabla \\ \nabla \end{array} & \begin{array}{c} \diagup \\ \diagdown \end{array} = \begin{array}{c} | \\ \triangle \end{array} \begin{array}{c} | \\ \triangle \end{array} & \begin{array}{c} \nabla \\ | \end{array} = I \end{array}$$

Definition 3.26. An **antipode** for a bialgebra $(B, \nabla, \nabla, \Delta, \triangle)$ is an endomorphism $s : B \rightarrow B$ such that

$$\begin{array}{c} \begin{array}{c} \diagup \\ \diagdown \end{array} \circ \begin{array}{c} \diagdown \\ \diagup \end{array} \circ s = \begin{array}{c} \diagdown \\ \diagup \end{array} \circ \begin{array}{c} \diagup \\ \diagdown \end{array} \circ s = \begin{array}{c} | \\ \triangle \end{array} \begin{array}{c} | \\ \triangle \end{array} \end{array}$$

A **Hopf algebra** is a bialgebra with an antipode. An **involutive Hopf algebra** is a hopf algebra where the antipode is self-inverse.

¹We thank J-S. P. Lemay for bringing our attention to this example.

A standard example of a Hopf algebra is a group algebra over a field: for all group elements g , $\nabla : g \mapsto g \otimes g$, $\triangleleft : g \mapsto 1$, $\Delta : g \otimes h \mapsto gh$ and $s : g \mapsto g^{-1}$.

Lemma 3.27. *Suppose \mathbb{X} is a symmetric monoidal category, then:*

- (i) [21, Theroem 3.5] *If H is a commutative or a cocommutative Hopf Algebra in \mathbb{X} , then $s^2 = 1$ where s is the antipode: so it is an involutive Hopf algebra.*
- (ii) [90, Lemma 2.11] *If H is a commutative Hopf Algebra, then s is a monoid homomorphism. If H is a cocommutative Hopf Algebra, then s is a comonoid homomorphism.*

Definition 3.28. *A left module for a bialgebra $(B, \nabla, u, \Delta, e)$ is a tuple $(M, a_M^l : B \otimes M \rightarrow M)$ such that a_M^l is a B -action i.e., the following diagram commutes:*

$$\begin{array}{ccc} M & \xrightarrow{u_\otimes^l} & \top \otimes M \\ & \searrow & \downarrow \nabla \\ & & M \end{array}$$

We graphically depict a_m^l as follows:

$$\begin{array}{c} \cup \\ | \\ \cup \end{array} : B \otimes M \rightarrow M$$

giving the graphical presentation of the module laws:

$$\begin{array}{c} \cup \\ | \\ \cup \end{array} = \begin{array}{c} \cup \\ | \\ \cup \end{array} \quad \text{and} \quad \begin{array}{c} \nabla \\ | \\ \cup \end{array} = \begin{array}{c} | \\ | \\ | \end{array}$$

Definition 3.29. *Let \mathbb{X} be a $*$ -autonomous category and H be a Hopf \otimes -algebra in \mathbb{X} . The category of left H -modules in \mathbb{X} , $\mathbf{H}\text{-Mod}_{\mathbb{X}}$ has:*

Objects: *Left H -modules $(A, a_A^l : H \otimes A \rightarrow A)$:*

Arrows: *A module homomorphism $(A, a_A^l : H \otimes A \rightarrow A) \xrightarrow{f} (B, a_B^l : H \otimes B \rightarrow B)$ is a map $A \xrightarrow{f} B$ such that the following diagram commutes:*

$$\begin{array}{ccc} H \otimes A & \xrightarrow{a_A^l} & A \\ 1 \otimes f \downarrow & & \downarrow f \\ H \otimes B & \xrightarrow{a_B^l} & B \end{array}$$

This is graphically depicted as follows:

$$\begin{array}{c} \cup \\ | \\ \cup \end{array} = \begin{array}{c} \cup \\ | \\ \cup \end{array} \circ f$$

Observe that any left action is indeed a module homomorphism.

Theorem 3.30. [103] *Let \mathbb{X} be symmetric $*$ -autonomous category and H be a \otimes -Hopf Algebra in \mathbb{X} with bijective antipode ($s^2 = 1$). Then, $\mathbf{H}\text{-Mod}_{\mathbb{X}}$ is a $*$ -autonomous category. If the Hopf Algebra, H , is cocommutative, then $\mathbf{H}\text{-Mod}_{\mathbb{X}}$ is a symmetric $*$ -autonomous category.*

Proof. (Sketch) The monoidal product \otimes for $\mathbf{H}\text{-Mod}_{\mathbb{X}}$ is defined as follows:

$$(A, \curvearrowright) \otimes (B, \curvearrowright) := (A \otimes B, \curvearrowright) \text{ where, } \curvearrowright := \begin{array}{c} | \\ \diagup \quad \diagdown \\ | \end{array}$$

The unit of \otimes is given by $(\top, H \otimes \top \xrightarrow{u_{\otimes}^R} H \xrightarrow{e} \top)$, the left action is drawn as

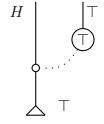

The par product is defined as: $(A, \curvearrowright) \oplus (B, \curvearrowright) := (A \oplus B, \curvearrowright)$ where,

$$\begin{aligned} \curvearrowright &:= H \otimes (A \oplus B) \xrightarrow{\Delta \otimes 1} (H \otimes H) \otimes (A \oplus B) \xrightarrow{a_{\otimes}} H \otimes (H \otimes (A \oplus B)) \\ &\xrightarrow{c_{\otimes}} (H \otimes (A \oplus B)) \otimes H \xrightarrow{\partial^L \otimes 1} ((H \otimes A) \oplus B) \otimes H \xrightarrow{\partial^R} (H \otimes A) \oplus (B \otimes H) \\ &\xrightarrow{1 \oplus c_{\otimes}} (H \otimes A) \oplus (H \otimes B) \xrightarrow{\curvearrowright \oplus \curvearrowright} A \oplus B \end{aligned}$$

and the unit of \oplus is

$$\perp := (\perp, H \otimes \perp \xrightarrow{u_{\otimes} \perp} \top \otimes \perp \xrightarrow{u_{\otimes}} \perp)$$

All the basic natural isomorphisms are inherited directly from \mathbb{X} , and they are module homomorphisms. Thus, $\mathbf{HMod}_{\mathbb{X}}$ is a LDC.

The dualizing functor $(-)^*$ is given as follows: $(A, \curvearrowright : H \otimes A \rightarrow A)^* := (A^*, \curvearrowright^* : H \otimes A^* \rightarrow A^*)$ where,

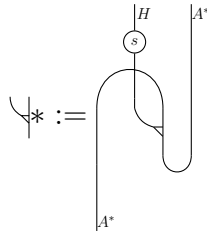

Equationally,

$$\begin{aligned}
\lrcorner_* &:= H \otimes A^* \xrightarrow{s \otimes 1} H \otimes A^* \xrightarrow{u_{\otimes}^{-1} \otimes 1} (H \otimes \top) \otimes A^* \xrightarrow{1 \otimes \eta \otimes 1} (H \otimes (A^* \oplus A)) \otimes A^* \\
&\xrightarrow{c_{\otimes} \otimes 1} ((A^* \oplus A) \otimes H) \otimes A^* \xrightarrow{\partial \otimes 1} (A^* \oplus (A \otimes H)) \otimes A^* \xrightarrow{1 \otimes c_{\otimes} \otimes 1} (A^* \oplus (H \otimes A)) \otimes A^* \\
&\xrightarrow{(1 \oplus \lrcorner) \otimes 1} (A^* \oplus A) \otimes A^* \xrightarrow{\partial} A^* \oplus (A \otimes A^*) \xrightarrow{1 \oplus \epsilon} A \oplus \perp \xrightarrow{u_{\oplus}^R} A^*
\end{aligned}$$

The cups and caps are inherited directly from \mathbb{X} , hence the snake diagrams hold. The antipode in the definition of $\lrcorner_* : H \otimes A^* \rightarrow A^*$ makes the cup and cap module morphisms.

Suppose $(A, \lrcorner) \xrightarrow{f} (B, \lrcorner)$ is as a module morphism, then $f^* := B^* \xrightarrow{f^*} A^* \in \mathbb{X}$ which is also a module morphism. Thus, $\mathbf{H}\text{-Mod}_{\mathbb{X}}$ is a monoidal category with a dualizing functor, hence a $*$ -autonomous category.

If H is cocommutative, then $(A, \lrcorner) \otimes (B, \lrcorner) \xrightarrow{c_{\otimes}} (B, \lrcorner) \otimes (A, \lrcorner)$ is a module homomorphism.

In that case, $\mathbf{H}\text{-Mod}_{\mathbb{X}}$ is a symmetric $*$ -autonomous category. \square

Futhermore, we can show that the category of Hopf modules is conjugative.

Lemma 3.31. *Let \mathbb{X} be a symmetric $*$ -autonomous category. $\mathbf{H}\text{-Mod}_{\mathbb{X}}$, the category of modules over a cocommutative Hopf Algebra H is a conjugative symmetric $*$ -autonomous category .*

Proof. We already know that $\mathbf{H}\text{-Mod}_{\mathbb{X}}$ is a symmetric $*$ -autonomous category. We define the conjugation functor $\overline{(_)} : \mathbf{H}\text{-Mod}_{\mathbb{X}} \rightarrow \mathbf{H}\text{-Mod}_{\mathbb{X}}$ as follows:

- $\overline{(A, \lrcorner)} := (A, \overline{\lrcorner})$ where, $\overline{\lrcorner} := \begin{array}{c} \circlearrowleft \\ \lrcorner \end{array}$
- Suppose $f : (A, \lrcorner) \rightarrow (B, \lrcorner)$, then $\overline{f} := f$

The basic natural isomorphisms are given by:

$$\overline{(B, \lrcorner)} \otimes \overline{(A, \lrcorner)} \xrightarrow{x} \overline{(A, \lrcorner) \otimes (B, \lrcorner)} := B \otimes A \xrightarrow{(c_{\otimes})_{B,A}} A \otimes B$$

$$(A, \overline{\overline{\lrcorner}}) \xrightarrow{\epsilon} (A, \lrcorner) := 1$$

The natural isomorphisms satisfy all the coherences of conjugative symmetric $*$ -autonomous category. \square

Lemma 3.32. *Suppose \mathbb{X} is a symmetric (iso)mix $*$ -autonomous category, then $\mathbf{H}\text{-Mod}_{\mathbb{X}}$, the category of Hopf modules over a cocommutative Hopf Algebra H is a (iso)mix conjugative symmetric $*$ -autonomous category.*

Proof. The mix map $\mathfrak{m} : \perp \rightarrow \top$ is inherited directly from \mathbb{X} . □

Corollary 3.33. *Suppose \mathbb{X} is a symmetric (iso)mix $*$ -autonomous, then $\mathbf{H}\text{-Mod}_{\mathbb{X}}$, the category of modules over a cocommutative Hopf Algebra H is a symmetric \dagger (iso)mix $*$ -autonomous category.*

Proof. From Lemma 3.32, $\mathbf{H}\text{-Mod}_{\mathbb{X}}$ is an (iso)mix conjugative symmetric $*$ -autonomous category. Then, by Theorem 3.20 one can construct a dagger functor by composing the conjugation and the dualizing functor as follows: $(-)^{\dagger} := \overline{(-)^*} : \mathbf{H}\text{-Mod}_{\mathbb{X}}^{\text{op}} \rightarrow \mathbf{H}\text{-Mod}_{\mathbb{X}}$. Therefore,

$$(A, \Psi)^{\dagger} := (A^*, \overline{\Psi}^*) \text{ where,}$$

$$(A, \overline{\Psi}^*) := \begin{array}{c} \begin{array}{c} |H \\ \circ \\ \circ \\ | \\ \text{---} \\ | \\ A^* \end{array} \quad \begin{array}{c} |A^* \\ | \\ \text{---} \\ | \\ A^* \end{array} \\ \text{---} \\ | \\ A^* \end{array} = \begin{array}{c} \begin{array}{c} |H \\ | \\ \text{---} \\ | \\ A^* \end{array} \quad \begin{array}{c} |A^* \\ | \\ \text{---} \\ | \\ A^* \end{array} \\ \text{---} \\ | \\ A^* \end{array}$$

□

Thus, one can generate a \dagger -isomix category from a symmetric isomix $*$ -autonomous category by choosing the Hopf modules over any cocommutative \otimes - Hopf Algebra.

Chapter 4

Mixed unitary categories (MUCs)

The notion of unitary isomorphism is important in categorical quantum mechanics since these isomorphisms model the unitary evolution of a quantum system. An isomorphism in a \dagger -monoidal category is said to be unitary when the inverse of the map coincides with its dagger. This idea cannot be directly applied to define unitary isomorphisms in \dagger -LDCs due to the non-stationary dagger functor ($A \neq A^\dagger$). This arises the following question: *what are unitary isomorphisms in \dagger -LDCs?* The objective of this chapter is resolve this question and to introduce mixed unitary categories (MUCs).

4.1 Unitary categories

4.1.1 Unitary structure

Categorically, within a \dagger -monoidal category, a unitary map is an isomorphism $f : A \rightarrow B$ such that $f^{-1} = f^\dagger$. This definition of unitary isomorphism cannot be used directly within the framework of \dagger -LDCs since the types of $f^{-1} : B \rightarrow A$ and $f^\dagger : B^\dagger \rightarrow A^\dagger$ are different. However, one can define such a unitary isomorphism if, minimally, $A \simeq A^\dagger$ and $B \simeq B^\dagger$, and the isomorphisms behave coherently with the \dagger -linear structure. We call such isomorphisms *unitary structure maps* and the objects equipped with such isomorphisms as *unitary objects*:

Definition 4.1. A \dagger -isomix category, \mathbb{X} has **unitary structure** in case there is an essentially small class of objects \mathcal{U} , called the **unitary objects** of \mathbb{X} such that

[U.1] for all $A \in \mathcal{U}$, $A \in \text{Core}(\mathbb{X})$, and A is equipped with an isomorphism, $\varphi_A : A \rightarrow A^\dagger$, called the **unitary structure map** of A

[U.2] \mathcal{U} is closed under $(-)^\dagger$ so that for all $A \in \mathcal{U}$, $\varphi_{A^\dagger} = ((\varphi_A)^{-1})^\dagger$

Observe that $[\mathbf{Udual.}](a) \Leftrightarrow (b)$. In a compact \dagger -LDC, $\top \dashv_u \perp$. $[\mathbf{Udual}]$ (a) is shown diagrammatically as follows:

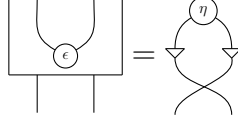

Lemma 4.4. *Suppose $(\eta_1, \epsilon_1) : V_1 \dashv_u U_1$ and $(\eta_2, \epsilon_2) : V_2 \dashv_u U_2$. Then, $(V_1 \otimes V_2) \dashv_u (U_1 \oplus U_2)$.*

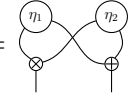
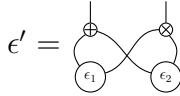
Proof. Define $(\eta', \epsilon') : (V_1 \otimes V_2) \dashv_u (U_1 \oplus U_2)$ so that $\eta' =$

 $\epsilon' =$

. This is easily checked to be a unitary linear adjoint. \square

We can now define what it means for an isomorphism to be unitary:

Definition 4.5. *Suppose A and B are unitary objects. An isomorphism $A \xrightarrow{f} B$ is said to be a **unitary isomorphism** if the following diagram commutes:*

$$\begin{array}{ccc} A & \xrightarrow{\varphi_A} & A^\dagger \\ f \downarrow & & \uparrow f^\dagger \\ B & \xrightarrow{\varphi_B} & B^\dagger \end{array}$$

Observe that φ is “twisted” natural for all unitary isomorphisms, thus, unitary isomorphisms compose and contain the identity maps. In a category in which the unitary structure maps are identity morphisms, one recovers the usual notion of unitary isomorphisms.

Our next objective is to show that all the coherence isomorphisms between unitary objects are unitary maps. First a warmup:

Lemma 4.6. *In a \dagger -isomix category with unitary structure:*

- (i) *If f is a unitary isomorphism, then so is f^\dagger ;*
- (ii) *If f and g are unitary, then so are $f \otimes g$ and $f \oplus g$;*
- (iii) *Unitary isomorphisms are closed under composition.*

Proof.

- (i) Recall that $\varphi_{A^\dagger} = (\varphi_A^{-1})^\dagger$, then f^\dagger is unitary because

$$\begin{array}{ccc} B^\dagger & \xrightarrow{f^\dagger} & A^\dagger \\ (\varphi_B^{-1})^\dagger = \varphi_{B^\dagger} \downarrow & & \downarrow (\varphi_A^{-1})^\dagger = \varphi_{A^\dagger} \\ B^{\dagger\dagger} & \xleftarrow{f^{\dagger\dagger}} & A^{\dagger\dagger} \end{array}$$

is just the dagger functor applied to the unitary diagram of f .

(ii) Suppose f and g are unitary morphisms, then:

$$\begin{array}{ccccc}
A \otimes B & \xrightarrow{\varphi_{A \otimes B}} & & & (A \otimes B)^\dagger \\
\downarrow f \otimes g & \searrow \text{mx} & A \oplus B & \xrightarrow{\varphi_{A \oplus B}} & A^\dagger \oplus B^\dagger & \nearrow \lambda_\oplus \\
& & \downarrow f \oplus g & & \uparrow f^\dagger \oplus g^\dagger & \text{(nat. } \lambda_\oplus) \\
& & A' \oplus B' & \xrightarrow{\varphi_{A' \oplus B'}} & A'^\dagger \oplus B'^\dagger & \searrow \lambda_\oplus \\
& \nearrow \text{mx} & & & & \\
A' \otimes B' & \xrightarrow{\varphi_{A' \otimes B'}} & & & (A' \otimes B')^\dagger \\
& & & & \uparrow (f \otimes g)^\dagger
\end{array}$$

[U.5(b)]
[U.5(b)]

The inner square commutes because f and g are unitary maps. Similarly, using [U.5(b)], one can show that if f and g are unitary, then $f \oplus g$ is unitary.

(iii) The proof is trivial. □

The following lemma will be used to prove that the natural isomorphisms in a \dagger -isomix category are unitary for unitary objects.

Lemma 4.7. *The following diagram commutes:*

$$\begin{array}{ccccc}
(A \otimes B) \otimes C & \xrightarrow{\text{mx}} & (A \otimes B) \oplus C & \xrightarrow{\text{mx} \oplus 1} & (A \oplus B) \oplus C \\
a_\otimes \downarrow & & & & \downarrow a_\oplus \\
A \otimes (B \otimes C) & \xrightarrow{\text{mx}} & A \oplus (B \otimes C) & \xrightarrow{1 \oplus \text{mx}} & A \oplus (B \oplus C)
\end{array}$$

Proof. The given diagram commutes due to the naturality of the mixor, and due to the rules governing the interaction of mixor, associator and distributor, see Section 2.1.3.

$$\begin{array}{ccccc}
(A \otimes B) \otimes C & \xrightarrow{\text{mx}} & (A \otimes B) \oplus C & \xrightarrow{\text{mx} \oplus 1} & (A \oplus B) \oplus C \\
a_\otimes \downarrow & \text{mix } (b) & \uparrow \partial^L & \text{mix } (a) & \downarrow a_\oplus \\
A \otimes (B \otimes C) & \xrightarrow{1 \otimes \text{mx}} & A \otimes (B \oplus C) & \xrightarrow{\text{mx}} & A \oplus (B \oplus C) \\
& \searrow \text{mx} & \text{nat. mx} & \nearrow 1 \oplus \text{mx} & \\
& & A \oplus (B \otimes C) & &
\end{array}$$

□

Lemma 4.8. *Suppose \mathbb{X} is a \dagger -isomix category with unitary structure and A , B , and C are unitary objects. Then the following are unitary isomorphisms:*

- (i) $\lambda_{\otimes} : A^{\dagger} \otimes B^{\dagger} \rightarrow (A \oplus B)^{\dagger}$ (viii) $\iota : A \rightarrow (A^{\dagger})^{\dagger}$
- (ii) $\lambda_{\oplus} : A^{\dagger} \oplus B^{\dagger} \rightarrow (A \otimes B)^{\dagger}$ (ix) $a_{\otimes} : (A \otimes B) \otimes C \rightarrow A \otimes (B \otimes C)$
- (iii) $\lambda_{\top} : \top \rightarrow \perp^{\dagger}$ (x) $a_{\oplus} : (A \oplus B) \oplus C \rightarrow A \oplus (B \oplus C)$
- (iv) $\lambda_{\perp} : \perp \rightarrow \top^{\dagger}$ (xi) $c_{\otimes} : A \otimes B \rightarrow B \otimes A$
- (v) $\varphi_A : A \rightarrow A^{\dagger}$ (xii) $c_{\oplus} : A \oplus B \rightarrow B \oplus A$
- (vi) $m : \top \rightarrow \perp$ (xiii) $\partial_L : A \otimes (B \oplus C) \rightarrow (A \otimes B) \oplus C$
- (vii) $\mathbf{mx}_{A,B} : A \otimes B \rightarrow A \oplus B$ (xiv) $\partial_R : (A \oplus B) \otimes C \rightarrow A \oplus (B \otimes C)$

Proof.

(i) $\lambda_{\otimes} : A^{\dagger} \otimes B^{\dagger} \rightarrow (A \oplus B)^{\dagger}$ is a unitary map because:

$$\begin{array}{ccccccc}
A^{\dagger} \otimes B^{\dagger} & \xrightarrow{\phi_{A^{\dagger} \otimes B^{\dagger}}^{-1} \phi_B^{-1}} & A \otimes B & \xrightarrow{\phi_A \otimes \phi_B} & A^{\dagger} \otimes B^{\dagger} & \xrightarrow{\phi_{A^{\dagger} \otimes B^{\dagger}}} & (A^{\dagger} \otimes B^{\dagger})^{\dagger} \\
\downarrow \lambda_{\otimes} & \text{[U.5(a)]} & \downarrow \mathbf{mx} & \text{nat.} & \downarrow \mathbf{mx} & \text{[U.5(a)]} & \downarrow \lambda_{\oplus}^{-1} \\
(A \oplus B)^{\dagger} & \xrightarrow{\phi_{A \oplus B}^{-1}} & A \oplus B & \xrightarrow{\phi_A \oplus \phi_B} & A^{\dagger} \oplus B^{\dagger} & \xrightarrow{\phi_{A^{\dagger} \oplus B^{\dagger}}} & (A^{\dagger})^{\dagger} \oplus (B^{\dagger})^{\dagger} \\
& \text{[U.3]} & \parallel & & \text{[U.3] } \oplus \text{ [U.3]} & & \parallel \\
& & A \oplus B & \xrightarrow{\iota \oplus \iota} & (A^{\dagger})^{\dagger} \oplus (B^{\dagger})^{\dagger} & & \downarrow \lambda_{\oplus} \\
& \searrow \phi_{(A \oplus B)^{\dagger}} & \downarrow \iota & & & & \downarrow \lambda_{\oplus} \\
& & ((A \oplus B)^{\dagger})^{\dagger} & \xrightarrow{[\dagger\text{-Idc.5(a)]}} & (A^{\dagger} \otimes B^{\dagger})^{\dagger} & & \\
& & & & \downarrow \lambda_{\otimes}^{\dagger} & & \\
& & & & (A^{\dagger} \otimes B^{\dagger})^{\dagger} & &
\end{array}$$

(ii) λ_{\oplus} is unitary because:

$$\begin{array}{ccc}
A^{\dagger} \oplus B^{\dagger} & \xrightarrow{\phi_{A^{\dagger} \oplus B^{\dagger}}} & (A^{\dagger} \oplus B^{\dagger})^{\dagger} \\
\downarrow \mathbf{mx}^{-1} & \text{Lem. 4.8 (vi)} & \downarrow (\mathbf{mx}^{-1})^{\dagger} \\
A^{\dagger} \otimes B^{\dagger} & \xrightarrow{\phi_{A^{\dagger} \otimes B^{\dagger}}} & (A^{\dagger} \otimes B^{\dagger})^{\dagger} \\
\downarrow \lambda_{\oplus} & \text{Lem. 3.3 } \lambda_{\otimes} \downarrow & \uparrow \lambda_{\otimes}^{\dagger} \text{ (Lem. 3.3)}^{\dagger} \\
(A \oplus B)^{\dagger} & \xrightarrow{\phi_{(A \oplus B)^{\dagger}}} & ((A \oplus B)^{\dagger})^{\dagger} \\
\downarrow (\mathbf{mx}^{-1})^{\dagger} & \text{Lems. 4.8 (vi), 4.6 (i)} & \downarrow ((\mathbf{mx}^{-1})^{\dagger})^{\dagger} \\
(A \otimes B)^{\dagger} & \xrightarrow{\phi_{(A \otimes B)^{\dagger}}} & ((A \otimes B)^{\dagger})^{\dagger} \\
& & \uparrow \lambda_{\oplus}^{\dagger}
\end{array}$$

(iii) $\lambda_{\perp} : \perp \rightarrow \top^{\dagger}$ is unitary because:

$$\begin{array}{ccc}
 \perp & \xrightarrow{\varphi_{\perp}} & \perp^{\dagger} \\
 \lambda_{\perp} \downarrow & \nearrow m^{\dagger} & \downarrow (\lambda_{\perp}^{-1})^{\dagger} \\
 \top^{\dagger} & \xrightarrow{\varphi_{\top^{\dagger}} = (\varphi_{\top}^{-1})^{\dagger}} & \top^{\dagger\dagger}
 \end{array}$$

The left triangle commutes by [U.4] and [†-mix]. The right triangle commutes by [U.4] and the functoriality of †.

(iv) $\lambda_{\top} : \top \rightarrow \perp^{\dagger}$ is unitary because:

$$\begin{array}{ccc}
 \top & \xrightarrow{\varphi_{\top}} & \top^{\dagger} \\
 \lambda_{\top} \downarrow & \nearrow (m^{-1})^{\dagger} & \downarrow (\lambda_{\top}^{-1})^{\dagger} \\
 \perp^{\dagger} & \xrightarrow{\varphi_{\perp^{\dagger}} = (\varphi_{\perp}^{-1})^{\dagger}} & \perp^{\dagger\dagger}
 \end{array}$$

The left triangle commutes by [U.4] and [†-mix]. The right triangle commutes by [U.4] and the functoriality of †.

(v) φ_A is unitary because the following square commutes by [U.3] and [U.4].

$$\begin{array}{ccc}
 A & \xrightarrow{\varphi_A} & A^{\dagger} \\
 \varphi_A \downarrow & & \downarrow (\varphi^{-1})^{\dagger} \\
 A^{\dagger} & \xrightarrow{\varphi_{A^{\dagger}}} & A^{\dagger\dagger}
 \end{array}$$

(vi) $m : \perp \rightarrow \top$ is unitary because:

$$\begin{array}{ccc}
 \perp & \xrightarrow{\varphi_{\perp}} & \perp^{\dagger} \\
 m \downarrow & \nearrow \lambda_{\top} & \downarrow (m^{-1})^{\dagger} \\
 \top & \xrightarrow{\varphi_{\top}} & \top^{\dagger}
 \end{array}$$

The left and right triangles commute by [U.4] and [†-mix] respectively. Hence, the outer squares commutes.

(vii) $\text{mx}_{A,B} : A \otimes B \rightarrow A \oplus B$ is unitary as:

$$\begin{array}{ccccc}
 & & \varphi_{A \otimes B} & & \\
 & & \curvearrowright & & \\
 A \otimes B & \xrightarrow{\text{mx}} & A \oplus B & \xrightarrow{\varphi_{A \oplus B}} & A^\dagger \oplus B^\dagger & \xrightarrow{\lambda_\oplus} & (A \otimes B)^\dagger \\
 & \searrow^{\varphi_{A \otimes B}} & \text{nat.} & \text{mx} \uparrow & \text{Lem. 3.3} & & \\
 & & & & A^\dagger \otimes B^\dagger & \xrightarrow{\lambda_\otimes} & (A \otimes B)^\dagger \\
 & & \varphi_{A \otimes B} & \text{[U.3]} & & & \\
 A \oplus B & \xrightarrow{\varphi_{A \oplus B}} & & & & & (A \oplus B)^\dagger \\
 & & \text{[U.3]} & & & & \\
 & & \text{mx} \downarrow & & & & \text{mx}^\dagger \uparrow
 \end{array}$$

(viii) $\iota : A \rightarrow A^{\dagger\dagger}$ is unitary as in

$$\begin{array}{ccc}
 A & \xrightarrow{\varphi_A} & A^\dagger \\
 \iota \downarrow & \swarrow \varphi_{A^\dagger} & \downarrow (\iota^{-1})^\dagger \\
 A^{\dagger\dagger} & \xrightarrow{\varphi_{A^{\dagger\dagger}}} & A^{\dagger\dagger\dagger}
 \end{array}$$

the left triangle commutes by [U.3] and the right triangle commutes by:

$$\begin{aligned}
 (\iota^{-1})^\dagger &= ((\varphi_{A^\dagger})^{-1} \varphi_A^{-1})^\dagger = (((\varphi_A^{-1})^\dagger)^{-1} \varphi_A^{-1})^\dagger \\
 &= ((\varphi_A^\dagger)(\varphi_A^{-1}))^\dagger = (\varphi_A^{-1})^\dagger (\varphi_A)^{\dagger\dagger} \\
 &= \varphi_{A^\dagger}(\varphi_A)^{\dagger\dagger} = \varphi_{A^\dagger}(\varphi_{A^{\dagger\dagger}})
 \end{aligned}$$

(ix) a_\otimes is unitary as:

$$\begin{array}{ccc}
 (A \otimes B) \otimes C & \xrightarrow{\varphi_{(A \otimes B) \otimes C}} & ((A \otimes B) \otimes C)^\dagger \\
 \text{mx} \searrow & \text{[U.5(b)]} & \swarrow \lambda_\oplus \\
 (A \otimes B) \oplus C & \xrightarrow{\varphi_{A \otimes B} \oplus \varphi_C} & (A \otimes B)^\dagger \oplus C^\dagger \\
 \text{mx} \oplus 1 \downarrow & \text{[U.5(b)]} \oplus (\text{id}) & \downarrow \lambda_\oplus^{-1} \oplus 1 \\
 (A \oplus B) \oplus C & \xrightarrow{(\varphi_{A \oplus B}) \oplus \varphi_C} & (A^\dagger \oplus B^\dagger) \oplus C^\dagger \\
 \text{Lem. 4.7} \quad a_\oplus \downarrow & \text{nat.} & \downarrow a_\oplus \quad [\dagger\text{-Idc.1}] \\
 A \oplus (B \oplus C) & \xrightarrow{\phi_{A \oplus (\phi_B \oplus \phi_C)}} & A^\dagger \oplus (B^\dagger \oplus C^\dagger) \\
 1 \oplus \text{mx} \uparrow & (\text{id}) \oplus \text{[U.5(b)]} & \downarrow 1 \oplus \lambda_\oplus \\
 A \oplus (B \otimes C) & \xrightarrow{\varphi_{A \oplus \varphi_{B \otimes C}}} & A^\dagger \oplus (B \otimes C)^\dagger \\
 \text{mx} \searrow & \text{[U.5(b)]} & \swarrow \lambda_\oplus \\
 A \otimes (B \otimes C) & \xrightarrow{\varphi_{A \otimes (B \otimes C)}} & (A \otimes (B \otimes C))^\dagger \\
 a_\otimes \downarrow & & \uparrow a_\otimes^\dagger
 \end{array}$$

(x) a_\oplus is unitary because:

where the left square commutes for the same reason and the right square is the dagger of the left square.

(xiii) ∂_L is unitary see Figure 4.1.

(xiv) ∂_R is unitary because:

$$\begin{array}{ccccccccccc}
& & & & \phi_{(A \oplus B) \otimes C} & & & & & & \\
& & & & \text{Lem. 4.8 (vii), 4.6} & & & & & & \\
(A \oplus B) \otimes C & \xrightarrow{\text{mx}} & (A \oplus B) \oplus C & \xrightarrow{\text{mx}^{-1} \oplus 1} & (A \otimes B) \oplus C & \xrightarrow{\phi_{(A \otimes B) \oplus C}} & ((A \otimes B) \oplus C)^\dagger & \xrightarrow{(\text{mx}^{-1} \oplus 1)^\dagger} & ((A \oplus B) \oplus C)^\dagger & \xrightarrow{\text{mx}^\dagger} & ((A \oplus B) \otimes C)^\dagger \\
\downarrow \partial_R & & & & \uparrow \partial_L & \text{Lem. 4.8 (xiii)} & \downarrow \partial_L^\dagger & & & & \uparrow \partial_R^\dagger \\
A \oplus (B \otimes C) & \xrightarrow{\text{mx}^{-1}} & A \oplus (B \oplus C) & \xrightarrow{1 \oplus \text{mx}} & A \otimes (B \oplus C) & \xrightarrow{\phi_{A \otimes (B \oplus C)}} & (A \otimes (B \oplus C))^\dagger & \xrightarrow{(\text{mx} \oplus 1)^\dagger} & (A \oplus (B \oplus C))^\dagger & \xrightarrow{(\text{mx}^{-1})^\dagger} & (A \oplus (B \otimes C))^\dagger \\
& & & & \text{Lem. 4.8 (vii), 4.6} & & & & & & \\
& & & & \phi_{A \oplus (B \otimes C)} & & & & & &
\end{array}$$

□

4.1.2 Unitary categories

With the notion of unitary objects in place, one can consider \dagger -isomix categories in which all the objects are unitary: these are called *unitary categories*. This section develops the theory of unitary categories.

Definition 4.9. A (symmetric) unitary category is a (symmetric) \dagger -isomix category with a unitary structure for which every object is unitary.

Clearly, a unitary category must be a compact \dagger -LDC, since the mixer is a unitary isomorphism, see Lemma 4.8-(iii).

A \dagger -monoidal category is a strict unitary category in which the unitary structure map and the mix map are identity morphisms. Similarly, a \dagger -compact closed category is a strict unitary category in which all objects have unitary duals.

In the rest of this subsection, we show that any unitary category is \dagger -linearly equivalent to a conventional dagger monoidal category. A unitary category being a compact LDC is linearly equivalent, using $\text{Mx}_\dagger^* : (\mathbb{X}, \otimes, \oplus) \rightarrow (\mathbb{X}, \oplus, \otimes)$ (see Corollary 2.18) to the underlying

monoidal category based on the par (and the tensor). We now show that for a unitary category one can induce a stationary on objects dagger on $(\mathbb{X}, \oplus, \oplus)$. We denote this dagger by $(-)^{\ddagger}$ and define it by $f^{\ddagger} := \varphi_B f^{\dagger} \varphi_A^{-1}$ as illustrated by the left diagram below:

$$\begin{array}{ccc} B & \xrightarrow{f^{\dagger}} & A \\ \varphi_B \downarrow & := & \downarrow \varphi_A \\ B^{\dagger} & \xrightarrow{f^{\dagger}} & A^{\dagger} \end{array} \quad \begin{array}{ccc} A & \xrightarrow{f^{\ddagger}} & B \\ \downarrow \varphi_A & & \varphi_B \downarrow \\ A^{\dagger} & \xrightarrow{(f^{\dagger})^{\dagger}} & B^{\dagger} \\ \downarrow (\varphi_A^{-1})^{\dagger} & & (\varphi_B^{-1})^{\dagger} \downarrow \\ A^{\ddagger} & \xrightarrow{f^{\ddagger}} & B^{\ddagger} \end{array} \iota$$

This new dagger clearly preserves composition and is also a stationary on objects involution as proven by the second diagram: the lower square of this diagram is the dagger of the inverted definition and the resulting outer square is the naturality of ι forcing $f^{\ddagger\ddagger} = f$.

Next, we observe that $u : X \rightarrow Y$ is a unitary isomorphism in \mathbb{X} if and only if $u^{-1} = u^{\ddagger}$. This makes unitary isomorphisms in the traditional sense of categorical quantum mechanics coincide with the notion introduced here. Thus, u is unitary in the sense here if and only if the diagram below commutes

$$\begin{array}{ccc} B & \xrightarrow{u^{-1}} & A \\ \varphi_B \downarrow & & \downarrow \varphi_A \\ B^{\dagger} & \xrightarrow{u^{\ddagger}} & A \end{array}$$

but this diagram commutes if and only if $u^{-1} = u^{\ddagger}$.

Definition 4.10. A \dagger -Frobenius mix functor, $F : \mathbb{X} \rightarrow \mathbb{Y}$, between compact \dagger -isomix categories with unitary structure **preserves unitary structure** if

- (i) for all unitary objects $A \in \mathbb{X}$, $F(A)$ is a unitary object such that $\varphi_{F(A)} = F(\varphi_A) \rho^F$
- (ii) Either n_{\perp}^F or m_{\top}^F are unitary isomorphisms i.e.,

$$\begin{array}{ccc} F(\perp) \xrightarrow{F(\varphi_{\perp})} F(\perp^{\dagger}) \xrightarrow{\rho} F(\perp)^{\dagger} \text{ (or)} & \top & \xrightarrow{\varphi_{\top}} \top^{\dagger} \\ n_{\perp} \downarrow & \uparrow n_{\perp}^{\dagger} & m_{\top} \downarrow \\ \perp & \xrightarrow{\varphi_{\perp}} \perp^{\dagger} & F(\top) \xrightarrow{F(\varphi_{\top})} F(\top^{\dagger}) \xrightarrow{\rho} F(\top)^{\dagger} \\ & & \uparrow m_{\top}^{\dagger} \end{array}$$

Notice that if F preserves unitary structure, it must be an isomix functor by Lemma 2.26. Also, when $A \in \mathbb{X}$ is a unitary object, then $F(A)$ must be a unitary object, and so $F(A)$ is in the core.

We now show that $\mathbf{M}_{\mathbf{x}\dagger} : (\mathbb{X}, \oplus, \oplus) \rightarrow (\mathbb{X}, \otimes, \oplus)$ provides a unitary structure preserving equivalence of a dagger monoidal category into a unitary category:

Proposition 4.11. *Unitary categories are \dagger -linearly equivalent via the mix functor $\text{Mx}_\dagger : (\mathbb{X}, \oplus, \otimes) \rightarrow (\mathbb{X}, \otimes, \oplus)$ to the underlying dagger monoidal category on the par. Furthermore, closed unitary categories under this equivalence become dagger compact closed categories.*

Proof. We must exhibit a preservator, that is a natural transformation showing that the involution is preserved:

$$\frac{\text{Mx}_\dagger(A^\dagger) \xrightarrow{\varphi_A} \text{Mx}_\dagger(A)^\dagger}{A \xrightarrow{\varphi_A} A^\dagger}$$

Note that φ is a natural transformation by the definition of $(-)^\dagger$ and its coherence requirements make it a linear natural equivalence. Making this the preservator immediately means that unitary structure is preserved.

Finally, we must show that unitary linear duals under Mx_\dagger^* become \ddagger -duals. Given $(\eta, \epsilon) : A \dashv_u B$ we must show that under Mx_\dagger^* this produces a dagger dual. $\text{Mx}_\dagger^*(\eta) = \text{m} \eta : \perp \rightarrow A \oplus B$ and $\text{Mx}_\dagger^*(\epsilon) = \text{mx}^{-1} \epsilon : B \oplus A \rightarrow \perp$. We then require that $c_\oplus \text{Mx}_\dagger^*(\epsilon) = \text{Mx}_\dagger^*(\eta)^\dagger$. This is provided by:

$$\begin{array}{ccccc}
 & & & \text{Mx}_\dagger^*(\epsilon) & \\
 & & & \curvearrowright & \\
 A \oplus B & \xrightarrow{c_\oplus} & B \oplus A & \xrightarrow{\text{mx}^{-1}} & B \otimes A & \xrightarrow{\epsilon} & \perp \\
 \downarrow \text{mx}^{-1} & & \downarrow c_\otimes & & \downarrow \epsilon & & \downarrow \text{m} \\
 A \otimes B & & & & & & \perp \\
 \downarrow \varphi_A \otimes \varphi_B & \text{Defn. 4.3 (b)} & & & & & \downarrow \text{m} \\
 A^\dagger \otimes B^\dagger & & & & & & \perp \\
 \downarrow \lambda_\otimes & & & & & & \downarrow \lambda_\top \\
 (A \oplus B)^\dagger & \xrightarrow{\eta^\dagger} & \top^\dagger & \xrightarrow{\text{m}^\dagger} & \perp^\dagger & & \\
 & & & \curvearrowleft & & & \\
 & & & \text{Mx}_\dagger^*(\eta)^\dagger & & & \\
 \varphi_{A \oplus B} & & & & & & \varphi_\perp
 \end{array}$$

□

4.1.3 The unitary construction

A \dagger -isomix category can have many different unitary structures, as we shall describe in this section, thus it is *structure*, and not a property. The requirements, however, do mean that for a \dagger -isomix category, \mathbb{X} , there is always a smallest unitary structure, referred to as the “trivial” unitary structure, that produces a full unitary subcategory in \mathbb{X} . In this subsection, we provide a construction called the unitary construction which produces this unitary category from any \dagger -isomix category. The construction is based on identifying objects with pre-unitary structure: the tensor units always have a canonical “pre-unitary” structure so the construction always produces a non-empty category. However, to ensure that an

application of the construction yields a unitary category in which there are objects which are not isomorphic to the units, one must exhibit concretely such objects. Fortunately this is often not difficult to do, making the construction quite applicable.

Definition 4.12.

- (i) In a \dagger -isomix category, a **pre-unitary object** is an object $U \in \text{Core}(\mathbb{X})$, together with an isomorphism $\alpha : U \rightarrow U^\dagger$ such that $\alpha(\alpha^{-1})^\dagger = \iota$.
- (ii) Suppose \mathbb{X} is a \dagger -isomix category, then define $\text{Unitary}(\mathbb{X})$, the **canonical unitary core** of \mathbb{X} , as follows:

Objects: Pre-unitary objects (U, α) ,

Maps: $(U, \alpha) \xrightarrow{f} (V, \beta)$ where $U \xrightarrow{f} V$ is any map of \mathbb{X} .

We note that any object which is isomorphic to a preunitary object is also pre-unitary:

Lemma 4.13. In a \dagger -isomix category, if U is a pre-unitary object and there exists an isomorphism $f : U \rightarrow U'$, then U' is pre-unitary.

Our objective is to show that $\text{Unitary}(\mathbb{X})$ is endowed with all the structure of a unitary category.

Lemma 4.14. For any \dagger -isomix category, its canonical unitary core is a compact \dagger -LDC with tensor and par defined by

$$(\top, \mathbf{m}^{-1}\lambda_\perp : \top \rightarrow \top^\dagger) \quad (A, \alpha) \otimes (B, \beta) := (A \otimes B, \mathbf{m}(\alpha \oplus \beta)\lambda_\oplus : A \otimes B \rightarrow (A \otimes B)^\dagger)$$

$$(\perp, \mathbf{m} \lambda_\top : \perp \rightarrow \perp^\dagger) \quad (A, \alpha) \oplus (B, \beta) := (A \oplus B, \mathbf{m}^{-1}(\alpha \otimes \beta)\lambda_\otimes : A \oplus B \rightarrow (A \oplus B)^\dagger)$$

and $(U, \alpha)^\dagger := (U^\dagger, (\alpha^{-1})^\dagger)$.

Proof. The proof uses the techniques of Lemma 4.2.

Note that, as the map and tensor structure is inherited from \mathbb{X} , it suffices to show that these objects are all pre-unitary objects. Starting with $(U\alpha)^\dagger$ we have:

$$(\alpha^{-1})^\dagger(((\alpha^{-1})^\dagger)^{-1})^\dagger = (\alpha^{-1})^\dagger(\alpha^\dagger)^\dagger = (\alpha^\dagger\alpha^{-1})^\dagger = (\iota^{-1})^\dagger = \iota$$

For the tensor and par we have:

$$\begin{aligned}
\mathbf{m}^{-1}\lambda_{\perp}((\mathbf{m}^{-1}\lambda_{\perp})^{-1})^{\dagger} &= \mathbf{m}^{-1}\lambda_{\perp}\mathbf{m}^{\dagger}\lambda_{\perp}^{\dagger} \\
&\stackrel{[\dagger\text{-mix}]}{=} \mathbf{m}^{-1}\mathbf{m}\lambda_{\top}\lambda_{\perp}^{\dagger} = \iota \\
\mathbf{m}\mathbf{x}^{-1}(\alpha \oplus \beta)\lambda_{\oplus}((\mathbf{m}\mathbf{x}^{-1}(\alpha \oplus \beta)\lambda_{\oplus})^{-1})^{\dagger} &= \mathbf{m}\mathbf{x}^{-1}(\alpha \oplus \beta)\lambda_{\oplus}(\mathbf{m}\mathbf{x}^{\dagger})(\alpha^{-1} \oplus \beta^{-1})^{\dagger}(\lambda_{\oplus}^{-1})^{\dagger} \\
&= \mathbf{m}\mathbf{x}^{-1}(\alpha \oplus \beta)\mathbf{m}\mathbf{x}\lambda_{\otimes}(\alpha^{-1} \oplus \beta^{-1})^{\dagger}(\lambda_{\oplus}^{-1})^{\dagger} \\
&= (\alpha \otimes \beta)\lambda_{\otimes}(\alpha^{-1} \oplus \beta^{-1})^{\dagger}(\lambda_{\oplus}^{-1})^{\dagger} \\
&= (\alpha \otimes \beta)((\alpha^{-1})^{\dagger} \otimes (\beta^{-1})^{\dagger})\lambda_{\otimes}(\lambda_{\oplus}^{-1})^{\dagger} \\
&\stackrel{\text{Defn 4.12-(i)}}{=} (\iota \otimes \iota)\lambda_{\otimes}(\lambda_{\oplus}^{-1})^{\dagger} \\
&\stackrel{[\dagger\text{-ldc.4}]}{=} \iota
\end{aligned}$$

$$\begin{aligned}
\mathbf{m}\lambda_{\top}((\mathbf{m}\lambda_{\top})^{-1})^{\dagger} &= \mathbf{m}\lambda_{\top}(\mathbf{m}^{-1})^{\dagger}(\lambda_{\top}^{-1})^{\dagger} \\
&= \mathbf{m} \mathbf{m}^{-1}\lambda_{\perp}(\lambda_{\top}^{-1})^{\dagger} = \iota \\
\mathbf{m}\mathbf{x}(\alpha \otimes \beta)\lambda_{\otimes}((\mathbf{m}\mathbf{x}(\alpha \otimes \beta)\lambda_{\otimes})^{-1})^{\dagger} &= \mathbf{m}\mathbf{x}(\alpha \otimes \beta)\lambda_{\otimes}(\mathbf{m}\mathbf{x}^{-1})^{\dagger}(\alpha^{-1} \otimes \beta^{-1})^{\dagger}(\lambda_{\otimes}^{-1})^{\dagger} \\
&= (\alpha \oplus \beta)\mathbf{m}\mathbf{x} \mathbf{m}\mathbf{x}^{-1}\lambda_{\oplus}(\alpha^{-1} \otimes \beta^{-1})^{\dagger}(\lambda_{\otimes}^{-1})^{\dagger} \\
&= (\alpha \oplus \beta)((\alpha^{-1})^{\dagger} \oplus (\beta^{-1})^{\dagger})\lambda_{\oplus}(\lambda_{\otimes}^{-1})^{\dagger} \\
&= (\iota \oplus \iota)\lambda_{\oplus}(\lambda_{\otimes}^{-1})^{\dagger} = \iota.
\end{aligned}$$

□

This makes $\mathbf{Unitary}(\mathbb{X})$ into a compact \dagger -LDC with all the structure inherited directly from \mathbb{X} . However, more is true: each object now has an obvious unitary structure. This gives:

Proposition 4.15. *For any \dagger -isomix category, \mathbb{X} , $\mathbf{Unitary}(\mathbb{X})$ is a unitary category with a full and faithful underlying \dagger -isomix functor $U : \mathbf{Unitary}(\mathbb{X}) \rightarrow \mathbb{X}$.*

Proof. The laxors are all identity maps so that the underlying functors is immediately a \dagger -mix functor.

It remains to show that every object is unitary: we set the unitary structure of an object to be $\alpha : (X, \alpha) \rightarrow (X, \alpha)^{\dagger}$. However, [U.1] – [U.5] are immediately satisfied by construction implying this provides unitary structure for every object. □

Next, we prove the couniversal property of the unitary construction. Define \mathbf{UCat} to be the category of unitary categories and \dagger -isomix functors that preserve unitary structure in the sense of Definition 4.10, thus, whenever φ_A is the unitary structure then $F'(\varphi_A)\rho^{F'}$

is unitary structure. Define **Kompact** to be the category of compact \dagger -LDCs and \dagger -isomix functors.

We now show that the unitary construction produces a right adjoint to the underlying functor $U : \mathbf{UCat} \rightarrow \mathbf{Kompact}$ which is the identity functor. Preliminary to this result we prove that Frobenius functors preserve preunitary objects:

Lemma 4.16. *If $F : \mathbb{X} \rightarrow \mathbb{Y}$ is a \dagger -isomix functor between compact \dagger -LDCs and (A, φ) is a preunitary object of \mathbb{X} , then $(F(A), F(\varphi)\rho)$ is a preunitary object of \mathbb{Y} .*

Proof. To prove that $(F(A), F(\varphi)\rho)$ is a preunitary object, one has the following computation:

$$\begin{aligned} F(\varphi)\rho((F(\varphi)\rho)^{-1})^\dagger &= F(\varphi)\rho F(\varphi^{-1})^\dagger(\rho^{-1})^\dagger \\ &= F(\varphi(\varphi^{-1})^\dagger)\rho(\rho^{-1})^\dagger \\ &= F(\iota)\rho(\rho^{-1})^\dagger \stackrel{[\dagger\text{-isomix}]}{=} \iota. \end{aligned}$$

□

Proposition 4.17. $U : \mathbf{UCat} \rightarrow \mathbf{Kompact}$ has a right adjoint $\mathbf{Unitary} : \mathbf{Kompact} \rightarrow \mathbf{UCat}; \mathbb{C} \mapsto \mathbf{Unitary}(\mathbb{C})$.

Proof. The couniversal diagram is as follows:

$$\begin{array}{ccc} U(\mathbb{U}) & \xrightarrow{F} & \mathbb{C} \\ U(F^b) \downarrow \dashv & \nearrow \epsilon & \\ U(\mathbf{Unitary}(\mathbb{C})) & & \end{array}$$

Since F is a \dagger -isomix functor it preserves preunitary structure (see Lemma 4.16). This means that each (U, φ_U) in \mathbb{U} is carried by F onto a preunitary object in \mathbb{C} , $(F(U), F(\varphi)\rho^F)$. But a preunitary object in \mathbb{C} is an object of $\mathbf{Unitary}(\mathbb{C})$ and this determines F^b . The functor F^b is uniquely determined as it must preserve the unitary structure. □

4.2 Examples: The unitary construction

In Section 3.3, we discussed examples of \dagger -isomix categories in which the \dagger is given by composing the conjugation functor and the dualizing functor. In the rest of the section, we apply the unitary construction to each of those examples to construct a unitary category:

4.2.1 Category of abstract state spaces

In Section 3.2.3, we discussed a construction on a \dagger -isomix category, \mathbb{X} , that produces a category of abstract state spaces, $\text{Asp}(\mathbb{X})$, which is a \dagger -isomix category. In this section, we examine the preunitary objects of $\text{Asp}(\mathbb{X})$. Since all the basic natural isomorphisms are inherited from \mathbb{X} , $\text{Core}(\mathbb{X})$ determines $\text{Core}(\text{Asp}(\mathbb{X}))$. If (A, α) is a preunitary object for \mathbb{X} , and $(A, e_A, u_A) \in \text{Asp}(\mathbb{X})$ then, $((A, e_A, u_A), \alpha)$ is a preunitary object for $\text{Asp}(\mathbb{X})$ if $u_A \alpha = \lambda_{\top} e_A^{\dagger}$.

4.2.2 Category of a group with involution

We discussed a source of examples of compact \dagger -LDCs which are given by groups with conjugation. Applying unitary construction to each of the example categories results in the following unitary categories. It could be noticed that the preunitary objects in each of these categories includes those group elements such that $\overline{g^{-1}} = g$. More explicitly, the preunitary objects are $(g, 1)$ such that $\overline{g^{-1}} = g$.

- In the discrete category of complex numbers, $\mathbb{D}(\mathbb{C}, +, 0)$,

$$(a + ib)^{\dagger} := \overline{(a + ib)^*} = \overline{-a - ib} = -a + ib$$

The preunitary objects in this category are given by all complex numbers, i.e., $(ib, 1)$.

- In the discrete category of non-zero complex numbers, $\mathbb{D}(\mathbb{C}, \cdot, 1)$, the preunitary objects are given by complex numbers on a unit circle.
- In the discrete category, $\mathbb{D}(P(x), +, 0)$, where $P(x)$ is a polynomial ring, $P(x)^{\dagger} = -P(-x)$ and the preunitary objects are polynomials $P(x) = \sum_n a_n x^n$ such that n is odd.
- In $\mathbb{D}(\mathbb{M}_2, \cdot, I_2)$ where \mathbb{M}_2 is the group of 2×2 invertible matrices over \mathbb{C} . The \dagger structure is as follows:

$$\begin{pmatrix} a + ib & m + in \\ c + id & p + iq \end{pmatrix}^{\dagger} := \overline{\begin{pmatrix} a + ib & m + in \\ c + id & p + iq \end{pmatrix}^*} = \begin{pmatrix} a - ib & c - id \\ m - in & p - iq \end{pmatrix}^{-1}$$

The preunitary objects in this category are the unitary matrices.

4.2.3 Category of Hopf modules in a $*$ -autonomous category

In Section 3.4.4, we described a construction of \dagger -isomix categories from any symmetric isomix $*$ -autonomous category, \mathbb{X} , by choosing the Hopf Modules over a cocommutative \otimes -Hopf Algebra. We referred to the resulting category as $\mathbf{H}\text{-Mod}_{\mathbb{X}}$. Now we shall look at the preunitary objects in $\mathbf{H}\text{-Mod}_{\mathbb{X}}$ in order to apply the unitary construction to this category. We begin by identifying the objects in the core of $\mathbf{H}\text{-Mod}_{\mathbb{X}}$:

Lemma 4.18. *Suppose \mathbb{X} is a mix $*$ -autonomous category and H is a cocommutative Hopf Algebra in \mathbb{X} . If (A, Ψ) is a H -Module and $A \in \text{Core}(\mathbb{X})$, then $(A, \Psi) \in \text{Core}(\mathbf{H}\text{-Mod}_{\mathbb{X}})$.*

Proof. The mixer $\text{mx} : A \otimes B \rightarrow A \oplus B$ is inherited directly from \mathbb{X} . Hence, $(A, \Psi) \in \text{Core}(\mathbf{H}\text{-Mod}_{\mathbb{X}})$. \square

Now that we identified the objects in the core, we prove a lemma that will be used later to identify the preunitary objects from the core:

Lemma 4.19. *The following equality holds for a Frobenius algebra:*

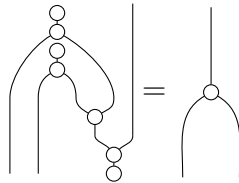

Proof.

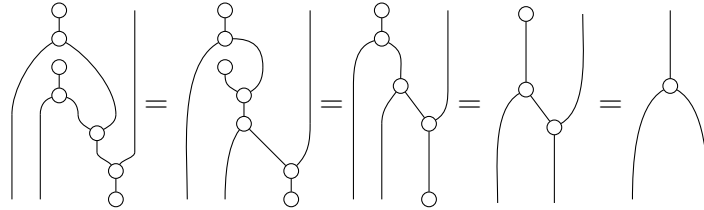



\square

In the following Proposition we identify the preunitary objects in the core:

Proposition 4.20. *Suppose \mathbb{X} is a symmetric mix $*$ -autonomous category and H is a cocommutative Hopf Algebra in \mathbb{X} . If $A \in \text{Core}(\mathbb{X})$ and $(A, \varphi, \rho, \lambda, \delta)$ is a cocommutative Frobenius Algebra with an algebra homomorphism $H \xrightarrow{h} A$ then,*

(a) (A, Ψ) is a H -Module where, $\Psi : H \otimes A \rightarrow A :=$ 

(b) $\overline{(A, \Psi)^*} = (A, \Psi)$ where A^* is the self-dual Frobenius Algebra with cups and caps defined as  and  respectively. Hence, $A^* = A$ and $(A, \Psi)^\dagger = (A, \Psi)$.

Proof.

(a)  : $H \otimes A \rightarrow A$ is a left action because $h : H \rightarrow A$ is an algebra homomorphism.

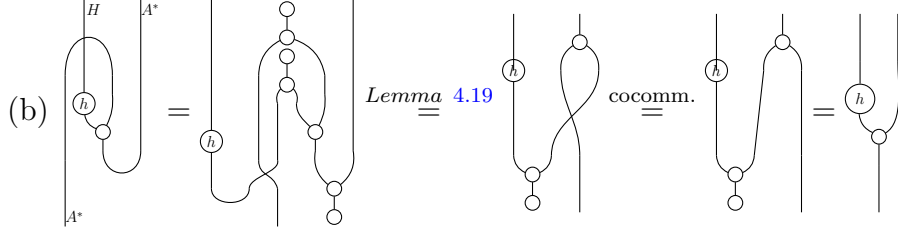

□

Corollary 4.21. $((A, \varphi, \imath, \rho, \delta), \Psi, 1)$ is a preunitary object.

Thus, we have a source of non-trivial preunitary objects so that we can form a non-trivial unitary category.

4.3 Mixed unitary categories

A mixed unitary category has a unitary core which is a model of classical categorical quantum mechanics extended by a larger setting in which possibly infinite dimensional objects can be modelled. We are now ready for the definition of mixed unitary categories, which is the key structure developed in the first part of this thesis.

4.3.1 Mixed unitary category

Definition 4.22. A mixed unitary category (MUC) is a \dagger -isomix category, \mathbb{C} , equipped with a strong \dagger -isomix functor $M : \mathbb{U} \rightarrow \mathbb{C}$ from a unitary category \mathbb{U} to \mathbb{C} such that there exists the following natural transformations:

$$\mathbf{mx}' : M(U) \oplus X \rightarrow M(U) \otimes X \text{ with } \mathbf{mx} \mathbf{mx}' = 1 \text{ and } \mathbf{mx}' \mathbf{mx} = 1$$

$$\mathbf{mx}'' : X \oplus M(U) \rightarrow X \otimes M(U) \text{ with } \mathbf{mx} \mathbf{mx}'' = 1 \text{ and } \mathbf{mx}'' \mathbf{mx} = 1$$

A mixed unitary category, $M : \mathbb{U} \rightarrow \mathbb{C}$ is **symmetric** if the functor M , the unitary category \mathbb{U} , and the \dagger -isomix category \mathbb{C} are symmetric.

In the definition of a MUC, the requirement of a transformation \mathbf{mx}' which is inverse to \mathbf{mx} ensures that the functor $M : \mathbb{U} \rightarrow \mathbb{C}$ factors through $\text{Core}(\mathbb{C})$. Figure 4.2 is a schematic diagram of a MUC.

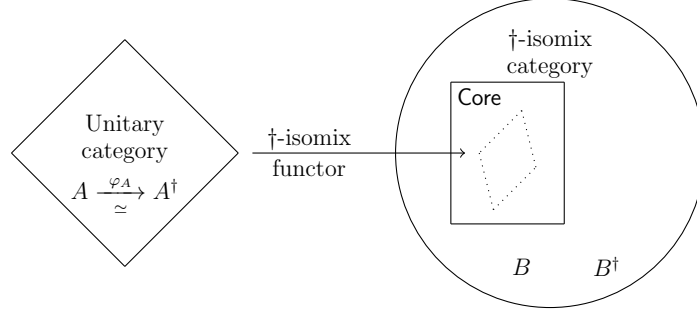

Figure 4.2: Schematic diagram for MUC

The \dagger -isomix category of a MUC is to be thought of as a larger space inside which a (small) unitary category embeds. Within the unitary category, $A \simeq A^\dagger$ by the means of the unitary structure map, however, outside the unitary core, an object is not in general isomorphic to its dagger.

In the rest of the thesis, MUCs are exclusively assumed to be symmetric unless stated otherwise.

Mix unitary categories organize themselves into a 2-category MUC (although we shall not discuss the 2-cell structure):

0-cells: Are mix unitary categories $M : \mathbb{U} \rightarrow \mathbb{X}$;

1-cells: Are MUC morphisms: these are squares of \dagger -isomix functors $(F', F, \gamma) : M \rightarrow N$ commuting up to a \dagger -linear natural isomorphism $\gamma : MF \Rightarrow F'N$:

$$\begin{array}{ccc}
 \mathbb{U} & \xrightarrow{M} & \mathbb{X} \\
 F' \downarrow & \Downarrow \gamma & \downarrow F \\
 \mathbb{V} & \xrightarrow{N} & \mathbb{Y}
 \end{array}$$

The functor $F' : \mathbb{U} \rightarrow \mathbb{V}$ is between unitary categories, and we demand of it that it preserves unitary structure in the sense of Definition 4.10, thus, whenever φ_A is the unitary structure then $F'(\varphi_A)\rho^F$ is unitary structure.

2-cells: These are “pillows” of natural transformations. $(\beta, \beta') : (F, F', \gamma_F) \Rightarrow (G, G', \gamma_G)$ is a 2-cell if and only if it satisfies the following equality:

$$\begin{array}{ccc}
 \begin{array}{ccc}
 \mathbb{U} & \xrightarrow{M} & \mathbb{X} \\
 \downarrow G' & \leftarrow \beta' & \downarrow F \\
 \mathbb{V} & \xrightarrow{N} & \mathbb{Y} \\
 \downarrow F' & \Downarrow \gamma_F & \downarrow F
 \end{array} & = &
 \begin{array}{ccc}
 \mathbb{U} & \xrightarrow{M} & \mathbb{X} \\
 \downarrow G' & \leftarrow \beta & \downarrow G \\
 \mathbb{V} & \xrightarrow{N} & \mathbb{Y} \\
 \downarrow \gamma_G & \Downarrow \gamma_G & \downarrow F
 \end{array}
 \end{array}$$

We remark that we have observed that any MUC can be “simplified” to a dagger monoidal category with a strong \dagger -mix Frobenius functor into a \dagger -isomix category: this is achieved by precomposing with \mathbf{Mx}_\downarrow . This may seem a worthwhile simplification, but it should be recognized that it simply transfers complexity from the unitary category itself onto the preservator which must now “create” unitary structure:

$$\begin{array}{ccc} \mathbb{U} & \xrightarrow{M} & \mathbb{C} \\ \mathbf{Mx}_\downarrow^* \downarrow & & \parallel \\ \mathbb{U}_\downarrow & \xrightarrow{\mathbf{Mx}_\downarrow; M} & \mathbb{C} \end{array}$$

Here $\mathbb{U}_\downarrow = (\mathbb{U}, \oplus, \oplus)$ is viewed as a dagger monoidal category and \mathbf{Mx}_\downarrow^* is the inverse of \mathbf{Mx}_\downarrow . The point is that the preservator of the lower arrow $\mathbf{Mx}_\downarrow; M$ is non-trivial as it must encode the unitary structure of \mathbb{U} .

4.3.2 Canonical mixed unitary categories

Our objective is now to show that the unitary construction of the previous section gives rise to a right adjoint to the underlying 2-functor $U : \mathbf{MUC} \rightarrow \mathbf{MCC}$ where the 2-category \mathbf{MCC} is defined as:

0-cells: Its objects are **mixed \dagger -compact categories** (\mathbf{MCC}), that is strong \dagger -Frobenius functors $V : \mathbb{C} \rightarrow \mathbb{Y}$ where \mathbb{C} is a compact \dagger -LDC, \mathbb{Y} is a \dagger -isomix category, and V factors through the core of \mathbb{Y} i.e, for all \forall objects $C \in \mathbb{C}$, $Y \in \mathbb{Y}$, $\exists \mathbf{mx}' : V(C) \oplus Y \rightarrow V(C) \otimes Y$ such that $\mathbf{mx} \mathbf{mx}' = 1$ and $\mathbf{mx}' \mathbf{mx} = 1$.

1-cells: The 1-cells are squares of mix Frobenius functors which commute up to a linear natural isomorphism;

2-cells: Are pillows of natural transformations (which we shall ignore).

An example of a mix \dagger -compact category is, of course, the inclusion of the core into a \dagger -isomix category $C : \mathbf{Core}(\mathbb{X}) \hookrightarrow \mathbb{X}$;

Proposition 4.23. $U : \mathbf{MUC} \rightarrow \mathbf{MCC}$ has a right adjoint $\mathbf{Unitary} : \mathbf{MCC} \rightarrow \mathbf{MUC}$; $(\mathbb{C} \xrightarrow{V} \mathbb{X}) \mapsto (\mathbf{Unitary}(\mathbb{C}) \xrightarrow{U;V} \mathbb{X})$.

Proof. The couniversal diagram is as follows:

$$\begin{array}{ccccc} \mathbb{U} & \xrightarrow{M} & \mathbb{X} & \xrightarrow{(F,G,\gamma)} & \mathbb{C} & \xrightarrow{V} & \mathbb{Y} \\ & & \downarrow (F^b,G,\gamma^b) & \nearrow \epsilon & & & \\ \mathbf{Unitary}(\mathbb{C}) & \xrightarrow{U;V} & \mathbb{Y} & & & & \end{array}$$

where ϵ is the square on the left and (F^b, G, γ^b) is the square on the right:

$$\begin{array}{ccc}
\text{Unitary}(\mathbb{C}) & \xrightarrow{U} & \mathbb{C} & \xrightarrow{V} & \mathbb{Y} \\
U \downarrow & & & & \parallel \\
\mathbb{C} & \xrightarrow{V} & & & \mathbb{Y}
\end{array}
\qquad
\begin{array}{ccccc}
\mathbb{U} & \xrightarrow{M} & & \mathbb{X} & \\
\downarrow F^b & \searrow & & \uparrow \gamma & \downarrow G \\
\text{Unitary}(\mathbb{C}) & \xrightarrow{F} & \mathbb{C} & \xrightarrow{V} & \mathbb{Y} \\
& & \downarrow U & &
\end{array}$$

It follows from Proposition 4.17 that the couniversal diagram commute. \square

This proposition means that in building a non-trivial MUC from a mixed \dagger -compact categories it suffices to show that the compact \dagger -LDC contains non-trivial pre-unitary objects.

4.4 Examples: Mixed unitary categories

We have already noted that dagger monoidal categories are automatically unitary categories in which the unitary structure is given by identity maps. The identity functors then give a rather trivial MUC. One can construct a MUC from any \dagger -isomix category using the unitary construction: for any \dagger -isomix category, \mathbb{X} , $\text{Unitary}(\text{Core}(\mathbb{X})) \xrightarrow{U} \text{Core}(\mathbb{X}) \hookrightarrow \mathbb{X}$ is a MUC. More excitingly one can take the bicompletion [82] of the \dagger -monoidal category: this is a non-trivial \dagger -isomix $*$ -autonomous category extension of the original \dagger -monoidal category and provides, thus, an interesting example of how MUCs arise.

Our purpose in this section is to exhibit some non-trivial manifestations of the various structural components of a MUC. To this end we discuss in some detail three basic examples.

4.4.1 Finite dimensional framed vector spaces

In this section we show that the example FFVec_K , the category of finite dimensional framed vector spaces defined in Section 3.2.2 is a unitary category (hence is immediately a mixed unitary category). The unitary structure map on each object (V, \mathcal{V}) is defined as follows:

$$\varphi_{(V, \mathcal{V})} : (V, \mathcal{V}) \rightarrow (V, \mathcal{V})^\dagger; v_i \mapsto \tilde{v}_i$$

and it remains to check the coherences [U.3]–[U.6]. First note that [U.4] holds immediately by the observation above that $\iota(v_i) = \tilde{\tilde{v}}_i$. For [U.3] we require that $\varphi_{A^\dagger}(\tilde{a}_i) = (\varphi_A^{-1})^\dagger(\tilde{a}_i)$ the result is a higher-order term so, we may check that the evaluations are the same on basis elements:

$$\begin{aligned}
(\varphi_{A^\dagger}(\tilde{a}_i))(\tilde{a}_j) &= \tilde{\tilde{a}}_i(\tilde{a}_j) = \partial_{i,j} \\
((\varphi_A^{-1})^\dagger(\tilde{a}_i))(\tilde{a}_j) &= \tilde{a}_i((\varphi_A^{-1})^\dagger(\tilde{a}_j)) = \tilde{a}_i(a_j) = \partial_{i,j}
\end{aligned}$$

Note that [U.5](a) and [U.5](b), in this example, require $\lambda_{\top} = \varphi_{\top}$ which can easily be verified as each reduces to conjugation. [U.6](a) and [U.6](b), in this example, are the same requirement which is verified by:

$$\lambda_{\otimes}(\varphi_A \otimes \varphi_B(a_i \otimes b_j)) = \lambda_{\otimes}(\widetilde{a}_i \otimes \widetilde{b}_j) = \widetilde{a_i \otimes b_j} = \varphi_{A \otimes B}(a_i \otimes b_j)$$

This gives:

Proposition 4.24. *FFVec_K with the unitary structure above is a MUC.*

This raises the question of what precisely the unitary maps of this example are. To elucidate this we note that a functor can easily be constructed $U : \text{FFVec}_K \rightarrow \text{Mat}(K)$ where, for each object in FFVec_K we choose a total order on the elements of the basis and note that any map is then given by a matrix acting on the bases: thus a matrix in $\text{Mat}(K)$ with the appropriate dimensions. We now observe:

Lemma 4.25. *An isomorphism $u : (A, \mathcal{A}) \rightarrow (B, \mathcal{B})$ in FFVec_K is unitary if and only if $U(f)$ is unitary in $\text{Mat}(K)$.*

Proof. While U does not preserve $(-)^{\dagger}$ on the nose it does so up to the natural equivalence determined by $U(\varphi_A)$ which being a basis permutation is a unitary equivalence. Thus, it is not hard to see that the following diagram commutes:

$$\begin{array}{ccc} U(B, \mathcal{B}) & \xrightarrow{U(\varphi_B)} & U((B, \mathcal{B})^{\dagger}) \\ U(f)^{\dagger} \downarrow & & \downarrow U(f^{\dagger}) \\ U(A, \mathcal{A}) & \xrightarrow{U(\varphi_A)} & U((A, \mathcal{A})^{\dagger}) \end{array}$$

Recall that in the category of matrices, the dagger is stationary on objects so $U(B, \mathcal{B}) = U(B, \mathcal{B})^{\dagger}$.

Now suppose u is unitary in FFVec_K then $u^{-1} = \varphi_B u^{\dagger} \varphi_A^{-1}$ so that

$$U(u)^{-1} = U(u^{-1}) = U(\varphi_B u^{\dagger} \varphi_A^{-1}) = U(\varphi_B) U(u^{\dagger}) U(\varphi_A^{-1}) = U(u)^{\dagger}$$

so that its underlying map is unitary. Conversely, if $U(u)$ is unitary then

$$U(u^{-1}) = U(u)^{-1} = U(u)^{\dagger} = U(\varphi_B u^{\dagger} \varphi_A^{-1})$$

which immediately implies, as U is faithful, that u is unitary in FFVec_K . □

One might reasonably regard this as a rather roundabout way to describe the standard notion of a unitary map. However, two things of importance have been achieved. First an

example of a unitary category with a non-stationary dagger and, thus, a non-identity unitary structure, has been exhibited. Second we have shown how the standard unitary structure may be re-expressed in this formalism using non-stationary constructs.

4.4.2 Finiteness matrices

In Section 3.4.2, we described the category of finiteness matrices, $\mathbf{FMat}(\mathbb{C})$. The core of $\mathbf{FMat}(\mathbb{C})$ is the subcategory determined by objects whose webs are finite sets, that is the objects are $(X, P(X))$ where X is a finite set. Clearly, $\mathbf{Core}(\mathbf{FMat}(\mathbb{C}))$ is then equivalent to the category of finite dimensional matrices, $\mathbf{Mat}(\mathbb{C})$. This is a well-known \dagger -compact closed category, which is a unitary category with unitary structure given by identity maps (as $(_)^\dagger$ is stationary on objects). The inclusion $\mathcal{I} : \mathbf{Mat}(\mathbb{C}) \rightarrow \mathbf{FMat}(\mathbb{C})$ provides an important example of a MUC.

4.4.3 The embedding of finite dimensional Hilbert Spaces into Chu Spaces

In Section 3.4.3, we showed that the Chu construction applied to a symmetric conjugative closed monoidal category, \mathbb{X} , with pullbacks gives a \dagger -isomix category. Recall that the dagger in the resulting category of Chu spaces is given by composing the conjugation with the dualizing functor. In this section, we start by discussing, in general, the construction of a mixed unitary category from a Chu category $\mathbf{Chus}_{\mathbb{X}}(I)$. A crucial step in this is to identify objects which are in the core of this category.

Recall that a symmetric monoidal closed category, \mathbb{X} , is (degenerately) a compact linearly distributive category and, thus, there may be objects which have linear adjoints: these are called **nuclear** objects [79]. Explicitly a nuclear object A in a symmetric monoidal closed category is an object with $A \multimap B \cong A^* \otimes B$, where $A^* := A \multimap I$. The nuclear objects form a compact closed subcategory of \mathbb{X} which is conjugative when \mathbb{X} is conjugative. In $\mathbf{Vec}_{\mathbb{C}}$ the nucleus consist precisely of the finite dimensional vector spaces. If $(\eta, \epsilon) : A \dashv B$ is witness that A (and B) are nuclear in \mathbb{X} then the object $(A, B, \epsilon, c_{\otimes}\epsilon)$ is in the core of $\mathbf{Chus}_{\mathbb{X}}(I)$ because in the second component of the tensor product with any other object $(X, Y, \nu, c_{\otimes}\nu)$ one has the degenerate pullback:

$$\begin{array}{ccccc}
 & & Y \otimes B & & \\
 & \swarrow & & \searrow & \\
 X \multimap B & & & & Y \otimes A^* \\
 & \searrow & & \swarrow & \\
 & & X \multimap A^* & \xrightarrow{\cong} & (X \multimap I) \otimes A
 \end{array}$$

where we use the isomorphism $B \xrightarrow{\cong} A^*$.

In this manner the nuclear objects of $\mathbf{Nuclear}(\mathbb{X})$, which form a compact closed category with a dagger, may be embedded into the core of $\mathbf{Chus}_{\mathbb{X}}(I)$. To obtain a unitary category it suffices then to use the unitary construction for which, to obtain a non-trivial result, we need to show that there are non-trivial examples of pre-unitary objects. To achieve this we consider an object H for which $(e, n) : H \dashv \overline{H}$ and such that e satisfies:

$$\begin{array}{ccc} \overline{\overline{H}} \otimes \overline{H} & \xrightarrow{\chi} & \overline{\overline{H}} \otimes \overline{H} \\ \varepsilon \otimes 1 \downarrow & & \downarrow \bar{\varepsilon} \\ H \otimes \overline{H} & & \\ e \downarrow & & \downarrow \\ I & \xrightarrow{\chi} & I \end{array}$$

For such an object we note:

$$\begin{aligned} \overline{(H, \overline{H}, e, c_{\otimes} e)}^* &= (\overline{H}, \overline{\overline{H}}, \chi \overline{c_{\otimes} e} (\chi^{\circ})^{-1}, \chi \bar{\varepsilon} (\chi^{\circ})^{-1})^* \\ &= (\overline{\overline{H}}, \overline{H}, \chi \bar{\varepsilon} (\chi^{\circ})^{-1}, \chi \overline{c_{\otimes} e} (\chi^{\circ})^{-1}) \end{aligned}$$

This makes

$$(\varepsilon^{-1}, 1) : (H, \overline{H}, e, c_{\otimes} e) \rightarrow (\overline{\overline{H}}, \overline{H}, \chi \bar{\varepsilon} (\chi^{\circ})^{-1}, \chi \overline{c_{\otimes} e} (\chi^{\circ})^{-1})$$

a preunitary map. Note that it is a Chu map by the commuting diagram above and as $\bar{\varepsilon} = \varepsilon$ we have

$$(\varepsilon^{-1}, 1)(1, \bar{\varepsilon}) = (\varepsilon^{-1}, 1)(1, \varepsilon) = (\varepsilon^{-1}, \varepsilon)$$

where $(\varepsilon^{-1}, \varepsilon)$ is the involutor.

In $\mathbf{Vec}_{\mathbb{C}}$ a map $e : H \otimes \overline{H} \rightarrow \mathbb{C}$ is a ‘‘sesquilinear form’’ and the diagram above asserts that it is in addition a symmetric form. Any Hilbert space with its inner product, thus, satisfies the above conditions. Thus, it is clear that the embedding of the category of finite dimensional Hilbert Spaces into Chu spaces, $\mathbf{FHilb} \hookrightarrow \mathbf{Chus}_{\mathbf{Vec}_{\mathbb{C}}}(\mathbb{C})$ is a mixed unitary category. The embedding is in fact a full and faithful embedding which extends to *all* Hilbert spaces (although only the finite dimensional ones land in the core).

Explicitly the embedding is defined as follows: suppose H is a (finite dimensional) Hilbert Space, then the corresponding Chu Space is given by $(H, \overline{H}, \langle - | - \rangle_H)$, where $\langle - | - \rangle_H : H \otimes \overline{H} \rightarrow \mathbb{C}$ is the inner product. For any linear map $H \xrightarrow{f} K$ between Hilbert Spaces, the corresponding Chu map is given by $(f, f^{\dagger}) : (H, \overline{H}, \langle - | - \rangle_H) \rightarrow (K, \overline{K}, \langle - | - \rangle_K)$, where f^{\dagger} is the Hermitian adjoint of f so, $\langle f(a) | b \rangle = \langle a | f^{\dagger}(b) \rangle$.

Furthermore, observe that $(H, \overline{H}, \langle - | - \rangle_H)^\dagger := \overline{(H, \overline{H}, \langle - | - \rangle_H)^*} = (H, \overline{H}, \langle - | - \rangle_H)$. Hence, this embedding preserves the (stationary) dagger for all Hilbert spaces. However, the par of two infinite dimensional Hilbert spaces in this Chu category is not a Hilbert space so that the duality cannot be seen within the category of Hilbert spaces.

Chapter 5

Summary

Chapters 3, and 4 extend the theory of \dagger -monoidal categories and \dagger -compact closed categories to linearly distributive and $*$ -autonomous settings to obtain the categorical semantics of (multiplicative) \dagger -linear logic. In these linear settings, the two different tensor products (tensor and par) must be flipped by the dagger. Thus, one cannot have a stationary (identity on objects) dagger, and hence one is forced to replace the conventional dagger by a contravariant structure-preserving involution. This has coherence consequences: section 3.1 is dedicated to understanding the details of these coherences.

If multiplicative \dagger -linear logic is to provide a semantics for a generalized categorical quantum mechanics (CQM), then notions such as isometry and unitary isomorphism, which are central to CQM, should have an expression in this logic. In section 4.1 we showed that with additional “unitary structure” one can recapture classical CQM as a “unitary core” of multiplicative \dagger -linear logic. Furthermore, we showed how, from any \dagger -isomix category, it is always possible to extract a “unitary core” which is, up to equivalence, a \dagger -monoidal category (i.e a classical semantic setting for CQM).

This led to the notion of a mixed unitary category (MUC) given by a \dagger -isomix category with a chosen unitary core as our proposal for an extension of CQM. A MUC can be viewed as an extension much as a K -algebra extends a field K and permits the expression of properties which are difficult to express within K itself. In the extended setting of a MUC – finiteness matrices with its core for example – provides an extension of the classical CQM setting in which infinite dimensional types, such as those given by the exponential modalities, are present. Furthermore, in the extended setting one can bend, and yank wires without the category being compact.

This concludes the first part of this thesis. The second part discusses the application of MUCs to CQM.

Part II

Application of dagger linear logic to categorical quantum mechanics

Chapter 6

Categorical Quantum Mechanics

The program of Categorical Quantum Mechanics (CQM) was started by Coecke and Abramsky [4] in 2004 with the aim of developing a high-level formal language for quantum mechanics while moving away from the standard formalism based on Hilbert spaces. CQM derived ideas from logic and computer science, and used the diagrammatic language of compact closed categories for an intuitive but mathematically rigorous presentation of the fundamental axioms of quantum theory.

The purpose this chapter is to review the fundamentals of Categorical Quantum Mechanics and to describe its essential features used to study quantum mechanics.

6.1 Dagger monoidal categories

Categorical quantum mechanics (CQM) models physical systems as objects within a monoidal category and the physical processes as the maps in the category. The identity maps equate to the do-nothing processes. Sequential composition of processes is given by the composition of maps while parallel composition is modelled using the tensor product. Categorifying the notion of inner product in traditional quantum theory produces a \dagger -functor for monoidal categories giving rise to the theory of \dagger -monoidal categories.

6.1.1 Graphical calculus for monoidal categories

Monoidal categories come equipped with a graphical calculus [109], which allows for diagrammatic representation and manipulation of systems and processes. The availability of this graphical calculus is perhaps the most attractive aspect of using monoidal categories to study quantum mechanics.

In the graphical calculus of monoidal categories, the objects are represented by wires,

and arrows by circles ¹. An identity arrow is given by a wire without by circle.

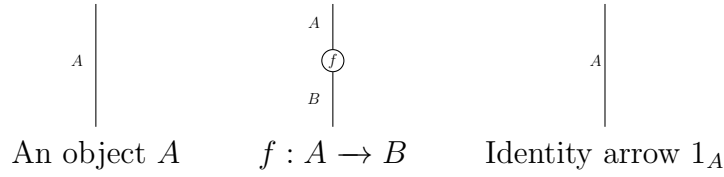

Note that the diagram for the object A is same as the identity arrow of A which is to be interpreted as follows: a physical system which does nothing is same as the system itself.

Composition of maps is given by connecting the wires sequentially. Tensor product of object is given by parallel juxtaposition of wires. The unit object is given by an empty circle representing the empty system. Recall that in LDCs, when the tensor and the par units are different, we used labelled wires to represent units.

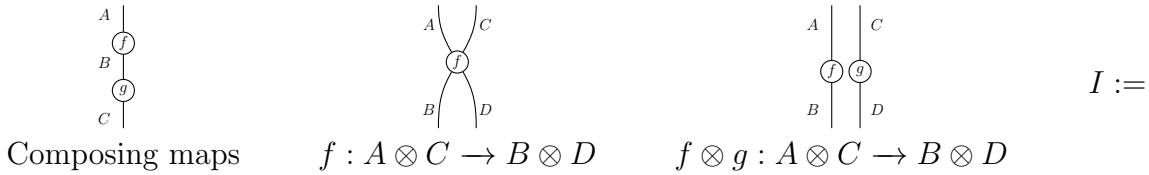

In CQM, maps from the tensor unit to any other object are referred to as **states**, maps into the tensor unit from any other object are referred to as **effects**, and maps that start and end in the tensor unit are referred to as **scalars**. States and effects are represented using triangles:



The associativity, left unitor, right unitor and the symmetry natural isomorphisms are given as follows:

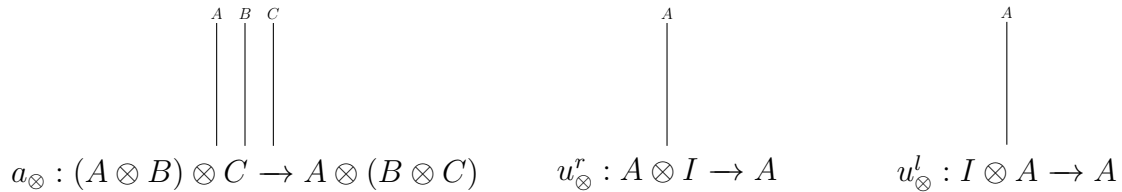

Note that the associativity isomorphisms, the left and the right unitors are identity maps. In fact, this is the graphical calculus for a strict monoidal category. Since every monoidal category is equivalent to a strict monoidal category [95] allows one to use this calculus on any monoidal category.

The symmetry map is represented using crossed wires as shown in the left. The inverse

¹In the CQM community, maps are often drawn as boxes. A circle and a box are topologically same.

law for a symmetric monoidal category is given by the diagrammatic equation in the right:

$$\begin{array}{ccc}
 \begin{array}{c}
 \begin{array}{c}
 \text{A} \quad \text{B} \\
 \diagdown \quad \diagup \\
 \diagup \quad \diagdown \\
 \text{B} \quad \text{A}
 \end{array} \\
 c_{\otimes} : A \otimes B \rightarrow B \otimes A
 \end{array} &
 &
 \begin{array}{c}
 \begin{array}{c}
 \diagdown \quad \diagup \\
 \diagup \quad \diagdown \\
 \diagdown \quad \diagup \\
 \diagup \quad \diagdown
 \end{array}
 =
 \begin{array}{c}
 | \quad | \\
 | \quad |
 \end{array} \\
 (c_{\otimes})_{B,A} = (c_{\otimes})_{A,B}^{-1}
 \end{array}
 \end{array}$$

An equation holds in a SMC if and only if it holds in the graphical calculus. Proving equations using graphical calculus is simpler than proving equations by reasoning with mathematical symbols because human brain excels at processing visual information.

Two diagrams are the same in the graphical calculus if one can be transformed to another up to planar isotopy or by using an axiom. For details on graphical calculus for monoidal categories see [109].

6.1.2 Dagger monoidal categories

Complex Hilbert spaces are used as the de facto framework for describing quantum processes. The inner product structure on these spaces allows the notion of adjoint which is in turn needed to define quantum observables: self-adjoint operators on the space. In quantum computing, every quantum logic gate is represented by a unitary (in other words a self-adjoint) matrix. CQM abstracts the notion of inner products as dagger [110, 47] functors for \dagger -monoidal categories.

Definition 6.1. A **dagger category** is a category, \mathbb{X} , equipped with a involutive ($f^{\dagger\dagger} = f$) contravariant functor $\dagger : \mathbb{X}^{\text{op}} \rightarrow \mathbb{X}$ which is the identity on objects ($A = A^{\dagger}$).

Note that, a given category can have more than one \dagger -functor, for example for the category of complex matrices (see Section 6.2.3) conjugate transpose and transpose operations on matrices gives two different dagger functors. Hence, \dagger is a structure rather than a property for a category. Because \dagger is a contravariant functor, $(fg)^{\dagger} = g^{\dagger}f^{\dagger}$.

Given any map $f : A \rightarrow B$, the map $f^{\dagger} : B \rightarrow A$ is referred to as its **adjoint**. A **unitary** isomorphism in a \dagger -category is an isomorphism f such that $f^{\dagger} = f^{-1}$. A map $f : A \rightarrow B$ is an isometry if $ff^{\dagger} = 1_A$.

Definition 6.2. A **\dagger -symmetric monoidal category** is a symmetric monoidal category which is also a \dagger -category such that the \dagger behaves coherently with the monoidal structure:

1. for all maps f, g , $(f \otimes g)^{\dagger} = f^{\dagger} \otimes g^{\dagger}$
2. the associator, the unitors and the symmetry map are unitary natural isomorphisms

Next, we discuss a key correspondence often used in quantum information theory called the operator-state duality, also referred to as the Choi-Jamiolkowski isomorphism: every linear map between (finite dimensional) Hilbert spaces H and K corresponds precisely to a state in the tensor product space $H \otimes K$. This correspondence is abstracted as follows using the compact structure [86] for monoidal categories.

Definition 6.3. *In a monoidal category, an object B is **right dual** to an object A if there exists maps:*

$$\eta : I \rightarrow A \otimes B \qquad \epsilon : B \otimes A \rightarrow I$$

such that:

$$(1 \otimes \eta)(\epsilon \otimes 1) = 1_B \qquad (\eta \otimes 1)(1 \otimes \epsilon) = 1_A$$

The maps η and ϵ are represented in graphical calculus by a cap and a cup respectively:

$$\eta : I \rightarrow A \otimes B = \cap \qquad \epsilon : B \otimes A \rightarrow I = \cup$$

The equations satisfied by a right dual are also referred to as the snake equations owing to their shape in the graphical calculus:

$$\begin{array}{c} B \\ | \\ \cap \\ | \\ A \\ | \\ \cup \\ | \\ B \\ | \\ I \end{array} = \begin{array}{c} | \\ B \\ | \end{array} \qquad \begin{array}{c} | \\ A \\ | \\ \cup \\ | \\ B \\ | \\ \cap \\ | \\ A \\ | \\ I \end{array} = \begin{array}{c} | \\ A \\ | \end{array}$$

Similarly, an object B is **left dual** to an object A if there exists maps $\eta : I \rightarrow B \otimes A$, and $\epsilon : A \otimes B \rightarrow I$ such that the corresponding snake equations hold.

Definition 6.4. *A **compact closed category** (KCC) is a monoidal category in which each object A is equipped with chosen right and left duals.*

For a KCC which is also a SMC, a right dual of an object is also its left dual, and vice versa. Such a dual of an object A is written as A^* .

Definition 6.5. [4] *A **†-compact closed** category (†-KCC) is a †-symmetric monoidal category which is also a compact closed category such that for each object $\eta^\dagger = c_\otimes \epsilon$ (equivalently $\epsilon^\dagger = \eta c_\otimes$).*

Dagger compact closed categories were introduced by Coecke and Abramsky [4] as an axiomatic framework for quantum information theory under the title strongly compact closed categories. The operator-state correspondence is straightforward in a †-compact closed category. Every map $f : A \rightarrow B$ precisely corresponds to a state $[f] : I \rightarrow B \otimes A^*$ and an

6.2.2 Categories of Hilbert spaces and bounded linear maps, Hilb

The category of Hilbert Spaces and bounded linear maps, \mathbf{Hilb} , is a \dagger -SMC. The subcategory \mathbf{FHilb} of \mathbf{Hilb} consisting of only finite-dimensional Hilbert spaces is a \dagger -KCC. \mathbf{FHilb} is used in CQM as a standard setting for studying processes in quantum information theory and quantum computing.

The category \mathbf{Hilb} is defined as follows:

Objects: Hilbert spaces

Maps: Bounded linear maps

Composition: Usual composition of linear maps

Tensor product: Standard tensor product of the underlying vector spaces. The tensor product on the maps is given by the Kronecker product. The tensor unit is \mathbb{C} .

Dagger: Given any map $f : A \rightarrow B$, its adjoint $f^\dagger : B \rightarrow A$ is defined as the map satisfying the following equation for all $a : I \rightarrow A$, and $b : I \rightarrow B$.

$$\langle bf^\dagger, a \rangle = \langle b, af \rangle$$

\mathbf{Hilb} is a \dagger -symmetric monoidal category. In finite-dimensions, Hilbert Spaces are equipped with a **compact structure**. Given any finite-dimensional Hilbert Space, H^* refers to the dual space of all functionals $H \rightarrow H$. Recall that every finite-dimensional Hilbert space has an orthonormal basis. Suppose $\{e_i\}_{i=1}^{\dim H}$ is an orthonormal basis for H , then:

$$\eta : 1 \rightarrow H^* \otimes H; 1 \mapsto \sum_i e_i^* \otimes e_i \text{ and } \epsilon : H \otimes H^* \rightarrow I; e_i \otimes e_j^* \mapsto \delta_{ij}$$

Note that one cannot define a counit ϵ as above for a Hilbert space since it could possibly result in an infinite sum for an infinite vector.

The η and ϵ satisfy snake equations as follows. Suppose $a \in H$ and $a = \sum_i a_i e_i$.

$$\begin{aligned} (1 \otimes \eta)(\epsilon \otimes 1)\left(\sum_i a_i e_i\right) &= (\epsilon \otimes 1)\left(\sum_i a_i e_i \otimes \sum_j e_j^* \otimes e_j\right) \\ &= \sum_i \sum_j a_i ((\epsilon \otimes 1)e_i \otimes e_j^* \otimes e_j) \text{ (By linearity)} \\ &= \sum_{ij} a_i (\delta_{ij} \otimes e_j) = \sum_j a_j e_j = a \end{aligned}$$

The subcategory finite-dimensional Hilbert Spaces, \mathbf{FHilb} , is \dagger -compact closed.

6.2.3 Categories of finite matrices over a commutative rig R , $\mathbf{Mat}(R)$

Consider the category $\mathbf{Mat}(R)$ defined as follows:

Objects : $n \in \mathbb{N}$;

Arrows: $n \xrightarrow{M} m$, where M is a $n \times m$ matrix over a commutative rig² R ;

Composition: matrix multiplication;

Tensor product: $n \otimes m := n \cdot m$; $M \otimes N$ is the outer product of matrices.

$\mathbf{Mat}(R)$ is a strict symmetric monoidal category. Every object in $\mathbf{Mat}(R)$ is self-dual: $(\eta_n, \epsilon_n) : n \dashv n$, where the η_n and ϵ_n are defined as follows:

$$\eta_n : 1 \rightarrow n \otimes n := \sum_{i=1}^n (e_i \otimes e_i) \quad \epsilon_n : n \otimes n \rightarrow 1 := \sum_{i=1}^n (e_i^T \otimes e_i^T)$$

Here e_i is a standard basis vector for $\mathbf{Mat}(R)$, and e_i^T is the transpose of e_i . For example, for $n = 2$, $e_1 := [1 \ 0]$, $e_2 := [0 \ 1]$ and, thus, $\eta_2 := [1 \ 0 \ 0 \ 1]$. If $M : n \rightarrow m$ then $M^* : m \rightarrow n$, the dual of M , M^* , is just the transpose, M^T .

When the commutative rig, R , has a conjugation, $\overline{(-)} : R \rightarrow R$ such that $\overline{\bar{r} + \bar{s}} = \overline{\bar{r}} + \overline{\bar{s}}$, $\overline{\bar{0}} = 0$, $\overline{\bar{r} \bar{s}} = \overline{\bar{r}} \overline{\bar{s}}$ and $\overline{\bar{1}} = 1$, then $\mathbf{Mat}(R)$ has a dagger given by conjugate transpose. In particular, this means $\mathbf{Mat}(\mathbb{C})$, finite-dimensional matrices over the complex numbers, in addition, has a dagger given by conjugate transpose. In fact, the category $\mathbf{Mat}(\mathbb{C})$ is equivalent to \mathbf{FHilb} [76, Example 1.34].

Note that the two element ordered set, $\mathbb{2}$, with join as addition and meet as multiplication is a rig and $\mathbf{Mat}(\mathbb{2})$ is then equivalent to the category of finite sets and relations. This equivalence can be turned into an isomorphism if one inflates $\mathbf{Mat}(R)$ so that it has objects finite sets, $I, J \in \mathbf{Set}_f$, and maps matrices given by maps $M : I \times J \rightarrow R$.

6.3 Complete positivity

In this section we discuss quantum channels in \dagger -SMCs and \dagger -KCCs. In quantum mechanics, the representation of a physical state can be either *pure* or *mixed*. A representation is mixed when it is a statistical ensemble of possible states of the system. If the representation is pure, then one knows the exact quantum state of the system.

While a pure state is represented as a vector in a Hilbert Space, a mixed state is represented as a positive self-adjoint operator on the Hilbert Space. The mixed state formalism of

²Ring without negatives, hence a semiring

quantum mechanics is very useful in practice since in an experimental setting our knowledge about the state of a quantum system is often limited. In the mixed state formalism, a quantum process is a completely positive map (sending positive self-adjoint operators to positive self-adjoint operators) which preserves trace. In this section, we discuss how completely positive maps and traces are abstracted in a categorical setting.

6.3.1 The CPM construction

We begin our discussion with linear operators on finite-dimensional Hilbert Spaces. A **linear operator** is a linear map from a Hilbert space to itself. The space of all linear operators, $\mathcal{L}(H)$, on a finite-dimensional Hilbert Space H is a \mathbb{C}^* -algebra with the \star on $\mathcal{L}(H)$ defined to be the adjoint operation. Considering the linear map in matrix form, the adjoint of the matrix is its conjugate transpose. An element a of a \mathbb{C}^* algebra is **positive** if there exists an element b in the algebra such that $a = b^\star b$. Note that a positive element is self-adjoint, that is $a^\star = a$. The mixed state of quantum system is given a by positive element of $\mathcal{L}(H)$ of norm 1.

A linear map between two \mathbb{C}^* algebras is **positive** if it preserves the positive elements, that is, $f(x^\star x) = y^\star y$. A linear map is said to be **completely positive** if it is positive and for all $n > 0$, the map $1_n \otimes f : \mathbb{C}^{n \times n} \otimes A \rightarrow \mathbb{C}^{n \times n} \otimes B$ is positive. If the representation of a quantum state is mixed, then completely positive maps that preserve trace are used to represent quantum processes.

The following theorem by Choi characterizes the form of completely positive maps:

Theorem 6.6. [33, Theorem 1] *Let H and K be finite-dimensional Hilbert spaces. A linear map $\phi : \mathcal{L}(H) \rightarrow \mathcal{L}(K)$ is completely positive if and only if there exists a collection of linear maps, $\{M_i | M_i \in \mathcal{L}(H, K)\}$ such that for all $A \in \mathcal{L}(H)$,*

$$\phi(A) = \sum_i M_i^\dagger A M_i$$

where M_i^\dagger is a adjoint of M_i .

The equation in the above theorem is referred to as the **Kraus decomposition** of ϕ , and the collection of maps, $\{M_i | M_i \in \mathcal{L}(H, K)\}$, are referred to as the **Kraus operators**.

Selinger [110] abstracted the notion of completely positive maps to \dagger -compact closed categories using the characterization discussed above. In a \dagger -compact closed category, a map $f : A \rightarrow A$ is **positive** if there exists a $g : A \rightarrow B$ such that $f = gg^\dagger$. A map $f : A^\star \otimes A$

ancillary system.

Any two Kraus maps, $f : A \rightarrow E \otimes B$, and $g : A \rightarrow F \otimes B$ are said to be **equivalent**, that is $f \sim g$, if for all $h : B \otimes C \rightarrow D$, they satisfy the following equation:

$$\begin{array}{c}
 \begin{array}{c}
 \begin{array}{c}
 A \\
 | \\
 \textcircled{f} \\
 | \\
 E \\
 | \\
 \textcircled{f'} \\
 | \\
 A
 \end{array}
 \end{array}
 \otimes
 \begin{array}{c}
 \begin{array}{c}
 B \\
 | \\
 \textcircled{h} \\
 | \\
 D \\
 | \\
 \textcircled{h'} \\
 | \\
 B
 \end{array}
 \end{array}
 \end{array}
 =
 \begin{array}{c}
 \begin{array}{c}
 \begin{array}{c}
 A \\
 | \\
 \textcircled{g} \\
 | \\
 F \\
 | \\
 \textcircled{g'} \\
 | \\
 A
 \end{array}
 \end{array}
 \otimes
 \begin{array}{c}
 \begin{array}{c}
 B \\
 | \\
 \textcircled{h} \\
 | \\
 D \\
 | \\
 \textcircled{h'} \\
 | \\
 B
 \end{array}
 \end{array}
 \end{array}
 \quad (6.3)$$

For any Kraus map, $f : A \rightarrow E \otimes B$, we will write its equivalence class as $[f]$.

Definition 6.7. [46, Definition 3] *The CP^∞ construction is defined as follows. Let \mathbb{C} be any \dagger -monoidal category.*

Objects: Same as objects as \mathbb{C}

Maps: Equivalence classes of Kraus maps in \mathbb{C}

Identity maps: Equivalence class of Kraus maps given by the left unitor, $[(u_\otimes^l)^{-1} : A \rightarrow I \otimes A]$.

Composition: The composition of two maps $f : A \rightarrow B$, and $g : B \rightarrow C \in \text{CP}^\infty(\mathbb{C})$ is given by composing their respective Kraus maps upto equivalence:

$$fg := \left[\begin{array}{c}
 \begin{array}{c}
 A \\
 | \\
 \textcircled{f} \\
 | \\
 E \\
 | \\
 \textcircled{g} \\
 | \\
 E' \\
 | \\
 C
 \end{array}
 \end{array} \right]$$

The composition is well-defined because if $f \sim f'$ and $g \sim g'$, then $fg \sim f'g'$.

If \mathbb{C} is a \dagger -SMC, then $\text{CP}^\infty(\mathbb{C})$ is a SMC [46, Proposition 5]. Note that, in this case, $\text{CP}^\infty(\mathbb{C})$ does not have a \dagger -functor. Moreover, if \mathbb{C} is a \dagger -KCC, then $\text{CP}^\infty(\mathbb{C})$ isomorphic to $\text{CPM}(\mathbb{C})$ [46, Proposition 6].

The set of all bounded linear maps from a Hilbert space to itself is a Von Neumann algebra. The category of Von Neumann algebras and normal completely positive maps is isomorphic to $\text{CP}^\infty(\text{Hilb})$ [46, Theorem 13].

6.3.3 Environment structures

In the previous sections, we discussed the constructions for transforming a category of pure states and processes into a category of mixed states and completely positive maps. In this

section we discuss characterizations of these constructions using the notion of *environment* [46, 50, 41]. While pure states contain information *purely* about the system, mixed states contain information about the system and its environment together. One can thus characterize the categories of mixed states by the presence of environment structure and discarding maps.

Definition 6.8. An **environment structure** for a \dagger -SMC, \mathbb{C}_{pure} , consists of a strict monoidal functor $F : \mathbb{C}_{pure} \rightarrow \mathbb{C}$ where \mathbb{C} is a SMC with designated map, $\gamma_A : A \rightarrow I$, called the **discarding map** for all objects $A \in \mathbb{C}$ such that the following equations hold:

Env 1: For all objects $A, B \in \mathbb{C}_{pure}$, $\gamma_{F(A \otimes B)} = \gamma_{F(A)} \otimes \gamma_{F(B)}(u_{\otimes})_I$

Env 2: $\gamma_I = id_I$ ($F(I) = I$)

Env 3: For all Kraus maps $f : A \rightarrow X \otimes B, g : A \rightarrow Y \otimes B \in \mathbb{C}_{pure}$,

$$f \sim g \text{ if and only if } F(f)(\gamma_{F(X)} \otimes 1_B) = F(g)(\gamma_{F(Y)} \otimes 1_B).$$

The axioms for an environment structure are drawn as follows:

$$[\mathbf{Env\ 1}]: \quad \underline{\underline{\underline{F(A \otimes B)}}}} = \underline{\underline{\underline{F(A)}}}} \underline{\underline{\underline{F(B)}}}} \quad [\mathbf{Env\ 2}]: \quad \underline{\underline{\underline{I}}} = id_I$$

$$[\mathbf{Env\ 3}]: \quad f \sim g \quad \Leftrightarrow \quad \begin{array}{c} \text{---} F(A) \\ | \\ \text{---} (F(f)) \\ | \\ \text{---} F(X) \quad \text{---} F(B) \end{array} = \begin{array}{c} \text{---} F(A) \\ | \\ \text{---} (F(g)) \\ | \\ \text{---} F(Y) \quad \text{---} F(B) \end{array}$$

A process $f : A \rightarrow B$ in a \dagger -SMC, \mathbb{C}_{pure} , with an environment structure ($F : \mathbb{C}_{pure} \rightarrow \mathbb{C}, \underline{\underline{\underline{\cdot}}}}$) is said to be **normalised** if $F(f)\gamma_{F(B)} = \gamma_{F(A)}$. The normalised processes of \mathbb{C}_{pure} form a sub- \dagger -SMC of \mathbb{C} with the same environment structure. In that case, for the sub- \dagger -SMC, the discarding map γ is a monoidal transformation for from the functor F to the constant endofunctor that sends all objects to I and all maps to id_I .

Definition 6.9. A \dagger -SMC, \mathbb{C}_{pure} , with an environment structure ($F : \mathbb{C}_{pure} \rightarrow \mathbb{C}, \underline{\underline{\underline{\cdot}}}}$) is said to allow **purification** if every map in \mathbb{C} is of the following form for some Kraus map $f : A \rightarrow X \otimes B \in \mathbb{C}_{pure}$

$$[\mathbf{Env\ 4}] \quad \begin{array}{c} \text{---} F(A) \\ | \\ \text{---} (F(f)) \\ | \\ \text{---} F(X) \quad \text{---} F(B) \end{array}$$

The idea of **[Env 3]** is that every process in \mathbb{C} is equal to a pure process followed by discarding information.

and trace preserving) when $g \in \text{FHilb}$ is normalized i.e, $F(g)\gamma_{F(E \otimes B)} = \gamma_{F(A)}$.

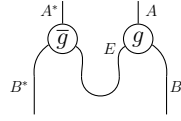

The environment structure in the above example also allows for purification because every map in $\text{CPM}(\mathbb{C}_{\text{pure}})$ is of the following form for some $g : A \rightarrow E \otimes B \in \mathbb{C}_{\text{pure}}$:

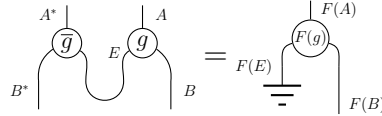

6.4 Measurement and complementarity

We covered quantum channels in the previous section. In this section we review the notions of quantum observables, measurement and complementarity categorically.

6.4.1 Quantum observables

A quantum observable is a physical property which can be measured. Frobenius algebras are one of the pillars of CQM because they are used to abstract the notion of quantum observables. In traditional quantum mechanics, an observable is represented by a self-adjoint operator a.k.a Hermitian operator on a Hilbert space. The set of all eigenvectors for an observable gives an orthogonal basis for the state space of the quantum system. After a measurement, the state of the quantum system will be one of these basis states. The eigenvalue corresponding to an eigenvector represents its probability amplitude i.e., the probability that the quantum system will end up in the particular basis state after measurement. Frobenius algebras provide a neat abstraction of these ideas in \dagger -monoidal categories. In this section, we review Frobenius algebras and their correspondence to quantum observables.

In a SMC, a monoid (A, \multimap, \uparrow) consists of an object A with a multiplication map, $\multimap : A \otimes A \rightarrow A$, and a unit map, $\uparrow : I \rightarrow A$, such that the multiplication is associative (see diagram (a)) and the unit law holds (see diagram (b)).



Similarly, a comonoid $(A, \complement, \downarrow)$ consists of an object A with a comultiplication $\complement : A \rightarrow A \otimes A$, and a counit map $e : A \rightarrow I$ such that the comultiplication is coassociative

(vertical reflection of equation for associativity), and that the counit law holds (vertical reflection of equation for unit law).

Definition 6.12. In a SMC, a **Frobenius algebra**, $(A, \multimap, \imath, \lrcorner, \jmath)$, consists of a monoid (A, \multimap, \imath) and a comonoid (A, \lrcorner, \jmath) such that the multiplication and the comultiplication interacts as follows:

The above equation is referred to as the Frobenius law. It can be proven that the Frobenius law holds for a monoid and a comonoid on A if and only if the following equation holds:

The diagram on the right of the equation is fondly referred to as a ‘spider’ in the CQM community.

In an SMC, if an object A is Frobenius algebra, then A is a self-dual object with the following cup and cap:

$$\eta : I \rightarrow A \otimes A := \text{cap} \quad \epsilon : A \otimes A \rightarrow I := \text{cup}$$

For a Frobenius algebra, $(A, \multimap, \imath, \lrcorner, \jmath)$, the monoid (A, \multimap, \imath) , and the comonoid (A, \lrcorner, \jmath) are dual to one another by the means of the self-dual cup and cap:

Conversely, if A is a self-dual object $A \dashv A$ and a monoid (A, \multimap, \imath) , and there exists a map $\jmath : A \rightarrow I$ such that the self-dual cup is given by \lrcorner , then A has a Frobenius structure, see [76, Proposition 5.16]. The map $\jmath : A \rightarrow I$ is referred to the non-degenerate form of the Frobenius structure.

Definition 6.13. In a \dagger -SMC, a \dagger -**Frobenius algebra** is a Frobenius algebra $(A, \multimap, \imath, \lrcorner, \jmath)$ such that

$$\left(\text{cup}_A \right)^\dagger = \text{cap}_A$$

In \dagger -KCCs, *pants algebra* provide an important class of examples for \dagger -FAs. To define pants algebra, note that in a KCC, for each object A , there exists a monoid on $A \otimes A^*$ with the following multiplication and unit respectively:

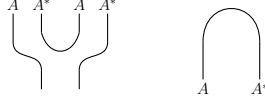

The above algebra is referred to as a **pants algebra** due to the shape of its multiplication map.

Every monoid in a *KCC* embeds into the pants monoid:

Lemma 6.14. *In a KCC, every monoid, $(A, \curlywedge, \curlyvee)$, embeds into its pants monoid on $A^* \otimes A$ by means of the following monoid morphism:*

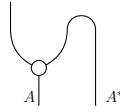

Lemma 6.15. *In a \dagger -KCC, pants algebra are \dagger -Frobenius.*

Applying the operator-state duality to pants \dagger -algebra we note the following. Let $f, g : A \rightarrow A$ be any two processes in a \dagger -KCC. Multiplying the states corresponding to these processes using the pants monoid gives the state corresponding to composition fg , see equation (a). Moreover, applying the counit to the state of f gives the trace of f , see diagram (b).

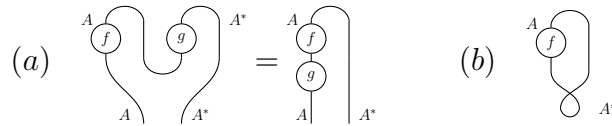

Let us review a concrete example of pants algebra. Consider the space of $n \times n$ complex matrices written as M_n which gives the pants algebra over the space \mathbb{C}^n in FHilb [76, Example 4.12]. We will show that M_n is the pants algebra for \mathbb{C}^n . The space of $n \times n$ complex matrices is a Hilbert space with the inner product given by $\langle A|B \rangle := Tr(A^\dagger B)$ (A^\dagger is conjugate transpose of A) and comes with a canonical basis $\{e_{ij}|i, j = 1, \dots, n\}$. The basis e_{ij} is a $n \times n$ matrix with zero for all entries except the entry (i, j) .

The algebra of $n \times n$ complex matrices has a \dagger Frobenius structure in FHilb:

Monoid structure: The multiplication, m , is given by matrix multiplication and the unit, u , is the $n \times n$ identity matrix.

Comonoid structure: Define the counit map $e := u^\dagger$. Then, by definition of \dagger for in Hilbert spaces, $\langle e(e_{ij})|1 \rangle = \langle (e_{ij})|e^\dagger(1) \rangle = \langle e_{ij}|u(1) \rangle = \langle e_{ij}|I_A \rangle = \delta_{ij} = Tr(e_{ij})$. By extension of linearity, for all $A \in M_n$, $e(A) = Tr(A)$.

Similarly, define the comultiplication to be, $d := m^\dagger$. By the definition of \dagger for \mathbf{FHilb} , $\langle m(e_{ij} \otimes e_{kl}) | e_{pq} \rangle = \langle e_{ij} \otimes e_{kl} | m^\dagger(e_{pq}) \rangle$. As before, in order to derive the definition of m^\dagger we expand the equation on both sides.

$$\begin{aligned} \langle m^\dagger(e_{ij}) | e_{kl} \otimes e_{pq} \rangle &= \langle e_{ij} | m(e_{kl} \otimes e_{pq}) \rangle \\ &= \langle e_{ij} | \delta_{lp} e_{kq} \rangle \\ &= \delta_{lp} \text{Tr}(e_{ij}^* e_{kq}) \\ &= \delta_{lp} \text{Tr}(e_{ij}^* e_{kq}) \\ &= \delta_{lp} \delta_{ik} \delta_{jq}. \end{aligned}$$

By defining $m^\dagger(e_{ij}) := \sum_l e_{il} \otimes e_{lj}$, $\langle m^\dagger(e_{ij}) | e_{kl} \otimes e_{pq} \rangle$ evaluates to $\delta_{lp} \delta_{ik} \delta_{jq}$.

A \dagger -Frobenius algebra in a symmetric \dagger -SMC is said to be **special** if (a) holds, **commutative** if (b) holds, and **symmetric** if (c) holds:

$$(a) \quad \begin{array}{c} \circ \\ | \\ \circ \\ | \\ \circ \end{array} = \begin{array}{c} | \\ | \\ | \end{array} \quad (b) \quad \begin{array}{c} \cup \\ \cup \\ \circ \\ | \end{array} = \begin{array}{c} \cup \\ \cup \\ | \\ \circ \end{array} \quad (c) \quad \begin{array}{c} \cup \\ \cup \\ \circ \\ | \end{array} = \begin{array}{c} \cup \\ \cup \\ | \\ \circ \end{array}$$

Commutativity is a stronger condition than the symmetry. For example, the pants algebra is non-commutative but symmetric.

The connection between Frobenius algebras and quantum observables given by the fact that in the \mathbf{FHilb} category, every special commutative \dagger -FA (\dagger -SCFA) precisely corresponds to an orthonormal basis. This correspondence arises from the notion of **classical states** for a \dagger -FA: the states, $a : I \rightarrow A$, which can be copied, and deleted as shown below.

$$\text{copy: } \begin{array}{c} \triangle \\ | \\ \cup \\ | \end{array} = \begin{array}{c} \triangle \\ | \\ | \end{array} \begin{array}{c} \triangle \\ | \\ | \end{array} \quad \text{delete: } \begin{array}{c} \triangle \\ | \\ \circ \end{array} = id_I$$

Theorem 6.16. [49, Theorem 5.1] *In \mathbf{FHilb} , the set of classical states for a \dagger -SCFA on an Hilbert space H precisely corresponds to an orthonormal basis for H .*

Hence, there exists a bijective correspondence between \dagger -SCFAs and orthonormal bases. The basis states are the only states of the quantum system that can be copied and deleted, in other words, a classical state. Hence, \dagger -SCFA are also referred to as *classical structures*. In the previous theorem if we drop the keyword special, then corresponding basis is orthogonal.

A quantum measurement is the process of extracting classical data (can be copied and deleted) from a quantum state. Categorically, Coecke and Pavlovic [48] described a “demolition” measurement in a \dagger -monoidal category as a process, $m : A \rightarrow X$, with $m^\dagger m = 1_X$,

to a special commutative \dagger -Frobenius algebra, X . The object A refers to the state space of a quantum system. Demolition means that we ignore the resulting state of the quantum system after measurement and preserve only the classical data.

In Theorem 6.16, we saw that \dagger -SCFA model classical data. However, Frobenius algebras which are non-commutative but symmetric model quantum information:

Theorem 6.17. [118] *In FHilb, every special symmetric \dagger -FA precisely corresponds to a \mathbb{C}^* -algebra.*

The proof of the above theorem relies on Lemma 6.14. Due to their correspondence to \mathbb{C}^* -algebras, special symmetric \dagger -FAs are also referred to as *quantum algebras*. Note that quantum algebras are non-commutative.

6.4.2 Strong complementarity

Bohr's complementarity [71] is a key feature that distinguishes quantum mechanics from classical mechanics. Two quantum observables are said to be complementary if measuring one observable leads to maximum uncertainty regarding the value of the other. An example of complementary observables is position and momentum of an electron. All physical properties occur in complementary pairs due to the wave and the particle nature of matter.

In CQM, complementary interaction of two observables are axiomatized using Hopf algebras [1], which are bialgebras with an antipode:

Definition 6.18. [105] *In a SMC, a bialgebra $(A, \varphi, \rho, \mu, \nu)$ consists of a monoid (A, φ, ρ) and a comonoid (A, μ, ν) satisfying the following equations:*

(a) (b) (c) (d)

The final equation is often referred to as the *bialgebra rule*. Observing equations (a)-(d), we note that the multiplication map acts as a comonoid morphism for the tensor comonoid $A \otimes A$. Equivalently, the comultiplication acts as a monoid morphism for the tensor monoid $A \otimes A$. The following lemma gives alternate descriptions for a bialgebra:

Lemma 6.19. *In an SMC, the following are equivalent:*

- (i) $(A, \varphi, \rho, \mu, \nu)$ is a bialgebra.
- (ii) (A, φ, ρ) is a monoid and (A, μ, ν) is a comonoid such that μ is a monoid morphism for the tensor monoid $(A \otimes A, \varphi \cup \varphi, \rho \cup \rho)$.

(iii) (A, \wp, \wp) is a monoid and $(A, \blacktriangleright, \blacktriangleleft)$ is a comonoid such that \wp is a comonoid morphism for the tensor comonoid $(A \otimes A, \blacktriangleright \blacktriangleright, \blacktriangleleft \blacktriangleleft)$.

The following are a few examples of bialgebras:

- In a category with biproducts, every object has a bialgebra structure given by the product and the coproduct maps:

$$A + A \xrightarrow{\begin{bmatrix} id_A \\ id_A \end{bmatrix}} A \quad 0 \xrightarrow{0_{0,A}} A \quad A \xrightarrow{\langle id_A, id_A \rangle} A + A \quad A \xrightarrow{0_{A,0}} 0$$

The category of vector spaces and linear maps has biproducts: ‘+’ is given by direct sum and 0 is the trivial vector space.

- Consider the category of sets and functions, **Set**. The category **Set** does not have biproducts, however, it is an SMC with the tensor product given by the cartesian product and the unit object being a chosen singleton set. In **Set**, every monoid (A, \circ, u) (that is, A is a set with a binary operation \circ and a unit u), is a bialgebra with the comonoid structure given as follows:

$$\text{for all } a \in A, \blacktriangleright : A \rightarrow A \times A; a \mapsto (a, a) \quad \blacktriangleleft : A \rightarrow \{*\}; a \mapsto *$$

We are now ready to define Hopf algebras:

Definition 6.20. [21, 28] In a SMC, a **Hopf algebra** is a bialgebra $(A, \wp, \wp, \blacktriangleright, \blacktriangleleft)$ with a map $s : A \rightarrow A$ referred to as an **antipode** such that:

The above equation is referred to as the *Hopf law*. The following are a few examples of Hopf algebras:

- In the examples of bialgebras, we saw that every monoid (A, \circ, e) in the category **Set** is a bialgebra. If this monoid is also a group, that is, each element of A is equipped with an inverse, then the bialgebra is Hopf with antipode $s : A \rightarrow A$ defined to be, for all $a \in A$, $s(a) := a^{-1}$.
- Another example of a Hopf algebra is a group K -algebra [97]. Given a finite group (G, \circ, u) , (that is, G is a set with a binary operation \circ , a unit u and an inverse for each

element) and a field K , it is the free K -vector space, $K[G]$, over G with basis $\{e_g\}_{g \in G}$. $K[G]$ is a Hopf algebra with the following K -linear maps: for all $g, h \in G$,

$$m : K[G] \otimes K[G] \rightarrow K[G]; e_g \otimes e_h \mapsto e_{goh} \quad u : K \rightarrow K[G]; 1 \mapsto e_u$$

$$d : K[G] \rightarrow K[G] \otimes K[G]; e_g \mapsto e_g \otimes e_g \quad e : K[G] \rightarrow K; e_g \mapsto 1$$

Finally, the antipode is:

$$s : K[G] \rightarrow K[G]; e_g \mapsto e_{g^{-1}}$$

The bialgebras and the Frobenius algebras capture interactions between a monoid and comonoid on a single underlying object. However, the axioms for a bialgebra are characterized by disconnected diagrams while the axioms for a Frobenius algebra are characterized by connected diagrams. The Hopf law depicts the maximum disconnect and can be interpreted as a process in which there is no information flow from the multiplication to the comultiplication. This makes Hopf algebras an appealing algebraic structure to model complementarity of two quantum observables [44].

It is worthwhile to note that an object, A , which is both a Frobenius algebra and a bialgebra is trivial i.e., $A \simeq I$:

Lemma 6.21. [76, Theorem 6.23] *In a \dagger -SMC, suppose a monoid $(A, \curlywedge, \curlyvee)$ and a comonoid $(A, \curlylrcorner, \curlyrccorner)$ is both a bialgebra and Frobenius algebra, then:*

Proof.

□

Step (1) of the proof uses the unit law for monoids, step (2) uses equation (b) of bialgebras, and step (3) uses the Frobenius law. Thus, for a Frobenius algebra which is also a bialgebra, the unit map is inverse of the counit map.

In the previous section, we saw that quantum observables are precisely \dagger -SCFAs in \mathbf{FHilb} . We now present the conditions for any two \dagger -SCFA to be complementary:

Definition 6.22. [76] *In a \dagger -SMC, any two \dagger -SCFAs, say $(A, \curlywedge, \curlyvee, \curlylrcorner, \curlyrccorner)$ and $(A, \curlywedge, \curlyvee, \curlylrcorner, \curlyrccorner)$ are **complementary** if $(A, \curlywedge, \curlyvee, \curlylrcorner, \curlyrccorner)$ (equivalently $(A, \curlywedge, \curlyvee, \curlylrcorner, \curlyrccorner)$) is a Hopf algebra with*

antipode:

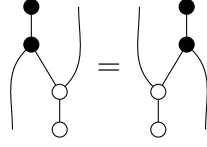

Note that in the CQM literature, the above definition is referred to as *strong complementarity*.

Let us look at an example of complementary observables in \mathbf{FHilb} . A simple yet significant example is given by the spin of an electron along the X , Y and Z axes. The spin of an electron is either *up* or *down* or a superposition these two states. This system is referred to as a qubit in quantum computation, and its state space is \mathbb{C}^2 .

Each of the X , Y , and Z observables are complementary to one another. These observables are given by *Pauli matrices* X , Y and Z defined as follows:

$$X = \begin{pmatrix} 0 & 1 \\ 1 & 0 \end{pmatrix} \quad Y = \begin{pmatrix} 0 & -i \\ i & 0 \end{pmatrix} \quad Z = \begin{pmatrix} 1 & 0 \\ 0 & -1 \end{pmatrix}$$

The eigenbasis of X , Y , and Z are $\{|0\rangle + |1\rangle, |0\rangle - |1\rangle\}$, Y is $\{|0\rangle + i|1\rangle, |0\rangle - i|1\rangle\}$, and Z is $\{|0\rangle, |1\rangle\}$ respectively, where:

$$|0\rangle = \begin{pmatrix} 1 \\ 0 \end{pmatrix} \quad |1\rangle = \begin{pmatrix} 0 \\ 1 \end{pmatrix}$$

These eigenvectors provide an orthonormal basis for \mathbb{C}^2 , hence they are \dagger -SCFAs in \mathbf{FHilb} , see [44, Example 2.11]. Note that, when used in calculations, the X and Y -eigenvectors are normalized so that for any of these vectors v , $\langle v|v\rangle = vv^\dagger = 1$. In CQM, normalization is handled by introducing scalars ($a : I \rightarrow I$) in the bialgebra equations [44, 10].

For a pair of complementary observables, the antipode is the identity map if and only if the self-dual cups and caps of the Frobenius algebras coincide. This is true in the case of Z and X observables. (and not for Z - Y and X - Y pairs). Coecke and Duncan developed a diagrammatic calculus for Z and X observables, called the ZX-calculus [44]. The bialgebraic interaction between the Z and the X observables is used in the calculus to construct logic gates in quantum computation. The ZX calculus is considered one of the most significant outcomes of the CQM program and is used extensively for quantum circuits optimization.

We end this section by providing an alternate and a useful characterization of complementary systems:

Theorem 6.23. [60, Theorem 6.4] *In a \dagger -SMC, two \dagger -SCFA $(A, \varphi, \rho, \rho^\smile, \downarrow)$, and $(A, \psi, \sigma, \sigma^\smile, \downarrow)$*

are complementary if and only if the following equations hold:

$$\begin{array}{c} \bullet \\ | \\ \bullet \\ \cup \\ \circ \end{array} = \begin{array}{c} \circ \\ | \end{array} \quad \begin{array}{c} \bullet \\ \cup \\ \circ \\ | \\ \bullet \end{array} = \begin{array}{c} | \\ \bullet \end{array}$$

In the previous section, for every Frobenius algebra, the multiplication is dual to the comultiplication, and the unit is dual to the counit via the self-dual cup and cap of the Frobenius algebra. The above theorem implies two \dagger -SCFAs are complementary if and only if the unit and the counit of each of these algebras are dual to one another using the self-dual cup and the cap of its complementary algebra.

Chapter 7

Completely positive maps

Categorical quantum mechanics (CQM) has mostly focused on quantum information theory and quantum computation which are finite dimensional branches of quantum mechanics. In order to widen the scope of CQM, there have been various proposals [46, 70, 6] to extend the structures in CQM to infinite dimensional systems. In Part I of this thesis, we generalized the framework of dagger compact closed categories to what we have called mixed unitary categories (MUCs). In this chapter we define completely positive maps for a MUC.

7.1 String calculus for MUCs

To facilitate reasoning within MUCs, it is useful to employ a circuit calculus built on the circuit calculus for LDCs introduced in [30]. The extended circuit calculus for mixed unitary categories includes dagger boxes, components for unitary structure maps, and inverse mixer morphisms.

7.1.1 Unitary structure map

A unitary object is an object equipped with an isomorphism $A \xrightarrow{\varphi_A} A^\dagger$, called the unitary structure map, which is drawn as a downward pointing triangle:

$$\begin{array}{c} A \\ \Downarrow \\ A^\dagger \end{array}$$

Diagrammatic representation of axioms [U.5]-(a), [U.4]-(a) in Definition 4.1 for unitary structure, and [Udual]-(a) in Definition 4.3 for unitary duals are as follows.

$$(\varphi_A \otimes \varphi_B)\lambda_{\otimes} = \mathbf{mx} \varphi_{A \oplus B} \quad \varphi_{\perp}(\lambda_{\top}^{-1}) = \mathbf{m} \quad \lambda_{\top} \epsilon_A^{\dagger} \lambda_{\oplus}^{-1} = \eta_A \varphi_{\oplus} \varphi_{C \oplus}$$

7.1.2 Inverse of the mixer

The mixer (obtained from the mix map $\perp \xrightarrow{\mathbf{m}} \top$ as below) $U_1 \otimes U_2 \xrightarrow{\mathbf{mx}} U_1 \oplus U_2$ is an isomorphism whenever U_1 and U_2 are unitary objects and its inverse are represented as follows:

$$\mathbf{mx}_{U_1, U_2} := \text{[Diagram]} = \text{[Diagram]} \quad \mathbf{mx}^{-1} := \text{[Diagram]}$$

Observe that \mathbf{mx}^{-1} maps associated to different unitary objects slide past each other, and indeed by naturality, \mathbf{mx}^{-1} slides over components in circuits:

$$\text{[Diagram 1]} = \text{[Diagram 2]} = \text{[Diagram 3]} = \text{[Diagram 4]} \quad \text{[Diagram 5]} = \text{[Diagram 6]}$$

7.2 Quantum channels for MUCs

7.2.1 Kraus maps

A Kraus map $(f, U) : A \rightarrow B$ in a mixed unitary category, $M : \mathbb{U} \rightarrow \mathbb{C}$, is a map $f : A \rightarrow M(U) \oplus B \in \mathbb{C}$ for some $U \in \mathbb{U}$. U is called the ancillary system of f . We glue the Kraus map to its dagger along its ancillary system giving rise to a combinator which acts on “test maps”. Two Kraus maps are equivalent when their effects on test maps are indistinguishable.

Definition 7.1. Given a MUC, $\mathbb{U} \xrightarrow{M} \mathbb{C}$, two Kraus maps $(f, U), (g, V) : A \rightarrow B$ are equivalent, $(f, U) \sim (g, V)$, if for all unitary objects X and all maps $h : B \otimes C \rightarrow V$ (called

test maps), the following equation holds:

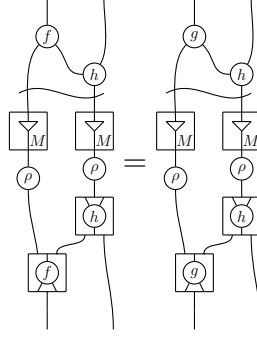

Note that the mx^{-1} map can be slid up and down along the wires of the unitary objects $M(U)$ and $M(V)$ by naturality of the mx map. The diagram includes covariant functor boxes for M and contravariant functor boxes for the dagger. The diagram on the left is given equationally as follows:

$$\begin{aligned}
 A \otimes C &\xrightarrow{f \otimes 1} (M(U) \oplus B) \otimes C \xrightarrow{\partial} M(U) \oplus (B \otimes C) \xrightarrow{1 \oplus h} M(U) \oplus M(V) \xrightarrow{\text{mx}^{-1}} M(U) \otimes M(V) \\
 &\xrightarrow{M(\varphi_U) \otimes M(\varphi_V)} M(U^\dagger) \otimes M(V^\dagger) \xrightarrow{\rho \otimes \rho} M(U)^\dagger \otimes M(V)^\dagger \xrightarrow{1 \otimes (h^\dagger \lambda_\oplus^{-1})} M(U)^\dagger \otimes (B^\dagger \oplus C^\dagger) \\
 &\xrightarrow{\delta} (M(U)^\dagger \otimes B^\dagger) \oplus C^\dagger \xrightarrow{\lambda_\otimes \oplus 1} (M(U) \oplus B)^\dagger \oplus C^\dagger \xrightarrow{f^\dagger \oplus 1} A^\dagger \oplus C^\dagger \xrightarrow{\lambda_\oplus} (A \otimes C)^\dagger
 \end{aligned}$$

The natural isomorphism $\rho : M(U^\dagger) \rightarrow M(U)^\dagger$ is the preservator of the \dagger -isomix functor, M , which ensures coherence with the \dagger from \mathbb{U} to \mathbb{C} . In the rest of this chapter, the covariant functor boxes represent the \dagger -isomix functor M of the MUC unless specified otherwise.

By forgetting the test maps and gluing Kraus map with its dagger, one gets a notationally convenient combinator which can be diagrammatically represented by:

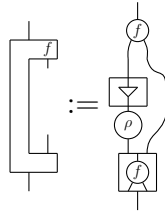

An equivalence class of Kraus morphisms is a **quantum channel**. If $(f, U) : A \rightarrow B$ and $(g, V) : A \rightarrow B$ are Kraus maps for which U and V are unitarily isomorphic, they are necessarily equivalent with respect to this relation:

Lemma 7.2. *Let $(f, U), (g, V) : A \rightarrow B$ be Kraus morphisms. If $U \xrightarrow{\alpha} V$ is a unitary isomorphism and $f(\alpha \oplus 1) = g$, then $(f, U) \sim (g, V)$.*

Proof. Let $h : B \otimes C \rightarrow M(X)$ be any test map. Then,

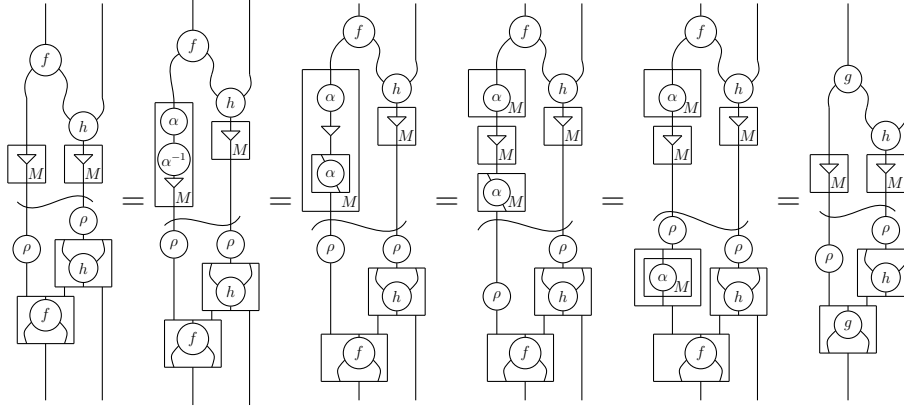

□

In a $*$ -MUC, the equivalence relation on Kraus maps is given equationally as follows:

Lemma 7.3. *Suppose $M : \mathcal{U} \rightarrow \mathbb{C}$, is a $*$ -MUC, that is every object in \mathbb{C} has linear adjoint, then two Kraus maps (f, U) and (g, V) are equivalent if and only if*

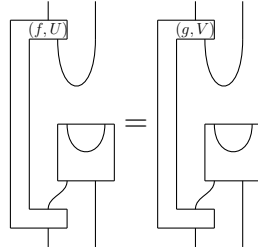

Proof. It is obvious that the given equation holds when the Kraus maps (f, U) and (g, V) are equivalent. For the converse, assume that the given equation holds. Then, the Kraus maps (f, U) and (g, V) are equivalent because, for any test map h , we have that:

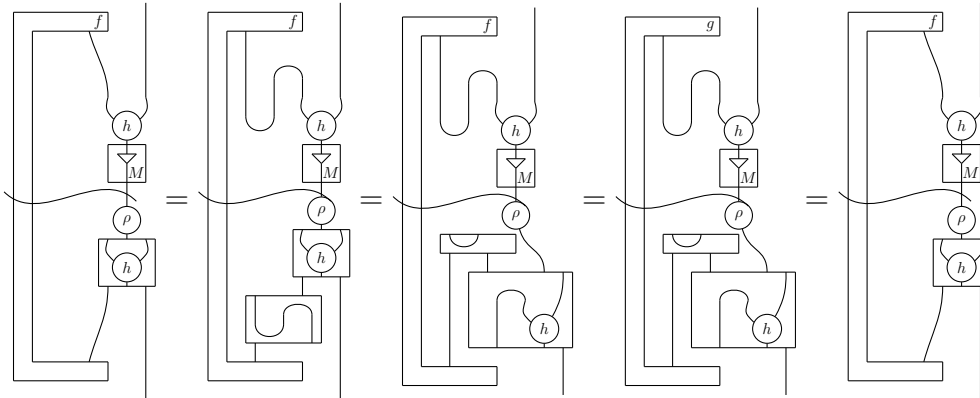

□

Let us now examine Kraus maps in our running examples:

- In the MUC, $\mathbb{R} \subset \mathbb{C}$, let c, c' be any two complex numbers. Kraus maps in $\mathbb{R} \subset \mathbb{C}$ are $(=, r) : c \rightarrow c'$ such that $c = rc'$. If $c' \neq 0$, then there is at most one Kraus map $(=, r) : c \rightarrow c'$. If $c' = 0$, then $c = 0$ and for all $r' \in \mathbb{R}$, $(=, r) \sim (=, r') : c \rightarrow c'$. Thus, in the complex plane, there are only Kraus maps between those complex numbers that can be connected by a line that extends through the origin making it the projective line $P^1(\mathbb{C})$, where \mathbb{C} refers to the complex field.

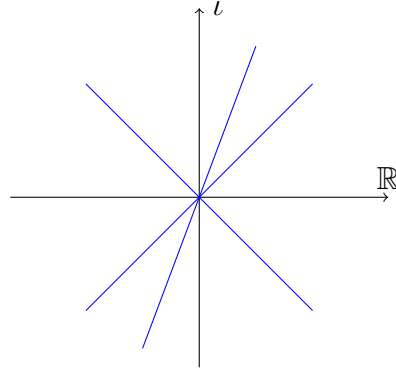

- In $\text{Mat}_{\mathbb{C}} \subset \text{FMat}_{\mathbb{C}}$, every Kraus map $(M, \mathbb{C}^n) : (X, \mathcal{A}, \mathcal{A}^+) \rightarrow (Y, \mathcal{B}, \mathcal{B}^+)$ is given by the sum of **pure completely positive maps** i.e., Kraus maps with \mathbb{C} as ancillary object:

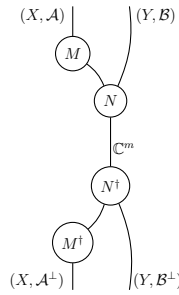

Choi's theorem states that every completely positive map can be written as a sum of pure completely positive maps. Analogously, every Kraus map in the category $\text{FMat}_{\mathbb{C}}$ can be written as a sum of pure maps as above. Given a Kraus map (M, \mathbb{C}^m) , here is the argument:

$$\begin{aligned}
 (M \otimes 1)(1 \otimes NN^\dagger)(M^\dagger \oplus 1) &= (M \otimes 1) \left(\left(\sum_i \Pi_i \Pi_i \right) \otimes NN^\dagger \right) (M^\dagger \oplus 1) \\
 &= \sum_i ((M(\Pi_i \otimes 1) \otimes 1)(1 \otimes hh^\dagger)((\Pi_i \oplus 1)M^\dagger) \oplus 1) = \sum_i (M_i \otimes 1)(1 \otimes NN^\dagger)(M_i^\dagger \oplus 1)
 \end{aligned}$$

7.2.2 $\mathbb{C}P^\infty$ -construction for MUCs

The CPM-construction [110] on \dagger -compact closed categories applied to the concrete category of finite-dimensional Hilbert Spaces and linear maps produces a category of mixed states and completely positive maps. Coecke and Heunen [46] generalized the CPM-construction to \dagger -symmetric monoidal categories, and thus, to infinite dimensions. They call the generalized construction the $\mathbb{C}P^\infty$ -construction. In this section, we generalize the $\mathbb{C}P^\infty$ construction to MUCs: our construction coincides with the original $\mathbb{C}P^\infty$ -construction when the MUC is a \dagger -monoidal category.

The $\mathbb{C}P^\infty$ -construction on MUCs is defined as follows:

Definition 7.4. *Given a MUC, $M : \mathbb{U} \rightarrow \mathbb{C}$, define $\mathbb{C}P^\infty(M : \mathbb{U} \rightarrow \mathbb{C})$ to have:*

Objects: *Same as \mathbb{C}*

Maps: $[(f, U)] : A \rightarrow B := \{f : A \rightarrow M(U) \oplus B \in \mathbb{C}\} / \sim$

Composition: *Composition of $[(f, U)] : A \rightarrow B$ and $[(g, V)] : B \rightarrow C$ is defined as follows:*

$$[(f, U)][(g, V)] := (A \xrightarrow{f} M(U) \oplus B \xrightarrow{1 \oplus g} M(U) \oplus (M(V) \oplus C) \xrightarrow{a_\oplus} (M(U \oplus V)) \oplus C \in \mathbb{C}) / \sim$$

Identity: 1_A is defined as $[A \xrightarrow{(u_\oplus^L)^{-1}} \perp \oplus A \xrightarrow{(n_\perp^M)^{-1} \oplus 1} M(\perp) \oplus A] \in \mathbb{X}$

In $\mathbb{C}P^\infty(M : \mathbb{U} \rightarrow \mathbb{C})$, composition of $f : A \rightarrow M(U) \oplus B$, and $g : B \rightarrow M(V) \oplus C$ is drawn as follows:

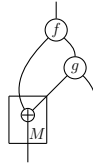

Observe that our $\mathbb{C}P^\infty$ -construction on $M : \mathbb{U} \rightarrow \mathbb{C}$ coincides with the original $\mathbb{C}P^\infty$ -construction [46] when $M : \mathbb{U} \rightarrow \mathbb{C}$ is dagger monoidal category $\mathbb{U} = \mathbb{C}$ and $M = id$.

Before we prove that $\mathbb{C}P^\infty(M : \mathbb{U} \rightarrow \mathbb{C})$ is a category, we observe the following result about unitary objects:

Lemma 7.5. *Suppose C and D are unitary objects. Then, the following diagrams commute:*

$$\begin{array}{ccc}
 M(C) \otimes M(D) & \xrightarrow{M(\varphi) \otimes M(\varphi)} & M(C^\dagger) \otimes M(D^\dagger) \\
 m_{\otimes}^M \downarrow & & \downarrow \rho \otimes \rho \\
 M(C \otimes D) & & M(C)^\dagger \otimes M(D)^\dagger \\
 M(\varphi) \downarrow & \text{(a)} & \downarrow \lambda_{\otimes} \\
 M((C \otimes D)^\dagger) & & (M(C) \oplus M(D))^\dagger \\
 \rho \downarrow & & \downarrow \mathbf{m}x^\dagger \\
 (M(C) \otimes M(D))^\dagger & \xrightarrow{(m_{\otimes}^M)^\dagger} & (M(C) \otimes M(D))^\dagger
 \end{array}$$

$$\begin{array}{ccc}
 M(C) \oplus M(D) & \xrightarrow{M(\varphi_C) \oplus M(\varphi_D)} & M(C^\dagger) \oplus M(D^\dagger) \\
 n_{\oplus}^{-1} \downarrow & & \downarrow \rho \oplus \rho \\
 M(C \oplus D) & & M(C)^\dagger \oplus M(D)^\dagger \\
 M(\varphi) \downarrow & \text{(b)} & \downarrow \lambda_{\oplus} \\
 M((C \oplus D)^\dagger) & & (M(C) \otimes M(D))^\dagger \\
 \rho \downarrow & & \downarrow (\mathbf{m}x^{-1})^\dagger \\
 (M(C \oplus D))^\dagger & \xleftarrow{n_{\oplus}^\dagger} & (M(C) \oplus M(D))^\dagger
 \end{array}$$

Proof.

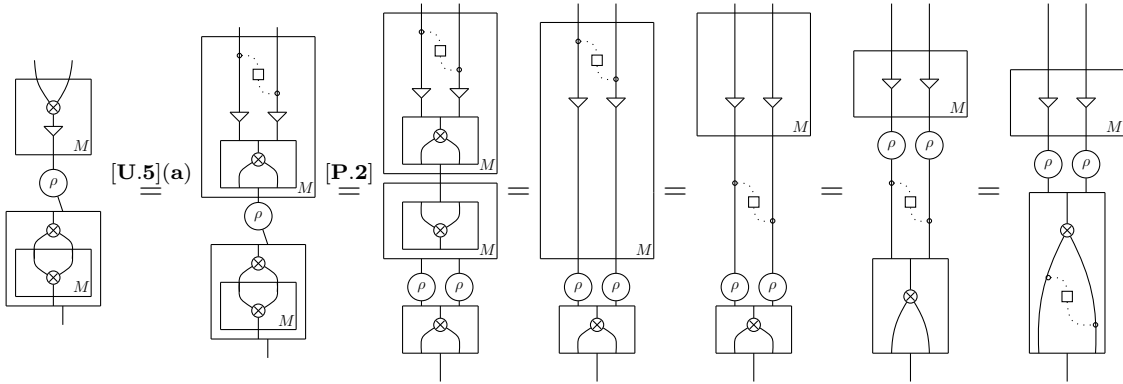

The commuting diagram (b) is proved similarly. □

Diagrammatic representation of Lemma 7.5 (b):

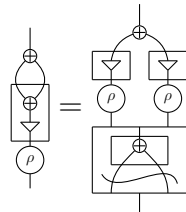

Proposition 7.6. $\text{CP}^\infty(M : \mathbb{U} \rightarrow \mathbb{C})$ is a category.

Proof.

- Composition is well-defined: That is to say, if $(f, U) \sim (f', U')$ then $(f, U)(g, V) \sim (f', U')(g, V)$. First we observe that: It suffices to show that:

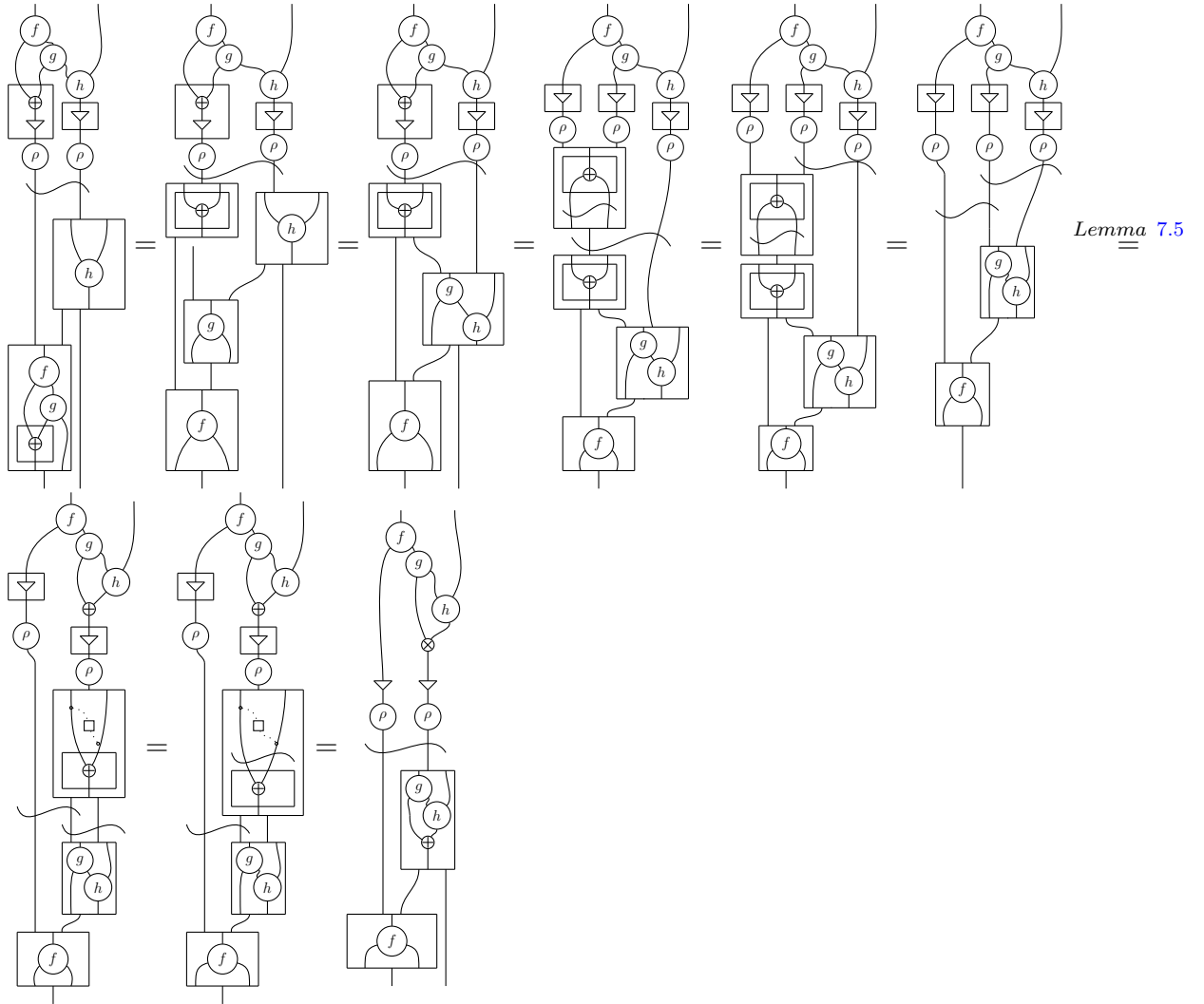

$(g, V) \sim (g', V') \Rightarrow (f, U)(g, V) \sim (f, U)(g', V')$ is proved similarly.

- Identity laws hold: $[(u_\oplus^L)^{-1}(n_\perp^M)^{-1}][f] = [f] = [f][(u_\oplus^L)^{-1}(n_\perp^M)^{-1}]$ It suffices to prove the following:

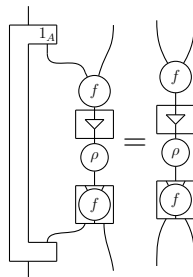

The proof uses the facts that ρ is a monoidal transformation (diagram on the left), and that for any unitary object U , the diagram on the right holds:

$$\begin{array}{ccc}
\top & \xrightarrow{\lambda_\top} & \perp^\dagger \\
m_\top^M \downarrow & & (n_\perp^M)^\dagger \downarrow \\
M(\top) & \xrightarrow{M(\lambda_\top)} M(\perp^\dagger) \xrightarrow{\rho} M(\perp)^\dagger & \xrightarrow{((n_\perp^M)^{-1})^\dagger} \perp^\dagger
\end{array}
\qquad
\begin{array}{ccc}
\top \otimes U & \xrightarrow{u_\otimes^L} & U \\
m^{-1} \otimes 1 \downarrow & & \downarrow (u_\oplus^L)^{-1} \\
\perp \otimes U & \xrightarrow{m_x} & \perp \oplus U
\end{array}$$

- Composition is associative: Suppose $(f, U_1) : A \rightarrow B$, $(g, U_2) : B \rightarrow C$, $(h, U_3) : C \rightarrow D \in \mathbf{CP}^\infty(M : \mathbb{U} \rightarrow \mathbb{C})$. Then,

$$((f, U_1)(g, U_2))(h, U_3) := \begin{array}{c} \text{Diagram 1} \\ \sim \\ \text{Diagram 2} \end{array} =: (f, U_1)((g, U_2)(h, U_3))$$

Since $(U_1 \oplus U_2) \oplus U_3 \xrightarrow{a_\oplus} U_1 \oplus (U_2 \oplus U_3)$ is a unitary isomorphism, by Lemma 7.2, $(fg)h \sim f(gh) \in \mathbb{C} \Rightarrow ((f, U_1)(g, U_2))(h, U_3) = (f, U_1)((g, U_2)(h, U_3)) \in \mathbf{CP}^\infty(M : \mathbb{U} \rightarrow \mathbb{C})$. □

There is a canonical functor $Q : \mathbb{C} \rightarrow \mathbf{CP}^\infty(M : \mathbb{U} \rightarrow \mathbb{C})$ of the original category into the category of channels:

Lemma 7.7. *Let $M : \mathbb{U} \rightarrow \mathbb{C}$ be a mixed unitary category, then there is a canonical functor:*

$$Q : \mathbb{C} \rightarrow \mathbf{CP}^\infty(M : \mathbb{U} \rightarrow \mathbb{C}); \quad \begin{array}{c} A \\ f \downarrow \\ B \end{array} \mapsto \begin{array}{c} A \\ \downarrow f(u_\oplus^L)^{-1}((n_\perp^M)^{-1} \oplus 1) \\ M(\perp) \oplus B \end{array}$$

Proof. Q preserves identity maps and composition because $f(u_\oplus^L)^{-1} \sim f \sim (u_\oplus^L)^{-1} f$. □

There is no reason why this functor should be faithful and, indeed, in many cases it will *not* be faithful [46].

Theorem 7.8. $\mathbf{CP}^\infty(M : \mathbb{U} \rightarrow \mathbb{C})$ is an isomix category.

Proof. We know that $\mathbf{CP}^\infty(M : \mathbb{U} \rightarrow \mathbb{C})$ is well-defined category. Indeed, it has two tensors:

$\widehat{\otimes}$ and $\widehat{\oplus}$ given by the following Kraus maps:

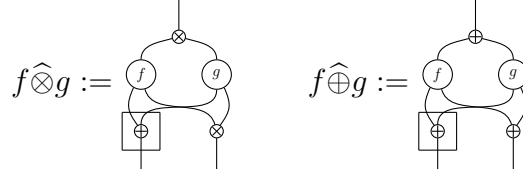

The units for $\widehat{\otimes}$ and $\widehat{\oplus}$ are \top and \perp respectively.

The linear distribution maps and all the basic natural isomorphisms are inherited from \mathbb{X} by composing each one of them with $(u_{\oplus}^L)^{-1}$ i.e.,

$$\frac{A \otimes (B \otimes C) \xrightarrow{a_{\otimes}} (A \otimes B) \otimes C \xrightarrow{(u_{\oplus}^L)^{-1}} \mathbb{C} / \sim}{A \widehat{\otimes} (B \widehat{\otimes} C) \xrightarrow{a_{\widehat{\otimes}} := a_{\otimes} (u_{\oplus}^L)^{-1}} (A \widehat{\otimes} B) \widehat{\otimes} C \in \mathbb{CP}^{\infty}(M : \mathbb{U} \rightarrow \mathbb{C})}$$

We prove that the associators and the other maps as defined above are natural isomorphisms in $\mathbb{CP}^{\infty}(M : \mathbb{U} \rightarrow \mathbb{C})$: From Lemma 7.7, $Q : \mathbb{C} \hookrightarrow \mathbb{CP}^{\infty}(M : \mathbb{U} \rightarrow \mathbb{C})$ is functorial which means that all commuting diagrams and isomorphisms are preserved. It remains to show that Q preserves the linear structure and the mix map:

- Q preserves \otimes : Suppose $f : A \rightarrow A'$ and $g : B \rightarrow B' \in \mathbb{C}$. Then, $Q(f) \widehat{\otimes} Q(g) = Q(f \otimes g)$:

$$\begin{aligned} Q(f) \widehat{\otimes} Q(g) &:= A \widehat{\otimes} B \xrightarrow{f(u_{\oplus}^L)^{-1} \widehat{\otimes} g(u_{\oplus}^L)^{-1}} (\perp \widehat{\oplus} \perp) \widehat{\otimes} (A' \widehat{\otimes} B') \\ Q(f \otimes g) &:= A \widehat{\otimes} B \xrightarrow{(f \otimes g) u_{\oplus}^{-1}} \perp \widehat{\oplus} (A' \widehat{\otimes} B') \end{aligned}$$

Since, $\perp \oplus \perp \xrightarrow{u_{\oplus}^L} \perp$ is a unitary isomorphism and, $f(u_{\oplus}^L)^{-1} \widehat{\otimes} g(u_{\oplus}^L)^{-1} (u_{\oplus}^L \oplus 1) = (f \otimes g) (u_{\oplus}^L)^{-1} \in \mathbb{C}$, by Lemma 7.2,

$$f(u_{\oplus}^L)^{-1} \widehat{\otimes} g(u_{\oplus}^L)^{-1} \sim (f \otimes g) (u_{\oplus}^L)^{-1}$$

Therefore, $Q(f) \widehat{\otimes} Q(g) = Q(f \otimes g)$. Similarly, $Q(f) \widehat{\oplus} Q(g) = Q(f \oplus g)$.

- Q preserves all basic natural isomorphisms (associators, unitors, symmetry maps, mix map) and linear distributions:

To prove that $a_{\widehat{\otimes}}$ is natural in $\mathbb{CP}^{\infty}(M : \mathbb{U} \rightarrow \mathbb{C})$, we need to prove that the following diagram commutes in $\mathbb{CP}^{\infty}(M : \mathbb{U} \rightarrow \mathbb{C})$:

$$\begin{array}{ccc}
A \widehat{\otimes} (B \widehat{\otimes} C) & \xrightarrow{a_{\widehat{\otimes}}} & (A \widehat{\otimes} B) \widehat{\otimes} C \\
(f \widehat{\otimes} g) \widehat{\otimes} h \downarrow & & \downarrow f \widehat{\otimes} (g \widehat{\otimes} h) \\
A' \widehat{\otimes} (B' \widehat{\otimes} C') & \xrightarrow{a_{\widehat{\otimes}}} & (A' \widehat{\otimes} B') \widehat{\otimes} C'
\end{array}$$

In other words, we need to show that the two compositions in \mathbb{C} are equivalent as Kraus maps. This follows from Lemma 7.2 as there is a unitary isomorphism between the ancillary objects $\perp \oplus (U_1 \oplus (U_2 \oplus U_3))$ and $\perp \oplus (U_1 \oplus U_2) \oplus U_3$. Similarly, we can show that the other basic linearly distributive transformations as defined are natural transformations. Since Q is functorial, it preserves isomorphisms and commuting diagrams so that the coherence diagrams automatically commute.

□

$\mathbf{CP}^\infty(M : \mathbb{U} \rightarrow \mathbb{C})$, in general, does not have a dagger even when \mathbb{C} is a \dagger -isomix category. However, if $M : \mathbb{U} \rightarrow \mathbb{C}$ is a $*$ -MUdC, that is, a mixed unitary category in which every object in \mathbb{U} has a unitary dual and if \mathbb{C} is a \dagger -isomix $*$ -autonomous category, then $\mathbf{CP}^\infty(M : \mathbb{U} \rightarrow \mathbb{C})$ has an obvious dagger as shown below:

Lemma 7.9. *If $M : \mathbb{U} \rightarrow \mathbb{C}$ is a $*$ -MUdC then $\mathbf{CP}^\infty(M : \mathbb{U} \rightarrow \mathbb{C})$ is a \dagger -isomix category and*

$$N : \mathbb{U} \rightarrow \mathbf{CP}^\infty(M : \mathbb{U} \rightarrow \mathbb{C}); f \downarrow \mapsto \begin{array}{ccc} U_1 & M(U_1) & \\ & \downarrow [(M(f)(u_{\oplus}^L)^{-1}((n_{\perp}^M)^{-1} \oplus 1), \perp)] & \\ U_2 & M(U_2) & \end{array}$$

is a $*$ -MUdC.

Proof. (Sketch) We first observe that $\mathbf{CP}^\infty(M : \mathbb{U} \rightarrow \mathbb{C})$ is a \dagger -isomix category. We have already proven that $\mathbf{CP}^\infty(M : \mathbb{U} \rightarrow \mathbb{C})$ is an isomix category. Suppose \mathbb{X} is a $*$ -MUdC, then the \dagger functor for $\mathbf{CP}^\infty(M : \mathbb{U} \rightarrow \mathbb{C})$ is defined as follows: Suppose $(f, U) : A \rightarrow B$ and $(\eta, \epsilon) : V \dashv_u U$ with $A' \dashv A$ and $B' \dashv B \in \mathbb{C}$ then,

$$\dagger : \mathbf{CP}^\infty(M : \mathbb{U} \rightarrow \mathbb{C})^{\text{op}} \rightarrow \mathbf{CP}^\infty(M : \mathbb{U} \rightarrow \mathbb{C}); \begin{array}{c} A \\ | \\ \text{---} \\ | \\ \text{---} \\ | \\ B \end{array} \xrightarrow{\dagger} \begin{array}{c} \boxed{\epsilon} \\ | \\ B' \\ | \\ \text{---} \\ | \\ \text{---} \\ | \\ \boxed{f} \\ | \\ A' \\ | \\ V' \end{array}$$

We need to prove that \dagger is well-defined: $f \sim g \Rightarrow f^\dagger \sim g^\dagger$.

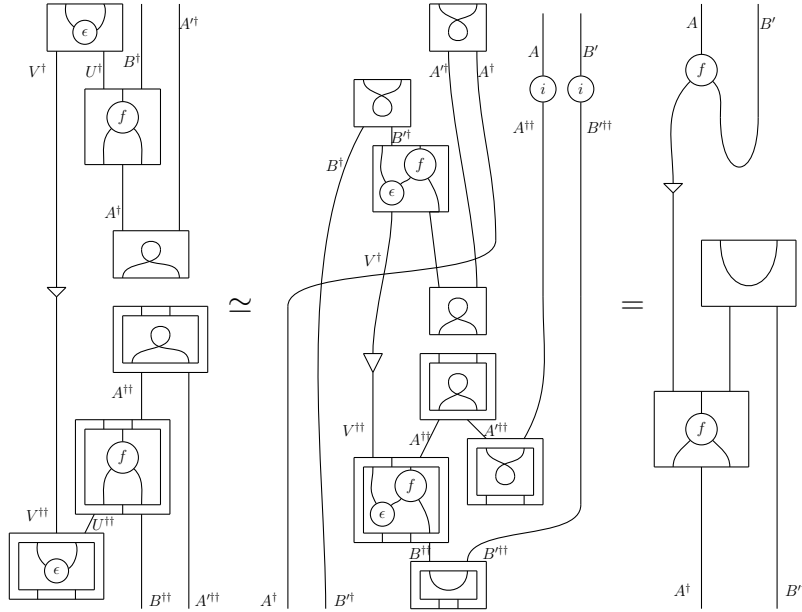

The equality is proved by using the snake diagrams and [U.2], [U.5](b), and [Udual.]. Suppose $f : A \rightarrow U_1 \oplus B$ and $g : B \rightarrow U_2 \oplus C$ with $(\eta_1, \epsilon_1) : U_1 \dashv_u V_1$ and $(\eta_2, \epsilon_2) : U_2 \dashv_u V_2$, then \dagger preserves composition, that is $(fg)^\dagger = g^\dagger f^\dagger$:

$$\frac{(fg) : A \rightarrow (U_1 \oplus U_2) \oplus C}{(fg)^\dagger : C^\dagger \rightarrow (V_1 \otimes V_2)^\dagger \oplus A^\dagger}$$

$$\frac{g^\dagger : C^\dagger \rightarrow U_2^\dagger \oplus B^\dagger \quad f^\dagger : B^\dagger \rightarrow U_1^\dagger \oplus A^\dagger}{(g^\dagger f^\dagger) : C^\dagger \rightarrow (V_2^\dagger \otimes V_1^\dagger) \oplus A^\dagger}$$

To prove that $(fg)^\dagger = (g^\dagger f^\dagger)$ in $\mathbf{CP}^\infty(M : \mathbb{U} \rightarrow \mathbb{C})$, represent the maps in circuit calculus and fuse the \dagger -boxes. Once the \dagger -boxes are fused, use Lemma 7.2 to show that both Kraus operations belong to the same equivalence. \dagger preserves identity map since $((u_\oplus^R)^{-1}, u_\oplus^L) : \top \dashv_u \perp$. Hence, \dagger is a functor.

All the basic natural isomorphisms associated with \dagger functor - $\lambda_\oplus, \lambda_\otimes, \lambda_\perp, \lambda_\top, \iota$ - are lifted from \mathbb{C} using $Q : \mathbb{C} \hookrightarrow \mathbf{CP}^\infty(M : \mathbb{U} \rightarrow \mathbb{C})$ which is defined in Lemma 7.7. The lifted morphisms are natural in $\mathbf{CP}^\infty(M : \mathbb{U} \rightarrow \mathbb{C})$ since their ancillaries are unitarily isomorphic. Since \dagger is functorial, all commuting diagrams are preserved. By the same argument, unitary structure is preserved under Q .

Thus, $\mathbf{CP}^\infty(M : \mathbb{U} \rightarrow \mathbb{C})$ is a mixed unitary category: as Q preserves all unitary linear adjoints this makes $\mathbf{CP}^\infty(M : \mathbb{U} \rightarrow \mathbb{C})$ a $*$ -MUdC. \square

Lemma 7.10. *The \mathbf{CP}^∞ -construction is functorial on $*$ -MUdCs.*

Proof. Let $M : \mathbb{U} \rightarrow \mathbb{C}$ and $M' : \mathbb{U}' \rightarrow \mathbb{C}'$ be $*$ -MUdCs and the following square be a MUC morphism:

$$\begin{array}{ccc} \mathbb{U} & \xrightarrow{M} & \mathbb{C} \\ F_u \downarrow & \Downarrow \alpha & \downarrow F \\ \mathbb{U}' & \xrightarrow{M'} & \mathbb{C}' \end{array}$$

F_u and F are \dagger -isomix functors and F_u preserves unitary structure i.e., $F_u(\varphi_A)\rho^{F_u} = \varphi_{F_u(A)}$ and $(n_{\perp}^{F_u}$ or $m_{\top}^{F_u})$ is a unitary isomorphism. α is a \dagger -linear natural isomorphism.

Then, the \mathbf{CP}^∞ -construction is functorial if there is a MUC morphism:

$$\begin{array}{ccc} \mathbb{U} & \xrightarrow{MQ} & \mathbf{CP}^\infty(M : \mathbb{U} \rightarrow \mathbb{C}) \\ F_u \downarrow & \Downarrow \alpha & \downarrow G \\ \mathbb{U}' & \xrightarrow{M'Q} & \mathbf{CP}^\infty(M' : \mathbb{U}' \rightarrow \mathbb{C}') \end{array}$$

Recall the functor $Q : \mathbb{C} \hookrightarrow \mathbf{CP}^\infty(M : \mathbb{U} \rightarrow \mathbb{C})$ from Lemma 7.7. Define $G : \mathbf{CP}^\infty(M : \mathbb{U} \rightarrow \mathbb{C}) \rightarrow \mathbf{CP}^\infty(M' : \mathbb{U}' \rightarrow \mathbb{C}')$ as follows:

$$G : \mathbf{CP}^\infty(M : \mathbb{U} \rightarrow \mathbb{C}) \rightarrow \mathbf{CP}^\infty(M' : \mathbb{U}' \rightarrow \mathbb{C}'); \quad \begin{array}{c} A \\ \downarrow [(f,U)] \\ B \end{array} \mapsto \begin{array}{c} F(A) \\ \downarrow [(F(f)n_{\oplus}^F(\alpha \oplus 1), F_u(U))] \\ F(B) \end{array}$$

The action of functor $G : \mathbf{CP}^\infty(M : \mathbb{U} \rightarrow \mathbb{C}) \rightarrow \mathbf{CP}^\infty(M' : \mathbb{U}' \rightarrow \mathbb{C}')$ on maps is drawn as follows:

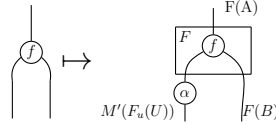

The natural isomorphism α lifts to $\mathbf{CP}^\infty(M' : \mathbb{U}' \rightarrow \mathbb{C}')$ as follows:

$$\alpha' := [(\alpha_u(u_{\oplus}^L)^{-1}((n_{\perp}^{M'})^{-1} \oplus 1), \perp)] : F(M(U)) \rightarrow M'(F_u(U))$$

It is immediate that $\alpha'_{U'} : (G(Q(M(U_1)) := F(M(U_1))) \rightarrow (Q(M'(F_u(U_2))) := M'(F_u(U_1)))$ is an isomorphism. Let $U_1 \xrightarrow{f} U_2 \in \mathbb{U}$. To prove that α' is natural, we show that the following diagram commutes in $\mathbf{CP}^\infty(M' : \mathbb{U}' \rightarrow \mathbb{C}')$.

$$\begin{array}{ccc} F(M(U_1)) & \xrightarrow{[(F(M(f)(u_{\oplus}^L)^{-1}((n_{\perp}^{M'})^{-1} \oplus 1))n_{\oplus}^F(\alpha \oplus 1), F_u(\perp))]} & F(M(U_2)) \\ \alpha'_{U_1} \downarrow & & \downarrow \alpha'_{U_2} \\ M'(F_u(U_1)) & \xrightarrow{[(M'(F_u(f))(u_{\oplus}^L)^{-1}((n_{\perp}^{M'})^{-1} \oplus 1), \perp)]} & M'(F_u(U_2)) \end{array}$$

The underlying Kraus maps for both the compositions are equivalent since $F_u(\perp) \xrightarrow{(n_{\perp}^{F_u})^{-1}} \perp$ is unitarily isomorphic:

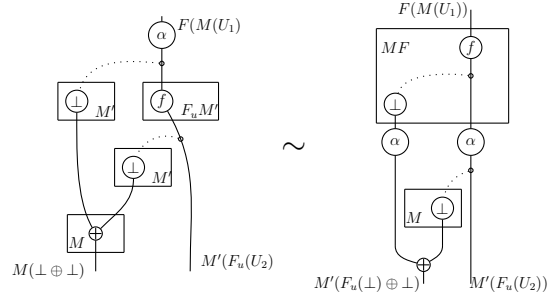

Hence, the diagram commutes and α' is natural in $\mathbf{CP}^\infty(M' : \mathbb{U}' \rightarrow \mathbb{C}')$. \square

The following table summarizes the structures inherited by $\mathbf{CP}^\infty(M : \mathbb{U} \rightarrow \mathbb{C})$ from $M : \mathbb{U} \rightarrow \mathbb{C}$:

$M : \mathbb{U} \rightarrow \mathbb{C}$	$\mathbf{CP}^\infty(M : \mathbb{U} \rightarrow \mathbb{C})$
mixed unitary category	isomix category
*-mixed unitary category with unitary duals	*-mixed unitary category with unitary duals
\dagger -symmetric monoidal category	symmetric monoidal category
\dagger -compact closed category	\dagger -compact closed category ($\mathbf{CP}^\infty(\mathbb{X}) \simeq \mathbf{CPM}(\mathbb{X})$)

7.3 Environment structure for MUCs

In this section, we describe when a given isomix category is of the form $\mathbf{CP}^\infty(M : \mathbb{U} \rightarrow \mathbb{C})$ by generalizing the notion of environment structures from \dagger -symmetric monoidal categories (see [46]) to mixed unitary categories. We then show that an environment structure over M which has purification is isomorphic to $\mathbf{CP}^\infty(M : \mathbb{U} \rightarrow \mathbb{C})$.

7.3.1 Environment structure

We first define environment structure for MUCs and give examples:

Definition 7.11. *An environment structure for a mixed unitary category $M : \mathbb{U} \rightarrow \mathbb{C}$ is a strict isomix functor $F : \mathbb{C} \rightarrow \mathbb{D}$ where \mathbb{D} is an isomix category and a family of maps $\perp_U : F(M(U)) \rightarrow \perp$ indexed by objects $U \in \mathbb{U}$ such that the following conditions hold:*

[Env.1] For $U, V \in \mathbb{U}$, the following diagrams commute:

$$\begin{array}{c}
 \text{(a)} \quad F(M(U)) \otimes F(M(V)) \xrightarrow{m_\otimes} F(M(U)) \oplus F(M(V)) \xrightarrow{\perp \oplus \perp} \perp \oplus \perp \\
 \begin{array}{ccc}
 \downarrow m_\otimes & & \downarrow u_\oplus \\
 F(M(U \otimes V)) & \xrightarrow{\perp} & \perp
 \end{array} \\
 \\
 \text{(b)} \quad F(M(U \oplus V)) \xrightarrow{\perp} \perp \\
 \begin{array}{ccc}
 \downarrow n_\oplus & & \downarrow u_\oplus \\
 F(M(U)) \oplus F(M(V)) & \xrightarrow{\perp \oplus \perp} \perp \oplus \perp \xrightarrow{u_\oplus} \perp
 \end{array}
 \end{array}$$

[Env.2] Kraus maps $(f, U) \sim (g, V) \in \mathbb{C}$ if and only if the following diagram commutes:

$$\begin{array}{ccc}
 & F(M(A)) & \\
 F(M(f)) \swarrow & & \searrow F(M(g)) \\
 F(M(U \oplus B)) & & F(M(U \oplus B)) \\
 \nu_\otimes \downarrow & & \nu_\otimes \downarrow \\
 F(M(U)) \oplus MF(B) & & F(M(U)) \oplus F(M(B)) \\
 \perp \oplus 1 \downarrow & & \perp \oplus 1 \downarrow \\
 \perp \oplus F(M(B)) & \xlongequal{\quad\quad\quad} & \perp \oplus F(M(B))
 \end{array}$$

The conditions are represented diagrammatically as follows:

$$\begin{array}{ccc}
 \text{[Env.1a]} & \begin{array}{c} \text{Diagram: } \text{Box}(MF) \text{ with } \otimes \text{ and } \oplus \text{ nodes, } \perp \text{ and } \oplus \text{ symbols} \end{array} & \\
 \text{[Env.1b]} & \begin{array}{c} \text{Diagram: } \text{Box}(MF) \text{ with } \oplus \text{ node, } \perp \text{ and } \oplus \text{ symbols, } F(M(U \oplus V)) \end{array} & \\
 \text{[Env.2]} & \begin{array}{c} \text{Diagram: } \text{Box}(f) \text{ and } \text{Box}(g) \text{ with } \perp \text{ and } \oplus \text{ symbols, } f \sim g \end{array} &
 \end{array}$$

Definition 7.12. An environment structure $F : \mathbb{C} \rightarrow \mathbb{D}$ with \perp for a mixed unitary category $M : \mathbb{U} \rightarrow \mathbb{C}$ has **purification** if

- F is bijective on objects, and
- for all $f : F(A) \rightarrow F(B) \in \mathbb{D}$, there exists a Kraus map $(f', U) : A \rightarrow B \in \mathbb{C}$ such

that

$$[\mathbf{Env.3}] \quad f = \begin{array}{c} \boxed{f'} \\ \oplus \\ \oplus \\ \perp \end{array}$$

Equationally,

$$F(A) \xrightarrow{f} F(B) = F(A) \xrightarrow{F(f')} F(M(U) \oplus B) \xrightarrow{n_\oplus} M(F(U)) \oplus F(B) \xrightarrow{\perp \oplus 1} \perp \oplus F(B) \xrightarrow{u_\oplus} F(B)$$

Lemma 7.13. *Every mixed unitary category $M : \mathbb{U} \rightarrow \mathbb{C}$ has an environment structure given by*

$$F : \mathbb{C} \rightarrow \mathbb{CP}^\infty(M : \mathbb{U} \rightarrow \mathbb{C}); \begin{array}{c} A \\ f \downarrow \\ B \end{array} \mapsto \begin{array}{c} A \\ \downarrow [(f(u_\oplus^L)^{-1}(n_\perp^M)^{-1}, \perp)] \\ M(\perp) \oplus B \end{array}$$

and

$$\perp : M(U) \rightarrow \perp \in \mathbb{CP}^\infty(M : \mathbb{U} \rightarrow \mathbb{C}) := [(u_\oplus^R)^{-1}, U]$$

for each object $U \in \mathbb{U}$. Moreover, this environment structure has purification.

Proof. F is functorial since $f(u_\oplus^L)^{-1}((n_\perp^M)^{-1} \oplus 1) \sim f \sim (u_\oplus^L)^{-1}(n_\perp^M)^{-1}(1 \oplus f)$. Define $F_\otimes = F_\oplus := F$. Note that, F is a strict monoidal functor and an isomix functor. In order to prove that $F : \mathbb{C} \rightarrow \mathbb{D}$ with \perp satisfy axioms for environment structures, the properties of isomix functor and Lemma 7.2 are used.

To prove that this environment structure has purification, consider any map $[(f, U)] : A \rightarrow B \in \mathbb{CP}^\infty(M : \mathbb{U} \rightarrow \mathbb{C})$. Then, there exists a Kraus map $(f, U) : A \rightarrow B \in \mathbb{C}$. Then, the map in equation **[Env. 3]** is drawn as follows:

$$\boxed{F(f)} = \begin{array}{c} \begin{array}{c} \oplus \\ \oplus \\ \perp \end{array} \\ \left[\begin{array}{c} \text{Diagram of } F(f) \text{ with } U, B, \perp \oplus B \end{array} \right] \end{array}$$

Because, $\begin{array}{c} \text{Diagram of } F(f) \\ \sim \\ \begin{array}{c} \oplus \\ \oplus \\ \perp \end{array} \end{array}$, the environment structure $(Q : \mathbb{C} \rightarrow \mathbb{CP}^\infty(M : \mathbb{U} \rightarrow \mathbb{C}), \perp)$ has

purification. □

The following are the environment structures for our running examples:

- Consider the MUC, $\mathbb{R}^* \subset \mathbb{C}$. Then,

$$(\mathbb{R}^* \xrightarrow{Q} \mathbf{CP}^\infty(\mathbb{R} \subset \mathbb{C}), \perp_r : r \rightarrow 1)$$

is an environment structure where, $\perp_r := (=, 1/r) : r \rightarrow 1$

- Consider the MUC, $\mathbf{Mat}_{\mathbb{C}} \rightarrow \mathbf{FMat}_{\mathbb{C}}$. Then,

$$\mathbf{Mat}_{\mathbb{C}} \xrightarrow{Q} \mathbf{CP}^\infty(\mathbf{Mat}_{\mathbb{C}} \subset \mathbf{FMat}_{\mathbb{C}})$$

is an environment structure where, $\perp_{\mathbb{C}^n} : \mathbb{C}^n \rightarrow \mathbb{C}; \rho \mapsto \text{Tr}(\rho)$.

7.3.2 Characterizing the \mathbf{CP}^∞ construction

In the rest of the section, we show that any environment structure with purification is initial in the category of environment structures. Given Lemma 7.13, this shows that any environment structure over a $M : \mathbb{U} \rightarrow \mathbb{C}$ with purification is isomorphic to $\mathbf{CP}^\infty(M : \mathbb{U} \rightarrow \mathbb{C})$. Thus, environment structures with purification captures the abstract structure of $\mathbf{CP}^\infty(M : \mathbb{U} \rightarrow \mathbb{C})$.

Definition 7.14. *Let $M : \mathbb{U} \rightarrow \mathbb{C}$ be a mixed unitary category. Define a category $\mathbf{Env}(M : \mathbb{U} \rightarrow \mathbb{C})$ as follows:*

Objects: *Environment structures for $M : \mathbb{U} \rightarrow \mathbb{C}$*

Arrows: *Suppose $D : \mathbb{C} \rightarrow \mathbb{D}$ with \perp , and $D' : \mathbb{C} \rightarrow \mathbb{D}'$ with \downarrow are two environment structures. Then, a morphism of environment structures is a strict isomix functor $F : \mathbb{D} \rightarrow \mathbb{D}'$ such that*

- $DF = D'$
- $F(\perp) = \downarrow$

Identity arrows: *Identity functor*

Composition: *Linear functor composition*

Lemma 7.15. *Let $M : \mathbb{U} \rightarrow \mathbb{C}$ be a mixed unitary category. Suppose $D : \mathbb{C} \rightarrow \mathbb{D}$ with \perp is an environment structure with purification, then it is initial in $\mathbf{Env}(M : \mathbb{U} \rightarrow \mathbb{C})$.*

Proof. Suppose $(D' : \mathbb{X} \rightarrow \mathbb{Y}', \perp) \in \text{Env}(\mathbb{C})$. We show that there is a unique strict isomix functor $F : \mathbb{D} \rightarrow \mathbb{D}'$ such that $DF = D'$ and $F(\perp) = \perp$.

Define $F : \mathbb{D} \rightarrow \mathbb{D}'$ as follows:

- Since (D, \perp) has purification, $D : \mathbb{C} \rightarrow \mathbb{D}$ is bijective on objects. Then for all $A \in \mathbb{D}$, $A = D(X)$ for a unique $X \in \mathbb{C}$. Then,

$$F(A) := D'(X)$$

- Let $f : A \rightarrow B \in \mathbb{D}$. Since $(D : \mathbb{C} \rightarrow \mathbb{D}, \perp)$ has purification,

$$\begin{array}{c} A \\ | \\ \textcircled{f} \\ | \\ B \end{array} = \begin{array}{c} D(X) \\ | \\ \textcircled{D(f)} \\ | \\ \perp \\ | \\ D(Y) \end{array} \xrightarrow{F} \begin{array}{c} D'(X) \\ | \\ \textcircled{D'(f)} \\ | \\ \perp \\ | \\ D'(Y) \end{array}$$

where $F(\perp) = \perp$.

This fixes the definition of F . To prove that F is well-defined on arrows we need to show that $f = g \Rightarrow F(f) = F(g)$. Since, (D, \perp) has purification, let

$$\begin{array}{c} | \\ \textcircled{f} \\ | \\ \perp \end{array} = \begin{array}{c} | \\ \textcircled{D(\bar{f})} \\ | \\ \perp \end{array} \quad \begin{array}{c} | \\ \textcircled{g} \\ | \\ \perp \end{array} = \begin{array}{c} | \\ \textcircled{D(\bar{g})} \\ | \\ \perp \end{array}$$

Then,

$$\begin{array}{c} | \\ \textcircled{D(\bar{f})} \\ | \\ \perp \end{array} = \begin{array}{c} | \\ \textcircled{D(\bar{g})} \\ | \\ \perp \end{array} \Leftrightarrow \begin{array}{c} | \\ \bar{f} \\ | \\ \perp \end{array} = \begin{array}{c} | \\ \bar{g} \\ | \\ \perp \end{array} \Leftrightarrow \begin{array}{c} | \\ \textcircled{D'(\bar{f})} \\ | \\ \perp \end{array} = \begin{array}{c} | \\ \textcircled{D'(\bar{g})} \\ | \\ \perp \end{array}$$

$F : \mathbb{D} \rightarrow \mathbb{D}'$ preserves identity:

$$F(1_A) = F(1_{D(X)}) = F(D(1_X)) = D'(1_X) = 1_{D'(X)} = 1_{F(D(X))} = 1_{F(A)}$$

$F : \mathbb{D} \rightarrow \mathbb{D}'$ preserves composition:

$$F \left(\begin{array}{c} | \\ \textcircled{f} \\ | \\ \textcircled{g} \\ | \\ \perp \end{array} \right) = F \left(\begin{array}{c} | \\ \textcircled{D(\bar{f})} \\ | \\ \textcircled{D(\bar{g})} \\ | \\ \perp \end{array} \right) \stackrel{\text{Env.1a}}{=} F \left(\begin{array}{c} | \\ \textcircled{D'(\bar{f})} \\ | \\ \textcircled{D'(\bar{g})} \\ | \\ \perp \end{array} \right) := \begin{array}{c} | \\ \textcircled{D'(\bar{f})} \\ | \\ \textcircled{D'(\bar{g})} \\ | \\ \perp \end{array} \stackrel{\text{Env.1a}}{=} \begin{array}{c} | \\ \textcircled{D'(\bar{f})} \\ | \\ \textcircled{D'(\bar{g})} \\ | \\ \perp \end{array} = \begin{array}{c} | \\ \textcircled{D'(\bar{f})} \\ | \\ \textcircled{D'(\bar{g})} \\ | \\ \perp \end{array} = \begin{array}{c} | \\ \textcircled{F(f)} \\ | \\ \textcircled{F(g)} \\ | \\ \perp \end{array}$$

$F : \mathbb{D} \rightarrow \mathbb{D}'$ is strict monoidal in \otimes :

$$F \left(\begin{array}{c} | \\ \textcircled{f} \\ | \\ \otimes \\ | \\ \textcircled{g} \\ | \\ \perp \end{array} \right) = F \left(\begin{array}{c} | \\ \textcircled{D(\bar{f})} \\ | \\ \otimes \\ | \\ \textcircled{D(\bar{g})} \\ | \\ \perp \end{array} \right) = F \left(\begin{array}{c} | \\ \textcircled{D(\bar{f})} \\ | \\ \textcircled{D(\bar{g})} \\ | \\ \perp \end{array} \right) = \begin{array}{c} | \\ \textcircled{D'(\bar{f})} \\ | \\ \textcircled{D'(\bar{g})} \\ | \\ \perp \end{array} = \begin{array}{c} | \\ \textcircled{D'(\bar{f})} \\ | \\ \otimes \\ | \\ \textcircled{D'(\bar{g})} \\ | \\ \perp \end{array} = \begin{array}{c} | \\ \textcircled{D'(\bar{f})} \\ | \\ \otimes \\ | \\ \textcircled{D'(\bar{g})} \\ | \\ \perp \end{array} = \begin{array}{c} | \\ \textcircled{D'(\bar{f})} \\ | \\ \otimes \\ | \\ \textcircled{D'(\bar{g})} \\ | \\ \perp \end{array} = \begin{array}{c} | \\ \textcircled{D'(\bar{f})} \\ | \\ \otimes \\ | \\ \textcircled{D'(\bar{g})} \\ | \\ \perp \end{array}$$

and, $F((u_{\otimes}^L)_A) = F((u_{\otimes}^L)_{D(X)}) = F(D((u_{\otimes}^L)_X)) = D'((u_{\otimes}^L)_X) = (u_{\otimes}^L)_{D'(X)} = (u_{\otimes}^L)_{F(D(X))} = (u_{\otimes}^L)_{F(A)}$

Similarly, it can be proved that F is strict comonoidal in \oplus .

Define $F_{\otimes} = F_{\oplus} := F$ and linear strengths to be identity maps. Thus, F is a unique strict Frobenius functor. F is an isomix functor because D and D' preserve the mix map m on the nose. \square

Corollary 7.16. *Suppose $D : \mathbb{C} \rightarrow \mathbb{D}$ with \perp is an environment structure with purification for $M : \mathbb{U} \rightarrow \mathbb{C}$. Then, $\mathbb{D} \simeq \mathbf{CP}^{\infty}(M : \mathbb{U} \rightarrow \mathbb{C})$.*

Proof. By Lemma 7.15, $D : \mathbb{C} \rightarrow \mathbb{D}$ with \perp is initial in $\mathbf{Env}(M : \mathbb{U} \rightarrow \mathbb{C})$. By Lemma 7.13, $F : \mathbb{C} \rightarrow \mathbf{CP}^{\infty}(M : \mathbb{U} \rightarrow \mathbb{C})$ with $[(u_{\oplus}^R)^{-1}, U]$ is an environment structure for $M : \mathbb{U} \rightarrow \mathbb{C}$ which has purification, hence it is also an initial object in $\mathbf{Env}(M : \mathbb{U} \rightarrow \mathbb{C})$. Since, initial objects of a category are isomorphic, there exists a strict isomix functor $\mathbb{D} \xrightarrow{F} \mathbf{CP}^{\infty}(M : \mathbb{U} \rightarrow \mathbb{C})$ that is full and faithful. \square

Chapter 8

Linear monoids, comonoids, and bialgebras

In a \dagger -monoidal category, (strong) complementary observables are axiomatized by two special commutative \dagger -Frobenius algebras interacting bialgebraically to produce two Hopf algebras, see Section 6.4.2. In an LDC, Frobenius algebras are generalized to linear monoids. However, bialgebraic interaction between two linear monoids is prohibited due to the directionality of the linear distributor. This raises the following question: *how one can model complementary observables in a \dagger -isomix setting?*

In this chapter, we develop new structures called linear comonoids and linear bialgebras which provide the basis to describe complementary systems in \dagger -isomix categories.

8.1 Linear monoids

For a Frobenius algebra, the monoid and the comonoid occur on the same object, and the object is self-dual. In an LDC, the presence of distinct tensor products - the tensor and the par - allows a ‘Frobenius interaction’ between a monoid and its dual comonoid, however the monoid and the comonoid now occur on distinct objects. A linear monoid, loosely defined, is a \otimes -monoid on an object A and A has a dual object.

8.1.1 Duals

Adding the sequent rules for negation (see Figure 1.3) to LDCs results in the notion of duals. We briefly discussed duals [35] in LDCs in Section 2.1.4. We delve deeper into the notion of duals, subsequently introduce \dagger -duals in this section.

In a compact closed category or a $*$ -autonomous category there is a canonical dual associated with each object. In an LDC if an object has a dual, it must be specified. Of course,

(1) and (4) are because $(1, q)$ is a morphism of duals, (2) is because of the right \dagger -duality of A , and (3) is because $\iota_B^{-1\dagger} = \iota_{B^\dagger}$.

Define the left \dagger -dual $(\tau', \gamma') : B^\dagger \dashv B$ as follows:

$$\tau' = \begin{array}{c} \tau' \\ \text{---} \\ B^\dagger \quad B \end{array} := \begin{array}{c} \tau \\ \text{---} \\ \begin{array}{c} A \\ \circlearrowleft p \\ B^\dagger \end{array} \quad \begin{array}{c} A^\dagger \\ \circlearrowright q \\ B \end{array} \end{array} = \begin{array}{c} \eta \\ \text{---} \\ \begin{array}{c} A \\ \circlearrowleft p \\ B^\dagger \end{array} \quad B \end{array} \quad \gamma' = \begin{array}{c} B \\ \text{---} \\ \gamma' \\ \text{---} \\ B^\dagger \end{array} := \begin{array}{c} B \\ \text{---} \\ \begin{array}{c} B \\ \circlearrowleft q^{-1} \\ A^\dagger \end{array} \quad \begin{array}{c} B^\dagger \\ \circlearrowright p^{-1} \\ A \end{array} \end{array} = \begin{array}{c} B \\ \text{---} \\ \begin{array}{c} B \\ \circlearrowleft q^{-1} \\ A^\dagger \end{array} \quad A \end{array} \quad \epsilon$$

It is clear that τ' and γ' satisfy snake diagrams. $(\tau', \gamma') : B^\dagger \dashv B$ can be proven to be a left \dagger -dual using the equation $\iota_B p^\dagger q = 1_B$. It is straightforward from the definition of τ' and γ' that $(p, 1)$ is a morphism of duals.

(ii) \Rightarrow (iii) Given that $(p, 1)$ is a morphism of duals as illustrated by diagram (b). Define,

$$q : A^\dagger \rightarrow B := \begin{array}{c} A^\dagger \\ \text{---} \\ \begin{array}{c} A \\ \circlearrowleft p \\ \eta \\ \text{---} \\ B \end{array} \end{array}$$

$(p, q) : ((\eta, \epsilon) : A \dashv B) \rightarrow ((\eta^\dagger, \epsilon^\dagger) : B^\dagger \dashv A^\dagger)$ is a morphism of duals because:

$$\begin{array}{c} \epsilon \\ \text{---} \\ B^\dagger \end{array} \quad \begin{array}{c} A^\dagger \\ \circlearrowright q \\ B \end{array} = \begin{array}{c} \epsilon \\ \text{---} \\ B^\dagger \end{array} \quad \begin{array}{c} A \\ \circlearrowleft p \\ \eta \\ \text{---} \\ B \end{array} = \begin{array}{c} \eta \\ \text{---} \\ \begin{array}{c} A \\ \circlearrowleft p \\ B^\dagger \end{array} \quad B \end{array}$$

Since p and q are isomorphisms, it remains to prove that either $pq^\dagger = i_A$ or $p^\dagger q = \iota_B^{-1}$. Using the definition of q , we note that,

$$p : A \rightarrow B^\dagger = \begin{array}{c} A \\ \text{---} \\ \begin{array}{c} \epsilon \\ \text{---} \\ B^\dagger \end{array} \quad \begin{array}{c} B \\ \circlearrowright q \\ B \end{array} \end{array}$$

From the proof of (i) \Rightarrow (ii) we know that $p^\dagger q = \iota_B^{-1}$. Thus, statement (iii) holds.

(iii) \Rightarrow (i) Assume that statement (iii) holds. Define a dual $(\tau, \gamma) : A \dashv B$ as follows:

$$\begin{array}{c} \tau \\ \text{---} \\ A \quad A^\dagger \end{array} := \begin{array}{c} \eta \\ \text{---} \\ \begin{array}{c} B \\ \circlearrowright q^{-1} \\ A^\dagger \end{array} \end{array} \quad \gamma = \begin{array}{c} A^\dagger \\ \text{---} \\ \gamma \\ \text{---} \\ A \end{array} := \begin{array}{c} A^\dagger \\ \text{---} \\ \begin{array}{c} B \\ \circlearrowright q \\ B \end{array} \quad A \end{array} \quad \epsilon$$

$(\tau, \gamma) : A \dashv A^\dagger$ is a right \dagger -dual because $pq^\dagger = \iota_A$. It is straightforward that $(1_A, q)$ is a morphism of duals. □

A **\dagger -dual** is a dual that satisfies any of the three equivalent statements of the previous Lemma. Notice, however, in statement (i) of the previous lemma, that the morphism to a given right \dagger -dual is uniquely determined by demanding the map is $(1_A, q)$ as 1_A completely

determines q . If *there exists* a right \dagger -dual for A , then any mere linear dual of A is a \dagger -dual. Thus, \dagger -duality really is a property of the object A rather than of the duality. Hence, in the rest of the thesis, we will use right and left \dagger -duals synonymously with \dagger -duals.

In a dagger monoidal setting, conventionally, we have a dagger dual [110] when the symmetry map acts an isomorphism between the dual and its dagger:

$$\begin{array}{ccc}
 A & \xrightarrow{(\eta, \epsilon)} \dashv\vdash & B \\
 & \searrow & \swarrow \\
 & & \\
 & \swarrow & \searrow \\
 B^\dagger = B & \xrightarrow{(\epsilon^\dagger, \eta^\dagger)} \dashv\vdash & A^\dagger = A \\
 \epsilon^\dagger = \eta c_\otimes; \eta^\dagger = c_\otimes \epsilon & &
 \end{array}$$

Using the symmetry map in this manner requires the dagger functor to be stationary on objects ($A = A^\dagger$) which does not hold in a \dagger -LDC in general ($A \neq A^\dagger$). The following diagram represents a *dagger*-dual in a \dagger -LDC:

$$\begin{array}{ccc}
 A & \xrightarrow{(\eta, \epsilon)} \dashv\vdash & B \\
 p \downarrow & & \uparrow q \\
 B^\dagger & \xrightarrow{(\epsilon^\dagger, \eta^\dagger)} \dashv\vdash & A^\dagger \\
 \epsilon^\dagger = \eta(q^{-1} \otimes p)\lambda_\oplus & &
 \end{array}$$

In the category of complex finiteness matrices, $\mathbf{FMat}(\mathbb{C})$, which is a \dagger -*-isomix category, every dual is a \dagger -dual. The category of finite-dimensional complex matrices, $\mathbf{Mat}(\mathbb{C})$ which is a \dagger -compact closed category is isomorphic to the core of $\mathbf{FMat}(\mathbb{C})$, see Section 2.3.4. Thus, every dual in $\mathbf{Mat}(\mathbb{C})$ is also \dagger -dual. In fact every dual in $\mathbf{FMat}(\mathbb{C})$ is both a \dagger -dual and a unitary dual ($\eta^\dagger = \epsilon c_\otimes$). These examples are discussed in detail in Section 10.1.1.

Observe \dagger -linear functors preserve \dagger -duals:

Lemma 8.6. *\dagger -linear functors preserve \dagger -duals.*

Proof. Let \mathbb{X} , and \mathbb{Y} be \dagger -LDCs. Let $(F_\otimes, F_\oplus) : \mathbb{X} \rightarrow \mathbb{Y}$ be a \dagger -linear functor. Then, for each object A , we have maps:

$$\mathbf{s}_A : F_\otimes(A^\dagger) \xrightarrow{\simeq} (F_\oplus(A))^\dagger \quad \mathbf{t}_A : (F_\otimes(A))^\dagger \xrightarrow{\simeq} F_\oplus(A^\dagger)$$

such that $(\mathbf{s}, \mathbf{t}) : (F_\otimes((-)^\dagger), (F_\oplus(-)^\dagger)) \Rightarrow ((F_\oplus(-))^\dagger, F_\otimes((-)^\dagger))$ is a linear natural isomorphism. We must prove that if $A \xrightarrow{\dagger} A^\dagger$ is a right \dagger -linear dual, then $F_\otimes(A)$ has a right \dagger -dual.

Suppose $A \xrightarrow{\dagger} A^\dagger$ is a right \dagger -dual. Since, linear functors preserve linear duals, $F_\otimes(A) \dashv$

with the isomorphisms which determine \dagger -dual, see the below diagram:

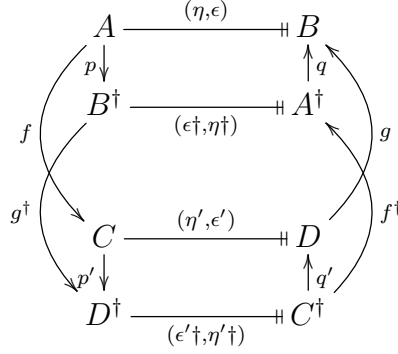

8.1.2 Linear monoids

In a linear setting with two distinct tensor products, Frobenius Algebras are generalized by linear monoids [62, 35]. The simplest way to describe a linear monoid is as a \otimes -monoid on an object together with a dual for that object. The similarity to Frobenius algebras becomes more apparent when one regards a linear monoid as a \otimes -monoid and a \oplus -comonoid with actions and coactions.

Definition 8.7. A **linear monoid**, $A \overset{\circ}{\dashv} B$, in an LDC consists of a monoid $(A, e : \top \rightarrow A, m : A \otimes A \rightarrow A)$, a left dual $(\eta_L, \epsilon_L) : A \dashv B$, and a right dual $(\eta_R, \epsilon_R) : B \dashv A$ such that:

$$\begin{array}{c} B \\ | \\ \circ \\ / \quad \backslash \\ B \quad B \end{array} := \begin{array}{c} B \\ | \\ \eta_L \\ | \\ \circ \\ / \quad \backslash \\ \epsilon_L \quad B \end{array} = \begin{array}{c} \eta_R \\ | \\ \circ \\ / \quad \backslash \\ B \quad \epsilon_R \end{array} \quad \begin{array}{c} B \\ | \\ \circ \\ | \\ \epsilon_L \end{array} := \begin{array}{c} B \\ | \\ \circ \\ | \\ \epsilon_L \end{array} = \begin{array}{c} B \\ | \\ \circ \\ | \\ \epsilon_R \end{array} \quad (8.3)$$

Note that, in a symmetric LDC, given a dual $(\eta_L, \epsilon_L) : A \dashv B$, any linear monoid $A \overset{\circ}{\dashv} B$, can be normalized to use the symmetric dual $(\eta_L c_{\oplus}, c_{\otimes}, \epsilon_L) : B \dashv A$. Suppose, in a symmetric LDC, $(\eta_L, \epsilon_L) : A \dashv B$, and $(\eta_R, \epsilon_R) : A \dashv B$ are cyclic duals, then:

$$\begin{array}{c} \eta_R \\ | \\ \circ \\ / \quad \backslash \\ B \quad A \\ | \\ \epsilon_L \end{array} = \left(\begin{array}{c} \eta_L \\ | \\ \circ \\ / \quad \backslash \\ A \quad B \\ | \\ \epsilon_R \end{array} \right)^{-1}$$

which is an isomorphism of duals:

$$\begin{array}{c} \eta_R \\ | \\ \circ \\ / \quad \backslash \\ A \quad B \\ | \\ \epsilon_R \end{array} = \begin{array}{c} \eta_L \\ | \\ \circ \\ / \quad \backslash \\ A \quad B \\ | \\ \epsilon_L \end{array} \quad \begin{array}{c} A \\ | \\ \eta_R \\ | \\ \circ \\ / \quad \backslash \\ B \quad A \\ | \\ \epsilon_L \end{array} = \begin{array}{c} A \\ | \\ \eta_L \\ | \\ \circ \\ / \quad \backslash \\ B \quad A \\ | \\ \epsilon_R \end{array}$$

Hence, in a symmetric LDC, for any linear monoid, one can assume that the duals are given using the symmetry map. A linear monoid is said to be **symmetric** when its duals are

symmetric. Section 10.1.2 discusses different examples of linear monoids.

An alternate form for linear monoids, which displays their similarity to Frobenius algebras, is:

Proposition 8.8. *A linear monoid, $A \overset{\circ}{\#} B$, in an LDC is equivalent to the following data:*

- a monoid $(A, \curlywedge : A \otimes A \rightarrow A, \curlyvee : \top \rightarrow A)$
- a comonoid $(B, \curlywedge : B \rightarrow B \oplus B, \curlyvee : B \rightarrow \perp)$
- actions, $\curlywedge : A \otimes B \rightarrow B, \curlyvee : B \otimes A \rightarrow B$, and coactions $\curlywedge : A \rightarrow B \oplus A, \curlyvee : A \rightarrow A \oplus B$,

such that the following axioms (and their ‘op’ and ‘co’ symmetric forms) hold:

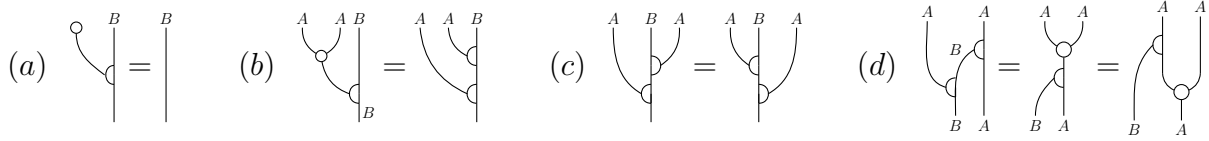

If the linear monoid is symmetric, then:

Proof. Suppose $A \overset{\circ}{\#} B$ is a linear monoid. Then, the comonoid on B is given by the left dual (or equivalently the right dual) of the monoid. The action and the coaction maps are defined as follows:

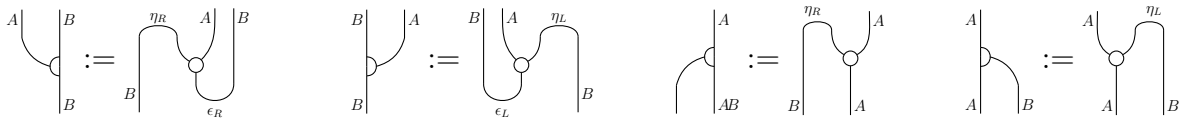

Equations (a)-(d) can be verified easily.

For the converse, the left and the right duals are defined as follows:

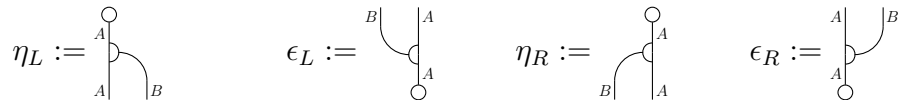

□

A linear monoid, $A \overset{\circ}{\#} B$, in a monoidal category gives a Frobenius Algebra when it is a self-linear monoid, that is $A = B$, and the dualities coincide with the self-dual cup, and the cap. Note that while a Frobenius Algebra is always on a self-dual object, a linear monoid allows Frobenius interaction between distinct dual objects.

Definition 8.9. A **morphism of linear monoids** is a pair of maps, $(f, g) : (A \overset{\circ}{\dashv} B) \rightarrow (A' \overset{\circ}{\dashv} B')$, such that $f : A \rightarrow A'$ is a monoid morphism (or equivalently $g : B' \rightarrow B$ is a comonoid morphism), and (f, g) and (g, f) preserves the left and the right duals respectively.

Note that a morphism of Frobenius algebras is usually given by a single monoid and comonoid morphism which has the effect of giving an isomorphism. However, the morphisms of linear monoids as in Definition 8.9, are not restricted to isomorphisms. Here, the comonoid morphism $g : B' \rightarrow B$, is the cyclic mate of the monoid morphism, $f : A \rightarrow A'$.

Definition 8.10. A **\dagger -linear monoid**, $(A, \varphi, \rho) \overset{\dagger}{\dashv} (A^\dagger, \rho, \delta)$, in a \dagger -LDC, is a linear monoid such that $(\eta_L, \epsilon_L) : A \dashv A^\dagger$, and $(\eta_R, \epsilon_R) : A^\dagger \dashv A$ are \dagger -duals and:

$$\begin{array}{c} | \\ A^\dagger \\ \circ \\ \epsilon_L \end{array} := \begin{array}{c} A^\dagger \\ \cup \\ \circ \\ \epsilon_L \end{array} = \begin{array}{c} \square \\ \circ \\ | \\ A^\dagger \end{array} \quad \begin{array}{c} | \\ A^\dagger \\ \circ \\ \epsilon_L \end{array} := \begin{array}{c} \eta_L \\ \cup \\ \circ \\ \epsilon_L \end{array} = \begin{array}{c} \square \\ \circ \\ | \\ A^\dagger \end{array} \quad (8.4)$$

In a \dagger -monoidal category, all \dagger -Frobenius algebras are also \dagger -linear monoids. However, the converse is not true. For example, in the category of complex Hilbert spaces and linear maps, the basic Weil Algebra $\mathbb{C}[x]/x^2 = 0$ is a commutative \dagger -linear monoid but not a \dagger -Frobenius Algebra. More examples are discussed in Section 10.1.2.

Definition 8.11. A \dagger -linear monoid is **twisted** if the dual of the multiplication coincides with the dagger of the multiplication but with a twist:

$$\begin{array}{c} | \\ A^\dagger \\ \circ \\ \epsilon_L \end{array} := \begin{array}{c} \eta_L \\ \cup \\ \circ \\ \epsilon_L \end{array} = \begin{array}{c} \square \\ \circ \\ | \\ A^\dagger \end{array} \quad (8.5)$$

In symmetric \dagger -LDCs, endomorphism monoids (pants monoids) is a twisted \dagger -linear monoid, see Section 8.1.3. Note that, every commutative \dagger -linear monoid is a twisted \dagger -linear monoid.

Following the same pattern as \dagger -duals, the \dagger -linear monoids can be classified as follows:

- a **(twisted) right \dagger -linear monoid** which is a linear monoid $A \overset{\circ}{\dashv} A^\dagger$ with left and right \dagger -duals such that the dual of the monoid is same as its (twisted) dagger,
- a **(twisted) left \dagger -linear monoid**, that is, a linear monoid $A^\dagger \overset{\circ}{\dashv} A$ with left and right \dagger -duals such that the dual of the comonoid is same as its (twisted) dagger, and
- a **general \dagger -linear monoid** which is a linear monoid $(A, \varphi, \rho) \overset{\circ}{\dashv} (B, \rho, \delta)$ satisfying one of the following three conditions:

- (i) $A \overset{\circ}{\dashv} B$ is isomorphic to its right \dagger -linear monoid via an isomorphism $(1_A, q) : A \overset{\circ}{\dashv} B \rightarrow A \overset{\dagger \circ}{\dashv} A^\dagger$,
 - (ii) $A \overset{\circ}{\dashv} B$ is isomorphic to its left \dagger -dual via an isomorphism $(p, 1_B) : B^\dagger \overset{\dagger \circ}{\dashv} B \rightarrow A \overset{\circ}{\dashv} B$, or
 - (iii) $A \overset{\circ}{\dashv} B$ is isomorphic to $B^\dagger \overset{\bullet}{\dashv} A^\dagger$ via an isomorphism (p, q) and $pq^\dagger = \iota_A$;
- a general \dagger -linear monoid is **twisted** if one of the following conditions hold:

- in condition (i), $q : (A^\dagger, \wp^\dagger, \wp^\dagger) \rightarrow (B, \wp, \wp)$ is a twisted comonoid morphism:

- in condition (ii), $p : (A, \wp, \wp) \rightarrow (B^\dagger, \wp^\dagger, \wp^\dagger)$ is a twisted monoid morphism:

- in condition (iii), either p is twisted monoid morphism, or q is a twisted comonoid morphism.

In condition (i) for a general \dagger -linear monoid, the identity map completely determines q . Hence, we observe that the existence of a right \dagger -linear monoid is all that is needed for any linear monoid to be a \dagger -linear monoid. By Lemma 8.12, the observation extends to twisted \dagger -linear monoids too: the existence of a twisted right \dagger -linear monoid is all that is needed any linear monoid to be a twisted \dagger -linear monoid.

A linear monoid has a twisted isomorphism to its right (or left) \dagger -linear monoid if and only if the right (or the left) \dagger -linear monoid is twisted:

Lemma 8.12. *In a \dagger -LDC, let $(\eta, \epsilon) : (A, \wp, \wp) \overset{\circ}{\dashv} (B, \wp, \wp)$ be a linear monoid with an isomorphism its right \dagger -linear monoid:*

$$\begin{array}{ccc}
 (A, \wp, \wp) & \xrightarrow{(\eta, \epsilon) \circ} & (B, \wp, \wp) \\
 \parallel & & \uparrow q \\
 (A, \wp, \wp) & \xrightarrow{\dagger(\tau, \gamma) \circ} & (A^\dagger, \wp^\dagger, \wp^\dagger)
 \end{array}$$

The isomorphism $(1, q)$ is twisted, that is, q is a twisted comonoid morphism if and only if $A \overset{\dagger \circ}{\dashv} A^\dagger$ is a twisted \dagger -linear monoid.

Proof. Assume that q is a twisted monoid morphism. Then, $A \xrightarrow{\dagger\circ} A^\dagger$ is a twisted \dagger -linear monoid because:

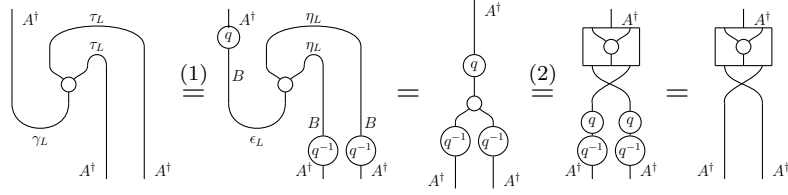

Step (1) is true because $(1, q)$ is a morphism of the underlying duals. Step (2) holds because q is a twisted comonoid morphism.

For the converse, assume that $(\tau, \gamma) : A \xrightarrow{\dagger\circ} A^\dagger$ is a twisted right \dagger -linear monoid. Then, q is a twisted comonoid morphism because:

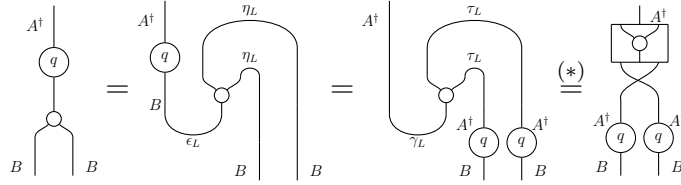

Step (*) is true because A is a twisted right \dagger -linear monoid. □

Next we note that \dagger -linear monoids are preserved by \dagger -linear functor:

Lemma 8.13. *\dagger -linear functors preserve (twisted) \dagger -linear monoids.*

Proof. Suppose $(F_\otimes, F_\oplus) : \mathbb{X} \rightarrow \mathbb{Y}$ is a \dagger -linear functor, and $A \xrightarrow{\dagger\circ} A^\dagger$ is a dagger-linear monoid in \mathbb{X} . Since, linear functors preserve linear monoids, $F_\otimes(A) \xrightarrow{\circ} F_\oplus(A^\dagger)$ is a linear monoid.

To prove that $F_\otimes(A)$ is a right \dagger -linear monoid, define the multiplication, unit, comultiplication, counit, action and coaction maps are given as follows:

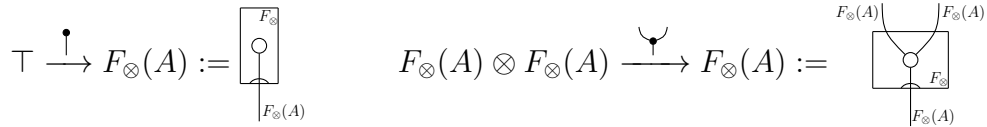

Define:

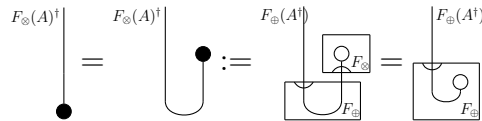

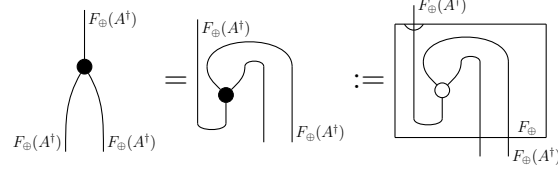

It remains to prove that:

- The counit is the dagger of the unit map:

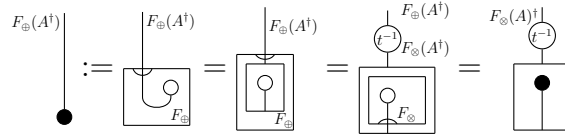

- The comultiplication is the dagger of the multiplication map:

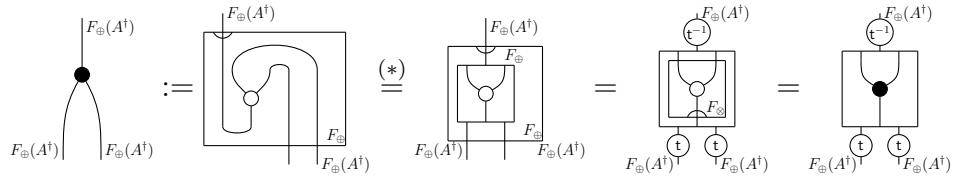

Observe that in step (*), a twist is introduced if the \dagger -linear monoid is twisted.

□

A morphism of (twisted) \dagger -linear monoids, follow the same pattern as a morphism of \dagger -duals:

Definition 8.14. A morphism of (twisted) \dagger -linear monoids is defined to be one of the following:

- For (twisted) **right** \dagger -linear monoids, it is a pair of maps (f, f^\dagger) which is a morphism of underlying linear monoids.
- For (twisted) **left** \dagger -linear monoids, it is a pair of maps (f^\dagger, f) which is a morphism of underlying linear monoids.
- For (twisted) **general** \dagger -linear monoids, it is a pair $(f, g) : A \xrightarrow{\dagger_{\oplus}} B \rightarrow C \xrightarrow{\dagger_{\oplus}} D$ such that (f, g) is a morphism of underlying linear monoids such that one of the following equivalent diagrams commute:

$$(a) \quad \begin{array}{ccc} C^\dagger & \xrightarrow{f^\dagger} & A^\dagger \\ q' \downarrow & & \downarrow q \\ D & \xrightarrow{g} & B \end{array} \quad (or) \quad (b) \quad \begin{array}{ccc} A & \xrightarrow{f} & C \\ p \downarrow & & \downarrow p' \\ B^\dagger & \xrightarrow{g^\dagger} & D^\dagger \end{array} \quad (8.6)$$

where (p, q) is the isomorphism between the linear monoid $A \overset{\circ}{\#} B$ and its dagger $B^\dagger \overset{\circ}{\#} A^\dagger$, and (p', q') is an isomorphism between the linear monoid $C \overset{\bullet}{\#} D$ and its dagger $D^\dagger \overset{\bullet}{\#} C^\dagger$ (as per the condition satisfied by a general \dagger -linear monoid).

In the commuting diagram (a), $f^\dagger : C^\dagger \rightarrow A^\dagger$ is a morphism between the dagger comonoids, and $g : D \rightarrow B$ is a morphism between the dual comonoids. If the given \dagger -linear monoids are twisted, then q and q' are twisted comonoid morphisms. Dually, in the commuting diagram (b), $f : A \rightarrow C$ is a monoid morphism, and $g^\dagger : B^\dagger \rightarrow D^\dagger$ is a morphism between the conjugate monoids. If the given \dagger -linear monoids are twisted, then the morphisms p and p' are twisted monoid morphisms.

8.1.3 The endomorphism linear monoid

In Section 6.4.1, we discussed the pants \dagger -Frobenius algebras in \dagger -KCCs. For an object A in a KCC, the dual structure of A induces a pants algebra a.k.a. an endomorphism monoid on the object $A \otimes A^*$. If the KCC is symmetric, then pants algebras are Frobenius. Moreover, in a \dagger -KCC, these algebras are \dagger -Frobenius. In this section, we present analogue of a pants algebra in \dagger -LDCs.

Lemma 8.15. *In an LDC, every dual $(\eta_L, \epsilon_L) : A \# B : (\eta_R, \epsilon_R)$ induces a linear monoid: $(\tau, \gamma) : (A \oplus B) \overset{\bullet}{\#} (A \otimes B)$:*

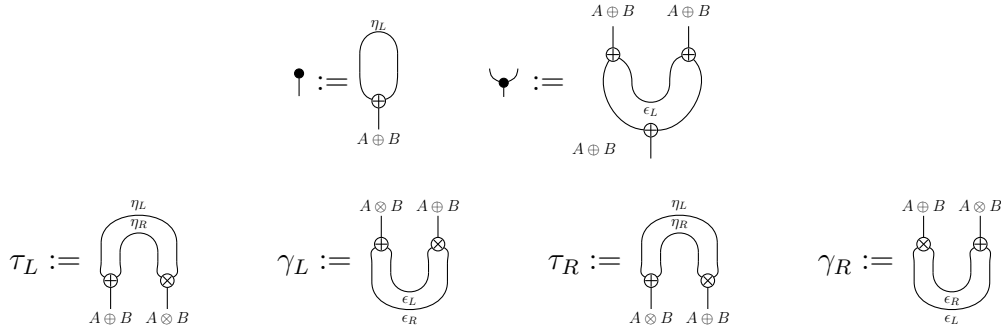

In a symmetric LDC, every dual automatically induces a pants linear monoid as shown in the previous lemma. Every linear monoid embeds into its pants linear monoids:

Lemma 8.16. *In an LDC, every linear monoid embeds into the pants linear monoids induced by its left and right duals.*

Proof. Suppose $A \overset{\circ}{\#} B$ is a linear monoid containing a monoid $(A, \curlywedge, \curlyvee)$, a left dual $(\eta_L, \epsilon_L) : A \# B$, and a right dual $(\eta_R, \epsilon_R) : A \# B$. The left and the right duals gives two pants linear monoids, $(\tau, \gamma) : (A \oplus B) \overset{\circ}{\#} (A \otimes B)$, and $(\tau', \gamma') : (B \oplus A) \overset{\bullet}{\#} (B \otimes A)$ as shown in Lemma 8.15.

In order to prove that $A \overset{\circ}{\#} B$ embeds into its pants linear monoids, we must show that there exist morphisms of linear monoids, (R, S) and (R', S') , and that these morphisms are left-invertible:

$$\begin{array}{ccc} A & \overset{\circ}{\#} & B \\ R \downarrow & & \uparrow S \\ A \oplus B & \overset{\bullet}{\#} & A \otimes B \end{array} \qquad \begin{array}{ccc} A & \overset{\circ}{\#} & B \\ R' \downarrow & & \uparrow S' \\ B \oplus A & \overset{\bullet}{\#} & B \otimes A \end{array}$$

We first prove that $(\eta, \epsilon) : A \overset{\circ}{\#} B$ embeds into $(\tau, \gamma) : (A \oplus B) \overset{\circ}{\#} (A \otimes B)$.

Define $R : A \rightarrow A \oplus B$ and $S : A \otimes B \rightarrow A$ as follows:

$$\begin{array}{ccc} \begin{array}{c} A \\ | \\ \textcircled{R} \\ | \\ A \oplus B \end{array} & := & \begin{array}{c} A \quad \eta_L \\ | \quad / \\ \textcircled{} \\ | \quad \backslash \\ A \quad B \end{array} \end{array} \qquad \begin{array}{ccc} \begin{array}{c} A \quad B \\ \backslash \quad / \\ \textcircled{S} \\ | \\ B \end{array} & := & \begin{array}{c} A \quad B \\ | \quad / \\ \textcircled{} \\ | \quad \backslash \\ \eta_R \quad B \end{array} \end{array}$$

where,

$$\begin{array}{ccc} \begin{array}{c} B \\ | \\ \textcircled{} \\ | \\ B \end{array} & := & \begin{array}{c} B \quad \eta_L \\ | \quad / \\ \textcircled{} \\ | \quad \backslash \\ \epsilon_L \quad B \end{array} = \begin{array}{c} B \quad \eta_R \\ | \quad / \\ \textcircled{} \\ | \quad \backslash \\ B \quad \epsilon_R \end{array} \end{array}$$

We prove that $R : (A, \varphi, \circlearrowleft) \rightarrow (A \oplus B, \varphi, \bullet)$ is a monoid morphism.

R preserves the unit:

$$\begin{array}{ccc} \begin{array}{c} \circ \\ | \\ \textcircled{R} \\ | \\ A \oplus B \end{array} & := & \begin{array}{c} \circ \quad \eta_L \\ | \quad / \\ \textcircled{} \\ | \quad \backslash \\ A \quad B \end{array} = \begin{array}{c} \circ \quad \eta_L \\ | \\ A \oplus B \end{array} = \begin{array}{c} \bullet \\ | \\ B \end{array} \end{array}$$

R preserves the multiplication:

$$\begin{array}{ccc} \begin{array}{c} \textcircled{R} \quad \textcircled{R} \\ | \quad | \\ \epsilon_L \end{array} & := & \begin{array}{c} \eta_L \quad \eta_L \\ / \quad \backslash \\ \textcircled{} \quad \textcircled{} \\ | \quad | \\ \epsilon_L \end{array} = \begin{array}{c} \eta_L \\ / \quad \backslash \\ \textcircled{} \\ | \\ B \end{array} = \begin{array}{c} \eta_L \\ / \quad \backslash \\ \textcircled{} \\ | \\ A \quad B \end{array} = \begin{array}{c} \eta_L \\ / \quad \backslash \\ \textcircled{} \\ | \\ A \quad B \end{array} = \begin{array}{c} \textcircled{R} \\ | \\ B \end{array} \end{array}$$

Finally, $(R, S) : ((\eta_L, \epsilon_L) : A \# B) \rightarrow ((\tau_L, \gamma_L) : (A \oplus B) \# (A \otimes B))$ is a morphism of duals:

$$\begin{array}{ccc} \begin{array}{c} \eta_L \quad \eta_R \\ / \quad \backslash \\ \textcircled{} \quad \textcircled{} \\ | \quad | \\ A \oplus B \quad A \otimes B \end{array} & := & \begin{array}{c} \eta_L \quad \eta_R \\ / \quad \backslash \\ \textcircled{} \quad \textcircled{} \\ | \quad | \\ A \oplus B \quad B \end{array} = \begin{array}{c} \eta_L \\ / \quad \backslash \\ \textcircled{} \\ | \\ B \end{array} = \begin{array}{c} \eta_L \\ / \quad \backslash \\ \textcircled{} \\ | \\ A \quad B \end{array} = \begin{array}{c} \eta_L \\ / \quad \backslash \\ \textcircled{} \\ | \\ A \quad B \end{array} = \begin{array}{c} \eta_L \\ / \quad \backslash \\ \textcircled{} \\ | \\ A \quad B \end{array} = \begin{array}{c} \eta_L \\ / \quad \backslash \\ \textcircled{R} \\ | \\ B \end{array} \end{array}$$

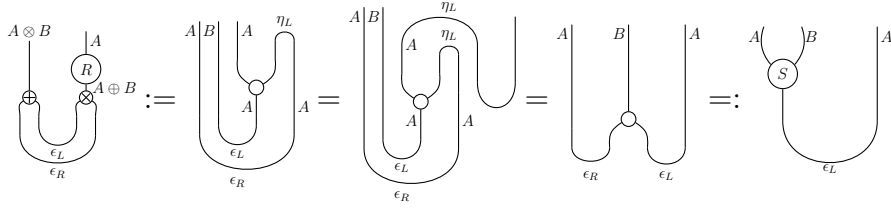

Similarly, we can prove that $(S, R) : ((\tau_R, \gamma_R) : (A \otimes B) \dashv\vdash (A \oplus B)) \rightarrow ((\eta_R, \epsilon_R) : B \dashv\vdash A)$ is a morphism of duals.

To prove that R is an embedding, it remains to prove that R is left invertible, that is, there exists (M, N) such that $(R, S)(M, N) := (RM, NS) = (1_A, 1_B)$:

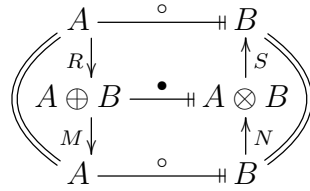

Define:

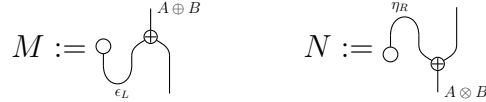

It is easy to verify that $RM = 1_A$ and $NS = 1_B$. Thus, $(\eta, \epsilon) : A \dashv\vdash B$ embeds into $(\tau, \gamma) : (A \oplus B) \dashv\vdash (A \otimes B)$. The proof that $(\eta, \epsilon) : A \dashv\vdash B$ embeds into $(\tau, \gamma) : (A \oplus B) \dashv\vdash (A \otimes B)$ is the mirror reflection of the above proof. \square

In a symmetric \dagger -LDC, It turns out that the pants “monoid” is a *twisted* \dagger -linear monoid, see 8.11: thus, the comultiplication is the dagger of the multiplication but with a twist (using the symmetry map).

In a symmetric \dagger -LDC, a twisted \dagger -linear monoid embeds into the pants \dagger -linear monoid.

Lemma 8.17. *In a symmetric \dagger -LDC, if $(\eta, \epsilon) : A \dashv\vdash A^\dagger$ is a \dagger -dual then the pants monoid $(\tau, \gamma) : (A \oplus A^\dagger) \dashv\vdash (A \otimes A^\dagger)$ is a twisted \dagger -linear monoid.*

Proof. In order to prove that $(\tau, \gamma) : (A \oplus A^\dagger) \dashv\vdash (A \otimes A^\dagger)$ is a \dagger -linear monoid, we show that there exists a linear monoid morphism (p, q) as shown below such that p and q are isomorphisms, and $pq^\dagger = \iota$:

$$\begin{array}{ccc} A \oplus A^\dagger & \xrightarrow{(\tau, \gamma)} & A \otimes A^\dagger \\ p \downarrow & & \uparrow q \\ (A \otimes A^\dagger)^\dagger & \xrightarrow{(\gamma^\dagger, \tau^\dagger)} & (A \oplus A^\dagger)^\dagger \end{array}$$

Moreover, to show that the \dagger -linear monoid is twisted, we must prove that p is a twisted monoid morphism (or equivalently q is a twisted comonoid morphism). A monoid morphism

$f : (A, m, u) \rightarrow (B, m', u')$ in an LDC is said to be twisted if $(f \otimes f)m = c_{\otimes} m' f$.

The maps p and q as follows:

$$p := A \oplus A^\dagger \xrightarrow{\iota_{\oplus} 1} A^{\dagger\dagger} \oplus A^\dagger \xrightarrow{c_{\otimes}} A^\dagger \oplus A^{\dagger\dagger} \xrightarrow{\lambda_{\oplus}} (A \otimes A^\dagger)^\dagger$$

$$q := (A \oplus A^\dagger)^\dagger \xrightarrow{\lambda_{\otimes}^{-1}} A^\dagger \otimes A^{\dagger\dagger} \xrightarrow{1 \otimes i^{-1}} A^\dagger \otimes A \xrightarrow{c_{\otimes}} A \otimes A^\dagger$$

Diagrammatically,

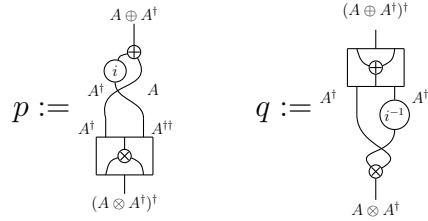

Note that p and q are isomorphisms. We must prove that $pq^\dagger = \iota$:

$$\begin{aligned} pq^\dagger &= (\iota_A \oplus 1)(c_{\oplus})_{A^{\dagger\dagger}, A} (\lambda_{\oplus})_{A^\dagger, A^{\dagger\dagger}} ((\lambda_{\oplus})_{A^\dagger, A^{\dagger\dagger}}^{-1} (1 \otimes \iota_A^{-1})(c_{\otimes})_{A, A^\dagger})^\dagger \\ &= (\iota_A \oplus 1)(c_{\oplus})_{A^{\dagger\dagger}, A} (\lambda_{\oplus})_{A^\dagger, A^{\dagger\dagger}} (c_{\otimes})_{A, A^\dagger}^\dagger (1 \otimes \iota_A^{-1})^\dagger (\lambda_{\oplus}^{-1})_{A^\dagger, A^{\dagger\dagger}}^\dagger \\ &= (\iota_A \oplus 1)(c_{\oplus})_{A^{\dagger\dagger}, A} (c_{\oplus})_{A^\dagger, A^{\dagger\dagger}} (\lambda_{\oplus})_{A^{\dagger\dagger}, A^\dagger} (1 \otimes \iota_A^{-1})^\dagger (\lambda_{\oplus}^{-1})_{A^\dagger, A^{\dagger\dagger}}^\dagger \\ &\stackrel{[\dagger\text{-LDC}]-7}{=} (\iota_A \oplus 1)(\lambda_{\oplus})_{A^{\dagger\dagger}, A^\dagger} (1 \otimes \iota_A^{-1})^\dagger (\lambda_{\oplus}^{-1})_{A^\dagger, A^{\dagger\dagger}}^\dagger \\ &\stackrel{Nat.}{=} \lambda_{\oplus} (\iota_A \oplus 1)(1 \oplus i_A^{-1\dagger})(\lambda_{\oplus})(\lambda_{\otimes}^{-1})^\dagger \\ &\stackrel{\iota_A^{-1\dagger} = \iota_{A^\dagger}}{=} (\iota_A \oplus \iota_{A^\dagger})(\lambda_{\oplus})(\lambda_{\otimes}^{-1})^\dagger \\ &\stackrel{[\dagger\text{-LDC}]-4}{=} \iota \end{aligned}$$

It remains to show that (p, q) is a twisted linear monoid morphism for which we prove that q is a twisted comonoid morphism and (p, q) is a morphism of the underlying duals. Recall that the linear monoid $(\tau, \gamma) : (A \oplus A^\dagger) \overset{\circ}{\dashv} (A \otimes A^\dagger)$ is given as follows: Showing that the q preserves the counit:

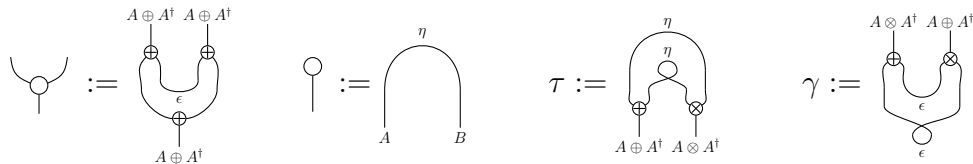

The comonoid $(A \otimes A^\dagger, \rho, \delta)$ is the dual of the monoid $A \oplus A^\dagger$ using the τ and the γ :

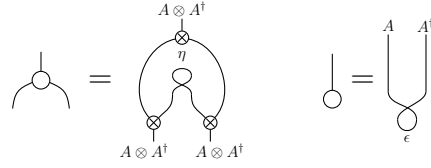

The linear monoid $(\gamma^\dagger, \tau^\dagger) : (A \otimes A^\dagger)^\dagger \dashv_{\oplus} (A \oplus A^\dagger)^\dagger$ is the dagger of $(\tau, \gamma) : (A \oplus A^\dagger) \dashv_{\otimes} (A \otimes A^\dagger)$. The following is the proof that $q : ((A \oplus A^\dagger)^\dagger, \rho, \delta) \rightarrow ((A \otimes A^\dagger), \rho, \delta)$ is twisted comonoid morphism.

Showing that q preserves the counit:

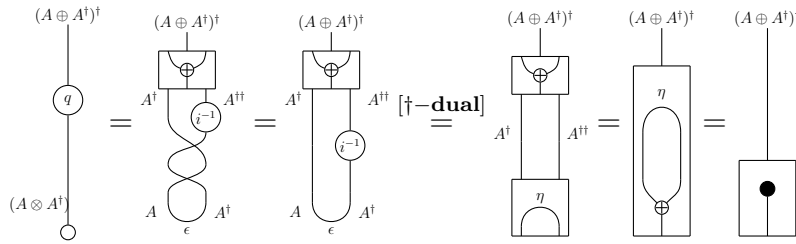

Showing that q preserves the comultiplication but with a twist:

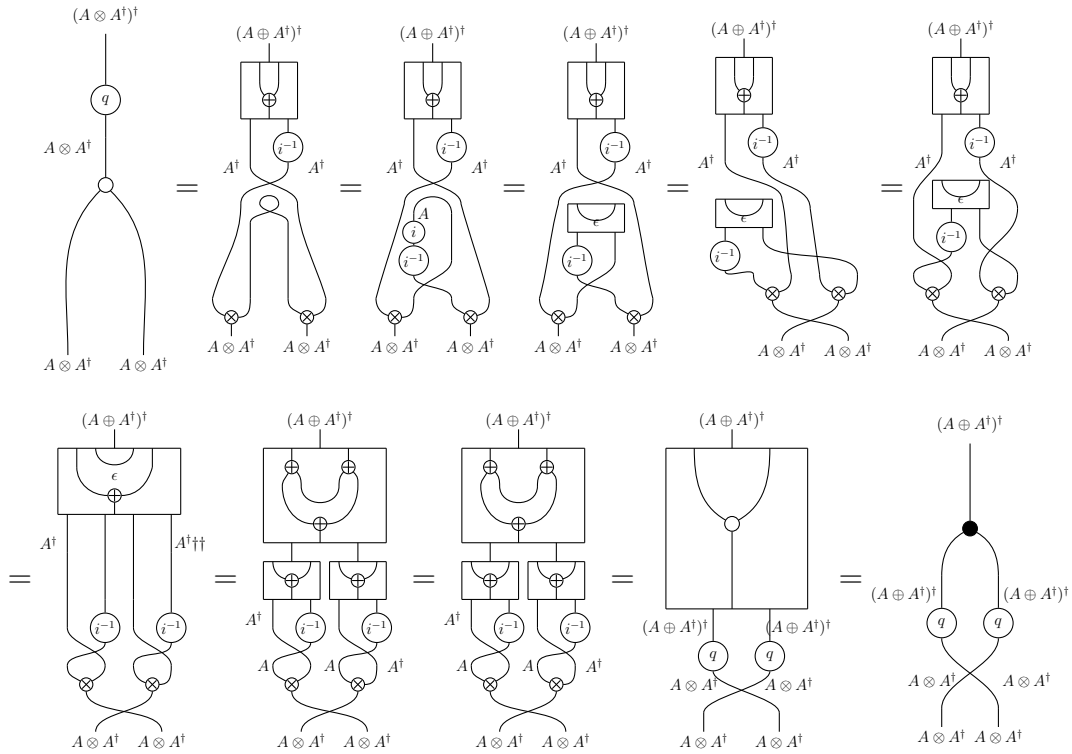

It remains to prove that (p, q) is a morphism of duals:

$$\begin{array}{ccc} A \oplus A^\dagger & \xrightarrow{(\tau, \gamma)} & A \otimes A^\dagger \\ p \downarrow & & \uparrow q \\ (A \otimes A^\dagger)^\dagger & \xrightarrow{(\gamma^\dagger, \tau^\dagger)} & (A \oplus A^\dagger)^\dagger \end{array}$$

The proof is as follows:

□

It is simultaneously surprising and unsurprising that the pants \dagger -linear monoid is twisted in \dagger -LDCs. A twist is expected because bending the wires of a multiplication into a comultiplication changes the original order of the wires while daggering does not have this effect (equivalently conjugation reverses the tensor product: $\overline{A \otimes B} \simeq \overline{B} \otimes \overline{A}$). However, in \dagger -KCCs, the pants \dagger -FAs are not twisted, because the \dagger -duals are already equipped with a twist ($\eta^\dagger = c_\otimes \epsilon$) which untwists the pants \dagger -FA.

Lemma 8.18. *In a symmetric \dagger -LDC, every twisted \dagger -linear monoid embeds into its pants \dagger -linear monoid.*

Proof. In Lemma 8.16, we showed that there exists a left invertible map, (R, S) , for every linear monoid into its pants monoids. Let $A \xrightarrow{\circ} A^\dagger$ be a twisted \dagger -linear monoid.

$$\begin{array}{ccc} A & \xrightarrow{\circ} & A^\dagger \\ R \downarrow & & \uparrow S \\ A \oplus A^\dagger & \xrightarrow{\bullet} & A \otimes A^\dagger \end{array}$$

where, $R : A \rightarrow A \oplus A^\dagger$ and $S : A \otimes A^\dagger \rightarrow A$ are defined as follows:

$$\begin{array}{c}
 \begin{array}{c} A \\ | \\ \textcircled{R} \\ | \\ A \end{array} \oplus \begin{array}{c} B \\ | \\ \textcircled{R} \\ | \\ B \end{array} \\
 := \\
 \begin{array}{c} A \\ | \\ \eta \\ | \\ A \end{array} \oplus \begin{array}{c} B \\ | \\ \epsilon \\ | \\ B \end{array}
 \end{array}
 \qquad
 \begin{array}{c}
 \begin{array}{c} A \\ | \\ \textcircled{S} \\ | \\ B \end{array} \otimes \begin{array}{c} B \\ | \\ \textcircled{S} \\ | \\ B \end{array} \\
 := \\
 \begin{array}{c} A \\ | \\ \epsilon \\ | \\ A \end{array} \otimes \begin{array}{c} B \\ | \\ \eta \\ | \\ B \end{array}
 \end{array}$$

To prove that every twisted \dagger -linear monoid embeds into its pants \dagger -linear monoid, it suffices to prove that (R, S) is a morphism of twisted \dagger -linear monoids.

From Lemma 8.17, we have that (p, q) is an isomorphism of linear monoids:

$$\begin{array}{ccc}
 A \oplus A^\dagger & \xrightarrow{(\tau, \gamma)} & A \otimes A^\dagger \\
 p \downarrow & & \uparrow q \\
 (A \otimes A^\dagger)^\dagger & \xrightarrow{(\gamma^\dagger, \tau^\dagger)} & (A \oplus A^\dagger)^\dagger
 \end{array}$$

where the maps p and q are given diagrammatically as follows:

$$\begin{array}{c}
 \begin{array}{c} A \oplus A^\dagger \\ | \\ \oplus \\ | \\ A^\dagger \oplus A \\ | \\ \otimes \\ | \\ (A \otimes A^\dagger)^\dagger \end{array} \\
 p := \\
 \begin{array}{c} (A \oplus A^\dagger)^\dagger \\ | \\ \boxplus \\ | \\ A^\dagger \oplus A \\ | \\ \otimes \\ | \\ A \otimes A^\dagger \end{array} \\
 q :=
 \end{array}$$

In order to prove that (R, S) is a morphism of twisted \dagger -linear monoids, we must prove that $qS = R^\dagger$ or $Rp = S^\dagger$ (See Definition 8.14):

$$\begin{array}{c}
 (A \oplus A^\dagger)^\dagger \\
 | \\
 \boxplus \\
 | \\
 A^\dagger \oplus A \\
 | \\
 \otimes \\
 | \\
 (A \otimes A^\dagger)^\dagger \\
 | \\
 \epsilon \\
 | \\
 A^\dagger \\
 qS = \\
 \begin{array}{c} (A \oplus A^\dagger)^\dagger \\ | \\ \boxplus \\ | \\ A^\dagger \oplus A \\ | \\ \otimes \\ | \\ (A \otimes A^\dagger)^\dagger \\ | \\ \epsilon \\ | \\ A^\dagger \end{array} \\
 \stackrel{(1)}{=} \\
 \begin{array}{c} (A \oplus A^\dagger)^\dagger \\ | \\ \boxplus \\ | \\ A^\dagger \oplus A \\ | \\ \otimes \\ | \\ (A \otimes A^\dagger)^\dagger \\ | \\ \epsilon \\ | \\ A^\dagger \end{array} \\
 = \\
 \begin{array}{c} (A \oplus A^\dagger)^\dagger \\ | \\ \boxplus \\ | \\ A^\dagger \oplus A \\ | \\ \otimes \\ | \\ (A \otimes A^\dagger)^\dagger \\ | \\ \epsilon \\ | \\ A^\dagger \end{array} \\
 \stackrel{(2)}{=} \\
 \begin{array}{c} (A \oplus A^\dagger)^\dagger \\ | \\ \boxplus \\ | \\ A^\dagger \oplus A \\ | \\ \otimes \\ | \\ (A \otimes A^\dagger)^\dagger \\ | \\ \epsilon \\ | \\ A^\dagger \end{array} \\
 = \\
 \begin{array}{c} (A \oplus A^\dagger)^\dagger \\ | \\ \boxplus \\ | \\ A^\dagger \oplus A \\ | \\ \otimes \\ | \\ (A \otimes A^\dagger)^\dagger \\ | \\ \epsilon \\ | \\ A^\dagger \end{array} \\
 = \\
 \begin{array}{c} (A \oplus A^\dagger)^\dagger \\ | \\ \boxplus \\ | \\ A^\dagger \oplus A \\ | \\ \otimes \\ | \\ (A \otimes A^\dagger)^\dagger \\ | \\ \epsilon \\ | \\ A^\dagger \end{array} \\
 = \\
 \begin{array}{c} (A \oplus A^\dagger)^\dagger \\ | \\ \boxplus \\ | \\ A^\dagger \oplus A \\ | \\ \otimes \\ | \\ (A \otimes A^\dagger)^\dagger \\ | \\ \epsilon \\ | \\ A^\dagger \end{array} \\
 = R^\dagger
 \end{array}$$

Step (1) holds because A is a twisted \dagger -linear monoid. Step (2) holds because A is a \dagger -dual. □

8.1.4 Being Frobenius

Linear monoids generalize Frobenius algebras from monoidal categories to LDCs. In 2.18, it has been proved that there exists a linear equivalence between compact LDCs and monoidal categories. Thus, it is useful to know the precise conditions under which a linear monoid in a compact LDC is a Frobenius algebra in the equivalent monoidal category. In this section we

develop these conditions and extend them to show the correspondence between \dagger -Frobenius algebras and \dagger -linear monoids.

Lemma 8.19. *In an LDC, the following conditions (and their ‘op’ symmetries) are equivalent for a self-linear monoid $A \overset{\circ}{\boxplus} A'$ with $\alpha : A \rightarrow A'$ being an isomorphism.*

(a) *The isomorphism α coincides with the following maps:*

$$\begin{array}{c} A \\ | \\ \alpha \\ | \\ A' \end{array} = \begin{array}{c} A \\ \eta_L \\ \circlearrowleft \\ \alpha \\ \circlearrowright \\ A' \end{array} = \begin{array}{c} \eta_R \\ \circlearrowleft \\ \alpha \\ \circlearrowright \\ A' \\ | \\ A \end{array} \quad (8.7)$$

(b) *The coaction maps given by the comultiplication and the linear duality coincides with the comultiplication:*

$$\begin{array}{c} A \\ \cup \\ A \end{array} = \begin{array}{c} \alpha \\ \cup \\ \epsilon_L \\ \alpha^{-1} \end{array} = \begin{array}{c} \eta_L \\ \cup \\ \alpha^{-1} \\ \cup \\ \epsilon_R \end{array} \quad (8.8)$$

(c) *The self-dual cup and cap coincide with the cups and the caps of the duals given in the linear monoid:*

$$\begin{array}{c} A \\ \cup \\ \alpha \\ \cap \\ A' \end{array} = \begin{array}{c} A \\ \alpha \\ \cup \\ \epsilon_L \\ A' \end{array} = \begin{array}{c} A \\ \cup \\ \epsilon_R \\ \alpha \\ A' \end{array} \quad (8.9)$$

Proof. For (a) \Rightarrow (b), substitute α in (b) using 8.7.

$$\begin{array}{c} \alpha \\ \cup \\ \epsilon_L \\ \alpha^{-1} \end{array} = \begin{array}{c} A \\ \eta_L \\ \alpha \\ \eta_L \\ A' \end{array} = \begin{array}{c} A \\ \eta_L \\ \alpha \\ \eta_L \\ A' \end{array} = \begin{array}{c} A \\ \eta_L \\ \alpha \\ \eta_L \\ A' \end{array} = \begin{array}{c} \cup \\ \alpha \\ \cup \\ \alpha^{-1} \end{array} = \begin{array}{c} \cup \end{array}$$

(b) \Rightarrow (c), and (c) \Rightarrow (a) are straightforward. □

In a compact LDC, a linear monoid satisfying one of the conditions in the previous Lemma, precisely corresponds to a Frobenius Algebra:

Lemma 8.20. *In a compact LDC, a self-linear monoid, $A \overset{\circ}{\boxplus} A'$ with an isomorphism $\alpha : A \rightarrow A'$ precisely corresponds to a Frobenius algebra under the linear equivalence, \mathbf{Mx}_{\downarrow} if and only if the following equation holds.*

$$\begin{array}{c} A \\ | \\ \alpha \\ | \\ A' \end{array} = \begin{array}{c} A \\ \eta_L \\ \circlearrowleft \\ \alpha \\ \circlearrowright \\ A' \end{array} = \begin{array}{c} \eta_R \\ \circlearrowleft \\ \alpha \\ \circlearrowright \\ A' \\ | \\ A \end{array} \quad (8.10)$$

Theorem 5.28] in \dagger -monoidal categories.

8.2 Linear comonoids

Our motive behind defining \dagger -linear monoids is to describe complementary systems in a \dagger -LDC setting. The bialgebra law is a central ingredient of complementary systems. The directionality of the linear distributors in an LDC makes a bialgebraic interaction between two linear monoids impossible. A linear monoid, however, can interact bialgebraically with a linear comonoid.

Definition 8.22. A linear comonoid, $A \dashv B$, in an LDC consists of a \otimes -comonoid, (A, \rhd, \lrcorner) , and a left and a right dual, $(\eta_L, \epsilon_L) : A \dashv B$, and $(\eta_R, \epsilon_R) : B \dashv A$, such that:

$$(a) \quad \begin{array}{c} B \oplus B \\ \circlearrowleft \\ \circlearrowright \\ \downarrow \\ B \end{array} := \begin{array}{c} B \oplus B \\ \circlearrowleft \\ \eta_L \\ \circlearrowright \\ A \\ \downarrow \\ B \end{array} = \begin{array}{c} \eta_R \\ \circlearrowleft \\ A \\ \downarrow \\ B \end{array} \begin{array}{c} \circlearrowleft \\ B \oplus B \\ \circlearrowright \end{array} \quad (b) \quad \begin{array}{c} \perp \\ \circlearrowleft \\ \downarrow \\ B \end{array} := \begin{array}{c} \eta_L \\ \circlearrowleft \\ A \\ \downarrow \\ \perp \\ \circlearrowright \\ B \end{array} = \begin{array}{c} \eta_R \\ \circlearrowleft \\ A \\ \downarrow \\ \perp \\ \circlearrowright \\ B \end{array} \quad (8.12)$$

Note that while a linear monoid has a \otimes -monoid and a \oplus -comonoid, a linear comonoid has a \otimes -comonoid and a \oplus -monoid. The commuting diagram for Equation 8.12(b) is as follows. Note that the diagram includes the unitors and linear distributors.

$$\begin{array}{ccccc} \perp & \xrightarrow{u_{\otimes}^{-1}} & \top \otimes \perp & \xrightarrow{\eta' \otimes 1} & (A \oplus B) \otimes \perp & \xrightarrow{\partial^r} & B \oplus (A \otimes \perp) \\ u_{\otimes}^{-1} \downarrow & & & & & & \downarrow 1 \oplus (e \otimes 1) \\ \perp \otimes \top & & & & & & B \oplus (\top \otimes \perp) \\ 1 \otimes \eta \downarrow & & & & & & \downarrow 1 \oplus u_{\otimes} \\ \perp \otimes (A \oplus B) & & & & & & B \oplus \perp \\ \partial^l \downarrow & & & & & & \downarrow u_{\oplus} \\ (\perp \otimes A) \oplus B & \xrightarrow{(1 \otimes e) \oplus 1} & (\perp \otimes \top) \oplus B & \xrightarrow{u_{\otimes} \oplus 1} & \perp \oplus B & \xrightarrow{u_{\oplus}} & B \end{array} \quad \text{LHS=RHS}$$

Similar to a linear monoid, however only in an isomix setting, a linear comonoid allows for Frobenius interaction between its \otimes -monoid and \oplus -comonoid:

Lemma 8.23. A linear comonoid, $A \dashv B$, in an isomix category is equivalent to the following data:

- a monoid $(B, \wp : B \oplus B \rightarrow B, \wp : \perp \rightarrow B)$
- a comonoid $(A, \rhd : A \rightarrow A \otimes A, \lrcorner : A \rightarrow \top)$
- actions, $\swarrow : B \otimes A \rightarrow A$, $\searrow : A \otimes B \rightarrow A$, and

$$\text{coactions } \begin{array}{|} \circlearrowleft \\ \hline \end{array} : B \rightarrow A \oplus B, \begin{array}{|} \circlearrowright \\ \hline \end{array} : B \rightarrow B \oplus A,$$

such that the following axioms (and their ‘op’ and ‘co’ symmetric forms) hold:

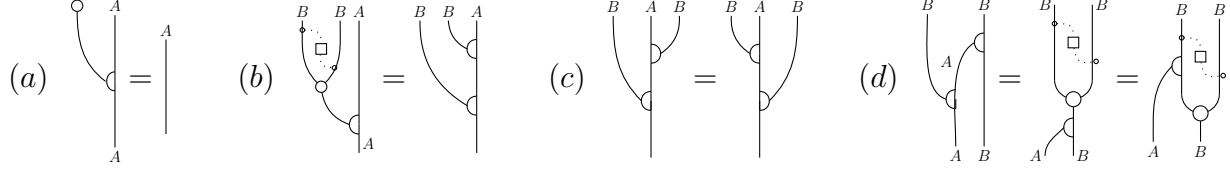

Proof. Given that $A \multimap B$ is a linear comonoid. Then, $(A, \circlearrowleft, \circlearrowright)$ is a \otimes -comonoid and there exists duals $(\eta_L, \epsilon_L) : A \dashv B$, and $(\eta_R, \epsilon_R) : B \dashv A$.

The \oplus -monoid on B is given as follows:

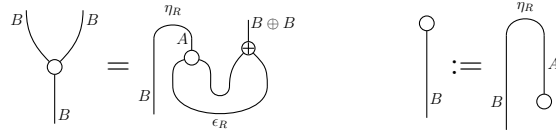

The left and the right actions are defined as follows:

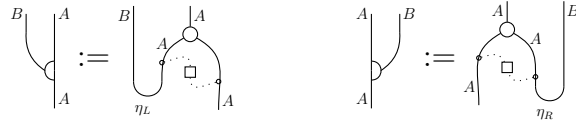

The left and the right coactions are defined as follows:



The proof that the required axioms hold is as follows. We prove a representative set of axioms. The other axioms are horizontal and vertical reflections of the following axioms:

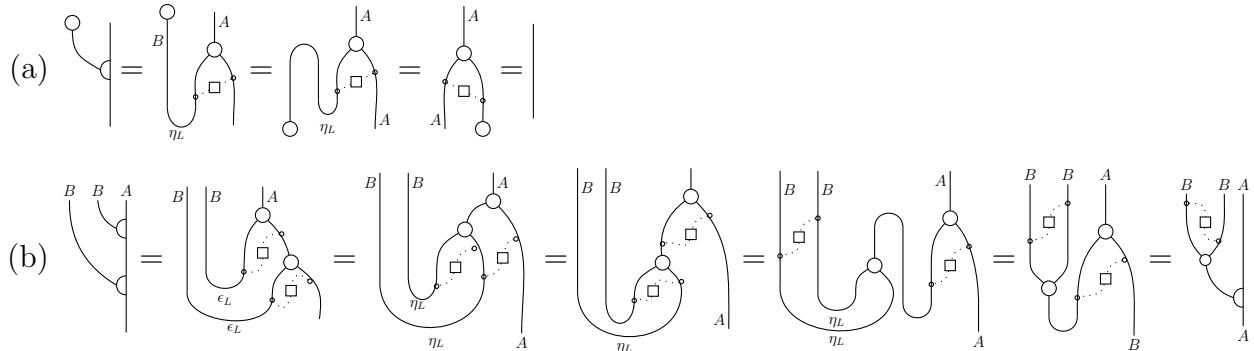

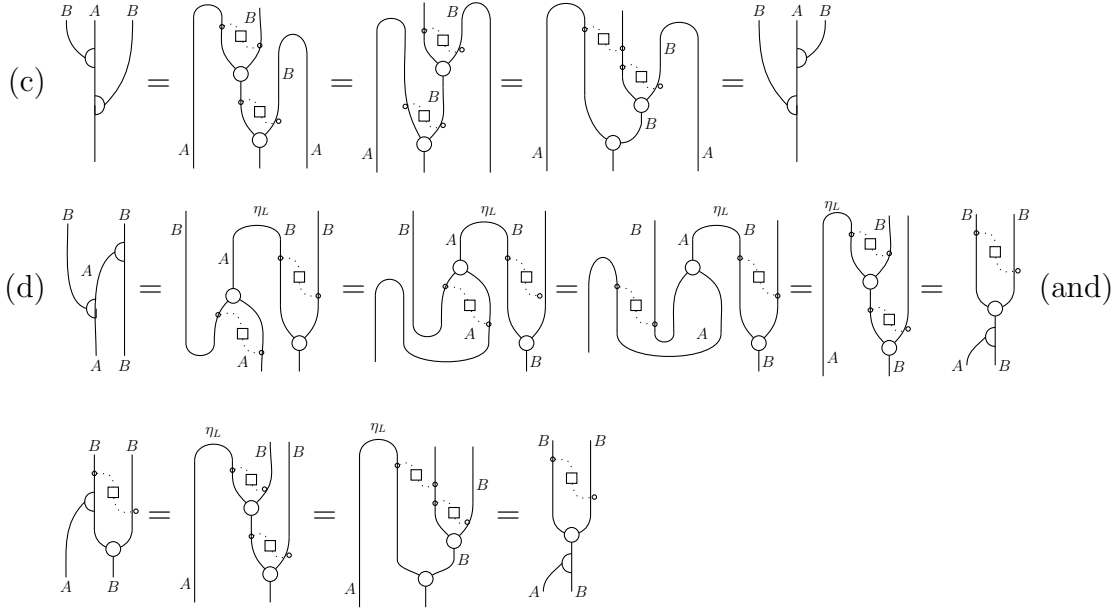

For the converse, assume the data given in the Lemma. Define the linear dual $(\eta_L, \epsilon_L) : B \dashv A$ as follows:

$$\eta_L = \begin{array}{c} \text{---} \\ \cup \\ \text{---} \end{array} \quad := \quad \begin{array}{c} \circ \\ | \\ \text{---} \\ | \\ \text{---} \\ \cup \\ \text{---} \\ | \\ \circ \end{array} \quad \epsilon_L = \begin{array}{c} \text{---} \\ \cup \\ \text{---} \end{array} \quad := \quad \begin{array}{c} \text{---} \\ | \\ \text{---} \\ | \\ \text{---} \\ \cup \\ \text{---} \\ | \\ \circ \end{array}$$

Similarly, the cup and the cap of the linear dual $(\eta, \epsilon) : A \dashv B$ is defined as follows:

$$\eta_R = \begin{array}{c} \text{---} \\ \cup \\ \text{---} \end{array} \quad := \quad \begin{array}{c} \circ \\ | \\ \text{---} \\ | \\ \text{---} \\ \cup \\ \text{---} \\ | \\ \circ \end{array} \quad \epsilon_R = \begin{array}{c} \text{---} \\ \cup \\ \text{---} \end{array} \quad := \quad \begin{array}{c} \text{---} \\ | \\ \text{---} \\ | \\ \text{---} \\ \cup \\ \text{---} \\ | \\ \circ \end{array}$$

It is straightforward to check that the snake equations hold, and that $A \dashv B$ is a linear comonoid. \square

The exponential modalities for LDCs provide an example of linear comonoids. We will prove later in Section 9.4 while discussing exponential modalities in LDCs, that every dual in an LDC with exponential modalities is also a linear comonoid.

Next, we explore the correspondence between linear monoids and linear comonoids in compact LDCs. A linear comonoid is same as a linear monoid except that a linear monoid has a \otimes -monoid (and a \oplus -comonoid) while a linear comonoid has a \otimes -comonoid (and a \oplus -monoid). This implies a correspondence between linear monoids and linear comonoids in a compact setting where the tensor and the par products are isomorphic. In fact, we show that there exists a symmetry called **compact reflection** which is an involution on the category of compact LDCs and linear functors: under this symmetry, a linear monoid translate into a linear comonoid and vice versa. The compact reflection symmetry is defined as follows:

Let \mathbb{X} be a compact LDC. Consider the category \mathbb{X}^{op} which is a compact LDC with the same tensor and par products as \mathbb{X} . The maps in \mathbb{X}^{op} are as follows:

$$\frac{A \xrightarrow{f} B \in \mathbb{X}}{B \xrightarrow{\bar{f}} A \in \mathbb{X}^{\text{op}}}$$

Here, the overline does not imply conjugation, and we use the notion to refer to the translation in the opposite category. The coherence isomorphisms for the tensor and the par products are given as follows:

$$\begin{aligned} A \otimes (B \oplus C) &\xrightarrow{\hat{\partial}} (A \otimes B) \oplus C := \bar{\partial}^{-1} \\ \perp &\xrightarrow{\hat{m}} \top := \bar{m}^{-1} \\ A \otimes B &\xrightarrow{\hat{m}_x} A \oplus B := \bar{m}_x^{-1} \end{aligned}$$

Associators and unitors are defined similarly.

Lemma 8.24. *Every linear monoid in a compact LDC, \mathbb{X} , corresponds to a linear comonoid in \mathbb{X}^{op} under the compact reflection of \mathbb{X} , and vice versa.*

Proof. Let $A \overset{\circ}{\#} B$ be a linear monoid in the compact LDC, \mathbb{X} . We know that any linear monoid, $A \overset{\circ}{\#} B$, is precisely a monoid, (A, m, u) with duals, $(\eta_L, \epsilon_L) : A \# B$, and $(\eta_R, \epsilon_R) : B \# A$, and the duals are cyclic on the monoid. The monoid (A, m, u) gives a \otimes -comonoid $(A, \Delta := \bar{m}, e := \bar{u})$ in \mathbb{X}^{op} under compact reflection. The dual $(\eta_L, \epsilon_L) : A \# B$ in the linear monoid gives the following maps in \mathbb{X}^{op} :

$$\frac{\top \xrightarrow{\eta_L} A \oplus B \in \mathbb{X}}{A \oplus B \xrightarrow{\bar{\eta}_L} \top \in \mathbb{X}^{\text{op}}} \quad \frac{B \otimes A \xrightarrow{\epsilon_L} \perp \in \mathbb{X}}{\perp \xrightarrow{\bar{\epsilon}_L} B \otimes A \in \mathbb{X}^{\text{op}}}$$

Similarly, the dual $(\eta_R, \epsilon_R) : B \# A$ gives maps $\bar{\eta}_R : B \oplus A \rightarrow \top$, and $\bar{\epsilon}_R : \perp \rightarrow A \otimes B$ in \mathbb{X}^{op} . Under this translation of $A \overset{\circ}{\#} B$, we get a linear comonoid, $A \overset{\circ}{\#} B$, in \mathbb{X}^{op} with the \otimes -comonoid (A, Δ, e) , and duals $(\tau_R, \gamma_R) : B \# A$, $(\tau_L, \gamma_L) : A \# B$ where,

$$\begin{aligned} \top &\xrightarrow{\tau_L} A \oplus B := \top \xrightarrow{\bar{m}} \perp \xrightarrow{\bar{\epsilon}_R} A \otimes B \xrightarrow{\bar{m}_x^{-1}} A \oplus B \\ B \otimes A &\xrightarrow{\gamma_L} \perp := B \otimes A \xrightarrow{\bar{m}_x^{-1}} B \oplus A \xrightarrow{\bar{\eta}_R} \top \xrightarrow{\bar{m}} \perp \end{aligned}$$

$\tau_R : \top \rightarrow B \oplus A$, and $\gamma_R : A \otimes B \rightarrow \perp$ are defined similarly. Compact reflection of the resulting linear comonoid gives back the original linear monoid in $(\mathbb{X}^{\text{op}})^{\text{op}} = \mathbb{X}$. \square

It follows from the previous Lemma that the results pertaining to linear monoids in a

compact LDC also applies for linear comonoids under compact reflection.

We move on to the discussion of morphisms of linear comonoids:

Definition 8.25. A **morphism** of linear comonoids, $(f, g) : (A \multimap B) \rightarrow (A' \multimap B')$, consists of a pair of maps, $f : A \rightarrow A'$ and $g : B' \rightarrow B$, such that f is a comonoid morphism, and (f, g) and (g, f) are morphisms of the left and the right duals respectively.

Definition 8.26. A \dagger -**linear comonoid** in a \dagger -LDC is $A \overline{\multimap} A^\dagger$ is a linear comonoid, $A \multimap A^\dagger$ such that $(\eta_L, \epsilon_L) : A \dashv A^\dagger$, and $(\eta_R, \epsilon_R) : A^\dagger \dashv A$ are \dagger -duals, and:

$$\begin{array}{c}
 \begin{array}{c} \circ \\ \perp \\ | \\ A^\dagger \end{array} := \begin{array}{c} | \\ \circ \\ | \\ A^\dagger \end{array} \begin{array}{c} \curvearrowright \\ | \\ \circ \\ | \\ A^\dagger \end{array} = \begin{array}{c} \boxed{\circ} \\ | \\ A^\dagger \end{array} \begin{array}{c} \circ \\ \perp \\ | \\ A^\dagger \end{array} \\
 \begin{array}{c} A^\dagger \oplus A^\dagger \\ \circ \\ | \\ A^\dagger \end{array} := \begin{array}{c} \curvearrowright \\ | \\ \circ \\ | \\ A^\dagger \end{array} \begin{array}{c} \curvearrowright \\ | \\ \circ \\ | \\ A^\dagger \end{array} = \begin{array}{c} \boxed{\circ} \\ | \\ A^\dagger \end{array} \begin{array}{c} \circ \\ \perp \\ | \\ A^\dagger \end{array}
 \end{array} \quad (8.13)$$

A \dagger -**self-linear comonoid** consists of an isomorphism $\alpha : A \rightarrow A^\dagger$ such that $\alpha\alpha^{-1\dagger} = \iota$.

Next, we discuss the compact reflection of \dagger -linear comonoids in compact \dagger -LDCs. If \mathbb{X} is a compact \dagger -LDC, then \mathbb{X}^{op} given by compact reflection of \mathbb{X} has the same dagger functor. In this case, the laxors and involution natural isomorphisms are defined similar to the other coherence isomorphisms:

$$\begin{aligned}
 A^\dagger \otimes B^\dagger &\xrightarrow{\widehat{\lambda}_\otimes} (A \oplus B)^\dagger := \overline{\lambda}_\otimes^{-1} \\
 \top &\xrightarrow{\widehat{\lambda}_\top} \perp^\dagger := \overline{\lambda}_\top^{-1} \\
 A &\xrightarrow{\widehat{\iota}} A^{\dagger\dagger} := \overline{\iota}^{-1}
 \end{aligned}$$

If \mathbb{X} is a unitary category, then \mathbb{X}^{op} is also a unitary category under compact reflection with the unitary structure map for an object A , given as $\widehat{\varphi}_A := \overline{\varphi}_A^{-1}$.

In Lemma 8.24, we proved that the compact reflection of a linear monoid in a compact LDC gives a linear comonoid and vice versa. In the following lemma we extend the result to \dagger -linear monoids on compact \dagger -LDCs:

Lemma 8.27. *If \mathbb{X} is a compact \dagger -LDC, then every dagger linear monoid corresponds to a dagger linear comonoid under the compact reflection.*

Proof. Suppose \mathbb{X} is a compact \dagger -LDC, and $A \overset{\circ}{\dashv} A^\dagger$ is a \dagger -linear monoid. Then, we have a \otimes -monoid (A, m, u) with a right \dagger -dual, $A \dashv A^\dagger$, and a left \dagger -dual $A^\dagger \dashv A$ satisfying the equations for a \dagger -linear monoid. To show that under compact reflection, a \dagger -linear monoid translates to a \dagger -linear comonoid, it suffices to prove that the \dagger -duals in \mathbb{X} translates to \dagger -duals in \mathbb{X}^{op} . The dual, $(\tau_L, \gamma_L) : A \dashv A^\dagger$ defined as in Lemma 8.24 is a \dagger -dual because:

The step (*) is true because $(\eta_R, \epsilon_R) : A^\dagger \xrightarrow{\dagger} A$ is a \dagger -dual. \square

Definition 8.28. A **morphism of \dagger -linear comonoids** is a pair (f, f^\dagger) such that (f, f^\dagger) is a morphism of the underlying linear comonoids.

8.3 Linear bialgebras

Linear bialgebras provide the basis for defining complementary systems in isomix categories. A linear bialgebra has a \otimes -bialgebra and a \oplus -bialgebra which are given by the bialgebraic interaction of a linear monoid and a linear comonoid. Thus, in a linear bialgebra two distinct dualities, that of the linear monoid and that of the linear comonoid, are at play.

All the results concerning bialgebras are necessarily set in symmetric LDCs, and we shall assume that the linear monoids and comonoids are symmetric.

Definition 8.29. A **linear bialgebra**, $\frac{(a,b)}{(a',b')} : A \xrightarrow{\circ} B$, in an LDC consists of:

(a) a linear monoid, $(a, b) : A \xrightarrow{\circ} B$, and

(b) a linear comonoid, $(a', b') : A \xrightarrow{\nabla} B$,

such that:

(i) $(A, \forall, \wp, \rho, \downarrow)$ is a \otimes -bialgebra, and

(ii) $(B, \forall, \Upsilon, \rho, \downarrow)$ is a \oplus -bialgebra.

A linear bialgebra is **commutative** if the \oplus -monoid and \otimes -monoid are commutative. A **self-linear bialgebra** is a linear bialgebra, in which there is an isomorphism $A \xrightarrow{\alpha} B$ (so essentially the algebra is on one object).

Definition 8.30. A **morphism of linear bialgebras** $(f, g) : \frac{(a,b)}{(a',b')} : A \xrightarrow{\circ} B \rightarrow \frac{(c,d)}{(c',d')} : C \xrightarrow{\circ} D$ is a morphism the linear monoids $((f, g) : (A \xrightarrow{\circ} B) \rightarrow (C \xrightarrow{\circ} D))$, and a morphism of the linear comonoids $((f, g) : (A \xrightarrow{\nabla} B) \rightarrow (C \xrightarrow{\nabla} D))$.

Isomorphisms transport linear bialgebras:

Lemma 8.31. In an LDC, if $\frac{(a,b)}{(a',b')} : A \xrightarrow{\circ} B$ is a linear bialgebra and $f : A' \rightarrow A$ and $g : B \rightarrow B'$ are isomorphisms, then $A' \xrightarrow{\circ} B'$ is a linear bialgebra with the linear monoid $(a(f^{-1} \oplus g), (g^{-1} \otimes f)b) : A' \xrightarrow{\circ} B'$, and the linear comonoid $(a'(f^{-1} \oplus g), (g^{-1} \otimes f)b') : A' \xrightarrow{\nabla} B'$.

A \dagger -linear bialgebra is defined as follows:

Definition 8.32. (i) A \dagger -linear bialgebra, $\frac{(a,b)}{(a',b')} : A \xrightarrow{\dagger\circ\#} A^\dagger$, is a linear bialgebra with a \dagger -linear monoid, and a \dagger -linear comonoid.

(ii) A \dagger -self-linear bialgebra is \dagger -linear bialgebra which is also a self-linear bialgebra such that the isomorphism, $\alpha : A \rightarrow A^\dagger$, satisfies $\alpha\alpha^{-1\dagger} = \iota$.

Note that A is a weak pre-unitary object, which if in the core, is a pre-unitary object.

The next chapter develops complementary systems and measurements in MUCs using the structures developed in the current chapter.

Chapter 9

Measurement and complementarity

In this chapter, we describe measurement in MUCs and characterize measurements using ‘compaction’. We also develop the notion of (\dagger) -complementary systems in (\dagger) -isomix categories and show that in an isomix category with free exponential modalities, every complementary system arises as a canonical compaction of a linear bialgebra on the free exponential modalities.

Coecke and Pavlovic [48] described a “demolition” measurement in a \dagger -monoidal category as a map, $m : A \rightarrow X$, with $m^\dagger m = 1_X$, to a special commutative \dagger -Frobenius algebra, X . In this chapter, we generalize this idea to MUCs. In the \dagger -isomix category of a MUC, generally, $A \neq A^\dagger$, hence the equation $m^\dagger m = 1$ does not make sense. However, the notion of a demolition measurement is available in the unitary core of the MUC. Thus, in a MUC, a measurement can be viewed as a two-step process in which one first “compacts”, by a retraction, into the unitary core and then one does a conventional demolition measurement. The compaction process is discussed in Section 9.1 and gives rise to the notion of \dagger -binary idempotent. On the other hand, a \dagger -binary idempotent which splits and satisfies the technical condition of being ‘coring’, gives rise to a compaction to the “canonical” unitary core.

9.1 Compaction

In order to perform a measurement on an object A of the \dagger -isomix category of a MUC, we must first compact A into an object in the unitary core:

Definition 9.1. *Let $M : \mathbb{U} \rightarrow \mathbb{C}$ be a MUC. A **compaction** to U of an object $A \in \mathbb{C}$ is a retraction, $r : A \rightarrow M(U)$. This means that there is a section $s : M(U) \rightarrow A$ such that $sr = 1_{M(U)}$. A compaction is said to be **canonical** when \mathbb{U} is the canonical unitary core, in other words, U is a pre-unitary object.*

An object, $M(U)$ for $U \in \mathbb{U}$, has a unitary structure map which is an isomorphism between $M(U)$ and $M(U)^\dagger$ given by composing the unitary structure map of U with the preservator:

$$\psi := M(U) \xrightarrow{M(\varphi)} M(U^\dagger) \xrightarrow{\rho} M(U)^\dagger$$

Once one has reached $M(U)$, one can follow with a conventional demolition measurement $U \xrightarrow{w} X$ in \mathbb{U} to obtain an overall compaction $A \xrightarrow{rM(w)} M(X)$. This composite may be viewed as being the analogue of a demolition measurement in a MUC.

We start by showing how a compaction gives rise to a binary idempotent:

Definition 9.2. *A binary idempotent in any category is a pair of maps (\mathbf{u}, \mathbf{v}) with $\mathbf{u} : A \rightarrow B$, and $\mathbf{v} : B \rightarrow A$ such that $\mathbf{u}\mathbf{v}\mathbf{u} = \mathbf{u}$, and $\mathbf{v}\mathbf{u}\mathbf{v} = \mathbf{v}$.*

A binary idempotent, $(\mathbf{u}, \mathbf{v}) : A \rightarrow B$ gives a pair of idempotents $e_A := \mathbf{u}\mathbf{v} : A \rightarrow A$, and $e_B := \mathbf{v}\mathbf{u} : B \rightarrow B$. We say a binary idempotent **splits** in case the idempotents e_A and e_B split.

Lemma 9.3. *In any category the following are equivalent:*

- (i) $(\mathbf{u}, \mathbf{v}) : A \rightarrow B$ is a binary idempotent which splits.
- (ii) There exists a pair of idempotents $e : A \rightarrow A$, and $d : B \rightarrow B$ which split through isomorphic objects.

Proof.

(i) \Rightarrow (ii): Suppose that $\mathbf{u}\mathbf{v}$ splits as $A \xrightarrow{r} A' \xrightarrow{s} A$ (so $e := rs = \mathbf{u}\mathbf{v}$ and $sr = 1_{A'}$) and $d := \mathbf{v}\mathbf{u}$ splits as $B \xrightarrow{p} B' \xrightarrow{q} B$ (so $pq = \mathbf{v}\mathbf{u}$ and $qp = 1_{B'}$) then we obtain two maps $\alpha := \text{sup} : A' \rightarrow B'$ and $\beta := \text{qvr} : B' \rightarrow A'$ which are inverse to each other:

$$\begin{aligned} \alpha\beta &:= (\text{sup})(\text{qvr}) = su(pq)\mathbf{v}r = s\mathbf{u}\mathbf{v}\mathbf{u}\mathbf{v}r = s\mathbf{u}\mathbf{v}r = sr\mathbf{u}\mathbf{v}r = 1_{A'} \\ \beta\alpha &:= (\text{qvr})(\text{sup}) = q\mathbf{v}(rs)\mathbf{u}p = q\mathbf{v}\mathbf{u}\mathbf{v}\mathbf{u}p = q\mathbf{v}\mathbf{u}p = qpq\mathbf{u}p = 1_{B'}. \end{aligned}$$

(ii) \Rightarrow (i): Suppose $e_A : A \rightarrow A$ and $e_B : B \rightarrow B$ are idempotents which split, respectively, as $A \xrightarrow{r} A' \xrightarrow{s} A$ (so $rs = e_A$ and $sr = 1_{A'}$) and $B \xrightarrow{p} B' \xrightarrow{q} B$ (so $pq = e_B$ and $qp = 1_{B'}$), so that $\gamma : A' \rightarrow B'$ is an isomorphism then we obtain two maps $\mathbf{u} := r\gamma q : A \rightarrow B$ and $\mathbf{v} := p\gamma^{-1}s : B \rightarrow A$. We observe:

$$\begin{aligned} \mathbf{u}\mathbf{v}\mathbf{u} &:= r\gamma qp\gamma^{-1}sr\gamma q = r\gamma\gamma^{-1}sr\gamma q = r\mathbf{u}\mathbf{v}\mathbf{u} = r\gamma q = \mathbf{u} \\ \mathbf{v}\mathbf{u}\mathbf{v} &:= p\gamma^{-1}sr\gamma qp\gamma^{-1}s = p\gamma^{-1}\gamma qp\gamma^{-1}s = pqp\gamma^{-1}s = p\gamma^{-1}s = \mathbf{v}. \end{aligned}$$

□

Observe that a compaction of an object, A , in any MUC, gives the following system of maps:

$$A \begin{array}{c} \xrightarrow{r} \\ \xleftarrow{s} \end{array} M(U) \begin{array}{c} \xrightarrow{\psi := M(\varphi)\rho} \\ \xleftarrow{\psi^{-1}} \end{array} M(U)^\dagger \begin{array}{c} \xrightarrow{r^\dagger} \\ \xleftarrow{s^\dagger} \end{array} A^\dagger$$

Thus the compaction gives rise to a binary idempotent $(\mathbf{u}, \mathbf{v}) : A \rightarrow A^\dagger$ where $\mathbf{u} := r\psi r^\dagger$ and $\mathbf{v} := s^\dagger\psi^{-1}s$

Because U is a unitary object, we have that $\varphi(\varphi^{-1})^\dagger = \iota$. The preservator, on the other hand, satisfies $\iota\rho^\dagger = M(\iota)\rho$ (see after Definition 3.17 in [34]). Thus $\iota\rho^\dagger = M(\iota)\rho = M(\varphi\varphi^{-1})^\dagger\rho = M(\varphi)\rho M(\varphi^{-1})^\dagger$ and whence $\psi = M(\varphi)\rho = \iota\rho^\dagger M(\varphi)^\dagger = \iota(M(\varphi)\rho)^\dagger = \iota\psi^\dagger$. This allows us to observe:

$$\begin{aligned} \iota\mathbf{u}^\dagger &= \iota(r\psi r^\dagger)^\dagger = \iota r^{\dagger\dagger}\psi^\dagger r^\dagger = r\iota\psi^\dagger r^\dagger = r\psi r^\dagger = \mathbf{u} \\ \mathbf{v}^\dagger &= (s^\dagger\psi^{-1}s)^\dagger = s^\dagger(\psi^\dagger)^{-1}s^{\dagger\dagger} = s^\dagger(\iota^{-1}\psi)^{-1}s^{\dagger\dagger} = s^\dagger\psi^{-1}\iota s^{\dagger\dagger} = s^\dagger\psi^{-1}s\iota = \mathbf{v}\iota \end{aligned}$$

This leads to the following definition:

Definition 9.4. A binary idempotent, $(\mathbf{u}, \mathbf{v}) : A \rightarrow A^\dagger$ in a \dagger -LDC, is a **\dagger -binary idempotent**, written $\dagger(\mathbf{u}, \mathbf{v})$, if $\mathbf{u} = \iota\mathbf{u}^\dagger$, and $\mathbf{v}^\dagger = \mathbf{v}\iota$.

In a \dagger -monoidal category, where $A = A^\dagger$ and $\iota = 1_A$ this makes $\mathbf{u} = \mathbf{u}^\dagger$ and $\mathbf{v} = \mathbf{v}^\dagger$, thus $\mathbf{u}\mathbf{v} = (\mathbf{v}\mathbf{u})^\dagger$. This means that if we require $\mathbf{u}\mathbf{v} = \mathbf{v}\mathbf{u}$ we obtain a dagger idempotent in the sense of [111].

Splitting a dagger binary idempotent almost produces a pre-unitary object. In a \dagger -LDC, we shall call an object A with an isomorphism $\varphi : A \rightarrow A^\dagger$ such that $\varphi\varphi^{\dagger-1} = \iota$ a **weak pre-unitary object**. In a \dagger -isomix category, a weak pre-unitary object (A, φ) is a pre-unitary object when, in addition, A is in the core. We next observe that dagger binary idempotent always split through weak pre-unitary objects:

Lemma 9.5. In a \dagger -LDC with a \dagger -binary idempotent $\dagger(\mathbf{u}, \mathbf{v}) : A \rightarrow A^\dagger$:

(i) $e_{A^\dagger} := \mathbf{v}\mathbf{u} = (\mathbf{u}\mathbf{v})^\dagger =: (e_A)^\dagger$;

(ii) if $\dagger(\mathbf{u}, \mathbf{v})$ splits with $e_A = A \xrightarrow{r} E \xrightarrow{s} A$ then $(E, \mathbf{u}s^\dagger)$ with is a weak pre-unitary object.

Proof.

(i) $e_{A^\dagger} = \mathbf{v}\mathbf{u} = \mathbf{v}\iota\mathbf{u}^\dagger = \mathbf{v}^\dagger\mathbf{u}^\dagger = (\mathbf{u}\mathbf{v})^\dagger = e_A^\dagger$.

(ii) Suppose (u, v) is a \dagger -binary idempotent, and uv splits as $uv = A \xrightarrow{r} U \xrightarrow{s} A$. This means vu splits as $vu = A^\dagger \xrightarrow{s^\dagger} U^\dagger \xrightarrow{r^\dagger} A^\dagger$. This yields an isomorphism $\alpha = sus^\dagger : E \rightarrow E^\dagger$ satisfying:

$$\alpha(\alpha^{-1})^\dagger = sus^\dagger(r^\dagger v r)^\dagger = sus^\dagger r^\dagger v^\dagger r^{\dagger\dagger} = suvuv^\dagger r^{\dagger\dagger} = suv^\dagger r^{\dagger\dagger} = suv l r^{\dagger\dagger} = suv r l = sr s r l = \iota.$$

□

Thus, in a \dagger -isomix category, an object which splits a \dagger -binary idempotent is always weakly pre-unitary. In order to ensure that the splitting of a dagger binary idempotent is a pre-unitary object – and so a canonical compaction – it remains to ensure that the splitting is in the core. This leads to the following definition:

Definition 9.6. *An idempotent $A \xrightarrow{e} A$ in an isomix category, \mathbb{X} , is a **coring idempotent** if it is equipped with natural $\kappa_X^L : X \oplus A \rightarrow X \otimes A$ and $\kappa_X^R : A \oplus X \rightarrow A \otimes X$ such that the following diagrams commute:*

$$\begin{array}{cccc} X \otimes A \xrightarrow{1 \otimes e} X \otimes A & X \oplus A \xrightarrow{1 \oplus e} X \oplus A & A \otimes X \xrightarrow{e \otimes 1} A \otimes X & A \oplus X \xrightarrow{e \oplus 1} A \oplus X \\ 1 \otimes e \downarrow \text{[KL.1]} \downarrow \text{mx} & 1 \oplus e \downarrow \text{[KL.2]} \downarrow \kappa_X^L & e \otimes 1 \downarrow \text{[KR.1]} \downarrow \text{mx} & e \oplus 1 \downarrow \text{[KR.2]} \downarrow \kappa_X^R \\ X \otimes A \xleftarrow{\kappa_X^L} X \oplus A & X \oplus A \xleftarrow{\text{mx}} X \otimes A & A \otimes X \xleftarrow{\kappa_X^R} A \oplus X & A \oplus X \xleftarrow{\text{mx}} A \otimes X \end{array}$$

For a coring idempotent $A \xrightarrow{e} A$, the transformations $\kappa_{\bar{X}}$ act on a splitting as the inverse of the mixer, mx . Thus, a coring idempotent always splits through the core:

Lemma 9.7. *In a mix category:*

- (i) *An idempotent splits through the core if and only if it is coring;*
- (ii) *If (u, v) is a binary idempotent then uv is coring if and only if vu is coring.*

Proof.

(i) Let $A \xrightarrow{e} A$ be a coring idempotent which splits as $A \xrightarrow{r} U \xrightarrow{s} A$. Define $\text{mx}'_{U,X} := U \oplus X \xrightarrow{s \oplus 1} A \oplus X \xrightarrow{\kappa_X^R} A \otimes X \xrightarrow{r \otimes 1} U \otimes 1$, then U is in the core because $\text{mx}'_{U,X} = \text{mx}_{U,X}^{-1}$. Conversely, the inverse of the mixer for U and an object X defines the $\kappa_{\bar{X}}$.

(ii) The splitting of uv is isomorphic to the splitting of vu and the core includes isomorphisms.

□

A consequence of Lemma 9.11 is that in a \dagger -LDC, splitting a \dagger -binary idempotent on a \dagger -dual gives a \dagger -self-duality if the binary idempotent is either sectional or retractional:

Lemma 9.13. *In a \dagger -LDC, a pair of idempotents (e, e^\dagger) , on a \dagger -dual $(\eta, \epsilon) : A \dashv\vdash B$, with splitting $A \xrightarrow{r} E \xrightarrow{s} A$ is sectional (respectively retractional) if and only if the section (s, s^\dagger) (respectively the retraction (r, r^\dagger)) is a morphism for $(\eta(r \oplus s^\dagger), (r^\dagger \otimes s)\epsilon) : E \dashv\vdash E^\dagger$.*

Proof. Let (e, e^\dagger) be sectional on a \dagger -dual $(\eta, \epsilon) : A \dashv\vdash A^\dagger$. Let the idempotent split:

$$e = A \xrightarrow{r} E \xrightarrow{s} A \quad \text{Hence, } e^\dagger = A^\dagger \xrightarrow{s^\dagger} E^\dagger \xrightarrow{r^\dagger} A^\dagger$$

It follows from Lemma 9.11 that the splitting is self-dual. The self-duality is given by $(\eta', \epsilon') : E \dashv\vdash E^\dagger$, where $\eta' := \eta(r \oplus s^\dagger)$, and $\epsilon' := (r^\dagger \otimes s)\epsilon$. We must prove that the self-dual is also a \dagger -dual i.e, equation 8.1-(a) holds for $(\eta', \epsilon') : E \dashv\vdash E^\dagger$:

$$\begin{aligned} \eta'(\iota \oplus 1) &= \eta(r \oplus s^\dagger)(\iota \oplus 1) = \eta(r\iota \oplus s^\dagger) \\ &\stackrel{\text{nat. } \iota}{=} \eta(\iota r^\dagger \oplus s^\dagger) = \eta(\iota \oplus 1)(r^\dagger \oplus s^\dagger) \\ &\stackrel{\dagger\text{-dual}}{=} (\epsilon)^\dagger \lambda_{\oplus}^{-1}((r^\dagger \oplus s^\dagger)) \stackrel{\text{nat. } \lambda_{\oplus}}{=} (\epsilon)^\dagger((r^\dagger \otimes s)^\dagger) \lambda_{\oplus}^{-1} \\ &= ((r^\dagger \otimes s)\epsilon)^\dagger \lambda_{\oplus}^{-1} = (\epsilon')^\dagger \lambda_{\oplus}^{-1} \end{aligned}$$

The statement is proven similarly when the idempotents are retractional. The converse is straightforward. \square

Corollary 9.14. *In a \dagger -LDC, a \dagger -binary idempotent $\dagger(u, v)$, on a \dagger -dual $(\eta, \epsilon) : A \dashv\vdash B$, with splitting $A \xrightarrow{r} E \xrightarrow{s} A$ is sectional (respectively retractional) if and only if the section (s, s^\dagger) (respectively the retraction (r, r^\dagger)) is a morphism for the self \dagger -dual $(\eta(r \oplus s^\dagger), (r^\dagger \otimes s)\epsilon) : E \dashv\vdash E^\dagger$.*

We move on to the idempotents for linear monoids.

Given an idempotent, $e_A : A \rightarrow A$, and a monoid, (A, m, u) in a monoidal category, e_A is **retractional** on the monoid if $e_A m = e_A m(e_A \otimes e_A)$. e_A is **sectional** on the monoid if $m(e_A \otimes e_A) = e_A m(e_A \otimes e_A)$ and $u e_A = u$.

Lemma 9.15. *In a monoidal category, a split idempotent $e : A \rightarrow A$ on a monoid (A, m, u) , with splitting $A \xrightarrow{r} E \xrightarrow{s} A$, is sectional (respectively retractional) if and only if the section s (respectively the retraction r) is a monoid morphism for $(E, (s \otimes s)m, ur)$.*

Proof. Suppose $e : A \rightarrow A$ is an idempotent with the splitting $A \xrightarrow{r} E \xrightarrow{s}$ and (A, m, u) is a monoid. Suppose e is sectional on A i.e, $(e \otimes e)m = (e \otimes e)me$, and $ue = u$.

We must prove that (E, m', u') is a monoid where $m' := (s \otimes s)mr$ and $u' := ur$. The unit law and associativity law are proven as follows.

$$(u' \otimes 1)m' = (ur \otimes 1)(s \otimes s)mr = (urs \otimes s)mr = (ue \otimes s)mr \stackrel{\text{sectional}}{=} (u \otimes s)mr = sr = 1$$

In the following string diagrams, we use black circle for (E, m', u') , and white circle (A, m, u) .

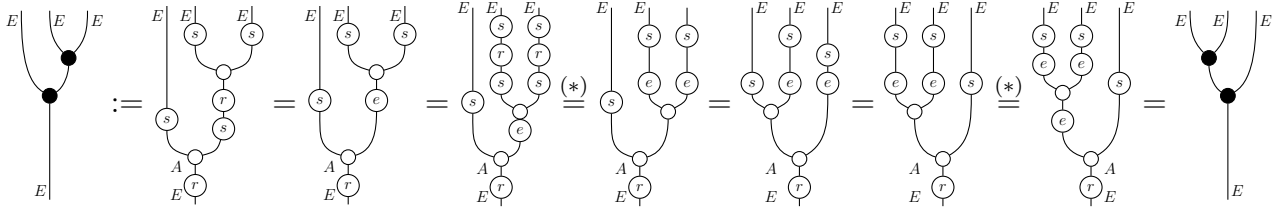

The steps labeled $(*)$ are valid because e is sectional on (A, m, u) .

Finally, $s : E \rightarrow A$ is a monoid homomorphism because:

$$m's = (s \otimes s)mrs = (srs \otimes srs)me = (s \otimes s)(e \otimes e)me = (s \otimes s)(e \otimes e)m = (s \otimes s)m$$

For the converse assume that (E, m', u') is a monoid where $m' = (s \otimes s)mr$, and $u' = ur$, and s is a monoid homomorphism. Then, $e : A \rightarrow A$ is sectional on (A, m, u) because:

$$ue = urs = u's = u$$

$$(e \otimes e)m = (r \otimes r)(s \otimes s)m = (r \otimes r)m's = (r \otimes r)(s \otimes s)mrs = (e \otimes e)me$$

The statement is proven similarly when the idempotent is retractional on the monoid. \square

A pair of idempotents, (e_A, e_B) is **sectional** (respectively **retractional**) on a linear monoid $A \overset{\circ}{\dashv} B$ if the idempotent pair satisfies the conditions in the following table.

(e_A, e_B) sectional on $A \overset{\circ}{\dashv} B$	(e_A, e_B) retractional on $A \overset{\circ}{\dashv} B$
e_A preserves (A, m, u) sectionally	e_A preserves (A, m, u) retractionally
(e_A, e_B) preserves $(\eta_L, \epsilon_L): A \dashv B$ sectionally	(e_A, e_B) preserves $(\eta_L, \epsilon_L): A \dashv B$ retractionally
(e_B, e_A) preserves $(\eta_R, \epsilon_R): B \dashv A$ retractionally	(e_B, e_A) preserves $(\eta_R, \epsilon_R): B \dashv A$ sectionally

A binary idempotent (u, v) on a linear monoid is **sectional** (respectively **retractional**) if (uv, vu) is sectional (respectively retractional).

Splitting a sectional or retractional idempotent on a linear monoid produces a linear monoid on the splitting:

Lemma 9.16. *In an LDC, let (e_A, e_B) be a pair of idempotents on a linear monoid $A \overset{\circ}{\dashv} B$*

and the idempotents split as follows: $A \xrightarrow{r} E \xrightarrow{s} A$, and $B \xrightarrow{r'} E' \xrightarrow{s'} B$. The idempotent pair (e_A, e_B) is sectional (respectively retractional) if and only if the section $(s, r') : (E \dashv\!\!\dashv E') \rightarrow (A \overset{\circ}{\dashv\!\!\dashv} B)$ (respectively the retraction $(r, s') : (A \overset{\circ}{\dashv\!\!\dashv} B) \rightarrow (E \dashv\!\!\dashv E')$) is a morphism of linear monoids.

Proof. Suppose (e_A, e_B) is sectional on $A \overset{\circ}{\dashv\!\!\dashv} B$. Let,

$$e_A = A \xrightarrow{r} E \xrightarrow{s} A \quad e_B = B \xrightarrow{r'} E' \xrightarrow{s'} B$$

be a splitting of (u, v) . From Lemma 9.15 we know that (A, m', u') is a monoid where $m' = (s \otimes s)mr$ and $u' = ur$, and from Lemma 9.11 we know that $(\eta_L(r \otimes r'), (s' \otimes s)\epsilon_L) : E \dashv\!\!\dashv E'$, and $(\eta_R(r' \otimes r), (s \otimes s')\epsilon_R) : E' \dashv\!\!\dashv E$ are the left and the right duals respectively.

To prove that the above data is a linear monoid we must show that equation 8.3 holds:

where (1) is true because e_A is section on (A, m, u) , (2) because (e_B, e_A) is retractional on $(\eta_R, \epsilon_R) : B \dashv\!\!\dashv A$, (3) holds because A is a linear monoid, and (4) holds because (e_A, e_B) is sectional on $(\eta_L, \epsilon_L) : A \dashv\!\!\dashv B$.

The converse of the statement is straightforward from Lemma 9.11, and Lemma 9.15. \square

As a consequence of the previous Lemma, a split binary idempotent is sectional (respectively retractional) if and only its section (respectively retraction) is a morphism from (respectively to) the self-linear monoid given on the splitting.

The following Lemma extends Lemma 9.16 to sectional/retractional \dagger -binary idempotents on \dagger -linear monoids:

Lemma 9.17. *In a \dagger -LDC, let (e, e^\dagger) be a pair of idempotents on a \dagger -linear monoid $A \overset{\circ}{\dashv\!\!\dashv} A^\dagger$ with splitting $A \xrightarrow{r} E \xrightarrow{s} A$. The idempotent pair (e, e^\dagger) is sectional (respectively retractional) if and only if the section (s, s^\dagger) (respectively the retraction (r, r^\dagger)) is a morphism of \dagger -linear monoids.*

Proof. Suppose an idempotent pair (e, e^\dagger) is a sectional on a \dagger -linear monoid $A \overset{\circ}{\dashv\!\!\dashv} A^\dagger$. Moreover, the idempotent e splits as follows:

$$e = A \xrightarrow{r} E \xrightarrow{s} A$$

We must show that E is a \dagger -linear monoid. From Lemma 9.16, we know that $E \overset{\circ}{\dashv} E^\dagger$ is a linear monoid. It is also a \dagger -linear monoid because:

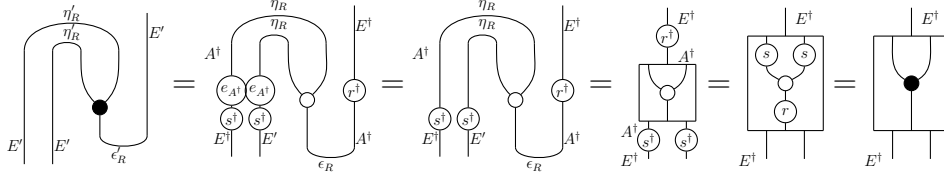

The statements are proven similarly for retractional binary idempotent. The converse follows directly from Lemma 9.16. \square

As a consequence of the above Lemma, a split \dagger -binary idempotent is sectional (respectively retractional) on a \dagger -linear monoid if and only if its section (respectively retraction) is a morphism from (respectively to) the \dagger -self-linear monoid given on the splitting.

From Lemma 9.16, it follows that splitting a sectional or retractional binary idempotent produces a self-linear monoid. If the binary idempotent is also coring and satisfies equation 9.1, then it produces a Frobenius Algebra on the splitting:

Lemma 9.18. *In an isomix category \mathbb{X} , let $E \overset{\bullet}{\dashv} E'$ be a self-linear monoid in $\text{Core}(\mathbb{X})$ given by splitting a coring sectional/retractional binary idempotent (u, v) on linear monoid $A \overset{\circ}{\dashv} B$. Let $\alpha : E \rightarrow E'$ be the isomorphism. Then, E is a Frobenius Algebra under the linear equivalence Mx_\downarrow if and only if the binary idempotent satisfies the following equation where $e_A = uv$ and $e_B = vu$:*

$$\begin{array}{c}
 \begin{array}{c} A \\ | \\ \text{u} \\ | \\ B \end{array}
 = \begin{array}{c} E \\ | \\ \epsilon_A \\ \circlearrowleft \\ \text{u} \\ \circlearrowright \\ \epsilon_B \\ | \\ B \end{array}
 = \begin{array}{c} E \\ | \\ \epsilon_B \\ \circlearrowleft \\ \text{u} \\ \circlearrowright \\ \epsilon_A \\ | \\ B \end{array}
 \end{array}
 \tag{9.1}$$

Proof. Let $E \overset{\bullet}{\dashv} E'$ be a self-linear monoid given by splitting a sectional or retractional binary idempotent on $A \overset{\circ}{\dashv} B$. Let the splitting of the binary idempotent be $e_A = uv = A \xrightarrow{r} E \xrightarrow{s} A$, and $e_B = vu = B \xrightarrow{r'} E' \xrightarrow{s'} B$. Suppose u satisfies the given equation. If we show that the following equation holds, then by Lemma 8.20 E is a Frobenius algebra:

$$\begin{array}{c}
 \begin{array}{c} E \\ | \\ \alpha \\ | \\ E' \end{array}
 = \begin{array}{c} E \\ | \\ \eta_L \\ \bullet \\ \alpha \\ \bullet \\ E' \end{array}
 = \begin{array}{c} E \\ | \\ \eta_R \\ \bullet \\ \alpha \\ \bullet \\ E' \end{array}
 \end{array}$$

The proof is as follows:

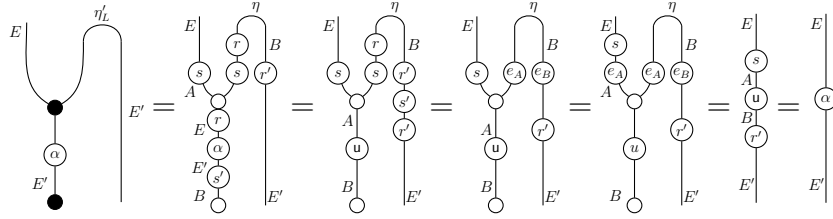

For the converse assume that $E \overset{\bullet}{\dashv} E'$ is a self-linear monoid given by splitting a coring sectional/retractational binary idempotent (u, v) on linear monoid $A \overset{\circ}{\dashv} B$. The linear monoid $E \overset{\bullet}{\dashv} E'$ correspond precisely to a Frobenius Algebra $(E, \varphi, \psi, \mu, \nu)$ under the linear equivalence \mathbf{Mx}_\downarrow . We must prove that the binary idempotent satisfies the given equation. Let the binary idempotent be either sectional or retractational and split as follows:

$$A \begin{array}{c} \xrightarrow{r} \\ \xleftarrow{s} \end{array} E \xrightarrow{\alpha} E' \begin{array}{c} \xleftarrow{s'} \\ \xrightarrow{r'} \end{array} B$$

Then,

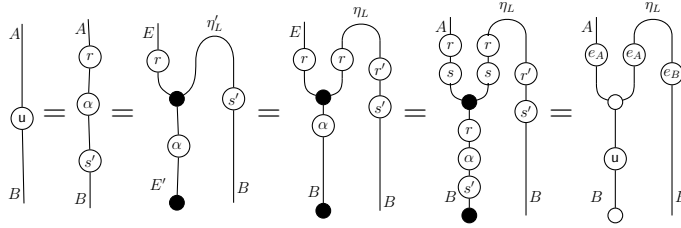

□

In a \dagger -isomix category splitting a sectional or retractational \dagger -binary idempotent on a \dagger -linear monoid gives a \dagger -self-linear monoid on a pre-unitary object. If the binary idempotent satisfies equation 9.1(a) in addition, then, by using Lemma 8.20 and 9.18, one gets a \dagger -Frobenius Algebra on the splitting.

9.2.2 For linear comonoids

In a monoidal category, an idempotent $e : A \rightarrow A$ is **sectional** (respectively **retractational**) on a comonoid (A, d, k) if $ed = ed(e \otimes e)$ (respectively if $d(e \otimes e) = ed(e \otimes e)$, and $ek = k$).

Lemma 9.19. *In a monoidal category, a split idempotent $e : A \rightarrow A$ on a comonoid (A, d, k) , with splitting $A \xrightarrow{r} E \xrightarrow{s} A$, is sectional (respectively retractational) if and only if the section s (respectively the retraction r) is a comonoid morphism for $(E, sd(r \otimes r), sk)$.*

Proof. Suppose $e : A \rightarrow A$ is an idempotent with the splitting $A \xrightarrow{r} E \xrightarrow{s}$ and (A, d, k) is a monoid. Suppose e is sectional on A i.e, $d(e \otimes e) = ed(e \otimes e)$.

We must prove that (E, d', k') is a monoid where $d' := sd(r \otimes r)$ and $k' := sk$. Unit law and associativity law are proven as follows.

$$\begin{aligned} d'(k' \otimes 1) &= sd(r \otimes r)(sk \otimes 1) = sd(rsk \otimes r) = sd(ek \otimes r) \\ &= srsd(ek \otimes r) = sed(ek \otimes er) \stackrel{\text{sectional}}{=} sed(k \otimes r) = ser = srsr = 1 \end{aligned}$$

In the following string diagrams, we use black circle for (E, d', k') , and white circle for (A, d, k) :

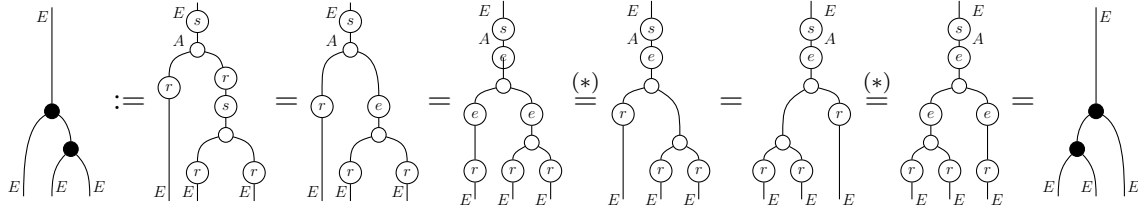

The steps labelled by $(*)$ are because e is sectional on (A, d, k) .

Finally, $s : E \rightarrow A$ is a comonoid homomorphism because:

$$d'(s \otimes s) = sd(r \otimes r)(s \otimes s) = sd(rs \otimes rs) = sd(e \otimes e) = srsd(e \otimes e) = sed(e \otimes e) = sed = sd$$

For the converse, assume that (E, d', k') is a comonoid where $d' = sd(r \otimes r)$, and $k' = sk$, and s is a monoid homomorphism, then, $e : A \rightarrow A$ is sectional on (A, d, k) because:

$$ed = rsd = rd'(s \otimes s) = rsd(r \otimes r)(s \otimes s) = ed(e \otimes e)$$

The statement is proven similarly when the idempotent is retractional on the comonoid. \square

In an LDC, a pair of idempotents (e_A, e_B) is **sectional** (respectively **retractional**) on a linear comonoid when e_A and e_B satisfies the conditions in table given below.

(e_A, e_B) sectional on $A \multimap B$	(e_A, e_B) retractional on $A \multimap B$
e_A preserves (A, d, k) sectionally	e_A preserves (A, d, k) retractionally
(e_A, e_B) preserves $(\eta_L, \epsilon_L): A \dashv B$ sectionally	(e_A, e_B) preserves $(\eta_L, \epsilon_L): A \dashv B$ retractionally
(e_B, e_A) preserves $(\eta_R, \epsilon_R): B \dashv A$ retractionally	(e_B, e_A) preserves $(\eta_R, \epsilon_R): B \dashv A$ sectionally

A binary idempotent (u, v) is **sectional** (respectively **retractional**) on a linear monoid when (uv, vu) is sectional (respectively retractional).

Lemma 9.20. *In an LDC, let (e_A, e_B) be a pair of idempotents on a linear comonoid $A \multimap B$ with \otimes -comonoid (A, d, e) and splitting $A \xrightarrow{r} E \xrightarrow{s} A$, and $B \xrightarrow{r'} E' \xrightarrow{s'} B$. The*

idempotent pair (e_A, e_B) is sectional (respectively retractional) if and only if the section (s, r') : $(E \dashv_{\bullet} E') \rightarrow (A \dashv_{\circ} B)$ (respectively the retraction (r, s') : $(A \dashv_{\circ} B) \rightarrow (E \dashv_{\bullet} E')$) is a morphism of linear comonoid.

The proof is similar to that of Lemma 9.16 for sectional/retractional idempotents on linear monoids.

As a consequence of the above Lemma, a split binary idempotent is sectional (respectively retractional) on a linear comonoid if and only if its section (respectively retraction) is a morphism from (respectively to) the self-linear comonoid given on the splitting.

When a sectional or retractional \dagger -binary idempotent on \dagger -linear comonoid splits, it gives a \dagger -self-linear comonoid on the splitting:

Lemma 9.21. *In a \dagger -LDC, let (e, e^\dagger) be a pair of idempotents on a \dagger -linear monoid $A \dashv_{\circ} A^\dagger$ with splitting $A \xrightarrow{r} E \xrightarrow{s} A$. The idempotent pair (e, e^\dagger) is sectional (respectively retractional) if and only if the section (s, s^\dagger) (respectively the retraction (r, r^\dagger)) is a morphism of \dagger -linear monoids.*

The proof is similar to Lemma 9.17 for sectional/retractional idempotents on \dagger -linear monoids.

As a consequence of the above Lemma, a split \dagger -binary idempotent is sectional (respectively retractional) on a \dagger -linear monoid if and only if its section (respectively retraction) is a morphism from (respectively to) the \dagger -self-linear monoid given on the splitting.

9.2.3 For linear bialgebras

We turn our attention to binary idempotents for linear bialgebras:

Definition 9.22. *A binary idempotent on a linear bialgebra is **sectional (respectively retractional)** if its sectional (respectively retractional) on the linear monoid, and the linear comonoid.*

Lemma 9.16 states that a pair of split idempotents is sectional (respectively retractional) on a linear monoid if and only if the section (repectively retraction) a morphism of linear monoid. Lemma 9.20 states that a pair of split idempotents is sectional (respectively retractional) on a linear comonoid if and only if the section (repectively retraction) a morphism of linear comonoid. Applying these results to a sectional / retractional binary idempotent on a linear bialgebra we get:

Lemma 9.23. *In an LDC, let (u, v) be a split binary idempotent on a linear bialgebra $A \dashv_{\diamond} B$ with splitting $A \xrightarrow{r} E \xrightarrow{s} A$, and $B \xrightarrow{r'} E' \xrightarrow{s'} B$ is sectional (respectively retractional) if and only if the section (s, r') (respectively the retraction (r, s')) is a morphism of linear*

bialgebra for $E \overset{\bullet}{\dashv} E'$ with its linear monoid and linear comonoid given as in Statement (i) of Lemma 9.16 and Lemma 9.20 respectively.

Proof. Let (u, v) be a sectional binary idempotent on a linear bialgebra $A \overset{\circ}{\dashv} B$. Let (u, v) split as follows: $e_A = uv = A \xrightarrow{r} E \xrightarrow{s} A$, and $e_B = vu = B \xrightarrow{r'} E' \xrightarrow{s'} B$. Using Statement (i) of Lemma 9.16, and Statement (i) of Lemma 9.20, we know that E is both a linear monoid and a linear comonoid.

It remains to show that $E \overset{\bullet}{\dashv} E'$, and $E \dashv \overset{\bullet}{\dashv} E'$ give a \otimes -bialgebra on E , and a \oplus -bialgebra on E' . The proof that E is a \otimes -bialgebra is as follows:

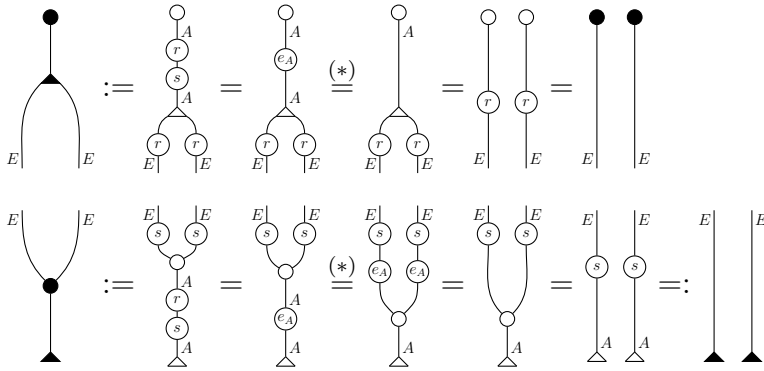

Where the steps labelled $(*)$ are because e_A is sectional on the linear monoid.

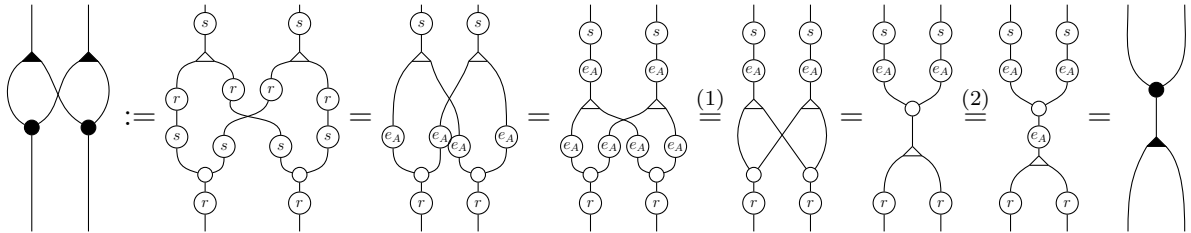

Where step (1) is because e_A is sectional on the linear comonoid, and step (2) is true because e_A is sectional on the linear monoid respectively. Similarly, E' is a \oplus -bialgebra. The converse is follows from Statement (i) of Lemma 9.16 and 9.20. \square

The above Lemma extends directly to \dagger -binary idempotents on \dagger -linear bialgebras.

9.3 Complementary linear bialgebras

In categorical quantum mechanics, Bohr's complementary principle is described using interacting commutative \dagger -Frobenius algebras in \dagger -monoidal categories. The aim of this section is to describe complementarity in isomix categories, for which, minimally, we require a self-linear bialgebra satisfying the equations described below.

Definition 9.24. A **complementary system** in an isomix category, \mathbb{X} , is a commutative and cocommutative self-linear bialgebra, $\frac{(a,b)}{(a',b')}: A \overset{\circ}{\dashv} A$ such that the following equations (with their ‘op’ symmetries) hold:

$$\begin{array}{ccc}
 \text{[comp.1]} & \text{[comp.2]} & \text{[comp.3]}
 \end{array}$$

A **†-complementary system** in a †-isomix category is a †-self-linear bialgebra which is also a complementary system.

By ‘op’ symmetry, we refer to the vertical reflection of the diagrams. The ‘co’ symmetry (horizontal reflection) of the equations are immediate from the commutativity and cocommutativity of the linear bialgebra.

Notice that we are using the alternate presentation of linear monoids by actions and coactions (see Proposition 8.8). Thus, [comp.1] requires that the counit of the linear comonoid is dual to the counit via the linear monoid dual, while [comp.2] requires that the unit of the linear monoid is dual to the counit via dual of the linear comonoid. Finally, [comp.3] requires that the coaction map of the linear monoid duplicates the unit of †-linear comonoid. The ‘op’ symmetry of equations [comp.1]-[comp.3] hold automatically for a †-complementary system.

In a monoidal category, a complementary system is given by a pair of commutative and cocommutative Frobenius algebras, $(A, \varphi, \rho, \alpha, \beta)$ and $(A, \psi, \tau, \gamma, \delta)$, interacting to produce pair of Hopf Algebras with the following antipodes [76, Definition 6.3].



In [60, Theorem 6.4], Duncan and Dunne proved that a pair of commutative †-Frobenius Algebras is a complementary system if and only if the following conditions hold:

$$\begin{array}{cc}
 \text{[comp.1]} & \text{[comp.2]}
 \end{array}$$

Note that the ‘op’ symmetry of [comp.1] is similar to the equation on the left and [comp.2] is similar to the equation on the right. In the following lemma, we prove that in an isomix category, the \otimes and the \oplus -bialgebras of a complementary system are Hopf:

Lemma 9.25. If $A \overset{\circ}{\dashv} A$ is a complementary system in an isomix category, then A is \otimes -

[comp.2]:

[comp.3]:

For the converse assume that, $E \overset{\bullet}{\dashv} E$ is a complementary system given by splitting a sectional or retractional binary idempotent (u, v) on a linear bialgebra $A \overset{\circ}{\dashv} B$. We show that $A \overset{\circ}{\dashv} B$ satisfies the equations, (a)-(c) given in the statement of the Lemma.

(a):

(b):

(c):

□

In the next section, we provide an example of Lemma 9.26 using exponential modalities.

9.4 Exponential modalities

Linear logic [68] treats formulae/types as depletable resources, hence the name ‘linear’ logic. However, it also allows for non-linear types, that is, resources that can be renewed indefinitely and erased, by means of the exponential operator, ! (read as the ‘bang’). The aim of this section is to show that there is a relationship between the ! operator of linear logic and complementarity, furthermore, a relationship which suggests a different perspective on measurement and complementarity in quantum systems.

9.4.1 Exponential modalities for monoidal categories

We first explore the semantics of the $!$ operator in symmetric monoidal categories (SMCs). In a SMC, the $!$ operator is a functor which is a comonad. The objects to which the $!$ functor has been applied can be duplicated and erased, thus, for all objects A , $!A$ is a cocommutative comonoid. Moreover, the comonad structure behaves coherently with the comonoid structure. Such a functor is called a coalgebra comodality. Finally, the $!$ -coalgebra modality behaves coherently with the tensor product, hence is monoidal.

Definition 9.27. [24] A **colagebra modality** for a symmetric monoidal category consists of a comonad $(!, \delta, \epsilon)$ and natural transformations $\Delta_A : !A \rightarrow !A \otimes !A$ and $\lrcorner_A : !A \rightarrow I$ such that $(!A, \Delta_A, e_A)$ is a cocommutative comonoid and $\delta_A : !A \rightarrow !!A$ preserves the comultiplication, that is,

$$\begin{array}{ccc} !A & \xrightarrow{\delta} & !!A \\ \Delta_A \downarrow & & \downarrow \Delta_{!A} \\ !A \otimes !A & \xrightarrow{\delta \otimes \delta} & !!A \otimes !!A \end{array}$$

For a coalgebra modality, $(!, \delta, \epsilon)$, and for any object A , $\delta_A : !A \rightarrow !!A$ is a comonoid morphism since it can be shown that δ preserves the counit.

Definition 9.28. [23] A coalgebra modality, $(!, \delta, \epsilon, \Delta, \lrcorner)$, is **monoidal** if $(!, \delta, \epsilon)$ is a monoidal comonad, (that is, $(!, m_\otimes, m_I)$ is a monoidal functor, and δ and ϵ are monoidal transformations), such that Δ and e are monoidal transformations:

$$\begin{array}{ccc} !A \otimes !B & \xrightarrow{m_\otimes} & !(A \otimes B) \\ \Delta \otimes \Delta \downarrow & & \downarrow \Delta \\ !A \otimes !A \otimes !B \otimes !B & & \\ 1 \otimes c_\otimes \otimes 1 \downarrow & & \\ !A \otimes !B \otimes !A \otimes !B & \xrightarrow{m_\otimes \otimes m_\otimes} & !(A \otimes B) \otimes !(A \otimes B) \end{array} \quad \begin{array}{ccc} !A \otimes !B & \xrightarrow{m_\otimes} & !(A \otimes B) \\ m_I \otimes m_I \downarrow & & \downarrow m_I \\ I \otimes I & \xrightarrow{\quad} & I \end{array}$$

$$\begin{array}{ccc} I & \xrightarrow{m_I} & !I \\ \parallel & & \downarrow \Delta \\ I \otimes I & \xrightarrow{m_I \otimes m_I} & !I \otimes !I \end{array} \quad \begin{array}{ccc} I & \xrightarrow{m_I} & !I \\ & \searrow & \downarrow \lrcorner_I \\ & & I \end{array}$$

and Δ and e are $!$ -colagebra morphisms:

$$\begin{array}{ccc} !A & \xrightarrow{\delta} & !!A \\ \Delta \downarrow & & \downarrow \Delta \\ !A \otimes !A & \xrightarrow{\delta \otimes \delta} & !!A \otimes !!A \xrightarrow{m_\otimes} & !(!A \otimes !A) \end{array} \quad \begin{array}{ccc} !A & \xrightarrow{\delta} & !!A \\ e \downarrow & & \downarrow \lrcorner_I \\ I & \xrightarrow{m_I} & !I \end{array}$$

Monoidal coalgebra modalities, also referred to as **exponential modalities** [108], pro-

vide a semantics for the exponential operator of linear logic in SMCs. Symmetric monoidal closed categories with exponential modalities are referred to as **linear categories** [20].

Definition 9.29. [89, 90] *A coalgebra modality is said to be a **free** if, for any object A , $(!A, \Delta_A, \perp_A)$ is a cofree cocommutative comonoid, that is, if (B, d, e) is a cocommutative comonoid, then for all maps $f : B \rightarrow A$, there exists a unique comonoid morphism from $f^\flat : (B, d, e) \rightarrow (!A, \Delta_A, \perp)$ such that the following diagram commutes.*

$$\begin{array}{ccc} (B, d, e) & \xrightarrow{f} & A \\ \exists! f^\flat \downarrow & \searrow & \\ (!A, \Delta_A, \perp) & \xrightarrow{\epsilon_A} & A \end{array}$$

A free colagebra modality is also a monoidal colagebra modality. Such a monoidal coalgebra modality is called a **free exponential modality**. Lafont, in his PhD thesis [89], provided an important source of examples for free exponential modalities by proving that:

Proposition 9.30. *In a symmetric monoidal category, \mathbb{X} , if every object A generates a cofree cocommutative comonoid $!A$, then \mathbb{X} has a free exponential modality.*

The proof can be sketched as follows. If \mathbb{X} is a symmetric monoidal category in which every object A freely generates a cocommutative comonoid, then the underlying functor $U : \mathbf{Comon}[\mathbb{X}] \rightarrow \mathbb{X}$, where $\mathbf{Comon}[\mathbb{X}]$ is the SMC of comonoids in X and comonoid morphisms between them, has a right adjoint, say $F : \mathbb{X} \rightarrow \mathbf{Comon}[\mathbb{X}]$, which maps each object A to its cofree commutative comonoid, $!A$, and each $f : A \rightarrow B$ in \mathbb{X} to the unique comonoid morphism $(\epsilon_A f)^\flat : (!A, \Delta_A, \perp_A) \rightarrow (!B, \Delta_B, \perp_B)$ given by the couniversal property of $(!B, \Delta_B, \perp_B)$. The comonad given by composing the forgetful functor, U , with the cofree functor, F , is a exponential modality. We discuss examples of categories with free exponential modalities later in section 10.2.

The free exponential modality has been used as a de facto structure for modelling infinite dimensional systems: [117] used the exponential modality to model the quantum harmonic oscillator, [26] used it to model the bosonic Fock space.

9.4.2 Exponential modalities for \dagger -LDCs

An LDC is said to have exponential modalities if it is equipped with a linear comonad $((!, ?), (\epsilon, \eta), (\delta, \mu))$. This means that:

Definition 9.31. [22, Definition 2.1] *A **!-?-LDC (an exponential LDC)** is an LDC, \mathbb{X} , with a comonad $(!, \delta, \epsilon)$, and a monad $(?, \mu, \eta)$ such that*

- (i) $(!, ?) : \mathbb{X} \rightarrow \mathbb{X}$ is a linear functor;

(ii) The pairs (δ, μ) , (ϵ, η) , (Δ, ∇) , and (\perp, Υ) are linear transformations.

(iii) For each object $A \in \mathbb{X}$, $(!A, \Delta_A, \perp_A)$ is a commutative \otimes -comonoid, and $(?A, \nabla_A, \Upsilon_A)$ is a commutative \oplus -monoid.

The linearity of the functors in a $(!, ?)$ -LDC means that $(!, \delta, \epsilon)$ is monoidal comonad while $(?, \mu, \eta)$ is a comonoidal monad, and $(!(A), \Delta_A, \perp_A)$ is a natural cocommutative comonoid while $(?(A), \nabla_A, \Upsilon_A)$ is a natural commutative monoid.

A \dagger - $(!, ?)$ -LDC is a $(!, ?)$ -LDC in which all the functors and natural transformations are \dagger -linear:

Definition 9.32. A \dagger - $(!, ?)$ -linearly distributive category is a $(!, ?)$ -LDC and a \dagger -LDC such that the following holds:

(i) $(!, ?)$ is a \dagger -linear functor i.e., we have that:

$$!(A^\dagger) \xrightarrow[\simeq]{s} (?A)^\dagger \quad !(A)^\dagger \xrightarrow[\simeq]{t} ?(A^\dagger)$$

is a linear natural isomorphism such that

$$\begin{array}{ccc} !X \xrightarrow{\iota} (!X)^{\dagger\dagger} & & ?X \xrightarrow{\iota} (?X)^{\dagger\dagger} \\ !\iota \downarrow & (a) & \downarrow (t^{-1})^\dagger \\ !(X^{\dagger\dagger}) \xrightarrow{s} (?X^{\dagger\dagger})^\dagger & & ?(X^{\dagger\dagger}) \xrightarrow[t^{-1}]{t} !(X^{\dagger\dagger})^\dagger \end{array} \quad (9.3)$$

(ii) The pair $\Delta_A : !A \rightarrow !A \otimes !A$, and $\nabla_A : ?A \oplus ?A \rightarrow ?A$ is a \dagger -linear natural transformation. i.e., the following diagrams commute:

$$\begin{array}{ccc} !(A^\dagger) \xrightarrow{\Delta} !(A^\dagger) \otimes !(A^\dagger) & & (!A \otimes !A)^\dagger \xrightarrow{\Delta^\dagger} (!A)^\dagger \\ \downarrow s & & \downarrow \lambda_\oplus^{-1} \\ (a) \quad (?A)^\dagger \otimes (?A)^\dagger & & (!A)^\dagger \oplus (!A)^\dagger \\ \downarrow \lambda_\otimes & & \downarrow t \\ (?A)^\dagger \xrightarrow{\nabla^\dagger} (?A \oplus ?A)^\dagger & & ?(A^\dagger) \oplus ?(A^\dagger) \xrightarrow{\nabla} ?(A^\dagger) \end{array} \quad (9.4)$$

Δ is completely determined by ∇ and vice versa.

(iii) The pair, $\Upsilon : !A \rightarrow \top$ and $\perp : \perp \rightarrow ?A$ is a \dagger -linear natural transformation i.e., the

following diagrams commute:

$$\begin{array}{ccc}
!(A^\dagger) & \xrightarrow{\perp} & \top \\
s \downarrow & (a) & \downarrow \lambda_\top \\
(?A)^\dagger & \xrightarrow{\top^\dagger} & \perp^\dagger
\end{array}
\qquad
\begin{array}{ccc}
\top^\dagger & \xrightarrow{\perp^\dagger} & !(A)^\dagger \\
\lambda_\perp^{-1} \downarrow & (b) & \downarrow t \\
\perp & \xrightarrow{\top} & (?A)^\dagger
\end{array}
\tag{9.5}$$

(iv) The pair $\delta : !A \rightarrow !!A$, and $\mu : ??A \rightarrow ?A$ is a \dagger -linear natural transformation:

$$\begin{array}{ccc}
!(A^\dagger) & \xrightarrow{\delta} & !!(A^\dagger) \\
s \downarrow & (a) & \downarrow !s \\
(?A)^\dagger & \xrightarrow{\mu^\dagger} & (??A)^\dagger
\end{array}
\qquad
\begin{array}{ccc}
(!!A)^\dagger & \xrightarrow{\delta^\dagger} & !(A)^\dagger \\
t \downarrow & (b) & \downarrow t \\
??(A^\dagger) & \xrightarrow{\mu} & ?(A^\dagger)
\end{array}
\tag{9.6}$$

The pair $\epsilon_A : !A \rightarrow A$, and $\eta_A : A \rightarrow ?A$ is a \dagger -linear natural transformation i.e., the following diagrams commute:

$$\begin{array}{ccc}
!(A^\dagger) & \xrightarrow{\epsilon} & A^\dagger \\
s \downarrow & (a) & \parallel \\
(?A)^\dagger & \xrightarrow{\eta^\dagger} & A^\dagger
\end{array}
\qquad
\begin{array}{ccc}
A^\dagger & \xrightarrow{\epsilon^\dagger} & !(A)^\dagger \\
\parallel & (b) & \downarrow t \\
A^\dagger & \xrightarrow{\eta} & ?(A^\dagger)
\end{array}
\tag{9.7}$$

In a $(!, ?)$ -LDC, any dual, $(a, b) : A \dashv\vdash B$, induces a dual, $(a_!, b_?) : !A \dashv\vdash ?B$ (see the diagrams below), on the exponential modalities using the linearity of $(!, ?)$. This means that, any dual induces a linear comonoid, $(a_!, b_?) : !A \dashv\vdash ?B$, where the comonoid structure is given by the modality.

$$a_! := \boxed{\begin{array}{c} \alpha \\ \downarrow \\ !A \quad \downarrow \quad ! \\ \uparrow \\ ?B \end{array}} = m_\top (!\alpha) \nu_\otimes \qquad
b_? := \boxed{\begin{array}{c} ?B \\ \downarrow \\ \beta \\ \downarrow \\ A \quad \downarrow \quad ? \\ \uparrow \\ ? \end{array}} = \nu_\oplus (? \epsilon) n_\perp \qquad
m_F := \boxed{\begin{array}{c} F_\otimes(A) \\ \downarrow \\ F_\otimes(A) \\ \downarrow \\ F_\otimes(A) \\ \downarrow \\ F_\otimes(A) \end{array}} = m_\otimes F_\otimes(m)$$

Any linear functor (F_\otimes, F_\oplus) applied to a linear monoid $(\alpha, \beta) : A \overset{\circ}{\dashv\vdash} B$ always produces a linear monoid $(\alpha_F, \beta_F) : F_\otimes(A) \overset{\square}{\dashv\vdash} F_\oplus(B)$ with multiplication m_F as shown in the above diagram. This simple observation when applied to the exponential modalities has a striking effect:

Lemma 9.33. *In any $(!, ?)$ -LDC any linear monoid $(a, b) : A \overset{\circ}{\dashv\vdash} B$ and an arbitrary dual $(a', b') : A \dashv\vdash B$ gives a linear bialgebra $\frac{(a_!, b_?)}{(a'_!, b'_?)} : !A \overset{\square}{\dashv\vdash} ?B$ using the natural cocommutative comonoid $(!A, \Delta_A, \perp_A)$.*

Proof. Given that $A \overset{\circ}{\dashv\vdash} B$ is a linear monoid, and $(a, b) : A \dashv\vdash B$ is a linear dual in a $!?$ -LDC.

Because, $(!, ?)$ are linear functors, and linear functors preserve linear monoids, we know that $!A \boxplus ?B$ is a linear monoid.

Similarly, by linearity of $(!, ?)$, we have the dual $(a'_1, b'_?) : !A \dashv ?B$. The cocommutative \otimes -comonoid $(!A, \Delta_A, e_A)$ given by the modality $!$ together with the dual $(a'_1, b'_?) : !A \dashv ?B$ gives a linear comonoid $!A \dashv ?B$. Note that, $(!A, \Delta_A, e_A)$ is dual to the commutative comonoid $(?B, \nabla_B, u_B)$ given by the $?$ modality, using $(a', b') : !A \dashv ?B$:

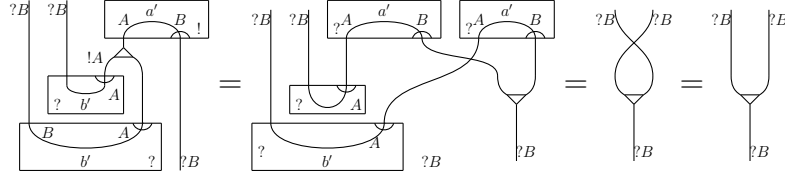

The linear monoid $!A \boxplus ?B$ and the linear comonoid $!A \dashv ?B$ gives a \otimes -bialgebra on $!A$ and a \oplus -bialgebra on $?B$. The bialgebra rules are immediate by naturality of Δ , ∇ , Υ , and \downarrow :

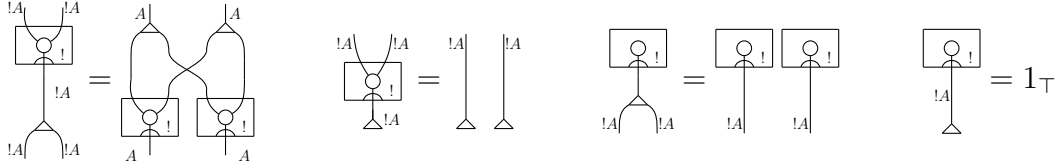

□

Lemma 9.34. *In any $(!, ?)$ - \dagger -LDC any \dagger -linear monoid $(a, b) : A \overset{\circ}{\dashv} A^\dagger$ and an arbitrary \dagger -dual $(a', b') : !A \dashv A^\dagger$ gives a \dagger -linear bialgebra $\frac{(a, b)}{(a', b')} : !A \boxplus ?A^\dagger$.*

Proof. Recall that there exists a natural isomorphism $t : (!A)^\dagger \rightarrow ?A^\dagger$ because $(!, ?)$ is a \dagger -linear functor. $(a_1, b_?) : !A \overset{\circ}{\dashv} ?A^\dagger$ is a \dagger -linear monoid because \dagger -linear functors preserve \dagger -linear monoids. Hence, $(a_1, b_?) : !A \overset{\circ}{\dashv} ?A^\dagger$ is a \dagger -linear monoid. $(a'_1, b'_?) : !A \dashv ?A^\dagger$ is a \dagger -linear comonoid because \dagger -linear functors preserve \dagger -duals, and (Δ, ∇) are \dagger -linear transformations i.e.,

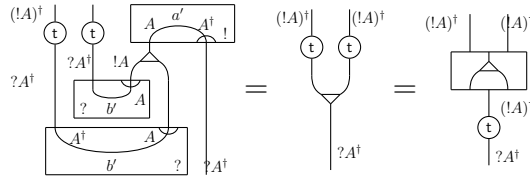

From Lemma 9.33, $!A \boxplus ?A^\dagger$ is a linear bialgebra. Thereby, $!A \boxplus ?A^\dagger$ is a \dagger -linear bialgebra. □

The bialgebra structure results from the naturality of Δ and \downarrow over the functorially induced monoid structure.

Next we explore the bialgebra structure induced by the free exponential modalities and their connection to complementary systems.

9.4.3 Sequent calculus for exponential \dagger -linear logic

In the sequent calculus for linear logic, the rules for the exponentials $!$ and $?$ are given as in Figure 9.1.

$$\begin{array}{ll}
(thin.L) \frac{\Gamma \vdash \Delta}{\Gamma, !A \vdash \Delta} & (thin.R) \frac{\Gamma \vdash \Delta}{\Gamma \vdash \Delta, ?B} \\
(der.L) \frac{\Gamma, A \vdash \Delta}{\Gamma, !A \vdash \Delta} & (der.R) \frac{\Gamma \vdash \Delta, B}{\Gamma \vdash \Delta, ?B} \\
(contr.L) \frac{\Gamma, !A, !A \vdash \Delta}{\Gamma, !A \vdash \Delta} & (contr.R) \frac{\Gamma \vdash \Delta, ?B, ?B}{\Gamma \vdash \Delta, ?B} \\
(stor.L) \frac{! \Gamma, A \vdash ? \Delta}{! \Gamma, ?A \vdash ? \Delta} & (stor.R) \frac{! \Gamma \vdash ? \Delta, B}{! \Gamma \vdash ? \Delta, !B}
\end{array}$$

Figure 9.1: Sequent rules for exponential modality

Categorically, the sequent rules, $(thin.L)$ and $(contr.L)$, means that $!A$ is a cocommutative comonoid. Similary, the rules, $(thin.R)$ and $(contr.R)$, means that $?B$ is a commutative monoid. The storage rules $(stor.L)$ and $(stor.R)$, and dereliction rules $(der.L)$ and $(der.R)$ makes $(!, ?)$ a linear functor, as shown in the figure 9.2. Moreover, the linear functor is also a linear comonad, see [22] for details.

$$\frac{\frac{\Gamma, A \vdash \Delta}{! \Gamma, A \vdash ? \Delta} der.L, der.R}{! \Gamma, ?A \vdash ? \Delta} stor.L \quad \frac{\frac{\Gamma \vdash B, \Delta}{! \Gamma \vdash B, ? \Delta} der.L, der.R}{! \Gamma \vdash !B, ? \Delta} stor.R$$

Figure 9.2: Derivation of $(!, ?)$ linear functor

In the presence of \dagger , the $(!, ?)$ exponential modality must satisfy the additional rules given in Figure 9.3 which $(!, ?)$ a \dagger -linear functor. Derivations of the isomorphisms $\mathbf{s} : (?A)^\dagger \longrightarrow (!A)^\dagger$, and $\mathbf{t} : (!A)^\dagger \longrightarrow (?A^\dagger)$ for $(!, ?)$ to be a \dagger -linear functor are shown Figures 9.4, and 9.5.

$$(\dagger-exp.L) \frac{\Gamma, ?(A^\dagger) \vdash \Delta}{\Gamma, (!A)^\dagger \vdash \Delta} \quad (\dagger-exp.R) \frac{\Gamma \vdash \Delta, !(B^\dagger)}{\Gamma \vdash \Delta, (?B)^\dagger}$$

Figure 9.3: Sequent rules for \dagger -exponential modality

In a $(!, ?)$ - \dagger -LDC, for any \dagger -dual, A , $!A$ is a \dagger -dual, because the pair $(!, ?)$ is a \dagger -linear functor, and \dagger -linear functor preserve \dagger -duals. Figure 9.6 shows the proof in sequent calculus, that, if A is a \dagger -dual, then $!A$ is also a \dagger -dual.

$$\begin{array}{c}
\frac{\overline{A \vdash A} \text{ id}}{A^{\dagger\dagger} \vdash A} \iota L \\
\frac{\quad}{?(A^{\dagger\dagger}) \vdash ?A} (!, ?) \text{ linear functor} \\
\frac{\quad}{(!A^{\dagger})^{\dagger} \vdash ?A} \dagger\text{-exp.L} \\
\frac{\quad}{(?A)^{\dagger} \vdash (!A^{\dagger})^{\dagger}} \dagger \\
\frac{\quad}{(?A)^{\dagger} \vdash (!A^{\dagger})} \iota R^{(-1)}
\end{array}
\qquad
\begin{array}{c}
\frac{\overline{A \vdash A} \text{ id}}{A^{\dagger} \vdash A^{\dagger}} \dagger \\
\frac{\quad}{!(A^{\dagger}) \vdash !(A^{\dagger})} (!, ?) \text{ linear functor} \\
\frac{\quad}{!(A^{\dagger}) \vdash (?A)^{\dagger}} \dagger\text{-exp.R}
\end{array}$$

Figure 9.4: Derivation of the isomorphism $s : (?A)^{\dagger} \rightarrow !(A^{\dagger})$

$$\begin{array}{c}
\frac{\overline{A \vdash A} \text{ id}}{A \vdash A^{\dagger\dagger}} \iota R \\
\frac{\quad}{!A \vdash !(A^{\dagger\dagger})} (!, ?) \text{ linear functor} \\
\frac{\quad}{!A \vdash (?A^{\dagger})^{\dagger}} \dagger\text{-exp.R} \\
\frac{\quad}{(?A^{\dagger})^{\dagger} \vdash (!A)^{\dagger}} \dagger \\
\frac{\quad}{?(A^{\dagger}) \vdash (!A)^{\dagger}} \iota L^{(-1)}
\end{array}
\qquad
\begin{array}{c}
\frac{\overline{A \vdash A} \text{ id}}{A^{\dagger} \vdash A^{\dagger}} \dagger \\
\frac{\quad}{?(A^{\dagger}) \vdash ?(A^{\dagger})} (!, ?) \text{ linear functor} \\
\frac{\quad}{(!A)^{\dagger} \vdash ?(A^{\dagger})} \dagger\text{-exp.L}
\end{array}$$

Figure 9.5: Derivation of the isomorphism $t : (!A)^{\dagger} \rightarrow ?(A^{\dagger})$

$$\frac{\frac{\overline{A \vdash A} \text{ id}, (\top L)}{\vdash A, A^{\dagger}} \dagger\text{-dual.R}}{\vdash !A, ?(A^{\dagger})} (!, ?) \text{ linear functor} \quad \frac{?(A^{\dagger}) \vdash (!A)^{\dagger}}{\vdash !A, (!A)^{\dagger}} \text{ cut}}{\top \vdash !A \oplus (!A)^{\dagger}} (\top L), (\oplus R)$$

$$\frac{\frac{\overline{A \vdash A} \text{ id}}{A^{\dagger}, A \vdash} \dagger\text{-dual.L}}{?(A^{\dagger}), !A \vdash} (!, ?) \text{ linear functor}}{(!A)^{\dagger}, !A \vdash} \dagger\text{-exp.L}}{(!A)^{\dagger} \otimes !A \vdash \perp} (\otimes L), (\perp R)$$

Figure 9.6: Sequent proof:- $!A$ is a \dagger -dual if A is a \dagger -dual

9.4.4 Complementarity from free exponential modalities

In this section, we prove that, in a \dagger -isomix category with free exponentials, every \dagger -complementary system arises as a compaction of a \dagger -linear bialgebra induced by the free exponentials. For this, we consider any complementary system in an isomix category and the linear bialgebra induced on the complementary system by the free exponential modalities (as in Lemma 9.33). We show that the induced linear bialgebra is equipped with a sectional coring binary idempotent which splits to give the original complementary system.

Definition 9.35. A $(!, ?)$ -LDC has **free exponential modalities** [89] if, for any object A , $(!A, \Delta_A, \lrcorner_A)$ is a cofree cocommutative \otimes -comonoid and $(?A, \nabla_A, \Upsilon_A)$ is a free commutative \oplus -monoid. This means that, if (B, d, e) is a cocommutative comonoid, then for all map $f : B \rightarrow A$, there exists a unique comonoid morphism from $f^\flat : (B, d, e) \rightarrow (!A, \Delta_A, \lrcorner_A)$ such that the diagram (a) commutes. Similarly, if (C, m, u) is a commutative monoid, then for all $g : A \rightarrow C$, there exists a unique monoid morphism $g^\sharp : (?A, \nabla_A, \Upsilon_A) \rightarrow (C, m, u)$ such that diagram (b) commutes:

$$(a) \quad \begin{array}{ccc} (B, d, e) & \xrightarrow{f} & A \\ \exists! f^\flat \downarrow & \searrow & \\ (!A, \Delta_A, \lrcorner_A) & \xrightarrow{\epsilon_A} & A \end{array} \quad (b) \quad \begin{array}{ccc} A & \xrightarrow{\eta_A} & (?A, \nabla_A, \Upsilon_A) \\ & \searrow g & \downarrow \exists! g^\sharp \\ & & (C, m, u) \end{array}$$

The universal property of free exponential modalities in a $(!, ?)$ -LDC implies that given any dual, the linear comonoid induced on the dual by the free exponentials is couniversal in the following sense:

Lemma 9.36. In a $(!, ?)$ -LDC with free exponentials, if $(x, y) : X \dashv_{\bullet} Y$ is a linear comonoid and

$$(f, g) : ((x, y) : X \dashv Y) \rightarrow ((a, b) : A \dashv B)$$

is a morphism of duals then, the unique map (f^\flat, g^\sharp) induced by the universal property of the free exponential is a morphism of linear comonoids:

$$\begin{array}{ccc} (x, y) : X \dashv_{\bullet} Y & \xrightarrow{(f, g)} & (a, b) : A \dashv B \\ (f^\flat, g^\sharp) \downarrow & \searrow & \\ (a_1, b_?) : !A \dashv_{\circ} ?B & \xrightarrow{(\epsilon, \eta)} & \end{array}$$

Proof. Given that (f, g) is a morphism of duals. We must show that (f^\flat, g^\sharp) given by the universal property of $(!, ?)$ is a morphism of duals by showing the equation on the left, below,

holds. However, the equation on the left holds if and only if the equation on the right holds:

$$\begin{array}{c} X \\ \curvearrowright \\ f \\ \downarrow \\ !A \end{array} \begin{array}{c} x \\ \curvearrowright \\ \boxed{a} \\ \downarrow \\ Y \end{array} = \begin{array}{c} \boxed{a} \\ \downarrow \\ !A \end{array} \begin{array}{c} \downarrow \\ g^\sharp \\ \downarrow \\ Y \end{array} \Leftrightarrow \begin{array}{c} X \\ \downarrow \\ f^\flat \\ \downarrow \\ !A \end{array} = \begin{array}{c} \boxed{a} \\ \downarrow \\ !A \end{array} \begin{array}{c} \downarrow \\ g^\sharp \\ \downarrow \\ Y \end{array} \begin{array}{c} \downarrow \\ \downarrow \\ X \end{array}$$

Now, by the couniversal property of the $!$ functor, f^\flat is a unique comonoid homomorphism such that $f^\flat \epsilon = f$. To prove that the latter equation holds, it suffices to prove that:

$$\begin{array}{c} \boxed{a} \\ \downarrow \\ !A \end{array} \begin{array}{c} \downarrow \\ \epsilon \\ \downarrow \\ A \end{array} \begin{array}{c} \downarrow \\ g^\sharp \\ \downarrow \\ Y \end{array} \begin{array}{c} \downarrow \\ y \\ \downarrow \\ X \end{array} \stackrel{(1)}{=} \begin{array}{c} a \\ \downarrow \\ A \end{array} \begin{array}{c} \downarrow \\ \eta \\ \downarrow \\ Y \end{array} \begin{array}{c} \downarrow \\ y \\ \downarrow \\ X \end{array} = \begin{array}{c} a \\ \downarrow \\ A \end{array} \begin{array}{c} \downarrow \\ g \\ \downarrow \\ Y \end{array} \begin{array}{c} \downarrow \\ y \\ \downarrow \\ X \end{array} \stackrel{(2)}{=} \begin{array}{c} \downarrow \\ f \\ \downarrow \\ A \end{array} \begin{array}{c} \downarrow \\ y \\ \downarrow \\ X \end{array}$$

Where (1) is holds because (ϵ, η) is a linear transformation, while (2) holds as f and g are mates.

$$\begin{array}{c} \boxed{a} \\ \downarrow \\ !A \end{array} \begin{array}{c} \downarrow \\ \epsilon \\ \downarrow \\ A \end{array} \begin{array}{c} \downarrow \\ g^\sharp \\ \downarrow \\ Y \end{array} \begin{array}{c} \downarrow \\ y \\ \downarrow \\ X \end{array} \stackrel{(1)}{=} \begin{array}{c} \boxed{a} \\ \downarrow \\ !A \end{array} \begin{array}{c} \downarrow \\ \epsilon \\ \downarrow \\ A \end{array} \begin{array}{c} \downarrow \\ g^\sharp \\ \downarrow \\ Y \end{array} \begin{array}{c} \downarrow \\ y \\ \downarrow \\ X \end{array} \stackrel{(2)}{=} \begin{array}{c} \boxed{a} \\ \downarrow \\ !A \end{array} \begin{array}{c} \downarrow \\ \epsilon \\ \downarrow \\ A \end{array} \begin{array}{c} \downarrow \\ g^\sharp \\ \downarrow \\ Y \end{array} \begin{array}{c} \downarrow \\ y \\ \downarrow \\ X \end{array} = \begin{array}{c} \boxed{a} \\ \downarrow \\ !A \end{array} \begin{array}{c} \downarrow \\ \epsilon \\ \downarrow \\ A \end{array} \begin{array}{c} \downarrow \\ g^\sharp \\ \downarrow \\ Y \end{array} \begin{array}{c} \downarrow \\ y \\ \downarrow \\ X \end{array}$$

Step (1) is uses the fact (Δ, ∇) is a linear transformation, while (2) holds as g^\sharp is a morphism of monoids. Hence, (f^\flat, g^\sharp) is a morphism of duals. \square

Next we prove that in a $(!, ?)$ -LDC with free exponential modalities, given any monoid the linear bialgebra induced on the monoid by the free exponentials as in Lemma 9.33 is couniversal in the following sense:

Lemma 9.37. *In $(!, ?)$ -LDC with free exponential modalities if $(X, \varphi, \uparrow, \triangleleft, \downarrow)$ is a \otimes -bialgebra, and $f : X \rightarrow A$ is a monoid morphism, then $f^\flat : X \rightarrow !A$ given by the couniversal property of the $!$ is a bialgebra homomorphism*

$$\begin{array}{ccc} (X, \varphi, \uparrow, \triangleleft, \downarrow) & & \\ \downarrow f^\flat & \searrow f & \\ (!A, \varphi_!, \uparrow_!, \Delta_A, \downarrow_A) & \xrightarrow{\epsilon_A} & (A, \varphi, \uparrow) \end{array}$$

where the multiplication and the unit for $!A$ is induced by linearity of $(!, ?)$:

$$\varphi_! := !A \otimes !A \xrightarrow{m_\otimes} !(A \otimes A) \xrightarrow{!(\varphi)} !A \quad \uparrow_! := \top \xrightarrow{m_\top} !\top \xrightarrow{!(\uparrow)} !A$$

Proof. Given that in a $(!, ?)$ -LDC with free exponential modalities, $(X, \varphi, \uparrow, \triangleleft, \downarrow)$ is a bial-

gebra, $(A, \curlywedge, \spadesuit)$ is a monoid, and $f : X \rightarrow A$ is a monoid morphism. The monoid on A induces a bialgebra on $(!A, \curlywedge_!, \spadesuit_!, \Delta_A, \lrcorner_A)$. We must show that f^b given by the couniversal property of $(!A, \Delta_A, \lrcorner_A)$ is a bialgebra morphism, that is, f^b is a monoid and a comonoid morphism.

From the given couniversal diagram, $f^b : (X, \curlywedge, \spadesuit) \rightarrow (!A, \Delta_A, e_A)$, is a comonoid morphism. We must prove that $f^b : (X, \curlywedge, \spadesuit) \rightarrow (!A, \curlywedge_!, \spadesuit_!)$ is a monoid morphism, that is the following diagrams commute:

$$(a) \quad \begin{array}{ccc} X \otimes X & \xrightarrow{f^b \otimes f^b} & !A \otimes !A \\ \curlywedge \downarrow & & \downarrow \curlywedge_! \\ X & \xrightarrow{f^b} & !A \end{array} \quad (b) \quad \begin{array}{ccc} \top & & \spadesuit_! \\ \spadesuit \downarrow & \searrow & \\ X & \xrightarrow{f^b} & !A \end{array}$$

In order to prove that (a) commutes, consider the following couniversal diagram.

$$\begin{array}{ccc} (\top, (u_{\otimes}^L)^{-1} = (u_{\otimes}^R)^{-1}, 1_{\top}) & & \\ \downarrow (\spadesuit f)^b & \searrow \spadesuit & \\ (!A, \Delta_A, \lrcorner_A) & \xrightarrow{\epsilon_A} & A \end{array} \quad \begin{array}{ccc} & & X \\ & & \searrow f \\ & & A \end{array}$$

Proving that $(\spadesuit f)^b = \spadesuit f^b$:

It is straightforward that $(\spadesuit f)^b \epsilon_A = \spadesuit f^b \epsilon_A = \spadesuit f$. Moreover, $\spadesuit f^b$ is a comonoid homomorphism because:

$$\begin{array}{ccc} \begin{array}{c} \circ \\ | \\ \text{f} \\ | \\ \text{f} \end{array} & \stackrel{(1)}{=} & \begin{array}{c} \circ \\ | \\ \text{f} \\ | \\ \text{f} \end{array} \\ \begin{array}{c} \circ \\ | \\ \text{f} \\ | \\ \text{f} \end{array} & \stackrel{(2)}{=} & \begin{array}{c} \circ \\ | \\ \text{f} \\ | \\ \text{f} \end{array} \end{array} \quad \begin{array}{ccc} \begin{array}{c} \circ \\ | \\ \text{f} \\ | \\ \triangle \end{array} & = & \begin{array}{c} \circ \\ | \\ \text{f} \\ | \\ \circ \end{array} \\ & \stackrel{(3)}{=} & 1_{\top} \end{array}$$

Where (1) is because $f^b : X \rightarrow !A$ is a comonoid morphism, and (2) and (3) are because X is a bialgebra.

Proving that $(\spadesuit f)^b = \lrcorner_!$:

We have that $\spadesuit_! \epsilon_A = m_{\top} !(\spadesuit) \epsilon_A = \spadesuit = \spadesuit f$ because ϵ_A is a monoidal transformation and f is a monoid homomorphism. Moreover, $\spadesuit_!$ is a comonoid morphism due to the naturality of Δ and \lrcorner .

By the uniqueness of \spadesuit^b , we have that $(\lrcorner f)^b \spadesuit_! = \spadesuit f^b$. Thereby, f^b preserves the unit of X . Thus, $f^b : (X, \curlywedge, \spadesuit) \rightarrow (!A, \curlywedge_!, \spadesuit_!)$ is a monoid homomorphism. Since f^b is a monoid and comonoid morphism, it is a bialgebra morphism. \square

The results discussed so far can be combined to give the more complicated observation on a linear bialgebra:

Proposition 9.38. *In a $(!, ?)$ -LDC with free exponential modalities, let $\frac{(x, y)}{(x', y')} : X \overset{\bullet}{\dashv} Y$ be a linear bialgebra, $(a, b) : A \overset{\circ}{\dashv} B$ a linear monoid, and $(a', b') : A \dashv B$ a dual, then*

$$(f^b, g^\sharp) : \left(\frac{(x, y)}{(x', y')} : X \overset{\bullet}{\dashv} Y \right) \rightarrow \left(\frac{(a_1, b_?)}{(a'_1, b'_?)} : !A \overset{\square}{\dashv} ?B \right)$$

is a morphism of bialgebras, whenever $f : (X, \blacktriangleright, \blacktriangleright) \rightarrow (A, \blacktriangleright, \blacktriangleright)$ is a morphism of monoids, and (f, g) is a morphism of both duals

$$(f, g) : ((x, y) : X \overset{\circ}{\dashv} Y) \rightarrow ((a, b) : A \overset{\circ}{\dashv} B) \quad \text{and} \quad (f, g) : ((x', y') : X \dashv Y) \rightarrow ((a', b') : A \dashv B)$$

Proof. We are given a linear monoid $(a, b) : A \overset{\circ}{\dashv} B$, and $(a', b') : A \dashv B$ is an arbitrary dual. Using Lemma 9.33, we know that $!A \overset{\square}{\dashv} ?B$ is a linear bialgebra.

We are given that (f, g) is a morphism of linear monoids, and a morphism of duals as in the diagram below. We must prove that (f^b, g^\sharp) is a morphism of bialgebras:

$$\begin{array}{ccc} \frac{(x, y)}{(x', y')} : X \overset{\bullet}{\dashv} Y & & \\ \downarrow (f^b, g^\sharp) & \searrow (f, g) & \\ \frac{(a_1, b_?)}{(a'_1, b'_?)} : !A \overset{\square}{\dashv} ?B & \xrightarrow{(\epsilon, \eta)} & (a, b) : A \overset{\circ}{\dashv} B ; (a', b') : A \dashv B \end{array}$$

Since $(f, g) : ((x', y') : X \dashv Y) \rightarrow ((a', b') : A \dashv B)$ is a morphism of duals it follows from Lemma 9.36 that $(f^b, g^\sharp) : ((x', y') : X \dashv Y) \rightarrow ((a'_1, b'_?) : !A \dashv ?B)$ is a morphism of linear comonoids.

Given that (f, g) is a morphism of linear monoids. This means that $(f, g) : ((x, y) : X \dashv Y) \rightarrow ((a, b) : A \dashv B)$ is a morphism of duals, and $f : (X, \blacktriangleright, \blacktriangleright) \rightarrow (A, \blacktriangleright, \blacktriangleright)$ is a morphism of monoids. We have to prove that (f^b, g^\sharp) is a morphism of linear monoids.

We know that (in a symmetric LDC) any dual with a \otimes -comonoid gives a linear comonoid. Hence, the dual $(x, y) : X \dashv Y$ and the \otimes -comonoid $(X, \blacktriangleright, \blacktriangleright)$ produces a linear comonoid $(x, y) : X \overset{\blacktriangleright}{\dashv} Y$. Now, the dual $(a, b) : A \dashv B$ induces a linear comonoid $(a_1, b_?) : !A \overset{\blacktriangleright}{\dashv} ?B$ on the exponential modalities. This leads to the situation as illustrated in the following diagram:

$$\begin{array}{ccc} (x, y) : X \overset{\blacktriangleright}{\dashv} Y & & \\ \downarrow (f^b, g^\sharp) & \searrow (f, g) & \\ (a_1, b_?) : !A \overset{\blacktriangleright}{\dashv} ?B & \xrightarrow{(\epsilon, \eta)} & (a, b) : A \dashv B \end{array}$$

Applying Lemma 9.36 to the above diagram, we have that (f^b, g^\sharp) is a morphism of duals. Note that, the linear comonoids on X and $!A$ in the above diagram are different from the linear comonoids in the $X \overset{\bullet}{\dashv} Y$ and $!A \overset{\square}{\dashv} ?B$ bialgebras.

It remains to prove that $f^b : (X, \wp, \uparrow) \rightarrow (!A, \wp_1, \uparrow_1)$ is a morphism of monoids. This is provided by the Lemma 9.37. \square

Corollary 9.39. *In a $(!, ?)$ -LDC with free exponential modalities, if $A \overset{\bullet}{\dashv} B$ is a linear bialgebra then $(1^b, 1^\sharp) : (A \overset{\bullet}{\dashv} B) \rightarrow (!A \overset{\square}{\dashv} ?B)$ is a morphism of bialgebras, making $A \overset{\bullet}{\dashv} B$ a retract of $!A \overset{\square}{\dashv} ?B$ as illustrated in the diagram below:*

$$\begin{array}{ccc}
 \frac{(a,b)}{(a',b')} : A \overset{\bullet}{\dashv} B & & \\
 \downarrow (1^b, 1^\sharp) & \searrow & \\
 \frac{(a_1, b_2)}{(a'_1, b'_2)} : !A \overset{\square}{\dashv} ?B & \xrightarrow{(\epsilon, \eta)} & \frac{(a,b)}{(a',b')} : A \overset{\bullet}{\dashv} B
 \end{array}$$

The corollary shows that every self-linear bialgebra in an $(!, ?)$ -LDC, with free exponential modalities, induces a sectional binary idempotent for the linear bialgebra induced on the exponential modalities:

$$!A \begin{array}{c} \xrightarrow{\epsilon} \\ \xleftarrow{1^b} \end{array} A \simeq B \begin{array}{c} \xrightarrow{\eta} \\ \xleftarrow{1^\sharp} \end{array} ?B$$

Moreover, the idempotent splits and it is coring whenever the self-linear bialgebra resides in the core.

Combining Corollary 9.39, and Lemma 9.26, we get:

Theorem 9.40. *In an $(!, ?)$ -isomix category with free exponential modalities, every complementary system arises as a splitting of a sectional binary idempotent on the free exponential modalities.*

The above results extend directly to \dagger -linear bilagebras in \dagger -LDCs with free exponential modalities due to the \dagger -linearity of $(!, ?)$, (η, ϵ) , (Δ, ∇) , and (\perp, Υ) .

Theorem 9.40 is a new observation in quantum theory: gives a non-functorial method to retrieve the ‘first quantization’ from the ‘second quantization’.

Chapter 10

Examples

In this chapter, we present examples of linear monoids and comonoids, and exponential modalities for LDCs.

10.1 Duals and linear monoids

This section is dedicated to discussing examples of (\dagger) -duals, and (\dagger) -linear monoids.

10.1.1 Duals in \mathbf{FRel} and $\mathbf{FMat}(R)$

In this section, we will examine the duals in \mathbf{FRel} , $\mathbf{FMat}(R)$, \mathbf{Rel} and $\mathbf{Mat}(R)$, where R is a commutative rig. We show that in \mathbf{FRel} , $\mathbf{FMat}(R)$ every dual is also a \dagger -dual. We will also prove that in \mathbf{Rel} and $\mathbf{Mat}(R)$, \dagger -duals coincide with unitary duals. Before proceeding with the proofs, we quickly recap the dual, dagger, tensor and the par products in \mathbf{FRel} and $\mathbf{FMat}(R)$.

In \mathbf{FRel} and $\mathbf{FMat}(R)$, the dual of a finiteness space, $(X, F(X), F(X)^\perp)^*$ is given by $(X, F(X)^\perp, F(X))$. For any finiteness relation, R , the dual relation R^* is the converse of R . For any finiteness matrix, M , the dual matrix, M^* , is given by transposing M .

Both \mathbf{FRel} and $\mathbf{FMat}(R)$ are conjugative $*$ -isomix categories, see 3.23. The conjugation functor, $\overline{(-)}$ along with the $*$ gives the \dagger functor: $(-)^{\dagger} = \overline{(-)}^* = \overline{(-)}^*$. In \mathbf{FRel} , the conjugation functor is the identity functor, hence, the \dagger coincides with the $*$ functor. In $\mathbf{FMat}(R)$, the conjugation functor is given by the conjugation for the rig R . Hence, the \dagger of a finiteness matrix is given by its conjugate transpose.

The category \mathbf{FRel} has a symmetric tensor product which is used to obtain a corresponding tensor product on $\mathbf{FMat}(R)$. The tensor product for \mathbf{FRel} is defined as follows: $X \otimes Y =$

$(X, F(X)) \otimes (Y, F(Y)) := (X \times Y, F(X \otimes Y), F(X \otimes Y)^\perp)$, where

$$F(X \otimes Y) := \downarrow \{A \times B \mid A \in F(X), B \in F(Y)\}$$

where $\downarrow \mathcal{A} := \{A' \mid A' \subseteq A, A \in \mathcal{A}\}$ is the downward closure of the set of subsets \mathcal{A} . The par is defined in the standard way:

$$X \oplus Y = (X^* \otimes Y^*)^*$$

The units of tensor and par are the same: $\top = \perp = (\{*\}, \{\emptyset, \{*\}\})$. Both \mathbf{FRel} and $\mathbf{FMat}(R)$ are symmetric \dagger -*-isomix categories.

Lemma 10.1. *In \mathbf{FRel} and $\mathbf{FMat}(R)$, every dual is also a \dagger -dual.*

Proof. We first prove the statement in \mathbf{FRel} . Let $(X, F(X), F(X)^\perp)$ be any finiteness space in \mathbf{FRel} . Consider its dual, $(\eta, \epsilon) : X \dashv X^*$. The relations $\eta : \top \rightarrow X \oplus X$, and the counit $\epsilon : X \otimes X \rightarrow \perp$ are same as for the duals in \mathbf{Rel} :

$$\eta := \{(*, (x, x)) \mid x \in X\} \quad \epsilon := \{((x, x), *) \mid x \in X\}$$

We prove that η , and ϵ are indeed finiteness relations. To prove that η is a finiteness relation, using Lemma 2.33-(iii), it suffices to prove the following:

- (i) for all $A \in F(\top) = \{\emptyset, \{*\}\}$, $A \triangleright \eta \in F(X \oplus X^\perp)$,
- (ii) for all $b \in X \oplus X^\perp = X \times X$, $\eta \triangleleft b \in F(\top)^\perp = \{\emptyset, \{*\}\}$.

(ii) is immediate. We prove that (i) holds: if $A = \emptyset$, then $A \triangleright \eta = \emptyset \in F(X \oplus X^\perp)$; if $A = \{*\}$ then:

$$A \triangleright \eta = \{(x, x) \mid x \in X\}$$

We have to show that $A \triangleright \eta \in F(X \oplus X^\perp)$. However, $F(X \oplus X^\perp) = F(X^\perp \otimes X^{\perp\perp})^\perp = F(X^\perp \otimes X)^\perp$. By Lemma 2.40, $A \triangleright \eta \in F(X^\perp \otimes X)^\perp$ if and only if the following conditions hold:

- (a) for all $P \in F(X)^\perp$, $P \triangleright S \in F(X)^\perp$
- (b) for all $Q \in F(X)$, $S \triangleleft Q \in F(X)^{\perp\perp} = F(X)$

where $S = A \eta$. However, it is clear that $P \triangleright S = P$, and $S \triangleleft Q = Q$, for all $P \in F(X)^\perp$, $Q \in F(X)$. Thus, $S = A \triangleright \eta \in F(X \oplus X^\perp)$. Thereby, η satisfies condition (i), and hence is a finiteness relation. Since ϵ is simply the converse of η , it is also a finiteness relation.

Finally, to prove that, in \mathbf{FRel} , every dual is a \dagger -dual, we must show that the following equation holds:

$$\begin{array}{c} \eta \\ \circlearrowleft \\ \downarrow \\ X^{\dagger\dagger} \end{array} \Big|_{X^\dagger} = \begin{array}{c} \boxed{\epsilon} \\ \downarrow \\ X^{\dagger\dagger} \end{array} \Big|_{X^\dagger}$$

However, the above equation is automatic because, in \mathbf{FRel} , for any finiteness space X , we have that $X^\dagger = X^*$ and $X = X^{\dagger\dagger}$. Moreover, for any finiteness relation, R , the finiteness relation R^\dagger is given by the converse of R , hence $\eta = \epsilon^\dagger$ as required.

The same proof extends to proving that in $\mathbf{FMat}(R)$ every dual is a \dagger -dual, since the support of every finiteness matrix is a finiteness relation. \square

Observe that when X is a finite set, the finiteness space is $(X, \mathcal{P}(X))$, which is a self-dual object. Such spaces lie in the core of $\mathbf{FMat}(R)$, and gives the subcategory $\mathbf{Mat}(R)$ which is a \dagger -compact closed category. Thus, every dual in $\mathbf{Mat}(R)$ is also \dagger dual. This leads one to wonder if, in $\mathbf{Mat}(R)$, the \dagger -duals coincide with the conventional dagger duals ($\eta^\dagger = c_{\otimes} \epsilon$).

To answer this question, we first determine the conditions under which a \dagger -dual is a unitary dual (see 4.3) in a unitary category. Recall that unitary categories are lax \dagger monoidal categories ($A \simeq A^\dagger$), and \dagger -monoidal categories are strict unitary categories ($A = A^\dagger$). When the unitary category is a \dagger -monoidal category, the unitary duals are precisely the conventional dagger duals.

Lemma 10.2. *Let $(\eta, \epsilon) : A \dashv_{\dagger} A^\dagger$ be a right \dagger -dual in a unitary category, then $(\eta, \epsilon) : A \dashv A^\dagger$ is a unitary dual if one of the following conditions hold:*

$$(a) \quad \begin{array}{c} \eta \\ \circlearrowleft \\ \downarrow \\ A \end{array} \Big|_{A^\dagger} = \begin{array}{c} \eta \\ \circlearrowleft \\ \downarrow \\ A^\dagger \end{array} \Big|_A \quad (or) \quad (b) \quad \begin{array}{c} A^\dagger \\ \downarrow \\ \epsilon \\ A \end{array} \Big|_{A^\dagger} = \begin{array}{c} A^\dagger \\ \downarrow \\ \epsilon \\ A \end{array} \Big|_{A^\dagger} \quad (10.1)$$

Let us now examine in $\mathbf{Mat}(R)$ if \dagger -duals coincide with unitary duals. $\mathbf{Mat}(R)$ is a \dagger -monoidal category in which every dual is also a unitary dual. Hence the category is \dagger -compact closed.

Lemma 10.3. *In $\mathbf{Mat}(R)$ and \mathbf{Rel} , every object is its own right and left \dagger -dual. Hence, every dual is a \dagger -dual.*

Proof. Let us first consider $\mathbf{Mat}(R)$. Recall from Section 6.2.3 that in $\mathbf{Mat}(R)$, every object n is a self-dual. Moreover, the involution, $\iota : n \rightarrow n^{\dagger\dagger}$ is I_n , the identity map. Given $(\eta, \epsilon) : n \dashv n$ we have that $\eta^\dagger = \epsilon$:

$$\eta^\dagger := \left(\sum_{i=1}^n (e_i \otimes e_i) \right)^T = \sum_{i=1}^n \left(\overline{(e_i \otimes e_i)} \right)^T = \sum_{i=1}^n (\bar{e}_i^T \otimes \bar{e}_i^T) = \sum_{i=1}^n (e_i^T \otimes e_i^T) =: \epsilon$$

By copyable basis, we mean that the comultiplication of the corresponding SCFA copies (duplicates) the basis elements. Similarly, given a SCFA, the corresponding basis is given by those vectors which the comultiplication of SCFA duplicates.

Example 10.6. [49] *Every commutative \dagger -Frobenius Algebra in FHilb corresponds precisely to an orthogonal copyable basis.*

Example 10.7. *The pants algebra are non-commutative \dagger -Frobenius algebra. Recall that in FHilb, pants algebra are given by the algebra of $n \times n$ complex matrices, See Section 6.4.1.*

The algebra of polynomials over a field K give a wealth of examples for linear monoids.

Example 10.8. *In FHilb, the basic Weil algebra, $\mathbb{C}[x]/x^2 = 0$, is a commutative \dagger -linear monoid.*

Proof. Consider the two-dimensional basic Weil algebra: $\mathbb{C}[x]/x^2 = 0$. The multiplication, m , for the algebra can be represented as a matrix, M , with 4 rows and 2 columns. The rows are indexed from top to bottom as, 1.1, 1.x, x.1 and x.x,. The columns are indexed from left to right as 1 and x . The multiplication matrix is given as follows:

$$M := \begin{bmatrix} 1 & 0 \\ 0 & 1 \\ 0 & 1 \\ 0 & 0 \end{bmatrix}$$

It is evident that $M^* = M^\dagger$, that is the transpose of M is the same as its conjugate transpose. Moreover, the multiplication is commutative. Hence, $\mathbb{C}[x]/x^2 = 0$ is a commutative \dagger -linear monoid.

Its not a \dagger -Frobenius algebra since the algebra is not generated by a copyable basis. The proof is as follows. For contradiction, let us assume that $\mathbb{C}[x]/x^2 = 0$ is generated by a copyable basis, and $b_i = a + bx$ be a basis element. Since the basis is copyable, we have that $(b_i \otimes b_i)m = b_i$. Using matrix representation of b_i we get the following equation:

$$\left[\begin{pmatrix} a & b \end{pmatrix} \otimes \begin{pmatrix} a & b \end{pmatrix} \right] M = \begin{pmatrix} a^2 & 2ab \end{pmatrix} = \begin{pmatrix} a & b \end{pmatrix}$$

The possible solutions to the above equation are: $b_i = \begin{pmatrix} 1 & 0 \end{pmatrix}$, $b_i = \begin{pmatrix} -1 & 0 \end{pmatrix}$, and $b_i = \begin{pmatrix} 0 & 0 \end{pmatrix}$. The matrices clearly do not produce a basis for the algebra. Hence, the given Weil algebra is not Frobenius. \square

Example 10.9. *In FHilb, The polynomial algebra $\mathbb{C}[x, y, z]/x^2 = 0, y^2 = 0, z^2 = 0, xy = iz, yx = -iz, xz = 0, zx = 0, yz = 0, zy = 0$ is a non-commutative \dagger -linear monoid.*

Proof. Consider the four-dimensional polynomial algebra,

$$\mathbb{C}[x, y, z]/x^2 = 0, y^2 = 0, z^2 = 0, xy = iz, yx = -iz, xz = 0, zx = 0, yz = 0, zy = 0$$

Consider the multiplication map m for the algebra. Note that for all $i, j \in \{1, x, y, z\}$, the conjugate of the multiplication coincides with the multiplication map:

$$\overline{m}(i, j) \stackrel{(1)}{=} \overline{m(j, i)} \stackrel{(2)}{=} m(i, j)$$

The step (1) is true because conjugation reverses the order of the types. For all i, j , the step (2) is true for the given algebra. Since the given monoid coincides with the conjugate monoid (equivalently \dagger of the monoid coincides with dual of the monoid), and the multiplication is non-commutative, we have a non-commutative \dagger -linear monoid.

As in the previous section, we prove that the algebra is not generated by a copyable basis. Assuming there exists a copyable basis for the algebra, consider any basis element $e_i = (a + bx + cy + dz)$. Solving the equation $e_i.e_i = e_i$ leads to the following situation:

$$a^2 = 0 \quad ab + ba = b \quad ac + ca = c \quad ad + da = d$$

The solutions for the above equations are: $a = 1, -1, 0$; $b = c = d = 0$, which is not a basis. This leads to a contradiction. Hence, the given algebra is not \dagger -Frobenius. \square

Example 10.10. In \mathbf{FHilb} , the following algebra is a commutative linear monoid:

$$C[x, y, z]/x^2 = 0, y^2 = 0, z^2 = 0, xy = iz, yx = iz, xz = 0, zx = 0, yz = 0, zy = 0$$

Proof. Recall that \mathbf{FHilb} is a symmetric KCC. Every object in the category comes with a chosen dual and the duals are symmetric. Hence, every monoid in this category is automatically a linear monoid. Note that the monoid is commutative. Hence, the given algebra is a commutative linear monoid.

It is not a commutative Frobenius algebra since there does not exist a copyable basis for the algebra: For contradiction, assume that $e_i = a + bx + cy + dz + e(yz)$ be an element of the copyable basis. Since the basis is copyable, the following must hold: $(e_i \otimes e_i)m = e_i$. Then we have that,

$$a^2 = a; \quad 2ab = b \quad 2ac = c \quad 2(ad + ibc) = d$$

The solutions for the above equations are: $a = 1, -1, 0$; $b = c = d = 0$, which is not a basis set. Hence, the given algebra cannot be Frobenius. \square

Example 10.11. In \mathbf{FHilb} , the following algebra is a non-commutative linear monoid:

$$\mathbb{C}[x, y, z]/x^2 = 0, y^2 = 0, z^2 = 0, xy = iz, yx = z, xz = 0, zx = 0, yz = 0, zy = 0$$

Proven similarly as the above examples.

10.2 Exponential Modalities

In this section we give a few examples of LDCs with free exponential modalities. [81, 90] discusses more examples of categories with free exponential modalities. Explicit constructions for free exponential modalities are discussed in [98, 113].

10.2.1 The free exponential modalities for \mathbf{Rel}

We know that \mathbf{Rel} , the category of sets and relations is a \dagger -compact closed category, See Section 6.2.1. Thus, \mathbf{Rel} is a compact LDC with $\otimes = \oplus$. The category \mathbf{Rel} comes with the free exponential modalities which are defined as follows:

- (i) For a set X , $!X$ is the set of all finite multisets of X :

$$!X := \{\llbracket x_1, \dots, x_n \rrbracket \mid x_i \in X\}$$

For a relation $R : X \rightarrow Y$, $!R$ relates multisets with same number of distinct elements such that the i^{th} distinct element of each multi-set is related by R :

$$!R := \{(\llbracket x_1, \dots, x_n \rrbracket, \llbracket y_1, \dots, y_n \rrbracket) \mid (x_i, y_i) \in R\}$$

In \mathbf{Rel} , since each object is self-dual, $?X = (!X)^{\dagger*} = !X$. Similarly, for any relation R ,

$$?R = (!R)^{\dagger*} = (?R^\circ)^\dagger = !(R^{\circ\circ})$$

where R° is the converse relation.

- (ii) $\delta_X : !X \rightarrow !!X$ relates a finite multiset of X to the set of all possible splittings of the multiset.

$$\delta_X := \{K, \llbracket K_1, K_2, \dots, K_n \rrbracket \mid K_1 \cup K_2 \cup \dots \cup K_n = B\} \subseteq !X \times !!X$$

Note that an element of $!!X$ is a finite multiset whose elements are finite multisets of X . $\mu_X : ??X \rightarrow ?X$ is the converse of δ_X .

(iii) $\epsilon_X : !X \rightarrow X$ relates multisets of a single element in X to the element itself. η_X is the converse of ϵ_X .

$$\epsilon_X := \{([\![x]\!], x) \mid x \in X\} \subseteq !X \times X$$

(iv) $(m_\otimes)_{X,Y} : !X \times !Y \rightarrow !(X \times Y)$ is the relation which relates the finite multisets of X and Y with equal number of distinct elements to the multiset given by their cartesian product:

$$(m_\otimes)_{X,Y} := \{([\![x_1, \dots, x_n]\!], [\![y_1, \dots, y_n]\!]), [(x_i, y_j)] \mid 0 < i, j \leq n \mid x_i \in X, y_j \in Y\} \\ \subseteq (!X \times !Y) \times !(X \times Y)$$

$(n_\otimes)_{X,Y} : ?(X \times Y) \rightarrow ?X \times ?Y$ is the converse of $(m_\otimes)_{X,Y}$.

(v) $m_I = \{*\} \rightarrow !\{*\}$ is simply the cartesian product, $\{*\} \times !\{*\}$, that is, m_I relates $*$ to every element of $!\{*\}$. The relation $n_I : ?\{*\} \rightarrow \{*\}$ is the converse of m_I

(vi) $\Delta_X : !X \rightarrow !X \times !X$ relates a finite multiset of X to pairs of finite multisets such that the pair is a splitting of the original multiset:

$$\Delta_X := \{K, (K_1, K_2) \mid K, K_1, K_2 \in !X, K_1 \cup K_2 = K\} \subseteq !X \times (!X \times !X)$$

$\nabla_X : ?X \otimes ?X \rightarrow ?X$ is the converse of Δ_X .

(vii) $\lrcorner_X : !X \rightarrow \{*\}$ relates the empty set from $!X$ to $*$. $\Upsilon_X : \{*\} \rightarrow ?X$ is the converse of \lrcorner_X .

$$\lrcorner_X := \{(\emptyset, *)\} \subseteq !X \times \{*\}$$

10.2.2 The free exponential modalities for FRel and FMat(R)

In [64] the exponential modalities for FRel and, more generally, FMat(R) are described. Furthermore, Christine Tasson in her PhD. thesis, [115], showed that this modality in FRel is *free* in the sense of Yves LaFont. The purpose of this section is to provide a review of these results and to establish also that the modality in Mat(R) is also free. This means that, by Theorem 9.40, in the MUC $\text{Mat}(\mathbb{C}) \leftrightarrow \text{FMat}(\mathbb{C})$, every complementary system within the unitary core arise as a compaction of a \dagger -linear bialgebra on the free exponentials.

In a symmetric monoidal category, we saw that, \mathbb{X} , an **coalgebra comodality** is given by a comonad

$$(! : \mathbb{X} \rightarrow \mathbb{X}, !(A) \xrightarrow{\varepsilon} A, !(A) \xrightarrow{\delta} !(!(A)))$$

in which each object $!(X)$ carries the structure of a cocommutative comonoid naturally

$$\top \xleftarrow{e} !(X) \xrightarrow{\Delta} !(A) \otimes !(A)$$

such that $\delta : !(A) \rightarrow !(!(A))$ is a morphism of these comonoids.

In a SMC with finite products and terminal object \top , a coalgebra comodality has **Seely isomorphisms** [20, 23] if the following natural transformations are isomorphisms:

$$s_{\top} : !\top \xrightarrow{\downarrow} I \quad s_{\otimes} : !(A \times B) \xrightarrow{\Delta} !(A \times B) \otimes !(A \times B) \xrightarrow{!(\pi_0) \otimes !(\pi_1)} !A \otimes !B$$

Hence, $!\top \simeq I$ and $!(A \times B) \simeq !A \otimes !B$.

In a SMC with finite products and terminal object, a coalgebra modality is monoidal if [20] and only if [23] it has the Seely isomorphisms: Often it is easier to exhibit Seely isomorphisms than to exhibit the monoidal structure directly.

In the category of sets and relations, Rel , it is well-known that the free exponential modality on a set X is $!(X) := \text{Bag}(X)$, that is, the set of all multisets of X (a multiset or a bag is a set which allows multiple instances of elements). Thus, in FRel we expect the web of the free exponential modality to be $\text{Bag}(X)$ the delicacy is define the finiteness structure. This was described in [64] as:

$$F(!(X)) := \{S \subseteq \text{Bag}(X) \mid S^{\cup} \in F(X)\}$$

where S^{\cup} is the union of all the bags in S . Thus, a finitary set of $!(X)$ is a set of bags, $S \subseteq \text{Bag}(X)$, the union of which is a finitary set of X . It is not obvious that this is an orthogonal closed subset:

Lemma 10.12. *As defined above $F(!(X)) = F(!(X))^{\perp\perp}$.*

Proof. Suppose that $S \in F(!(X))^{\perp\perp}$ we aim to show that it follows that $S \in F(!(X))$. Suppose, for contradiction, that $S \notin F(!(X))$ then there is a $w \in F(X)^{\perp}$ with $w' := S^{\cup} \cap w$ infinite. This means there is a function $f : w' \rightarrow S$ which associates to each $a \in w'$ an $f(a) \in S$ with $a \in f(a)$. Notice that $\text{cod}(f)$ is infinite as f is finitely fibred because each bag contains only finitely many elements.

However, $\text{cod}(f) \in F(!(X))^{\perp}$ as for each $T \in F(!(X))$ we have $\text{cod}(f) \cap T$ finite as

$$f^{-1}(\text{cod}(f) \cap T) \subseteq f^{-1}(\text{cod}(f)) \cap T^{\cup} \subseteq S^{\cup} \cap w \cap T^{\cup} \subseteq w \cap T^{\cup}$$

where $w \cap T^{\cup}$ is finite as $T \in F(!(X))$. But $\text{cod}(f) \cap S = \text{cod}(f)$ is infinite so S is not in $F(!(X))^{\perp\perp}$ and we are done. \square

We shall prove following [115], that $!(X)$, so defined, is a free exponential modality. An exponential modality is **free** in case given any cocommutative comonoid

$$\top \xleftarrow{u} X \xrightarrow{d} X \otimes X$$

and map $f : X \rightarrow A$ there is a unique homomorphism of comonoids $f^b : X \rightarrow !(A)$ such that $f^b \varepsilon = f : X \rightarrow A$, that is, the following diagrams commute:

$$\begin{array}{ccc} X & \xrightarrow{d} & X \otimes X \\ f \swarrow & & \downarrow f^b \otimes f^b \\ A & \xleftarrow{\varepsilon} & !(A) \xrightarrow{\Delta} !(A) \otimes !(A) \end{array} \quad \begin{array}{ccc} X & & \\ f^b \downarrow & \searrow u & \\ !(A) & \xrightarrow{e} & \top \end{array}$$

Recall that this property also provides the coherences required of an exponential modality by:

$$\begin{array}{cccc} !(A) & & !(A) & & !(A) \otimes !(B) & & \top \\ \downarrow !(f) & \searrow \varepsilon_A f & \downarrow \delta & \searrow \text{=} & \downarrow m_\otimes & \searrow \varepsilon_A \otimes \varepsilon_B & \downarrow m_\top \\ !(B) & \xrightarrow{\varepsilon_B} B & !(A) & \xrightarrow{\varepsilon_{!(A)}} !(A) & !(A \otimes B) & \xrightarrow{\varepsilon_{A \otimes B}} A \otimes B & !(\top) \xrightarrow{\varepsilon_\top} \top \end{array}$$

The map is the monoidal map and is defined using the cocommutative monoid with comultiplication

$$!(A) \otimes !(B) \xrightarrow{\Delta \otimes \Delta} !(A) \otimes !(A) \otimes !(B) \otimes !(B) \xrightarrow{1 \otimes c_\otimes \otimes 1} !(A) \otimes !(B) \otimes !(A) \otimes !(B)$$

and unit with comultiplication $\top \xrightarrow{u_\otimes^1} \top \otimes \top$.

Thus, once one establishes that a modality has this universal property all the required coherence properties are automatic. The fact that the exponential modalities are free in FRel is proven in [115]:

Lemma 10.13. *The exponential modality in FRel is free.*

Proof. From Rel we know that:

$$f^b := \{(x, \mu) \mid \exists n \text{ such that } x d^n(x_1, \dots, x_n), \mu = (a_1, \dots, a_n), \forall i \leq n \ x_i f a_i\}$$

where $d^n : X \rightarrow X^{\otimes n}$, is the unique relation making the diagram commute. We must show that f^b is a finiteness relation.

Towards this end consider $f^b \triangleleft \{(a_1, \dots, a_n)\}$ this the same as $d^n(f \otimes \dots \otimes f) \triangleleft \{(a_1, \dots, a_n)\}$ which is a cofinitary set of X as d^n and f are finiteness relations.

It remain to show that finitary relations are preserved by f^b . Let $W \in F(X)$ then we must show $W \triangleright f^b \in F(!A)$. But $W \triangleright f^b \in F(!A)$ if and only if $(W \triangleright f^b)^\cup \in F(A)$. But $a \in (W \triangleright f^b)^\cup$ if and only if there is a $w \in W$ with $(w, (a_1, \dots, a_n)) \in f^b$ and $a = a_i$. Further decomposing this gives $(w, (a_1, \dots, a_n)) \in f^b$ if and only if $(w, (x_1, \dots, x_n)) \in d^n$ and $(x_i, a) \in f$. As d is commutative we may assume $(x_1, a) \in f$ and also, using associativity, that $(w, (x_1, x_2)) \in d$ and $(x_1, a) \in f$. But that makes $(W \triangleright f^b)^\cup = (W \triangleright f) \cup \pi_0(W \triangleright d(f \otimes f))$ which is a finitary set as required. \square

Having free exponentials is a strong property but is certainly not unique to \mathbf{FRel} (for example see [52]). Our next task is to show that $\mathbf{FMat}(R)$ also has free exponentials. It is useful to first observe that, in \mathbf{FRel} there is a always transformation from the exponential modality to the modality of linear monoid (see Sec 10.3) because $!A$ is a comonoid:

$$\begin{array}{ccccc}
 & & !(X) & \xrightarrow{\Delta} & !(X) \otimes !(X) & \xrightarrow{\text{mix}} & !(X) \oplus !(X) \\
 & \nearrow \varepsilon_X & \downarrow \gamma_! & & & & \downarrow \gamma_! \oplus \gamma_! \\
 X & \xleftarrow{\pi_1} & !_w(X) & \xrightarrow{\Delta'} & !_w(X) \oplus !_w(X) & &
 \end{array}$$

Note that $\gamma_!$ is a bijec map as it underlies to the identity in \mathbf{Rel} .

Theorem 10.14. $\mathbf{FMat}(R)$ has free exponential modalities.

Proof. First we note the object $?(A)$ is a \oplus -monoid as where the monoid maps $\nabla : ?(A) \oplus ?(A) \rightarrow ?(A)$ and $\perp \xrightarrow{u} ?(A)$ are given by the characteristic maps of those in \mathbf{FRel} . This means there is a linear transformation given by the universal map $?(A) \xrightarrow{\gamma_?} ?(A)$ induced by preceding $\nabla : ?A \oplus ?A \rightarrow ?A$ by the mixer. Now suppose we are given $f : A \rightarrow X$ and a par commutative monoid $m : X \oplus X \rightarrow X \leftarrow \perp : e$ then we have:

$$\begin{array}{ccccc}
 ?_w(A) \otimes ?_w(A) & \xrightarrow{\nabla'} & ?_w(A) & \xleftarrow{\sigma_1} & A \\
 \gamma_? \otimes \gamma_? \downarrow & & \downarrow \gamma_? & \nearrow \eta & \nearrow f \\
 ?(A) \otimes ?(A) & \xrightarrow{\text{mix}} & ?(A) \oplus ?(A) & \xrightarrow{\nabla} & ?(A) \\
 \beta \otimes \beta \downarrow & & \beta \oplus \beta \downarrow & & \downarrow \beta \\
 X \otimes X & \xrightarrow{\text{mix}} & X \oplus X & \xrightarrow{m} & X
 \end{array}$$

which shows, as $\gamma_?$ and the mixer are bijective, that if there is a map β making the bottom right square commute, it must certainly be unique.

Now $\gamma_? \beta$ exists by the universal property of $?_w$ and $\gamma_?$ is the identity matrix (although significantly the finiteness topology is weakened). So it suffices to show that $\gamma_? \beta$ induces a map $?(A) \rightarrow X$: this amounts to showing that the support of $\gamma_? \beta$ is a finitary set of $?(A)$. However, by translating the diagram into \mathbf{FRel} , where such a β exists, shows that the support is certainly finitary for $?(A)$. Thus, β is well defined in $\mathbf{Mat}(R)$. \square

In [64] the exponential modality of $\mathbf{FMat}(R)$ is approached by providing an explicit description of $!(R)$ for a finiteness matrix $R : X \rightarrow Y$ in $\mathbf{Mat}(R)$. The description is not so simple and, thus, it requires some work to show that the exponential gives a functor. The explicit construction can be reconstructed from our approach using the behaviour of the maps on the projections $!(A) \rightarrow A^{\otimes n} \setminus n!$:

$$\begin{array}{ccc}
 !(A) & \xrightarrow{!(R)} & !(B) \\
 \downarrow \pi_n & & \downarrow \pi_n \\
 A^{\otimes n} \setminus n! & \xrightarrow{R^{\otimes n} \setminus n!} & B^{\otimes n} \setminus n! \\
 \nu_n \downarrow & & \downarrow \nu \\
 A^{\otimes n} & \xrightarrow{R^{\otimes n}} & B^{\otimes n}
 \end{array}$$

The formula using the notation in [64]:

$$!(R)_{u,v} = \sum_{\sigma \in L(u,v)} \begin{bmatrix} u \\ \sigma \end{bmatrix} R^\sigma$$

where $\sigma \in L(u,v) \subseteq \mathbf{Bag}(A \times B)$ is such that $v(a) = \sum_{b \in B} \sigma_{a,b}$ and $u(b) = \sum_{a \in A} \sigma_{a,b}$ (here we are viewing bags as finitely supported maps to the natural numbers), $R^\sigma := \prod_{(a,b) \in A \times B} R_{a,b}^{\sigma_{a,b}}$ and $\begin{bmatrix} v \\ \sigma \end{bmatrix} := \prod_{b \in B} v(b)! / \prod_{a \in A, b \in B} \sigma_{a,b}!$.

For bags of length n this is recaptured (when the rig has division by natural numbers) as $\nu R^{\otimes n} \nu^\square$. It is interesting to note that in [64] the functor was described as $!(R)_{u,v} = \sum_{\sigma \in L(u,v)} \begin{bmatrix} v \\ \sigma \end{bmatrix} R^\sigma$ (note the partition counting term is now the codomain). This form of the functor is a result of using the other splitting (see Remark 10.19) which is available when one assumes (as was the case in that paper) that the rig R is a field. In particular, this means, when R has inverses of natural numbers, that there is a non-trivial automorphism $\square : !(A) \rightarrow !(A)$ which shifts the combinatorial weighting.

10.2.3 The free exponential modalities in Chu spaces

Barr proved that:

Theorem 10.15. [16, Theorem 4.8] *If \mathbb{X} is a symmetric monoidal closed category that is locally presentable and D is any object in the category, then $\mathbf{Chu}_{\mathbb{X}}(D)$ is a model of linear logic with free exponential modalities.*

The category of vector spaces over complex numbers and linear maps, $\mathbf{Vec}(\mathbb{C})$, is a sym-

metric monoidal closed category which is locally presentable. Notably, $\mathbf{Chus}_{\mathbf{vec}_C}(\mathbb{C})$ is a \dagger -isomix category, see Section 4.4.3. We conjecture that the free exponential modalities of $\mathbf{Chus}_{\mathbf{vec}_C}(\mathbb{C})$ are \dagger -exponentials, in other words, $\mathbf{Chus}_{\mathbf{vec}_C}(\mathbb{C})$ is a $(!, ?)$ - \dagger -isomix category .

10.3 The free infinite linear monoids in \mathbf{FRel} and $\mathbf{FMat}(R)$

In this section, we describe a construction for free infinite linear monoids in isomix categories with certain limits and colimits using a standard construction for *exponential modalities* (see Section 9.4) in LDCs.

A standard way to attempt to build universal exponential modalities in an LDC is to use the following formulae (due to Michael Barr [15]):

$$!_w(A) := \prod_{n \in \mathbb{N}} A^{\otimes n} \setminus n! \quad \text{and} \quad ?_w(A) := \prod_{n \in \mathbb{N}} A^{\oplus n} / n!$$

Here, $A^{\otimes n} \setminus n!$ indicates the equalizer of all the $n!$ permutations of $A^{\otimes n}$. Dually $A^{\oplus n} / n!$ indicates the coequalizer of all the $n!$ permutations of $A^{\oplus n}$. In the category of vector spaces over a field K , $!_w(V)$ is the free symmetric algebra, $\bigoplus_{n \in \mathbb{N}} V^{\otimes n}$ over a vector space V .

For $!_w$ and $?_w$ to be exponential modalities, along with the other conditions, we require for all objects A in the LDC, $!_w(A)$ to be a cofree \otimes -coalgebra, and $?_w(A)$ to be a free \oplus -algebra. In order to define $\Delta_A : !_w(A) \rightarrow !_w(A) \otimes !_w(A)$ and $\nabla_A : ?_w(A) \otimes ?_w(A) \rightarrow ?_w(A)$ it is required that \otimes distributes over the product, that is $X \otimes \prod_{n \in \mathbb{N}} A^{\otimes n} = \prod_{n \in \mathbb{N}} X \otimes A^{\otimes n}$, and \oplus over the coproduct respectively – while the usual natural distributions (i.e. those which are guaranteed) are of the tensor over the coproduct and the par over the product. This construction – and when it fails to produce an exponential modality – is discussed in detail in [98].

Nonetheless, it does sometimes happen that the unexpected distributions do hold: that is, the tensor distributes over (countable) products and the par over (countable) coproducts. For example, in \mathbf{Rel} , where tensor is the same as par, and is inherited from the product in sets, the distribution over the product and coproduct is inherited from the distribution of products over coproducts in sets, this also works in suplattice (see [15]). However, even given the close relation of \mathbf{FRel} to \mathbf{Rel} , this construction does *not* work in \mathbf{FRel} . However, it does provide a modality (i.e. linear functor) which produces natural \otimes -monoids (and natural \oplus -comonoids) which furthermore have a universal property. This, in particular, provides us with a ready source of infinite linear monoids. in \mathbf{FRel} and $\mathbf{Mat}(R)$. Furthermore, as this is a construction which works in *all* isomix categories with the appropriate limits and colimits it provides us with a very general source of infinite linear monoids which can be exploited.

One aspect of this construction which is immediate clear is that, in the presence of a duality, $!_w(X) \simeq (?_w(X^*))^*$ as:

$$\begin{aligned}
(?_w(A^*))^* &:= \left(\prod_{n \in \mathbb{N}} (A^*)^{\oplus n} / n! \right)^* = \prod_{n \in \mathbb{N}} ((A^*)^{\oplus n} / n!)^* \\
&= \prod_{n \in \mathbb{N}} ((A^*)^{\oplus n})^* \setminus n! = \prod_{n \in \mathbb{N}} (A^{**})^{\otimes n} \setminus n! \\
&= \prod_{n \in \mathbb{N}} A^{\otimes n} \setminus n! = !_w(A)
\end{aligned}$$

This means, importantly, that $(!_w, ?_w)$ form a linear functor pair provided $!_w(A)$ is a monoidal functor with respect to the tensor (or, equivalently, $?_w(A)$ is a comonoidal functor with respect to par). However, notice that, as $!_w$ is built using limits, it is *automatically* monoidal and so $(!_w, ?_w)$, if it exists, is always a linear functor.

The reason for wanting the distributive law of \oplus over the coproduct is that this enables one to define a natural multiplication $\nabla_2 : ?_w(A) \oplus ?_w(A) \rightarrow ?_w(A)$ in the absence of a distributive law, however, one cannot define such a multiplication. However, there *is* a multiplication $\nabla'_2 : ?_w(A) \otimes ?_w(A) \rightarrow ?_w(A)$ as we do have the appropriate distributive law for tensor, thus, define the multiplication:

$$\frac{\left\{ (A^{\oplus i} / i!) \otimes (A^{\oplus j} / j!) \xrightarrow{\text{mix}} (A^{\oplus i} / i!) \oplus (A^{\oplus j} / j!) \rightarrow A^{\oplus i+j} / (i+j)! \xrightarrow{\sigma_{i+j}} \prod_{n \in \mathbb{N}} A^{\oplus n} / n! \right\}_{n \in \mathbb{N}}}{\frac{\prod_{n \in \mathbb{N}} \prod_{i+j=n} (A^{\oplus i} / i!) \otimes (A^{\oplus j} / j!) \rightarrow \prod_{n \in \mathbb{N}} A^{\oplus n} / n!}{(\prod_{n \in \mathbb{N}} A^{\oplus n} / n!) \otimes (\prod_{n \in \mathbb{N}} A^{\oplus n} / n!) \xrightarrow{\nabla'_2} \prod_{n \in \mathbb{N}} A^{\oplus n} / n!}}$$

The unit for the multiplication is $u := \sigma_0 : \top = \perp \xrightarrow{u} \prod_{n \in \mathbb{N}} A^{\oplus n} / n!$.

This is clearly not a free \otimes -commutative monoid in general but it is a linear functorial construction which exists for very general reasons and is present in isomix categories which are complete and cocomplete (and for which colimits distribute over tensor and limits distribute over par – which, of course, is immediate in $*$ -autonomous categories).

Note that the formulae for $!_w$ uses equalizers and countable products, dually, the formulae for $?_w$ uses coequalizers and countable coproducts. In \mathbf{FRel} and $\mathbf{FMat}(R)$ not all limits and colimits exist so we have to be a little careful in constructing $!_w$. We know arbitrary products and coproducts are present, we need only to discuss the formation of the coequalizer

$A^{\oplus n}/n!$ this is the coequalizer

$$A^{\oplus n} \begin{array}{c} \xrightarrow{\rho_1} \\ \vdots \\ \xrightarrow{\rho_{n!}} \end{array} A^{\oplus n} \xrightarrow{\nu_n} A^{\oplus n}/n! \quad (10.2)$$

where ρ_i the i^{th} permutation of the par power. When the category is additively enriched (which \mathbf{FRel} and $\mathbf{FMat}(R)$ are) – and when the rig, R , admits division by positive natural numbers – we may replace this coequalizer by the simpler coequalizer

$$A^{\oplus n} \begin{array}{c} \xrightarrow{\quad} \\ \xrightarrow{(\sum_{i=1}^{n!} \rho_i)/n!} \end{array} A^{\oplus n} \xrightarrow{\nu_n} A^{\oplus n}/n! \quad (10.3)$$

The ability to divide by $n!$ is necessary for this simplification. Note that in \mathbf{FRel} , $m = 1 \cup \dots \cup 1 = 1$ so it admits division by positive numbers. Generally in $\mathbf{FMat}(R)$ one needs the rig, R , to admits division by natural numbers in order to reach this simplification: clearly this is the case for all fields and \mathbb{Q} -algebras.

We show that the simpler parallel pair of maps - 1 , $(\sum_{i=1}^{n!} \rho_i)/n!$ - in formula 10.3 has the same coequalizer as for the maps $\rho_1, \dots, \rho_{n!}$ in formula 10.2. Suppose ν_n is the coequalizer of 1 and $(\sum_{i=1}^{n!} \rho_i)/n!$ in 10.3, that is, $1_{A^{\oplus n}} \nu_n = (\sum_{i=1}^{n!} \rho_i)/n!$, then ν_n coequalizes all pairs of ρ_i and ρ_j in formula 10.2, in particular, we have that for all $i \in n!$, $\rho_i \nu_n = 1_{A^{\oplus n}} \nu_n = \rho_1 \nu_n$.

$$\rho_i \nu_n = \rho_i 1_{A^{\oplus n}} \nu_n = \rho_i \left(\sum_{j=1}^{n!} \rho_j / n! \right) \nu_n = \left(\sum_{i=1}^{n!} \rho_i \rho_j / n! \right) \nu_n \stackrel{(*)}{=} \left(\sum_{i=1}^{n!} \rho_i / n! \right) \nu_n = 1_{A^{\oplus n}} \nu_n = \rho_1 \nu_n$$

The step $(*)$ is true because the set of all permutations form a group. Similarly, if $\lambda : A^{\oplus n} \rightarrow Y$ coequalizes all the permutations $\rho_1, \dots, \rho_{n!}$, then λ coequalizes 1 and $(\sum_{i=1}^{n!} \rho_i)/n!$:

$$\left(\sum_{i=1}^{n!} \rho_i / n! \right) \lambda = \left(\sum_{i=1}^{n!} \rho_i \lambda \right) / n! = \left(\sum_{i=1}^{n!} \lambda \right) / n! = \left(\sum_{i=1}^{n!} 1_{A^{\oplus n}} \right) / n! \lambda = 1_{A^{\oplus n}} \lambda$$

so the coequalizer of the formula in 10.3 is precisely the coequalizer of the permutations.

It is also clear that $(\sum_{i=1}^{n!} \rho_i)/n!$ is an idempotent as:

$$\left(\sum_{i=1}^{n!} \rho_i / n! \right) \left(\sum_{i,j=1}^{n!} \rho_j / n! \right) = \sum_{i=1}^{n!} \sum_{j=1}^{n!} \rho_i \rho_j / (n!)^2 = \sum_{j=1}^{n!} n! \rho_j / (n!)^2 = \sum_{j=1}^{n!} \rho_j / n!$$

This means that the coequalizer (and indeed the equalizer) we seek, in this case, is obtained by splitting this idempotent (and such splittings are preserved by all functors). Thus, when

we have division by positive natural numbers, we have the coequalizer we seek provided (these) idempotents split. Even though this is a very mild requirement, recall that in **FRel** not all idempotents split so we must examine this particular idempotent in more detail.

In **Rel** the coequalization of permutations of product powers is given by the surjection $\nu_n : A^n \rightarrow \mathbf{Bag}(A)_n$, where $\mathbf{Bag}(A)_n$ is the set of bags of A with exactly n -elements. The section is just the converse of this map $\nu_n^\circ : \mathbf{Bag}(A)_n \rightarrow A^n$ (it is monic exactly because it is the converse of an epic!). In **SRel** on the web the splitting must take the form it has in **Rel**, however, we must show that the finiteness structures are compatible with this. We will deal with the par and so we shall argue using the cofinitary sets.

$F(A^{\oplus n})^\perp = \downarrow \{A_1 \times \dots \times A_n \mid A_i \in F(A)^\perp\} = \downarrow \{A_0^n \mid A_0 \in F(A)^\perp\}$, where the last set dominates the previous one because $A_1 \times \dots \times A_n \subseteq A_0^n$ where $A^0 := \bigcup_{i=1}^n A_i$.

We set $F(A^{\oplus n}/n!)^\perp = \{X \mid \nu_n \triangleleft X \in F(A^{\oplus n})^\perp\} = \{X \mid \nu_n \triangleleft X \subset A_0^n, A_0 \in F(A)^\perp\} = \{X \mid X^\cup \in F(A)^\perp\}$ where by X^\cup we indicate the union of all the elements in the bags in $X \subseteq \mathbf{Bag}(A)_n$. We must show that this does provide a well-defined finiteness space on $\mathbf{Bag}(A)_n$. Toward this end note that ν_n is a map so $\{a_1 \oplus \dots \oplus a_n\} \triangleright \nu_n$ is a singleton so a finitary set in $\mathbf{Bag}(A)_n$. Furthermore, ν_n reflects cofinitary sets by definition. On the otherhand, ν_n still has $\{b\} \triangleright \nu_n^\circ$ finite and, again, by definition preserves cofinitary sets.

This all means that the coequalizer exist in **FRel** and is given by splitting an idempotent. To transpose this into a coequalizer in **FMat**(R) we take the characteristic function of ν_n , however, for ν_n° we use the matrix (which we denote ν^\square) with its entries determined by:

$$\nu^\square : \mathbf{Bag}(A)_n \times A^n \rightarrow R; (y, x) \mapsto \begin{cases} \frac{r_1! \dots r_p!}{n!} & \text{when } y = \nu_n(x) \text{ and } y = r_1 \cdot a_1 + \dots + r_p \cdot a_p \\ 0 & \text{otherwise} \end{cases}$$

where this formula takes into account the repetitions in the bag: a repetition reduces the number of sequences corresponding to the bag. We now have:

Lemma 10.16. *In both **FRel** and **FMat**(R), where R is a rig with division by positive natural numbers, the idempotents $(\sum_{i=1}^{n!} \rho_i)/n!$ on both $A^{\oplus n}$ and $A^{\otimes n}$ split.*

In fact, the coequalizer $\nu_n : A^{\oplus n} \rightarrow A^{\oplus n}/n!$ exists in **FMat**(R), for an arbitrary rig R . It, however, will not be given by a splitting of an idempotent in general. The point is that the map $\nu_n : A^{\oplus n} \rightarrow A^{\oplus n}/n! = \mathbf{Bag}_n(A)$ is always present as the characteristic function of ν_n . Its universal property is given by its finiteness relational universality. This means that we have all the components of the proposed construction of the modality $(!_w, ?_w)$ in all these categories:

Proposition 10.17. *In both **FRel** and **FMat**(R), where R is any rig, the modality $(!_w, ?_w)$ described above exists. Furthermore, it produces infinite linear monoids: thus, for any object*

$A, ?_w(A) \overset{\circ}{\dashv} !_w(A^*)$ is a linear monoid.

The linear functor $(!_w, ?_w)$ has a universal property but for commutative “mixed” \oplus -monoids and \otimes -comonoids: suppose $m : X \oplus X \rightarrow X \leftarrow \perp : u$ is a commutative monoid and there is a map $f : A \rightarrow X$ then there is a unique map $f^{\oplus r} m_r : A^{\oplus r} / r! \rightarrow X$ determined by the n -fold multiplication $m_r : X^{\oplus r} / r! \rightarrow X$ this then gives a map from the coproduct $f^\# : ?_w(A) \rightarrow X$ such that:

$$\begin{array}{ccccc} ?_w(A) \otimes ?_w(A) & \xrightarrow{\nabla'_2} & ?_w(A) & \xleftarrow{\sigma_1} & A \\ f^\# \otimes f^\# \downarrow & & f^\# \downarrow & & \swarrow f \\ X \otimes X & \xrightarrow{\text{mix}} & X \oplus X & \xrightarrow{m} & X \end{array}$$

where $f^\# := \{A^{\oplus n} / n! \xrightarrow{f^{\oplus n} / n!} X^{\oplus n} / n! \xrightarrow{m_n} X\}_{n \in \mathbb{N}}$ is the comparison map from the coproduct. The map $f^\#$ is unique whenever the mixer $\text{mix} : A \otimes B \rightarrow A \oplus B$ is epic – which, notably, is so in FRel and $\text{Fmat}(R)$ as it underlies to the identity in Rel – because:

$$\begin{array}{ccccc} A^{\oplus p} / p! \otimes A^{\oplus q} / q! & \xrightarrow{\text{mix}} & A^{\oplus p} / p! \oplus A^{\oplus q} / q! & \xrightarrow{\nabla'_{n,m}} & A^{\oplus p+q} / (p+q)! \\ \mu_p \otimes \mu_q \downarrow & & \mu_p \oplus \mu_q \downarrow & & \mu_{p+q} \downarrow \\ X \otimes X & \xrightarrow{\text{mix}} & X \oplus X & \xrightarrow{m} & X \end{array}$$

whenever the outer square commutes, because the left square commutes, it follows that the righthand square must commute (assuming the mixer is epic). However, the righthand square is determined by the colimit to have $\mu_r = f^{\oplus r} m_r$ so $\{\mu_r\}_{r \in \mathbb{N}} = f^\#$. This gives:

Proposition 10.18. *In any isomix category which has products (which distribute over par) and coproducts (which distribute over tensor) and for which the mixer is bijective (that is both epic and monic) the weak exponential has the universal property that given any commutative monoid $X \oplus X \xrightarrow{m} X \xleftarrow{u} \perp$ and $f : A \rightarrow X$ there is a unique morphism to the mixed monoid $f^\# : ?_w(A) \rightarrow X$ such that:*

$$\begin{array}{ccccc} ?_w(A) \otimes ?_w(A) & \xrightarrow{\nabla'_2} & ?_w(A) & \xleftarrow{\sigma_1} & A & \perp & \xrightarrow{\nabla'_0} & ?_w(A) \\ f^\# \otimes f^\# \downarrow & & f^\# \downarrow & & \swarrow f & & \searrow u & \downarrow f^\# \\ X \otimes X & \xrightarrow{\text{mix}} & X \oplus X & \xrightarrow{m} & X & & & X \end{array}$$

Dually, given a cocommutative comonoid $Y \otimes Y \xleftarrow{d} Y \xrightarrow{e} \top$ and map $g : Y \rightarrow B$ there is a unique morphism from the mixed comonoid $f^\flat : Y \rightarrow !_w(B)$ such that $f^\flat d \text{mix} = \Delta'(f^\flat \oplus f^\flat)$.

Remark 10.19. *In a $\text{FMat}(R)$, in which R has division by natural numbers, there is a second canonical way to split the idempotent as $\omega_n^\square : A^{\oplus n} \rightarrow A^{\oplus n} / n!$ with the section $\omega : A^{\oplus n} / n!$*

$\rightarrow A^{\oplus n}$ being the characteristic function. Thus,

$$\omega_n^{\square}([a_1, \dots, a_n], r_1 \cdot a_{r_1} + \dots + r_p \cdot a_r = \wr[a_1, \dots, a_n] = r_1! \dots r_p! / n!.$$

This alternate splitting shifts the weights from the section onto the retraction. The splitting given by ν_n and ν_n^{\square} has the advantage that the map ν_n exists for every rig R – this is why we can form the weak exponential for all rigs.

Chapter 11

Summary

The second part of this thesis focused on formulating the structures fundamental to CQM, namely completely positive maps, \dagger -Frobenius algebras, and complementary bialgebras, in MUCs. Recall that a MUC, $M : \mathbb{U} \rightarrow \mathbb{C}$, is given by a \dagger -isomix functor M from a unitary category \mathbb{U} into a \dagger -isomix category \mathbb{C} . Moreover, M factors through the core of \mathbb{C} .

Chapter 7 generalized Coecke and Heunen's $\mathbb{C}P^\infty$ construction [46] on \dagger -SMCs to MUCs. In a MUC setting, the auxiliary wire for Kraus maps must be unitary. Similar to the $\mathbb{C}P^\infty$ construction on \dagger -SMCs, we characterize the $\mathbb{C}P^\infty$ construction on MUCs using environment structures. Unlike in \dagger -SMCs, an environment structure for MUC requires discarding maps only within the unitary core. A MUC which has an environment structure with purification is isomorphic to the $\mathbb{C}P^\infty$ category of some other MUC. Our $\mathbb{C}P^\infty$ construction on a MUC produces an isomix category. The construction preserves dagger when the base category has unitary duals.

Chapter 9 discussed modelling measurement and complementarity in MUCs using structures developed in Chapter 8. In \dagger -SMCs, Coecke and Pavlovic [48] described a demolition measurement as a map $f : A \rightarrow X$ where X is a special commutative \dagger -Frobenius algebra and $f^\dagger f = 1_X$. Coecke and Pavlovic's measurement formula cannot be directly applied in a MUC setting because in a \dagger -isomix category an object A is not always isomorphic to A^\dagger except in the unitary core. Hence, in a MUC setting, measurement is done in two steps: an object is first *compact* into the unitary core followed by a demolition measurement. Interestingly, compaction produces a coring \dagger -binary idempotent, and a coring \dagger -binary idempotent, when split, produces an object in the canonical unitary core. The details are discussed in the Section 9.1.

A component of Coecke and Pavlovic's measurement formula is a special commutative \dagger -Frobenius algebra (\dagger -FA). In LDCs, FAs are generalized by linear monoids containing a \otimes -monoid, say on A , and a dual \oplus -comonoid on B . Note that, the monoid and the comonoid

are not usually defined on the same object which differentiates linear monoids from Frobenius algebras. In a compact setting, linear monoids on isomorphic objects collapse to FAs when the isomorphism satisfy a certain condition. We show that these results extend to a \dagger settings too, see Section 8.1.

Even though expected, it is suprising that the linear monoids lead to the notion of linear comonoids consists of a \otimes -comonoid and a \oplus -monoid, introduced in Section 8.2. Exponential modalities for LDCs is a significant source of examples for linear comonoids. In an LDC, linear monoids and linear comonoids interact bialgebraically to produce a pair of bialgebras - one on the tensor and the other one on the par product. Linear bialgebras are fundamental to complementary systems which are discussed in Section 8.3. When a self-linear bialgebra satisfies certain conditions, its \otimes and \oplus bialgebra are Hopf algebras with a certain antipode; such self-linear bialgebras are referred to as complementary systems, see Section 9.3.

In the presence of the free exponential modalities $(!, ?)$, every complementary system in an isomix category induces a linear bialgebra on the free exponential modalities - the linear comonoid of the induced $(!, ?)$ -linear bialgebra is given by the free canonical cocommutative \otimes -comonoid of the $!$. The universal property of the free $(!, ?)$ induces a binary idempotent on the $(!, ?)$ -linear bialgebra which splits to produce the original complementary system. Thus, *every complementary system arises as a splitting of a binary idempotent on the linear bialgebra induced on the free exponential modalities*, see Section 9.4. The results extend directly to \dagger -complementary systems in \dagger -isomix categories with a free $(!, ?)$. Rel , FRel , $\text{FMat}(R)$ where R is commutative rig and certain Chu categories are examples of \dagger -isomix categories with free exponential modalities, see Section 10.2.

Chapter 12

Conclusion and future work

12.1 Conclusion

This thesis is a product of our journey towards developing a suitable categorical semantics for quantum processes without the constraint of dimensionality. Since its inception, CQM has piqued the interest of researchers by its versatile and elegant approach towards studying quantum foundations and quantum processes. While CQM was built on compact closed categories - categorical semantics of linear logic with the pair of multiplicatives combined into one and the pair of additives combined into one - which forces the Hilbert space model to be finite dimensional, there have been efforts to address the dimensionality constraint of CQM.

While one approach was to construct a category which is still compact closed but can suitably describe quantum processes of arbitrary dimensions [70, 77], the other approach was to construct suitable algebraic structures in \dagger -SMCs [46, 6]. Attempts have also been made by adding properties to the underlying monoidal category so that it accommodates objects of arbitrary dimension [75, 118]. In our journey, we stepped out of the well-trodden path of \dagger -monoidal categories in CQM, went back to the fundamentals, and as category theorists asked, “*Can we consider the semantics of \dagger -linear logic that indeed is not degenerate?*” This turned our attention towards linearly distributive categories and $*$ -autonomous categories (LDCs without negation).

Proceeding to define a \dagger functor for LDCs, and a unitary structure for \dagger -isomix categories, we arrived at the notion of mixed unitary categories (MUCs) which are \dagger -isomix categories with a chosen unitary core. As revealed by the schematic diagram of MUC in Figure 4.2, the \dagger -isomix category is a larger space in which the (smaller) unitary category resides. For any MUC, its unitary core is equivalent to a \dagger -monoidal category, and in the presence of unitary duals, it is equivalent to a \dagger -compact closed category. Thus, one gets a neat description of

the traditional CQM framework in terms of a larger and a more general framework. We have discussed quite a few examples of MUCs as we developed the structure. Significant among these examples are, the category of finiteness relations \mathbf{FRel} which has a faithful functor into \mathbf{Rel} , and the category of finiteness matrices over of commutative rig R , $\mathbf{FMat}(R)$. In fact, the category of finite complex matrices $\mathbf{Mat}(\mathbb{C})$ is isomorphic to the core of $\mathbf{FMat}(\mathbb{C})$.

Further in our journey, we tested our framework in its applicability to quantum mechanics by generalizing the algebraic structures fundamental to CQM - completely positive maps modeling quantum processes, special commutative \dagger -Frobenius algebras modeling quantum observables, and bialgebras and Hopf algebras modeling complementary observables - from \dagger -SMCs to \dagger -isomix categories. By generalizing the \mathbf{CP}^∞ construction from \dagger -SMCs to MUCs, we noticed that, in MUCs, interestingly, a completely positive map always factors through the unitary core in its Kraus decomposition form. Moreover, in order to characterize the \mathbf{CP}^∞ construction, it suffices that one can discard information for unitary objects. Hence, the notion of environment structure, in other words, discarding information, is a requirement only within the unitary core.

Moving on, we turned our focus on *linear monoids* [30] in LDCs which are a general version of Frobenius algebras: in linear monoids, the monoid and the comonoid pair generally occur on different objects, the monoid is on the \otimes -product, the comonoid is on the \oplus -product, and the monoid and the comonoid objects are dual to one another. We introduced \dagger -linear monoids, which in a unitary category are equivalent to \dagger -Frobenius algebras when the unitary structure map satisfies a certain condition. Linear comonoids which are same as linear monoids except with the monoid on the \oplus -product and the comonoid on the \otimes -product, are a surprising consequence of our attempt to understand bialgebraic interaction of linear monoids. A bialgebraic interaction between two linear monoids implies a bialgebraic interaction between a \otimes -monoid and a \oplus -comonoid, which is not supported in an LDC. This led to the idea of linear comonoids. Indeed, linear comonoids are not mere algebraic constructs defined for convenience, but they are significant, since exponential modalities of linear logic provide a source of examples for linear comonoids.

A linear monoid and linear comonoid may interact beautifully to produce a \otimes -bialgebra and a \oplus -bialgebra, we refer to this interaction as a linear bialgebra. At this stage, one can perceive the significance of keeping the tensor products (the multiplicatives of linear logic) distinct in the framework. Complementary observables are intimately connected to the notion of measurement. In a MUC, we showed that a measurement takes place in two steps: first an arbitrary (non-unitary) type is compacted into the unitary core, while inside the unitary core, one can use the traditional machinery of CQM to perform a measurement. Interestingly, compaction produces a binary idempotent with certain properties. We

called this a coring \dagger -binary idempotent. Conversely, a coring \dagger -binary idempotent induces a compaction.

Finally, turning our attention to complementary systems, we considered such a system in \dagger -isomix categories as a self-linear bialgebra satisfying certain equations. These equations implied that the pair of bialgebras are indeed Hopf with a particular antipode. We noted that when the \dagger -isomix category has free exponential modalities (the exponential operator of linear logic which provides for non-linear types with infinite duplication and discarding), every complementary system induces a linear bialgebra on the free exponential modalities (in the larger space). Indeed, in such a setting, every complementary system arises by splitting a coring \dagger -binary idempotent on the induced \dagger -linear bialgebra. This is perhaps, the most interesting result in this thesis in relation to quantum mechanics.

Bohr's principle of complementarity [71] states that, due to the wave and particle nature of matter, physical properties occur in complementary pairs. Our result connecting complementarity with exponential modalities displays a complementary system as a compaction of a \dagger -linear bialgebra in which the two dual structures (one pertaining to linear monoid and the other one of the linear comonoid) occur separately providing an interesting perspective on Bohr's principle.

12.2 Future work

The current journey has many interesting further directions, a few of which are discussed below:

12.2.1 Models of physical systems

In this thesis, we have discussed multiple examples of MUCs such as \mathbf{FRel} , $\mathbf{FMat}(R)$ and \mathbf{Chu} spaces from a mathematical viewpoint. The role of these categories in the study of quantum foundations and the other areas of quantum theory is yet to be explored. In particular, $\mathbf{FMat}(R)$ seems to be an interesting candidate to study quantum mechanics since its canonical unitary core is isomorphic to \mathbf{FHilb} which is a well-studied model in CQM. Moreover, $\mathbf{FMat}(R)$ is a model of full linear logic and comes with the free exponential modalities.

In [117], Vicary uses the $!$ exponential modality and a differential map [24] to categorify the creation and annihilation operators for a Fock space in \dagger -monoidal categories with \dagger -biproducts. He assumes that the \dagger commutes with the $!$ modality. Recall that, in a linear setting, we saw that applying \dagger to $!$ modality gives the $?$ modality. Vicary applies the machinery to a category \mathbf{Inner} with complex inner product spaces of countable dimensions and well-defined linear maps to study the state space of Quantum Harmonic Oscillators

(QHO). However, the claim that the adjunction between the cofree and the forgetful functor producing the $!$ -modality is well-defined is left as a conjecture. It has been mentioned that the difficulty lies in proving that η map of the adjunction is well-defined. It would be interesting to revisit Vicary’s ideas on categorifying QHO [117] in a linearly distributive setting, in particular, in $\mathbf{FMat}(R)$ with distinct $!$ and $?$ modalities.

In [117], Vicary points out that with exponential modality one can model the state space of a QHO, however, in order to achieve a categorical description of the dynamics of the system, one needs the ability to express differential equations categorically. Differential categories [24, 29] which are additive symmetric monoidal categories with a coalgebra comodality and a differential combinator seems to be a natural candidate satisfying the requirement. [91] emphasizes the relevance of differential categories to quantum foundations. In fact, \mathbf{FRel} and $\mathbf{FMat}(R)$ are indeed differential categories due to the presence of the free exponential modalities. This arises a question if can one obtain a complete categorical description of quantum harmonic oscillator in differential categories?

Our thesis proved that in a \dagger -isomix category, in the presence of free exponential modalities, every complementary system inside the canonical unitary core arises from the linear bialgebra induced on the free exponential modalities. Free exponential modalities imply the presence of a differential combinator [65, 29] and provide a categorical description for the state space of a QHO [26, 117]. This leads one to wonder if there is any interesting connection between quantum harmonic oscillators and complementary observables in physics.

12.2.2 Joyal’s Bicompletion construction

An interesting source of examples for MUC is Joyal’s [82, 83] bicompletion procedure on monoidal categories. Starting with a \dagger -monoidal category, or unitary category, \mathbb{C} , one can form a MUC $i : \mathbb{C} \rightarrow \Lambda(\mathbb{C})$ by simply bicompleting (by adding arbitrary limits and colimits) to the \dagger -monoidal category. Furthermore, the bicompletion, $\Lambda(\mathbb{C})$, is a (non-compact) \dagger -isomix category which, when the starting point, \mathbb{C} , is \dagger -compact closed, is a \dagger -isomix $*$ -autonomous category. Bicompleting a monoidal category, \mathbb{C} , causes its tensor to split into two linearly related tensors products \otimes and \oplus and induces a cofree functor $i : \mathbb{C} \rightarrow \Lambda(\mathbb{C})$ on the category of bicomplete categories and bicontinuous functors. The free bicomplete category generated by a single object is a $*$ -autonomous category [83, Corollary - Theorem 3].

12.2.3 Clifford algebras in linear settings

Clifford algebras¹ [73, 94, 57] are regarded as a universal language for physics due to their intimate connection to geometry. They neatly geometrify algebra and algebraize geometry. Clifford algebras have been applied in many fields of physics including quantum gravity [66, 58], quantum field theory [116] and quantum electrodynamics [19].

The Clifford algebra of space time captures the geometry of special relativity [73]. In his discussion on categorification of a quantum harmonic oscillator [117, Sec. Discussion], Vicary notes that within the current CQM formalism,

“... an elegant categorical description of the other ingredients of the Schrödinger equation, such as Planck’s constant h and the imaginary unit i , is far from apparent.”

Clifford algebra addresses the above concern by providing a geometric interpretation for the imaginary constant i as rotations in space time. The gamma matrices which are 4×4 anti-commuting unitary matrices solving the Dirac equation in quantum field theory gives a matrix representation for a Clifford algebra, $Cl_{1,3}(\mathbb{R})$ [116]. The Pauli I, X, Y, Z matrices which are quite significant for quantum mechanics and quantum computing provides a representation for the Clifford algebra $Cl_{0,3}(\mathbb{R})$ [57]. Schrödinger’s equation can be represented as an element in the Clifford algebra $Cl_{0,1}(\mathbb{R})$ [80].

Clifford algebras enable an interesting possibility of understanding and formalizing quantum computation via geometry rather than the other standard non-intuitive methods such as unitary matrices formalism or the circuit language method borrowed from classical computing. This approach is quite different from the existing approaches and can provide a fresh perspective on quantum computation. Efforts [114, 120, 119, 7, 53, 93, 92] to apply Clifford algebras to quantum computing in a non-categorical setting emphasize the conceptual clarity and computational advantages provided by Clifford algebras. In [114] the authors show that the Clifford algebra description of quantum computation operations has a direct correlation to NMR spectroscopy, hence can be implemented in NMR quantum computing without further translation. The more recent works [93, 92] interestingly uses string diagrams of monoidal categories to describe Clifford operations.

In the future, we would like to formulate abstract Clifford algebras in linear settings. It would also be interesting to adapt the string diagrams of CQM to the Clifford algebras. The elements of a Clifford algebra always anti commute. This suggests a connection between these algebras to complementary measurements. Can Clifford algebras be used to provide a fresh perspective on quantum computation by taking an approach quite different from classical computation? Drawing inspiration from the ZX calculus [44], can one build a

¹Note that the term Clifford algebras and geometric algebra are used interchangeably in the physics literature. However, Clifford algebras are free geometric algebras which satisfy a universal property.

universal Clifford calculus that would bridge multiple areas of quantum research? Can such a Clifford calculus provide a neat generalization to the ZX calculus to arbitrary dimensional systems? It would be quite interesting and highly useful to devise a diagrammatic calculus for the complicated equations areas in quantum chemistry and other branches of quantum mechanics. In ZX calculus, the bialgebraic interaction between the complementary Z and the X observables is exploited to construct gates for quantum computation. The Pauli X, Y and Z matrices along with the identity matrix is a representation for a Clifford algebra. This arises a question if there is any interesting connection between bialgebras and Clifford algebras? These questions are yet to be explored.

Bibliography

- [1] Eiichi Abe. *Hopf Algebras*. Cambridge University Press, 2004.
- [2] Samson Abramsky. “Big toy models”. In: *Synthese* 186.3 (2012), pp. 697–718.
- [3] Samson Abramsky. “Coalgebras, Chu spaces, and representations of physical systems”. In: *Journal of philosophical logic* 42.3 (2013), pp. 551–574.
- [4] Samson Abramsky and Bob Coecke. “A Categorical Semantics of Quantum Protocols”. In: *Proceedings of the 19th Annual IEEE Symposium on Logic in Computer Science*. LICS '04. Washington, DC, USA: IEEE Computer Society, 2004, pp. 415–425. ISBN: 0-7695-2192-4. DOI: [10.1109/LICS.2004.1](https://doi.org/10.1109/LICS.2004.1). URL: <http://dx.doi.org/10.1109/LICS.2004.1>.
- [5] Samson Abramsky and Ross Duncan. “A categorical quantum logic”. In: *In the Proceedings of the 2nd International Workshop on Quantum Programming Languages (QPL '04)*. 2004.
- [6] Samson Abramsky and Chris Heunen. “H*-algebras and nonunital Frobenius algebras: first steps in infinite-dimensional categorical quantum mechanics”. In: *Clifford Lectures* 71 (2012), pp. 1–24.
- [7] Diederik Aerts and Marek Czachor. “Cartoon computation: quantum-like computing without quantum mechanics”. In: *Journal of Physics A: Mathematical and Theoretical* 40.13 (Mar. 2007), F259–F266.
- [8] Warren Ambrose. “Structure theorems for a special class of Banach algebras”. In: *Transactions of the American Mathematical Society* 57.3 (1945), pp. 364–386.
- [9] Steve Awodey. *Category Theory*. 2nd. USA: Oxford University Press, Inc., 2010. ISBN: 0199237182.
- [10] Miriam Backens. “Making the stabilizer ZX-calculus complete for scalars”. In: *Electronic Proceedings in Theoretical Computer Science* 195 (Nov. 2015), pp. 17–32.

- [11] John Baez and Michael Stay. “Physics, Topology, Logic and Computation: A Rosetta Stone”. In: *Lecture Notes in Physics* 813 (2011), pp. 95–172. URL: <http://arxiv.org/abs/0903.0340>.
- [12] John Baez and Mike Stay. “Physics, Topology, Logic and Computation: A Rosetta Stone”. In: *Lecture Notes in Physics* (2010), pp. 95–172.
- [13] Howard Barnum and Alexander Wilce. “Information processing in convex operational theories”. In: *Electronic Notes in Theoretical Computer Science* 270.1 (2011), pp. 3–15.
- [14] Michael Barr. “*-Autonomous categories and linear logic”. In: *Mathematical Structures in Computer Science* 1.2 (1991), pp. 159–178. DOI: [10.1017/S0960129500001274](https://doi.org/10.1017/S0960129500001274).
- [15] Michael Barr. “*-Autonomous categories and linear logic”. In: *Mathematical Structures in Computer Science* 1.2 (1991), pp. 159–178.
- [16] Michael Barr. “Accessible categories and models of linear logic”. In: *Journal of Pure and Applied Algebra* 69.3 (1991), pp. 219–232.
- [17] Michael Barr and Charles Wells. *Category Theory for Computing Science*. USA: Prentice-Hall, Inc., 1990. ISBN: 0131204866.
- [18] Michel Barr. “The Chu construction: history of an idea”. In: *Theory and Applications of Categories* 17.1 (2006), pp. 10–16.
- [19] William Baylis. *Electrodynamics: A Modern Geometric Approach*. Birkhäuser, 2004.
- [20] Gavin M. Bierman. “What is a categorical model of intuitionistic linear logic?” In: *Proceedings of the Second International Conference on Typed Lambda Calculi and Applications*. TLCA '95. Berlin, Heidelberg: Springer-Verlag, 1995, pp. 78–93.
- [21] Richard Blute. “Hopf algebras and linear logic”. In: *Mathematical Structures in Computer Science* 6.2 (1996), pp. 189–212.
- [22] Richard Blute, Robin Cockett, and Robert Seely. “! and?-Storage as tensorial strength”. In: *Mathematical Structures in Computer Science* 6.4 (1996), pp. 313–351.
- [23] Richard Blute, Robin Cockett, and Robert Seely. “Cartesian differential categories with storage”. In: *Theory and Applications of Categories* 30.18 (2015), pp. 622–672.
- [24] Richard Blute, Robin Cockett, and Robert Seely. “Differential categories”. In: *Mathematical Structures in Computer Science* 16.6 (2006), pp. 1049–1083.
- [25] Richard Blute, Robin Cockett, and Robert Seely. “Feedback for linearly distributive categories: traces and fixpoints”. In: *Journal of Pure and Applied Algebra* 154.1-3 (2000), pp. 27–69.

- [26] Richard Blute, Prakash Panangaden, and Robert AG Seely. “Fock space: a model of linear exponential types”. In: *Proceedings of Ninth Conf. on Mathematical Foundations of Programming Semantics, Lecture Notes in Computer Science* (Berlin). Vol. 802. Springer, 1994, pp. 1–25.
- [27] Richard Blute, Prakash Panangaden, and Sergey Slavnov. “Deep inference and probabilistic coherence spaces”. In: *Applied Categorical Structures* 20.3 (2012), pp. 209–228.
- [28] Richard Blute and Philip Scott. “Category theory for linear logicians”. In: *Linear logic in Computer Science* 316 (2004), pp. 3–65.
- [29] Richard Blute et al. “Differential categories revisited”. In: *Applied Categorical Structures* (2019), pp. 1–65.
- [30] Richard Blute et al. “Natural deduction and coherence for weakly distributive categories”. In: *Journal of Pure and Applied Algebra* 113.3 (1996), pp. 229–296. ISSN: 0022-4049. DOI: [https://doi.org/10.1016/0022-4049\(95\)00159-X](https://doi.org/10.1016/0022-4049(95)00159-X). URL: <http://www.sciencedirect.com/science/article/pii/002240499500159X>.
- [31] Arkady Bolotin. *No-cloning implies unalterability of the past*. 2019. arXiv: [1905.06766](https://arxiv.org/abs/1905.06766) [quant-ph].
- [32] Francis Borceux. *Handbook of Categorical Algebra 1 – Basic Category Theory*. Cambridge Univ. Press, 1994.
- [33] Man-Duen Choi. “Completely positive linear maps on complex matrices”. In: *Linear Algebra and its Applications* 10 (1975), pp. 285–290.
- [34] Robin Cockett, Cole Comfort, and Priyaa Srinivasan. *Dagger linear logic for categorical quantum mechanics*. 2018. arXiv: [1809.00275](https://arxiv.org/abs/1809.00275) [math.CT].
- [35] Robin Cockett, Jürgen Koslowski, and Robert Seely. “Introduction to linear bicategories”. In: *Mathematical Structures in Computer Science* 10.2 (2000), pp. 165–203.
- [36] Robin Cockett and Robert Seely. “Linearly distributive functors”. In: *Journal of Pure and Applied Algebra* 143.1-3 (1999), pp. 155–203.
- [37] Robin Cockett and Robert Seely. “Proof theory for full intuitionistic linear logic, bilinear logic, and mix categories”. In: *Theory and Applications of categories* 3.5 (1997), pp. 85–131.
- [38] Robin Cockett and Robert Seely. “Weakly distributive categories”. In: *Journal of Pure and Applied Algebra* 114.2 (1997), pp. 133–173.

- [39] Robin Cockett and Priyaa Srinivasan. *Exponential modalities and complementarity*. “To appear in the proceedings of 4th International Conference on Applied Category Theory, 2021”. 2021. arXiv: [2103.05191](https://arxiv.org/abs/2103.05191) [[math.CT](#)].
- [40] Robin Cockett and Priyaa V. Srinivasan. “Complete Positivity for Mixed Unitary Categories”. In: *arXiv preprint arXiv:1905.08877* (2019).
- [41] Bob Coecke. “Axiomatic Description of Mixed States From Selinger’s CPM-construction”. In: *Electronic Notes in Theoretical Computer Science* 210 (2008). Proceedings of the 4th International Workshop on Quantum Programming Languages (QPL 2006), pp. 3–13. ISSN: 1571-0661.
- [42] Bob Coecke. “Introducing categories to the practicing physicist”. In: (2008). arXiv: [0808.1032](https://arxiv.org/abs/0808.1032) [[math-ph](#)].
- [43] Bob Coecke. “Terminality implies non-signalling”. In: *Electronic Proceedings in Theoretical Computer Science* 172 (Dec. 2014), pp. 27–35. DOI: [10.4204/eptcs.172.3](https://doi.org/10.4204/eptcs.172.3).
- [44] Bob Coecke and Ross Duncan. “Interacting quantum observables: categorical algebra and diagrammatics”. In: *New Journal of Physics* 13.4 (2011), p. 043016.
- [45] Bob Coecke, Bill Edwards, and Robert W. Spekkens. “Phase Groups and the Origin of Non-locality for Qubits”. In: *Electronic Notes in Theoretical Computer Science* 270.2 (Feb. 2011), pp. 15–36. DOI: [10.1016/j.entcs.2011.01.021](https://doi.org/10.1016/j.entcs.2011.01.021).
- [46] Bob Coecke and Chris Heunen. “Pictures of complete positivity in arbitrary dimension”. In: *Information and Computation* 250 (2016), pp. 50–58.
- [47] Bob Coecke and Aleks Kissinger. *Picturing Quantum Processes: A First Course in Quantum Theory and Diagrammatic Reasoning*. Cambridge University Press, 2017. DOI: [10.1017/9781316219317](https://doi.org/10.1017/9781316219317).
- [48] Bob Coecke and Dusko Pavlovic. “Quantum measurements without sums”. In: *Mathematics of Quantum Computation and Quantum Technology*. Taylor and Francis, 2007, pp. 577–620.
- [49] Bob Coecke, Dusko Pavlovic, and Jamie Vicary. “A new description of orthogonal bases”. In: *Mathematical structures in computer science* 23.3 (2012), pp. 555–567.
- [50] Bob Coecke and Simon Perdrix. “Environment and classical channels in categorical quantum mechanics”. In: *International Workshop on Computer Science Logic*. Springer. 2010, pp. 230–244.

- [51] Bob Coecke et al. “Strong Complementarity and Non-locality in Categorical Quantum Mechanics”. In: *2012 27th Annual IEEE Symposium on Logic in Computer Science* (June 2012). DOI: [10.1109/lics.2012.35](https://doi.org/10.1109/lics.2012.35).
- [52] R. Crubillé et al. “The Free Exponential Modality of Probabilistic Coherence Spaces.” In: *In Esparza J., Murawski A. (eds) Foundations of Software Science and Computation Structures. FoSSaCS 2017. Lecture Notes in Computer Science* (Berlin). Vol. 10203. Springer, 2017, pp. 20–35.
- [53] Marek Czachor. “Elementary gates for cartoon computation”. In: *Journal of Physics A: Mathematical and Theoretical* 40.31 (July 2007), F753–F759.
- [54] Vincent Danos and Laurent Regnier. “The structure of multiplicatives”. In: *Archive for Mathematical logic* 28.3 (1989), pp. 181–203.
- [55] Brian Day and Craig Pastro. “Note on Frobenius monoidal functors”. In: *New York J. Math* 14.733-742 (2008), p. 20.
- [56] Jacques Dixmier. *Von Neumann Algebras*. North Holland, Oct. 2011.
- [57] Chris Doran and Anthony Lasenby. *Geometric Algebra for Physicists*. Cambridge University Press, 2003. DOI: [10.1017/CB09780511807497](https://doi.org/10.1017/CB09780511807497).
- [58] Chris Doran and Anthony Lasenby. *Geometric Algebra for Physicists*. Cambridge University Press, 2007.
- [59] Ross Duncan. “Types for Quantum Computing”. PhD thesis. Oxford University, 2006.
- [60] Ross Duncan and Kevin Dunne. “Interacting Frobenius Algebras Are Hopf”. In: *Proceedings of the 31st Annual ACM/IEEE Symposium on Logic in Computer Science. LICS '16*. New York, NY, USA: Association for Computing Machinery, 2016, pp. 535–544.
- [61] Jeff Egger. “On involutive monoidal categories”. In: *Theory and Applications of Categories* 25.14 (2011), pp. 368–393.
- [62] Jeff Egger. “The Frobenius relations meet linear distributivity.” In: *Theory and Applications of Categories* 24 (2010), pp. 25–38.
- [63] Jeff Egger and Micah Blake McCurdy. “On cyclic star-autonomous categories”. In: *Journal of Pure and Applied Algebra* 216.8-9 (2012), pp. 1706–1725.
- [64] Thomas Ehrhard. “Finiteness spaces”. In: *Mathematical Structures in Computer Science* 15.4 (2005), pp. 615–646.

- [65] Marcelo P. Fiore. “Differential structure in models of multiplicative biadditive intuitionistic linear logic”. In: *International Conference on Typed Lambda Calculi and Applications*. Springer. 2007, pp. 163–177.
- [66] Matthew R. Francis and Arthur Kosowsky. “Geometric algebra techniques for general relativity”. In: *Annals of Physics* 311.2 (June 2004), pp. 459–502.
- [67] Peter Freyd and Andre Scedrov. *Categories, Allegories*. Vol. 39. North Holland, 1989.
- [68] Jean-Yves Girard. “Linear logic”. In: *Theoretical computer science* 50.1 (1987), pp. 1–101.
- [69] Jean-Yves Girard. *Linear Logic: Its Syntax And Semantics*. 1995.
- [70] Stefano Gogioso and Fabrizio Genovese. “Infinite-dimensional Categorical Quantum Mechanics”. In: Proceedings 13th International Conference on *Quantum Physics and Logic*, Glasgow, Scotland, 6-10 June 2016. Ed. by Ross Duncan and Chris Heunen. Vol. 236. Electronic Proceedings in Theoretical Computer Science. Open Publishing Association, 2017, pp. 51–69. DOI: [10.4204/EPTCS.236.4](https://doi.org/10.4204/EPTCS.236.4).
- [71] David J. Griffiths and Darrell F. Schroeter. *Introduction to quantum mechanics*. Cambridge University Press, 2018.
- [72] Stefano Guerrini. “Correctness of multiplicative proof nets is linear”. In: *Proceedings. 14th Symposium on Logic in Computer Science (Cat. No. PR00158)*. IEEE. 1999, pp. 454–463.
- [73] David Hestenes and Garret Sobczyk. *Clifford algebra to geometric calculus: a unified language for mathematics and physics*. Vol. 5. Springer Science & Business Media, 2012.
- [74] Chris Heunen. “Compactly accessible categories and quantum key distribution”. In: *Logical Methods in Computer Science* 4 (2008).
- [75] Chris Heunen. “Compactly accessible categories and quantum key distribution”. In: *Logical Methods in Computer Science* 4.4 (2008), pp. 1–26.
- [76] Chris Heunen and Vicary Jamie. *Categories for Quantum Theory: An Introduction*. Oxford University Press, Nov. 2019.
- [77] Chris Heunen and Manuel L Reyes. “Frobenius structures over Hilbert C*-modules”. In: *Communications in Mathematical Physics* 361.2 (2018), pp. 787–824.
- [78] Chris Heunen and Sean Tull. “Categories of relations as models of quantum theory”. In: *Electronic Proceedings in Theoretical Computer Science* 195 (Nov. 2015), pp. 247–261.

- [79] D. A. Higgs and K. Rowe. “Nuclearity in the category of complete semilattices”. In: *Journal of Pure and Applied Algebra* 57 (1989), pp. 67–78.
- [80] Basil J. Hiley and Robert E. Callaghan. *The Clifford Algebra approach to Quantum Mechanics A: The Schrödinger and Pauli Particles*. 2010. arXiv: [1011.4031](https://arxiv.org/abs/1011.4031) [[math-ph](https://arxiv.org/archive/math)].
- [81] Martin Hyland and Andrea Schalk. “Glueing and orthogonality for models of linear logic”. In: *Theoretical Computer Science* 294.1–2 (Feb. 2003), pp. 183–231.
- [82] André Joyal. “Free bicomplete categories”. In: *Mathematical Reports* XVII (1995), pp. 219–225.
- [83] André Joyal. “Free bicomplete categories”. In: *Mathematical Reports* XVII (1995), pp. 213–218.
- [84] G. Max Kelly. “On MacLane’s conditions for coherence of natural associativities, commutativities, etc.” In: *Journal of Algebra* 1.4 (1964), pp. 397–402. ISSN: 0021-8693.
- [85] G.M. Kelly and M.L. Laplaza. “Coherence for compact closed categories”. In: *Journal of Pure and Applied Algebra* 19 (1980), pp. 193–213. ISSN: 0022-4049. DOI: [https://doi.org/10.1016/0022-4049\(80\)90101-2](https://doi.org/10.1016/0022-4049(80)90101-2). URL: <https://www.sciencedirect.com/science/article/pii/0022404980901012>.
- [86] Max Kelly. “Doctrinal adjunction”. In: *Category Seminar*. Springer. 1974, pp. 257–280.
- [87] Alex Kissinger and Saunders Uijlen. “A categorical semantics for causal structure”. In: *Logical Methods Computer Science* 15 (2019).
- [88] Jürgen Koslowski. “An extended view of the Chu-construction”. In: *Theory and Applications of Categories* 17.6 (2006), pp. 103–126.
- [89] Yves Lafont. “Logiques, catégories & machines: Implantation de langages de programmation guidé par la logique catégorique”. PhD thesis. [S.l.] : [s.n.], 1988: Université Paris Diderot - Paris, 1988.
- [90] Jean-Simon Pacaud Lemay. “Lifting coalgebra modalities and MELL Model Structure to Eilenberg-Moore categories”. In: *Logical Methods in Computer Science* 15.4 (Nov. 2019), pp. 215–242.

- [91] Jean-Simon Pacaud Lemay. “Why FHilb is not an interesting (co)differential category”. In: *Electronic Proceedings in Theoretical Computer Science* 318 (May 2020), pp. 13–26. ISSN: 2075-2180. DOI: [10.4204/eptcs.318.2](https://doi.org/10.4204/eptcs.318.2). URL: <http://dx.doi.org/10.4204/EPTCS.318.2>.
- [92] Robert Lin. *A Graphical Calculus for Multi-Qudit Computations with Generalized Clifford Algebras*. Mar. 2021. arXiv: [2103.16081](https://arxiv.org/abs/2103.16081) [quant-ph].
- [93] Robert Lin. *An Algebraic Framework for Multi-Qudit Computations with Generalized Clifford Algebras*. Mar. 2021. arXiv: [2103.15324](https://arxiv.org/abs/2103.15324) [quant-ph].
- [94] Douglas Lundholm and Lars Svensson. “Clifford algebra, geometric algebra, and applications”. In: (2009). arXiv: [0907.5356](https://arxiv.org/abs/0907.5356) [math-ph].
- [95] Saunders Mac Lane. *Categories for the Working Mathematician*. Vol. 5. Berlin/Heidelberg, Germany: Springer Science & Business Media, 2013.
- [96] Roberto Maieli and Quintijn Puite. “Modularity of proof-nets”. In: *Archive for Mathematical Logic* 44.2 (2005), pp. 167–193.
- [97] Shahn Majid. *Foundations of Quantum Group Theory*. Cambridge University Press, Apr. 2000.
- [98] Paul-André Melliér, Nicholas Tabareau, and Christine Tasson. “An explicit formula for the free exponential modality of linear logic”. In: *Mathematical Structures in Computer Science* 28.7 (2018), pp. 1253–1286. DOI: [10.1017/S0960129516000426](https://doi.org/10.1017/S0960129516000426).
- [99] David Mermin. “What’s wrong with this pillow?” In: *Mathematical Structures in Computer Science* 42.4 (1989), pp. 615–646. URL: <https://doi.org/10.1063/1.2810963>.
- [100] B. Musto and Jamie Vicary. “Quantum Latin squares and unitary error bases”. In: *Quantum Inf. Comput.* 16 (2016), pp. 1318–1332.
- [101] John von Neumann and Robert T. Beyer. *Mathematical Foundations of Quantum Mechanics: New Edition*. NED - New edition. Princeton University Press, 2018.
- [102] Michael A. Nielsen and Isaac L. Chuang. *Quantum Computation and Quantum Information: 10th Anniversary Edition*. Cambridge University Press, 2010.
- [103] Craig Pastro and Ross Street. “Weak Hopf monoids in braided monoidal categories”. In: *Algebra & Number Theory* 3.2 (2009), pp. 149–207.
- [104] Dusko Pavlovic. “Relating toy models of quantum computation: comprehension, complementarity and dagger mix autonomous categories”. In: *Electronic Notes in Theoretical Computer Science* 270.2 (2011), pp. 121–139.

- [105] Hans-E. Porst. “On categories of monoids, comonoids, and bimonoids”. In: *Quaestiones Mathematicae* 31.2 (2008), pp. 127–139.
- [106] Vaughan Pratt. “Linear Logic for Generalized Quantum Mechanics”. In: *In Proc. Workshop on Physics and Computation (PhysComp’92)*. IEEE, 1993, pp. 166–180.
- [107] Abraham Robinson. *Non-standard analysis*. Princeton University Press, June 1996.
- [108] Andrea Schalk. “What is a categorical model for Linear Logic?” Manuscript downloadable from www.cs.man.ac.uk/~schalk/notes/llmodel.pdf. 2004. (Visited on 04/17/2021).
- [109] Peter Selinger. “A survey of graphical languages for monoidal categories”. In: *New Structures for Physics*. Springer, 2010, pp. 289–355.
- [110] Peter Selinger. “Dagger compact closed categories and completely positive maps”. In: *Electronic Notes in Theoretical Computer Science* 170 (2007), pp. 139–163.
- [111] Peter Selinger. “Idempotents in Dagger Categories: (Extended Abstract)”. In: *Electron. Notes Theor. Comput. Sci.* 210 (2008), pp. 107–122.
- [112] Peter Selinger. “Towards a quantum programming language”. In: *Mathematical Structures in Computer Science* 14 (2004), pp. 527–586.
- [113] Sergey Slavnov. “On Banach spaces of sequences and free linear logic exponential modality”. In: *Mathematical Structures in Computer Science* 29.2 (2017), pp. 215–242.
- [114] Shyamal S. Somaroo, David G. Cory, and Timothy F. Havel. “Expressing the operations of quantum computing in multiparticle geometric algebra”. In: *Physics Letters A* 240.1 (1998), pp. 1–7.
- [115] Christine Tasson. “Sémantiques et Syntaxes Vectorielles de la Logique Linéaire”. Theses. Université Paris-Diderot - Paris VII, Dec. 2009. URL: <https://tel.archives-ouvertes.fr/tel-00440752>.
- [116] Jayme Jr. Vaz and Roldão Jr. da Rocha. *An Introduction to Clifford Algebras and Spinors*. Oxford University Press, 2019.
- [117] Jamie Vicary. “A categorical framework for the quantum harmonic oscillator”. In: *International Journal of Theoretical Physics* 47.12 (2008), pp. 3408–3447.
- [118] Jamie Vicary. “Categorical formulation of finite-dimensional quantum algebras”. In: *Communications in Mathematical Physics* 304.3 (Nov. 2010), pp. 765–796.
- [119] Alexander Yu Vlasov. “Clifford algebras and universal sets of quantum gates”. In: *Physical Review A* 63.5 (Apr. 2001).

- [120] Alexander Yu Vlasov. *Quantum gates and Clifford algebras*. 1999. arXiv: [9907079](#) [quant-ph].