

Structural Analysis by Modified Signature Matrix for Integro-differential-algebraic Equations

Wenqiang Yang^{a,b}, Wenyuan Wu^{a,b,*}, Greg Reid^c

^a*Chongqing Key Laboratory of Automated Reasoning and Cognition, Chongqing Institute of Green and Intelligent Technology, Chinese Academy of Sciences*

^b*Chongqing School, University of Chinese Academy of Sciences*

^c*Mathematics Department, University of Western Ontario*

Abstract

Integro-differential-algebraic equations (IDAE)s are widely used in applications of engineering and analysis. When there are hidden constraints in an IDAE, structural analysis is necessary. But if derivatives of dependent variables appear in their integrals, the existing definition of the signature matrix for an IDAE cannot be satisfied. Moreover, if an IDAE has a singular Jacobian matrix after structural analysis by the Σ -method, improved structural analysis methods are proposed to regularize it. However, the optimal value of an IDAE may be negative which can not ensure the termination of the regularization. Furthermore, overestimation of the signature matrix may also lead to failure of its structural analysis.

In this paper, firstly, we redefine the signature matrix and introduce a definition of the degree of freedom for IDAEs. Thus, the termination of improved structural analysis methods can be guaranteed. Secondly, the detection method by points is proposed to deal with the problem of overestimation of signature matrix. Thirdly, the embedding method has proved to suitable for structural unamenable IDAEs, including those types that arise from symbolic cancellation and numerical degeneration. Finally, the global numerical method is applied to an example of two-stage drive system which can help to find all solutions for IDAEs by witness points. Hopefully, through the example of pendulum curtain, the approach for IDAEs proposed in this paper can be applied to integro-partial-differential-algebraic equations (IPDAE)s.

*Corresponding author

Email address: wuwenyuan@cigit.ac.cn (Wenyuan Wu)

Keywords: integro-differential-algebraic equation, signature matrix, degree of freedom, structural method, witness point

PACS: 0000, 1111

2000 MSC: 0000, 1111

1. Background

In applications, IDAEs may occur in the following cases. First of all, IDAEs are often used to analyze dynamic changes during a interval of time or a distance, such as in electric circuits [1], hydraulic circuits [2], chemical reactions [3] and one-dimensional heat conduction [4]. Secondly, IDAEs depend on the selection of dependent variables during modeling. When analyzing the change of current, according to Kirchhoff laws, capacitors correspond to the differential of the change of current, while inductors correspond to the integral of the change of current [5]. Thirdly, the continuous-time PID controller [6] is widely used in control engineering which is an IDAE system with three parameters to be determined.

Let the independent variable $t \in \mathbb{I} = [t_0, t_f] \subseteq \mathbb{R}$ and the unknown dependent variable $\mathbf{x} = (x_1(t), \dots, x_n(t))$. Suppose $\mathbf{x}, \mathbf{x}^{(1)}, \dots, \mathbf{x}^{(\ell)}$ are vectors in \mathbb{R}^n , where $\boldsymbol{\ell} = (\ell_1, \dots, \ell_n)$ is a n dimensional non-negative integer vector, and $\mathbf{x}^{(\ell)} = (x^{(\ell_1)}, \dots, x^{(\ell_n)})$. $x^{(\ell_k)}$ is the ℓ_k -th order derivative of $x_k(t)$, for $k = 1, \dots, n$, with $\mathbf{x}^{(0)} \equiv \mathbf{x}$. Here we consider maps $\boldsymbol{\phi} : \mathbb{I} \times \mathbb{R}^{(\sum_{k=1}^n \ell_k + 1)n} \rightarrow \mathbb{R}^m$ and $\boldsymbol{\varphi} : \mathbb{I} \times \mathbb{I} \times \mathbb{R}^{(\sum_{k=1}^n \ell_k + 1)n} \times \mathbb{R}^{(\sum_{k=1}^n \ell_k + 1)n} \rightarrow \mathbb{R}^m$ are given real analytic, where possibly $m \neq n$. An integro-differential-algebraic equation (IDAE) can be described as follow:

$$\boldsymbol{\phi}(t, \mathbf{x}^{(\ell)}(t)) + \int_{t_0}^t \boldsymbol{\varphi}(t, s, \mathbf{x}^{(\ell)}(s), \mathbf{x}^{(\ell)}(t)) ds = \mathbf{F}(t, \mathbf{x}, \dots, \mathbf{x}^{(\ell)}) = \mathbf{0} \quad (1)$$

An IDAE in Equation (1) consists of differential algebraic equation (DAE)'s part — $\boldsymbol{\phi}(t, \mathbf{x}^{(\ell)}(t))$, noted as $\boldsymbol{\Phi}$, and integral algebraic equation (IAE)'s part — $\int_{t_0}^t \boldsymbol{\varphi}(t, s, \mathbf{x}^{(\ell)}(s), \mathbf{x}^{(\ell)}(t)) ds$, noted as $\boldsymbol{\Psi}$. If $\boldsymbol{\varphi}(t, s, \mathbf{x}^{(\ell)}(s), \mathbf{x}^{(\ell)}(t)) = \mathbf{0}$, then \mathbf{F} is a typical DAE $\boldsymbol{\phi}(t, \mathbf{x}^{(\ell)}(t)) = \mathbf{0}$. If $\boldsymbol{\phi}(t, \mathbf{x}^{(\ell)}(t)) = \mathbf{0}$, then \mathbf{F} is a typical IAE $\int_{t_0}^t \boldsymbol{\varphi}(t, s, \mathbf{x}^{(\ell)}(s), \mathbf{x}^{(\ell)}(t)) ds = \mathbf{0}$.

For linear time-varying IDAE systems, the Laplace transform is widely used to solve most of them effectively [5]. However, when dealing with an IDAE system with a high index or nonlinear or singular Jacobian matrix, the

Laplace transform will fail. Collocation methods are also a good choice for numerical solution of such IDAE, but are only applicable to low index (≤ 1)[7] or specific [8] IDAEs. Thus, similar to DAEs, it is necessary for an IDAE to be processed by structural analysis.

Existing methods [9, 10, 11, 12] for a DAE to find an initial point on constraints can be applied directly for an IDAE with on integrals at initial time $t = t_0$. Moreover, the Homotopy method can find all initial points of a polynomial DAE from each component through at least one witness point [13]. And these witness points can help to detect not only the failure caused by a singular Jacobian matrix but also the failure caused by an incorrect signature matrix (see Example 4.1). However, there is little research in this area.

Much work has been done on different indices [14, 15, 7] for structural analysis. The differential index of this IDAE can also be defined as the minimum number of differentiation to find all constraints. It is difficult to find hidden constraints directly [9] for IDAEs with high index (≥ 2). Without index reduction, a numerical solution may drift off the true solution [16]. The direct method [17] of index reduction is too complex to be applied. The indirect method for the Σ -method [18] is based on the signature matrix and is efficient. To make it possible for IAEs [19] and IDAEs [20], the signature matrix had to be redefined. However, this definition of the signature matrix is still incomplete when it gives rise to an IDAE with derivatives.

An IDAE is called “**structurally amenable**” (S-amenable) if the Σ -method is applicable. Similarly, in a “**structurally unamenable** (S-unamenable) IDAE, the Σ -method may fail since the Jacobian matrix is singular after differentiation. Improved structural methods have been proposed to regularize the Jacobian matrices of S-unamenable DAEs, including direct methods [21, 22, 23, 24, 25]. Indirect methods have also been proposed (the LC-method [26], the embedding method [13], the ES-method [26], the substitution method [27] and the augmentation method [27]). For IDAEs, Bulatov [28] dealt with some linear explicit singular IDAEs by using special properties of the matrix polynomials. Zolfaghari [16] extended the LC-method and the ES-method to linear IDAEs. But these methods also fail in the case of numerical degeneration (see Example 5.1). Essentially, unlike for DAEs with the non-negative optimal value of the signature matrix, the termination of improved structural methods can no longer be guaranteed since the optimal value may be negative.

In this paper, our contributions can be summarized as:

- We modify the definition of the signature matrix for IDAEs with derivatives in their integrals. We also define the degree of freedom for IDAEs and then it is conducive to the termination of improved structural methods.
- We propose a detection method to correct the overestimation of the signature matrix due to constraints been ignored.
- We extend the embedding method for IDAEs that can help to restore full-rank Jacobian matrices without algebraic elimination.

2. Structural Analysis by Σ -method for DAES

The Σ -method is an efficient method for DAES, and this motivates on extension of it to IDAEs. In this section, we provide a brief introduction to it to explain terminology and notation.

Definition 2.1. *Suppose that the k -th order of derivative of x_j occurs in F_i , then the partial derivative $\partial F_i / \partial x_j^{(k)}$ is not identical zero. The leading derivative of an equation $F_i = 0$ with respect to x_j is denoted by $\text{LD}(F_i, x_j)$ and is the highest order of derivative such that some $F_i \in \mathbf{F}$ depends on $x_j^{(k)}$ for some $k \in \mathbb{Z}$. Thus, we construct an $n \times n$ signature matrix $\boldsymbol{\sigma}(\mathbf{F}) = [\sigma_{i,j}]_{1 \leq i \leq n, 1 \leq j \leq n}(\mathbf{F})$ of DAES \mathbf{F} by Pryce [18]:*

$$[\sigma_{i,j}](\mathbf{F}) := \begin{cases} \text{the order of } \text{LD}(F_i, x_j(t)), & \text{if } x_j(t) \text{ occurs in } F_i; \\ -\infty, & \text{otherwise.} \end{cases} \quad (2)$$

Let $\mathbf{c} = (c_1, \dots, c_n)$ and $\mathbf{d} = (d_1, \dots, d_n)$ be a dual optimal solution. There must be a highest-value transversal (HVT) of the signature matrix, denoted by $\sum_{(i,j) \in T} \sigma_{ij}$, in which $d_j - c_i = \sigma_{ij}$ for all $(i, j) \in T$, and T is the set of indices of elements in different rows and columns corresponding to the maximum value. According to [16], the dual problem is equivalent to minimizing $\sum_{(i,j) \in T} \sigma_{ij} = \sum d_j - \sum c_i$.

This can be formulated as an assignment problem (AP):

$$\delta(\mathbf{F}) \left\| \begin{array}{l} \text{Minimize } \delta = \sum d_j - \sum c_i, \\ \text{where } d_j - c_i \geq \sigma_{ij}, \\ c_i \geq 0 \end{array} \right. \quad (3)$$

Let $\delta(\mathbf{F})$ be the optimal value of the problem (3).

Let \mathbf{D} be the formal total derivative operator with respect to independent variable t :

$$\mathbf{D} = \frac{\partial}{\partial t} + \sum_{k=0}^{\infty} \mathbf{x}^{(k+1)} \frac{\partial}{\partial \mathbf{x}^{(k)}} \quad (4)$$

If we specify the differentiation order for F_i to be c_i , then $c_i \geq 0$, for $i = 1, \dots, n$. Then the differentiation of \mathbf{F} up to the order \mathbf{c} is

$$\mathbf{F}^{(\mathbf{c})} = \{F_1, \mathbf{D}F_1, \dots, \mathbf{D}^{c_1} F_1\} \cup \dots \cup \{F_n, \mathbf{D}F_n, \dots, \mathbf{D}^{c_n} F_n\} = \mathbf{D}^{\mathbf{c}} \mathbf{F} \quad (5)$$

The number of equations of $\mathbf{F}^{(\mathbf{c})}$ is $n + \sum_{i=1}^n c_i$.

Without loss of generality, we assume $c_1 \geq c_2 \geq \dots \geq c_n$, and let $k_c = c_1$, which is closely related to the *index* of system \mathbf{F} (see [18]). The r -th order derivative of F_j with respect to t is denoted by $F_j^{(r)}$. Then we can partition $\mathbf{F}^{(\mathbf{c})}$ into $k_c + 1$ parts, for $0 \leq p \in \mathbb{Z} \leq k_c$ given by

$$\mathbf{B}_p := \{F_j^{(p+c_j-k_c)} : 1 \leq j \leq n, p + c_j - k_c \geq 0\}. \quad (6)$$

Here, we call \mathbf{B}_{k_c} as the **top block** of $\mathbf{F}^{(\mathbf{c})}$ and $\mathbf{F}^{(\mathbf{c}-1)} = \{\mathbf{B}_0, \dots, \mathbf{B}_{k_c-1}\}$ as the **constraints**.

Similarly, let $k_d = \max(d_j)$ and we can partition all the variables into $k_d + 1$ parts:

$$\mathbf{X}^{(q)} := \{x_j^{(q+d_j-k_d)} : 1 \leq j \leq n\}. \quad (7)$$

Here, if $(q + d_j - k_d) < 0$, it means it's integral of x_j with respect to the independent variable t .

3. Structural Analysis for IDAEs

However, for IDAEs, the existing definition of the signature matrix has encountered great challenges, due to the derivatives in the IAE's part of the IDAE.

The improved structural methods for DAEs to find hidden constraints are equivalent to decreasing its optimal value δ . However, when it encounters to IDAEs, there are several difficulties: (a) the scheme of the combinatorial relaxation framework [27] in Phase 3 is not applicable; (b) the optimal value may be negative in Example 3.3; (c) the termination of improved structural methods can not be ensured.

Thus, we should adapt several general definitions to erase these difficulties in structural analysis.

3.1. Modified Signature Matrix for IDAEs

Unlike DAEs or IAEs, the signature matrix of IDAEs must contain the information of both parts.

For the DAE part of the IDAE, we can easily construct an $n \times n$ signature matrix $\boldsymbol{\sigma}(\boldsymbol{\Phi}) = [\sigma_{i,j}]_{1 \leq i \leq n, 1 \leq j \leq n}(\boldsymbol{\Phi})$ according to Definition 2.1. For the IAE's part, [19] gave an incomplete definition of its signature matrix without considering derivatives. In this section, we give a new the definition of the signature matrix for IDAEs.

Definition 3.1. Let $\boldsymbol{\Psi} = \int_{t_0}^t \boldsymbol{\varphi}(t, s, \mathbf{x}^{(\ell)}(s), \mathbf{x}^{(\ell)}(t)) ds$ be sufficiently smooth, defined in Equation (1). For any x_j of \mathbf{x} and for some $t \in \mathbb{I}$, let $v_{i,j} \geq 1$ be the **smallest** integer of some $\varphi_i \in \boldsymbol{\varphi}$ for which

$$\frac{\partial}{\partial x_j} \left(\frac{\partial^{v_{i,j}-1}}{\partial t^{v_{i,j}-1}} \varphi_i(t, s, \mathbf{x}^{(\ell)}(s), \mathbf{x}^{(\ell)}(t)) \Big|_{s=t} \right) \neq 0 \quad (8)$$

Let $\omega_{i,j} \geq 1$ be the **largest** integer for which

$$\frac{\partial}{\partial x_j} \left(\frac{\partial^{\omega_{i,j}-1}}{\partial t^{\omega_{i,j}-1}} \varphi_i(t, s, \mathbf{x}^{(\ell)}(s), \mathbf{x}^{(\ell)}(t)) \Big|_{s=t} \right) \neq 0 \quad (9)$$

We say $\boldsymbol{\Psi}$ is $\omega_{i,j}$ -integral with respect to x_j .

If Equation (8) does not hold for any integer $v_{i,j} \geq 1$, then we define $v_{i,j} = \infty$ which means ∞ -smoothing.

If Equation (9) does not hold for any integer $\omega_{i,j} \geq 1$, then we define $\omega_{i,j} = 0$ which means x_j does not occur in φ_i .

Remark 3.1. Note that Equation (8) implies that $\boldsymbol{\Psi}$ is $v_{i,j}$ -smoothing [19] with respect to x_j . In particular, this definition also applies to while x_j does not occur in φ_i .

Example 3.1. Let $\varphi_i(t, s, \mathbf{x}(s)) = x_2(s)^2 + (t-s)x_1(s)$, where $\mathbf{x}(s) = (x_1(s), x_2(s), x_3(s)) \neq \mathbf{0}$. Here,

$$\begin{aligned} \varphi_i(t, t, \mathbf{x}(t)) &= x_2(t)^2 \\ \frac{\partial}{\partial x_1} (\varphi_i(t, t, \mathbf{x}(t))) &= 0, & \frac{\partial}{\partial x_2} (\varphi_i(t, t, \mathbf{x}(t))) &= 2 \cdot x_2 \neq 0, \\ \frac{\partial}{\partial x_1} \left(\frac{\partial}{\partial t} \varphi_i(t, s, \mathbf{x}(s)) \Big|_{s=t} \right) &= 1 \neq 0, & \frac{\partial}{\partial x_2} \left(\frac{\partial}{\partial t} \varphi_i(t, s, \mathbf{x}(s)) \Big|_{s=t} \right) &= 0, \\ \frac{\partial}{\partial x_1} \left(\frac{\partial^k}{\partial t^k} \varphi_i(t, s, \mathbf{x}(s)) \Big|_{s=t} \right) &= 0, & \frac{\partial}{\partial x_2} \left(\frac{\partial^k}{\partial t^k} \varphi_i(t, s, \mathbf{x}(s)) \Big|_{s=t} \right) &= 0, \text{ for } k \geq 2. \end{aligned}$$

Therefore, by Equation (8) and Remark 3.1, Ψ is 2-smoothing with respect to x_1 and 1-smoothing with respect to x_2 and ∞ -smoothing with respect to x_3 . Significantly, $x_2(t)$ appearing in φ_i is a dependent variable with independent variable t , which indicates that its corresponding element in the signature matrix of the DAE part of IDAE should be considered by Definition 2.1.

By Equation (9), Ψ is 2-integral with respect to x_1 and 1-integral with respect to x_2 , and 0-integral with respect to x_3 .

Since $\sigma_{i,j}$ is the order of the highest derivative of variable $x_j(s)$ occurs in the i -th function [18], we can define an $n \times n$ signature matrix as follows:

Definition 3.2 (Signature Matrix for IAE Part). Consider an IDAE of Equation (1), we define the signature matrix, as $n \times n$ matrix $\sigma(\Psi) = [\sigma_{i,j}]_{1 \leq i \leq n, 1 \leq j \leq n}(\Psi)$ of IAE part:

$$[\sigma_{i,j}](\Psi) := \begin{cases} \max(\beta_1, \beta_2), & x_j(t) \text{ and } x_j(s) \text{ occur in } \varphi_i; \\ \beta_2, & \text{only } x_j(s) \text{ occurs in } \varphi_i. \\ -\infty, & \text{otherwise;} \end{cases} \quad (10)$$

Where β_1 is the order of $\text{LD}(\varphi_i, x_j(t))$ and β_2 is the order of $\text{LD}(\varphi_i, x_j(s)) - v_{i,j}$.

When φ_i does not contain the derivative of x_j , the order of $\text{LD}(\varphi_i, x_j)$ is 0, which is the same as the definition of [20].

Definition 3.3 (Signature Matrix for IDAE). The $n \times n$ signature matrix $\sigma(\mathbf{F}) = [\sigma_{i,j}]_{1 \leq i \leq n, 1 \leq j \leq n}(\mathbf{F})$ of IDAE \mathbf{F} of Equation (1) is defined as:

$$[\sigma_{i,j}](\mathbf{F}) := \max_{i,j} ([\sigma_{i,j}](\Phi), [\sigma_{i,j}](\Psi)) \quad (11)$$

Obviously, this is equivalent to the signature matrix defined by Zolfaghar in [16] in the case that there is no derivative in IAES part.

Example 3.2. Consider the following IDAE [16] with dependent variables $x_1(t)$ and $x_2(t)$:

$$\mathbf{F} = \begin{cases} e^{-x_1(t)-x_2(t)} - g_1(t) \\ \int_{t_0}^t (x_1(s) + x_2(s) + (t-s)x_1(s) \cdot x_2(s)) ds - g_2(t) \end{cases}$$

Where $g_1(t)$ and $g_2(t)$ are given functions. Its Jacobian

$$\mathcal{J} = \begin{pmatrix} -e^{-x_1(t)-x_2(t)} & -e^{-x_1(t)-x_2(t)} \\ 1 & 1 \end{pmatrix}$$

is identically singular, with rank equals to 1.

By Equation (1), we get $\Phi = \begin{cases} e^{-x_1(t)-x_2(t)} - g_1(t) \\ -g_2(t) \end{cases}$ and $\Psi = \begin{cases} 0 \\ \int_{t_0}^t (x_1(s) + x_2(s) + (t-s)x_1(s) \cdot x_2(s)) ds \end{cases}$

Then, it easily follows that $[\sigma_{i,j}](\Phi) = \begin{pmatrix} 0 & 0 \\ -\infty & -\infty \end{pmatrix}$ by Equation (2), and $[\sigma_{i,j}](\Psi) = \begin{pmatrix} -\infty & -\infty \\ -1 & -1 \end{pmatrix}$ by Equation (10). So $\omega = \begin{pmatrix} 0 & 0 \\ 2 & 2 \end{pmatrix}$ by Equation (9). Thus, $[\sigma_{i,j}](\mathbf{F}) = \begin{pmatrix} 0 & 0 \\ -1 & -1 \end{pmatrix}$ by Equation (11).

3.2. The Degree of Freedom of IDAEs

Finding hidden constraints is essential to minimizing the degree of freedom DOF of an IDAE \mathbf{F} . The termination of improved structural methods depends on the existence of the solution, which implies $DOF \geq 0$. The definition of general form of DOF is as follows:

Definition 3.4 (DOF for IDAE). Let a system \mathbf{F} contains m equations and n dependent variables, DOF of \mathbf{F} is $DOF(\mathbf{F}) := n - \text{rank}(\mathcal{J})$ which determines the existence of the solution. Without redundant equations, then $DOF(\mathbf{F}) := n - m$.

There is a relationship between DOF and optimal value, which can help to deduce the DOF of IDAEs directly.

Proposition 3.1. Let (\mathbf{c}, \mathbf{d}) be the optimal solution of Problem (3) for a given IDAE \mathbf{F} . And x_j is $\omega_{i,j}$ -integral in φ_i of F_i . Then $DOF(\mathbf{F}) := \delta(\mathbf{F}) + \sum_j \max_i \omega_{i,j}$.

PROOF. Since any x_j in φ_i of F_i is $\omega_{i,j}$ -integral, there must be a primitive function with respect to the dependent variable x_j , whose $\omega_{i,j}$ -th derivative with respect to the independent variable t is x_j . Thus there are $\omega_{i,j}$ dependent

variables related to the integral of x_j in φ_i of F_i . Hence, there are $\max_i \omega_{i,j}$ dependent variables related to the integral of x_j in \mathbf{F} . Since $\mathbf{F}^{(c)}$ is the differentiation of \mathbf{F} , there are also $\max_i \omega_{i,j}$ dependent variables related to the integral of x_j in $\mathbf{F}^{(c)}$.

Obviously, the derivatives in $\mathbf{F}^{(c)}$ are $\mathbf{x}^{(\leq d)}$. Assume there are n equations in \mathbf{F} . There must be $n + \sum_j (d_j + \max_i \omega_{i,j})$ dependent variables and $n + \sum_i c_i$ equations in $\mathbf{F}^{(c)}$. And there must be $n + \sum_j (d_j + \max_i \omega_{i,j}) - \sum_i c_i$ dependent variables and n equations in \mathbf{F} . By Definition 3.4, $DOF(\mathbf{F}) = DOF(\mathbf{F}^{(c)})$. Moreover, since $\delta(\mathbf{F}) = \sum_j d_j - \sum_i c_i$, then

$$DOF(\mathbf{F}) = \delta(\mathbf{F}) + \sum_j \max_i \omega_{i,j}$$

□

In the special case of a DAE \mathbf{F} , we have $\omega_{i,j} = 0$. Then the DOF of \mathbf{F} is $\delta(\mathbf{F})$, this is the same as the definition of DOF in [26].

Since the optimal value of \mathbf{F} is limited to square systems, the DOF of non-square systems $\mathbf{F}^{(c)}$ should be extended.

Proposition 3.2. *Let an IDAE \mathbf{F} consist of two blocks \mathbf{A} and \mathbf{B} , where \mathbf{F} contains p equations and n dependent variables $p \geq n$, and suppose the signature matrix of \mathbf{A} is an $n \times n$ square matrix. So \mathbf{B} contains the remaining $(p - n)$ equations. Let $DOF(\mathbf{A})$ be the degree of freedom of \mathbf{A} 's signature matrix. Then $DOF(\mathbf{F}) = DOF(\mathbf{A}) - \#eqns(\mathbf{B})$, where $\#eqns(\mathbf{B})$ is the number of equations in \mathbf{B} .*

PROOF. Since the set of dependent variables of block \mathbf{B} is a subset of the dependent variables of block \mathbf{A} , $DOF(\mathbf{A}) = \#vars(\mathbf{A}) - \#eqns(\mathbf{A})$ and $DOF(\mathbf{F}) = \#vars(\mathbf{A}) - \#eqns(\mathbf{F})$, where $\#vars(\mathbf{A})$ is the number of dependent variables in \mathbf{A} . Since there are no redundant equations, $\#eqns(\mathbf{F}) = \#eqns(\mathbf{A}) + \#eqns(\mathbf{B})$. Hence $DOF(\mathbf{F}) = DOF(\mathbf{A}) - \#eqns(\mathbf{B})$. □

Example 3.3. *Consider the IDAE given in Example 3.2 which has no constraints. The structural information obtained by the Σ -method is that the dual optimal solution is $\mathbf{c} = (0, 1)$ and $\mathbf{d} = (0, 0)$. Then the DOF of this IDAE by Proposition 3.1 is $DOF(\mathbf{F}) = \delta(\mathbf{F}) + \sum_j \max_i \omega_{i,j} = -1 + 4 = 3$.*

4. Detection Method for Incorrect Signature Matrix

Unfortunately, the Σ -method updated with the definitions in section 3 may fail to overestimate some “true” $\sigma_{i,j}$. That will yield incorrect optimal solutions and hidden constraints [26]. The case of an incorrect signature matrix is a typical case of such failure. In that case, the function corresponding to $\sigma_{i,j}$, i.e. to coefficient and Equation (8), etc., may be vanish on the constraints of IDAE. This occurs in Example 4.1, and may lead to incorrect optimal solutions.

Example 4.1. Consider the following IDAE with dependent variables $x(t)$ and $y(t)$:

$$\mathbf{F} = \left\{ y(t) - \dot{x}(t), x(t) + \int_{t_0}^t (t-s) \cdot \left(\frac{y(s)}{2} - \dot{x}(s) \right) \cdot y(s) ds \right\}. \quad (12)$$

Then

$$[\sigma_{i,j}](\mathbf{F}) = \begin{array}{c} \begin{array}{cc} x & y \\ \left(\begin{array}{cc} 1 & 0 \\ 0 & -2 \end{array} \right) & \begin{array}{c} c_i \\ 0 \\ 2 \end{array} \\ d_j & \begin{array}{cc} 2 & 0 \end{array} \end{array} \quad \times$$

$$[\sigma_{i,j}](\mathbf{F}) = \begin{array}{c} \begin{array}{cc} x & y \\ \left(\begin{array}{cc} 1 & 0 \\ 0 & -\infty \end{array} \right) & \begin{array}{c} c_i \\ 0 \\ 1 \end{array} \\ d_j & \begin{array}{cc} 1 & 0 \end{array} \end{array} \quad \checkmark$$

In the latter equation, for y , the Definition of Equation (8) implies

$$\begin{aligned} \frac{\partial}{\partial y} \left((t-s) \cdot \left(\frac{y(s)}{2} - \dot{x}(s) \right) \cdot y(s) \right) \Big|_{s=t} &= 0, \\ \frac{\partial}{\partial y} \frac{\partial}{\partial t} \left((t-s) \cdot \left(\frac{y(s)}{2} - \dot{x}(s) \right) \cdot y(s) \right) \Big|_{s=t} &= y(t) - \dot{x}(t), \\ \frac{\partial}{\partial y} \frac{\partial^k}{\partial t^k} \left((t-s) \cdot \left(\frac{y(s)}{2} - \dot{x}(s) \right) \cdot y(s) \right) \Big|_{s=t} &= 0, \text{ for } k \geq 2. \end{aligned}$$

However, $y(t) - \dot{x}(t)$ is *zero* by Equation (12). That means the latter equation is ∞ -smoothing rather than 2-smoothing with respect to y .

To find the correct signature matrix, we need to determine whether each of its elements is vanishing or not on the known constraints. Gröbner bases [29] or Triangular Decomposition [30] are possible approaches to this problem, but they are high complexity and are only feasible in polynomial cases. Besides that, the signature matrix may be different for each component of constraints. In this section, we apply an efficient detection method [13] to construct the corresponding signature matrix for each component of constraints.

Proposition 4.1 (Proposition 2.2.8 of [31]). *If f_1, \dots, f_m are real analytic in some neighbourhood of the point $\mathbf{p} \in \mathbb{R}^n$ and g is real analytic in some neighbourhood of the point $(f_1(\mathbf{p}), \dots, f_m(\mathbf{p})) \in \mathbb{R}^m$, then the composition of functions $g(f_1(\mathbf{x}), \dots, f_m(\mathbf{x}))$ is real analytic in a neighborhood of \mathbf{p} .*

Proposition 4.2 (Proposition 2.2.3 of [31]). *Let f be a real analytic function defined on an open subset $U \subset \mathbb{R}^n$, Then f is continuous and has continuous, real analytic partial derivatives of all orders. Further, the indefinite integral with respect to any variable is real analytic.*

According to Proposition 4.1 and Proposition 4.2, since ϕ and φ are real analytic, thus the IDAE \mathbf{F} is real analytic.

Definition 4.1 (Real zero set, singular set). *The real zero set of a real analytic system $\mathbf{f} = \mathbf{0}$ is denoted by $Z_{\mathbb{R}}(\mathbf{f})$. The singular set of $\mathbf{f} = \mathbf{0}$, denoted by \mathfrak{S} , are those points at which $Z_{\mathbb{R}}(\mathbf{f})$ is locally not an analytic manifold.*

Then $Z_{\mathbb{R}}(\mathbf{f})/\mathfrak{S} = \cup_{i \in \mathcal{I}} C_i$ where each C_i is a connected component of $Z_{\mathbb{R}}(\mathbf{f})/\mathfrak{S}$ of the analytic system. Moreover C_i is an analytic manifold.

Definition 4.2 (Component). *We call C_i a **component of $Z_{\mathbb{R}}(\mathbf{f})$** . If $Z_{\mathbb{R}}(\mathbf{f})$ is the zero set of the constraints of an analytic DAE, then C_i is called a **component of the constraints**.*

Consider a component C of $Z_{\mathbb{R}}(\mathbf{F}^{(c)})$ with a real point $\mathbf{p} \in \mathbb{R}^n$. Suppose $\text{rank} \mathcal{J}(\mathbf{p}) = r \leq n$. Without loss of generality, we assume that the sub-matrix $\mathcal{J}(\mathbf{p})[1 : r, 1 : r]$ has full rank.

Lemma 4.1 (Lemma 3.2 of [13]). *Let $Z_{\mathbb{R}}(\mathbf{F})$ be the zero set of a real analytic system, C be a component of $Z_{\mathbb{R}}(\mathbf{F})$ in \mathbb{R}^{m+n} of dimension m and let f be a real analytic function on \mathbb{R}^{m+n} . Then the intersection $C \cap Z_{\mathbb{R}}(f)$ is equal to C or has measure zero over C .*

Lemma 4.2 (Lemma 3.3 of [13]). *Let $Z_{\mathbb{R}}(\mathbf{F})$ be the zero set of a real analytic system, C be a component of $Z_{\mathbb{R}}(\mathbf{F})$. If $\mathcal{J}[1 : r, 1 : r]$ has full rank at some point \mathbf{p} on C , then it is non-singular almost everywhere on C .*

Corollary 4.1. *Let $Z_{\mathbb{R}}(\mathbf{F})$ be the zero set of a real analytic system, C be a component of $Z_{\mathbb{R}}(\mathbf{F})$. If Equation (8) or Equation (9) holds at an arbitrary point \mathbf{p} on C , then it holds almost everywhere of the whole component. And, if Equation (8) or Equation (9) doesn't hold at this point, then it is ∞ -smoothing or ∞ -integral over the whole component.*

PROOF. According to Proposition 4.1 and Proposition 4.2, since φ are real analytic, then Equation (8) and Equation (9) are real analytic. If Equation (8) or Equation (9) holds, then the functions on the left hand sides of their equations are nonzero, otherwise these functions have measure zero. The proof of this corollary can be easily completed in a similar manner to the proof of Lemma 4.2. \square

Corollary 4.1 yields Algorithm 1 for the detection method to construct a true signature matrix.

Algorithm 1 Construct Signature Matrix by Detection Method

```

1: procedure SIGMAT( $\mathbf{F}$ )
2:   Compute an initial point  $\mathbf{p}$  from one component.
3:   Set  $N := 10000$  ▷ maximum number of times.
4:   for  $1 \leq i \leq n$  do
5:     for  $1 \leq j \leq n$  do
6:       Compute  $[\sigma_{i,j}](\Phi)$  and  $\text{LD}(\varphi_i, x_j(s))$  by Equation (2).
7:       for  $k$  from 1 to  $N$ ,  $k := k + 1$  do
8:          $v_{i,j} := k$ .
9:         if Equation (8) holds at the initial point  $\mathbf{p}$  then
10:           Break.
11:         if  $k == N$  then
12:            $v_{i,j} := -\infty$ , break.
13:   Compute  $[\sigma_{i,j}](\Psi)$  by Equation (10).
14:   Compute  $[\sigma_{i,j}](\mathbf{F})$  by Equation (11).
15:   Return  $[\sigma_{i,j}](\mathbf{F})$ .
```

If one or more solutions of the constraints can be found, the correct signature matrix on the component for each solution can be determined by

the detection method. Actually, we can easily find a single solution to the constraints by root finding methods, e.g. Newton's method [32], SOR method [33], tensor methods [34, 35], etc.. Interval methods [36, 37] can find all points of the constraints if the scale and the interval is not too large. Homotopy methods [38, 39] also can help to find at least one point from each component if the constraints are polynomials.

5. Embedding Method for S-unamenable IDAES

There are some S-unamenable IDAES from applications, such as the IDAE of a PID controller [6]. The Σ -method may also fail by producing a singular Jacobian, while these cases may be solvable. In this section, we give an improved structural method to regularize S-unamenable IDAES which can erase the difficulties mentioned in section 2.

In a similar manner to [13], we divide such systems into two types: systems with **symbolic cancellation** (see Example 3.2) and systems with **numerical degeneration** (see Example 5.1).

Example 5.1. *Numerical Degeneration:*

Belt-drive systems and chain-drive systems, are important parts of mechanical transmission systems which are widely used in high-tech industries such as automobiles and high-speed railways [40]. In a similar manner to let-off and take-up systems [41], they not only implicitly require the coiling amount and the let-off amount to be equal in the whole process, but also implicitly require that their energies are equal which helps to improve fatigue strength and to avoid heating caused by deformation. Their dynamic simulation models can be described as follow:

$$\begin{cases} J_1 \cdot \dot{\Omega}_1(t) + J_2 \cdot \dot{\Omega}_2(t) + K \cdot \int_{t_0}^t (\Omega_1(s) - \Omega_2(s)) ds \\ \quad + B \cdot (\Omega_1(t) - \Omega_2(t)) - T_1(t) + T_2(t) = 0 \\ \int_{t_0}^t (J_1 \cdot (\Omega_1(s))^2 - J_2 \cdot (\Omega_2(s))^2) ds = 0 \end{cases}$$

$$\Rightarrow \mathcal{J} = \begin{pmatrix} J_1 & J_2 \\ 2 \cdot J_1 \cdot \Omega_1 & -2 \cdot J_2 \cdot \Omega_2 \end{pmatrix}$$

Here, J_1 and J_2 are moments of inertia of the wheels, K is a given constant of elasticity coefficient, B is a given constant damping coefficient, $T_1(t)$ and $T_2(t)$ are given torques, and $\Omega_1(t)$ and $\Omega_2(t)$ are angular velocities of

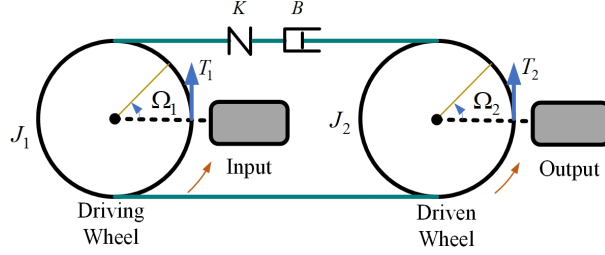

Figure 1: Belt-Drive System

the wheels, respectively. When the transmission ratio is equal, the moments of inertia of the driving wheel and the driven wheel are the same, that is $J_1 = J_2 = J$.

In this example, the determinant of the Jacobian matrix is $-2 \cdot J^2 \cdot (\Omega_1 + \Omega_2)$. Since $J \cdot ((\Omega_1)^2 - (\Omega_2)^2) = (\Omega_1 - \Omega_2) \cdot (\Omega_1 + \Omega_2) \cdot J$ in the constraints, two consistent initial points can be selected from the two different components, respectively. If the point is on the component $\Omega_1 - \Omega_2 = 0$, then the Σ -method works well. But for any initial point on the component $\Omega_1 + \Omega_2 = 0$, we always encounter a singular Jacobian, and we call this case numerical degeneration.

Especially, linear recombination or high multiplicity for an S-amenable IDAE may also lead to the singularity of the Jacobian matrix. The singularity caused by linear recombination belongs to the case of symbolic cancellation since the row vectors of the Jacobian matrix are linearly related. The singularity caused by high multiplicity belongs to the case of numerical degeneration since some constraints are ideals of the determinant of the Jacobian matrix.

Based on the definition of DOF in section 3.2, our scheme for improved structural methods for an IDAE can be described as: a scheme to construct a new IDAE \mathbf{G} , whose solution of \mathbf{x} is the same as IDAE \mathbf{F} and $0 \leq DOF(\mathbf{G}) < DOF(\mathbf{F})$.

If we have an initial point from a component of an IDAE, then according to Lemma 4.2, the rank of the Jacobian matrix is constant almost everywhere on this component. It can be calculated by singular value decomposition (SVD). Moreover, the Jacobians with constant rank enable us to embed the zero set into a higher dimensional space. Hence, the embedding method is proposed in [13] to construct a new DAE \mathbf{G} by decreasing the optimal value. But the embedding method for S-unamenable IDAEs is invalid due to

a negative optimal value which should be replaced by DOF.

5.1. Extension of the Embedding Method

Unlike other improved structural methods, the embedding method only replaces the variables of the top block.

Corollary 5.1. *The highest derivative of the top block \mathbf{X}^{k_d} has no integral element.*

PROOF. The variables of the top block $\mathbf{X}^{k_d} = \{x_1^{(d_1)}, \dots, x_n^{(d_n)}\}$. Since $\mathbf{d} = (d_1, \dots, d_n) \geq \mathbf{0}$ is a constraint of the optimization problem (3), \mathbf{X}^{k_d} is only related to \mathbf{x} and its derivatives. \square

Suppose $Z_{\mathbb{R}}(\mathbf{F}^{(c)})$ has constant rank i.e.

$$\text{rank}\mathcal{J} = r = \text{rank}\mathcal{J}[1:r, 1:r] < n \quad (13)$$

over a smooth component C of $Z_{\mathbb{R}}(\mathbf{F}^{(c-1)})$.

Suppose (\mathbf{c}, \mathbf{d}) is the optimal solution of Problem (3) for a given IDAE \mathbf{F} . Then differentiated IDAE $\mathbf{F}^{(c)} = \{\mathbf{B}_{k_c}, \mathbf{F}^{(c-1)}\}$ has constant rank $\text{rank}\mathcal{J} = r < n$. Let $\mathbf{s} = (x_1^{(d_1)}, \dots, x_r^{(d_r)})$, $\mathbf{y} = (x_{r+1}^{(d_{r+1})}, \dots, x_n^{(d_n)})$ and $\mathbf{z} = (t, \mathbf{X}, \mathbf{X}^{(1)}, \dots, \mathbf{X}^{(k_d-1)})$. Then $\mathbf{B}_{k_c} = \{\mathbf{f}(\mathbf{s}, \mathbf{y}, \mathbf{z}), \mathbf{g}(\mathbf{s}, \mathbf{y}, \mathbf{z})\}$, where $\mathbf{f}(\mathbf{s}, \mathbf{y}, \mathbf{z}) = \{F_1^{(c_1)}, \dots, F_r^{(c_r)}\}$ with full rank Jacobian and $\mathbf{g}(\mathbf{s}, \mathbf{y}, \mathbf{z}) = \{F_{r+1}^{(c_{r+1})}, \dots, F_n^{(c_n)}\}$. Then \mathbf{G} is constructed by the embedding method in Algorithm 2.

Most preferably, the initial values of the new variables \mathbf{u} can simply be taken as the initial values of their replaced variables \mathbf{s} . And $\boldsymbol{\xi}$ takes the same initial value as was assigned to \mathbf{y} .

Theorem 5.1. *Let (\mathbf{c}, \mathbf{d}) be the optimal solution of Problem (3) for a given IDAE \mathbf{F} . Let $\mathbf{F}^{(c)} = \{\mathbf{B}_{k_c}, \mathbf{F}^{(c-1)}\}$ as defined in Equation (6). If $\mathbf{F}^{(c)}$ satisfies (13), and C is a component of constraints, then*

$$Z_{\mathbb{R}}(\mathbf{F}^{(c)}) \cap C = \pi Z_{\mathbb{R}}(\mathbf{G}) \cap C$$

where $\mathbf{G} = \{\mathbf{F}^{aug}, \mathbf{F}^{(c-1)}\}$ as defined in Algorithm 2. Moreover, we have $\text{DOF}(\mathbf{G}) \leq \text{DOF}(\mathbf{F}) - (n - r)$.

PROOF. Just like the proof of Theorem 4.3 in [13], since $\mathbf{F}^{(c-1)}$ is common to both $\mathbf{F}^{(c)}$ and \mathbf{G} , we have $Z_{\mathbb{R}}(\mathbf{F}^{(c)}) \cap C = \pi Z_{\mathbb{R}}(\mathbf{G}) \cap C$.

Algorithm 2 The Embedding Method

- 1: **procedure** EMBEDDING
- 2: Introduce n new equations $\hat{\mathbf{F}}(\mathbf{s}, \mathbf{y}, \mathbf{z}) := \mathbf{B}_{k_c}$.
- 3: to replace \mathbf{s} in the top block $\hat{\mathbf{F}}$ by r new dependent variables $\mathbf{u} = (u_1, \dots, u_r)$ respectively.
- 4: to replace \mathbf{y} in the top block $\hat{\mathbf{F}}$ by $n - r$ random constants $\boldsymbol{\xi} = (\xi_1, \dots, \xi_{n-r})$ respectively.
- 5: Construct a new square subsystem

$$\mathbf{F}^{aug} := \{f(\mathbf{s}, \mathbf{y}, \mathbf{z}), \hat{\mathbf{F}}(\mathbf{u}, \boldsymbol{\xi}, \mathbf{z})\}. \quad (14)$$

▷ Where \mathbf{F}^{aug} has $n + r$ equations with $n + r$ leading variables $\{\mathbf{X}^{(k_d)}, \mathbf{u}\}$ and $\mathbf{X}^{(k_d)} = \{\mathbf{s}, \mathbf{y}\}$.

- 6: Construct $\mathbf{G} := \{\mathbf{F}^{aug}, \mathbf{F}^{(c-1)}\}$.
 - 7: Return \mathbf{G} .
-

We construct a pair $(\hat{\mathbf{c}}, \hat{\mathbf{d}})$, for $i = 1, \dots, n$, $\hat{c}_i = 0$ and for $j = 1, \dots, n$, $\hat{d}_j = d_j$. Since (\mathbf{c}, \mathbf{d}) is the optimal solution for \mathbf{F} , and \mathbf{B}_{k_c} is the top block of $\mathbf{F}^{(c)}$, it follows that $(\hat{\mathbf{c}}, \hat{\mathbf{d}})$ is the optimal solution for \mathbf{B}_{k_c} , and $\delta(\mathbf{B}_{k_c}) = \sum_j d_j$.

In the same manner of [13], we also construct a pair of feasible solutions $(\bar{\mathbf{c}}, \bar{\mathbf{d}})$ for \mathbf{F}^{aug} , which can help us to obtain $\delta(\mathbf{F}^{aug}) \leq \delta(\mathbf{B}_{k_c}) - (n - r)$. Where

$$\begin{aligned} \bar{c}_i &= \begin{cases} 0, & i = 1, \dots, r; \\ 1, & i = (r + 1), \dots, (n + r). \end{cases} \\ \bar{d}_j &= \begin{cases} d_j, & j = 1, \dots, n; \\ 1, & j = (n + 1), \dots, (n + r). \end{cases} \end{aligned} \quad (15)$$

According to Corollary 5.1, the replaced variables only occur in \mathbf{X}^{k_d} in the top block, thus \mathbf{F}^{aug} and \mathbf{B}_{k_c} have the same integration variables. By Proposition 3.1, such that $DOF(\mathbf{F}^{aug}) \leq DOF(\mathbf{B}_{k_c}) - (n - r)$.

Obviously, since both $\mathbf{F}^{(c)}$ and \mathbf{G} have the same block of constraints $\mathbf{F}^{(c-1)}$, according to Proposition 3.2, it follows that $DOF(\mathbf{G}) - DOF(\mathbf{F}^{(c)}) = DOF(\mathbf{F}^{aug}) - DOF(\mathbf{B}_{k_c}) \leq -(n - r)$. Finally, $DOF(\mathbf{G}) \leq DOF(\mathbf{F}^{(c)}) - (n - r) = DOF(\mathbf{F}) - (n - r)$, since $DOF(\mathbf{F}) = DOF(\mathbf{F}^{(c)})$ by Proposition 3.1. \square

Moreover, since the embedding method only replaces derivatives for $\mathbf{d} \geq \mathbf{0}$, the $\omega_{i,j}$ -integral of variables in \mathbf{F} is the same as the $\omega_{i,j}$ -integral of variables in \mathbf{G} .

Although there are more dependent variables in \mathbf{G} , the computational cost is much lower than explicit symbolic elimination, since \mathbf{G} and the corresponding lifted initial points can be easily constructed. Theoretically, Lemma 5.1 below shows that the feasible solution $(\bar{\mathbf{c}}, \bar{\mathbf{d}})$ is optimal under some reasonable assumptions.

Lemma 5.1. *Suppose each equation F_i in the top block \mathbf{B}_{k_c} of a IDAE \mathbf{F} contains at least one variable $x_j \in \mathbf{X}^{(k_d)-1}$. If \mathbf{F} is also a perfect match, then $(\bar{\mathbf{c}}, \bar{\mathbf{d}})$ in Equation (15) is an optimal solution, and $DOF(\mathbf{G}) = DOF(\mathbf{F}) - (n - r)$.*

This lemma is proved by contradiction. For more detail please see the proof of Lemma 4.4 in [13].

5.2. Examples

Example 5.2. *(Symbolic Cancellation) According to Example 3.2 and Example 3.3, this IDAE is a typical example of symbolic cancellation.*

Obviously, we still cannot solve the system directly after the Σ method. Fortunately, as shown in [16], the ES-method can successfully regularize it, while the LC-method fails.

Here, we apply the embedding method to this example. According to Algorithm 2, we have $\mathbf{s} = \{x_1\}, \mathbf{y} = \{x_2\}, \mathbf{f}(\mathbf{s}, \mathbf{y}, \mathbf{z}) = \{F_2^{(1)}\}, \mathbf{g}(\mathbf{s}, \mathbf{y}, \mathbf{z}) = \{F_1\}, \mathbf{F}^{(c-1)} = \{F_2\}$. Thus, $\bar{\mathbf{F}} = \{\mathbf{f}(\mathbf{u}, \boldsymbol{\xi}, \mathbf{z}), \mathbf{g}(\mathbf{u}, \boldsymbol{\xi}, \mathbf{z})\}$, where \mathbf{s} and \mathbf{y} are replaced by u and some random constants ξ respectively. Thus,

$$\mathbf{F}^{aug} = \begin{cases} x_1(t) + x_2(t) + \int_{t_0}^t x_1(s) \cdot x_2(s) ds - \dot{g}_2(t) \\ e^{-u(t)-\xi} - g_1(t) \\ u(t) + \xi + \int_{t_0}^t x_1(s) \cdot x_2(s) ds - \dot{g}_2(t) \end{cases}$$

After executing the embedding method, directly construct $\bar{\mathbf{c}} = (0, 1, 1)$ and $\bar{\mathbf{d}} = (0, 0, 1)$ by Lemma 5.1. Actually, it also is the optimal solution of AP by calculation. And the DOF of the new system \mathbf{G} is $\sum \bar{d}_j - \sum \bar{c}_i + \sum_j \max_i \omega_{i,j} - \#eqns(\mathbf{F}^{(c-1)}) = 1 - 2 + 4 - 1 = DOF(\mathbf{F}) - n + r = 3 - 2 + 1$, which is the same as the DOF after the ES-method.

Then we can verify that the determinant of the new Jacobian matrix is $(x_2 - x_1) \cdot e^{u-\xi}$, which is non-singular at t_0 if $x_1(t_0) - x_2(t_0) \neq 0$, which is the same result as in [16].

Example 5.3. (*Numerical Degeneration*) Consider the following IDAE with dependent variables $x(t)$ and $y(t)$:

$$\mathbf{F} = \left\{ 2y \frac{d^2x}{dt^2} - x \frac{d^2y}{dt^2} + 2x \left(\frac{dx}{dt} \right)^2 - \frac{dx}{dt} + \sin(t), \int_0^t (y(s) - x(s)^2) ds \right\}.$$

The exact solution of this IDAE is $x(t) = C - \cos(t)$ and $y(t) = x(t)^2$. Applying the structural method yields $\mathbf{c} = (0, 3)$ and $\mathbf{d} = (2, 2)$. Then $\mathbf{F}^{(e)} = [\{2yx_{tt} - xy_{tt} + 2xx_t^2 - x_t + \sin(t), y_{tt} - 2x_t^2 - 2xx_{tt}\}, \{-2xx_t + y_t\}, \{-x^2 + y\}, \{\int (-x^2 + y) ds\}]$, and the Jacobian matrix of the top block is $\mathcal{J} = \begin{pmatrix} 2y & -x \\ -2x & 1 \end{pmatrix}$.

Although the determinant of the Jacobian $2y - 2x^2$ is not identically zero, it must equal zero at any initial point since the determinant belongs to the ideal generated by the hidden constraints. Thus,

$$\mathbf{F}^{aug} = \begin{cases} 2y \frac{d^2x}{dt^2} - x \frac{d^2y}{dt^2} + 2x \left(\frac{dx}{dt} \right)^2 - \frac{dx}{dt} + \sin(t) = 0 \\ 2 \cdot u_1 \cdot y - \xi \cdot x + 2x \left(\frac{dx}{dt} \right)^2 - \frac{dx}{dt} + \sin(t) = 0 \\ \xi - 2 \cdot u_1 \cdot x - 2 \cdot \left(\frac{dx}{dt} \right)^2 = 0 \end{cases}$$

After the embedding method with $\mathbf{s} = \{\frac{d^2x}{dt^2}\}$, $\mathbf{y} = \{\frac{d^2y}{dt^2}\}$, $\mathbf{f}(\mathbf{s}, \mathbf{y}, \mathbf{z}) = \{F_1\}$, $\mathbf{g}(\mathbf{s}, \mathbf{y}, \mathbf{z}) = \{F_2^{(3)}\}$, $\bar{\mathbf{c}} = (0, 1, 1)$ and $\bar{\mathbf{d}} = (2, 2, 1)$, the new Jacobian matrix of \mathbf{F}^{aug} is

$$\mathcal{J} = \begin{pmatrix} 2y & -1 & 0 \\ 4x \cdot x_t - 1 & 0 & 2y \\ -4x_t & 0 & -2x \end{pmatrix}$$

It is obvious that the determinant of the new Jacobian matrix will not degenerate to a singular matrix by virtue of the constraints.

It should be noted that there is a redundant constraint in this example which will affect the DOF.

Example 5.4. (*Hybrid System*) Consider an S -amenable IDAE with exact solution $x_1(t) = 1 - 2t$ and $x_2(t) = 4t$:

$$\mathbf{F} = \begin{cases} F_1 : t x_1(t) + \int_0^t x_2(s) ds - t \\ F_2 : \int_0^t x_1(s) ds + t^2 - t \end{cases}$$

Whose signature matrix is

$$[\sigma_{i,j}](\mathbf{F}) = \begin{matrix} & & c_i \\ & \begin{pmatrix} 0 & -1 \\ -1 & -\infty \end{pmatrix} & \begin{matrix} 1 \\ 2 \end{matrix} \\ d_j & \begin{matrix} 1 & 0 \end{matrix} & \end{matrix}$$

and DOF is 0.

When linear recombination and high multiplicity occur in it such as $\bar{\mathbf{F}} = \{F_1^2, F_1 - F_2\}$, it turns out to be an S-unamenable IDAE.

By the Σ -method, the signature matrix

$$[\sigma_{i,j}](\bar{\mathbf{F}}) = \begin{matrix} & & c_i \\ & \begin{pmatrix} 0 & -1 \\ \mathbf{0} & -1 \end{pmatrix} & \begin{matrix} 1 \\ \mathbf{1} \end{matrix} \\ d_j & \begin{matrix} 1 & 0 \end{matrix} & \end{matrix}.$$

Here, DOF is 2 with 1 redundant constraint, and Jacobian matrix is $\mathcal{J} = \begin{pmatrix} 2 \cdot t \cdot F_1 & 2 \cdot F_1 \\ t & 1 \end{pmatrix}$ is identical zero, whose rank is 1.

In this example, we need to call the embedding method twice to find 2 hidden constraints. At the first call, $s = \{\frac{dx_1}{dt}\}$, $y = \{x_2\}$, $f(s, y, z) = \{\bar{F}_2'\}$, $g(s, y, z) = \{\bar{F}_1'\}$, $\bar{\mathbf{c}} = (0, 1, 1)$ and $\bar{\mathbf{d}} = (1, 0, 1)$. The Jacobian matrix of the new subsystem $\bar{\mathbf{F}}^{aug}$ is $\mathcal{J} = \begin{pmatrix} t & 1 & 0 \\ 2 \cdot t \cdot (\bar{F}_1'(u, \xi, z) + \bar{F}_1) & 2 \cdot \bar{F}_1'(u, \xi, z) & 2 \cdot t \cdot \bar{F}_1 \\ 0 & 0 & t \end{pmatrix}$, which implies that the new system has numerical degeneration. At the second call of the embedding method, $\mathbf{s} = \{\frac{dx_1}{dt}, \frac{du}{dt}\}$, $y = \{x_2\}$, $\mathbf{f}(\mathbf{s}, \mathbf{y}, \mathbf{z}) = \{\bar{F}_1^{aug}, \bar{F}_3^{aug}\}$, and $g(s, y, z) = \{\bar{F}_2^{aug}\}$. Finally, the Jacobian matrix is non-singular.

The above examples illustrate that the embedding method is a good choice for S-unamenable IDAEs including those with linear recombination and high multiplicity cases.

6. Global Numerical Solution of Two Stage Drive System

After structural analysis, a low-index IDAE can be obtained which can be decoupled into a system of regular Volterra integro differential equations (VIDE)s and a system of second-kind Volterra integral equations (VIE)s [7]. Generally, numerical solution methods for IDAEs can be summarized in terms

of two steps. The first step is to compute an initial value by VIEs, and the second step is to solve a VIDE using the initial value of the first step and to check whether the new solution conforms to VIEs. Most studies have focused on the second step. Some numerical iterative formats for some typical IDAE systems have been proposed. Implicit Runge-Kutta methods [42], collocation methods and collocation based methods [7, 43], implicit Euler methods and methods based on backward differentiation formulas [28, 44].

The global numerical method in [13] can be applied to IDAEs directly. In particular, Homotopy continuation methods or interval methods can help to find all initial points. Next, we will give an example to illustrate the global numerical method in [13].

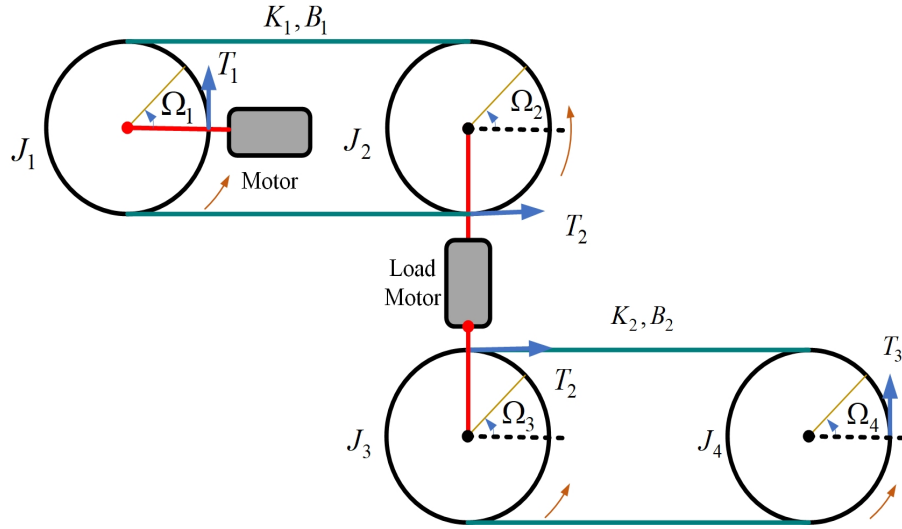

Figure 2: The Two Stage Drive System

The specific description of one stage driven system is given in Example 5.1. In applications, we can usually introduce a constant load in a series of one stage driven systems to achieve multi-stage transmission. When it comes to two stage drive system in Figure 2, it can be described as follows.

Assume moments of inertia $J_1 = J_2 = J_3 = J_4 = 1$, elastic coefficients $K_1 = K_2 = 1$, damping coefficients $B_1 = B_2 = 1$, and torques $T_1(t) = 2$, $T_2(t) = -\sin(t)$, $T_3(t) = 1$, respectively.

$$\begin{cases} \dot{\Omega}_1 + \dot{\Omega}_2 + \int_0^t (\Omega_1 - \Omega_2) ds + \Omega_1 - \Omega_2 + 2 - \sin(t) = 0 \\ \int_0^t ((\Omega_1)^2 - (\Omega_2)^2) ds = 0 \\ \dot{\Omega}_3 + \dot{\Omega}_4 + \int_0^t (\Omega_3 - \Omega_4) ds + \Omega_3(t) - \Omega_4(t) + \sin(t) - 1 = 0 \\ \int_0^t ((\Omega_3)^2 - ((\Omega_4)^2) ds = 0 \end{cases}$$

$$\Rightarrow \mathcal{J} = \begin{pmatrix} 1 & 1 & 0 & 0 \\ 2 \cdot \Omega_1 & -2 \cdot \Omega_2 & 0 & 0 \\ 0 & 0 & 1 & 1 \\ 0 & 0 & 2 \cdot \Omega_3 & -2 \cdot \Omega_4 \end{pmatrix}$$

Here, the two stage driven system is designed to be an equal transmission ratio system. It must be a numerically degenerate system with 4 components in Table 1.

By structural analysis, the dual optimal solutions is $\mathbf{c} = (0, 2, 0, 2)$ and $\mathbf{d} = (1, 1, 1, 1)$. In this example, there are two separate equation blocks that we can deal with them by applying the embedding method separately to reduce complexity. We also can construct the optimal solutions of the new system \mathbf{G} by Lemma 5.1.

Table 1: Components of Two Stage Driven System

	Components	rank \mathcal{J}	$\mathbf{f}(\mathbf{s}, \mathbf{y}, \mathbf{z})$	\mathbf{s}	Method
(a)	$\Omega_1 = \Omega_2, \Omega_3 = \Omega_4$	4			Σ
(b)	$\Omega_1 = -\Omega_2, \Omega_3 = \Omega_4$	3	F_2	$\dot{\Omega}_1$	embedding
(c)	$\Omega_1 = \Omega_2, \Omega_3 = -\Omega_4$	3	F_4	$\dot{\Omega}_3$	embedding
(d)	$\Omega_1 = -\Omega_2, \Omega_3 = -\Omega_4$	2	F_2, F_4	$\dot{\Omega}_1, \dot{\Omega}_3$	embedding

When $t \in [0, 5]$, four witness points from each component are computed by the Homotopy continuation method [45] where each point has coordinates $(\Omega_1, \Omega_2, \Omega_3, \Omega_4)$:

$$\begin{pmatrix} 0.21862079540 & 0.21862079540 & -0.87716795773 & -0.87716795773 \\ -1.00000000000 & 1.00000000000 & -0.87716795773 & -0.87716795773 \\ 0.21862079540 & 0.21862079540 & 0.50000000000 & -0.50000000000 \\ -1.00000000000 & 1.00000000000 & 0.50000000000 & -0.50000000000 \end{pmatrix}$$

These witness points are approximate points near the consistent initial value points, which need to be refined by Newton iteration. Finally, four numerical solutions from different components are shown in Figure 3.

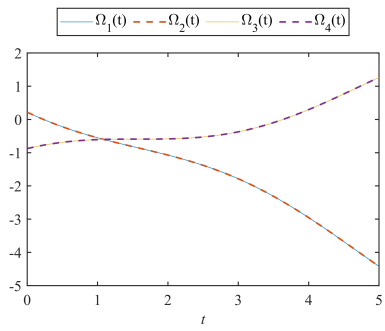

(a)

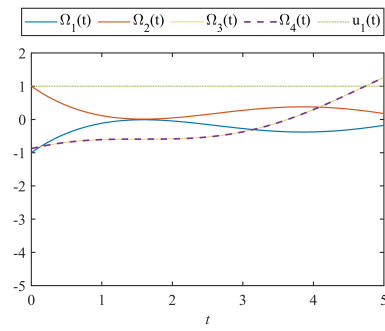

(b)

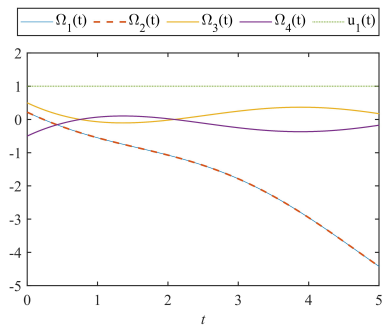

(c)

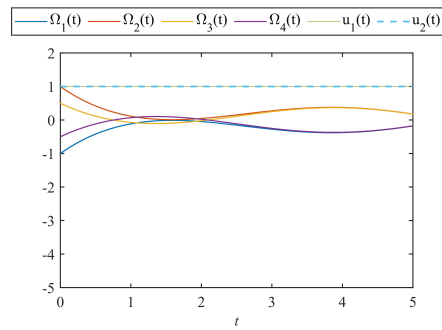

(d)

Figure 3: Global Numerical Solution of Two Stage Drive System

Further, we can reestablish an equivalent DAE system of this IDAE system with the angle as the variable, which can help us to obtain the exact solutions by symbolic computation.

$$\begin{aligned}
\Omega_1(t) &= +\Omega_2(t) = -\frac{1}{2} \cdot \cos(t) + C_1 \cdot t + C_2 \\
\Omega_1(t) &= -\Omega_2(t) = -\frac{1}{4} \cdot (\sin(t) + \cos(t)) + C_3 \cdot \exp(-t) \\
\Omega_3(t) &= +\Omega_4(t) = -\frac{1}{2} \cdot \cos(t) + C_4 \cdot t + C_5 \\
\Omega_3(t) &= -\Omega_4(t) = -\frac{1}{4} \cdot (\sin(t) + \cos(t)) + C_6 \cdot \exp(-t)
\end{aligned}$$

Here $C_1, C_2, C_3, C_4, C_5,$ and C_6 are constants depending on consistent initial conditions. These exact solutions can be used to check the correctness of our global numerical solution of the embedding method.

It should be noted that since the global numerical solution adopts the piecewise integration method, the constants ξ in the embedding method need to be reassigned along with the integration segment to ensure the consistency of the initial value and the correctness of the solution.

7. Integro-Partial-Differential-Algebraic Equations

In this section, we briefly generalize the Σ -method to IPDAEs based on the modified signature matrix.

Wu, Reid and Ilie [46] gave an approach for the class of so-called t -dominated (see Definition 7.2) PDAE. This approach can control the growth of differentiation due to only differentiation with respect to a single independent variable t . And it can avoid the expensive application of differential elimination methods which are poorly suited to systems with approximate coefficients.

The approach developed in this paper is an efficient way to identify the missing constraints for IDAEs under certain conditions. Just like the promotion of DAEs to IDAEs, we can now consider the class of t -dominated IPDAEs which involve $D_t^{-1} = \int_{t_0}^t$, with leading t structure dominated by t derivatives and expressions in D_t^{-1} , which allows the direct application of the previous methods of our paper.

For simplicity, we only consider the case of 2 independent variables (t, u) . The given system we assume to be written formally in terms of partial differential operators $D_t = \frac{\partial}{\partial t}$ and $D_u = \frac{\partial}{\partial u}$ so that it is a PDAE.

Consider a set of indeterminates $\Omega = \{v_\alpha^j | \alpha = (\alpha_1, \alpha_2) \in \mathbb{N}^2, j = 1, \dots, n\}$ where each member of Ω corresponds to a partial derivative by: $v_\alpha^j \leftrightarrow (D_t)^{\alpha_1} (D_u)^{\alpha_2} x_j(t, u)$. In a similar manner to [46], we let $\epsilon > 0$ be a positive symbolic parameter, and define a weight map $\tau : \Omega \rightarrow \mathbb{R}$ with respect to t by

$$\tau(v_\alpha^j) := \begin{cases} \alpha_1 & \text{if } \alpha_2 = 0, \\ \alpha_1 + \epsilon & \text{otherwise.} \end{cases}$$

Similarly to IDAE we can also split an IPDAE \mathbf{F} into two parts: Φ without integral terms and Ψ with integral terms. Then Definition 3.3 for the signature matrix of an IDAE can be generalized to IPDAE.

Definition 7.1 (Signature Matrix for IPDAE). *The $n \times n$ signature matrix $\sigma(\mathbf{F}) = [\sigma_{i,j}]_{1 \leq i \leq n, 1 \leq j \leq n}(\mathbf{F})$ of IPDAE \mathbf{F} of Equation (1) is defined as:*

$$[\sigma_{i,j}](\mathbf{F}) := \max_{i,j} ([\sigma_{i,j}](\Phi), [\sigma_{i,j}](\Psi))$$

Here, the definition of $[\sigma_{i,j}](\Phi)$ and $[\sigma_{i,j}](\Psi)$ is in the way of Definition 2.1 and Definition 3.3. In which, $x_j(t)$ and $x_j(s)$ should be replaced by $x_j(t, u)$ and $x_j(s, u)$, respectively; the order of $\text{LD}(\cdot, x_j(t))$ and the order of $\text{LD}(\cdot, x_j(s))$ should be replaced by $\tau(\text{LD}(\cdot, x_j(t, u)))$ and $\tau(\text{LD}(\cdot, x_j(s, u)))$, respectively.

Example 7.1. *Let an IPDAE $\mathbf{F} = \{\frac{\partial^2}{\partial t \partial u} x_1(t, u) + \int_{t_0}^t (s - t) \cdot \frac{\partial^2}{\partial t^2} x_1(t, u) \cdot x_2(s, u) ds = 0, \frac{\partial^2}{\partial u^2} x_2(t, u) + \int_{t_0}^t (\frac{\partial}{\partial s} x_1(s, u))^2 ds = 0\}$ with independent variables (t, u) and dependent variables $x_1(t, u)$ and $x_2(t, u)$.*

Thus, we can get the following two parts: $\Phi = \{\frac{\partial^2}{\partial t \partial u} x_1(t, u), \frac{\partial^2}{\partial u^2} x_2(t, u)\}$, $\Psi = \{\int_{t_0}^t (s - t) \cdot \frac{\partial^2}{\partial t^2} x_1(t, u) \cdot x_2(s, u) ds, \int_{t_0}^t (\frac{\partial}{\partial s} x_1(s, u))^2 ds\}$

By Definition 2.1 and Definition 3.3, the 2×2 signature matrix (with respect to t) of each parts are: $[\sigma_{i,j}](\Phi) = \begin{pmatrix} 1 + \epsilon & -\infty \\ -\infty & \epsilon \end{pmatrix}$ and $[\sigma_{i,j}](\Psi) =$

$$\begin{pmatrix} \max(2, -\infty) & -2 \\ \epsilon - 1 & 0 \end{pmatrix}.$$

By Definition 7.1, the 2×2 signature matrix (with respect to t) of this IPDAE is: $[\sigma_{i,j}](\mathbf{F}) = \begin{pmatrix} 2 & -2 \\ \epsilon - 1 & \epsilon \end{pmatrix}$.

As in [46], t -dominated PDAE is dominated by pure derivatives in the independent variable t . And a pure derivative of dependent variable x_j to the independent variable t is a derivative form $(\frac{\partial}{\partial t})^k x_j(t, u)$ where $k \in \mathbb{N}$.

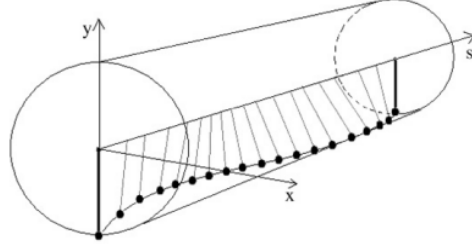

Figure 4: Pendulum Curtain

Definition 7.2. We say an IPDAE \mathbf{F} is dominated by pure derivatives in the independent variable t if there is no ϵ appearing in $[\sigma_{i,j}](\mathbf{F})$.

Example 7.2. Consider the Example 7.1, by Definition 7.2, we can say the first equation F_1 is t -dominated, and the second equation F_2 is not t -dominated since there is ϵ in its signature matrix.

For example, consider a curtain made of many pendula hanging under gravity g given by Wu, Reid and Ilie [46]. As shown in Fig. 4 the pendula are restricted to move on the surface of the cylinder and in planes perpendicular to the s -axis displayed. The pendula form a continuous curtain in the limit. For small deviations from the vertical equilibrium position the equations for $x(t, s)$, $y(t, s)$ and Lagrange multiplier $\lambda(t, s)$ for the continuous curtain satisfy

$$\frac{\partial^2 x}{\partial t^2} + \lambda x = \kappa \frac{\partial^2 x}{\partial s^2}, \quad \frac{\partial^2 y}{\partial t^2} + \lambda y + g = \kappa \frac{\partial^2 y}{\partial s^2}, \quad x^2 + y^2 = 1.$$

Pishbin's paper [8] contains interesting theoretical and computational discussions of DAE and IAE. In a manner to the pendulum example in [8], the PDAE for the pendulum curtain can be easily converted to an IPDAE by integrating:

$$\mathbf{F} = \left\{ \begin{array}{l} \frac{\partial x}{\partial t} - \frac{\partial x}{\partial t} \Big|_{t=t_0} + \int_{t_0}^t \lambda x dt = \int_{t_0}^t \kappa \frac{\partial^2 x}{\partial s^2} dt, \\ \frac{\partial y}{\partial t} - \frac{\partial y}{\partial t} \Big|_{t=t_0} + \int_{t_0}^t \lambda y dt + g = \int_{t_0}^t \kappa \frac{\partial^2 y}{\partial s^2} dt, \\ \int_{t_0}^t (x^2 + y^2 - 1) dt = 0. \end{array} \right\}$$

The key idea is to select an independent variable and ranking of derivatives in which the derivatives are highest in the ranking. In this example, the ranking for each dependent variables, e.g. x , should satisfy $x \prec \frac{\partial x}{\partial s} \prec \frac{\partial^2 x}{\partial s^2} \prec \dots \prec \frac{\partial x}{\partial t} \prec \frac{\partial^2 x}{\partial t \partial s} \prec \dots$. This system is t -dominated and a generalization of the Σ -method applies.

Finally, we can get its signature matrix of this IPDAE as:

$$[\sigma_{i,j}](\mathbf{F}) = \begin{pmatrix} 1 & -\infty & -1 \\ -\infty & 1 & -1 \\ -1 & -1 & -\infty \end{pmatrix}.$$

By Definition 7.2, \mathbf{F} is t -dominated.

In the manner to PDAEs, we can apply the Σ -method to this t -dominated system directly, and get $\mathbf{c} = (1, 1, 3)$, $\mathbf{d} = (2, 2, 0)$. Then, we can easily yield the t -differentiation of this IPDAE: $\mathbf{F}^{(\mathbf{c})} = \{ \{ \frac{\partial^2 x}{\partial t^2} + \lambda x = \kappa \frac{\partial^2 x}{\partial s^2}, \frac{\partial^2 y}{\partial t^2} + \lambda y + g = \kappa \frac{\partial^2 y}{\partial s^2}, x \frac{\partial^2 x}{\partial t^2} + y \frac{\partial^2 y}{\partial t^2} + (\frac{\partial x}{\partial t})^2 + (\frac{\partial y}{\partial t})^2 = 0 \}, \{ \frac{\partial x}{\partial t} - \frac{\partial x}{\partial t} \Big|_{t=t_0} + \int_{t_0}^t \lambda x dt = \int_{t_0}^t \kappa \frac{\partial^2 x}{\partial s^2} dt, \frac{\partial y}{\partial t} - \frac{\partial y}{\partial t} \Big|_{t=t_0} + \int_{t_0}^t \lambda y dt + g = \int_{t_0}^t \kappa \frac{\partial^2 y}{\partial s^2} dt, x \frac{\partial x}{\partial t} + y \frac{\partial y}{\partial t} = 0 \}, \{ x^2 + y^2 = 1 \}, \{ \int_{t_0}^t (x^2 + y^2 - 1) dt = 0 \} \}$.

Obviously, the Jacobian matrix of top block is

$$\mathcal{J} = \begin{pmatrix} 1 & 0 & x \\ 0 & 1 & y \\ x & y & 0 \end{pmatrix},$$

whose determinant is $x^2 + y^2$ is non-singular satisfying its constraints.

Due to there is no integral item in the top block of the differentiation system $\mathbf{F}^{(\mathbf{c})}$, the top block of $\mathbf{F}^{(\mathbf{c})}$ is a typical PDAE. By the Theorem 7.3 of [46], since the Jacobian matrix of top block of $\mathbf{F}^{(\mathbf{c})}$ is non-singular, the top block can be transformed into a DAE system via the numerical method of lines [46] and the Jacobian matrix of this DAE is non-singular too. That's to say we can numerically solve this example after numerical discretization.

However, this example is only of constant coefficient. Considering the length of this paper, numerical solution based on our approach in this paper for a general IPDAE is our future work.

8. Conclusions

There are many obstacles to the structural analysis by the Σ -method for IDAEs. To clear it, we redefine the signature matrix, so that it can deal with general forms of IDAEs.

However, the Σ -method may fail due to overestimating some elements in signature matrix including incorrect signature matrix cases and S-unamenable cases. To correct the signature matrix, we give an efficient detection method by points that also helps to calculate the rank of the Jacobian. To regularize S-unamenable IDAEs, we remedy the condition of convergence and termination of the embedding method with a new definition of the DOF for IDAEs. The embedding method for an IDAE avoids direct elimination by introducing new variables and equations to increase the dimensions of space in which the IDAE resides. Under certain conditions, it avoids solving assignment problems for the new systems. The superiority of the embedding method has been illustrated with examples.

For initial points, we can traverse all components by the Homotopy methods and interval methods. Combined with the embedding method, the global numerical method can find all numerical solutions of IDAEs. We give an example of two stage drive system to demonstrate the method.

As shown in example of pendulum curtain, it is promising that modified signature matrix can help to transform an IPDAE system into an IDAE system. A general numerical solution method for IPDAEs is our future work.

Acknowledgements. This work is partially supported by the projects of Chongqing (2020000036, 2021000263, cstc2020yszx-jcyjX0005, Chongqing Talents - Wenyuan Wu), and special research assistant program of CAS.

References

- [1] Y. Jiang, O. Wing, Waveform Relaxation of Linear Integral-differential Equations for Circuit Simulation, Proceedings of the ASP-DAC '99 Asia and South Pacific Design Automation Conference 1999 (Cat. No.99EX198) 1 (1999) 61–64. doi:10.1109/ASPAC.1999.759710.
- [2] A. Nassirharand, A New Technique for Solving Sets of Coupled Nonlinear Algebraic and Integro-Differential Equations Encountered in Hydraulics, Int. J. Contemp. Math. Sciences 3 (2008) 1611–1617.
- [3] V. Kafarov, B. Mayorga, C. G. Dallos, Mathematical Method for Analysis of Dynamic Processes in Chemical Reactors, Chemical Engineering Science 54 (1999) 4669–4678.
- [4] B. Jumarhon, W. Lamb, S. McKee, T. Tang, A Volterra Integral Type Method for Solving A Class of Nonlinear Initial-boundary Value

- Problems, Numerical Methods for Partial Differential Equations 12 (1996) 265–281.
- [5] R. Dorf, R. Bishop, Modern Control Systems, 12th Edition, Prentice Hall, 2010.
- [6] A. Visioli, Modified Anti-windup Scheme for PID Controllers, IEE Proceedings - Control Theory and Applications 150 (2003) 49–54(5). URL: https://digital-library.theiet.org/content/journals/10.1049/ip-cta_20020769. doi:10.1049/ip-cta:20020769.
- [7] H. Liang, H. Brunner, Collocation Methods for Integro-differential Algebraic Equations with Index 1, IMA Journal of Numerical Analysis 40 (2019) 850–885. URL: <https://doi.org/10.1093/imanum/drz010>. doi:10.1093/imanum/drz010.
- [8] S. Pishbin, Optimal Convergence Results of Piecewise Polynomial Collocation Solutions for Integral–algebraic Equations of Index-3, Journal of Computational and Applied Mathematics 279 (2015) 209–224. URL: <https://www.sciencedirect.com/science/article/pii/S037704271400483X>. doi:<https://doi.org/10.1016/j.cam.2014.11.012>.
- [9] L. Shampine, Solving $0=f(t,y(t),y'(t))$ in Matlab, Journal of Numerical Mathematics 10 (2002) 291–310. URL: <https://doi.org/10.1515/JNMA.2002.291>. doi:10.1515/JNMA.2002.291.
- [10] R. Vieira, E. Biscaia, Direct Methods for Consistent Initialization of DAE Systems, Computers and Chemical Engineering 25 (2001) 1299–1311. URL: <https://www.sciencedirect.com/science/article/pii/S0098135401007025>. doi:10.1016/S0098-1354(01)00702-5.
- [11] P. N. Brown, A. C. Hindmarsh, L. R. Petzold, Consistent initial condition calculation for differential-algebraic systems, SIAM Journal on Scientific Computing 19 (1998) 1495–1512. URL: <https://doi.org/10.1137/S1064827595289996>. doi:10.1137/S1064827595289996.
- [12] B. Leimkuhler, L. R. Petzold, C. W. Gear, Approximation Methods for the Consistent Initialization of Differential-Algebraic Equations, SIAM

- Journal on Numerical Analysis 28 (1991) 205–226. URL: <https://doi.org/10.1137/0728011>. doi:10.1137/0728011.
- [13] W. Yang, W. Wu, G. Reid, Index Reduction for Degenerated Differential-Algebraic Equations by Embedding, arXiv e-prints (2022) arXiv:2210.16707. arXiv:2210.16707.
- [14] C. W. Gear, Differential Algebraic Equations, Indices, and Integral Algebraic Equations, SIAM Journal on Numerical Analysis 27 (1990) 1527–1534. URL: <https://doi.org/10.1137/0727089>. doi:10.1137/0727089. arXiv:<https://doi.org/10.1137/0727089>.
- [15] H. Liang, H. Brunner, Integral-Algebraic Equations: Theory of Collocation Methods I, SIAM Journal on Numerical Analysis 51 (2013) 2238–2259. URL: <https://doi.org/10.1137/120894567>. doi:10.1137/120894567. arXiv:<https://doi.org/10.1137/120894567>.
- [16] R. Zolfaghari, J. Taylor, R. J. Spiteri, Structural Analysis of Integro-differential-algebraic Equations, Journal of Computational and Applied Mathematics 394 (2021) 113568. URL: <https://www.sciencedirect.com/science/article/pii/S0377042721001886>. doi:<https://doi.org/10.1016/j.cam.2021.113568>.
- [17] C. W. Gear, Differential-Algebraic Equation Index Transformations, SIAM Journal on Scientific and Statistical Computing 9 (1988) 39–47. URL: <https://doi.org/10.1137/0909004>. doi:10.1137/0909004.
- [18] J. D. Pryce, A Simple Structural Analysis Method for DAEs, BIT Numerical Mathematics 41 (2001) 364–394. URL: <https://doi.org/10.1023/A:1021998624799>. doi:10.1023/A:1021998624799.
- [19] P. K. Lamm, A Survey of Regularization Methods for First-Kind Volterra Equations, in: SURVEYS ON SOLUTION METHODS FOR INVERSE PROBLEMS, Springer, Vienna, 2000, pp. 53–82. URL: https://doi.org/10.1007/978-3-7091-6296-5_4. doi:10.1007/978-3-7091-6296-5_4.
- [20] R. Zolfaghari, N. S. Nedialkov, Structural analysis of linear integral-algebraic equations, Journal of Computational and Applied Mathematics 353 (2019) 243–252. URL: <https://www>.

sciencedirect.com/science/article/pii/S037704271830774X.
doi:<https://doi.org/10.1016/j.cam.2018.12.043>.

- [21] M. Gerdt, Optimal Control of ODEs and DAEs, De Gruyter, 2011. URL: <https://doi.org/10.1515/9783110249996>. doi:10.1515/9783110249996.
- [22] S. Iwata, Computing the Maximum Degree of Minors in Matrix Pencils via Combinatorial Relaxation, *Algorithmica* 36 (2003) 331–341. URL: <https://doi.org/10.1007/s00453-003-1022-9>. doi:10.1007/s00453-003-1022-9.
- [23] K. Murota, Computing the Degree of Determinants via Combinatorial Relaxation, *SIAM J. Comput.* 24 (1995) 765–796. URL: <https://doi.org/10.1137/S0097539791201897>. doi:10.1137/S0097539791201897.
- [24] S. L. Campbell, Least Squares Completions for Nonlinear Differential Algebraic Equations, *Numer. Math.* 65 (1993) 77–94. URL: <https://doi.org/10.1007/BF01385741>. doi:10.1007/BF01385741.
- [25] X. Wu, Y. Zeng, J. Cao, The Application of the Combinatorial Relaxation Theory on the Structural Index Reduction of DAE, in: 2013 12th International Symposium on Distributed Computing and Applications to Business, Engineering Science, 2013, pp. 162–166. doi:10.1109/DCABES.2013.36.
- [26] G. Tan, N. Nedialkov, J. Pryce, Conversion Methods for Improving Structural Analysis of Differential-Algebraic Equation Systems, *BIT Numerical Mathematics* 57 (2017) 845–865. URL: <https://doi.org/10.1007/s10543-017-0655-z>. doi:10.1007/s10543-017-0655-z.
- [27] T. Oki, Improved Structural Methods for Nonlinear Differential-Algebraic Equations via Combinatorial Relaxation†, *IMA Journal of Numerical Analysis* 43 (2021) 357–386. URL: <https://doi.org/10.1093/imanum/drab094>. doi:10.1093/imanum/drab094.
- [28] M. Bulatov, E. Chistyakova, On A Family of Singular Integro-differential Equations, *Computational Mathematics and Mathematical Physics* 51 (2011) 1558–1566. URL: <https://doi.org/10.1134/S0965542511090065>. doi:10.1134/S0965542511090065.

- [29] K. O. Geddes, S. R. Czapor, G. Labahn, Algorithms for Computer Algebra, Springer US, Boston, MA, 1992, pp. 429–471. URL: https://doi.org/10.1007/978-0-585-33247-5_10. doi:10.1007/978-0-585-33247-5_10.
- [30] G. E. Buchberger, B. Collins, R. Loos, Computer Algebra: Symbolic and Algebraic Computation, Springer-Verlag Vienna, Vienna, 1982. URL: <https://doi.org/10.1007/978-3-7091-3406-1>. doi:10.1007/978-3-7091-3406-1.
- [31] S. G. Krantz, H. R. Parks, Some Questions of Hard Analysis, Birkhäuser Boston, Boston, MA, 2002. URL: https://doi.org/10.1007/978-0-8176-8134-0_4. doi:10.1007/978-0-8176-8134-0_4.
- [32] J. E. Dennis, R. B. Schnabel, Numerical Methods for Unconstrained Optimization and Nonlinear Equations, Society for Industrial and Applied Mathematics, 1996. URL: <https://epubs.siam.org/doi/abs/10.1137/1.9781611971200>. doi:10.1137/1.9781611971200. arXiv:<https://epubs.siam.org/doi/pdf/10.1137/1.9781611971200>.
- [33] J. M. Ortega, W. C. Rheinboldt, Iterative Solution of Nonlinear Equations in Several Variables, Society for Industrial and Applied Mathematics, 2000. URL: <https://epubs.siam.org/doi/abs/10.1137/1.9780898719468>. doi:10.1137/1.9780898719468. arXiv:<https://epubs.siam.org/doi/pdf/10.1137/1.9780898719468>.
- [34] R. B. Schnabel, P. D. Frank, Tensor Methods for Nonlinear Equations, SIAM Journal on Numerical Analysis 21 (1984) 815–843. URL: <https://doi.org/10.1137/0721054>. doi:10.1137/0721054. arXiv:<https://doi.org/10.1137/0721054>.
- [35] B. W. Bader, Tensor-Krylov Methods for Solving Large-Scale Systems of Nonlinear Equations, SIAM Journal on Numerical Analysis 43 (2005) 1321–1347. URL: <https://doi.org/10.1137/040607095>. doi:10.1137/040607095. arXiv:<https://doi.org/10.1137/040607095>.
- [36] P. Van Hentenryck, D. McAllester, D. Kapur, Solving Polynomial Systems Using a Branch and Prune Approach, SIAM Journal on Numerical Analysis 34 (1997) 797–827. URL: <https://doi.org/10.1137/970709797>.

org/10.1137/S0036142995281504. doi:10.1137/S0036142995281504.
arXiv:<https://doi.org/10.1137/S0036142995281504>.

- [37] L. Granvilliers, F. Benhamou, Algorithm 852: RealPaver: An Interval Solver Using Constraint Satisfaction Techniques, *ACM Trans. Math. Softw.* 32 (2006) 138–156. URL: <https://doi.org/10.1145/1132973.1132980>. doi:10.1145/1132973.1132980.
- [38] D. J. Bates, A. J. Sommese, J. D. Hauenstein, C. W. Wampler, Numerically Solving Polynomial Systems with Bertini, Society for Industrial and Applied Mathematics, Philadelphia, PA, 2013. URL: <https://epubs.siam.org/doi/abs/10.1137/1.9781611972702>. doi:10.1137/1.9781611972702. arXiv:<https://epubs.siam.org/doi/pdf/10.1137/1.9781611972702>.
- [39] A. Sommese, C. Wampler, The Numerical Solution of Systems of Polynomials Arising in Engineering and Science, 2005. doi:10.1142/5763.
- [40] K. Zhang, J. Yang, C. Liu, J. Wang, D. Yao, Dynamic Characteristics of a Traction Drive System in High-Speed Train Based on Electromechanical Coupling Modeling under Variable Conditions, *Energies* 15 (2022). URL: <https://www.mdpi.com/1996-1073/15/3/1202>. doi:10.3390/en15031202.
- [41] W. Yang, Technology of Analyzing and Controlling Dynamical Warp Yarn Tension of High-speed Loom, Master's thesis, Donghua University, 2013.
- [42] J.-P. Kauthen, Implicit Runge-Kutta methods for some integrodifferential-algebraic equations, *Applied Numerical Mathematics* 13 (1993) 125–134. URL: <https://www.sciencedirect.com/science/article/pii/016892749390136F>. doi:[https://doi.org/10.1016/0168-9274\(93\)90136-F](https://doi.org/10.1016/0168-9274(93)90136-F).
- [43] H. Brunner, Collocation Methods for Volterra Integral and Related Functional Differential Equations, Cambridge Monographs on Applied and Computational Mathematics, Cambridge University Press, 2004. doi:10.1017/CB09780511543234.

- [44] M. Bulatov, E. Chistyakova, Numerical Solution of Integro-differential Systems with A Degenerate Matrix Multiplying the Derivative by Multistep Methods, *Differential Equations* 42 (2006) 1317–1325. doi:10.1134/S0012266106090102.
- [45] Y. Wang, W. Wu, B. Xia, A Special Homotopy Continuation Method for a Class of Polynomial Systems, in: V. P. Gerdt, W. Koepf, W. M. Seiler, E. V. Vorozhtsov (Eds.), *Computer Algebra in Scientific Computing*, Springer International Publishing, Cham, 2017, pp. 362–376. URL: https://doi.org/10.1007/978-3-319-66320-3_26. doi:10.1007/978-3-319-66320-3_26.
- [46] W. Wu, G. Reid, S. Ilie, Implicit riquier bases for pdae and their semi-discretizations, *Journal of Symbolic Computation* 44 (2009) 923–941. URL: <https://www.sciencedirect.com/science/article/pii/S0747717108001302>. doi:<https://doi.org/10.1016/j.jsc.2008.04.020>, international Symposium on Symbolic and Algebraic Computation.