

Developing a highly sensitive ^{222}Rn concentration measurement system for the water Cherenkov detector of Jiangmen Underground Neutrino Observatory

Y. Liu^a, Y.P. Zhang^{b,c,d}, J.C. Liu^{b,c,d}, C. Guo^{b,c,d*}, C.G. Yang^{b,c,d},
P. Zhang^{b,c,d}, Q. Tang^{a†}, Z.F. Xu^a, C. Li^a, T.Y. Guan^a, S.B. Wang^b

^a*School of Nuclear Science and Technology, University of South China, Hengyang, China*

^b*Experimental Physics Division, Institute of High Energy Physics, Chinese Academy of Sciences, Beijing, China*

^c*School of Physics, University of Chinese Academy of Sciences, Beijing, China*

^d*State Key Laboratory of Particle Detection and Electronics, Beijing, China*

Abstract

The Jiangmen Underground Neutrino Observatory (JUNO), a 20 kton multipurpose underground liquid scintillator detector, was proposed for the determination of the neutrino mass hierarchy as primary physics goal. The central detector will be submerged in a water Cherenkov detector to lower the background from the environment and cosmic muons. Radon is one of the primary background sources. Nitrogen will be used in several sub-systems, and a highly sensitive radon detector has to be developed to measure its radon concentration. A system has been developed based on ^{222}Rn enrichment of activated carbon and ^{222}Rn detection of the electrostatic collection. This paper presents the detail of a $\mu\text{Bq}/\text{m}^3$ ^{222}Rn concentration measurement system and gives detailed information about how the adsorption coefficient was measured and how the temperature, flow rate, and ^{222}Rn concentration affect the adsorption coefficient.

Keywords: Radon, Activated carbon, Adsorption coefficient, Low temperature

*Corresponding author. Tel: +86-1088236256. E-mail address: guocong@ihep.ac.cn (C. Guo).

†Corresponding author. Tel: +86-1088236095. E-mail address: tangquan528@sina.com (Q. Tang).

1. Introduction

The Jiangmen Underground Neutrino Observatory (JUNO) is a multipurpose neutrino experiment designed to determine the neutrino mass hierarchy and precisely measure the oscillation parameters by detecting reactor anti-neutrinos from the Yangjiang and Taishan Nuclear Power Plants with a 20 kton liquid scintillator (LS) detector located 700-m underground [1, 2]. The natural radioactive gas radon (^{222}Rn), soluble in water and LS, is one of JUNO's most crucial background sources.

Nitrogen is used in several sub-systems of JUNO; for example, nitrogen with a radon concentration of $\sim 30 \mu\text{Bq}/\text{m}^3$ will be used in the gas stripping equipment to remove the radio-active gas dissolved in LS [3], and nitrogen with a radon concentration of $\sim 1 \text{ mBq}/\text{m}^3$ will be used in the ultra-pure water system to produce low radon ultra-pure water [2, 4]. The residual radon in nitrogen, which will introduce extra background to the detector, should be measured before use. Thus it is necessary to develop a highly sensitive radon concentration measurement system.

In Our previous work [5], we measured the background of Saratech activated carbon and verified its radon adsorption performance. In this work, we investigated its optimal working conditions and applied it to the highly sensitive radon concentration measurement. This paper is organized as follows. Section 2 describes the update of the measurement system. Section 3 describes how the adsorption coefficient of activated carbon is measured. Section 4 presents how the temperature, the gas flow rate, and the radon concentration in the gas affect the adsorption coefficient. Section 5 gives the ^{222}Rn concentration measurement sensitivity of the system, section 6 is several discussions about the system and section 7 gives the conclusion and future prospects.

2. Experimental principle and setup

In the highly sensitive ^{222}Rn concentration measurement system, the authors first use low-temperature activated carbon to enrich the radon gas [6, 7], and then use a radon detector [8–11] to measure the radon concentration of the enriched gas. Activated carbon is an excellent adsorbent with a strong adsorption capacity for radon and has been widely used for radon removal in

low background experiments [12–14]. The adsorption capacity of activated carbon working at low temperatures to radon gas is significantly enhanced and it has been confirmed by many researchers [12, 14–17] and our previous work [5]. Based on the earlier results, the Saratech activated carbon [18] is used in this work because of its excellent radon adsorption capability and low radioactive background.

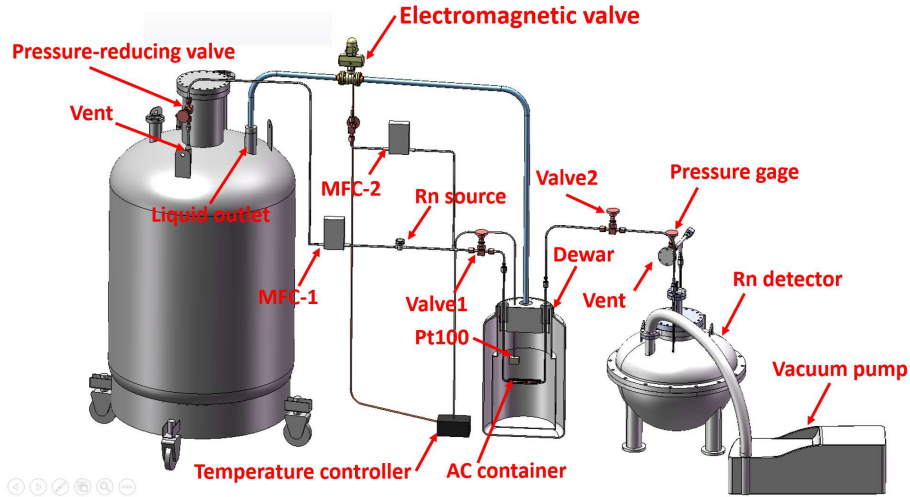

Figure 1: Schematic system diagram, which consists of a high-pressure nitrogen tank, a gas flow control system, a gas flow radon source, an activated carbon container, a temperature control system, a vacuum pump, and a radon detector.

Fig. 1 shows the schematic of the system, which is updated from our previous work [5]. Based on the measurement requirements of this project, the following improvements have been made:

(A) A liquid nitrogen tank with an internal pressure of 12 bar is used to obtain a higher gas flow rate.

(B) Two gas mass flow controllers (MFC, 1179A, MKS Instruments, Inc.) are used, one of which is used to control the gas flow rate through the radon source to obtain different concentrations of radon-containing gas, and the other is used to control the gas flow rate through the activated carbon.

(C) A heating belt made of silicone rubber is used in the temperature control system to heat the activated carbon to $200\text{ }^{\circ}\text{C}$ while radon desorption.

(D) A vacuum pump (ACP40, Pfeiffer) is used to evacuate the detector to obtain a lower detector background.

(E) A pressure gauge (ISE80-A2-N-M, SMC corporation) is connected to the radon detector to monitor the internal pressure.

(F) The radon detector's electronics readout system has been upgraded to reduce the cost. The updated circuit diagram is shown in Fig. 2. A power module (CRF-0508, Tianjin Centre Advanced Tech. Co. Ltd) is used to supply -700 V high voltage, and a DC power supply (DP 831A, Rigol) is used to provide power to the power module. A CR-110 pre-amplifier (Cremat. Inc.) and a CR-200 Gaussian shaping amplifier (Cremat. Inc.) are used to amplify and shape the signal.

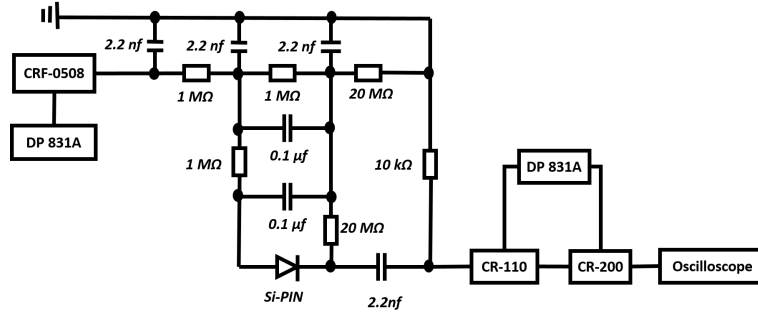

Figure 2: The circuit diagram of the readout system. DP 831A is a DC power supply made by Rigol company, CRF-0508 is a power module made by Tianjin Centre Advanced Technology Company, and CR-110 and CR-200 are pre-amplifier and shaping amplifier made by Cremat company. CRF-0508 converts an input voltage of 12 V to an output voltage of -700 V.

3. Adsorption coefficient measurement

Activated carbon is widely used in low-background experiments for radon removal. The radon adsorption coefficient of activated carbon is used to quantify its radon adsorption capability. Fig. 3 shows the relevant branches of ^{222}Rn decay chain and the radon concentration is determined by detecting the α s from ^{218}Po and ^{214}Po decay. The left of Fig. 4 shows example pulses of ^{218}Po and ^{214}Po and the right of Fig. 4 shows an energy spectrum of a ^{222}Rn source. The detail of the detector and the detecting principle can be found in Ref. [5, 19, 20].

The adsorption coefficient is calculated with the ^{222}Rn breakthrough curve, which is measured as follows:

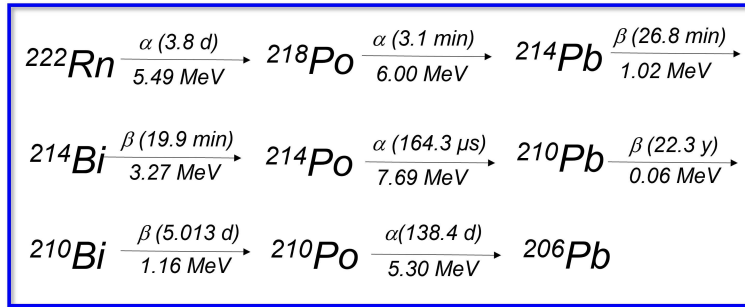

Figure 3: The relevant branches of ^{222}Rn decay chain. The half-lives of the nuclide are in parentheses. The α decay energy or the maximum β decay energy are indicated below the arrow.

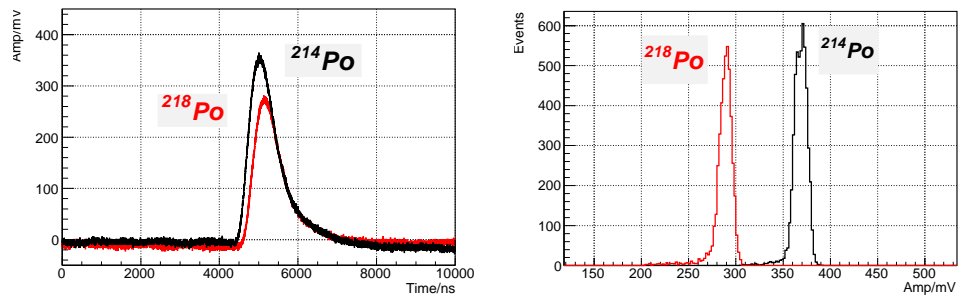

Figure 4: Left: Examples of signal pulse. Right: An energy spectrum of ^{222}Rn source.

(A) Turn on the temperature control system to heat the activated carbon to 200°C and purge the system with evaporative nitrogen for 2 hours.

(B) Vacuum the system to -101 kPa.

(C) Cool the activated carbon to a specified temperature with the temperature control system.

(D) Open the relevant valves and use the MFCs to control the gas passing through the activated carbon to a specified flow rate.

(E) Open the outlet valve of the radon detector after its relative internal pressure is larger than 10 kPa.

(F) Monitor the radon concentration inside the detector until it reaches equilibrium.

As is shown in Fig. 3, the half-life of ^{218}Po is only 3.1 min, it can reach dynamic equilibrium quickly, so the ^{218}Po counting rate is used to characterize the ^{222}Rn concentration inside the detector.

In this work, 0.73 g activated carbon is used. Fig. 5 is an example of the ^{222}Rn breakthrough curve measured at -80 °C. The radon concentration in the gas is 160 ± 16 mBq/m³, and the gas flow rate is 4 L/min. The average event rate at equilibrium is indicated with a red dashed line, and the 1% event rate is indicated with a blue dashed line. The intersection of the pink dashed line and the X-axis is when the radon adsorption efficiency decreases to 99%, which is used to calculate the radon adsorption coefficient. The adsorption coefficient is defined as:

$$C = \frac{F_G \times t_A}{m_{AC}} \quad (1)$$

Where C is the radon adsorption coefficient in the unit of L/g, F_G is the gas flow rate in the unit of L/min, t_A is the time when the radon adsorption efficiency decreases to 99%, and its unit is minute, m_{AC} is the activated carbon mass in the unit of gram which is 0.73 g in this measurement.

According to Fig. 5, the radon adsorption coefficient at -80 ± 5 °C is 425 ± 14 L/g, and the error is derived from the gas flow rate and the bin width of the histogram.

4. Influencing factors of radon adsorption on activated carbon

The intrinsic background and its radon adsorption capability are the main factors considered in the application of activated carbon. According to our

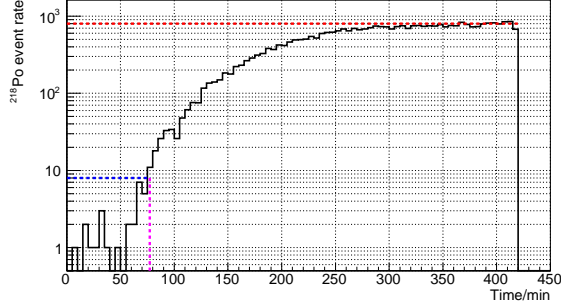

Figure 5: ^{222}Rn breakthrough curve. The Y-axis is the event rate of ^{218}Po . This curve is measured at -80°C with 0.73 g activated carbon, and the gas flow rate is 4 L/min. The average event rate at equilibrium is indicated with the red dashed line, and the 1% event rate is indicated with the blue dashed line. The intersection of the pink dashed line and the X-axis is when the radon adsorption efficiency decreases to 99%, which is used to calculate the radon adsorption coefficient. The events in the first 50 min are caused by the residual ^{222}Rn from the last test.

previous work [5], the ^{226}Ra content of the SARATECH polymer-based spherical activated carbon is ~ 1.36 mBq/kg, which can be used for radon enrichment. While the adsorption capability of the activated carbon is not only affected by its characteristics, micro-porous structure, and relative surface, for example, but also by external conditions. In this work, the authors mainly consider the temperature, the gas flow rate, and the radon concentration in the gas.

4.1. Influencing factor of temperature

The adsorption capability of activated carbon on radon at low temperatures will be significantly enhanced. However, according to our limited knowledge, there is no experiment to give the optimal temperature for radon adsorption on activated carbon.

In this work, the adsorption coefficient dependence on temperature has been measured and the measurement results are shown in Fig. 6. During the measurements, the radon concentration in the gas is 160 ± 16 mBq/m³. For the tests between 0 °C and -60 °C, the gas flow rate is 1 L/min; for the tests between -70 °C to -120 °C, the gas flow rate is 4 L/min, for others, the gas flow rate is 15 L/min.

As can be seen from Fig. 6, from -173 °C to 0 °C, the radon adsorption capability of activated carbon increased significantly along with the decrease

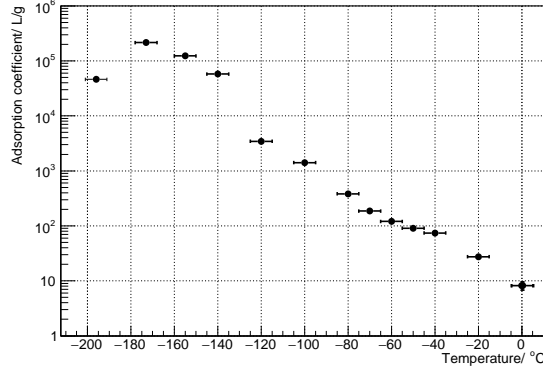

Figure 6: The dependence of adsorption coefficient on temperature. During the test, the radon concentration in the gas is 160 ± 16 mBq/m³. For the tests between 0 °C and -60 °C, the gas flow rate is 1 L/min; for the tests between -70 °C to -120 °C, the gas flow rate is 4 L/min, for other tests, the gas flow rate is 15 L/min.

of temperature. However, when the activated carbon is cooled to -196 °C, the adsorption capability sharply decreases. This is because when the temperature drops to -196 °C, the carrier gas, nitrogen, will be liquefied, and the adsorption capability of activated carbon to radon gas in a liquid is significantly lower than that in gas. Therefore, we can conclude that for the radon adsorption of activated carbon, the lower the temperature is, the stronger the adsorption capability is. Still, it must not be lower than the liquefaction point of the carrier gas.

4.2. Influencing factor of gas flow rate

During the measurement described in Sec. 4.1, three different kinds of gas flow rates are used. When the temperature is relatively high, the radon adsorption capability of activated carbon is weak, and using a large gas flow rate at this time will introduce a large error. While the temperature is low, the radon adsorption capability is strong, a small gas flow rate will make the test time too long.

Five different gas flow rates with the same ²²²Rn concentration at -100 ± 5 °C have been measured to study the influence of gas flow rate on the adsorption coefficient. As is shown in Fig. 7, the adsorption coefficient decreases along with the increase of the gas flow rate. This may be caused by insufficient contact between radon and activated carbon at a high flow rate.

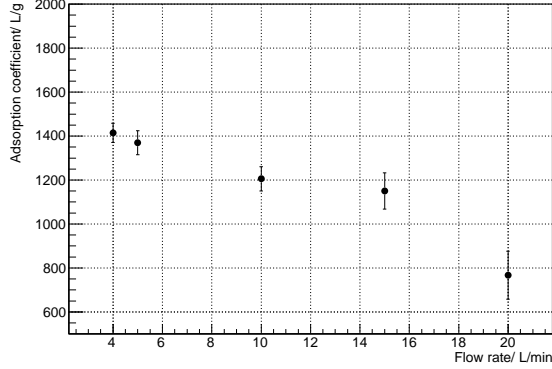

Figure 7: The dependence of adsorption coefficient on gas flow rate. During the test, the radon concentration in the gas is 160 ± 16 mBq/m³, and the temperature is -100 ± 5 °C.

4.3. Influencing factor of radon concentration

Except for the temperature and gas flow rate, the dependence of the adsorption coefficient on ²²²Rn concentration has also been measured. Two different radon concentrations have been measured in the tests, and the results are shown in Fig. 8. The blue curve represents the ²²²Rn concentration in the gas is 160 ± 16 mBq/m³, and the red curve represents the ²²²Rn concentration in the gas is 32.0 ± 3.2 mBq/m³. The two black dotted lines indicate the ²¹⁸Po event rate at equilibrium for two conditions, and the green and pink dotted lines indicate the 1% event rate for two conditions, respectively. The events before 70 minutes are caused by the residual ²²²Rn from the previous measurement. During the measurements, the temperature is -80 ± 5 °C, and the flow rate is 4 L/min.

According to Fig. 8, under these two different ²²²Rn concentrations, the breakthrough curves both reach equilibrium at ~ 400 minutes and get the 1% event rate at ~ 80 minutes, namely, no clear correlation between the adsorption coefficient and ²²²Rn concentration has been observed.

5. Sensitivity estimation

The ²²²Rn concentration measurement sensitivity of this system depends on the sensitivity of the ²²²Rn detector and the enrichment ability of the low-temperature activated carbon system. The sensitivity of the ²²²Rn detector

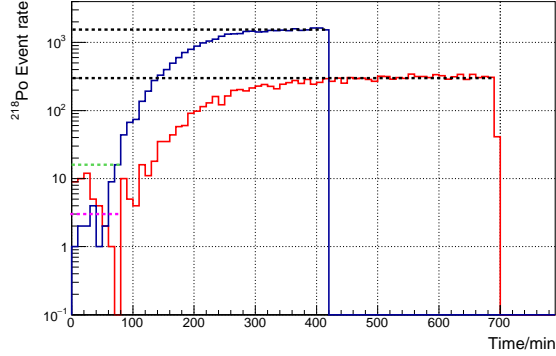

Figure 8: Two breakthrough curves for different radon concentrations. During the tests, the temperature is $-80 \pm 5^\circ\text{C}$, and the flow rate is 4 L/min. While for the ^{222}Rn concentration, the blue curve is $160 \pm 16 \text{ mBq/m}^3$ and the red curve is $32.0 \pm 3.2 \text{ mBq/m}^3$. The two black dotted lines indicate the ^{218}Po event rate at equilibrium for two conditions, and the green and pink dotted lines indicate the 1% event rate for two conditions, respectively. The events before 70 minutes are caused by the residual ^{222}Rn from the previous measurement.

is 0.71 mBq/m^3 for a one-day measurement and the detail can be found in Ref. [5].

The enrichment ability of the activated carbon system depends on the adsorption coefficient and the ^{222}Rn detector volume. The desorption efficiency of activated carbon at 200°C is generally considered to be $\sim 100\%$ [16]. The enrichment factor can be obtained by dividing the volume of gas flow through the activated carbon by the volume of the ^{222}Rn detector. The gas flow volume through the activated carbon should not be larger than the adsorption coefficient. The system shown in Fig. 1 is used here. The gas flow rate is set to 10 L/min, the ^{222}Rn concentration is $\sim 2.5 \text{ Bq/m}^3$, 0.73 g activated is used, and the temperature is $-140 \pm 5^\circ\text{C}$. The volume of ^{222}Rn containing gas adsorbed by activated carbon is 10 m^3 , which does not exceed the adsorption coefficient shown in Fig. 6. The operating procedures are as below:

- (A)-(E) Same as the adsorption coefficient measurement discussed in Sec. 3;
- (F) Monitor the gas volume flow through the activated carbon and close valve1 and valve2 after the gas volume is 10 m^3 ;
- (G) Pump the ^{222}Rn detector to -101kPa ;
- (H) Turn on the temperature control system to heat the activated carbon

to 200°C and open valve1 and valve2 after the temperature is stabilized to 200°C;

- (I) Seal the ^{222}Rn detector after the pressure reaches 0 kPa.
- (J) Measure the ^{222}Rn concentration in the detector.

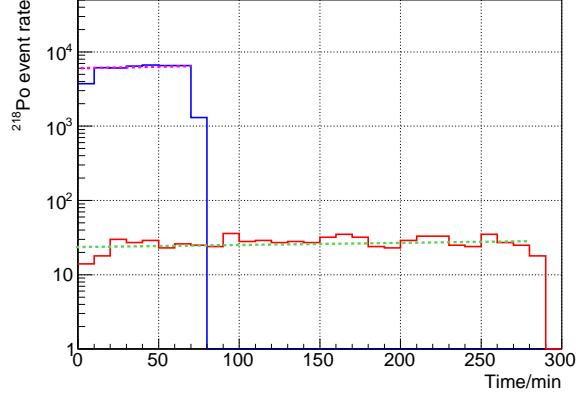

Figure 9: The ^{218}Po event rate before and after the enrichment. The red curve is the direct measurement result, and the average event rate, indicated with a green dashed line, is 28.3 ± 1.0 counts/10min. The blue curve is the event rate after enrichment, and the average event rate, indicated with a pink dashed line, is 6444 ± 36 counts/10min.

Fig. 9 is the ^{218}Po event rates before and after enrichment. The red curve is the direct measurement result of ^{222}Rn concentration in gas, and the blue curve is after enrichment. The expected ^{218}Po event rate can be calculated according to:

$$R_E = R_0 * \left(\frac{V_G}{V_D} + 1 \right) * C_D \quad (2)$$

Where R_E is the expected event rate after enrichment, R_0 is the direct measurement event rate, V_G is the gas volume flow through the activated carbon, V_D is the detector volume, and one is because one volume of gas will be used to bring ^{222}Rn from the activated carbon chamber into the detector, C_D is the decay factor, which is calculated with:

$$C_D = \frac{\int_0^{t_E} e^{-\lambda t} dt}{t_E} \quad (3)$$

Where λ is the ^{222}Rn decay constant, t_E is the enrich time. In this measurement, $t_E = 1000$ min, $C_D = 0.939$, $R_0 = 28.3 \pm 1.0$ counts/10min. R_0

is calculated with the event rate from 20 min to 270 min shown in Fig. 9. Thus R_E is expected to be $(6.43 \pm 0.24) \times 10^3$ counts/10min. The measurement result is in good accordance with R_E , which is $(6.444 \pm 0.036) \times 10^3$ counts/10min.

The ^{222}Rn concentration measurement sensitivity can be estimated with Eq. 5:

$$L = \frac{L_D}{\left(\frac{V_G}{V_D} + 1\right) \times C_D} \quad (4)$$

Where L is the sensitivity of the system, L_D is the sensitivity of the ^{222}Rn detector which is 0.71 mBq/m^3 , V_G , V_D , and C_D are the same as in Eq. 2. With the setup described above, the sensitivity of the system is $\sim 3 \text{ } \mu\text{Bq/m}^3$.

6. Discussion

6.1. Adsorption coefficient

According to the measurement results described in Sec. 4, the adsorption coefficient of activated carbon is related to the temperature and gas flow rate. While in the measurement shown in Fig. 6, the authors used different gas flow rates at different temperatures for measurement accuracy and test duration. Therefore, the measurement results can be further improved if a small gas flow rate is used.

6.2. Activated carbon background

According to our measurement, the ^{226}Ra concentration in Saratech activated carbon is $\sim 1.36 \text{ mBq/kg}$. The activity of ^{222}Rn emanated from the activated carbon can be calculated with Eq. 5:

$$A_{Rn} = A_{Ra} \times (1 - e^{-\lambda t_E}) \quad (5)$$

Where A_{Rn} is the ^{222}Rn activity, A_{Ra} is the ^{226}Ra activity of the activated carbon, λ is the ^{222}Rn decay constant, t_E is the enrich time.

If $t_E=24 \text{ h}$, the background contributed by the activated carbon will be $\sim 0.23 \text{ } \mu\text{Bq}$. Therefore, the influence of the activated carbon background on the measurement is negligible.

6.3. Limit sensitivity estimation

As described in Sec. 5, if the temperature is $\sim -140^\circ\text{C}$, the gas flow rate is 10 L/min, and the enrich time is 1000 min, the sensitivity is $\sim 3 \mu\text{Bq}/\text{m}^3$. While according to Fig. 6, 1 g activated carbon can be used to adsorb the radon in more than 200 m^3 radon gas. With the parameters shown in Tab. 1, the limit sensitivity of the system can be calculated according to Eq. 3, and it is $\sim 0.3 \mu\text{Bq}/\text{m}^3$.

When $T_E = 9.26 \text{ d}$, the ^{222}Rn background contributed by the activated is $\sim 1.1 \mu\text{Bq}$, if averaged to the 200 m^3 gas, it will be $0.0055 \mu\text{Bq}/\text{m}^3$, which is negligible to the measurement.

Temperature($^\circ\text{C}$)	$F_G(\text{L}/\text{min})$	$T_E(\text{min})$	$V_G(\text{m}^3)$	C_D
-173 ± 5	15	$9.26 \times 24 \times 60$	200	0.48

Table 1: Parameters used for limit sensitivity estimation.

7. Conclusions and future prospects

JUNO is a multipurpose neutrino experiment aiming to determine the neutrino mass ordering and precisely measure the neutrino oscillation parameters. ^{222}Rn is one of the main background sources. To measure the ^{222}Rn concentration in the nitrogen used for JUNO, a highly sensitive ^{222}Rn concentration measurement system based on ^{222}Rn enrichment of low-temperature activated carbon and ^{222}Rn measurement of the electrostatic collection has been developed and the limit sensitivity of the system is $\sim 0.3 \mu\text{Bq}/\text{m}^3$.

This paper also measured the adsorption coefficient of Saratech activated carbon at different conditions. The results show that above the liquefaction temperature of the carrier gas, the lower the temperature, the larger the adsorption coefficient. Besides, the adsorption coefficient also increases with the decrease of the gas flow rate.

The measurement results also show that the Saratech activated carbon is an excellent candidate for the research and development of radon removal devices. The amount of activated carbon, working temperature, and gas flow rate need to be determined according to specific experimental conditions.

8. Acknowledgments

This work is supported by the National Natural Science Foundation of China - Yalong River Hydropower Development Co., LTD. Yalong River Joint

Fund (Grant No. U1865208), the Strategic Priority Research Program of the Chinese Academy of Sciences (Grant No. XDA10011200), the Innovative Project of the Institute of High Energy Physics (Grant No. Y954514), and the National Natural Science Foundation of China (Grant No. 11875280, No. 11905241).

References

- [1] JUNO Collaboration, Neutrino physics with JUNO, *J. Phys. G: Nucl. Part. Phys.* 43 (2016) 030401.
- [2] JUNO Collaboration, JUNO physics and detector, *Progress in Particle and Nuclear Physics* 123 (2022) 103927.
- [3] P. Lombardi, M. Montuschi, A. Formozov, et al., Distillation and stripping pilot plants for the JUNO neutrino detector: Design, operations and reliability, *Nucl. Instrum. Meth. A* 925 (2019) 6-17.
- [4] C. Guo, J.C. Liu, Y.P. Zhang, P. Zhang, C.G. Yang, Y.B. Huang, W.X. Xiong, H.Q. Zhang, Y.T. Wei, Y.Y. Gan, Study on the radon removal for the water system of Jiangmen Underground Neutrino Observatory, *RDTM* (2018)2:48.
- [5] Y.Y. Chen, Y.P. Zhang, Y. Liu, J.C. Liu, C. Guo, P. Zhang, S.K. Qiu, C.G. Yang, and Q. Tang, A study on the radon removal performance of low background activated carbon, *JINST* 17 (2022) P02003.
- [6] M. Wojcik, G. Zuzel, Low-²²²Rn nitrogen gas generator for ultra-low background counting systems, *Nucl. Instrum. Meth. A* 539 (2005) 427-432.
- [7] K. Pushkin, C. Akerlof, D. Anbajagane, J. Armstrong, M. Arthurs, J. Bringewatt, T. Edberg, C. Hall, M. Lei, R. Raymond, M. Reh, D. Saini, A. Sander, J. Schaefer, D. Seymour, N. Swanson, Y. Wang, W. Lorenzon, Study of radon reduction in gases for rare event search experiments, *Nucl. Instrum. Meth. A* 903 (2018) 267-276.
- [8] Y. Takeuchi, K. Okumura, T. Kajita, S. Tasaka, H. Hori, M. Nemoto, et al., Development of high sensitivity radon detectors, *Nucl. Instrum. Meth. A* 421 (1999) 334.

- [9] Y. Nakano, H. Sekiya, S. Tasaka, Y. Takeuchi, R.A. Wendell, M. Matsubara, M. Nakahata, Measurement of radon concentration in super-Kamiokande's buffer gas, Nucl. Instrum. Meth. A 867 (2017) 108-114.
- [10] Y. Nakano a, T. Hokama, M. Matsubara, M. Miwa, M. Nakahata, T. Nakamura, H. Sekiya, Y. Takeuchi, S. Tasaka, R.A. Wendell, Measurement of the radon concentration in purified water in the Super-Kamiokande IV detector, Nucl. Instrum. Meth. A 977 (2020) 164297.
- [11] J. Kiko, Detector for ^{222}Rn measurements in air at the 1mBq/m^3 level, Nucl. Instrum. Meth. A 460 (2001) 272-277.
- [12] DarkSide collaboration, DarkSide-50 532-day Dark Matter Search with Low-Radioactivity Argon, Phys. Rev. D 98 (2018) 102006.
- [13] Super-Kamiokande collaboration, The Super-Kamiokande detector, Nucl. Instrum. Meth. A 501 (2003)418.
- [14] XMASS collaboration, Radon removal from gaseous xenon with activated charcoal, Nucl. Instrum. Meth. A 661 (2012) 50.
- [15] Y. Nakano, K. Ichimura, H. Ito, T. Okada, H. Sekiya, Y. Takeuchi, S. Tasaka, and M. Yamashita, Evaluation of radon adsorption efficiency values in xenon with activated carbon fibers, Prog. Theor. Exp. Phys. 2020, 113H01.
- [16] G. Heusser, W. Rau, B. Freudiger, M. Laubenstein, M. Balata, T. Kirsten, ^{222}Rn detection at the $\mu\text{Bq/m}^3$ range in nitrogen gas and a new Rn purification technique for liquid nitrogen, Applied Radiation and Isotopes 52 (2000) 691-695.
- [17] Lu Guo, Yunxiang Wang, Lei Zhang, Zhi Zeng, Wenbin Dong, Qiuju Guo, The temperature dependence of adsorption coefficients of ^{222}Rn on activated charcoal: an experimental study, Applied Radiation and Isotopes 125 (2017) 185-187.
- [18] Saratech charcoal specification, <https://www.bluecher.com/en/>.
- [19] Y.P. Zhang, J.C. Liu, C. Guo, Y.B. Huang, C. Xu, M.Y. Guan, C.G. Yang, P. Zhang, The development of ^{222}Rn detectors for JUNO prototype, RDTM (2018) 2:5.

- [20] L.F. Xie, J.C. Liu, S.K. Qiu, C. Guo, C.G. Yang, Q. Tang, Y.P. Zhang, P. Zhang, Developing the radium measurement system for the water Cherenkov detector of the Jiangmen Underground Neutrino Observatory, Nucl. Instrum. Meth. A 976 (2020) 164266.