

RATIONAL HOMOLOGY DISK SMOOTHINGS AND LEFSCHETZ FIBRATIONS

HAKHO CHOI

ABSTRACT. In this article, we generalize the results discussed in [EMV11] by introducing a genus to generic fibers of Lefschetz fibrations. That is, we give families of relations in the mapping class groups of genus-1 surfaces with boundaries that represent rational homology disk smoothings of weighted homogeneous surface singularities whose resolution graphs are 3-legged with a bad central vertex.

1. INTRODUCTION

Rational blowdown surgery, which was introduced by Fintushel-Stern [FS97] and generalized by J. Park [Par97], is a surgery operation that replace a linear plumbing $C_{p,q}$ of 2-spheres with a rational homology ball $B_{p,q}$ (i.e., $H_*(B_{p,q}, \mathbb{Q}) \cong H_*(B^4, \mathbb{Q})$). As rational blowdown surgery reduces the second Betti number and the Seiberg-Witten invariants of the surgered manifold are determined by that of the original manifold under mild conditions, it is one of the most powerful tools in constructing smooth 4-manifolds with small Euler characteristic [FS06] [Par05] [PSS05]. Further, it can be used to construct simply connected complex surface of general type with $p_g = 0$ and $K^2 = 2, 3, 4$ because $C_{p,q}$ is the minimal resolution of cyclic quotient surfaces singularities $A_{p^2, pq-1}$, and $B_{p,q}$ is the rational homology disk smoothing (i.e., Milnor fiber with vanishing Milnor number) of $A_{p^2, pq-1}$ [LP07] [PPS09a] [PPS09b]. From these perspectives, researchers attempted to identify other normal surface singularities admitting rational homology disk smoothing (QHD for short). In particular, there is a complete classification of resolution graphs admitting QHD smoothing for the case of weighted homogeneous surface singularities [SSW08], [BS11]. They are all 3-legged or 4-legged graphs. We focus on 3-legged graphs in this article (refer to Figure 1 for the complete list, and for an exhaustive list of 4-legged cases, refer to Figure 2 in [BS11]).

In this article, we aim to interpret QHD smoothings in terms of Lefschetz fibrations. A QHD smoothing is a Stein filling of the link of a weighted homogeneous surface singularity with the Milnor fillable contact structure. As the existence of positive allowable Lefschetz fibration (PALF for short) on a Stein filling is well known in general [AO01] [LP01], an explicit monodromy description of the filling

Date: July 19, 2022.

2010 Mathematics Subject Classification. 57K43, 53D05, 14J17.

Key words and phrases. Lefschetz fibration, Rational homology disk smoothing, Rational blowdowns.

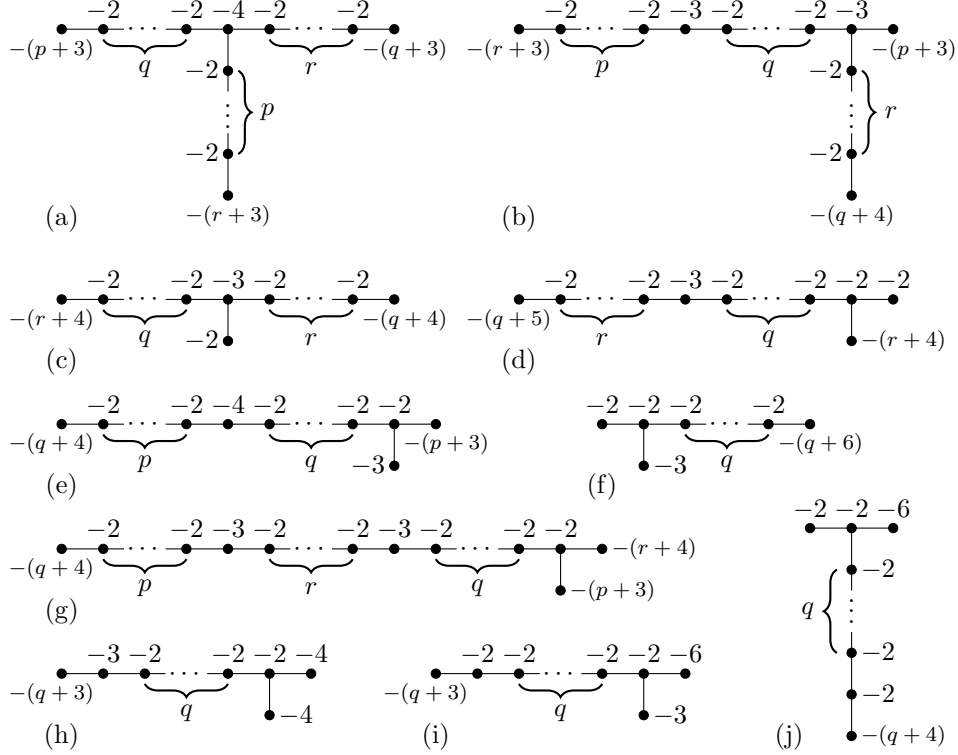

FIGURE 1. 3-legged resolution graphs admitting \mathbb{Q} HD smoothing
 $(p, q, r \geq 0)$

is of great interest. The simplest example of this is the famous lantern relation $abcd = xyz$ in the mapping class group of 4-holed sphere, where each letter stands for right-handed Dehn twists of curves, as depicted in Figure 2. Here, a Lefschetz fibration X with monodromy $abcd$ is diffeomorphic to the minimal resolution of $A_{4,1}$ singularity whose link is diffeomorphic to a lens space $L(4, 1)$ while a Lefschetz fibration Y with monodromy xyz is diffeomorphic to the \mathbb{Q} HD smoothing of the singularity [EG10]. Furthermore, the equality in the relation implies that the boundary of X and Y are diffeomorphic and the induced contact structures on the boundary are isotopic to each other, which is isotopic to the Milnor fillable contact structure. Therefore, asking whether other relations that describe \mathbb{Q} HD smoothings exist is natural. In [EMV11], relations in the mapping class group of planar surfaces corresponding to \mathbb{Q} HD smoothings of $A_{p^2, pq-1}$ and weighted homogeneous surface singularities with resolution graphs belonging to (a), (b) and (c) families in Figure 1 were given by Endo-Mark-Van Horn-Morris. In the resolution graphs depicted in Figure 1, each vertex v corresponds to an irreducible component E_v of the exceptional divisor E , which is topologically 2-sphere, and each edge corresponds to an intersection between the irreducible components E_v . We denote the number of edges connected to a vertex v as the *valence* of v , and the self-intersection of E_v

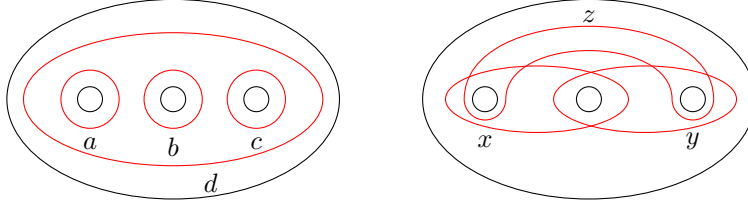

FIGURE 2. Lantern relation

as the *degree* of v . If the absolute value of the degree of v is strictly less than the valence of v , we call the vertex v a *bad vertex*. Note that central vertices in (a), (b), and (c) families in Figure 1 are not bad vertices, while central vertices in other families are bad. In this article, we construct genus-1 Lefschetz fibrations on QHD smoothings containing bad central vertices in their resolution graphs.

Theorem 1.1. *For each resolution graph Γ in Figure 1 with bad central vertex, there is a relation $W_\Gamma = W'_\Gamma$ between words of right-handed Dehn twists in mapping class group of a genus-1 surface with boundaries such that Lefschetz fibration X_Γ with monodromy W_Γ is diffeomorphic to the minimal resolution of corresponding singularity S_Γ and Lefschetz fibration Y_Γ with monodromy W'_Γ is a rational homology ball.*

To prove Theorem 1.1, we proceed as follows: For each resolution graph Γ in Figure 1 with a bad central vertex, we construct a genus-1 PALF X_Γ on the minimal resolution of the singularity S_Γ corresponding to Γ and verify whether the induced contact structure on the boundary is the Milnor fillable contact structure by computing the first Chern class. Then, starting from the global monodromy W_Γ of the X_Γ , we get another positive word $W'_\Gamma = W_\Gamma$ of right-handed Dehn twists by monodromy substitutions after introducing appropriate canceling pairs so that PALF Y_Γ with global monodromy W'_Γ is rationally homology ball filling of the link of S_Γ .

Remark 1.1. From the Lefschetz fibration Y_Γ we constructed, we obtain a rational homology ball filling of the link of S_Γ . Hence, one may ask whether the total space of Y_Γ is symplectic deformation equivalent or diffeomorphic to a QHD smoothing of S_Γ , which is given by complement of the compactifying divisor K_Γ in a rational surface. By analyzing the method of constructing QHD smoothings, M. Bhupal and A. Stipsicz demonstrated that if Γ is one of the resolution graphs in Figure 1 (a), (b), (c), (d), (e), (f) or (g), then rational homology ball filling of the link of S_Γ with the Milnor fillable contact structure is symplectically unique [BS13, Theorem 1.1]. We expect this result to be valid for the (h),(i) and (j) families. However, the uniqueness of the symplectic deformation or diffeomorphism type of rational homology ball filling is unknown for those families.

Acknowledgements. The author thanks Kyungbae Park, Jongil Park and Ki-Heon Yun for their interests and valuable comments. The author is supported by a KIAS Individual Grant (MG071002) at Korea Institute for Advanced Study

2. MONODROMY RELATIONS

As the first step of the proof of Theorem 1.1, we construct genus-1 Lefschetz fibrations on the minimal resolutions. If there is no bad vertex in the resolution graph Γ , there is well-known genus-0 PALF of Gay-Mark on the minimal resolution [GM13] (See also [EO06]): We consider the 2-sphere Σ_i with b_i holes for each vertex v_i with degree $-b_i$. Then, the generic fiber Σ is obtained by gluing Σ_i along their boundaries according to Γ , and the global monodromy is given by the product of right-handed Dehn twists on curves parallel to the boundary of each Σ_i . We end up with only one right-handed Dehn twist on the connecting neck. For the resolution graphs in Figure 1 with bad central vertex, we construct PALFs on the minimal resolutions by introducing a genus on the generic fibers, as in [CP20]. First, we construct genus-0 Lefschetz fibrations on horizontal and vertical part of

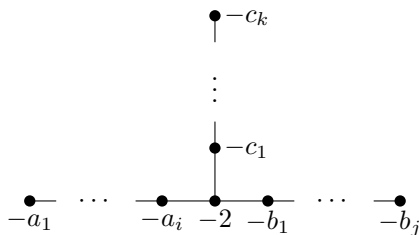
FIGURE 3. 3-legged plumbing graph Γ with bad central vertex

a plumbing graph Γ given in Figure 3 as illustrated in Figure 4 and Figure 5: Let Σ_1 and Σ_2 be the generic fibers for horizontal and vertical parts, respectively. We denote a simple closed curve in Σ_1 enclosing i^{th} hole by α_i and a simple closed curve in Σ_1 enclosing all holes from the first to i^{th} hole by γ_i . Further, we denote a simple closed curve in Σ_2 enclosing i^{th} hole by β_i and a simple closed curve in Σ_2 enclosing all holes from the first to i^{th} hole by δ_i . The global monodromy of horizontal part can be written as $W_a \gamma_N^2 W_b$, where W_a is a word of right-handed Dehn twists along curves from degree $-a_n$ vertices, W_b is a word of right-handed Dehn twists along curves from degree $-b_m$ vertices, and $N = (a_1 + \dots + a_i) - 2i + 1$. Similarly, the global monodromy corresponding to the vertical part can be written as $\beta_1 \dots \beta_{c_1-1} \delta_{c_1-1} W_c$, where W_c is a word of right-handed Dehn twists along curves from degree $-c_l$ vertices with $l = 2, \dots, k$.

Now, we consider a genus-1 surface Σ_Γ obtained from Σ_1 by attaching $b_1(\Sigma_2)$ 1-handles as in Figure 6. Then, we can naturally consider simple closed curves in Σ_i as simple closed curves in Σ_Γ .

Proposition 2.1. *Let X_Γ be a positive allowable Lefschetz fibration with generic fiber Σ_Γ , and global monodromy $\beta_1 \dots \beta_{c_1-1} W_a \gamma_N \delta_{c_1-1} W_c \gamma_N W_b$. Then, total space of X_Γ is diffeomorphic to the plumbing of 2-spheres according to Γ . Furthermore, the first Chern class of X_Γ satisfies the adjunction equality for each vertex in Γ .*

Proof. We first verify that a genus-0 PALF X_L of Gay-Mark on a linear plumbing L (see Figure 7) is actually diffeomorphic to the plumbing of spheres. From the

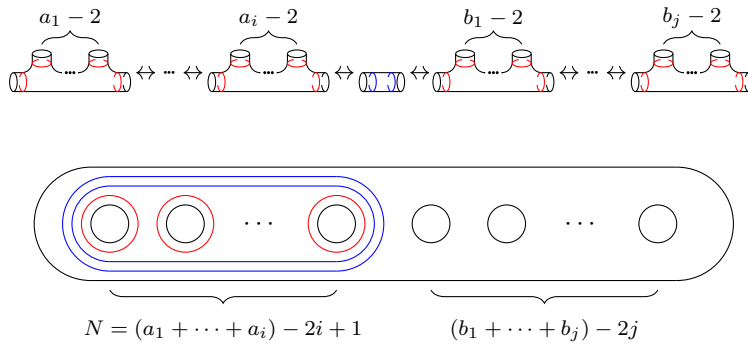

FIGURE 4. Global monodromy: $W_a \gamma_N^2 W_b$

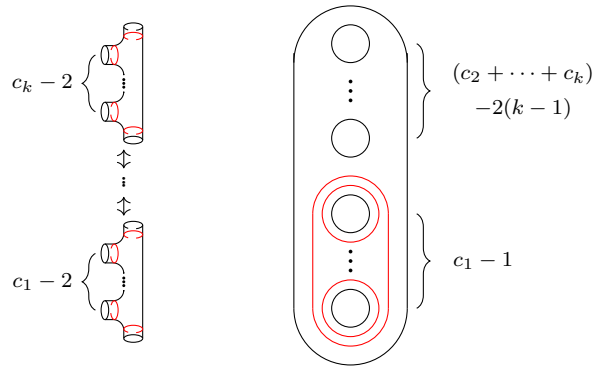

FIGURE 5. Global monodromy: $\beta_1 \cdots \beta_{c_1-1} \delta_{c_1-1} W_c$

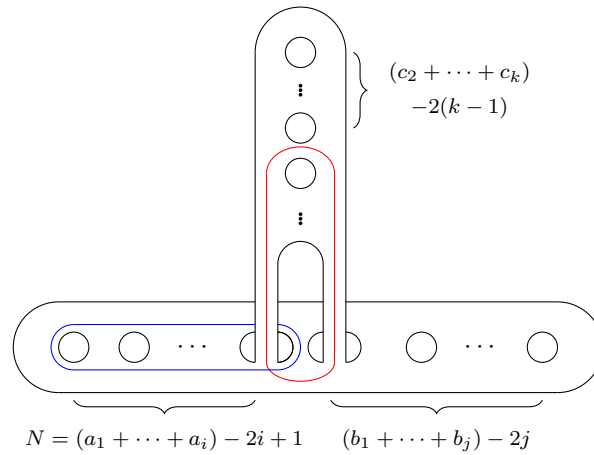

FIGURE 6. Global monodromy: $\beta_1 \cdots \beta_{c_1-1} W_a \gamma_N \delta_{c_1-1} W_c \gamma_N W_b$

Lefschetz fibration structure of X_L , we obtain a Kirby diagram as in Figure 7: As the generic fiber of W is $N = (a_1 + \cdots + a_i) - 2i + 1$ holed disk, we have one 0-handle, N 1-handles and a 2-handle for each vanishing cycle as in Figure 7. Note that all the framings of 2-handles are -1 with respect to the blackboard framing. First, we slide a 2-handle corresponding to γ_N over 2-handles corresponding to α_n

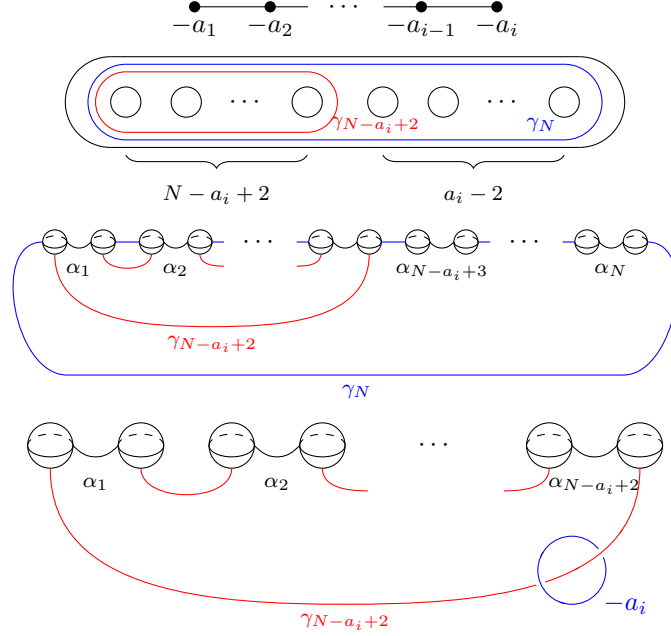

FIGURE 7. Linear plumbing of L and part of Kirby diagram of W

with $n = N - a_i + 3, \dots, N$, and γ_{N-a_i+2} to unlink from the 1-handles. After cancelling 1-handles with α_n ($n = N - a_i + 3, \dots, N$) 2-handles, we obtain the last diagram in Figure 7. A 2-handle represented by unknot in the last diagram in Figure 7 corresponds to degree $-a_i$ vertex v_i in L . Thus, the homology class of v_i can be represented by $\gamma_N - \gamma_{N-a_i+2} - \alpha_{N-a_i+3} - \cdots - \alpha_N$. We also verify that the first Chern class $c_1(X_L)$ satisfies the adjunction equality on v_i : The first Chern class $c_1(X_L)$ is represented by a co-cycle whose value on the 2-handle corresponding to a vanishing cycle is the rotation number of the vanishing cycle [Gom98]. And if we fix a trivialization of the tangent bundle of fiber as a natural extension of a trivialization of the tangent bundle of \mathbb{R}^2 , the rotation numbers of all vanishing cycles of X_L are 1. Then a simple computation shows that the adjunction equality is satisfied on v_i . The aforementioned process can be repeated until a Kirby diagram of the plumbing of 2-spheres according to L is obtained.

Subsequently, we verify that the total space of X_Γ is diffeomorphic to the plumbing of 2-spheres according to Γ . From the Lefschetz fibration structure of X_Γ , we get a Kirby diagram of X_Γ as in Figure 8. The white and gray 1-handles correspond

to the horizontal and vertical parts of Γ , respectively, and all the framings of 2-handles are -1 with respect to the blackboard framing. As the Kirby diagrams for the horizontal and vertical parts are embedded in the diagram for X_Γ , the plumbing of unknots is obtained with respect to the horizontal and vertical parts by sliding and canceling handles as described previously. The linking of horizontal and vertical parts is derived from linkings between 2-handles corresponding to β_1 , δ_{c_1-1} and two γ_N . The homology class of each vertex v is represented by same vanishing cycles derived from linear plumbings. Thus, the first Chern class of X_Γ satisfies adjunction equality on v . \square

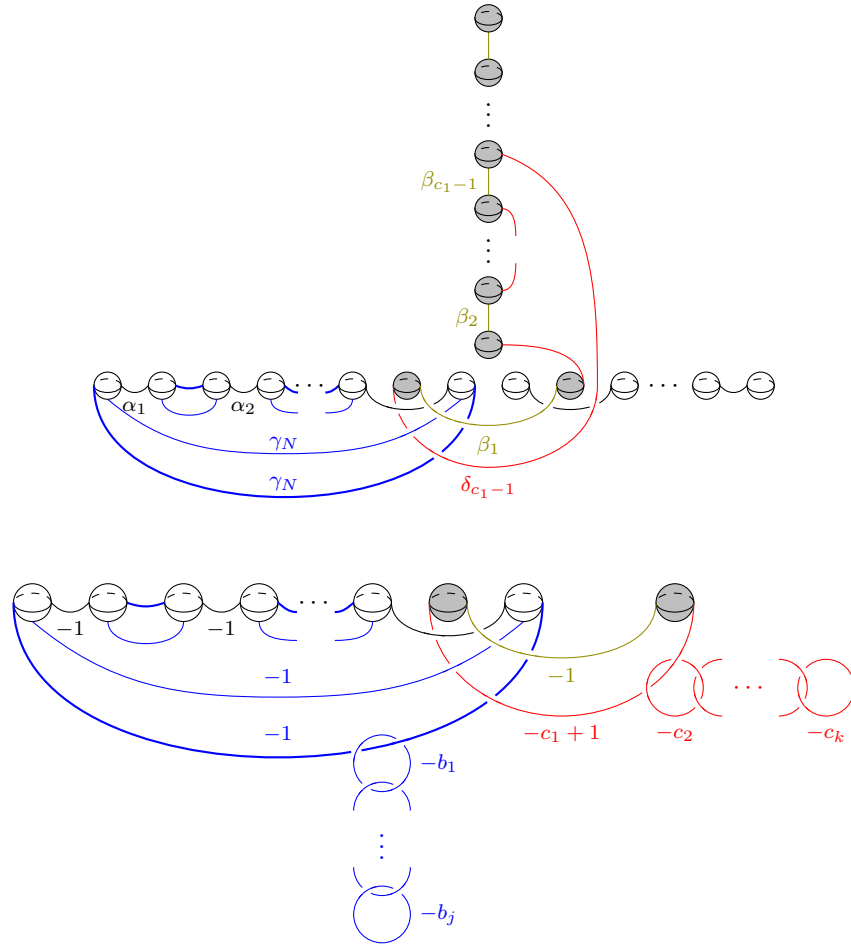

FIGURE 8. Part of Kirby diagram of X_Γ

If Γ is one of the resolution graphs with bad central vertices in Figure 1, then the PALF X_Γ induces the Milnor fillable contact structure on the boundary: Let Y be the 3-manifold diffeomorphic to the boundary of X_Γ . Then Y is a small Seifert 3-manifold $Y(-2; (\alpha_1, \beta_1), (\alpha_2, \beta_2), (\alpha_3, \beta_3))$. If Y is an L -space, there is

a classification of tight contact structures on Y given by Ghiggini (Theorem 1.3 in [Ghi08]): A tight contact structure ξ of L is determined by $Spin^c$ structure t_ξ induced by ξ and filled by the Stein manifolds described via Legendrian surgery on all possible Legendrian realizations of the link corresponding to Γ . In particular, the Milnor fillable contact structure is filled by the Stein manifold whose first Chern class satisfies the adjunction equality on each vertex in Γ . On the other hand, the singularity corresponding to Γ is a rational singularity, because it admits QHD smoothing. Therefore, the link of the singularity, which is diffeomorphic to the boundary of X_Γ , is L -space. Hence, by the theorem of Ghiggini, the PALF X_Γ we constructed induces the Milnor fillable contact structure on the boundary of X_Γ .

Remark 2.1. Using a technique similar to that described in Proposition 2.1, we can construct a genus-1 PALF structure on a 4-legged resolution graph with a central -3 vertex whose first Chern class satisfies the adjunction equality on each vertex. But it is unknown whether the induced contact structure of the PALF is the Milnor fillable due to the lack of a classification of tight contact structures.

We now give an explicit relation $W_\Gamma = W'_\Gamma$ between two words of right-handed Dehn twists on simple closed curves in genus-1 surface Σ_Γ where W_Γ is the global monodromy of X_Γ while the PALF Y_Γ with the global monodromy W'_Γ is a rational homology ball filling. Because of the homology condition on Y_Γ , the length of W'_Γ must be equal to $b_1(\Sigma_\Gamma)$. Conversely, if the length of W'_Γ is equal to $b_1(\Sigma_\Gamma)$, then Y_Γ is a rational homology ball since the boundary of X_Γ is rational homology 3-sphere. We denote the right-handed Dehn twist on a curve α by α and also by t_α and use functional notation for the products of Dehn twists.

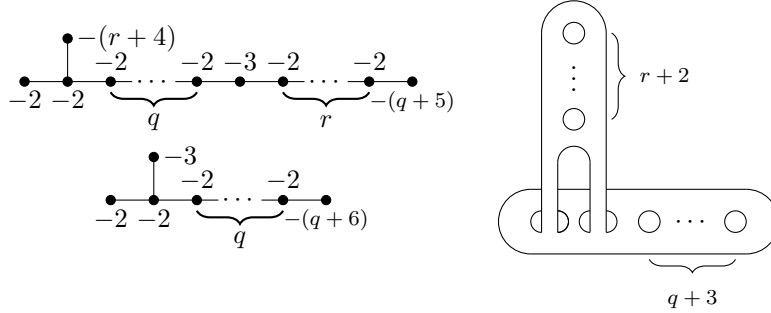

FIGURE 9. Resolution graph $\Gamma_{q,r}$ and generic fiber $\Sigma_{\Gamma_{q,r}}$ for (d) and (f) family

2.1. Relations for (d) and (f) family. Let $\Gamma_{q,r}$ (with $r \geq 0$) be a resolution graph of (d) family and $\Gamma_{q,-1}$ be a resolution graph of (f) family as in Figure 9. Then the generic fiber for $X_{\Gamma_{q,r}}$ is $\Sigma_{\Gamma_{q,r}}$ as in Figure 9 and the global monodromy of $X_{\Gamma_{q,r}}$ is given by

$$\beta_1 \cdots \beta_{r+3} \alpha_1^2 \delta_{r+3} \alpha_1^{q+1} \alpha_2 \gamma_2^{r+1} \alpha_3 \cdots \alpha_{q+5} \gamma_{q+5}$$

We introduce a cancelling pair $\delta_{r+3}^{-1} \cdot \delta_{r+3}$ and rearrange the word using Hurwitz moves.

$$\begin{aligned}
 & \beta_1 \cdots \beta_{r+3} \alpha_1^2 \delta_{r+3} \alpha_1^{q+1} \alpha_2 \gamma_2^{r+1} \alpha_3 \cdots \alpha_{q+5} \gamma_{q+5} \\
 &= \beta_1 \cdots \beta_{r+3} \cdot \delta_{r+3}^{-1} \cdot \delta_{r+3} \cdot \alpha_1^2 \delta_{r+3} \alpha_1^{q+1} \alpha_2 \gamma_2^{r+1} \alpha_3 \cdots \alpha_{q+5} \gamma_{q+5} \\
 &= \beta_1 \cdots \beta_{r+3} \gamma_2^{r+1} \cdot \delta_{r+3}^{-1} \cdot \alpha_1^{q+3} \alpha_2 \alpha_3 \cdots \alpha_{q+5} \gamma_{q+5} \\
 & \quad \cdot (t_{\alpha_1}^{-(q+3)} \cdot t_{\alpha_2}^{-1})(\delta_{r+3}) \cdot (t_{\alpha_1}^{-(q+1)} \cdot t_{\alpha_2}^{-1})(\delta_{r+3})
 \end{aligned}$$

Let $c_r = t_{\alpha_2}^{-1}(\delta_{r+3})$. Then c_r and α_1 intersect geometrically once. Because of the braid relation $c_r \cdot \alpha_1 \cdot c_r = \alpha_1 \cdot c_r \cdot \alpha_1$, we have

$$\begin{aligned}
 & (t_{\alpha_1}^{-(q+3)} \cdot t_{\alpha_2}^{-1})(\delta_{r+3}) \cdot (t_{\alpha_1}^{-(q+1)} \cdot t_{\alpha_2}^{-1})(\delta_{r+3}) \\
 &= \alpha_1^{-(q+3)} \cdot c_r \cdot \alpha_1^2 \cdot c_r \cdot \alpha_1^{(q+1)} \\
 &= \alpha_1^{-(q+3)} \cdot c_r \cdot \alpha_1 \cdot c_r \cdot \alpha_1 \cdot c_r \cdot \alpha_1^q \\
 &= \alpha_1^{-(q+2)} \cdot c_r \cdot \alpha_1^2 \cdot c_r \cdot \alpha_1^q \\
 & \quad \vdots \\
 &= \alpha_1^{-2} \cdot c_r \cdot \alpha_1^2 \cdot c_r \\
 &= \alpha_1^{-2} \cdot c_r \cdot \alpha_1^2 \cdot c_r \cdot \alpha_1 \cdot \alpha_1^{-1} \cdot \\
 &= \alpha_1^{-2} \cdot c_r \cdot \alpha_1 \cdot c_r \cdot \alpha_1 \cdot c_r \cdot \alpha_1^{-1} \\
 &= \alpha_1^{-1} \cdot c_r \cdot \alpha_1 \cdot \alpha_1 \cdot c_r \cdot \alpha_1^{-1} \\
 &= (t_{\alpha_1}^{-1})(c_r) \cdot t_{\alpha_1}(c_r)
 \end{aligned}$$

On the other hand, we have a daisy relation of the form

$$\alpha_1^{q+3} \alpha_2 \cdots \alpha_{q+5} \gamma_{q+5} = y_1 y_2 \cdots y_{q+5}$$

with $y_1 = \gamma_2$ as in Figure 10 to Figure 11. Hence after a daisy substitution and

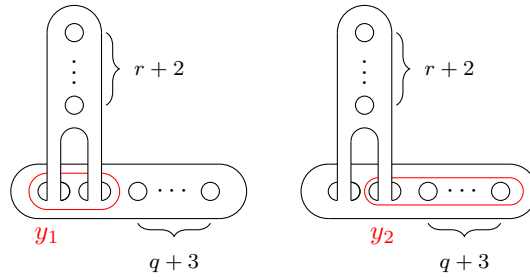
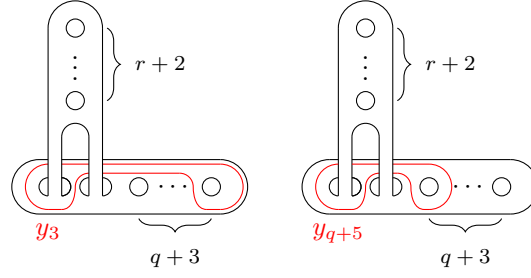

FIGURE 10. y_1 and y_2

Hurwitz moves, we have

$$\begin{aligned}
 & \beta_1 \cdots \beta_{r+3} \gamma_2^{r+1} \cdot \delta_{r+3}^{-1} \cdot y_1 y_2 \cdots y_{q+5} \cdot (t_{\alpha_1}^{-1})(c_r) \cdot t_{\alpha_1}(c_r) \\
 &= \beta_1 \cdots \beta_{r+3} \gamma_2^{r+2} \cdot \delta_{r+3}^{-1} \cdot y_2 \cdots y_{q+5} \cdot (t_{\alpha_1}^{-1})(c_r) \cdot t_{\alpha_1}(c_r) \\
 &= Y_{2,r} \cdots Y_{q+5,r} \cdot (t_{\beta_1} \cdot t_{\delta_{r+3}}^{-1} \cdot t_{\alpha_1}^{-1})(c_r) \cdot \beta_1 \cdots \beta_{r+3} \cdot t_{\alpha_1}(c_r) \cdot \gamma_2^{r+2} \cdot \delta_{r+3}^{-1}
 \end{aligned}$$

FIGURE 11. y_i for $i = 3, \dots, q + 5$

where $Y_{i,r} = (t_{\beta_1} \cdot t_{\delta_{r+3}}^{-1})(y_i)$. Again, we have a daisy relation of the form

$$\beta_1 \cdots \beta_{r+3} \cdot t_{\alpha_1}(c_r) \cdot \gamma_2^{r+2} = z_1 \cdot z_2 \cdots z_{r+3} \cdot z_{r+4}$$

with $z_{r+4} = \delta_{r+3}$. See Figure 12 for corresponding curves in planar surface. By performing a daisy substitution and cancelling z_{r+4} with δ_{r+3}^{-1} , we get a monodromy factorization $W'_{\Gamma_{q,r}}$ whose length is $b_1(\Sigma_{\Gamma_{q,r}})$.

$$Y_{2,r} \cdots Y_{q+5,r} \cdot (t_{\beta_1} \cdot t_{\delta_{r+3}}^{-1} \cdot t_{\alpha_1}^{-1})(c_r) \cdot z_1 \cdots z_{r+3}$$

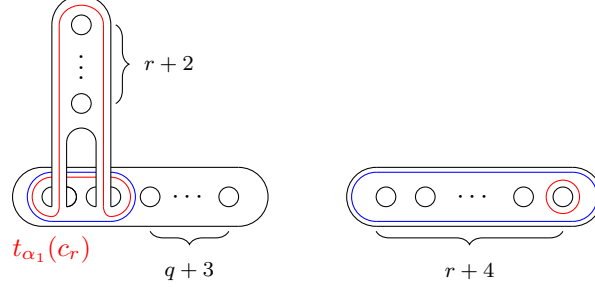
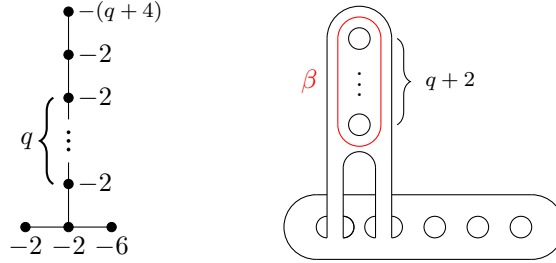

FIGURE 12. Corresponding curves for a daisy relation

FIGURE 13. Resolution graph Γ_q and generic fiber Σ_{Γ_q} for (j) family

2.2. Relations for (j) family. Let Γ_q be a resolution graph of (j) family as in Figure 13. Then the generic fiber for X_{Γ_q} is Σ_r as in Figure 13 and the global monodromy of X_{Γ_q} is given by

$$\beta_1 \alpha_1^2 \beta_1^{q+1} \beta_2 \cdots \beta_{q+3} \delta_{q+3} \alpha_1 \alpha_2 \alpha_3 \alpha_4 \alpha_5 \gamma_5.$$

We introduce a cancelling pair $\beta^{-1} \cdot \beta$ and rearrange the word using Hurwitz moves where β is a simple closed curve in Σ_r as in Figure 13.

$$\begin{aligned} & \beta_1 \cdot \beta^{-1} \cdot \beta \cdot \alpha_1^2 \beta_1^{q+1} \beta_2 \cdots \beta_{q+3} \delta_{q+3} \alpha_1 \alpha_2 \alpha_3 \alpha_4 \alpha_5 \gamma_5 \\ &= \beta_2 \cdots \beta_{q+3} \cdot \beta^{-1} \cdot \beta_1 \beta \alpha_1^2 \beta_1^{q+1} \delta_{q+3} \alpha_1 \alpha_2 \alpha_3 \alpha_4 \alpha_5 \gamma_5 \\ &= \beta_2 \cdots \beta_{q+3} \cdot \beta^{-1} \cdot \underline{\beta_1 \beta \alpha_1^2 \delta_{q+3} \alpha_1 \alpha_2 \alpha_3 \alpha_4 \alpha_5 \gamma_5} \cdot ((t_{\alpha_1}^{-1} \cdot t_{\alpha_2}^{-1})(\beta_1))^{q+1} \end{aligned}$$

There is a obvious subsurface of Σ_q which is diffeomorphic to $\Sigma_{0,-1}$ of Figure 9 so that image of each curve of $\Sigma_{0,-1}$ in Σ_q is as follows

$$\begin{aligned} \beta_1 &\rightarrow \beta_1 \\ \beta_2 &\rightarrow \beta \\ \delta_2 &\rightarrow \delta_{q+3} \\ \alpha_i &\rightarrow \alpha_i \end{aligned}$$

By performing a monodromy substitution corresponds to $\Gamma_{0,-1}$ of (f) family, we have

$$\begin{aligned} & \beta_2 \cdots \beta_{q+3} \cdot \beta^{-1} \cdot \beta_1 \beta \alpha_1^2 \delta_{q+3} \alpha_1 \alpha_2 \alpha_3 \alpha_4 \alpha_5 \gamma_5 \cdot ((t_{\alpha_1}^{-1} \cdot t_{\alpha_2}^{-1})(\beta_1))^{q+1} \\ &= \beta_2 \cdots \beta_{q+3} \cdot \beta^{-1} \cdot Y_{q,2} \cdots Y_{q,5} \cdot (t_{\beta_1} \cdot t_{\delta_{q+3}}^{-1} \cdot t_{\alpha_1}^{-1})(c_q) \cdot z_{q,1} z_{q,2} \cdot B^{q+1} \\ &= Y_{q,2} \cdots Y_{q,5} \\ & \quad \cdot \beta_2 \cdots \beta_{q+3} \cdot (t_{\beta_1} \cdot t_{\delta_{q+3}}^{-1} \cdot t_{\alpha_1}^{-1})(c_q) \cdot B^{q+1} \cdot \beta^{-1} \cdot (t_B^{-(q+1)})(z_{q,1}) \cdot (t_B^{-(q+1)})(z_{q,2}) \end{aligned}$$

Here $Y_{q,i}$ and $z_{q,j}$ is image of $Y_{i,-1}$ and z_j of $\Sigma_{0,-1}$ in Σ_q respectively, $c_q = t_{\alpha_2}^{-1}(\delta_{q+3})$ and $B = (t_{\alpha_1}^{-1} \cdot t_{\alpha_2}^{-1})(\beta_1)$. We have a daisy relation of the form

$$\beta_2 \cdots \beta_{q+3} \cdot (t_{\beta_1} \cdot t_{\delta_{q+3}}^{-1} \cdot t_{\alpha_1}^{-1})(c_q) \cdot B^{q+1} = x_1 \cdots x_{q+3}$$

with $x_{q+3} = \beta$. See Figure 14 for corresponding curves in planar surface. By performing a daisy substitution and cancelling x_{q+3} with β^{-1} , we get a monodromy factorization W'_{Γ_q} whose length is $b_1(\Sigma_{\Gamma_q})$.

$$Y_{q,2} \cdots Y_{q,5} \cdot x_1 \cdots x_{q+2} \cdot (t_B^{-(q+1)})(z_{q,1}) \cdot (t_B^{-(q+1)})(z_{q,2})$$

2.3. Relations for (e) and (g) family. Let $\Gamma_{p,q,-1}$ be a resolution graph of (e) family and $\Gamma_{p,q,r}$ (with $r \geq 0$) be a resolution graph of (g) family as in Figure 15. Then the generic fiber for $X_{\Gamma_{p,q,r}}$ is $\Sigma_{p,q,r}$ as in Figure 15 and the global monodromy of $X_{\Gamma_{p,q,r}}$ is given by

$$\beta_1 \cdots \beta_{p+2} \alpha_1 \cdots \alpha_{r+3} \gamma_{r+3} \delta_{p+2} \gamma_{r+3}^{q+1} \alpha_{r+4} \gamma_{r+4}^{r+1} \alpha_{r+5} \gamma_{r+5}^{p+1} \alpha_{r+6} \cdots \alpha_{r+q+7} \gamma_{r+q+7}$$

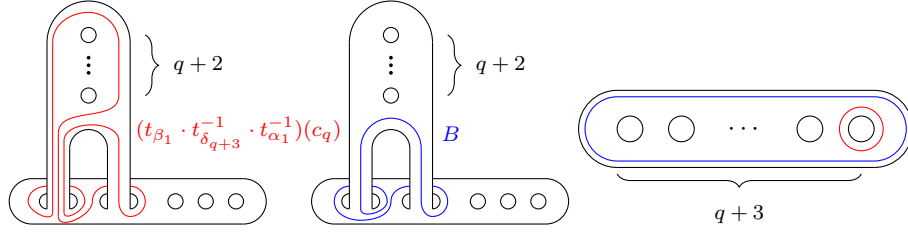
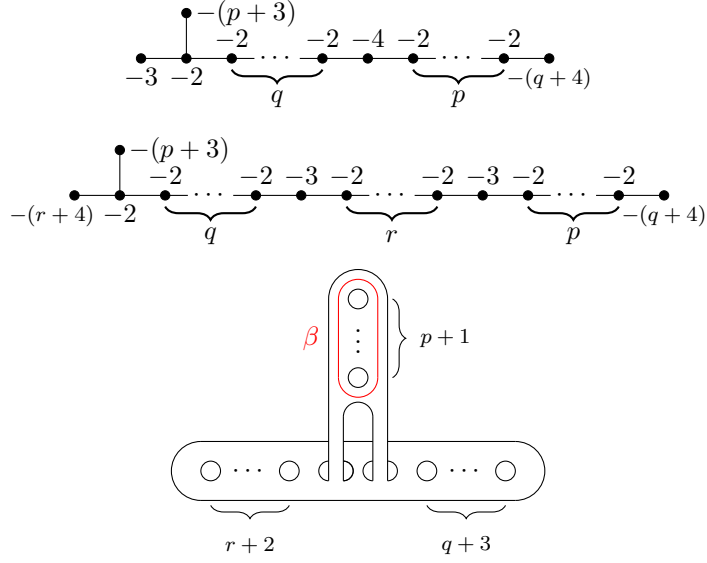

FIGURE 14. Corresponding curves for a daisy relation

FIGURE 15. Resolution graph $\Gamma_{p,q,r}$ and generic fiber $\Sigma_{\Gamma_{p,q,r}}$ for (e) and (g) family

We introduce cancelling pairs $\beta^{-1} \cdot \beta$, $\gamma_{r+2}^{-1} \cdot \gamma_{r+2}$ and $\gamma_{r+3}^{-1} \cdot \gamma_{r+3}$ and rearrange the word using Hurwitz moves where β is a simple closed curve in $\Sigma_{p,q,r}$ as in Figure 15.

$$\begin{aligned}
& \beta_1 \cdots \beta_{p+2} \alpha_1 \cdots \alpha_{r+3} \gamma_{r+3} \delta_{p+2} \gamma_{r+3}^{q+1} \alpha_{r+4} \gamma_{r+4}^{r+1} \alpha_{r+5} \gamma_{r+5}^{p+1} \alpha_{r+6} \cdots \alpha_{r+q+7} \gamma_{r+q+7} \\
&= \beta_1 \cdots \beta_{p+2} \cdot \beta^{-1} \cdot \beta \cdot \alpha_1 \cdots \alpha_{r+2} \cdot \gamma_{r+2}^{-1} \cdot \gamma_{r+2} \cdot \alpha_{r+3} \cdot \gamma_{r+3}^{-1} \cdot \gamma_{r+3} \\
&\quad \cdot \gamma_{r+3} \delta_{p+2} \gamma_{r+3}^{q+1} \alpha_{r+4} \gamma_{r+4}^{r+1} \alpha_{r+5} \gamma_{r+5}^{p+1} \alpha_{r+6} \cdots \alpha_{r+q+7} \gamma_{r+q+7} \\
&= \beta_1 \cdots \beta_{p+2} \cdot \beta^{-1} \cdot \alpha_1 \cdots \alpha_{r+2} \cdot \gamma_{r+2}^{-1} \cdot \gamma_{r+3}^{-1} \\
&\quad \cdot \beta \gamma_{r+2} \alpha_{r+3} \gamma_{r+3}^2 \delta_{p+2} \gamma_{r+3}^{q+1} \alpha_{r+4} \gamma_{r+4}^{r+1} \alpha_{r+5} \gamma_{r+5}^{p+1} \alpha_{r+6} \cdots \alpha_{r+q+7} \gamma_{r+q+7} \\
&= \beta_1 \cdots \beta_{p+2} \cdot \beta^{-1} \cdot \alpha_1 \cdots \alpha_{r+2} \cdot \gamma_{r+2}^{-1} \cdot \gamma_{r+3}^{-1} \cdot \gamma_{r+4}^{r+1} \cdot \gamma_{r+5}^p \\
&\quad \cdot \beta \gamma_{r+2} \alpha_{r+3} \gamma_{r+3}^2 \delta_{p+2} \gamma_{r+3}^{q+1} \alpha_{r+4} \alpha_{r+5} \gamma_{r+5} \alpha_{r+6} \cdots \alpha_{r+q+7} \gamma_{r+q+7} \\
&= \beta_2 \cdots \beta_{p+2} \cdot \beta^{-1} \cdot \alpha_1 \cdots \alpha_{r+2} \cdot \gamma_{r+2}^{-1} \cdot \gamma_{r+4}^{r+1} \cdot \gamma_{r+5}^p \cdot (t_{\beta_1}(\gamma_{r+3}))^{-1} \\
&\quad \cdot \beta \gamma_{r+2} t_{\beta_1}(\alpha_{r+3}) (t_{\beta_1}(\gamma_{r+3}))^2 \delta_{p+2} (t_{\beta_1}(\gamma_{r+3}))^{q+1} \beta_1 \alpha_{r+4} \\
&\quad \cdot \alpha_{r+5} \gamma_{r+5} \alpha_{r+6} \cdots \alpha_{r+q+7} \gamma_{r+q+7} \\
&= \beta_2 \cdots \beta_{p+2} \cdot \beta^{-1} \cdot \alpha_1 \cdots \alpha_{r+2} \cdot \gamma_{r+2}^{-1} \cdot \gamma_{r+4}^{r+1} \cdot \gamma_{r+5}^p \cdot (t_{\beta_1}(\gamma_{r+3}))^{-1} \\
&\quad \cdot \beta \gamma_{r+2} t_{\beta_1}(\alpha_{r+3}) (t_{\beta_1}(\gamma_{r+3}))^2 \delta_{p+2} (t_{\beta_1}(\gamma_{r+3}))^{q+1} \alpha_{r+4} (t_{\alpha_{r+4}}^{-1})(\beta_1) \\
&\quad \cdot \alpha_{r+5} \gamma_{r+5} \alpha_{r+6} \cdots \alpha_{r+q+7} \gamma_{r+q+7}
\end{aligned}$$

Let $\gamma = t_{\beta_1}(\gamma_{r+3})$. Then γ and δ_{p+2} intersect geometrically. Because of the braid relation $\gamma \cdot \delta_{p+2} \cdot \gamma = \delta_{p+2} \cdot \gamma \cdot \delta_{p+2}$, we have

$$\begin{aligned}
 & \gamma^2 \delta_{p+2} \gamma^{q+1} \\
 &= \gamma \cdot \delta_{p+2} \cdot \gamma \cdot \delta_{p+2} \cdot \gamma^q \\
 &= \gamma \cdot \delta_{p+2}^2 \cdot \gamma \cdot \delta_{p+2} \cdot \gamma^{q-1} \\
 & \quad \vdots \\
 &= \gamma \cdot \delta_{p+2}^{q+1} \cdot \gamma \cdot \delta_{p+2} \\
 &= \gamma \cdot \delta_{p+2}^{q+2} \cdot (t_{\delta_{p+2}}^{-1})(\gamma) \\
 &= (t_\gamma(\delta_{p+2}))^{q+2} \cdot \gamma \cdot (t_{\delta_{p+2}}^{-1})(\gamma) \\
 &= (t_\gamma(\delta_{p+2}))^{q+3} \cdot (t_{\delta_{p+2}}^{-1} \cdot t_\gamma^{-1} \cdot t_{\delta_{p+2}})(\gamma) \quad (\because (t_{\delta_{p+2}}^{-1})(\gamma) = t_\gamma(\delta_{p+2}))
 \end{aligned}$$

Back to the global monodromy, we have

$$\begin{aligned}
 & \beta_2 \cdots \beta_{p+2} \cdot \beta^{-1} \cdot \alpha_1 \cdots \alpha_{r+2} \cdot \gamma_{r+2}^{-1} \cdot \gamma_{r+4}^{r+1} \cdot \gamma_{r+5}^p \cdot (t_{\beta_1}(\gamma_{r+3}))^{-1} \\
 & \cdot \beta \gamma_{r+2} t_{\beta_1}(\alpha_{r+3}) (t_\gamma(\delta_{p+2}))^{q+3} (t_{\delta_{p+2}}^{-1} \cdot t_\gamma^{-1} \cdot t_{\delta_{p+2}})(\gamma) \alpha_{r+4} (t_{\alpha_{r+4}}^{-1})(\beta_1) \\
 & \cdot \alpha_{r+5} \gamma_{r+5} \alpha_{r+6} \cdots \alpha_{r+q+7} \gamma_{r+q+7} \\
 = & \beta_2 \cdots \beta_{p+2} \cdot \beta^{-1} \cdot \alpha_1 \cdots \alpha_{r+2} \cdot \gamma_{r+2}^{-1} \cdot \gamma_{r+4}^{r+1} \cdot \gamma_{r+5}^p \cdot (t_{\beta_1}(\gamma_{r+3}))^{-1} \\
 & \cdot \beta \gamma_{r+2} t_{\beta_1}(\alpha_{r+3}) (t_\gamma(\delta_{p+2}))^{q+3} \alpha_{r+4} (t_{\alpha_{r+4}}^{-1} \cdot t_{\delta_{p+2}}^{-1} \cdot t_\gamma^{-1} \cdot t_{\delta_{p+2}})(\gamma) \cdot (t_{\alpha_{r+4}}^{-1})(\beta_1) \\
 & \cdot \alpha_{r+5} \gamma_{r+5} \alpha_{r+6} \cdots \alpha_{r+q+7} \gamma_{r+q+7} \\
 = & \beta_2 \cdots \beta_{p+2} \cdot \beta^{-1} \cdot \alpha_1 \cdots \alpha_{r+2} \cdot \gamma_{r+2}^{-1} \cdot \gamma_{r+4}^{r+1} \cdot \gamma_{r+5}^p \cdot (t_{\beta_1}(\gamma_{r+3}))^{-1} \\
 & \cdot \gamma_{r+2} \cdot t_{\beta_1}(\alpha_{r+3}) \cdot \underline{\beta \cdot (t_\gamma(\delta_{p+2}))^{q+3} \alpha_{r+4} \alpha_{r+5} \gamma_{r+5} \alpha_{r+6} \cdots \alpha_{r+q+7} \gamma_{r+q+7}} \\
 & \cdot (t_{\alpha_{r+4}}^{-1} \cdot t_{\delta_{p+2}}^{-1} \cdot t_\gamma^{-1} \cdot t_{\delta_{p+2}})(\gamma) \cdot (t_{\alpha_{r+4}}^{-1})(\beta_1)
 \end{aligned}$$

The underlined part can be seen an embedding of the linear plumbing L_q in Figure 17: Let L_q be a linear plumbing and Σ_{L_q} be a generic fiber for X_{L_q} as in Figure 17. Then the monodromy for X_{L_q} can be written as

$$a_1^{q+3} a_2 a_3 a_4 b_4 a_5 \cdots a_{q+6} b_{q+6}$$

where a_i is simple closed curve in Σ_{L_q} enclosing i th hole and b_j is simple closed curve in Σ_{L_q} enclosing from the first to i th holes. Then there is a planar subsurface of $\Sigma_{\Gamma_{p,q,r}}$ which is diffeomorphic to Σ_{L_q} so that the image of each curves are

$$\begin{aligned}
 a_1 & \rightarrow t_\gamma(\delta_{p+2}) \\
 a_2 & \rightarrow \beta \\
 a_i & \rightarrow \alpha_{r+i+1} \quad (i = 3, \dots, q+6) \\
 b_4 & \rightarrow \gamma_{r+5} \\
 b_{q+6} & \rightarrow \gamma_{r+q+7}
 \end{aligned}$$

The linear plumbing L_q can be rationally blowdown and the relation in the mapping

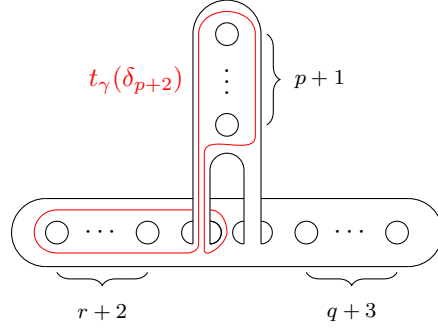

FIGURE 16. $t_\gamma(\delta_{p+2})$ in $\Sigma_{\Gamma_{p,q,r}}$

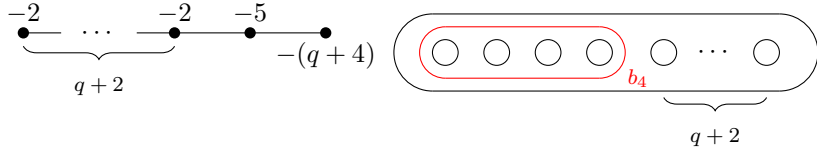

FIGURE 17. Linear plumbing L_q and the generic fiber Σ_{L_q} for X_{L_q}

class group of Σ_{L_q} for the rational blowdown was given by Endo-Mark-Van Horn-Morris in [EMV11].

$$a_1^{q+3} a_2 a_3 a_4 b_4 a_5 \cdots a_{q+6} b_{q+6} = y_1 y_2 \cdots y_{q+6}$$

Let $Y_{p,i,r}$ a simple closed curve in $\Sigma_{\Gamma_{p,q,r}}$ be the image of y_i which can be drawn

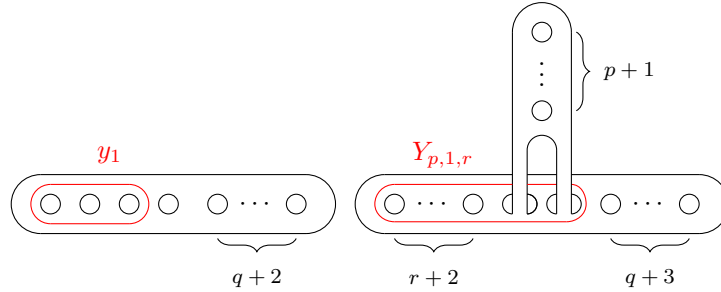
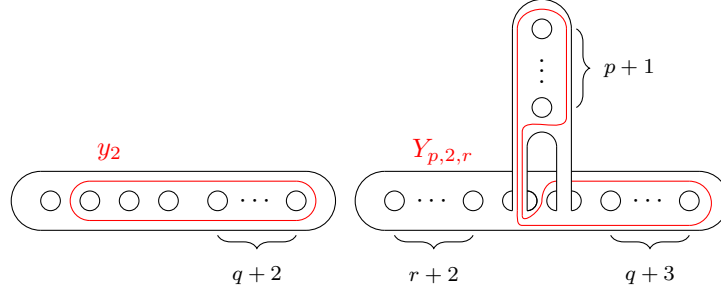
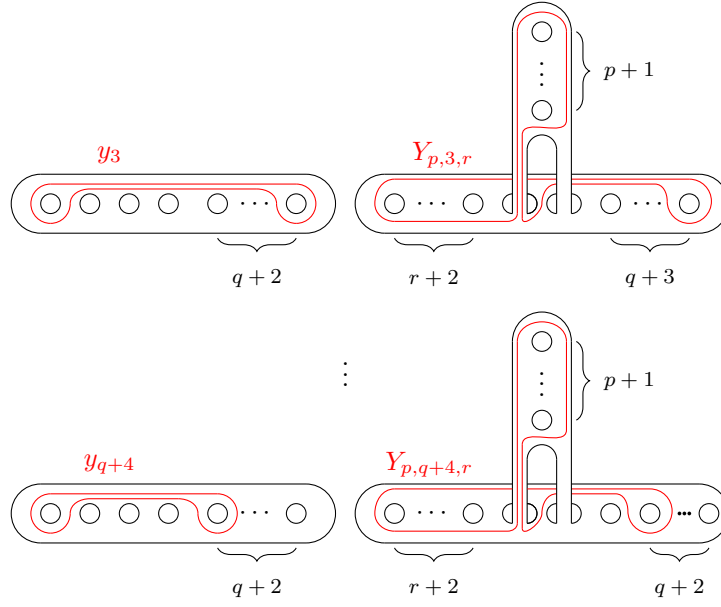

FIGURE 18. y_1 and $Y_{p,1,r} = (t_{\alpha_{r+4}}^{-1} \cdot t_{\beta_1}^{-1} \cdot t_{\alpha_{r+4}})(Y_{p,1,r})$

FIGURE 19. y_2 and $Y_{p,2,r}$ FIGURE 20. y_i and $Y_{p,i,r}$ for $(i = 3, \dots, q+4)$

as in Figure 18 to Figure 22. Then we have

$$\begin{aligned}
& \beta_2 \cdots \beta_{p+2} \cdot \beta^{-1} \cdot \alpha_1 \cdots \alpha_{r+2} \cdot \gamma_{r+2}^{-1} \cdot \gamma_{r+4}^{r+1} \cdot \gamma_{r+5}^p \cdot (t_{\beta_1}(\gamma_{r+3}))^{-1} \\
& \cdot \gamma_{r+2} \cdot t_{\beta_1}(\alpha_{r+3}) \cdot \beta(t_{\gamma}(\delta_{p+2}))^{q+3} \alpha_{r+4} \alpha_{r+5} \gamma_{r+5} \alpha_{r+6} \cdots \alpha_{r+q+7} \gamma_{r+q+7} \\
& \cdot (t_{\alpha_{r+4}}^{-1} \cdot t_{\delta_{p+2}}^{-1} \cdot t_{\gamma}^{-1} \cdot t_{\delta_{p+2}})(\gamma) \cdot (t_{\alpha_{r+4}}^{-1})(\beta_1) \\
= & \beta_2 \cdots \beta_{p+2} \cdot \beta^{-1} \cdot \alpha_1 \cdots \alpha_{r+2} \cdot \gamma_{r+2}^{-1} \cdot \gamma_{r+4}^{r+1} \cdot \gamma_{r+5}^p \cdot (t_{\beta_1}(\gamma_{r+3}))^{-1} \\
& \cdot \gamma_{r+2} \cdot t_{\beta_1}(\alpha_{r+3}) \cdot Y_{p,1,r} \cdots Y_{p,q+6,r} \cdot (t_{\alpha_{r+4}}^{-1} \cdot t_{\delta_{p+2}}^{-1} \cdot t_{\gamma}^{-1} \cdot t_{\delta_{p+2}})(\gamma) \cdot (t_{\alpha_{r+4}}^{-1})(\beta_1) \\
= & \beta_2 \cdots \beta_{p+2} \cdot \beta^{-1} \cdot \alpha_1 \cdots \alpha_{r+2} \cdot \gamma_{r+2}^{-1} \cdot \gamma_{r+4}^{r+1} \cdot \gamma_{r+5}^p \\
& \cdot (t_{\beta_1}(\gamma_{r+3}))^{-1} \cdot \gamma_{r+2} \cdot t_{\beta_1}(\alpha_{r+3}) \cdot (t_{\alpha_{r+4}}^{-1})(\beta_1) \cdot (t_{\alpha_{r+4}}^{-1} \cdot t_{\beta_1}^{-1} \cdot t_{\alpha_{r+4}})(Y_{p,1,r}) \\
& (t_{\alpha_{r+4}}^{-1} \cdot t_{\beta_1}^{-1} \cdot t_{\alpha_{r+4}})(Y_{p,1,r}) \cdots (t_{\alpha_{r+4}}^{-1} \cdot t_{\beta_1}^{-1} \cdot t_{\alpha_{r+4}})(Y_{p,q+6,r}) \\
& \cdot (t_{\alpha_{r+4}}^{-1} \cdot t_{\beta_1}^{-1} \cdot t_{\delta_{p+2}}^{-1} \cdot t_{\gamma}^{-1} \cdot t_{\delta_{p+2}})(\gamma)
\end{aligned}$$

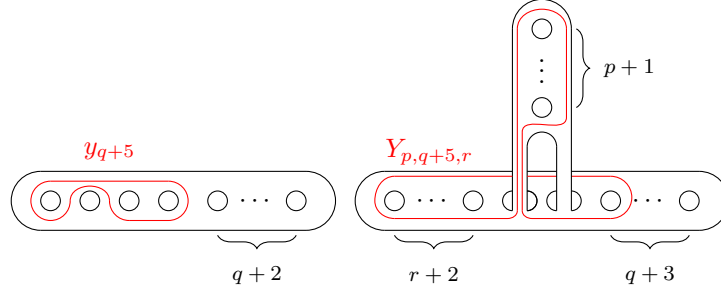

FIGURE 21. y_{q+5} and $Y_{p,q+5,r} = (t_{\alpha_{r+4}}^{-1} \cdot t_{\beta_1}^{-1} \cdot t_{\alpha_{r+4}})(Y_{p,q+5,r})$

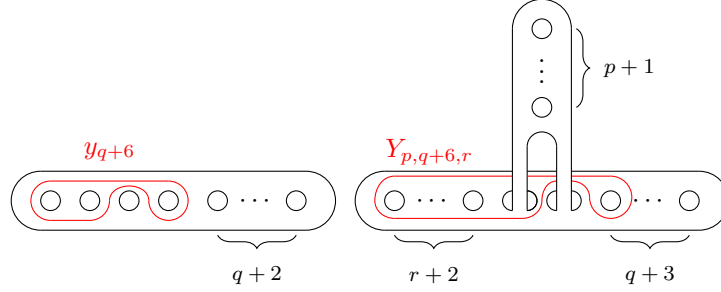

FIGURE 22. y_{q+6} and $Y_{p,q+6,r}$

Note that

$$\begin{aligned}
 & \gamma_{r+2} \cdot t_{\beta_1}(\alpha_{r+3}) \cdot (t_{\alpha_{r+4}}^{-1})(\beta_1) \cdot (t_{\alpha_{r+4}}^{-1} \cdot t_{\beta_1}^{-1} \cdot t_{\alpha_{r+4}})(Y_{p,1,r}) \\
 &= t_{\beta_1}(\gamma_{r+2}) \cdot t_{\beta_1}(\alpha_{r+3}) \cdot t_{\beta_1}(\alpha_{r+4}) \cdot t_{\beta_1}(\gamma_{r+4}) \\
 &= t_{\beta_1}(\gamma_{r+3}) \cdot t_{\beta_1}(a) \cdot t_{\beta_1}(b)
 \end{aligned}$$

where a and b are simple closed curves as in Figure 23 due to the lantern relation. After a lantern substitution and cancelling $(t_{\beta_1}(t_{\gamma_{r+3}}))^{-1}$ with $t_{\beta_1}(t_{\gamma_{r+3}})$, we have

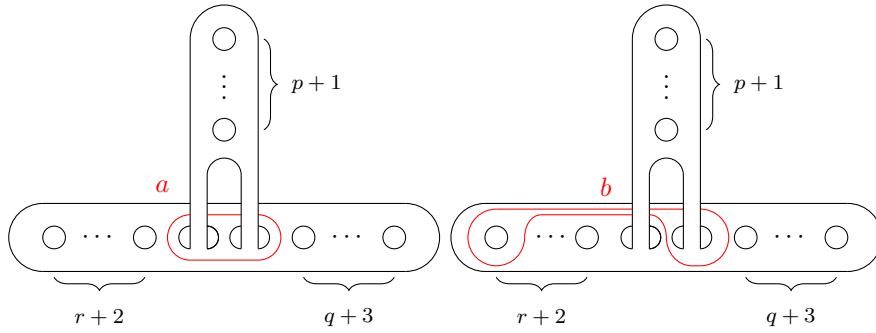

FIGURE 23. $a = t_{\beta_1}(a)$ and b in $\Sigma_{\gamma_{p,q,r}}$

$$\begin{aligned}
 & \beta_2 \cdots \beta_{p+2} \cdot \beta^{-1} \cdot \alpha_1 \cdots \alpha_{r+2} \cdot \gamma_{r+2}^{-1} \cdot \gamma_{r+4}^{r+1} \cdot \gamma_{r+5}^p \\
 & \cdot (t_{\beta_1}(\gamma_{r+3}))^{-1} \cdot \gamma_{r+2} \cdot t_{\beta_1}(\alpha_{r+3}) \cdot (t_{\alpha_{r+4}}^{-1})(\beta_1) \cdot (t_{\alpha_{r+4}}^{-1} \cdot t_{\beta_1}^{-1} \cdot t_{\alpha_{r+4}})(Y_{p,1,r}) \\
 & \cdot (t_{\alpha_{r+4}}^{-1} \cdot t_{\beta_1}^{-1} \cdot t_{\alpha_{r+4}})(Y_{p,2,r}) \cdots (t_{\alpha_{r+4}}^{-1} \cdot t_{\beta_1}^{-1} \cdot t_{\alpha_{r+4}})(Y_{p,q+6,r}) \\
 & \cdot (t_{\alpha_{r+4}}^{-1} \cdot t_{\beta_1}^{-1} \cdot t_{\delta_{p+2}}^{-1} \cdot t_{\gamma}^{-1} \cdot t_{\delta_{p+2}})(\gamma) \\
 = & \beta_2 \cdots \beta_{p+2} \cdot \beta^{-1} \cdot \alpha_1 \cdots \alpha_{r+2} \cdot \gamma_{r+2}^{-1} \cdot \gamma_{r+4}^{r+1} \cdot \gamma_{r+5}^p \cdot t_{\beta_1}(a) \cdot t_{\beta_1}(b) \\
 & \cdot (t_{\alpha_{r+4}}^{-1} \cdot t_{\beta_1}^{-1} \cdot t_{\alpha_{r+4}})(Y_{p,2,r}) \cdots (t_{\alpha_{r+4}}^{-1} \cdot t_{\beta_1}^{-1} \cdot t_{\alpha_{r+4}})(Y_{p,q+6,r}) \\
 & \cdot (t_{\alpha_{r+4}}^{-1} \cdot t_{\beta_1}^{-1} \cdot t_{\delta_{p+2}}^{-1} \cdot t_{\gamma}^{-1} \cdot t_{\delta_{p+2}})(\gamma) \\
 = & \alpha_1 \cdots \alpha_{r+2} \cdot t_{\beta_1}(a) \cdot \gamma_{r+4}^{r+1} \cdot \gamma_{r+2}^{-1} \cdot t_{\beta_1}(b) \\
 & \cdot (t_{\alpha_{r+4}}^{-1} \cdot t_{\beta_1}^{-1} \cdot t_{\alpha_{r+4}})(Y_{p,2,r}) \cdots (t_{\alpha_{r+4}}^{-1} \cdot t_{\beta_1}^{-1} \cdot t_{\alpha_{r+4}})(Y_{p,q+4,r}) \\
 & \cdot \beta_2 \cdots \beta_{p+2} \cdot Y_{p,q+5,r} \cdot \gamma_{r+5}^p \cdot \beta^{-1} \\
 & \cdot (t_{\alpha_{r+4}}^{-1} \cdot t_{\beta_1}^{-1} \cdot t_{\alpha_{r+4}})(Y_{p,q+6,r}) \cdot (t_{\alpha_{r+4}}^{-1} \cdot t_{\beta_1}^{-1} \cdot t_{\delta_{p+2}}^{-1} \cdot t_{\gamma}^{-1} \cdot t_{\delta_{p+2}})(\gamma)
 \end{aligned}$$

One can easily check that

$$\begin{aligned}
 \alpha_1 \cdots \alpha_{r+2} \cdot t_{\beta_1}(a) \cdot \gamma_{r+4}^{r+1} &= Z_{p,q,1} \cdots Z_{p,q,r+3} \\
 \beta_2 \cdots \beta_{p+2} \cdot Y_{p,q+5,r} \cdot \gamma_{r+5}^p &= X_{1,q,r} \cdots X_{p+2,q,r}
 \end{aligned}$$

for some simple closed curves $X_{i,q,r}$ and $Z_{p,q,j}$ with $X_{p+2,q,r} = \beta$ and $Z_{p,q,r+3} = \gamma_{r+2}$ due to the daisy relations. By performing daisy substitutions and cancelling $X_{p+2,q,r}$ with β^{-1} and $Z_{p,q,r+3}$ with γ_{r+2}^{-1} , we get a monodromy factorization $W_{\Gamma_{p,q,r}}^r$ whose length is $b_1(\Sigma_{\Gamma_{p,q,r}})$.

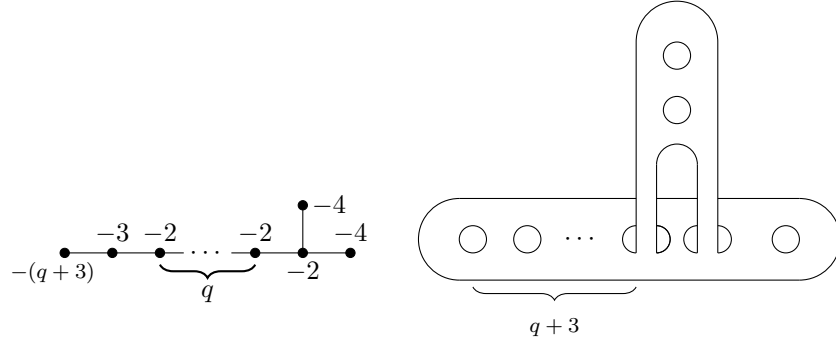

FIGURE 24. Resolution graph Γ_q and generic fiber Σ_{Γ_q} for (h) family

2.4. Relations for (h) family. Let Γ_q be a resolution graph of (h) family as in Figure 24. Then the generic fiber for X_{Γ_q} is Σ_q as in Figure 24 and the global monodromy of X_{Γ_q} is given by

$$\beta_1 \beta_2 \beta_3 \alpha_1 \alpha_2 \cdots \alpha_{q+2} \gamma_{q+2} \alpha_{q+3} \gamma_{q+3}^{q+1} \delta_3 \gamma_{q+3} \alpha_{q+4} \alpha_{q+5} \gamma_{q+5}$$

We rearrange the word using Hurwitz moves as follows.

$$\begin{aligned}
& \beta_1 \beta_2 \beta_3 \alpha_1 \alpha_2 \cdots \alpha_{q+2} \gamma_{q+2} \alpha_{q+3} \gamma_{q+3}^{q+1} \delta_3 \gamma_{q+3} \alpha_{q+4} \alpha_{q+5} \gamma_{q+5} \\
&= \beta_1 \beta_2 \beta_3 \alpha_1 \alpha_2 \cdots \alpha_{q+2} \gamma_{q+2} \gamma_{q+3}^{q+1} \alpha_{q+4} (t_{\alpha_{q+3}} \cdot t_{\alpha_{q+4}}^{-1}) (\delta_3) \gamma_{q+3} \alpha_{q+3} \alpha_{q+5} \gamma_{q+5} \\
&= \beta_2 \beta_3 \alpha_1 \alpha_2 \cdots \alpha_{q+2} \gamma_{q+2} (t_{\beta_1}(\gamma_{q+3}))^{q+1} t_{\beta_1}(\alpha_{q+4}) \beta_1 (t_{\alpha_{q+3}} \cdot t_{\alpha_{q+4}}^{-1}) (\delta_3) \gamma_{q+3} \\
&\quad \cdot \alpha_{q+3} \alpha_{q+5} \gamma_{q+5} \\
&= \beta_2 \beta_3 \alpha_1 \alpha_2 \cdots \alpha_{q+2} \gamma_{q+2} (t_{\beta_1}(\gamma_{q+3}))^{q+1} t_{\beta_1}(\alpha_{q+4}) \beta_1 \gamma_{q+3} (t_{\gamma_{q+3}}^{-1} \cdot t_{\alpha_{q+3}} \cdot t_{\alpha_{q+4}}^{-1}) (\delta_3) \\
&\quad \cdot \alpha_{q+3} \alpha_{q+5} \gamma_{q+5}
\end{aligned}$$

Let $\delta = (t_{\gamma_{q+3}}^{-1} \cdot t_{\alpha_{q+3}} \cdot t_{\alpha_{q+4}}^{-1}) (\delta_3)$.

$$\begin{aligned}
& \beta_2 \beta_3 \alpha_1 \alpha_2 \cdots \alpha_{q+2} \gamma_{q+2} (t_{\beta_1}(\gamma_{q+3}))^{q+1} t_{\beta_1}(\alpha_{q+4}) \beta_1 \gamma_{q+3} \delta \alpha_{q+3} \alpha_{q+5} \gamma_{q+5} \\
&= \beta_2 \beta_3 \alpha_1 \alpha_2 \cdots \alpha_{q+2} \gamma_{q+2} (t_{\beta_1}(\gamma_{q+3}))^{q+1} t_{\beta_1}(\alpha_{q+4}) t_{\beta_1}(\gamma_{q+3}) \beta_1 \delta \alpha_{q+3} \alpha_{q+5} \gamma_{q+5} \\
&= \beta_2 \beta_3 \alpha_1 \alpha_2 \cdots \alpha_{q+2} \gamma_{q+2} (t_{\beta_1}(\gamma_{q+3}))^{q+1} t_{\beta_1}(\alpha_{q+4}) t_{\beta_1}(\gamma_{q+3}) \delta t_{\delta}^{-1}(\beta_1) \alpha_{q+3} \alpha_{q+5} \gamma_{q+5} \\
&= \beta_2 \beta_3 \alpha_1 \alpha_2 \cdots \alpha_{q+2} \gamma_{q+2} (t_{\beta_1}(\gamma_{q+3}))^{q+2} t_{\beta_1}(\alpha_{q+4}) \delta t_{\delta}^{-1}(\beta_1) \alpha_{q+3} \alpha_{q+5} \gamma_{q+5}
\end{aligned}$$

Now we introduce cancelling pair $\gamma_{q+4} \cdot \gamma_{q+4}^{-1}$ as follows.

$$\underline{\beta_2 \beta_3 \alpha_1 \alpha_2 \cdots \alpha_{q+2} \gamma_{q+2} (t_{\beta_1}(\gamma_{q+3}))^{q+2} t_{\beta_1}(\alpha_{q+4}) \delta \cdot \gamma_{q+4} \cdot \gamma_{q+4}^{-1} t_{\delta}^{-1}(\beta_1) \alpha_{q+3} \alpha_{q+5} \gamma_{q+5}}$$

By taking a global conjugation of each monodromy with γ_{q+3} , the underlined part can be seen an embedding of the linear plumbing L_q in Figure 26: The α_i , β_j and γ_k is unchanged under conjugation. Note that $t_{\beta_1}(\gamma_{q+3}) = t_{\gamma_{q+3}}^{-1}(\beta_1)$ since β_1 and γ_{q+3} intersect geometrically once. And $(t_{\gamma_{q+3}} \cdot t_{\beta_1})(\alpha_{q+4})$ and $t_{\gamma_{q+3}}(\delta)$ can be drawn as in Figure 25. Let L_q be a linear plumbing and Σ_{L_q} be a generic fiber for X_{L_q} as

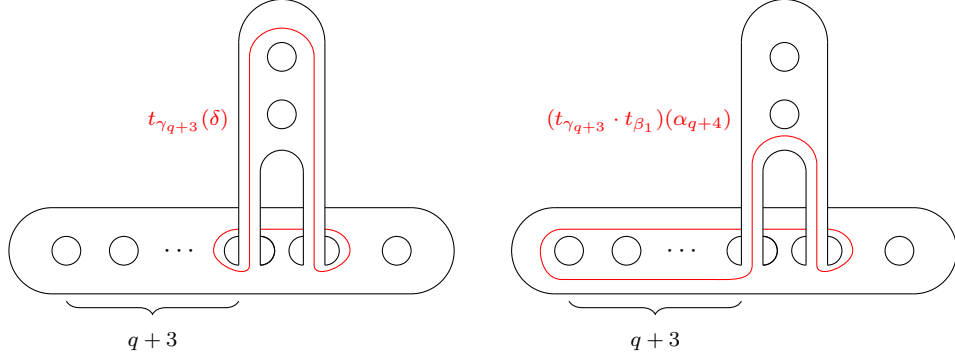

FIGURE 25. $t_{\gamma_{q+3}}(\delta)$ and $(t_{\gamma_{q+3}} \cdot t_{\beta_1})(\alpha_{q+4})$ in Σ_{γ_q}

in Figure 26. Then the monodromy for X_{L_q} can be written as

$$a_1 a_2 \cdots a_{q+2} b_{q+2} a_{q+3} a_{q+4} a_{q+5} b_{q+5} a_{q+6}^{q+2} b_{q+6}$$

where a_i is simple closed curve in Σ_{L_q} enclosing i th hole and b_j is simple closed curve in Σ_{L_q} enclosing from the first to i th holes. Then there is a planar subsurface

of Σ_{Γ_q} which is diffeomorphic to Σ_{L_q} so that the image of each curves are

$$\begin{aligned}
 a_i &\rightarrow \alpha_i & (i = 1, \dots, q+2) \\
 b_{q+2} &\rightarrow \gamma_{q+2} \\
 a_{q+3} &\rightarrow t_{\gamma_{q+3}}(\delta) \\
 a_{q+4} &\rightarrow \beta_3 \\
 a_{q+5} &\rightarrow \beta_2 \\
 b_{q+5} &\rightarrow (t_{\gamma_{q+3}} \cdot t_{\beta_1})(\alpha_{q+4}) \\
 a_{q+6} &\rightarrow \beta_1 \\
 b_{q+6} &\rightarrow \gamma_{q+4}
 \end{aligned}$$

The linear plumbing L_q can be rationally blowdown and the relation in the mapping

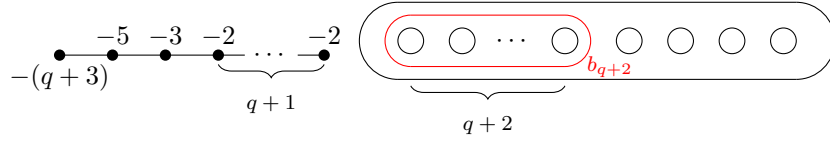

FIGURE 26. Linear plumbing L_q and the generic fiber Σ_{L_q} for X_{L_q}

class group of Σ_{L_q} for the rational blowdown was given by Endo-Mark-Van Horn-Morris in [EMV11].

$$a_1 a_2 \cdots a_{q+2} b_{q+2} a_{q+3} a_{q+4} a_{q+5} b_{q+5} a_{q+6}^{q+2} = y_1 y_2 \cdots y_{q+6}$$

Let Y_i a simple closed curve in Σ_{Γ_q} be the image of y_i in Σ_{L_q} which can be drawn as in Figure 27 to Figure 31 and X_i be $t_{\gamma_{q+3}}^{-1}(Y_i)$. Then we have

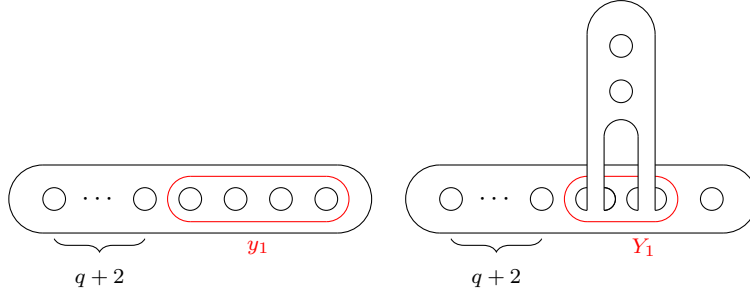
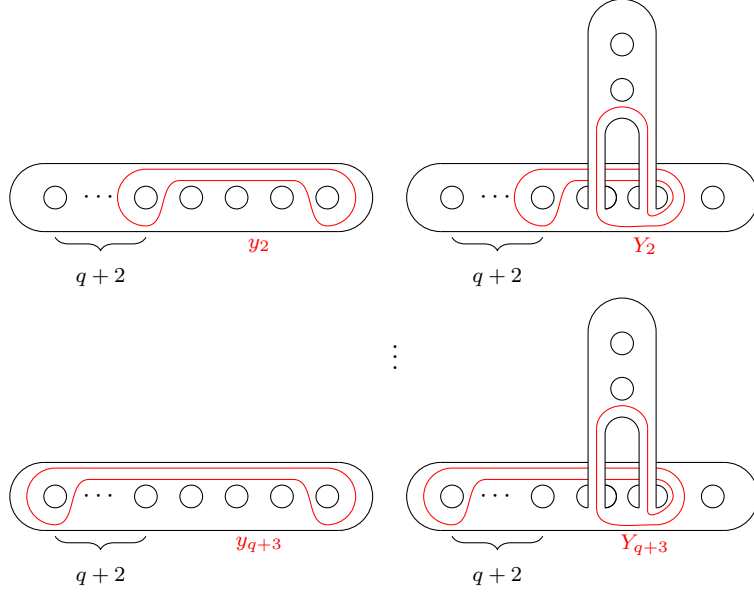
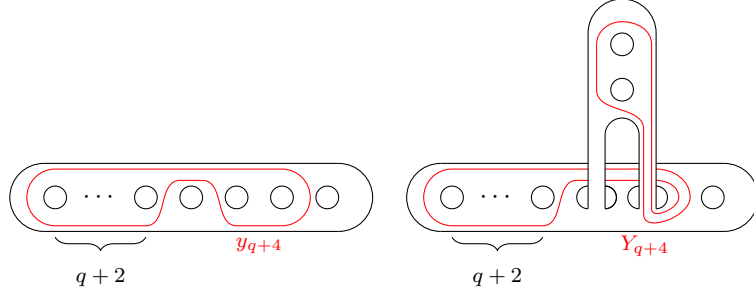

FIGURE 27. y_1 and Y_1

$$\begin{aligned}
 &\underline{\beta_2 \beta_3 \alpha_1 \alpha_2 \cdots \alpha_{q+2} \gamma_{q+2} (t_{\beta_1}(\gamma_{q+3}))^{q+2} t_{\beta_1}(\alpha_{q+4}) \delta \gamma_{q+4} \cdot \gamma_{q+4}^{-1} t_{\delta}^{-1}(\beta_1) \alpha_{q+3} \alpha_{q+5} \gamma_{q+5}} \\
 &= t_{\gamma_{q+3}}^{-1}(Y_1) t_{\gamma_{q+3}}^{-1}(Y_2) \cdots t_{\gamma_{q+3}}^{-1}(Y_{q+6}) \gamma_{q+4}^{-1} t_{\delta}^{-1}(\beta_1) \alpha_{q+3} \alpha_{q+5} \gamma_{q+5} \\
 &= X_1 \cdots X_{q+6} t_{\delta}^{-1}(\beta_1) \alpha_{q+3} \alpha_{q+5} \gamma_{q+5} \gamma_{q+4}^{-1} \\
 &= X_1 \cdots X_{q+4} (t_{X_{q+5}} \cdot t_{X_{q+6}} \cdot t_{\delta}^{-1})(\beta_1) X_{q+5} X_{q+6} \alpha_{q+3} \alpha_{q+5} \gamma_{q+5} \gamma_{q+4}^{-1} \\
 &= X_1 \cdots X_{q+4} (t_{X_{q+5}} \cdot t_{X_{q+6}} \cdot t_{\delta}^{-1})(\beta_1) \alpha_{q+3} \alpha_{q+5} \gamma_{q+5} \gamma_{q+4}^{-1} t_{\alpha_{q+3}}^{-1}(X_{q+5}) t_{\alpha_{q+3}}^{-1}(X_{q+6})
 \end{aligned}$$

FIGURE 28. y_i and Y_i for $(i = 2, \dots, q + 3)$ FIGURE 29. y_{q+4} and Y_{q+4}

One can easily see that $(t_{X_{q+5}} \cdot t_{X_{q+6}} \cdot t_{\delta}^{-1})(\beta_1)\alpha_{q+3}\alpha_{q+5}\gamma_{q+5} = Z_q \cdot W_q \cdot \gamma_{q+4}$ for some simple closed curve W_q and Z_q due to the lantern relation (See Figure 32). By performing a lantern substitution and cancelling γ_{q+4} with γ_{q+4}^{-1} , we get a monodromy factorization $W_{\Gamma_q}^t$ whose length is $b_1(\Sigma_{\Gamma_q})$.

$$X_1 \cdots X_{q+4} \cdot Z_q \cdot W_q \cdot t_{\alpha_{q+3}}^{-1}(X_{q+5}) \cdot t_{\alpha_{q+3}}^{-1}(X_{q+6})$$

2.5. Relations for (i) family. Let Γ_q be a resolution graph of (i) family as in Figure 33. Then the generic fiber for X_{Γ_q} is Σ_q as in Figure 33 and the global monodromy of X_{Γ_q} is given by

$$\beta_1 \beta_2 \alpha_1 \alpha_2 \alpha_3 \alpha_4 \alpha_5 \gamma_5 \delta_2 \gamma_5^{q+2} \alpha_6 \cdots \alpha_{q+6} \gamma_{q+6}$$

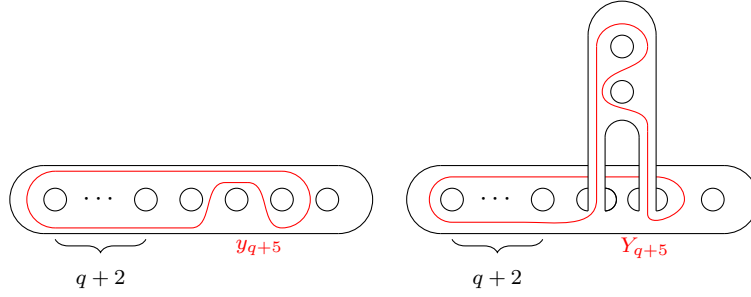
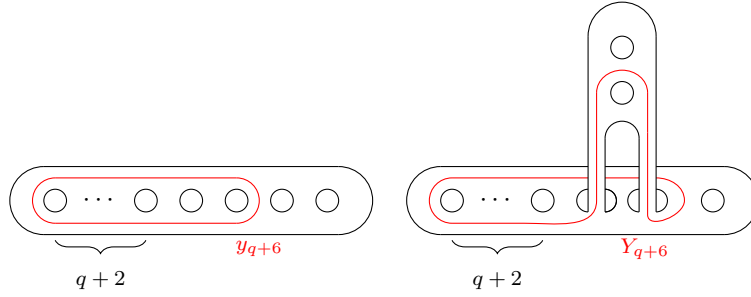
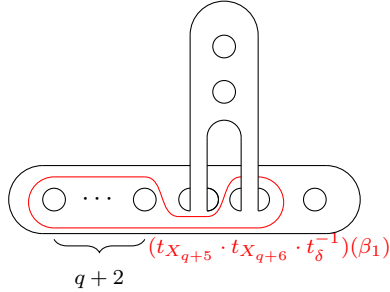
FIGURE 30. y_{q+5} and Y_{q+5} FIGURE 31. y_{q+6} and Y_{q+6} FIGURE 32. $(t_{X_{q+5}} \cdot t_{X_{q+6}} \cdot t_{\delta}^{-1})(\beta_1)$

We introduce a cancelling pair $\delta_2 \cdot \delta_2^{-1}$ and rearrange the word using Hurwitz moves and braid relations $\delta_2 \cdot \alpha_5 \cdot \delta_2 = \alpha_5 \cdot \delta_2 \cdot \alpha_5$ and $\delta_2 \cdot \gamma_5 \cdot \delta_2 = \gamma_5 \cdot \delta_2 \cdot \gamma_5$.

$$\begin{aligned}
& \beta_1 \beta_2 \cdot \delta_2^{-1} \cdot \delta_2 \cdot \alpha_1 \alpha_2 \alpha_3 \alpha_4 \alpha_5 \gamma_5 \delta_2 \gamma_5^{q+2} \alpha_6 \cdots \alpha_{q+6} \gamma_{q+6} \\
= & \beta_1 \beta_2 \delta_2^{-1} \cdot \alpha_1 \alpha_2 \alpha_3 \alpha_4 \cdot \underline{\delta_2 \alpha_5 \gamma_5 \delta_2 \gamma_5^{q+2}} \alpha_6 \cdots \alpha_{q+6} \gamma_{q+6} \\
= & \beta_1 \beta_2 \delta_2^{-1} \cdot \alpha_1 \alpha_2 \alpha_3 \alpha_4 \cdot \underline{\delta_2 \alpha_5 \delta_2 \gamma_5 \delta_2 \gamma_5^{q+1}} \alpha_6 \cdots \alpha_{q+6} \gamma_{q+6} \\
= & \beta_1 \beta_2 \delta_2^{-1} \cdot \alpha_1 \alpha_2 \alpha_3 \alpha_4 \cdot \underline{\alpha_5 \delta_2 \alpha_5 \gamma_5 \delta_2 \gamma_5^{q+1}} \alpha_6 \cdots \alpha_{q+6} \gamma_{q+6} \\
& \vdots \\
= & \beta_1 \beta_2 \delta_2^{-1} \cdot \alpha_1 \alpha_2 \alpha_3 \alpha_4 \cdot \underline{\alpha_5^{q+1} \delta_2 \alpha_5 \gamma_5 \delta_2 \gamma_5} \alpha_6 \cdots \alpha_{q+6} \gamma_{q+6} \\
= & \beta_1 \beta_2 \delta_2^{-1} \cdot \alpha_1 \alpha_2 \alpha_3 \alpha_4 \cdot \alpha_5^{q+2} \cdot (t_{\alpha_5}^{-1})(\delta_2) \cdot \gamma_5^2 \cdot (t_{\gamma_5}^{-1})(\delta_2) \cdot \alpha_6 \cdots \alpha_{q+6} \gamma_{q+6} \\
= & \beta_1 \beta_2 \delta_2^{-1} \cdot \underline{\alpha_1 \alpha_2 \alpha_3 \alpha_4 \alpha_5^{q+2} \gamma_5^2 \alpha_6 \cdots \alpha_{q+6} \gamma_{q+6}} \cdot (t_{\alpha_6}^{-1} \cdot t_{\gamma_5}^{-2} \cdot t_{\alpha_5}^{-1})(\delta_2) \cdot (t_{\alpha_6}^{-1} \cdot t_{\gamma_5}^{-1})(\delta_2)
\end{aligned}$$

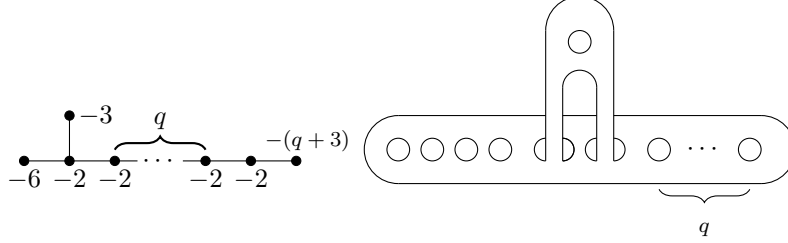
FIGURE 33. Resolution graph Γ_q and generic fiber Σ_{γ_q} for (i) family

The underlined part can be seen an embedding of the linear plumbing L_q in Figure 34: Let L_q be a linear plumbing and Σ_{L_q} be a generic fiber for X_{L_q} as in Figure 34. Then the monodromy for X_{L_q} can be written as

$$a_1 a_2 a_3 a_4 a_5^{q+2} b_5^2 a_6 \cdots a_{q+6} b_{q+6}$$

where a_i is simple closed curve in Σ_{L_q} enclosing i th hole and b_j is simple closed curve in Σ_{L_q} enclosing from the first to j th holes. Then there is obvious planar subsurface of Σ_{Γ_q} which is diffeomorphic to Σ_{L_q} so that the image of each curves are

$$\begin{aligned} a_i &\rightarrow \alpha_i & (i = 1, \dots, q+6) \\ b_j &\rightarrow \gamma_j & (j = 5, q+6) \end{aligned}$$

The linear plumbing L_q can be rationally blowdown and the relation in the mapping

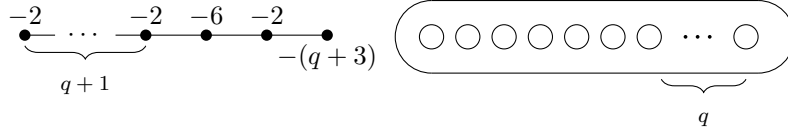
FIGURE 34. Linear plumbing L_q and the generic fiber Σ_{L_q} for X_{L_q}

class group of Σ_{L_q} for the rational blowdown was given by Endo-Mark-Van Horn-Morris in [EMV11].

$$a_1 a_2 a_3 a_4 a_5^{q+2} b_5^2 a_6 \cdots a_{q+6} b_{q+6} = y_1 y_2 \cdots y_{q+6}$$

Let Y_i a simple closed curve in Σ_{Γ_q} be the image of y_i in Σ_{L_q} which can be drawn as in Figure 35 to Figure 38. Then we have

$$\begin{aligned} & \beta_1 \beta_2 \delta_2^{-1} \alpha_1 \alpha_2 \alpha_3 \alpha_4 \alpha_5^{q+2} \gamma_5^2 \alpha_6 \cdots \alpha_{q+6} \gamma_{q+6} \cdot (t_{\alpha_6}^{-1} \cdot t_{\gamma_5}^{-2} \cdot t_{\alpha_5}^{-1})(\delta_2) \cdot (t_{\alpha_6}^{-1} \cdot t_{\gamma_5}^{-1})(\delta_2) \\ &= \beta_1 \beta_2 \delta_2^{-1} Y_1 \cdots Y_{q+5} \cdot Y_{q+6} \cdot (t_{\alpha_6}^{-1} \cdot t_{\gamma_5}^{-2} \cdot t_{\alpha_5}^{-1})(\delta_2) \cdot (t_{\alpha_6}^{-1} \cdot t_{\gamma_5}^{-1})(\delta_2) \\ &= \beta_1 \beta_2 \delta_2^{-1} Y_1 \cdots Y_{q+5} \cdot Y_{q+6} \cdot (t_{\alpha_6}^{-1} \cdot t_{\gamma_5}^{-1})(\delta_2) \cdot (t_{\alpha_6}^{-1} \cdot t_{\alpha_5})(\delta_2) \end{aligned}$$

Since

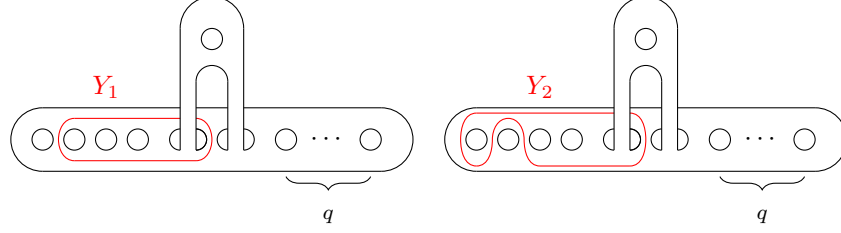
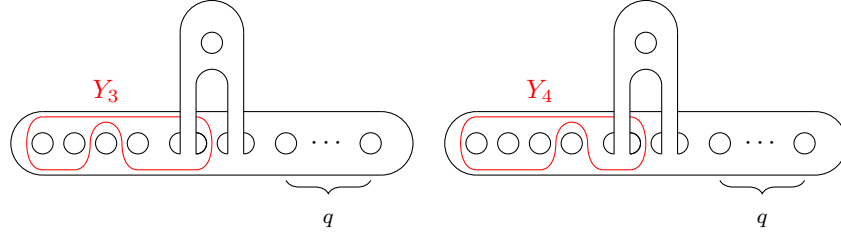
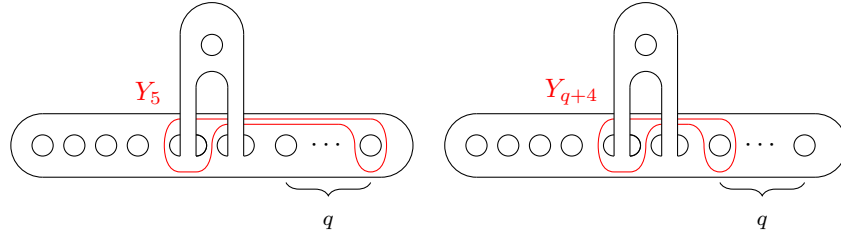
FIGURE 35. Y_1 and Y_2 in Σ_{Γ_q} FIGURE 36. Y_3 and Y_4 in Σ_{Γ_q} FIGURE 37. Y_i in Σ_{Γ_q} ($i = 5, \dots, q+4$)

$$\begin{aligned}
& (t_{\alpha_6}^{-1} \cdot t_{\gamma_5}^{-2} \cdot t_{\alpha_5}^{-1})(\delta_2) \cdot (t_{\alpha_6}^{-1} \cdot t_{\gamma_5}^{-1})(\delta_2) \\
&= \alpha_6^{-1} \gamma_5^{-2} \alpha_5^{-1} \delta_2 \alpha_5 \gamma_5 \delta_2 \gamma_5 \alpha_6 \\
&= \alpha_6^{-1} \gamma_5^{-2} \alpha_5^{-1} \delta_2 \alpha_5 \delta_2 \gamma_5 \delta_2 \alpha_6 \\
&= \alpha_6^{-1} \gamma_5^{-2} \alpha_5^{-1} \alpha_5 \delta_2 \alpha_5 \gamma_5 \delta_2 \alpha_6 \\
&= \alpha_6^{-1} \gamma_5^{-2} \delta_2 \gamma_5 \alpha_5 \delta_2 \alpha_5 \alpha_5^{-1} \alpha_6 \\
&= \alpha_6^{-1} \gamma_5^{-2} \delta_2 \gamma_5 \delta_2 \alpha_5 \delta_2 \alpha_5^{-1} \alpha_6 \\
&= \alpha_6^{-1} \gamma_5^{-2} \gamma_5 \delta_2 \gamma_5 \alpha_5 \delta_2 \alpha_5^{-1} \alpha_6 \\
&= \alpha_6^{-1} \gamma_5^{-1} \delta_2 \gamma_5 \alpha_6 \cdot \alpha_6^{-1} \alpha_5 \delta_2 \alpha_5^{-1} \alpha_6 \\
&= (t_{\alpha_6}^{-1} \cdot t_{\gamma_5}^{-1})(\delta_2) \cdot (t_{\alpha_6}^{-1} \cdot t_{\alpha_5})(\delta_2)
\end{aligned}$$

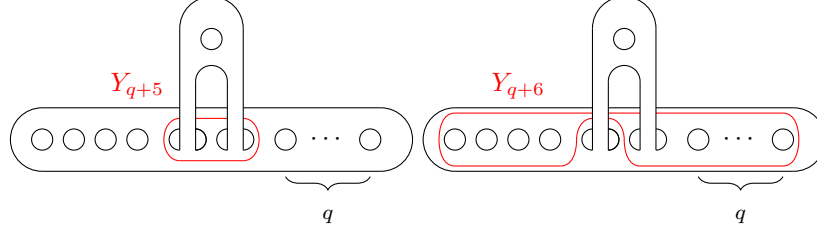
FIGURE 38. Y_{q+5} and Y_{q+6} in Σ_{Γ_q}

Note that $\beta_1 \cdot \beta_2 \cdot Y_{q+5} \cdot (t_{\alpha_6}^{-1} \cdot t_{\alpha_5})(\delta_2) = \delta_2 \cdot Z \cdot W$ for some simple closed curves W and Z in Σ_{Γ_q} due to the lantern relation. See Figure 39 for corresponding curves in a planar surface. By performing a lantern substitution and cancelling δ_2 with δ_2^{-1} after rearranging the word, we get a monodromy factorization W'_{Γ_q} whose length is $b_1(\Sigma_{\Gamma_q})$.

$$\begin{aligned}
& \beta_1 \beta_2 \delta_2^{-1} Y_1 \cdots Y_{q+5} \cdot Y_{q+6} \cdot (t_{\alpha_6}^{-1} \cdot t_{\alpha_5})(\delta_2) \cdot (t_{\alpha_6}^{-1} \cdot t_{\alpha_5})(\delta_2) \\
= & \beta_1 \beta_2 \delta_2^{-1} Y_1 \cdots Y_{q+4} \cdot t_{Y_{q+5}}(Y_{q+6}) \cdot (t_{Y_{q+5}} \cdot t_{\alpha_6}^{-1} \cdot t_{\alpha_5})(\delta_2) \cdot Y_{q+5} \cdot (t_{\alpha_6}^{-1} \cdot t_{\alpha_5})(\delta_2) \\
= & (t_{\delta_2}^{-1} \cdot t_{\beta_1})(Y_1) \cdot (t_{\delta_2}^{-1} \cdot t_{\beta_1})(Y_2) \cdots (t_{\delta_2}^{-1} \cdot t_{\beta_1})(Y_{q+4}) \cdot (t_{\delta_2}^{-1} \cdot t_{\beta_1} \cdot t_{Y_{q+5}})(Y_{q+6}) \\
& \cdot (t_{\delta_2}^{-1} \cdot t_{\beta_1} \cdot t_{Y_{q+5}} \cdot t_{\alpha_6}^{-1} \cdot t_{\alpha_5})(\delta_2) \cdot \delta_2^{-1} \cdot \beta_1 \cdot \beta_2 \cdot Y_{q+5} \cdot (t_{\alpha_6}^{-1} \cdot t_{\alpha_5})(\delta_2) \\
= & (t_{\delta_2}^{-1} \cdot t_{\beta_1})(Y_1) \cdot (t_{\delta_2}^{-1} \cdot t_{\beta_1})(Y_2) \cdots (t_{\delta_2}^{-1} \cdot t_{\beta_1})(Y_{q+4}) \cdot (t_{\delta_2}^{-1} \cdot t_{\beta_1} \cdot t_{Y_{q+5}})(Y_{q+6}) \\
& \cdot (t_{\delta_2}^{-1} \cdot t_{\beta_1} \cdot t_{Y_{q+5}} \cdot t_{\alpha_6}^{-1} \cdot t_{\alpha_5})(\delta_2) \cdot Z \cdot W
\end{aligned}$$

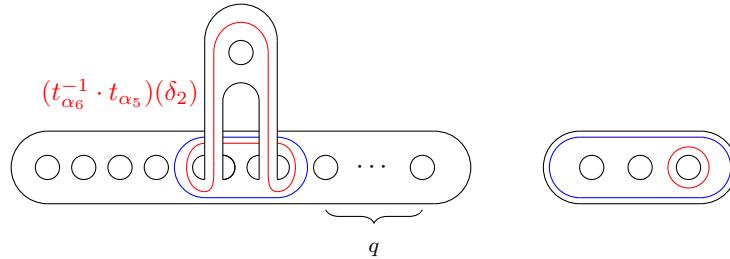

FIGURE 39. Corresponding curves for the lantern relation

REFERENCES

- [AO01] S. Akbulut and B. Ozbagci, *Lefschetz fibrations on compact Stein surfaces*, *Geom. Topol.* **5** (2001), 319–334.
- [BS11] M. Bhupal and A. Stipsicz, *Weighted homogeneous singularities and rational homology disk smoothings*, *Amer. J. Math.* **133** (2011), no. 5, 1259–1297.
- [BS13] ———, *Smoothings of singularities and symplectic topology*, *Deformations of surface singularities*, *Bolyai Soc. Math. Stud.*, vol. 23, János Bolyai Math. Soc., Budapest, 2013, pp. 57–97.
- [CP20] H. Choi and J. Park, *A Lefschetz fibration on minimal symplectic fillings of a quotient surface singularity*, *Math. Z.* **295** (2020), no. 3-4, 1183–1204.
- [EG10] H. Endo and Y. Gurtas, *Lantern relations and rational blowdowns*, *Proc. Amer. Math. Soc.* **138** (2010), no. 3, 1131–1142.
- [EMV11] H. Endo, T. Mark, and J. Van Horn-Morris, *Monodromy substitutions and rational blowdowns*, *J. Topol.* **4** (2011), no. 1, 227–253.
- [EO06] J. Etnyre and B. Ozbagci, *Open books and plumbings*, *Int. Math. Res. Not.* (2006), Art. ID 72710, 17.
- [FS97] R. Fintushel and R. Stern, *Rational blowdowns of smooth 4-manifolds*, *J. Differential Geom.* **46** (1997), no. 2, 181–235.
- [FS06] ———, *Double node neighborhoods and families of simply connected 4-manifolds with $b^+ = 1$* , *J. Amer. Math. Soc.* **19** (2006), no. 1, 171–180.
- [Ghi08] P. Ghiggini, *On tight contact structures with negative maximal twisting number on small Seifert manifolds*, *Algebr. Geom. Topol.* **8** (2008), no. 1, 381–396.
- [GM13] D. Gay and T. Mark, *Convex plumbings and Lefschetz fibrations*, *J. Symplectic Geom.* **11** (2013), no. 3, 363–375.
- [Gom98] R. Gompf, *Handlebody construction of Stein surfaces*, *Ann. of Math. (2)* **148** (1998), no. 2, 619–693.
- [LP01] A. Loi and R. Piergallini, *Compact Stein surfaces with boundary as branched covers of B^4* , *Invent. Math.* **143** (2001), no. 2, 325–348.
- [LP07] Y. Lee and J. Park, *A simply connected surface of general type with $p_g = 0$ and $K^2 = 2$* , *Invent. Math.* **170** (2007), no. 3, 483–505.
- [Par97] J. Park, *Seiberg-Witten invariants of generalised rational blow-downs*, *Bull. Austral. Math. Soc.* **56** (1997), no. 3, 363–384.
- [Par05] ———, *Simply connected symplectic 4-manifolds with $b_2^+ = 1$ and $c_1^2 = 2$* , *Invent. Math.* **159** (2005), no. 3, 657–667.
- [PPS09a] H. Park, J. Park, and D. Shin, *A simply connected surface of general type with $p_g = 0$ and $K^2 = 3$* , *Geom. Topol.* **13** (2009), no. 2, 743–767.
- [PPS09b] ———, *A simply connected surface of general type with $p_g = 0$ and $K^2 = 4$* , *Geom. Topol.* **13** (2009), no. 3, 1483–1494.
- [PSS05] J. Park, A. Stipsicz, and Z. Szabó, *Exotic smooth structures on $\mathbb{C}P^2 \# 5\overline{\mathbb{C}P^2}$* , *Math. Res. Lett.* **12** (2005), no. 5-6, 701–712.
- [SSW08] A. Stipsicz, Z. Szabó, and J. Wahl, *Rational blowdowns and smoothings of surface singularities*, *J. Topol.* **1** (2008), no. 2, 477–517.

SCHOOL OF MATHEMATICS, KOREA INSTITUTE FOR ADVANCED STUDY, 85 HOEGIRO, DONGDAEMUN-GU, SEOUL 02455, REPUBLIC OF KOREA
Email address: hakho@kias.re.kr

CENTER FOR QUANTUM STRUCTURES IN MODULES AND SPACES, SEOUL NATIONAL UNIVERSITY, SEOUL 08226, KOREA
Email address: hako85@snu.ac.kr