

CLASPER PRESENTATIONS OF HABEGGER-LIN'S ACTION ON STRING LINKS

YUKA KOTORII AND ATSUHIKO MIZUSAWA

ABSTRACT. Habegger and Lin gave a classification of the link-homotopy classes of links as the link-homotopy classes of string links modulo the actions of conjugations and partial conjugations for string links. In this paper, we calculated the actions of the partial conjugations and the conjugations explicitly for 4- and 5-component string links which gave classifications (presentations) of the link-homotopy classes of 4- and 5-component links. As an application, we can run Habegger and Lin's algorithm which determines whether given two links are link-homotopic or not for 4- and 5-component links.

1. INTRODUCTION

Milnor [15] introduced a concept of *link-homotopy* on links, which is a restricted homotopy (he called it homotopy) and a weaker equivalence relation than isotopy. The link-homotopy can be defined an equivalence relation generated by ambient isotopies and self-crossing changes. Here the self-crossing change is a crossing change between the same components. Milnor gave a complete classification of link-homotopy classes of links with 3- or fewer components by numerical invariants derived from the reduced link group. The reduced link group is a link-homotopy invariant, which is a certain quotient of the fundamental group of the complement of a link. Furthermore he [16] made the family of numerical invariants, called $\bar{\mu}$ -invariants, which is the extension of the numerical invariants in [15].

On the other hand, Levine [10] showed that the Milnor invariant is not enough to classify 4-component links completely. He [11] improved indeterminacy of $\bar{\mu}$ -invariants and then classified 4-component links. In order to classify more general cases, Habegger and Lin [3] defined a concept of the string link. They showed that the set of link-homotopy classes of string links has a group structure, which is the same as the group of link-homotopy classes of pure braids. They also represented the group as a subgroup of the automorphism group of the reduced free group. Then, they defined Milnor's μ -invariants for string links and classified the link-homotopy classes of string links completely by the μ -invariants. Furthermore they gave the Markov-type theorem for link-homotopy classes of string links. That is, the closures of two string links are link-homotopic if and only if these two can be related by a finite sequence of string links such that any two adjacent string links are either *conjugation* or *partial conjugation*. They gave an algorithm which

Date: January 10, 2023.

2020 Mathematics Subject Classification. 57K10, 57M05.

Key words and phrases. link-homotopy, string link, 4-component link, 5-component link, clasper, Milnor's $\bar{\mu}$ -invariant, algorithm.

decides whether the closures of two string links are link-homotopic or not and therefore gave an algorithm which decides whether two links are link-homotopic or not by using the actions of partial conjugations and the conjugations. On the other hand, the orbit space of the group action on the group of link-homotopy classes of string links generated by the partial conjugations and the conjugations is not represented exactly and we can not run the algorithm actually. After that, Hughes [5] showed that the partial conjugations generate the conjugations. Now it is enough to consider the partial conjugations only.

In some cases, the link-homotopy classes are described by using the *claspers* introduced by Habiro [4] and Gusarov [2] independently. For 2- and 3-component links, the standard forms of link-homotopy classes are given by using Hopf chords and Borromean chords (i.e. C_1 and C_2 -trees) in [19]. For the link-homotopy classes of string links, Yasuhara [20] gave a canonical form using claspers and showed the correspondence between the Milnor invariants and claspers (see also [14]). We also remark the works [18, 7] on HL-homotopy for handle-body links by using the clasper theory.

For 4-component link-homotopy classes, Levine [11] represented a link as commutator numbers and gave its ambiguity by calculating the automorphism group of the reduced group of the link. He then gave a classification of links. On the other hand, in our previous paper [8], we represented a link as the numbers of claspers in the clasper presentation and gave its ambiguity by calculating transformation between claspers. We then gave a geometric classification of links. However, in the proof of the result, we used Levine's result and it did not give an alternative proof of Levine's result.

The classification in the previous work [8] was applied to Habegger and Lin's algorithm since the calculations of the numbers of claspers correspond to the actions of the partial conjugations. We succeeded in running Habegger and Lin's algorithm for the 4-component case.

In the present paper, we apply the clasper theory to 4- and 5-component string links. We calculate the actions of the partial conjugations for string-links and explicitly classify 4- and 5-component links.

Theorem 1.1 (Theorems 3.2 and 3.5). *Let \mathcal{L}_n be the set of the link-homotopy classes of n -component links. For 4-component links,*

$$\mathcal{L}_4 = \mathbb{Z}^{12}/X_4,$$

where \mathbb{Z}^{12} is the set of ordered tuples of 12 integers

$$(y_{12}, y_{13}, y_{14}, y_{23}, y_{24}, y_{34}, y_{123}, y_{124}, y_{134}, y_{234}, y_{1234}, y_{1324})$$

and X_4 is the relations generated by the following relations in Table 3,

$$\{\bar{x}'_{12}, \bar{x}'_{13}, \bar{x}'_{21}, \bar{x}'_{23}, \bar{x}'_{31}\bar{x}'_{32}, \bar{x}'_{41}, \bar{x}'_{42}\}.$$

For 5-component links,

$$\mathcal{L}_5 = \mathbb{Z}^{36}/X_5$$

where \mathbb{Z}^{36} is the set of ordered tuples of 36 integers

$$(y_{12}, y_{13}, y_{14}, y_{15}, y_{23}, y_{24}, y_{25}, y_{34}, y_{35}, y_{45},$$

$$y_{123}, y_{124}, y_{134}, y_{125}, y_{135}, y_{145}, y_{234}, y_{235}, y_{245}, y_{345},$$

$$y_{1234}, y_{1324}, y_{1235}, y_{1245}, y_{1325}, y_{1345}, y_{1425}, y_{1435}, y_{2345}, y_{2435}, \\ y_{12345}, y_{12435}, y_{13245}, y_{13425}, y_{14235}, y_{14325})$$

and X_5 is the relations generated by the following relations in Table 3,

$$\{\bar{x}'_{12}, \bar{x}'_{13}, \bar{x}'_{14}, \bar{x}'_{21}, \bar{x}'_{23}, \bar{x}'_{24}, \bar{x}'_{31}, \bar{x}'_{32}, \bar{x}'_{34}, \bar{x}'_{41}, \bar{x}'_{42}, \bar{x}'_{43}, \bar{x}'_{51}, \bar{x}'_{52}, \bar{x}'_{53}\}.$$

Remark 1.2. The presentation of \mathcal{L}_4 in Theorem 1.1 coincides with the one in [8]. Thus the calculations in this paper give an alternative proof of the Levine's result.

Remark 1.3. The $\bar{\mu}$ -invariants for links are several quotients of the μ -invariants for string links. However, the $\bar{\mu}$ -invariants are not enough to classify the link-homotopy classes of links. So there is a question what is the appropriate quotient for links. In [20, 14], the relations between the Milnor's μ -invariants and the number of clasps of the canonical form are given for string links (see Subsection 2.3). Theorem 1.1 determines the quotient (the indeterminacy) of $\bar{\mu}$ -invariants for the 5-component case.

Remark 1.4. Graff [1] showed the presentation in Theorem 1.1 for 4-component case independently. (We also announced the result for 4-component links in [9].) He also gave a presentation for algebraically split 5-component links.

The calculations for Theorem 1.1 give the actions of the partial conjugations for the 4- and 5-component cases and they enable us to run Habegger and Lin's algorithm which determines whether given two link are link-homotopic or not. This recovers the algorithm in [8] for the 4-component case.

The organization of this paper is as follows. In Section 2, we review the clasper theory and define a canonical form of string links. In Section 3, we explicitly represent the orbit space of the group action on the group of link-homotopy classes of string links generated by the partial conjugations by using clasper presentations. In Section 4, we give an algorithm which decides whether given two 4- or 5-component links are link-homotopic or not in terms of clasper calculations. In Section 5, we test the results of the calculations in Section 3 by using the actions of the conjugations for the canonical forms.

ACKNOWLEDGEMENT

The authors thank Professor Akira Yasuhara for helpful comments. Y.K. is supported by JSPS KAKENHI, Grant-in-Aid for Early-Career Scientists Grant Number 20K14322, and by RIKEN iTHEMS Program and World Premier International Research Center Initiative (WPI) program, International Institute for Sustainability with Knotted Chiral Meta Matter (SKCM²).

2. PREPARATIONS

2.1. Markov-type theorem for link-homotopy classes of string links. In this section, we introduce Habegger and Lin's results in [3] for link-homotopy classes of string links. The string links were introduced to study link-homotopy classification of links. They gave a Markov-type theorem for the link-homotopy classes of links by using string links.

Let p_1, \dots, p_n be points lying in order on the x -axis on the interior of the unit disk D^2 . An n -string link $\sigma = \sigma_1 \cup \dots \cup \sigma_n$ is a proper embedding of n disjoint unit intervals I_1, \dots, I_n into $D^2 \times [0, 1]$ such that for each $i = 1, \dots, n$, $\sigma_i(0) = (p_i, 0)$ and $\sigma_i(1) = (p_i, 1)$, where σ_i is called the i -th string of the string link σ . Each string of a string link inherits an orientation from the usual orientation of the interval. Figure 1 left shows a planar projection of a 4-string link. Composition of n -string links is defined as follows. Let $\sigma = \sigma_1 \cup \dots \cup \sigma_n$ and $\sigma' = \sigma'_1 \cup \dots \cup \sigma'_n$ be two string links. Then the *composition* $\sigma\sigma' = (\sigma\sigma')_1 \cup \dots \cup (\sigma\sigma')_n$ of σ and σ' is the string link defined by $(\sigma\sigma')_i = h_1(\sigma_i) \cup h_2(\sigma'_i)$ for each $i = 1, \dots, n$, where $h_1, h_2 : D^2 \times [0, 1] \rightarrow D^2 \times [0, 1]$ are embeddings defined by

$$h_1(p, t) = (p, \frac{1}{2}t) \text{ and } h_2(p, t) = (p, \frac{1}{2} + \frac{1}{2}t)$$

for any $p \in D^2$ and $t \in [0, 1]$ (see Figure 1 right). The *trivial* n -string link 1_n consists of $\sigma(I_i) = p_i \times [0, 1]$ for each $i = 1, \dots, n$. It is known that for fixed n , the set of link-homotopy classes of n -string links forms a group with multiplication induced by the composition of string links and the link-homotopy class $[1_n]$ of 1_n as the identity. We denote it by $\mathcal{H}(n)$. Here the link-homotopy on string links is generated by ambient isotopies relative to endpoints of each strings and self-crossing changes.

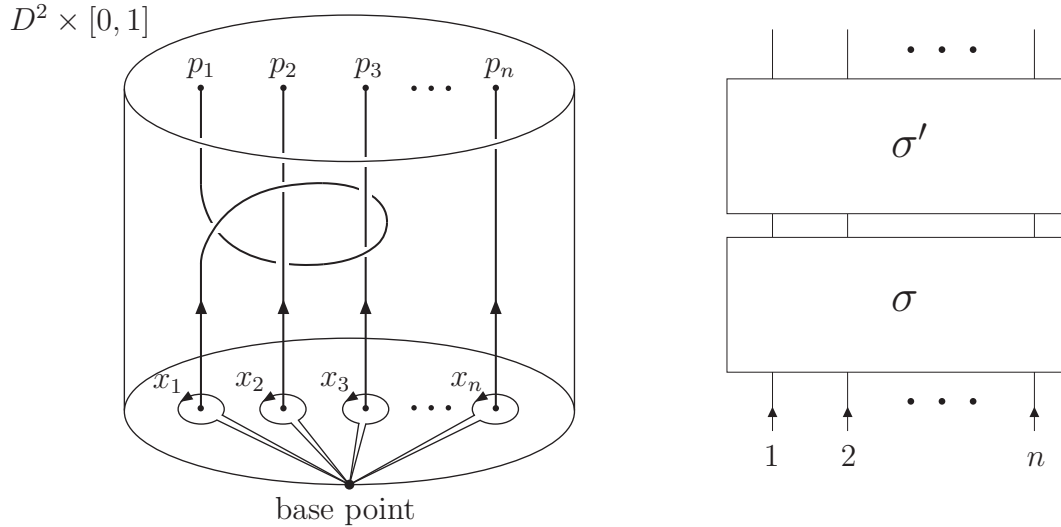

FIGURE 1. An n -string link and a composition.

Let $F(n)$ be a free group generated by x_1, \dots, x_n corresponding to the loops in Figure 1 left and $RF(n)$ the quotient group of $F(n)$ obtained by adding relations that each x_i commutes with all of its conjugations. It is known that for each i , any $\sigma \in \mathcal{H}(n)$ can be decomposed as $\theta_i g_i$ corresponding to the decomposition $\mathcal{H}(n) = \mathcal{H}(n-1) \rtimes RF_i(n-1)$ obtained from the map $\mathcal{H}(n) \rightarrow \mathcal{H}(n-1)$ given by omission of the i -th string, where $RF_i(n-1)$ is generated by the generators except for x_i . Figure 2 is an example.

Definition 2.1. Let $\sigma \in \mathcal{H}(n)$ be decomposed as $\theta_i g_i$. A *partial conjugation* of σ is an element of $\mathcal{H}(n)$ of the form $\theta_i g_i^h$ with $h \in RF_i(n-1)$, where $g_i^h = h g_i h^{-1}$.

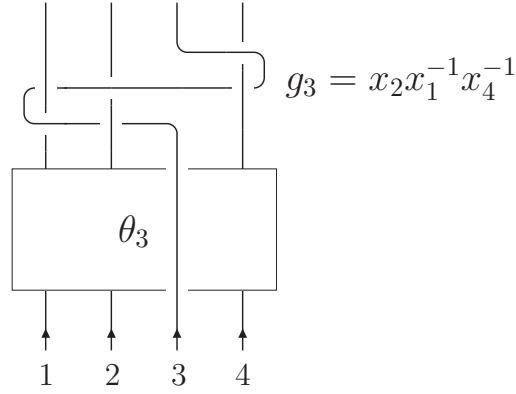

FIGURE 2. A decomposition.

Habegger and Lin gave the following Markov-type theorem for $\mathcal{H}(n)$, which is an improved version by Hughes's claim [5] that the partial conjugations generate the conjugations.

Theorem 2.2 ([3], [5]). *Let σ and σ' be in $\mathcal{H}(n)$. Then the closures of σ and σ' are link-homotopic if and only if there is a finite sequence $\sigma = \sigma_0, \sigma_1, \dots, \sigma_m = \sigma'$ of elements of $\mathcal{H}(n)$ such that σ_k is a partial conjugation of σ_{k-1} for each $k = 1, \dots, m$.*

The partial conjugation is induced by the following group action on $\mathcal{H}(n)$. The action $\Sigma \cdot \sigma$ of $\Sigma \in \mathcal{H}(2n)$ on $\sigma \in \mathcal{H}(n)$ is defined as illustrated in Figure 3. Here we forget the orientation of Σ once and give an orientation compatible with that of σ .

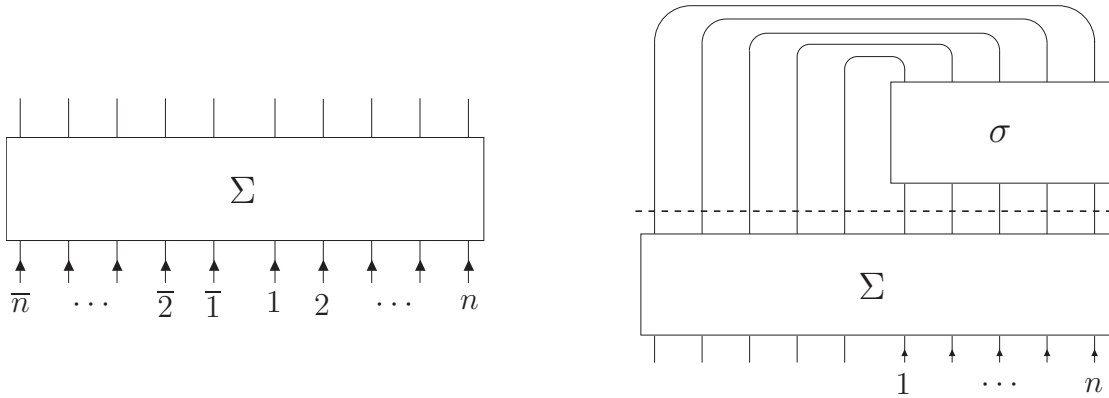
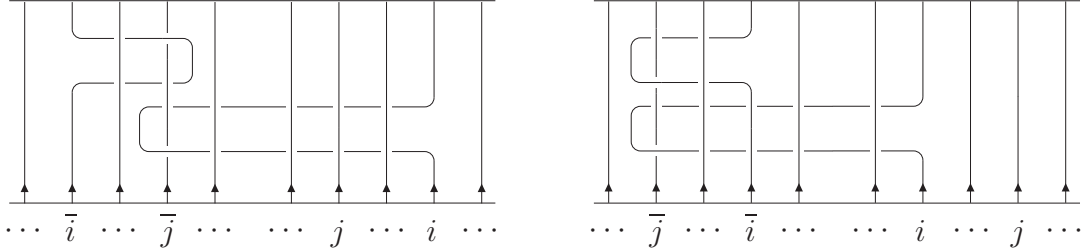

FIGURE 3. An action of $\mathcal{H}(2n)$ on $\mathcal{H}(n)$.

Let $(\bar{x}_j, \bar{x}_j)_i$ ($1 \leq i \neq j \leq n$) be a $2n$ -string link as illustrated in Figure 4. The left figure is the case $j < i$ and the right figure is the case $i < j$.

The action of a subgroup generated by $(\bar{x}_j, \bar{x}_j)_i$ ($1 \leq i \neq j \leq n$) on $\mathcal{H}(n)$ induces the partial conjugations. In fact, for a decomposed string link $\theta_i g_i$, we have $(\bar{x}_j, \bar{x}_j)_i \cdot \theta_i g_i = \theta_i g_i^{x_j}$. Therefore for any $(\bar{x}_j, \bar{x}_j)_i$ and string link σ , the action give a partial conjugation of σ and it is clear that any partial conjugation $\theta_i g_i^h$ of $\theta_i g_i$ is induced by $(\bar{x}_j, \bar{x}_j)_i$ for

FIGURE 4. Generators $(\bar{x}_i, \bar{x}_i)_j$ of partial conjugations.

$j = 1, \dots, i-1, i+1, \dots, n$. For the use in Section 5, we also introduce generators $(\bar{x}_j, x_j)_i$ of conjugations in $\mathcal{H}(2n)$ as illustrated in Figure 5.

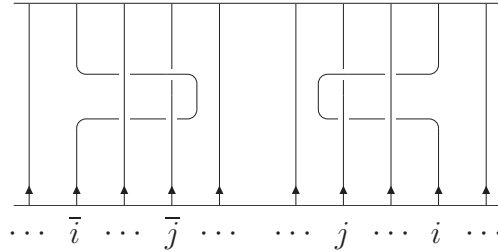
FIGURE 5. A generator $(\bar{x}_j, x_j)_i$ of conjugations.

2.2. Claspers. In this section, we introduce the clasper theory. For general definitions of claspers, we refer to Habiro [4].

Definition 2.3. ([4]) An embedded disk T in S^3 ($D^2 \times [0, 1]$) is said to be a *simple tree clasper* for a (string) link L if it satisfies the following three conditions:

- (1) The embedded disk T is decomposed into bands and disks as follows. Each band connects two distinct disks and each disk attaches either one or three bands, where a disk attached at exactly one band is called a *leaf*.
- (2) The embedded disk T intersects the (string) link L transversely so that each intersection is contained in the interior of the leaf.
- (3) Each leaf intersects the (string) link L at exactly one point.

In this paper, we call a simple tree clasper with $k+1$ leaves a C_k -tree. For simplicity, we express disks and bands as shown in Figure 6 and call the band an *edge*. Furthermore, we express a positive (or negative) half-twist of a band by a circle with plus (or minus, respectively) on the edge, see Figure 6.

For a given C_k -tree T for a (string) link L , there is a procedure to construct a framed link in a regular neighborhood of T . By surgery along the framed link, L is changed into another (string) link in S^3 ($D^2 \times I$), so we can regard the surgery as a local move on L as showed in Figure 7, called a C_k -move. We denote the obtained (string) link by L_T . We remark that a C_1 -move and a C_2 -move take a band sum of a Hopf link and a Borromean ring respectively. The C_k -equivalence is the equivalence relation on (string) links generated by C_k -moves and ambient isotopies (with fixing boundary).

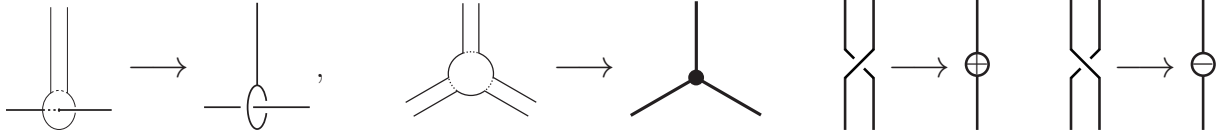

FIGURE 6. A band and a disk.

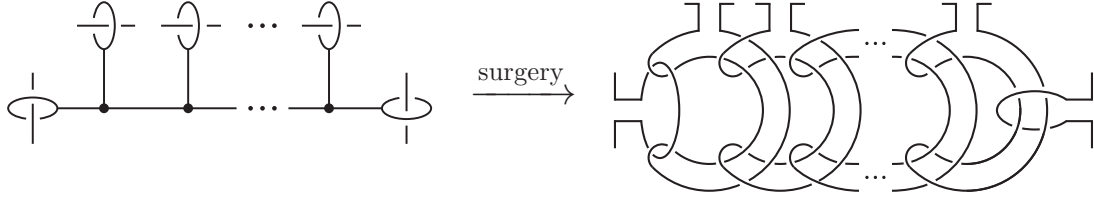

FIGURE 7. A C_k -tree and a local move.

The relation in Figure 8 holds up to ambient isotopy. Thus a crossing change can be expressed by a C_1 -tree.

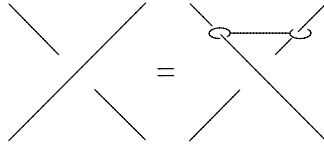

FIGURE 8. A crossing change and a C_1 -tree.

Since a surgery along C_k -trees corresponds to a band sum of a Hopf link or a Brunnian link, the following two lemmas hold.

Lemma 2.4. *If two leaves of a clasper are at the same component of a (string) link, the clasper vanishes up to link-homotopy.*

Lemma 2.5. *A crossing change between edges belonging to a C_k -tree is achieved by link-homotopy.*

We recall the relations of the claspers up to link-homotopy. We prepare the following lemma about local moves by claspers to transform shapes of (string) links up to link-homotopy (see also [8]).

Lemma 2.6 ([4, 13], [12] for (6)). *The following equations hold up to link-homotopy.*

- (1) *A crossing change between a C_i -tree and a C_j -tree makes a new C_{i+j+2} -tree as shown in Figure 9(1).*
- (2) *An exchange of leaves of a C_i -tree and a C_j -tree makes a new C_{i+j+1} -tree as shown in Figure 9(2).*
- (3) *A full-twist of an edge of a C_i -tree vanishes (Figure 9(3)).*
- (4) *A half-twist of an edge of a C_i -tree can be moved to another incident edge (Figure 9(4)).*
- (5) *If two C_i -trees are parallel where one of them is twisted and the other is non-twisted,*

then they are canceled (Figure 9(5)).

(6) The relation shown in Figure 9(6) holds. We refer the relation by an IHX relation.

(7) A crossing change between a C_k -tree and a link component makes a new C_{k+1} -tree as shown in Figure 9(7), where the bold arcs are link components, the new C_{k+1} -tree in the right-hand side is a copy of the C_k -tree with a new vertex and a new edge connecting the vertex with the new leaf intersecting with the component and the new C_{k+1} -tree has an extra minus half-twist.

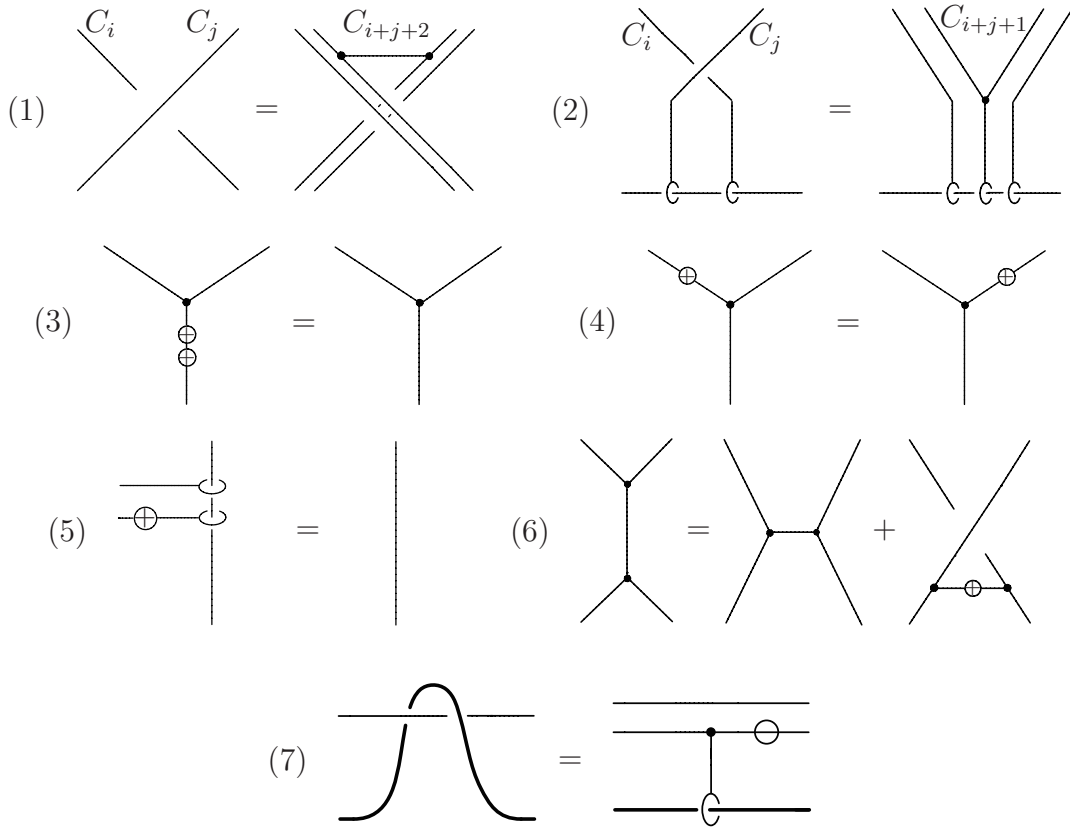

FIGURE 9. Equations up to link-homotopy.

Remark 2.7. In Lemma 2.6(1), if the C_i -tree and the C_j -tree in the left-hand side have leaves at the same component, the new C_{i+j+2} -tree in the right-hand side vanishes by Lemma 2.4. In Lemma 2.6(2), if the C_i -tree and the C_j -tree in the left-hand side have leaves at the same component other than the ones shown in Figure 9(2), the new C_{i+j+1} -tree in the right-hand side vanishes by Lemma 2.4. By Lemma 2.6(3), a positive half-twist and a negative one are equivalent up to link-homotopy. So we express those by just circles for simplicity.

2.3. Canonical form for link-homotopy classes of string links. In [3] Habegger and Lin essentially defined the Milnor invariant of string links and showed that this invariant decides the link-homotopy class of a string link. After that, in [20] Yasuhara gave a

canonical form for link-homotopy classes of string links by using claspers as follows. In this subsection, we introduce a link-homotopy classification of string links by claspers.

Let $\mathcal{I}_{k,n}$ be the set of sequences $i_1 i_2 \dots i_k$ of length k on $\{1, \dots, n\}$ such that $i_1 < \dots < i_k$ and S_k be the symmetric group of degree k . Let $\mathcal{J}_{k,n}$ be the set of all sequences $i_1 s(i_2 \dots i_k) i_{k+1}$ where $i_1 i_2 \dots i_{k+1}$ in $\mathcal{I}_{k+1,n}$ and s in S_{k-1} . For any J in $\mathcal{J}_{k,n}$, let T_J and T_J^{-1} be the C_k -trees for 1_n as illustrated in Figure 10, where b_J is the positive $(k-1)$ -braid defined by a permutation s such that every pair of strings crosses at most once, and each edges of the tree overpasses all strings of 1_n . Then we have the following canonical forms for string links.

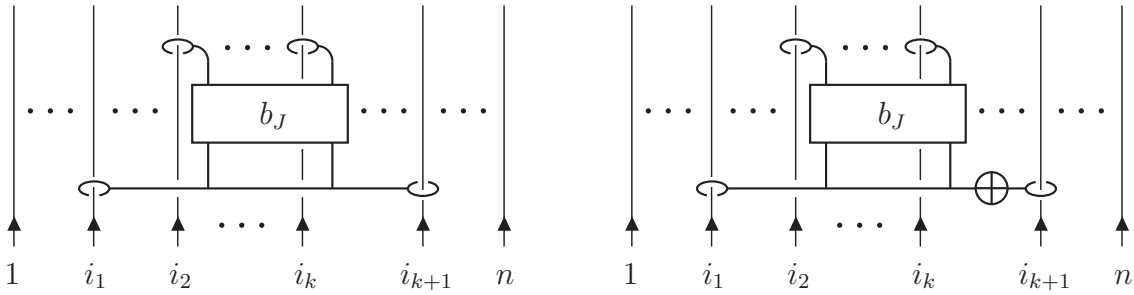

FIGURE 10. C_k -trees T_J and T_J^{-1} for 1_n .

Theorem 2.8 ([14], cf.[20]). *Any n -string link σ is link-homotopic to the string link $l_1 \cdot l_2 \cdot \dots \cdot l_{n-1}$, where*

$$l_k = \prod_{J \in \mathcal{J}_{k,n}} ((1_n)_{T_J^\varepsilon})^{|x_J|}, x_J = \begin{cases} \mu_\sigma(J) & \text{if } k = 1 \\ (-1)^{k-1} \{ \mu_\sigma(J) - \mu_{i_1 i_2 \dots i_{k-1}}(J) \} & \text{if } k \geq 2, \end{cases}$$

where μ is Milnor's invariant for string links, J in the product appears in the lexicographic order of the length 2 subsequence $i_1 i_{k+1}$ of J and if they are the same then in the lexicographic order of $s(i_2 \dots i_k)$, and $\varepsilon = 1$ if $x_J > 0$ and otherwise $\varepsilon = -1$.

Remark 2.9. In [13], when $k \geq 2$, the sign $(-1)^{k-1}$ of $\mu_L(M) - \mu_{i_1 i_2 \dots i_{k-1}}(M)$ seems to be missing (see [6]).

Remark 2.10. A product of p copies of a C_k -tree T_J^\pm for 1_n can be expressed by p parallel C_k -trees as illustrated in Figure 11 by Lemma 2.6(1), (2) and Lemma 2.4. We denote it by $T_J^{\pm p}$.

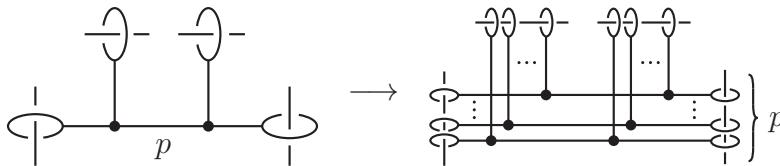

FIGURE 11. p parallel trees.

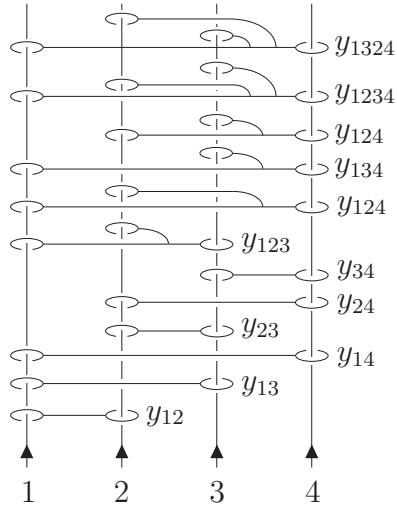

FIGURE 12. The canonical form for 4-component string links

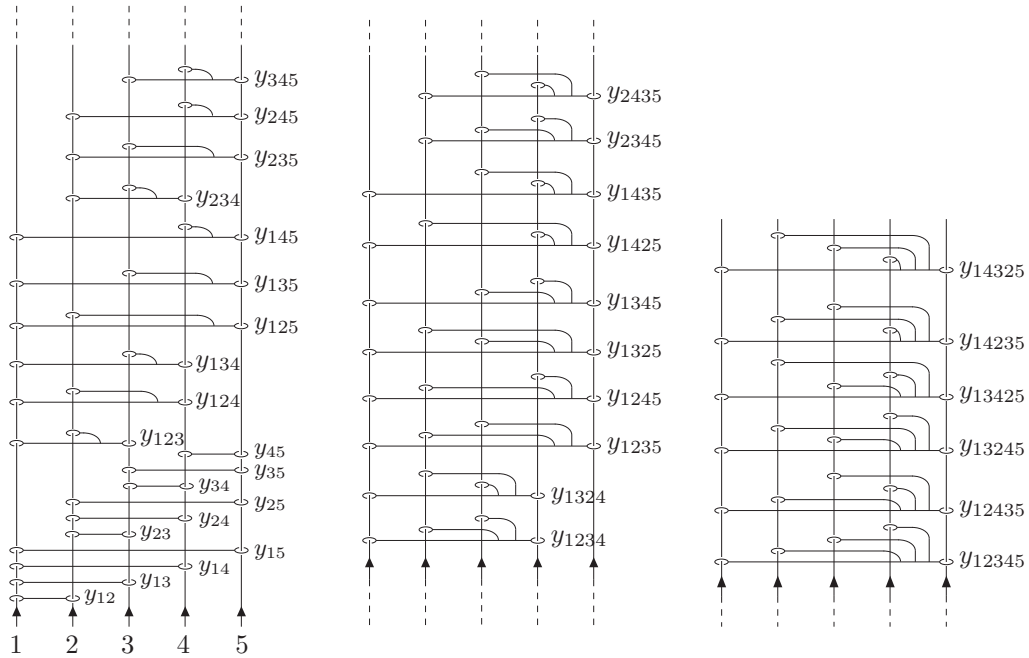

FIGURE 13. The canonical form of 5-component string links

3. CALCULATION OF PARTIAL CONJUGATIONS

In this section, we calculate the actions of the generators $(\bar{x}_i, \bar{x}_i)_j$ of partial conjugations for 4- and 5-component string links. We abbreviate $(\bar{x}_i, \bar{x}_i)_j$ to \bar{x}_{ij} . These results give presentations of the link-homotopy classes of 4- and 5-component links, see Theorems 3.2 and 3.5. In the 4-component case, the result gives an alternative proof of Levine's classification of the link-homotopy classes of 4-component links [11], see Remark 1.2.

Theorem 2.8 gives canonical forms for string links. The canonical forms for the 4- and 5-component cases are as in Figure 12 and 13 respectively. For the canonical form, the action of the partial conjugation \bar{x}_{ij} in Figure 4 is shown as in Figure 14 by using clasps, where b presents the canonical forms.

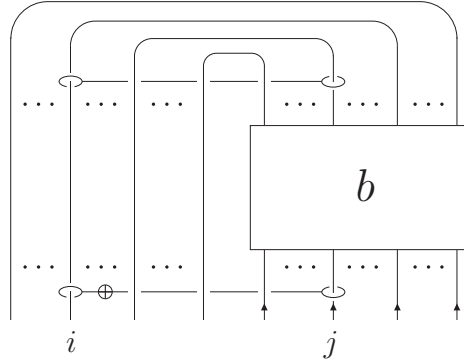

FIGURE 14. Partial conjugation \bar{x}_{ij} for the canonical form b

We transform the shape of Figure 14 back to the canonical form by using the relations in Section 2. Then the numbers of clasps change and the differences from the previous canonical form present the action of the partial conjugation \bar{x}_{ij} . For the generators $\{\bar{x}_{ij} \mid 1 \leq i, j \leq n, i \neq j\}$ of the partial conjugations for n -component string links, we call \bar{x}_{ij} a commutator of *degree 1* and $[\bar{x}_{ij}, C] = \bar{x}_{ij}C\bar{x}_{ij}^{-1}C^{-1}$ of *degree k* if C is a degree $k - 1$ commutator. In [11], Levine classified the link-homotopy classes of 4-component links. In the process, he simplified the result by using the commutators of the actions corresponding to the partial conjugations. In [3], Habegger and Lin pointed out that the actions of the k -th degree commutators commute up to those of $(k + 1)$ -th degree commutators and $(n - 1)$ -th degree commutators are identities for an n -component link. We calculate the actions of commutators $[\bar{x}_{ij}, \bar{x}_{kl}] = \bar{x}_{ij}\bar{x}_{kl}(\bar{x}_{ij})^{-1}(\bar{x}_{kl})^{-1}$ of the partial conjugations \bar{x}_{ij} for the 4- and 5-component cases and additionally $[\bar{x}_{ij}, [\bar{x}_{kl}, \bar{x}_{st}]]$ for the 5-component case. By using the action of the commutators, we modify the actions of \bar{x}_{ij} to simplified ones \bar{x}'_{ij} .

The results of this section are also on the second author's web page [17] as excel files and Mathematica files.

3.1. 4-component case. The results of the calculations of the actions of \bar{x}_{ij} are in Table 1, where the entries are the difference of the number of the clasps. Note that y_{ij} are invariants (which are equivalent to the linking numbers) and we omit them in the table. An example of a calculation for \bar{x}_{ij} is shown in Appendix A.

We also calculate the actions of the commutators $[\bar{x}_{ij}, \bar{x}_{kl}]$. The results are in Table 2. The other commutators which do not appear the table are equal to the identity or the ones in the table.

Remark 3.1. We have that, for the 4-component case, $[\bar{x}_{ik}, \bar{x}_{jk}] = [\bar{x}_{il}, \bar{x}_{jl}]$ where i, j, k, l are distinct integers in $\{1, 2, 3, 4\}$.

TABLE 1. Partial conjugations for 4-component string links

	\bar{x}_{12}	\bar{x}_{13}	\bar{x}_{14}	\bar{x}_{21}
y_{123}	y_{23}	$-y_{23}$	0	$-y_{13}$
y_{124}	y_{24}	0	$-y_{24}$	$-y_{14}$
y_{134}	0	y_{34}	$-y_{34}$	0
y_{234}	0	0	0	0
y_{1234}	$y_{234} - y_{24}y_{34}$ $+y_{23}y_{34}$	$y_{34} - y_{23}y_{34}$	$-y_{234} - y_{34}$ $+y_{24}y_{34}$	$-y_{134} + y_{14}y_{34}$ $-y_{13}y_{34} + y_{13}y_{14}$
y_{1324}	$-y_{23}y_{24}$	$-y_{234} + y_{23}y_{24}$	$y_{234} - y_{24}$	$-y_{13}y_{14}$
	\bar{x}_{23}	\bar{x}_{24}	\bar{x}_{31}	\bar{x}_{32}
y_{123}	y_{13}	0	y_{12}	$-y_{12}$
y_{124}	0	y_{14}	0	0
y_{134}	0	0	$-y_{14}$	0
y_{234}	y_{34}	$-y_{34}$	0	$-y_{24}$
y_{1234}	$y_{134} + y_{13}y_{34}$ $-y_{13}y_{14}$	$y_{14} - y_{14}y_{34}$	$-y_{14} - y_{12}y_{14}$	$-y_{124} + y_{12}y_{14}$
y_{1324}	$-y_{134} + y_{13}y_{14}$	$y_{134} - y_{14}$	$-y_{124} + y_{14}$	$y_{124} - y_{12}y_{14}$
	\bar{x}_{34}	\bar{x}_{41}	\bar{x}_{42}	\bar{x}_{43}
y_{123}	0	0	0	0
y_{124}	0	y_{12}	$-y_{12}$	0
y_{134}	y_{14}	y_{13}	0	$-y_{13}$
y_{234}	y_{24}	0	y_{23}	$-y_{23}$
y_{1234}	y_{124}	$y_{123} + y_{12}$ $-y_{13}y_{23} + y_{12}y_{23}$	$-y_{12}y_{23} - y_{12}$	$-y_{123} + y_{13}y_{23}$
y_{1324}	$-y_{14}y_{24}$	$-y_{123} + y_{13}$ $+y_{12}y_{13} - y_{12}y_{23}$ $+y_{13}y_{23}$	$y_{123} - y_{12}y_{13}$ $+y_{12}y_{23}$	$-y_{13}y_{23}$

TABLE 2. Commutators of \bar{x}_{ij} for 4-component string links

	$[\bar{x}_{21}, \bar{x}_{31}]$	$[\bar{x}_{21}, \bar{x}_{41}]$	$[\bar{x}_{31}, \bar{x}_{41}]$	$[\bar{x}_{12}, \bar{x}_{32}]$	$[\bar{x}_{12}, \bar{x}_{42}]$	$[\bar{x}_{13}, \bar{x}_{23}]$
y_{123}	0	0	0	0	0	0
y_{124}	0	0	0	0	0	0
y_{134}	0	0	0	0	0	0
y_{234}	0	0	0	0	0	0
y_{1234}	$-y_{14}$	0	y_{12}	0	$-y_{23}$	y_{34}
y_{1324}	y_{14}	y_{13}	0	y_{24}	y_{23}	0

We can simplify the relation \bar{x}_{ij} in Table 1 by using the commutators in Table 2 to the simplified relations \bar{x}'_{ij} . The actions of simplified partial conjugations \bar{x}'_{ij} are in Table 3.

For examples, the first two \bar{x}'_{ij} are obtained as follows,

$$\bar{x}'_{12} = [\bar{x}_{13}, \bar{x}_{23}]^{y_{24}-y_{23}} \circ [\bar{x}_{12}, \bar{x}_{32}]^{y_{23}} \circ \bar{x}_{12}, \quad \bar{x}'_{13} = [\bar{x}_{13}, \bar{x}_{23}]^{y_{23}} \circ [\bar{x}_{12}, \bar{x}_{32}]^{-y_{23}} \circ \bar{x}_{13}.$$

TABLE 3. Simplified partial conjugations \bar{x}'_{ij} for 4-component string links

	\bar{x}'_{12}	\bar{x}'_{13}	\bar{x}'_{14}	\bar{x}'_{21}	\bar{x}'_{23}	\bar{x}'_{24}
y_{123}	y_{23}	$-y_{23}$	0	$-y_{13}$	y_{13}	0
y_{124}	y_{24}	0	$-y_{24}$	$-y_{14}$	0	y_{14}
y_{134}	0	y_{34}	$-y_{34}$	0	0	0
y_{234}	0	0	0	0	y_{34}	$-y_{34}$
y_{1234}	y_{234}	0	$-y_{234}$	$-y_{134}$	y_{134}	0
y_{1324}	0	$-y_{234}$	y_{234}	0	$-y_{134}$	y_{134}
	\bar{x}'_{31}	\bar{x}'_{32}	\bar{x}'_{34}	\bar{x}'_{41}	\bar{x}'_{42}	\bar{x}'_{43}
y_{123}	y_{12}	$-y_{12}$	0	0	0	0
y_{124}	0	0	0	y_{12}	$-y_{12}$	0
y_{134}	$-y_{14}$	0	y_{14}	y_{13}	0	$-y_{13}$
y_{234}	0	$-y_{24}$	y_{24}	0	y_{23}	$-y_{23}$
y_{1234}	0	$-y_{124}$	y_{124}	y_{123}	0	$-y_{123}$
y_{1324}	$-y_{124}$	y_{124}	0	$-y_{123}$	y_{123}	0

We remark that, by replacing \bar{x}_{ij} to \bar{x}'_{ij} , the actions of the commutators in Table 2 do not change; $[\bar{x}_{ij}, \bar{x}_{kl}] = [\bar{x}'_{ij}, \bar{x}'_{kl}]$. Since $\prod_{j:j \neq i} \bar{x}'_{ij} = \text{id}$ holds for each $1 \leq i \leq 4$, we can erase 4 relations. We erase $\{\bar{x}'_{14}, \bar{x}'_{24}, \bar{x}'_{34}, \bar{x}'_{43}\}$. From the changes of y_{ijk} in Table 3, we see that no more relations can be erased. For example, if \bar{x}'_{12} is erased additionally, we can not change y_{124} by y_{24} by using the other \bar{x}'_{ij} . Thus the smallest number of the relations is 8. Note that, for the commutators in Table 2, we do not use \bar{x}_{ij} corresponding to the erased relations.

As a conclusion, we have a presentation of the link-homotopy classes of 4-component links.

Theorem 3.2. *The set \mathcal{L}_4 of link-homotopy classes of 4-component links has a presentation which is the set of 12-tuples of integers (i.e. the numbers of clasps) modulo the relations X_4 generated by the 8 relations $\{\bar{x}'_{12}, \bar{x}'_{13}, \bar{x}'_{21}, \bar{x}'_{23}, \bar{x}'_{31}, \bar{x}'_{32}, \bar{x}'_{41}, \bar{x}'_{42}\}$ in Table 3. Namely,*

$$\mathcal{L}_4 = \mathbb{Z}^{12}/X_4.$$

Remark 3.3. The functions of 12 integer variables which are invariants under the relations of Table 3 are invariants of \mathcal{L}_4 . Some examples are given in [11] and [8] for subsets of \mathcal{L}_4 .

3.2. 5-component case. We also calculate the actions of \bar{x}_{ij} for the 5-component case. In this subsection, some tables of the calculations are moved to Appendix B since they occupy spaces. The results of the actions of \bar{x}_{ij} are in the Table 7, where the entries

are the difference of the number of the claspers. Note that y_{ij} are invariants (which are equivalent to the linking numbers) and we omit them in the table.

We also calculate the actions of the commutators $[\bar{x}_{ij}, \bar{x}_{kl}]$ in Table 8 and $[\bar{x}_{ij}, [\bar{x}_{kl}, \bar{x}_{st}]]$ in Table 6. The results of $[\bar{x}_{ij}, \bar{x}_{kl}]$ can be simplified by using $[\bar{x}_{ij}, [\bar{x}_{kl}, \bar{x}_{st}]]$. The simplified first commutators $[\bar{x}_{ij}, \bar{x}_{kl}]'$ are shown in Table 5. Then we can simplify the actions of \bar{x}_{ij} by using $[\bar{x}_{ij}, \bar{x}_{kl}]'$ and $[\bar{x}_{ij}, [\bar{x}_{kl}, \bar{x}_{st}]]$. The simplified partial conjugations \bar{x}'_{ij} are shown in Table 4. For example,

$$\begin{aligned} \bar{x}'_{12} = & [\bar{x}_{34}, [\bar{x}_{14}, \bar{x}_{24}]]^{y_{25}y_{35}-y_{24}y_{34}-y_{23}y_{35}+y_{23}y_{34}} \circ [\bar{x}_{31}, [\bar{x}_{14}, \bar{x}_{24}]]^{-y_{23}y_{25}+y_{23}y_{24}} \\ & \circ [\bar{x}_{52}, [\bar{x}_{13}, \bar{x}_{23}]]^{y_{24}y_{25}-y_{23}y_{25}} \circ [\bar{x}_{43}, [\bar{x}_{13}, \bar{x}_{23}]]^{y_{24}+y_{24}y_{34}-y_{23}y_{34}+y_{23}y_{24}} \\ & \circ [\bar{x}_{41}, [\bar{x}_{13}, \bar{x}_{23}]]^{-y_{24}y_{25}+y_{23}y_{24}} \circ [\bar{x}_{54}, [\bar{x}_{12}, \bar{x}_{42}]]^{y_{145}} \\ & \circ [\bar{x}_{53}, [\bar{x}_{12}, \bar{x}_{32}]]^{y_{135}} \circ [\bar{x}_{42}, [\bar{x}_{12}, \bar{x}_{32}]]^{y_{23}y_{24}} \circ \bar{x}_{12}. \end{aligned}$$

In the equation we only use the commutators $[\bar{x}_{ij}, [\bar{x}_{kl}, \bar{x}_{st}]]$ of degree 3. However, in general, to simplify \bar{x}_{ij} , we also use modified commutators $[\bar{x}_{ij}, \bar{x}_{kl}]'$ of degree 2.

Remark 3.4. In Table 8, the other commutators $[\bar{x}_{ij}, \bar{x}_{kl}]$ which do not appear the table are equal to the identity or to the ones in the table up to the relations of the commutators $[\bar{x}_{ij}, [\bar{x}_{kl}, \bar{x}_{st}]]$ in Table 6. In Table 6, the other commutators $[\bar{x}_{ij}, [\bar{x}_{kl}, \bar{x}_{st}]]$ which do not appear the table are equal to the identity or the one in the table.

Remark that, when we replace \bar{x}_{ij} to \bar{x}'_{ij} , the actions of the commutators in Table 6 do not change; $[\bar{x}_{ij}, [\bar{x}_{kl}, \bar{x}_{st}]] = [\bar{x}'_{ij}, [\bar{x}'_{kl}, \bar{x}'_{st}]]$, and the commutators $[\bar{x}'_{ij}, \bar{x}'_{kl}]$ can be simplified to the corresponding actions in Table 5. Since, $\prod_{j:j \neq i} \bar{x}'_{ij} = \text{id}$ holds for each $1 \leq i \leq 5$, we can erase 5 relations. We erase $\{\bar{x}'_{15}, \bar{x}'_{25}, \bar{x}'_{35}, \bar{x}'_{45}, \bar{x}'_{54}\}$. From the changes of y_{ijk} in Table 4, we see that no more relations can be erased. For example, if \bar{x}'_{12} is erased additionally, we can not change y_{125} by y_{25} by using the other \bar{x}'_{ij} . Thus the smallest number of the relations is 15. Note that, for the commutators in Tables 8 and 6, we do not use \bar{x}_{ij} corresponding to the erased relations. Then we have a presentation of \mathcal{L}_5 .

Theorem 3.5. *The set \mathcal{L}_5 of link-homotopy classes of 5-component links has a presentation which is 36-tuples of integers (i.e. the numbers of claspers) modulo the relations X_5 generated by the 15 relations $\{\bar{x}'_{12}, \bar{x}'_{13}, \bar{x}'_{14}, \bar{x}'_{21}, \bar{x}'_{23}, \bar{x}'_{24}, \bar{x}'_{31}, \bar{x}'_{32}, \bar{x}'_{34}, \bar{x}'_{41}, \bar{x}'_{42}, \bar{x}'_{43}, \bar{x}'_{51}, \bar{x}'_{52}, \bar{x}'_{53}\}$ in Table 4. Namely,*

$$\mathcal{L}_5 = \mathbb{Z}^{36} / X_5.$$

Remark 3.6. The functions of 36 integer variables which are invariants under the relations of Table 4 are invariants of \mathcal{L}_5 .

3.3. Conjecture. In the both 4- and 5-component cases, $\prod_{j:j \neq i} \bar{x}_{ij} = \text{id}$ holds up to commutators for each $1 \leq i \leq n$. We can check the similar relations for the 2- and 3-component cases. We state a conjecture.

Conjecture 3.7. For n -component string links, $\prod_{j:j \neq i} \bar{x}_{ij} = \text{id}$ holds up to commutators for each $1 \leq i \leq n$. Thus the number of the generators of partial conjugations is reduced to $n(n-2)$.

TABLE 4. Simplified partial conjugations \bar{x}'_{ij} for 5-component string links

	\bar{x}'_{12}	\bar{x}'_{13}	\bar{x}'_{14}	\bar{x}'_{15}
y_{123}	y_{23}	$-y_{23}$	0	0
y_{124}	y_{24}	0	$-y_{24}$	0
y_{134}	0	y_{34}	$-y_{34}$	0
y_{125}	y_{25}	0	0	$-y_{25}$
y_{135}	0	y_{35}	0	$-y_{35}$
y_{145}	0	0	y_{45}	$-y_{45}$
y_{234}	0	0	0	0
y_{235}	0	0	0	0
y_{245}	0	0	0	0
y_{345}	0	0	0	0
y_{1234}	$y_{234} + y_{23}y_{34} - y_{24}y_{34}$	$-y_{23}y_{34}$	$-y_{234} + y_{24}y_{34}$	0
y_{1324}	$-y_{23}y_{24}$	$-y_{234} + y_{23}y_{24}$	y_{234}	0
y_{1235}	$y_{235} + y_{23}y_{35} - y_{25}y_{35}$	$-y_{23}y_{35}$	0	$-y_{235} + y_{25}y_{35}$
y_{1245}	$y_{245} + y_{24}y_{45} - y_{25}y_{45}$	0	$-y_{24}y_{45}$	$-y_{245} + y_{25}y_{45}$
y_{1325}	$-y_{23}y_{25}$	$-y_{235} + y_{23}y_{25}$	0	y_{235}
y_{1345}	0	$y_{345} + y_{34}y_{45} - y_{35}y_{45}$	$-y_{34}y_{45}$	$-y_{345} + y_{35}y_{45}$
y_{1425}	$-y_{24}y_{25}$	0	$-y_{245} + y_{24}y_{25}$	y_{245}
y_{1435}	0	$-y_{34}y_{35}$	$-y_{345} + y_{34}y_{35}$	y_{345}
y_{2345}	0	0	0	0
y_{2435}	0	0	0	0
y_{12345}	y_{2345}	0	0	$-y_{2345}$
y_{12435}	y_{2435}	0	0	$-y_{2435}$
y_{13245}	0	$-y_{2345} - y_{2435}$	0	$y_{2345} + y_{2435}$
y_{13425}	0	y_{2435}	0	$-y_{2435}$
y_{14235}	0	0	$-y_{2345} - y_{2435}$	$y_{2345} + y_{2435}$
y_{14325}	0	0	y_{2345}	$-y_{2345}$

4. ALGORITHM

In [3], Habegger and Lin showed that there is an algorithm which determines whether given two links are link-homotopic or not by using the actions of the partial conjugations.

	\bar{x}'_{21}	\bar{x}'_{23}	\bar{x}'_{24}	\bar{x}'_{25}
y_{123}	$-y_{13}$	y_{13}	0	0
y_{124}	$-y_{14}$	0	y_{14}	0
y_{134}	0	0	0	0
y_{125}	$-y_{15}$	0	0	y_{15}
y_{135}	0	0	0	0
y_{145}	0	0	0	0
y_{234}	0	y_{34}	$-y_{34}$	0
y_{235}	0	y_{35}	0	$-y_{35}$
y_{245}	0	0	y_{45}	$-y_{45}$
y_{345}	0	0	0	0
y_{1234}	$-y_{134} + y_{13}y_{14}$ $-y_{13}y_{34} + y_{14}y_{34}$	$y_{134} - y_{13}y_{14}$ $+y_{13}y_{34} - y_{14}y_{34}$	0	0
y_{1324}	$-y_{13}y_{14}$	$-y_{134} + y_{13}y_{14}$ $-y_{13}y_{34} + y_{14}y_{34}$	$y_{134} + y_{13}y_{34}$ $-y_{14}y_{34}$	0 0
y_{1235}	$-y_{135} + y_{13}y_{15}$ $-y_{13}y_{35} + y_{15}y_{35}$	$y_{135} - y_{13}y_{15}$ $+y_{13}y_{35} - y_{15}y_{35}$	0	0
y_{1245}	$-y_{145} + y_{14}y_{15}$ $-y_{14}y_{45} + y_{15}y_{45}$	0	$y_{145} - y_{14}y_{15}$ $+y_{14}y_{45} - y_{15}y_{45}$	0
y_{1325}	0	$-y_{135} + y_{13}y_{15}$ $-y_{13}y_{35} + y_{15}y_{35}$	0	$y_{135} - y_{13}y_{15}$ $+y_{13}y_{35} - y_{15}y_{35}$
y_{1345}	0	0	0	0
y_{1425}	0	0	$-y_{145} + y_{14}y_{15}$ $-y_{14}y_{45} + y_{15}y_{45}$	$y_{145} - y_{14}y_{15}$ $+y_{14}y_{45} - y_{15}y_{45}$
y_{1435}	0	0	0	0
y_{2345}	0	$y_{345} - y_{34}y_{35}$	$y_{34}y_{45}$	$-y_{345} + y_{34}y_{35}$ $-y_{34}y_{45}$
y_{2435}	0	$y_{34}y_{35}$	$-y_{345} - y_{34}y_{45}$ $+y_{35}y_{45}$	$y_{345} - y_{34}y_{35}$ $+y_{34}y_{45} - y_{35}y_{45}$
y_{12345}	$-y_{1345}$	y_{1345}	0	0
y_{12435}	$-y_{1435}$	0	y_{1435}	0
y_{13245}	0	$-y_{1345}$	y_{1345}	0
y_{13425}	0	0	$-y_{1345}$	y_{1345}
y_{14235}	0	y_{1435}	$-y_{1435}$	0
y_{14325}	0	$-y_{1435}$	0	y_{1435}

However, in the paper, the actions are not calculated explicitly. As an application of Section 3, we can run the algorithm.

Let L and L' be two n -component links. By cutting them at appropriate points, we have string links corresponding to them. Then we transform them to Meilhan and Yasuhara's canonical form [13]. Let Y_i (resp. Y'_i) be the sequence of the numbers of i -th degree claspers of L (resp. L'). For example, for 4-component links L (resp. L'),

	\bar{x}'_{31}	\bar{x}'_{32}	\bar{x}'_{34}	\bar{x}'_{35}
y_{123}	y_{12}	$-y_{12}$	0	0
y_{124}	0	0	0	0
y_{134}	$-y_{14}$	0	y_{14}	0
y_{125}	0	0	0	0
y_{135}	$-y_{15}$	0	0	y_{15}
y_{145}	0	0	0	0
y_{234}	0	$-y_{24}$	y_{24}	0
y_{235}	0	$-y_{25}$	0	y_{25}
y_{245}	0	0	0	0
y_{345}	0	0	y_{45}	$-y_{45}$
y_{1234}	$-y_{12}y_{14}$	$-y_{124} + y_{12}y_{14}$ $-y_{12}y_{24} + y_{14}y_{24}$	$y_{124} + y_{12}y_{24}$ $-y_{14}y_{24}$	0
y_{1324}	$-y_{124} + y_{12}y_{14}$ $-y_{12}y_{24} + y_{14}y_{24}$	$y_{124} - y_{12}y_{14}$ $+y_{12}y_{24} - y_{14}y_{24}$	0	0
y_{1235}	0	$-y_{125} + y_{12}y_{15}$ $-y_{12}y_{25} + y_{15}y_{25}$	0	$y_{125} - y_{12}y_{15}$ $+y_{12}y_{25} - y_{15}y_{25}$
y_{1245}	0	0	0	0
y_{1325}	$-y_{125} + y_{12}y_{15}$ $-y_{12}y_{25} + y_{15}y_{25}$	$y_{125} - y_{12}y_{15}$ $+y_{12}y_{25} - y_{15}y_{25}$	0	0
y_{1345}	$-y_{145} + y_{14}y_{15}$ $-y_{14}y_{45} + y_{15}y_{45}$	0	$y_{145} - y_{14}y_{15}$ $+y_{14}y_{45} - y_{15}y_{45}$	0
y_{1425}	0	0	0	0
y_{1435}	0	0	$-y_{145} + y_{14}y_{15}$ $-y_{14}y_{45} + y_{15}y_{45}$	$y_{145} - y_{14}y_{15}$ $+y_{14}y_{45} - y_{15}y_{45}$
y_{2345}	0	$-y_{245}$	$y_{245} - y_{25}y_{45}$	$y_{25}y_{45}$
y_{2435}	0	$y_{24}y_{25}$	$-y_{245} - y_{24}y_{45}$ $+y_{25}y_{45}$	$y_{245} - y_{24}y_{25}$ $+y_{24}y_{45} - y_{25}y_{45}$
y_{12345}	0	$-y_{1245}$	y_{1245}	0
y_{12435}	0	0	$-y_{1245}$	y_{1245}
y_{13245}	$-y_{1245}$	y_{1245}	0	0
y_{13425}	$-y_{1425}$	0	y_{1425}	0
y_{14235}	0	$-y_{1425}$	0	y_{1425}
y_{14325}	0	y_{1425}	$-y_{1425}$	0

$Y_1 = (y_{12}, y_{13}, y_{14}, y_{23}, y_{24}, y_{34})$, $Y_2 = (y_{123}, y_{124}, y_{134}, y_{234})$ and $Y_3 = (y_{1234}, y_{1324})$ (resp. $Y'_1 = (y'_{12}, y'_{13}, y'_{14}, y'_{23}, y'_{24}, y'_{34})$, $Y'_2 = (y'_{123}, y'_{124}, y'_{134}, y'_{234})$ and $Y'_3 = (y'_{1234}, y'_{1324})$). Then, for the links $L = (Y_1, Y_2, \dots, Y_{n-1})$ and $L' = (Y'_1, Y'_2, \dots, Y'_{n-1})$, Habegger and Lin's algorithm is translated in our notations as follows. We will change Y_i to Y'_i in order. Note that the partial conjugations do not change the numbers y_{ij} of C_1 -trees (they are invariants; the linking numbers).

	\bar{x}'_{41}	\bar{x}'_{42}	\bar{x}'_{43}	\bar{x}'_{45}
y_{123}	0	0	0	0
y_{124}	y_{12}	$-y_{12}$	0	0
y_{134}	y_{13}	0	$-y_{13}$	0
y_{125}	0	0	0	0
y_{135}	0	0	0	0
y_{145}	$-y_{15}$	0	0	y_{15}
y_{234}	0	y_{23}	$-y_{23}$	0
y_{235}	0	0	0	0
y_{245}	0	$-y_{25}$	0	y_{25}
y_{345}	0	0	$-y_{35}$	y_{35}
y_{1234}	$y_{123} + y_{12}y_{23}$ $-y_{13}y_{23}$	0	$-y_{123} - y_{12}y_{23}$ $+y_{13}y_{23}$	0
y_{1324}	$-y_{123} + y_{12}y_{13}$ $-y_{12}y_{23} + y_{13}y_{23}$	$y_{123} - y_{12}y_{13}$ $+y_{12}y_{23} - y_{13}y_{23}$	0	0
y_{1235}	0	0	0	0
y_{1245}	0	$-y_{125} + y_{12}y_{15}$ $-y_{12}y_{25} + y_{15}y_{25}$	0	$y_{125} - y_{12}y_{15}$ $+y_{12}y_{25} - y_{15}y_{25}$
y_{1325}	0	0	0	0
y_{1345}	0	0	$-y_{135} + y_{13}y_{15}$ $-y_{13}y_{35} + y_{15}y_{35}$	$y_{135} - y_{13}y_{15}$ $+y_{13}y_{35} - y_{15}y_{35}$
y_{1425}	$-y_{125} + y_{12}y_{15}$ $-y_{12}y_{25} + y_{15}y_{25}$	$y_{125} - y_{12}y_{15}$ $+y_{12}y_{25} - y_{15}y_{25}$	0	0
y_{1435}	$-y_{135} + y_{13}y_{15}$ $-y_{13}y_{35} + y_{15}y_{35}$	0	$y_{135} - y_{13}y_{15}$ $+y_{13}y_{35} - y_{15}y_{35}$	0
y_{2345}	0	$y_{23}y_{25}$	$-y_{235} - y_{23}y_{35}$ $+y_{25}y_{35}$	$y_{235} - y_{23}y_{25}$ $+y_{23}y_{35} - y_{25}y_{35}$
y_{2435}	0	$-y_{235}$	$y_{235} - y_{25}y_{35}$	$y_{25}y_{35}$
y_{12345}	0	0	$-y_{1235}$	y_{1235}
y_{12435}	0	$-y_{1235}$	y_{1235}	0
y_{13245}	0	$-y_{1325}$	0	y_{1325}
y_{13425}	0	y_{1325}	$-y_{1325}$	0
y_{14235}	$-y_{1235}$	y_{1235}	0	0
y_{14325}	$-y_{1325}$	0	y_{1325}	0

1. Check $Y_1 = Y'_1$. If it holds, then go to Step 2, otherwise L and L' are not link-homotopic.
2. Let \mathcal{S}_1 be the set of partial conjugations. Find a relation $\Psi_1 \in \mathcal{S}_1$ which satisfies $\Psi_1(Y_2) = Y'_2$ for L . If there is such a relation, then replace

$$L = (Y_1, Y_2, Y_3, Y_4, \dots)$$

	\bar{x}'_{51}	\bar{x}'_{52}	\bar{x}'_{53}	\bar{x}'_{54}
y_{123}	0	0	0	0
y_{124}	0	0	0	0
y_{134}	0	0	0	0
y_{125}	y_{12}	$-y_{12}$	0	0
y_{135}	y_{13}	0	$-y_{13}$	0
y_{145}	y_{14}	0	0	$-y_{14}$
y_{234}	0	0	0	0
y_{235}	0	y_{23}	$-y_{23}$	0
y_{245}	0	y_{24}	0	$-y_{24}$
y_{345}	0	0	y_{34}	$-y_{34}$
y_{1234}	0	0	0	0
y_{1324}	0	0	0	0
y_{1235}	$y_{123} - y_{12}y_{13}$ $+y_{12}y_{23} - y_{13}y_{23}$	0	$-y_{123} + y_{12}y_{13}$ $-y_{12}y_{23} + y_{13}y_{23}$	0
y_{1245}	$y_{124} - y_{12}y_{14}$ $+y_{12}y_{24} - y_{14}y_{24}$	0	0	$-y_{124} + y_{12}y_{14}$ $-y_{12}y_{24} + y_{14}y_{24}$
y_{1325}	$-y_{123} - y_{12}y_{23}$ $+y_{13}y_{23}$	$y_{123} + y_{12}y_{23}$ $-y_{13}y_{23}$	0	0
y_{1345}	$y_{134} - y_{13}y_{14}$ $+y_{13}y_{34} - y_{14}y_{34}$	0	0	$-y_{134} + y_{13}y_{14}$ $-y_{13}y_{34} + y_{14}y_{34}$
y_{1425}	$-y_{124} - y_{12}y_{24}$ $+y_{14}y_{24}$	$y_{124} + y_{12}y_{24}$ $-y_{14}y_{24}$	0	0
y_{1435}	$-y_{134} - y_{13}y_{34}$ $+y_{14}y_{34}$	0	$y_{134} + y_{13}y_{34}$ $-y_{14}y_{34}$	0
y_{2345}	0	$y_{234} - y_{23}y_{24}$	$y_{23}y_{34}$	$-y_{234} + y_{23}y_{24}$ $-y_{23}y_{34}$
y_{2435}	0	$-y_{234}$	$y_{234} - y_{24}y_{34}$	$y_{24}y_{34}$
y_{12345}	y_{1234}	0	0	$-y_{1234}$
y_{12435}	$-y_{1234} - y_{1324}$	0	$y_{1234} + y_{1324}$	0
y_{13245}	y_{1324}	0	0	$-y_{1324}$
y_{13425}	$-y_{1234} - y_{1324}$	$y_{1234} + y_{1324}$	0	0
y_{14235}	y_{1324}	0	$-y_{1324}$	0
y_{14325}	y_{1234}	$-y_{1234}$	0	0

to

$$\begin{aligned}
L_1 &= \Psi_1(L) \\
&= (Y_1, \Psi_1(Y_2), \Psi_1(Y_3), \Psi_1(Y_4), \dots) \\
&= (Y'_1, Y'_2, \Psi_1(Y_3), \Psi_1(Y_4), \dots)
\end{aligned}$$

and go to Step 3, otherwise L and L' are not link-homotopic.

TABLE 5. Modified commutators of \bar{x}_{ij} for 5-component string links

	$[\bar{x}_{21}, \bar{x}_{31}]'$	$[\bar{x}_{21}, \bar{x}_{41}]'$	$[\bar{x}_{21}, \bar{x}_{51}]'$	$[\bar{x}_{31}, \bar{x}_{41}]'$	$[\bar{x}_{31}, \bar{x}_{51}]'$
y_{1234}	y_{14}	0	0	$-y_{12}$	0
y_{1324}	$-y_{14}$	$-y_{13}$	0	0	0
y_{1235}	y_{15}	0	0	0	$-y_{12}$
y_{1245}	0	y_{15}	0	0	0
y_{1325}	$-y_{15}$	0	$-y_{13}$	0	0
y_{1345}	0	0	0	y_{15}	0
y_{1425}	0	$-y_{15}$	$-y_{14}$	0	0
y_{1435}	0	0	0	$-y_{15}$	$-y_{14}$
y_{2345}	0	0	0	0	0
y_{2435}	0	0	0	0	0
y_{12345}	y_{145}	0	0	0	0
y_{12435}	0	y_{135}	0	0	$-y_{124}$
y_{13245}	$-y_{145}$	0	0	0	0
y_{13425}	0	0	$-y_{134}$	y_{125}	0
y_{14235}	0	$-y_{135}$	0	0	y_{124}
y_{14325}	0	0	y_{134}	$-y_{125}$	0
	$[\bar{x}_{41}, \bar{x}_{51}]'$	$[\bar{x}_{12}, \bar{x}_{32}]'$	$[\bar{x}_{12}, \bar{x}_{42}]'$	$[\bar{x}_{12}, \bar{x}_{52}]'$	$[\bar{x}_{32}, \bar{x}_{42}]'$
y_{1234}	0	0	y_{23}	0	y_{12}
y_{1324}	0	$-y_{24}$	$-y_{23}$	0	0
y_{1235}	0	0	0	y_{23}	0
y_{1245}	$-y_{12}$	0	0	y_{24}	0
y_{1325}	0	$-y_{25}$	0	$-y_{23}$	0
y_{1345}	$-y_{13}$	0	0	0	0
y_{1425}	0	0	$-y_{25}$	$-y_{24}$	0
y_{1435}	0	0	0	0	0
y_{2345}	0	0	0	0	y_{25}
y_{2435}	0	0	0	0	$-y_{25}$
y_{12345}	$-y_{123}$	0	0	y_{234}	y_{125}
y_{12435}	0	0	0	$-y_{234}$	$-y_{125}$
y_{13245}	y_{123}	$-y_{245}$	0	0	0
y_{13425}	0	0	0	$-y_{234}$	$-y_{125}$
y_{14235}	0	0	$-y_{235}$	0	0
y_{14325}	0	0	0	y_{234}	y_{125}

3. Let \mathcal{S}_2 be the set of the partial conjugations which do not change Y'_2 of L_1 . Find a relation $\Psi_2 \in \mathcal{S}_2$ which satisfies $\Psi_2 \circ \Psi_1(Y_3) = Y'_3$ for L_1 . If there is such a relation, then replace

$$L_1 = (Y'_1, Y'_2, \Psi_1(Y_3), \Psi_1(Y_4), \dots)$$

	$[\bar{x}_{32}, \bar{x}_{52}]'$	$[\bar{x}_{42}, \bar{x}_{52}]'$	$[\bar{x}_{13}, \bar{x}_{23}]'$	$[\bar{x}_{13}, \bar{x}_{43}]'$	$[\bar{x}_{13}, \bar{x}_{53}]'$
y_{1234}	0	0	$-y_{34}$	$-y_{23}$	0
y_{1324}	0	0	0	y_{23}	0
y_{1235}	y_{12}	0	$-y_{35}$	0	$-y_{23}$
y_{1245}	0	y_{12}	0	0	0
y_{1325}	0	0	0	0	y_{23}
y_{1345}	0	0	0	0	y_{34}
y_{1425}	0	0	0	0	0
y_{1435}	0	0	0	$-y_{35}$	$-y_{34}$
y_{2345}	0	$-y_{23}$	0	0	0
y_{2435}	$-y_{24}$	0	0	0	0
y_{12345}	0	0	$-y_{345}$	0	0
y_{12435}	0	0	0	0	y_{234}
y_{13245}	0	$-y_{123}$	0	0	$-y_{234}$
y_{13425}	0	0	0	0	y_{234}
y_{14235}	$-y_{124}$	0	0	0	$-y_{234}$
y_{14325}	0	0	0	y_{235}	0
	$[\bar{x}_{23}, \bar{x}_{43}]'$	$[\bar{x}_{23}, \bar{x}_{53}]'$	$[\bar{x}_{14}, \bar{x}_{24}]'$	$[\bar{x}_{14}, \bar{x}_{34}]'$	$[\bar{x}_{24}, \bar{x}_{34}]'$
y_{1234}	0	0	y_{34}	0	$-y_{14}$
y_{1324}	y_{13}	0	0	y_{24}	y_{14}
y_{1235}	0	0	0	0	0
y_{1245}	0	0	$-y_{45}$	0	0
y_{1325}	0	y_{13}	0	0	0
y_{1345}	0	0	0	$-y_{45}$	0
y_{1425}	0	0	0	0	0
y_{1435}	0	0	0	0	0
y_{2345}	0	y_{34}	0	0	$-y_{45}$
y_{2435}	$-y_{35}$	$-y_{34}$	0	0	0
y_{12345}	0	0	0	0	$-y_{145}$
y_{12435}	$-y_{135}$	0	y_{345}	0	0
y_{13245}	y_{135}	0	0	0	y_{145}
y_{13425}	$-y_{135}$	0	0	y_{245}	0
y_{14235}	y_{135}	0	0	0	y_{145}
y_{14325}	0	$-y_{134}$	0	0	$-y_{145}$

to

$$\begin{aligned}
L_2 &= \Psi_2(L_1) \\
&= (Y'_1, Y'_2, \Psi_2 \circ \Psi_1(Y_3), \Psi_2 \circ \Psi_1(Y_4), \dots) \\
&= (Y'_1, Y'_2, Y'_3, \Psi_2 \circ \Psi_1(Y_4), \dots)
\end{aligned}$$

and go to Step 4, otherwise L and L' are not link-homotopic.

TABLE 6. 3-commutators for 5-component string links

	$[\bar{x}_{41}, [\bar{x}_{21}, \bar{x}_{31}]]$	$[\bar{x}_{43}, [\bar{x}_{21}, \bar{x}_{31}]]$	$[\bar{x}_{52}, [\bar{x}_{21}, \bar{x}_{31}]]$	$[\bar{x}_{53}, [\bar{x}_{21}, \bar{x}_{31}]]$	$[\bar{x}_{52}, [\bar{x}_{21}, \bar{x}_{41}]]$
y_{12345}	y_{15}	$-y_{15}$	0	0	0
y_{12435}	0	y_{15}	0	0	0
y_{13245}	$-y_{15}$	0	0	0	0
y_{13425}	0	y_{15}	0	0	$-y_{13}$
y_{14235}	$-y_{15}$	0	0	y_{14}	0
y_{14325}	y_{15}	$-y_{15}$	$-y_{14}$	0	0
	$[\bar{x}_{54}, [\bar{x}_{21}, \bar{x}_{41}]]$	$[\bar{x}_{53}, [\bar{x}_{31}, \bar{x}_{41}]]$	$[\bar{x}_{54}, [\bar{x}_{31}, \bar{x}_{41}]]$	$[\bar{x}_{41}, [\bar{x}_{12}, \bar{x}_{32}]]$	$[\bar{x}_{42}, [\bar{x}_{12}, \bar{x}_{32}]]$
y_{12345}	0	0	y_{12}	0	0
y_{12435}	0	$-y_{12}$	0	0	0
y_{13245}	y_{13}	0	0	0	0
y_{13425}	0	0	0	0	$-y_{25}$
y_{14235}	0	0	0	0	0
y_{14325}	0	0	0	y_{25}	0
	$[\bar{x}_{52}, [\bar{x}_{12}, \bar{x}_{32}]]$	$[\bar{x}_{53}, [\bar{x}_{12}, \bar{x}_{32}]]$	$[\bar{x}_{52}, [\bar{x}_{12}, \bar{x}_{42}]]$	$[\bar{x}_{54}, [\bar{x}_{12}, \bar{x}_{42}]]$	$[\bar{x}_{41}, [\bar{x}_{13}, \bar{x}_{23}]]$
y_{12345}	0	0	0	$-y_{23}$	0
y_{12435}	0	$-y_{24}$	0	0	0
y_{13245}	y_{24}	0	0	y_{23}	0
y_{13425}	$-y_{24}$	0	0	0	0
y_{14235}	0	y_{24}	y_{23}	0	y_{35}
y_{14325}	0	0	$-y_{23}$	0	0
	$[\bar{x}_{43}, [\bar{x}_{13}, \bar{x}_{23}]]$	$[\bar{x}_{52}, [\bar{x}_{13}, \bar{x}_{23}]]$	$[\bar{x}_{53}, [\bar{x}_{13}, \bar{x}_{23}]]$	$[\bar{x}_{31}, [\bar{x}_{14}, \bar{x}_{24}]]$	$[\bar{x}_{34}, [\bar{x}_{14}, \bar{x}_{24}]]$
y_{12345}	0	0	y_{34}	0	$-y_{45}$
y_{12435}	$-y_{35}$	0	$-y_{34}$	0	0
y_{13245}	0	0	0	y_{45}	0
y_{13425}	0	$-y_{34}$	0	0	0
y_{14235}	0	0	0	0	0
y_{14325}	0	y_{34}	0	0	0

4. Let \mathcal{S}_3 be the set of the partial conjugations which do not change Y'_2 and Y'_3 of L_2 . Find a relation $\Psi_3 \in \mathcal{S}_3$ which satisfies $\Psi_3 \circ \Psi_2 \circ \Psi_1(Y_4) = Y'_4$ for L_2 . If there is such a relation, then replace

$$L_2 = (Y'_1, Y'_2, Y'_3, \Psi_2 \circ \Psi_1(Y_4), \dots)$$

to

$$\begin{aligned} L_3 &= \Psi_3(L_2) \\ &= (Y'_1, Y'_2, Y'_3, \Psi_3 \circ \Psi_2 \circ \Psi_1(Y_4), \dots) \\ &= (Y'_1, Y'_2, Y'_3, Y'_4, \dots) \end{aligned}$$

and go to the next step, otherwise L and L' are not link-homotopic.

5. Repeat the operations until Y_{n-1} changes to Y'_{n-1} . Then, $L' = \Psi_{n-1} \circ \cdots \circ \Psi_1(L)$ and L and L' are link-homotopic. If it stops before that, L and L' are not link-homotopic.

Remark 4.1. For the 4- and 5-component cases, the algorithm goes as follows.

The set \mathcal{S}_1 is generated by X_n in Theorems 3.2 and 3.5 for the 4- and 5-component cases respectively. In Step 2, Ψ_1 can be presented as $\prod_{\bar{x}'_{ij} \in X_n} \bar{x}'_{ij}{}^{a_{ij}}$, where $a_{ij} \in \mathbb{Z}$. To find Ψ_1 such that $\Psi_1(Y_2) = Y'_2$, it is needed to find a_{ij} satisfying

$$(1) \quad \prod_{\bar{x}'_{ij} \in X_n} \bar{x}'_{ij}{}^{a_{ij}}(y_{klm}) = y'_{klm}$$

for all pairs (y_{klm}, y'_{klm}) ($y_{klm} \in Y_2$, $y'_{klm} \in Y'_2$). This problem is a system of linear Diophantine equations and solvable if it has solutions.

In Step 3, the set \mathcal{S}_2 includes the commutators $[\bar{x}_{ij}, \bar{x}_{kl}]$ or the simplified commutators $[\bar{x}_{ij}, \bar{x}_{kl}]'$, see Tables 2 or 5. The set \mathcal{S}_2 is generated by relations presented as $\prod_{\bar{x}'_{ij} \in X_n} \bar{x}'_{ij}{}^{b_{ij}}$, where $b_{ij} \in \mathbb{Z}$, which satisfy $\prod_{\bar{x}'_{ij} \in X_n} \bar{x}'_{ij}{}^{b_{ij}}(Y'_2) = Y'_2$ and the (simplified) commutators in Table 2 or 5. To find the generators of \mathcal{S}_2 which are not the (simplified) commutators, it is needed to find b_{ij} satisfying

$$\prod_{\bar{x}'_{ij} \in X_n} \bar{x}'_{ij}{}^{b_{ij}}(y'_{klm}) = y'_{klm}$$

for all $y'_{klm} \in Y'_2$. This problem is the homogeneous system of linear Diophantine equations corresponding to (1).

Let ψ_i be the generators of \mathcal{S}_2 . To find Ψ_2 such that $\Psi_2 \circ \Psi_1(Y_3) = Y'_3$, it is needed to find c_i satisfying

$$(2) \quad \prod_{\psi_i} \psi_i^{c_i}(y_{klmn}) = y'_{klmn}$$

for all pairs (y_{klmn}, y'_{klmn}) ($y_{klmn} \in Y_3$, $y'_{klmn} \in Y'_3$). This problem is a system of linear Diophantine equations.

For the 5-component case, the commutators $[\bar{x}_{ij}, [\bar{x}_{kl}, \bar{x}_{mn}]]$ do not change Y'_3 , see Table 6. Thus, in Step 4, the set \mathcal{S}_3 includes the commutators $[\bar{x}_{ij}, [\bar{x}_{kl}, \bar{x}_{mn}]]$. The set \mathcal{S}_3 is generated by relations presented as $\prod_{\psi_i} \psi_i^{d_i}$, where $d_i \in \mathbb{Z}$, which satisfy $\prod_{\psi_i} \psi_i^{d_i}(Y'_3) = Y'_3$ and $[\bar{x}_{ij}, [\bar{x}_{kl}, \bar{x}_{mn}]]$ in Table 6. To find the generators of \mathcal{S}_3 which are not $[\bar{x}_{ij}, [\bar{x}_{kl}, \bar{x}_{mn}]]$, it is needed to find d_i satisfying

$$\prod_{\psi_i} \psi_i^{d_i}(y_{klmn}) = y_{klmn}$$

for all $y'_{klmn} \in Y'_3$. This problem is the homogeneous system of linear Diophantine equations corresponding to (2).

Remark 4.2. In [8], the authors gave a presentation of \mathcal{L}_4 by using the ‘‘tetrahedron’’ standard form, which coincides with Theorem 3.2, and showed examples of the algorithm. For explicit calculations of the algorithm, see Section 4 of the paper.

5. TEST OF THE RESULTS

The calculations of the partial conjugations \bar{x}_{ij} are complicated and mistakes easily occur. In this section, we also calculate the actions of conjugations $(\bar{x}_j, x_j)_i$ in Figure 5 for the canonical forms and test the results in Table 1 and 7. We abbreviate $(\bar{x}_j, x_j)_i$ to cx_{ij} for simplicity. The conjugation cx_{ij} ($1 \leq i < j \leq n$) for the canonical form b of n -component string links is shown in Figure 15. We transform the shape of Figure 15 back to the canonical form by using the relations in Section 2. Then the numbers of claspers change and the differences of the numbers from the previous canonical form present the action of the conjugation cx_{ij} . The results of the actions of cx_{ij} are in Table 9 for the 4-component case and Table 10 for the 5-component case. We also use the notation cx_{ji} ($1 \leq i < j \leq n$) with $cx_{ij} = cx_{ji}$.

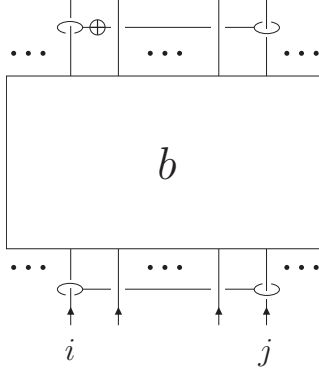
FIGURE 15. Conjugation cx_{ij} for the canonical form b

Proposition 5.1. *For the actions of conjugations cx_{ij} and partial conjugations \bar{x}_{ij} for n -component string links, the following relations hold.*

- (1) $\prod_{k=2}^n CX_k = id$, where $CX_k = \prod_{i=1}^{k-1} cx_{ik}$.
- (2) $\prod_{\substack{i=1 \\ i \neq j}}^n \bar{x}_{ij} = \prod_{\substack{i=1 \\ i \neq j}}^n cx_{ij}$ for each $1 \leq j \leq n$.

Proof. (1) $\prod_{k=2}^n CX_k$ make left (resp. right) full-twists above (resp. under) a string link σ , see Figure 16 for the 4-component case. The twists cancel by isotopy and the action is the identity.

(2) We show the relation for the 4-component case. See Figure 17. The first figure presents $\prod_{\substack{i=1 \\ i \neq 4}}^4 \bar{x}_{i4}$ (i.e. $j = 4$). Up to link-homotopy, it is transformed to the last figure

which presents $\prod_{\substack{i=1 \\ i \neq 4}}^4 cx_{i4}$. For the cases $j \neq 4$, to see the relation, first move the j -th component to the outermost position under the other components, second transform the shape similar to the case $j = 4$ and finally move back the j -th component to the original position. The relations for other than the 4-component case are shown similarly. \square

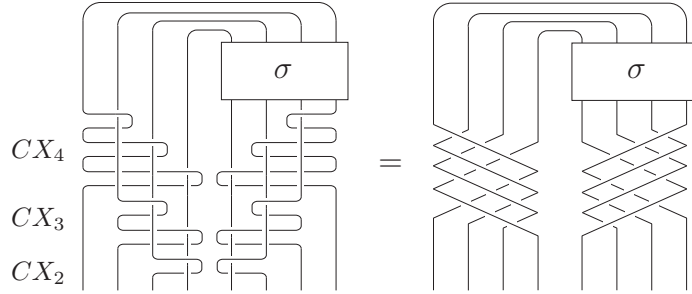

FIGURE 16. Full twist

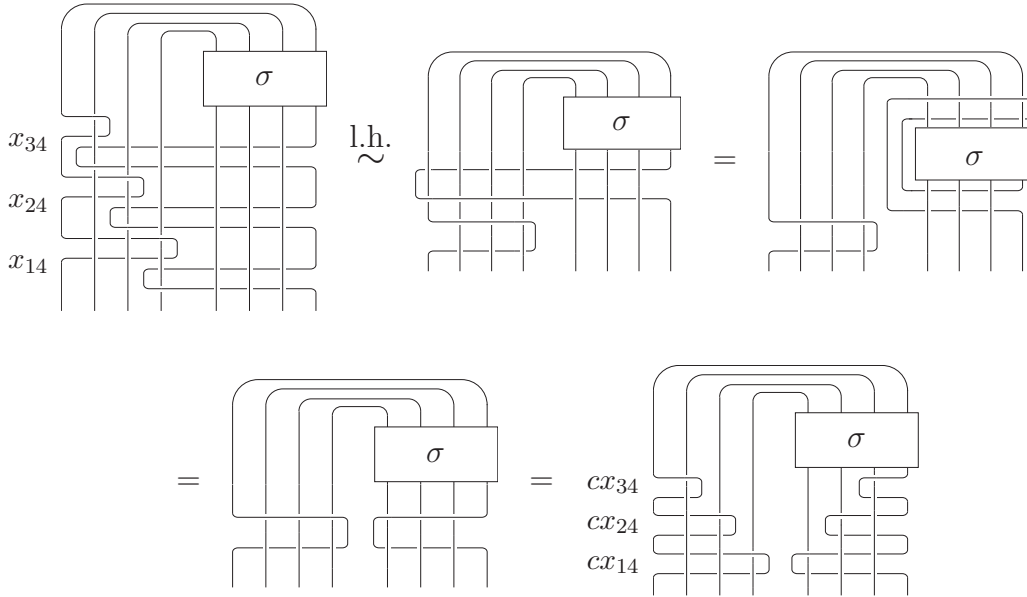

FIGURE 17. Relation between the partial conjugations and the conjugations.

The relations (1) and (2) in Proposition 5.1 can be used to test the results of cx_{ij} and \bar{x}_{ij} respectively. We have checked these relations by using the software Mathematica. The files are in the web page [17].

APPENDIX A. EXAMPLES OF CALCULATIONS FOR \bar{x}_{ij}

We show an example of the calculation of the action \bar{x}_{13} for the 4-component canonical form. We use the relations of the clasppers in Section 2. They also induce the relations

in Figure 18 up to link-homotopy, where the vertical lines are components of string links and the new clasps in the right-hand sides go parallel to the other clasps in outside the figures.

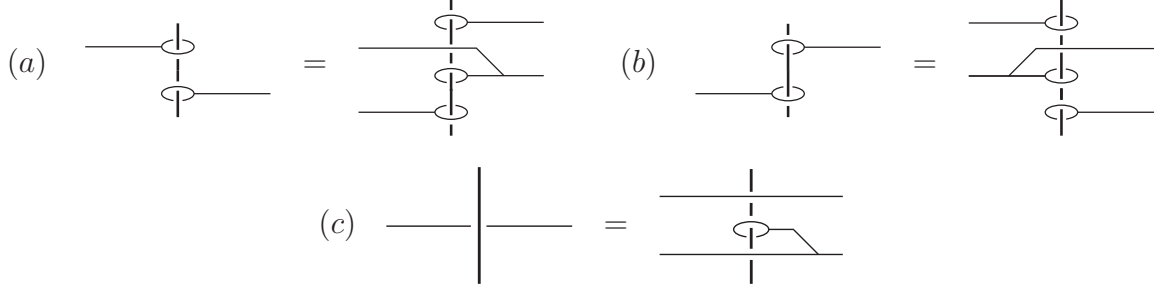

FIGURE 18. Relations of the clasps for string links

The calculation of the action \bar{x}_{13} is in Figure 19, where b is the canonical form for 4-component string links in Figure 12. The partial conjugation \bar{x}_{13} is presented as the first figure. We transform it back to the canonical form. In the figures, we only write the numbers of clasps for the new clasps. First, we move the clasper over the canonical form b down to under it. Then the clasper cancel with the twisted clasper bottommost. In the middle, by (2) in Lemma 2.6 and (a) in Figure 18, the new clasps appear which are shown in the second figure. Second, we move the leaves in the left-side to the right-side. Third, we start to move the new clasps to the positions of the canonical form. In the fourth figure, $-y_{234}$ parallel clasps moves to the position of the canonical form and, by (c) in Figure 18, new $+y_{34}$ C_3 -clasps appear. In the fifth figure, the clasps in the fourth figure move to the positions of the canonical form. In the process, new clasps occur by (2) in Lemma 2.6 and (b) in Figure 18. Finally, we obtain the new canonical form in the last figure. The difference of the numbers of the clasps from b presents the action of \bar{x}_{13} .

By the similar calculations, we obtain the actions \bar{x}_{ij} for the 4-component case (Table 1) and the 5-component case (Table 7).

APPENDIX B. RESULTS OF CALCULATIONS

We show the results of calculations. The results of the action of the generators \bar{x}_{ij} of partial conjugations for 5-component string links are in Table 7. In Table 8, the actions of the commutators $[\bar{x}_{ij}, \bar{x}_{kl}]$ of \bar{x}_{ij} are shown. In Table 10, the actions of conjugations $c_{x_{ij}}$ are shown.

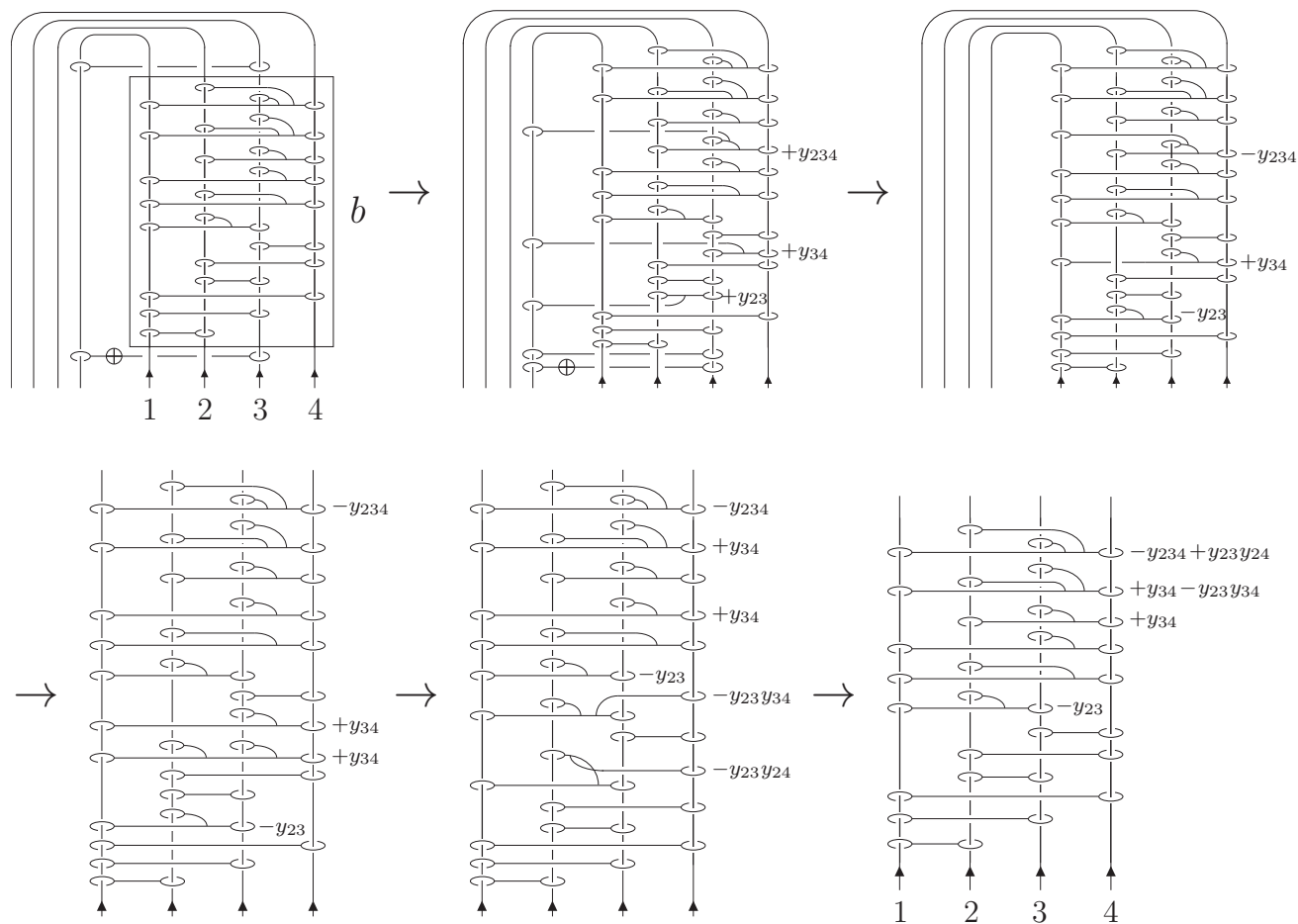

FIGURE 19. The action of \bar{x}_{13} for 4-component canonical forms

TABLE 7. Partial conjugations for 5-component string links

	\bar{x}_{12}	\bar{x}_{13}	\bar{x}_{14}
y_{123}	y_{23}	$-y_{23}$	0
y_{124}	y_{24}	0	$-y_{24}$
y_{134}	0	y_{34}	$-y_{34}$
y_{125}	y_{25}	0	0
y_{135}	0	y_{35}	0
y_{145}	0	0	y_{45}
y_{234}	0	0	0
y_{235}	0	0	0
y_{245}	0	0	0
y_{345}	0	0	0
y_{1234}	$y_{234} - y_{24}y_{34} + y_{23}y_{34}$	$-y_{23}y_{34} + y_{34}$	$-y_{234} - y_{34} + y_{24}y_{34}$
y_{1324}	$-y_{23}y_{24}$	$-y_{234} + y_{23}y_{24}$	$y_{234} - y_{24}$
y_{1235}	$y_{235} - y_{25}y_{35} + y_{23}y_{35}$	$-y_{23}y_{35} + y_{35}$	0
y_{1245}	$y_{245} - y_{25}y_{45} + y_{24}y_{45}$	0	$-y_{24}y_{45} + y_{45}$
y_{1325}	$-y_{23}y_{25}$	$-y_{235} + y_{23}y_{25}$	0
y_{1345}	0	$y_{345} - y_{35}y_{45} + y_{34}y_{45}$	$y_{45} - y_{34}y_{45}$
y_{1425}	$-y_{24}y_{25}$	0	$-y_{245} + y_{24}y_{25}$
y_{1435}	0	$-y_{34}y_{35}$	$-y_{345} + y_{34}y_{35}$
y_{2345}	0	0	0
y_{2435}	0	0	0
y_{12345}	$y_{2345} + y_{23}y_{145}$ $+ y_{25}y_{35}y_{45} - y_{24}y_{34}y_{45}$ $- y_{23}y_{35}y_{45} + y_{23}y_{34}y_{45}$	$y_{345} - y_{23}y_{145} - y_{35}y_{45}$ $+ y_{34}y_{45} + y_{23}y_{35}y_{45}$ $- y_{23}y_{34}y_{45}$	$y_{45} - y_{34}y_{45}$ $+ y_{24}y_{34}y_{45}$
y_{12435}	$y_{2435} + y_{24}y_{135} + y_{24}y_{35}$ $+ y_{24}y_{34}y_{35} - y_{23}y_{34}y_{35}$ $+ y_{23}y_{24}y_{35}$	$-y_{34}y_{35} + y_{23}y_{34}y_{35}$ $- y_{23}y_{24}y_{35}$	$-y_{345} - y_{24}y_{135}$ $+ y_{34}y_{35} - y_{24}y_{34}y_{35}$
y_{13245}	$-y_{23}y_{145} + y_{23}y_{25}y_{45}$ $- y_{23}y_{24}y_{45}$	$-y_{2435} - y_{2345} + y_{23}y_{145}$ $- y_{23}y_{25}y_{45} + y_{23}y_{24}y_{45}$	$-y_{24}y_{45}$
y_{13425}	$y_{24}y_{25}y_{34} - y_{23}y_{25}y_{34}$ $+ y_{23}y_{24}y_{25}$	$y_{2435} + y_{34}y_{125}$ $+ y_{23}y_{25}y_{34} - y_{23}y_{24}y_{25}$	$-y_{245} - y_{34}y_{125}$ $- y_{24}y_{25}y_{34} + y_{24}y_{25}$
y_{14235}	$-y_{24}y_{135} + y_{24}y_{25}y_{35}$ $- y_{23}y_{24}y_{35}$	$y_{23}y_{24}y_{35}$	$-y_{2435} - y_{2345}$ $+ y_{24}y_{135} - y_{24}y_{25}y_{35}$ $- y_{24}y_{35}$
y_{14325}	$-y_{24}y_{25}y_{34} + y_{23}y_{25}y_{34}$	$-y_{34}y_{125} - y_{23}y_{25}y_{34}$	$y_{2345} + y_{34}y_{125}$ $+ y_{24}y_{25}y_{34}$

	\bar{x}_{15}	\bar{x}_{21}	\bar{x}_{23}
y_{123}	0	$-y_{13}$	y_{13}
y_{124}	0	$-y_{14}$	0
y_{134}	0	0	0
y_{125}	$-y_{25}$	$-y_{15}$	0
y_{135}	$-y_{35}$	0	0
y_{145}	$-y_{45}$	0	0
y_{234}	0	0	y_{34}
y_{235}	0	0	y_{35}
y_{245}	0	0	0
y_{345}	0	0	0
y_{1234}	0	$-y_{134} + y_{14}y_{34} - y_{13}y_{34} + y_{13}y_{14}$	$y_{134} + y_{13}y_{34} - y_{13}y_{14}$
y_{1324}	0	$-y_{13}y_{14}$	$-y_{134} + y_{13}y_{14}$
y_{1235}	$-y_{235} - y_{35} + y_{25}y_{35}$	$-y_{135} + y_{15}y_{35} - y_{13}y_{35} + y_{13}y_{15}$	$y_{135} + y_{13}y_{35} - y_{13}y_{15}$
y_{1245}	$-y_{245} - y_{45} + y_{25}y_{45}$	$-y_{145} + y_{15}y_{45} - y_{14}y_{45} + y_{14}y_{15}$	0
y_{1325}	$y_{235} - y_{25}$	$-y_{13}y_{15}$	$-y_{135} + y_{13}y_{15}$
y_{1345}	$-y_{345} - y_{45} + y_{35}y_{45}$	0	0
y_{1425}	$y_{245} - y_{25}$	$-y_{14}y_{15}$	0
y_{1435}	$y_{345} - y_{35}$	0	0
y_{2345}	0	0	$y_{345} - y_{35}y_{45} + y_{34}y_{45}$
y_{2435}	0	0	$-y_{34}y_{35}$
y_{12345}	$-y_{2345} - y_{345} - y_{45} + y_{35}y_{45} - y_{25}y_{35}y_{45}$	$-y_{1345} + y_{15}y_{234} + y_{13}y_{35}y_{45} - y_{15}y_{35}y_{45} + y_{14}y_{34}y_{45} - y_{13}y_{34}y_{45} - y_{13}y_{15}y_{45} + y_{13}y_{15}y_{34} + y_{13}y_{14}y_{45} - y_{13}y_{14}y_{15} - y_{14}y_{15}y_{34}$	$y_{1345} + y_{34}y_{145} - y_{13}y_{35}y_{45} + y_{13}y_{34}y_{45} + y_{13}y_{15}y_{45} - y_{13}y_{15}y_{34} - y_{13}y_{14}y_{45} + y_{13}y_{14}y_{15}$
y_{12435}	$-y_{2435} + y_{345} - y_{35}$	$-y_{1435} - y_{15}y_{234} - y_{14}y_{35} - y_{14}y_{34}y_{35} + y_{13}y_{34}y_{35} - y_{13}y_{15}y_{34} + y_{14}y_{15}y_{34} - y_{14}y_{15}y_{35}$	$-y_{34}y_{135} - y_{13}y_{34}y_{35} + y_{13}y_{15}y_{34}$
y_{13245}	$y_{2435} + y_{2345} - y_{245} + y_{25}y_{45}$	$-y_{13}y_{245} + y_{13}y_{15}y_{45} - y_{13}y_{14}y_{45} + y_{13}y_{14}y_{15}$	$-y_{1345} - y_{34}y_{145} + y_{34}y_{135} + y_{13}y_{245} - y_{13}y_{15}y_{45} + y_{13}y_{14}y_{45} - y_{13}y_{14}y_{15}$
y_{13425}	$-y_{2435} + y_{245} - y_{25}$	$-y_{15}y_{134} - y_{15}y_{234} - y_{13}y_{15}y_{34} + y_{14}y_{15}y_{34}$	$-y_{34}y_{135} + y_{13}y_{15}y_{34}$
y_{14235}	$y_{2435} + y_{2345} - y_{235} + y_{25}y_{35}$	$-y_{14}y_{235} - y_{13}y_{14}y_{35} + y_{13}y_{14}y_{15} + y_{14}y_{15}y_{35}$	$y_{1435} + y_{35}y_{145} - y_{34}y_{145} + y_{34}y_{135} + y_{13}y_{14}y_{35} - y_{13}y_{14}y_{15}$
y_{14325}	$-y_{2345} + y_{235}$	$y_{15}y_{134} + y_{15}y_{234} + y_{13}y_{15}y_{34} - y_{13}y_{14}y_{15} - y_{14}y_{15}y_{34}$	$-y_{1435} - y_{35}y_{145} - y_{35}y_{134} + y_{34}y_{145} - y_{13}y_{15}y_{34} + y_{13}y_{14}y_{15}$

	\bar{x}_{24}	\bar{x}_{25}	\bar{x}_{31}
y_{123}	0	0	y_{12}
y_{124}	y_{14}	0	0
y_{134}	0	0	$-y_{14}$
y_{125}	0	y_{15}	0
y_{135}	0	0	$-y_{15}$
y_{145}	0	0	0
y_{234}	$-y_{34}$	0	0
y_{235}	0	$-y_{35}$	0
y_{245}	y_{45}	$-y_{45}$	0
y_{345}	0	0	0
y_{1234}	$y_{14} - y_{14}y_{34}$	0	$-y_{12}y_{14} - y_{14}$
y_{1324}	$y_{134} - y_{14}$	0	$-y_{124} + y_{14}y_{24} - y_{12}y_{24}$ $+y_{12}y_{14} + y_{14}$
y_{1235}	0	$-y_{15}y_{35} + y_{15}$	$-y_{12}y_{15} - y_{15}$
y_{1245}	$y_{145} + y_{14}y_{45} - y_{14}y_{15}$	$y_{15} - y_{15}y_{45}$	0
y_{1325}	0	$y_{135} - y_{15}$	$-y_{125} + y_{15}y_{25} - y_{12}y_{25}$ $+y_{12}y_{15} + y_{15}$
y_{1345}	0	0	$-y_{145} + y_{15}y_{45} - y_{14}y_{45}$ $+y_{14}y_{15}$
y_{1425}	$-y_{145} + y_{14}y_{15}$	$y_{145} - y_{15}$	0
y_{1435}	0	0	$-y_{14}y_{15}$
y_{2345}	$y_{45} - y_{34}y_{45}$	$-y_{345} - y_{45} + y_{35}y_{45}$	0
y_{2435}	$-y_{345} + y_{34}y_{35}$	$y_{345} - y_{35}$	0
y_{12345}	$y_{145} - y_{34}y_{145}$ $-y_{14}y_{34}y_{45} + y_{14}y_{15}y_{34}$ $+y_{14}y_{45} - y_{14}y_{15}$	$-y_{15}y_{234} + y_{15}$ $-y_{15}y_{45} + y_{15}y_{35}y_{45}$	$+y_{15}y_{45} - y_{14}y_{45} + y_{15}y_{45}$ $-y_{14}y_{45} + y_{14}y_{15} + y_{12}y_{15}y_{45}$ $-y_{12}y_{14}y_{45} + y_{12}y_{14}y_{15}$
y_{12435}	$y_{1435} + y_{34}y_{135}$ $+y_{14}y_{35} + y_{14}y_{34}y_{35}$ $-y_{14}y_{15}y_{34} + y_{14}y_{15}y_{35}$	$y_{15}y_{234} - y_{15}y_{35}$	$y_{15}y_{234} - y_{15}y_{124}$ $+y_{14}y_{15}y_{24} - y_{12}y_{15}y_{24}$
y_{13245}	$y_{1345} - y_{145} + y_{45}y_{135}$ $+y_{34}y_{145} - y_{34}y_{135}$ $+y_{14}y_{15} - y_{14}y_{45}$	$y_{135} - y_{45}y_{135} - y_{15}$ $+y_{15}y_{45}$	$-y_{1245} + y_{145} - y_{15}y_{45} + y_{14}y_{45}$ $-y_{14}y_{15} - y_{15}y_{234} - y_{15}y_{25}y_{45}$ $+y_{14}y_{24}y_{45} - y_{14}y_{15}y_{24}$ $+y_{12}y_{25}y_{45} - y_{12}y_{24}y_{45}$ $-y_{12}y_{15}y_{45} + y_{12}y_{15}y_{24}$ $+y_{12}y_{14}y_{45} - y_{12}y_{14}y_{15}$
y_{13425}	$-y_{1345} - y_{45}y_{135}$ $+y_{45}y_{134} + y_{34}y_{135}$ $-y_{14}y_{15}y_{34}$	$y_{1345} - y_{135}$ $+y_{45}y_{135} - y_{45}y_{134}$ $+y_{15}y_{134} + y_{15}y_{234}$	$-y_{1425} + y_{15}y_{234} - y_{14}y_{25}$ $-y_{14}y_{24}y_{25} - y_{14}y_{15}y_{25} + y_{14}y_{15}y_{24}$ $+y_{12}y_{24}y_{25} - y_{12}y_{15}y_{24}$
y_{14235}	$-y_{1435} - y_{145} + y_{34}y_{145}$ $-y_{34}y_{135} - y_{14}y_{35}$ $+y_{14}y_{235} + y_{14}y_{15}$ $-y_{14}y_{15}y_{35}$	$y_{145} - y_{35}y_{145} - y_{15}$ $+y_{15}y_{35}$	$-y_{15}y_{234} + y_{15}y_{124}$ $-y_{14}y_{15} - y_{14}y_{15}y_{24}$ $+y_{12}y_{15}y_{24} - y_{12}y_{14}y_{15}$
y_{14325}	$y_{145} + y_{14}y_{15}y_{34}$ $-y_{14}y_{15} - y_{34}y_{145}$	$y_{1435} - y_{145} + y_{35}y_{145}$ $+y_{35}y_{134} - y_{15}y_{134}$ $-y_{15}y_{234} + y_{15}$	$y_{14}y_{235} + y_{14}y_{15}$ $+y_{14}y_{15}y_{25} - y_{12}y_{14}y_{25}$ $+y_{12}y_{14}y_{15}$

	\bar{x}_{32}	\bar{x}_{34}	\bar{x}_{35}
y_{123}	$-y_{12}$	0	0
y_{124}	0	0	0
y_{134}	0	y_{14}	0
y_{125}	0	0	0
y_{135}	0	0	y_{15}
y_{145}	0	0	0
y_{234}	$-y_{24}$	y_{24}	0
y_{235}	$-y_{25}$	0	y_{25}
y_{245}	0	0	0
y_{345}	0	y_{45}	$-y_{45}$
y_{1234}	$-y_{124} + y_{12}y_{14}$	y_{124}	0
y_{1324}	$y_{124} + y_{12}y_{24} - y_{12}y_{14}$	$-y_{14}y_{24}$	0
y_{1235}	$-y_{125} + y_{12}y_{15}$	0	y_{125}
y_{1245}	0	0	0
y_{1325}	$y_{125} + y_{12}y_{25} - y_{12}y_{15}$	0	$-y_{15}y_{25}$
y_{1345}	0	$y_{145} + y_{14}y_{45} - y_{14}y_{15}$	$y_{15} - y_{15}y_{45}$
y_{1425}	0	0	0
y_{1435}	0	$-y_{145} + y_{14}y_{15}$	$y_{145} - y_{15}$
y_{2345}	$-y_{245} + y_{25}y_{45} - y_{24}y_{45} + y_{24}y_{25}$	$y_{245} - y_{24}y_{25} + y_{24}y_{45}$	$-y_{25}y_{45} + y_{25}$
y_{2435}	$-y_{24}y_{25}$	$-y_{245} + y_{24}y_{25}$	$y_{245} - y_{25}$
y_{12345}	$-y_{1245} - y_{24}y_{145} + y_{24}y_{125} + y_{12}y_{345} - y_{12}y_{15}y_{45} + y_{12}y_{14}y_{45} - y_{12}y_{14}y_{15}$	$y_{1245} + y_{45}y_{125} + y_{24}y_{145} - y_{24}y_{125}$	$y_{125} - y_{45}y_{125}$
y_{12435}	$y_{12}y_{15}y_{24} - y_{24}y_{125}$	$-y_{1245} - y_{45}y_{125} + y_{45}y_{124} + y_{24}y_{125} - y_{14}y_{15}y_{24}$	$y_{1245} - y_{125} + y_{45}y_{125} - y_{45}y_{124} - y_{15}y_{234} + y_{15}y_{124}$
y_{13245}	$y_{1245} + y_{24}y_{145} - y_{12}y_{25}y_{45} + y_{12}y_{24}y_{45} + y_{12}y_{15}y_{45} - y_{12}y_{15}y_{24} - y_{12}y_{14}y_{45} + y_{12}y_{14}y_{15}$	$-y_{24}y_{145} - y_{14}y_{24}y_{45} + y_{14}y_{15}y_{24}$	$y_{15}y_{234} + y_{15}y_{25}y_{45}$
y_{13425}	$-y_{12}y_{24}y_{25} - y_{24}y_{125} + y_{12}y_{15}y_{24}$	$y_{1425} + y_{24}y_{125} + y_{14}y_{25} + y_{14}y_{24}y_{25} + y_{14}y_{15}y_{25} - y_{14}y_{15}y_{24}$	$-y_{15}y_{234} - y_{15}y_{25}$
y_{14235}	$-y_{1425} - y_{25}y_{145} - y_{25}y_{124} + y_{24}y_{145} - y_{12}y_{15}y_{24} + y_{12}y_{14}y_{15}$	$-y_{24}y_{145} + y_{14}y_{15}y_{24}$	$y_{1425} + y_{25}y_{145} + y_{25}y_{124} + y_{15}y_{234} - y_{15}y_{124}$
y_{14325}	$y_{1425} + y_{25}y_{145} - y_{24}y_{145} + y_{24}y_{125} + y_{12}y_{14}y_{25} - y_{12}y_{14}y_{15}$	$-y_{1425} + y_{24}y_{145} - y_{24}y_{125} - y_{14}y_{235} - y_{14}y_{25} - y_{14}y_{15}y_{25}$	$-y_{25}y_{145} + y_{15}y_{25}$

	\bar{x}_{41}	\bar{x}_{42}	\bar{x}_{43}
y_{123}	0	0	0
y_{124}	y_{12}	$-y_{12}$	0
y_{134}	y_{13}	0	$-y_{13}$
y_{125}	0	0	0
y_{135}	0	0	0
y_{145}	$-y_{15}$	0	0
y_{234}	0	y_{23}	$-y_{23}$
y_{235}	0	0	0
y_{245}	0	$-y_{25}$	0
y_{345}	0	0	$-y_{35}$
y_{1234}	$y_{123} + y_{12} - y_{13}y_{23} + y_{12}y_{23}$	$-y_{12} - y_{12}y_{23}$	$-y_{123} + y_{13}y_{23}$
y_{1324}	$-y_{123} + y_{13} + y_{13}y_{23} - y_{12}y_{23} + y_{12}y_{13}$	$y_{123} + y_{12}y_{23} - y_{12}y_{13}$	$-y_{13}y_{23}$
y_{1235}	0	0	0
y_{1245}	$-y_{15} - y_{12}y_{15}$	$-y_{125} + y_{12}y_{15}$	0
y_{1325}	0	0	0
y_{1345}	$-y_{15} - y_{13}y_{15}$	0	$-y_{135} + y_{13}y_{15}$
y_{1425}	$-y_{125} + y_{15} + y_{15}y_{25} - y_{12}y_{25} + y_{12}y_{15}$	$y_{125} + y_{12}y_{25} - y_{12}y_{15}$	0
y_{1435}	$-y_{135} + y_{15} + y_{15}y_{35} - y_{13}y_{35} + y_{13}y_{15}$	0	$y_{135} + y_{13}y_{35} - y_{13}y_{15}$
y_{2345}	0	$-y_{25} - y_{23}y_{25}$	$-y_{235} + y_{23}y_{25}$
y_{2435}	0	$-y_{235} + y_{25} + y_{25}y_{35} - y_{23}y_{35} + y_{23}y_{25}$	$y_{235} + y_{23}y_{35} - y_{23}y_{25}$
y_{12345}	$-y_{15}y_{234} - y_{15}y_{123} - y_{15} + y_{13}y_{15}y_{23} - y_{12}y_{15} - y_{12}y_{15}y_{23}$	$-y_{125} - y_{23}y_{125} + y_{12}y_{15} + y_{12}y_{15}y_{23}$	$-y_{1235} - y_{35}y_{125} + y_{35}y_{123} + y_{23}y_{125} - y_{13}y_{15}y_{23}$
y_{12435}	$-y_{135} + y_{15} + y_{15}y_{35} - y_{13}y_{35} + y_{13}y_{15} + y_{12}y_{345} + y_{12}y_{15} + y_{12}y_{15}y_{35} - y_{12}y_{13}y_{35} + y_{12}y_{13}y_{15}$	$-y_{1235} + y_{125} - y_{23}y_{135} + y_{23}y_{125} - y_{12}y_{345} - y_{12}y_{15} - y_{12}y_{15}y_{35} + y_{12}y_{13}y_{35} - y_{12}y_{13}y_{15}$	$y_{1235} + y_{35}y_{125} + y_{23}y_{135} - y_{23}y_{125}$
y_{13245}	$y_{15}y_{234} + y_{15}y_{123} - y_{13}y_{15} - y_{13}y_{15}y_{23} + y_{12}y_{15}y_{23} - y_{12}y_{13}y_{15}$	$-y_{1325} - y_{25}y_{135} - y_{25}y_{123} + y_{23}y_{135} - y_{12}y_{15}y_{23} + y_{12}y_{13}y_{15}$	$-y_{23}y_{135} + y_{13}y_{15}y_{23}$
y_{13425}	$-y_{125} + y_{15} + y_{15}y_{25} + y_{13}y_{245} + y_{13}y_{15} + y_{13}y_{15}y_{25} - y_{12}y_{25} + y_{12}y_{15} - y_{12}y_{13}y_{25} + y_{12}y_{13}y_{15}$	$y_{1325} + y_{125} + y_{25}y_{135} - y_{23}y_{135} + y_{23}y_{125} + y_{12}y_{25} - y_{12}y_{15} + y_{12}y_{13}y_{25} - y_{12}y_{13}y_{15}$	$-y_{1325} + y_{23}y_{135} - y_{23}y_{125} - y_{13}y_{245} - y_{13}y_{25} - y_{13}y_{15}y_{25}$
y_{14235}	$-y_{1235} + y_{135} + y_{15}y_{234} - y_{15}y_{35} - y_{15}y_{25}y_{35} + y_{13}y_{35} - y_{13}y_{15} + y_{13}y_{23}y_{35} - y_{13}y_{15}y_{23} + y_{12}y_{25}y_{35} - y_{12}y_{23}y_{35} - y_{12}y_{15}y_{35} + y_{12}y_{15}y_{23} + y_{12}y_{13}y_{35} - y_{12}y_{13}y_{15}$	$y_{1235} + y_{23}y_{135} - y_{12}y_{25}y_{35} + y_{12}y_{23}y_{35} + y_{12}y_{15}y_{35} - y_{12}y_{15}y_{23} - y_{12}y_{13}y_{35} + y_{12}y_{13}y_{15}$	$-y_{23}y_{135} - y_{13}y_{23}y_{35} + y_{13}y_{15}y_{23}$
y_{14325}	$-y_{1325} + y_{125} - y_{15}y_{234} - y_{15} - y_{15}y_{25} - y_{13}y_{25} - y_{13}y_{23}y_{25} - y_{13}y_{15}y_{25} + y_{13}y_{15}y_{23} + y_{12}y_{25} - y_{12}y_{15} + y_{12}y_{23}y_{25} - y_{12}y_{15}y_{23}$	$-y_{125} - y_{23}y_{125} - y_{12}y_{25} + y_{12}y_{15} - y_{12}y_{23}y_{25} + y_{12}y_{15}y_{23}$	$y_{1325} + y_{23}y_{125} + y_{13}y_{25} + y_{13}y_{23}y_{25} - y_{13}y_{15}y_{23} + y_{13}y_{15}y_{25}$

	\bar{x}_{45}	\bar{x}_{51}
y_{123}	0	0
y_{124}	0	0
y_{134}	0	0
y_{125}	0	y_{12}
y_{135}	0	y_{13}
y_{145}	y_{15}	y_{14}
y_{234}	0	0
y_{235}	0	0
y_{245}	y_{25}	0
y_{345}	y_{35}	0
y_{1234}	0	0
y_{1324}	0	0
y_{1235}	0	$y_{123} - y_{13}y_{23} + y_{12} + y_{12}y_{23}$
y_{1245}	y_{125}	$y_{124} - y_{14}y_{24} + y_{12} + y_{12}y_{24}$
y_{1325}	0	$-y_{123} + y_{13}y_{23} + y_{12}y_{13} + y_{13} - y_{12}y_{23}$
y_{1345}	y_{135}	$y_{134} - y_{14}y_{34} + y_{13} + y_{13}y_{34}$
y_{1425}	$-y_{15}y_{25}$	$-y_{124} + y_{14} + y_{14}y_{24} - y_{12}y_{24} + y_{12}y_{14}$
y_{1435}	$-y_{15}y_{35}$	$-y_{134} + y_{14} + y_{14}y_{34} - y_{13}y_{34} + y_{13}y_{14}$
y_{2345}	y_{235}	0
y_{2435}	$-y_{25}y_{35}$	0
y_{12345}	$y_{1235} + y_{35}y_{125}$ $-y_{35}y_{123} + y_{15}y_{234}$ $+y_{15}y_{123}$	$y_{1234} + y_{123} + y_{14}y_{123} + y_{14}y_{24}y_{34}$ $-y_{13}y_{23} - y_{13}y_{23}y_{34} + y_{12}y_{345} + y_{12}$ $-y_{12}y_{24}y_{34} + y_{12}y_{23} + y_{12}y_{23}y_{34}$
y_{12435}	$-y_{35}y_{125}$	$-y_{1324} - y_{1234} + y_{124} - y_{14}y_{24}$ $-y_{14}y_{24}y_{34} + y_{13}y_{124} - y_{13}y_{24}$ $+y_{13}y_{23}y_{34} - y_{13}y_{23}y_{24} - y_{13}y_{14}y_{24}$ $-y_{12}y_{345} + y_{12}y_{24} + y_{12}y_{24}y_{34}$ $-y_{12}y_{23}y_{34} + y_{12}y_{23}y_{24}$
y_{13245}	$y_{1325} + y_{25}y_{135}$ $+y_{25}y_{123} - y_{15}y_{234}$ $-y_{15}y_{123}$	$y_{1324} - y_{123} - y_{14}y_{123} + y_{13}y_{245} + y_{13}$ $+y_{13}y_{24} + y_{13}y_{23} + y_{13}y_{23}y_{24} - y_{12}y_{23}$ $-y_{12}y_{23}y_{24} + y_{12}y_{13} + y_{12}y_{13}y_{24}$
y_{13425}	$-y_{25}y_{135}$	$-y_{1324} - y_{1234} + y_{134} - y_{14}y_{34} - y_{14}y_{24}y_{34}$ $-y_{13}y_{245} + y_{13}y_{34} - y_{13}y_{24} + y_{13}y_{23}y_{34}$ $-y_{13}y_{23}y_{24} + y_{12}y_{134} + y_{12}y_{24}y_{34} - y_{12}y_{23}y_{34}$ $+y_{12}y_{23}y_{24} - y_{12}y_{14}y_{34} + y_{12}y_{13}y_{34} - y_{12}y_{13}y_{24}$
y_{14235}	$-y_{15}y_{234} + y_{15}y_{25}y_{35}$	$y_{1324} - y_{124} + y_{14}y_{235} + y_{14} + y_{14}y_{24} - y_{13}y_{124}$ $+y_{13}y_{24} + y_{13}y_{23}y_{24} + y_{13}y_{14}y_{24} - y_{13}y_{14}y_{23}$ $-y_{12}y_{24} - y_{12}y_{23}y_{24} + y_{12}y_{14} + y_{12}y_{14}y_{23}$
y_{14325}	$y_{15}y_{234}$	$y_{1234} - y_{134} - y_{14}y_{235} + y_{14}y_{34} + y_{14}y_{24}y_{34}$ $-y_{13}y_{34} - y_{13}y_{23}y_{34} + y_{13}y_{14} + y_{13}y_{14}y_{23}$ $-y_{12}y_{134} - y_{12}y_{24}y_{34} + y_{12}y_{23}y_{34} - y_{12}y_{14}y_{23}$ $+y_{12}y_{14}y_{34} - y_{12}y_{13}y_{34} + y_{12}y_{13}y_{14}$

	\bar{x}_{52}	\bar{x}_{53}	\bar{x}_{54}
y_{123}	0	0	0
y_{124}	0	0	0
y_{134}	0	0	0
y_{125}	$-y_{12}$	0	0
y_{135}	0	$-y_{13}$	0
y_{145}	0	0	$-y_{14}$
y_{234}	0	0	0
y_{235}	y_{23}	$-y_{23}$	0
y_{245}	y_{24}	0	$-y_{24}$
y_{345}	0	y_{34}	$-y_{34}$
y_{1234}	0	0	0
y_{1324}	0	0	0
y_{1235}	$-y_{12} - y_{12}y_{23}$	$-y_{123} + y_{13}y_{23}$	0
y_{1245}	$-y_{12} - y_{12}y_{24}$	0	$-y_{124} + y_{14}y_{24}$
y_{1325}	$y_{123} + y_{12}y_{23} - y_{12}y_{13}$	$-y_{13}y_{23}$	0
y_{1345}	0	$-y_{13} - y_{13}y_{34}$	$-y_{134} + y_{14}y_{34}$
y_{1425}	$y_{124} + y_{12}y_{24} - y_{12}y_{14}$	0	$-y_{14}y_{24}$
y_{1435}	0	$y_{134} + y_{13}y_{34} - y_{13}y_{14}$	$-y_{14}y_{34}$
y_{2345}	$y_{234} - y_{24}y_{34} + y_{23} + y_{23}y_{34}$	$-y_{23} - y_{23}y_{34}$	$-y_{234} + y_{24}y_{34}$
y_{2435}	$-y_{234} + y_{24} + y_{24}y_{34}$ $-y_{23}y_{34} + y_{23}y_{24}$	$y_{234} + y_{23}y_{34} - y_{23}y_{24}$	$-y_{24}y_{34}$
y_{12345}	$-y_{12}y_{345} - y_{12} + y_{12}y_{24}y_{34}$ $-y_{12}y_{23} - y_{12}y_{23}y_{34}$	$-y_{123} - y_{34}y_{123}$ $+y_{13}y_{23} + y_{13}y_{23}y_{34}$	$-y_{1234} + y_{34}y_{123}$ $-y_{14}y_{123} - y_{14}y_{24}y_{34}$
y_{12435}	$y_{12}y_{345} - y_{12}y_{24} - y_{12}y_{24}y_{34}$ $+y_{12}y_{23}y_{34} - y_{12}y_{23}y_{24}$	$y_{1324} + y_{1234} + y_{34}y_{124}$ $-y_{13}y_{124} + y_{13}y_{24}$ $-y_{13}y_{23}y_{34} + y_{13}y_{23}y_{24}$ $+y_{13}y_{14}y_{24}$	$-y_{34}y_{124} + y_{14}y_{24}y_{34}$
y_{13245}	$y_{123} + y_{24}y_{123} + y_{12}y_{23}$ $+y_{12}y_{23}y_{24} - y_{12}y_{13}$ $-y_{12}y_{13}y_{24}$	$-y_{13}y_{245} - y_{13}y_{23}$ $-y_{13}y_{23}y_{24}$	$-y_{1324} - y_{24}y_{123}$ $+y_{14}y_{123}$
y_{13425}	$y_{1324} + y_{1234} + y_{24}y_{134} - y_{12}y_{134}$ $-y_{12}y_{24}y_{34} + y_{12}y_{23}y_{34}$ $-y_{12}y_{23}y_{24} + y_{12}y_{14}y_{34}$ $-y_{12}y_{13}y_{34} + y_{12}y_{13}y_{24}$	$y_{13}y_{245} - y_{13}y_{23}y_{34}$ $+y_{13}y_{23}y_{24}$	$-y_{24}y_{134} + y_{14}y_{24}y_{34}$
y_{14235}	$y_{124} + y_{23}y_{124} + y_{12}y_{24}$ $+y_{12}y_{23}y_{24} - y_{12}y_{14} - y_{12}y_{14}y_{23}$	$-y_{1324} - y_{23}y_{124}$ $+y_{13}y_{124} - y_{13}y_{24}$ $-y_{13}y_{23}y_{24} - y_{13}y_{14}y_{24}$ $+y_{13}y_{14}y_{23}$	$-y_{14}y_{235}$
y_{14325}	$-y_{1234} - y_{23}y_{134} + y_{12}y_{134}$ $+y_{12}y_{24}y_{34} - y_{12}y_{23}y_{34}$ $+y_{12}y_{14}y_{23} - y_{12}y_{14}y_{34}$ $+y_{12}y_{13}y_{34} - y_{12}y_{13}y_{14}$	$y_{23}y_{134} + y_{13}y_{23}y_{34}$ $-y_{13}y_{14}y_{23}$	$y_{14}y_{235} - y_{14}y_{24}y_{34}$

TABLE 8. Commutators of \bar{x}_{ij} for 5-component string links

	$[\bar{x}_{21}, \bar{x}_{31}]$	$[\bar{x}_{21}, \bar{x}_{41}]$	$[\bar{x}_{21}, \bar{x}_{51}]$	$[\bar{x}_{31}, \bar{x}_{41}]$
y_{1234}	y_{14}	0	0	$-y_{12}$
y_{1324}	$-y_{14}$	$-y_{13}$	0	0
y_{1235}	y_{15}	0	0	0
y_{1245}	0	y_{15}	0	0
y_{1325}	$-y_{15}$	0	$-y_{13}$	0
y_{1345}	0	0	0	y_{15}
y_{1425}	0	$-y_{15}$	$-y_{14}$	0
y_{1435}	0	0	0	$-y_{15}$
y_{2345}	0	0	0	0
y_{2435}	0	0	0	0
y_{12345}	$-y_{14}y_{15} + y_{14}y_{45}$ $-y_{15}y_{45} + y_{145}$	y_{15}	0	$y_{15} + y_{12}y_{15}$
y_{12435}	0	$-y_{15} - y_{13}y_{15} + y_{13}y_{35}$ $-y_{15}y_{35} + y_{135}$	0	$-y_{15} - y_{12}y_{15}$
y_{13245}	$y_{14}y_{15} - y_{14}y_{45}$ $+y_{15}y_{45} - y_{145}$	$y_{13}y_{15}$	$-y_{13}$	0
y_{13425}	0	$-y_{15} - y_{13}y_{15}$	$-y_{13}y_{34} + y_{14}y_{34}$ $-y_{134}$	$-y_{15} - y_{12}y_{15} + y_{12}y_{25}$ $-y_{15}y_{25} + y_{125}$
y_{14235}	$y_{14}y_{15}$	$y_{13}y_{15} - y_{13}y_{35}$ $+y_{15}y_{35} - y_{135}$	$-y_{14}$	0
y_{14325}	$-y_{14}y_{15}$	y_{15}	$-y_{13}y_{14} + y_{13}y_{34}$ $-y_{14}y_{34} + y_{134}$	$y_{15} + y_{12}y_{15} - y_{12}y_{25}$ $+y_{15}y_{25} - y_{125}$

	$[\bar{x}_{31}, \bar{x}_{51}]$	$[\bar{x}_{41}, \bar{x}_{51}]$	$[\bar{x}_{12}, \bar{x}_{32}]$	$[\bar{x}_{12}, \bar{x}_{42}]$
y_{1234}	0	0	0	y_{23}
y_{1324}	0	0	$-y_{24}$	$-y_{23}$
y_{1235}	$-y_{12}$	0	0	0
y_{1245}	0	$-y_{12}$	0	0
y_{1325}	0	0	$-y_{25}$	0
y_{1345}	0	$-y_{13}$	0	0
y_{1425}	0	0	0	$-y_{25}$
y_{1435}	$-y_{14}$	0	0	0
y_{2345}	0	0	0	0
y_{2435}	0	0	0	0
y_{12345}	$-y_{12}$	$-y_{12} - y_{12}y_{23}$ $+y_{13}y_{23} - y_{123}$	0	0
y_{12435}	$-y_{12}y_{24} + y_{14}y_{24}$ $-y_{124}$	0	0	0
y_{13245}	0	$-y_{13} - y_{12}y_{13} + y_{12}y_{23}$ $-y_{13}y_{23} + y_{123}$	$-y_{24}y_{45} + y_{25}y_{45}$ $-y_{245}$	0
y_{13425}	0	0	$y_{24}y_{25}$	$-y_{25}$
y_{14235}	$-y_{14} - y_{12}y_{14} + y_{12}y_{24}$ $-y_{14}y_{24} + y_{124}$	0	0	$-y_{23}y_{35} + y_{25}y_{35}$ $-y_{235}$
y_{14325}	0	0	0	$y_{25} + y_{23}y_{25}$

	$[\bar{x}_{12}, \bar{x}_{52}]$	$[\bar{x}_{32}, \bar{x}_{42}]$	$[\bar{x}_{32}, \bar{x}_{52}]$	$[\bar{x}_{42}, \bar{x}_{52}]$
y_{1234}	0	y_{12}	0	0
y_{1324}	0	0	0	0
y_{1235}	y_{23}	0	y_{12}	0
y_{1245}	y_{24}	0	0	y_{12}
y_{1325}	$-y_{23}$	0	0	0
y_{1345}	0	0	0	0
y_{1425}	$-y_{24}$	0	0	0
y_{1435}	0	0	0	0
y_{2345}	0	y_{25}	0	$-y_{23}$
y_{2435}	0	$-y_{25}$	$-y_{24}$	0
y_{12345}	$y_{23} + y_{23}y_{34}$ $-y_{24}y_{34} + y_{234}$	$-y_{12}y_{15} + y_{125}$	y_{12}	$y_{12} + y_{12}y_{23}$
y_{12435}	$y_{24} + y_{23}y_{24}$ $-y_{23}y_{34} + y_{24}y_{34}$ $-y_{234}$	$y_{12}y_{15} - y_{125}$	$y_{12}y_{24}$	0
y_{13245}	$-y_{23} - y_{23}y_{24}$	0	0	$y_{12}y_{13} - y_{12}y_{23}$ $-y_{123}$
y_{13425}	$y_{23}y_{24} - y_{23}y_{34}$ $+y_{24}y_{34} - y_{234}$	$y_{12}y_{15} - y_{12}y_{25}$ $-y_{125}$	0	0
y_{14235}	$-y_{24} - y_{23}y_{24}$	0	$y_{12}y_{14} - y_{12}y_{24}$ $-y_{124}$	0
y_{14325}	$y_{23}y_{34} - y_{24}y_{34}$ $+y_{234}$	$-y_{12}y_{15} + y_{12}y_{25}$ $+y_{125}$	0	0

	$[\bar{x}_{13}, \bar{x}_{23}]$	$[\bar{x}_{13}, \bar{x}_{43}]$	$[\bar{x}_{13}, \bar{x}_{53}]$	$[\bar{x}_{23}, \bar{x}_{43}]$
y_{1234}	$-y_{34}$	$-y_{23}$	0	0
y_{1324}	0	y_{23}	0	y_{13}
y_{1235}	$-y_{35}$	0	$-y_{23}$	0
y_{1245}	0	0	0	0
y_{1325}	0	0	y_{23}	0
y_{1345}	0	0	y_{34}	0
y_{1425}	0	0	0	0
y_{1435}	0	$-y_{35}$	$-y_{34}$	0
y_{2345}	0	0	0	0
y_{2435}	0	0	0	$-y_{35}$
y_{12345}	$-y_{34}y_{45} + y_{35}y_{45}$ $-y_{345}$	0	$-y_{23} + y_{34}$ $-y_{23}y_{34}$	0
y_{12435}	$y_{34}y_{35}$	$-y_{35}$	$-y_{23}y_{24} - y_{34}$ $+y_{23}y_{34} + y_{234}$	$y_{13}y_{15} - y_{13}y_{35}$ $-y_{135}$
y_{13245}	0	0	$y_{23} + y_{23}y_{24}$ $-y_{234}$	$-y_{13}y_{15} + y_{135}$
y_{13425}	0	0	$-y_{23}y_{24} + y_{23}y_{34}$ $+y_{234}$	$y_{13}y_{15} - y_{135}$
y_{14235}	0	$y_{23}y_{35}$	$y_{23}y_{24} - y_{234}$	$-y_{13}y_{15} + y_{13}y_{35}$ $+y_{135}$
y_{14325}	0	$-y_{23}y_{25} + y_{235}$	$-y_{23}y_{34}$	0

	$[\bar{x}_{23}, \bar{x}_{53}]$	$[\bar{x}_{14}, \bar{x}_{24}]$	$[\bar{x}_{14}, \bar{x}_{34}]$	$[\bar{x}_{24}, \bar{x}_{34}]$
y_{1234}	0	y_{34}	0	$-y_{14}$
y_{1324}	0	0	y_{24}	y_{14}
y_{1235}	0	0	0	0
y_{1245}	0	$-y_{45}$	0	0
y_{1325}	y_{13}	0	0	0
y_{1345}	0	0	$-y_{45}$	0
y_{1425}	0	0	0	0
y_{1435}	0	0	0	0
y_{2345}	y_{34}	0	0	$-y_{45}$
y_{2435}	$-y_{34}$	0	0	0
y_{12345}	0	$-y_{45} + y_{34}y_{45}$	$-y_{45}$	$y_{14}y_{15} - y_{14}y_{45} - y_{145}$
y_{12435}	0	$-y_{34}y_{35} + y_{345}$	0	0
y_{13245}	y_{13}	0	$y_{24}y_{45}$	$-y_{14}y_{15} + y_{14}y_{45} + y_{145}$
y_{13425}	$y_{13}y_{34}$	0	$-y_{24}y_{25} + y_{245}$	0
y_{14235}	0	0	0	$-y_{14}y_{15} + y_{145}$
y_{14325}	$y_{13}y_{14} - y_{13}y_{34} - y_{134}$	0	0	$y_{14}y_{15} - y_{145}$

TABLE 9. Conjugations for 4-component string links

	cx_{12}	cx_{13}	cx_{14}
y_{123}	$y_{23} - y_{13}$	$-y_{23} + y_{12}$	0
y_{124}	$y_{24} - y_{14}$	0	$-y_{24} + y_{12}$
y_{134}	0	$y_{34} - y_{14}$	$-y_{34} + y_{13}$
y_{234}	0	0	0
y_{1234}	$-y_{134} + y_{234}$ $-y_{24}y_{34} + y_{23}y_{34}$ $y_{14}y_{34} - y_{14}y_{23}$ $-y_{13}y_{34} + y_{13}y_{14}$	$y_{34} - y_{23}y_{34}$ $-y_{14} + y_{14}y_{23}$ $+y_{12}y_{34} - y_{12}y_{14}$	$-y_{234} + y_{123}$ $-y_{34} + y_{24}y_{34}$ $-y_{13}y_{23} - y_{12}y_{34}$ $+y_{12} + y_{12}y_{23}$
y_{1324}	$-y_{23}y_{24} + y_{14}y_{23}$ $+y_{13}y_{24} - y_{13}y_{14}$	$-y_{234} - y_{124}$ $+y_{23}y_{24} + y_{14}$ $+y_{14}y_{24} - y_{14}y_{23}$ $-y_{12}y_{24} + y_{12}y_{14}$	$y_{234} - y_{123}$ $-y_{24} + y_{13}$ $-y_{13}y_{24} + y_{13}y_{23}$ $-y_{12}y_{23} + y_{12}y_{13}$
	cx_{23}	cx_{24}	cx_{34}
y_{123}	$y_{13} - y_{12}$	0	0
y_{124}	0	$y_{14} - y_{12}$	0
y_{134}	0	$-y_{34} + y_{23}$	$y_{14} - y_{13}$
y_{234}	$y_{34} - y_{24}$	0	$y_{24} - y_{23}$
y_{1234}	$y_{134} - y_{124}$ $+y_{13}y_{34} - y_{13}y_{14}$ $-y_{12}y_{34} + y_{12}y_{14}$	$y_{14} - y_{14}y_{34}$ $+y_{14}y_{23} - y_{12}$ $+y_{12}y_{34} - y_{12}y_{23}$	$y_{124} - y_{123}$ $-y_{14}y_{23} + y_{13}y_{23}$
y_{1324}	$-y_{134} + y_{124}$ $-y_{13}y_{24} + y_{13}y_{14}$ $+y_{12}y_{24} - y_{12}y_{14}$	$y_{134} + y_{123}$ $-y_{14} - y_{14}y_{23}$ $+y_{12}y_{23} - y_{12}y_{13}$	$-y_{14}y_{24} + y_{14}y_{23}$ $+y_{13}y_{24} - y_{13}y_{23}$

TABLE 10. Conjugations for 5-component string links

	$c\mathcal{X}_{12}$
y_{123}	$y_{23} - y_{13}$
y_{124}	$y_{24} - y_{14}$
y_{134}	0
y_{125}	$y_{25} - y_{15}$
y_{135}	0
y_{145}	0
y_{234}	0
y_{235}	0
y_{245}	0
y_{345}	0
y_{1234}	$y_{234} - y_{134} - y_{24}y_{34} + y_{23}y_{34} + y_{14}y_{34} - y_{14}y_{23} - y_{13}y_{34} + y_{13}y_{14}$
y_{1324}	$-y_{23}y_{24} + y_{14}y_{23} + y_{13}y_{24} - y_{13}y_{14}$
y_{1235}	$+y_{235} - y_{135} - y_{25}y_{35} + y_{23}y_{35} + y_{15}y_{35} - y_{15}y_{23} - y_{13}y_{35} + y_{13}y_{15}$
y_{1245}	$+y_{245} - y_{145} - y_{25}y_{45} + y_{24}y_{45} + y_{15}y_{45} - y_{15}y_{24} - y_{14}y_{45} + y_{14}y_{15}$
y_{1325}	$-y_{23}y_{25} + y_{15}y_{23} + y_{13}y_{25} - y_{13}y_{15}$
y_{1345}	0
y_{1425}	$-y_{24}y_{25} + y_{15}y_{24} + y_{14}y_{25} - y_{14}y_{15}$
y_{1435}	0
y_{2345}	0
y_{2435}	0
y_{12345}	$+y_{2345} - y_{1345} + y_{25}y_{35}y_{45} - y_{24}y_{34}y_{45} - y_{23}y_{35}y_{45} + y_{23}y_{34}y_{45}$ $-y_{15}y_{35}y_{45} + y_{15}y_{24}y_{34} + y_{15}y_{23}y_{45} - y_{15}y_{23}y_{34} + y_{14}y_{34}y_{45}$ $-y_{14}y_{23}y_{45} - y_{14}y_{15}y_{34} + y_{14}y_{15}y_{23} + y_{13}y_{35}y_{45} - y_{13}y_{34}y_{45}$ $-y_{13}y_{15}y_{45} + y_{13}y_{15}y_{34} + y_{13}y_{14}y_{45} - y_{13}y_{14}y_{15}$
y_{12435}	$+y_{2435} - y_{1435} + y_{24}y_{35} + y_{24}y_{34}y_{35} - y_{23}y_{34}y_{35} + y_{23}y_{24}y_{35} + y_{15}y_{24}y_{35}$ $-y_{15}y_{24}y_{34} + y_{15}y_{23}y_{34} - y_{15}y_{23}y_{24} - y_{14}y_{34}y_{35} - y_{14}y_{15}y_{35}$ $+y_{14}y_{15}y_{34} - y_{14}y_{35} + y_{13}y_{34}y_{35} - y_{13}y_{24}y_{35} - y_{13}y_{15}y_{34} + y_{13}y_{15}y_{24}$
y_{13245}	$+y_{23}y_{25}y_{45} - y_{23}y_{24}y_{45} - y_{15}y_{23}y_{45} + y_{15}y_{23}y_{24} + y_{14}y_{23}y_{45}$ $-y_{14}y_{15}y_{23} - y_{13}y_{25}y_{45} + y_{13}y_{24}y_{45} + y_{13}y_{15}y_{45} - y_{13}y_{15}y_{24}$ $-y_{13}y_{14}y_{45} + y_{13}y_{14}y_{15}$
y_{13425}	$+y_{25}y_{134} + y_{24}y_{25}y_{34} - y_{23}y_{25}y_{34} + y_{23}y_{24}y_{25} - y_{15}y_{24}y_{34} + y_{15}y_{23}y_{34}$ $-y_{15}y_{23}y_{24} - y_{15}y_{134} - y_{14}y_{25}y_{34} + y_{14}y_{15}y_{34} + y_{13}y_{25}y_{34} - y_{13}y_{24}y_{25}$ $-y_{13}y_{15}y_{34} + y_{13}y_{15}y_{24}$
y_{14235}	$+y_{24}y_{25}y_{35} - y_{23}y_{24}y_{35} - y_{15}y_{24}y_{35} + y_{15}y_{23}y_{24} - y_{14}y_{25}y_{35}$ $+y_{14}y_{23}y_{35} + y_{14}y_{15}y_{35} - y_{14}y_{15}y_{23} + y_{13}y_{24}y_{35} - y_{13}y_{15}y_{24}$ $-y_{13}y_{14}y_{35} + y_{13}y_{14}y_{15}$
y_{14325}	$-y_{25}y_{134} - y_{24}y_{25}y_{34} + y_{23}y_{25}y_{34} + y_{15}y_{24}y_{34} - y_{15}y_{23}y_{34} + y_{15}y_{134}$ $+y_{14}y_{25}y_{34} - y_{14}y_{23}y_{25} - y_{14}y_{15}y_{34} + y_{14}y_{15}y_{23} - y_{13}y_{25}y_{34}$ $+y_{13}y_{15}y_{34} + y_{13}y_{14}y_{25} - y_{13}y_{14}y_{15}$

	$c\mathcal{X}_{13}$
y_{123}	$-y_{23} + y_{12}$
y_{124}	0
y_{134}	$+y_{34} - y_{14}$
y_{125}	0
y_{135}	$+y_{35} - y_{15}$
y_{145}	0
y_{234}	0
y_{235}	0
y_{245}	0
y_{345}	0
y_{1234}	$+y_{34} - y_{23}y_{34} + y_{14}y_{23} - y_{14} + y_{12}y_{34} - y_{12}y_{14}$
y_{1324}	$-y_{234} - y_{124} + y_{23}y_{24} + y_{14}y_{24} - y_{14}y_{23} + y_{14} - y_{12}y_{24} + y_{12}y_{14}$
y_{1235}	$+y_{35} - y_{23}y_{35} + y_{15}y_{23} - y_{15} + y_{12}y_{35} - y_{12}y_{15}$
y_{1245}	0
y_{1325}	$-y_{235} - y_{125} + y_{23}y_{25} + y_{15}y_{25} - y_{15}y_{23} + y_{15} - y_{12}y_{25} + y_{12}y_{15}$
y_{1345}	$+y_{345} - y_{145} - y_{35}y_{45} + y_{34}y_{45} + y_{15}y_{45} - y_{15}y_{34} - y_{14}y_{45} + y_{14}y_{15}$
y_{1425}	0
y_{1435}	0
y_{2345}	0
y_{2435}	0
y_{12345}	$+y_{345} - y_{145} + y_{34}y_{45} - y_{35}y_{45} + y_{23}y_{35}y_{45} - y_{23}y_{34}y_{45} - y_{15}y_{23}y_{45}$ $+y_{15}y_{23}y_{34} + y_{15}y_{45} - y_{15}y_{34} + y_{14}y_{23}y_{45} - y_{14}y_{15}y_{23} - y_{14}y_{45} + y_{14}y_{15}$ $-y_{12}y_{35}y_{45} + y_{12}y_{34}y_{45} + y_{12}y_{15}y_{45} - y_{12}y_{15}y_{34} - y_{12}y_{14}y_{45} + y_{12}y_{14}y_{15}$
y_{12435}	$-y_{34}y_{35} + y_{23}y_{34}y_{35} - y_{23}y_{24}y_{35} + y_{35}y_{124} - y_{15}y_{124} + y_{15}y_{24} - y_{15}y_{23}y_{34}$ $+y_{15}y_{23}y_{24} + y_{15}y_{34} - y_{15}y_{24} - y_{14}y_{24}y_{35} + y_{14}y_{15}y_{24} - y_{12}y_{34}y_{35}$ $+y_{12}y_{24}y_{35} + y_{12}y_{15}y_{34} - y_{12}y_{15}y_{24}$
y_{13245}	$-y_{2435} - y_{2345} - y_{1245} + y_{145} - y_{23}y_{25}y_{45} + y_{23}y_{24}y_{45} - y_{15}y_{25}y_{45} - y_{15}y_{24}$ $+y_{15}y_{23}y_{45} - y_{15}y_{23}y_{24} - y_{15}y_{45} + y_{15}y_{24} + y_{14}y_{24}y_{45} - y_{14}y_{23}y_{45}$ $-y_{14}y_{15}y_{24} + y_{14}y_{15}y_{23} + y_{14}y_{45} - y_{14}y_{15} + y_{12}y_{25}y_{45} - y_{12}y_{24}y_{45}$ $-y_{12}y_{15}y_{45} + y_{12}y_{15}y_{24} + y_{12}y_{14}y_{45} - y_{12}y_{14}y_{15}$
y_{13425}	$+y_{2435} - y_{1425} + y_{23}y_{25}y_{34} - y_{23}y_{24}y_{25} + y_{15}y_{25}y_{34} + y_{15}y_{24} - y_{15}y_{23}y_{34}$ $+y_{15}y_{23}y_{24} + y_{15}y_{34} - y_{15}y_{24} - y_{14}y_{24}y_{25} - y_{14}y_{25} - y_{14}y_{15}y_{25} + y_{14}y_{15}y_{24}$ $-y_{12}y_{25}y_{34} + y_{12}y_{24}y_{25} + y_{12}y_{15}y_{34} - y_{12}y_{15}y_{24}$
y_{14235}	$+y_{23}y_{24}y_{35} - y_{35}y_{124} + y_{15}y_{124} - y_{15}y_{24} - y_{15}y_{23}y_{24} + y_{15}y_{24} + y_{14}y_{24}y_{35}$ $-y_{14}y_{23}y_{35} - y_{14}y_{15}y_{24} + y_{14}y_{15}y_{23} + y_{14}y_{35} - y_{14}y_{15} - y_{12}y_{24}y_{35}$ $+y_{12}y_{15}y_{24} + y_{12}y_{14}y_{35} - y_{12}y_{14}y_{15}$
y_{14325}	$-y_{23}y_{25}y_{34} - y_{15}y_{25}y_{34} + y_{15}y_{23}y_{34} - y_{15}y_{34} + y_{14}y_{23}y_{25} + y_{14}y_{15}y_{25}$ $-y_{14}y_{15}y_{23} + y_{14}y_{15} + y_{12}y_{25}y_{34} - y_{12}y_{15}y_{34} - y_{12}y_{14}y_{25} + y_{12}y_{14}y_{15}$

	Cx_{14}
y_{123}	0
y_{124}	$-y_{24} + y_{12}$
y_{134}	$-y_{34} + y_{13}$
y_{125}	0
y_{135}	0
y_{145}	$+y_{45} - y_{15}$
y_{234}	0
y_{235}	0
y_{245}	0
y_{345}	0
y_{1234}	$-y_{234} + y_{123} - y_{34} + y_{24}y_{34} - y_{13}y_{23} + y_{12} - y_{12}y_{34} + y_{12}y_{23}$
y_{1324}	$+y_{234} - y_{123} - y_{24} + y_{13} - y_{13}y_{24} + y_{13}y_{23} - y_{12}y_{23} + y_{12}y_{13}$
y_{1235}	0
y_{1245}	$+y_{45} - y_{24}y_{45} - y_{15} + y_{15}y_{24} + y_{12}y_{45} - y_{12}y_{15}$
y_{1325}	0
y_{1345}	$+y_{45} - y_{34}y_{45} - y_{15} + y_{15}y_{34} + y_{13}y_{45} - y_{13}y_{15}$
y_{1425}	$-y_{245} - y_{125} + y_{24}y_{25} + y_{15} + y_{15}y_{25} - y_{15}y_{24} + y_{12}y_{15} - y_{12}y_{25}$
y_{1435}	$-y_{345} - y_{135} + y_{34}y_{35} + y_{15} + y_{15}y_{35} - y_{15}y_{34} - y_{13}y_{35} + y_{13}y_{15}$
y_{2345}	0
y_{2435}	0
y_{12345}	$+y_{45} + y_{45}y_{123} - y_{34}y_{45} + y_{24}y_{34}y_{45} - y_{15} + y_{15}y_{34} - y_{15}y_{123} - y_{15}y_{24}y_{34}$ $-y_{13}y_{23}y_{45} + y_{13}y_{15}y_{23} + y_{12}y_{45} - y_{12}y_{34}y_{45} + y_{12}y_{23}y_{45} + y_{12}y_{15}y_{34}$ $-y_{12}y_{15}y_{23} - y_{12}y_{15}$
y_{12435}	$-y_{345} - y_{135} + y_{34}y_{35} - y_{24}y_{34}y_{35} + y_{15} - y_{15}y_{24} + y_{15}y_{35} - y_{15}y_{34}$ $-y_{15}y_{24}y_{35} + y_{15}y_{24}y_{34} - y_{13}y_{35} + y_{13}y_{24}y_{35} - y_{13}y_{15}y_{24} + y_{13}y_{15}$ $+y_{12}y_{34}y_{35} + y_{12}y_{15}y_{35} - y_{12}y_{15}y_{34} + y_{12}y_{15} - y_{12}y_{13}y_{35} + y_{12}y_{13}y_{15}$
y_{13245}	$-y_{45}y_{123} - y_{24}y_{45} + y_{15}y_{24} + y_{15}y_{123} + y_{13}y_{45} - y_{13}y_{24}y_{45} + y_{13}y_{23}y_{45}$ $+y_{13}y_{15}y_{24} - y_{13}y_{15}y_{23} - y_{13}y_{15} - y_{12}y_{23}y_{45} + y_{12}y_{15}y_{23} + y_{12}y_{13}y_{45}$ $-y_{12}y_{13}y_{15}$
y_{13425}	$-y_{245} - y_{125} - y_{24}y_{25}y_{34} + y_{24}y_{25} + y_{15} + y_{15}y_{25} - y_{15}y_{24} - y_{15}y_{34} - y_{15}y_{25}y_{34}$ $+y_{15}y_{24}y_{34} + y_{13}y_{24}y_{25} + y_{13}y_{15}y_{25} - y_{13}y_{15}y_{24} + y_{13}y_{15} + y_{12}y_{25}y_{34}$ $-y_{12}y_{25} - y_{12}y_{15}y_{34} + y_{12}y_{15} - y_{12}y_{13}y_{25} + y_{12}y_{13}y_{15}$
y_{14235}	$-y_{2435} - y_{2345} - y_{1235} + y_{135} - y_{24}y_{25}y_{35} - y_{24}y_{35} + y_{15}y_{24} - y_{15}y_{35} - y_{15}y_{25}y_{35}$ $+y_{15}y_{24}y_{35} + y_{13}y_{35} - y_{13}y_{24}y_{35} + y_{13}y_{23}y_{35} + y_{13}y_{15}y_{24} - y_{13}y_{15}y_{23}$ $-y_{13}y_{15} + y_{12}y_{25}y_{35} - y_{12}y_{23}y_{35} - y_{12}y_{15}y_{35} + y_{12}y_{15}y_{23} + y_{12}y_{13}y_{35}$ $-y_{12}y_{13}y_{15}$
y_{14325}	$+y_{2345} - y_{1325} + y_{125} + y_{24}y_{25}y_{34} - y_{15} - y_{15}y_{25} + y_{15}y_{34} + y_{15}y_{25}y_{34}$ $-y_{15}y_{24}y_{34} - y_{13}y_{25} - y_{13}y_{23}y_{25} - y_{13}y_{15}y_{25} + y_{13}y_{15}y_{23} - y_{12}y_{25}y_{34}$ $+y_{12}y_{25} + y_{12}y_{23}y_{25} + y_{12}y_{15}y_{34} - y_{12}y_{15}y_{23} - y_{12}y_{15}$

	Cx_{15}
y_{123}	0
y_{124}	0
y_{134}	0
y_{125}	$-y_{25} + y_{12}$
y_{135}	$-y_{35} + y_{13}$
y_{145}	$-y_{45} + y_{14}$
y_{234}	0
y_{235}	0
y_{245}	0
y_{345}	0
y_{1234}	0
y_{1324}	0
y_{1235}	$-y_{235} + y_{123} - y_{35} + y_{25}y_{35} - y_{13}y_{23} + y_{12} - y_{12}y_{35} + y_{12}y_{23}$
y_{1245}	$-y_{245} + y_{124} - y_{45} + y_{25}y_{45} - y_{14}y_{24} + y_{12} - y_{12}y_{45} + y_{12}y_{24}$
y_{1325}	$+y_{235} - y_{123} - y_{25} + y_{13} - y_{13}y_{25} + y_{13}y_{23} - y_{12}y_{23} + y_{12}y_{13}$
y_{1345}	$-y_{345} + y_{134} - y_{45} + y_{35}y_{45} - y_{14}y_{34} + y_{13} + y_{13}y_{34} - y_{13}y_{45}$
y_{1425}	$+y_{245} - y_{124} - y_{25} - y_{14}y_{25} + y_{14}y_{24} + y_{14} - y_{12}y_{24} + y_{12}y_{14}$
y_{1435}	$+y_{345} - y_{134} - y_{35} - y_{14}y_{35} + y_{14}y_{34} + y_{14} - y_{13}y_{34} + y_{13}y_{14}$
y_{2345}	0
y_{2435}	0
y_{12345}	$-y_{2345} + y_{1234} - y_{345} + y_{123} - y_{45} + y_{35}y_{45} - y_{45}y_{123} - y_{25}y_{35}y_{45} + y_{14}y_{123}$ $+y_{14}y_{24}y_{34} - y_{13}y_{23} + y_{13}y_{23}y_{45} - y_{13}y_{23}y_{34} + y_{12} - y_{12}y_{45} + y_{12}y_{23}$ $+y_{12}y_{35}y_{45} - y_{12}y_{24}y_{34} - y_{12}y_{23}y_{45} + y_{12}y_{23}y_{34}$
y_{12435}	$-y_{2435} - y_{1324} - y_{1234} + y_{345} + y_{124} - y_{35} - y_{35}y_{124} + y_{14}y_{24}y_{35} - y_{14}y_{24}y_{34} - y_{14}y_{24}$ $+y_{13}y_{124} - y_{13}y_{24} + y_{13}y_{23}y_{34} - y_{13}y_{23}y_{24} - y_{13}y_{14}y_{24} + y_{12}y_{24}$ $-y_{12}y_{35} - y_{12}y_{24}y_{35} + y_{12}y_{24}y_{34} - y_{12}y_{23}y_{34} + y_{12}y_{23}y_{24}$
y_{13245}	$+y_{2435} + y_{2345} + y_{1324} - y_{245} - y_{123} + y_{45}y_{123} + y_{25}y_{45} - y_{14}y_{123} + y_{13} - y_{13}y_{45}$ $+y_{13}y_{23} + y_{13}y_{25}y_{45} + y_{13}y_{24} - y_{13}y_{23}y_{45} + y_{13}y_{23}y_{24} - y_{12}y_{23} + y_{12}y_{13}$ $+y_{12}y_{23}y_{45} - y_{12}y_{23}y_{24} - y_{12}y_{13}y_{45} + y_{12}y_{13}y_{24}$
y_{13425}	$-y_{2435} - y_{1324} - y_{1234} + y_{245} + y_{134} - y_{25} - y_{25}y_{134} + y_{14}y_{25}y_{34} - y_{14}y_{24}y_{34}$ $-y_{14}y_{34} + y_{13}y_{34} - y_{13}y_{25} - y_{13}y_{25}y_{34} - y_{13}y_{24} + y_{13}y_{23}y_{34} - y_{13}y_{23}y_{24}$ $+y_{12}y_{134} + y_{12}y_{24}y_{34} - y_{12}y_{23}y_{34} + y_{12}y_{23}y_{24} - y_{12}y_{14}y_{34} + y_{12}y_{13}y_{34}$ $-y_{12}y_{13}y_{24}$
y_{14235}	$+y_{2435} + y_{2345} + y_{1324} - y_{235} - y_{124} + y_{35}y_{124} + y_{25}y_{35} + y_{14} + y_{14}y_{25}y_{35}$ $-y_{14}y_{24}y_{35} - y_{14}y_{35} + y_{14}y_{24} - y_{13}y_{124} + y_{13}y_{24} + y_{13}y_{23}y_{24} + y_{13}y_{14}y_{24}$ $-y_{13}y_{14}y_{23} - y_{12}y_{24} + y_{12}y_{14} + y_{12}y_{24}y_{35} - y_{12}y_{23}y_{24} - y_{12}y_{14}y_{35}$ $+y_{12}y_{14}y_{23}$
y_{14325}	$-y_{2345} + y_{1234} + y_{235} - y_{134} + y_{25}y_{134} - y_{14}y_{25}y_{34} + y_{14}y_{24}y_{34} + y_{14}y_{34} - y_{14}y_{25}$ $-y_{13}y_{34} + y_{13}y_{14} + y_{13}y_{25}y_{34} - y_{13}y_{23}y_{34} - y_{13}y_{14}y_{25} + y_{13}y_{14}y_{23} - y_{12}y_{134}$ $-y_{12}y_{24}y_{34} + y_{12}y_{23}y_{34} + y_{12}y_{14}y_{34} - y_{12}y_{14}y_{23} - y_{12}y_{13}y_{34} + y_{12}y_{13}y_{14}$

	Cx_{23}
y_{123}	$+y_{13} - y_{12}$
y_{124}	0
y_{134}	0
y_{125}	0
y_{135}	0
y_{145}	0
y_{234}	$+y_{34} - y_{24}$
y_{235}	$+y_{35} - y_{25}$
y_{245}	0
y_{345}	0
y_{1234}	$+y_{134} - y_{124} + y_{13}y_{34} - y_{12}y_{34} - y_{13}y_{14} + y_{12}y_{14}$
y_{1324}	$-y_{134} + y_{124} - y_{13}y_{24} + y_{12}y_{24} + y_{13}y_{14} - y_{12}y_{14}$
y_{1235}	$+y_{135} - y_{125} + y_{13}y_{35} - y_{12}y_{35} - y_{13}y_{15} + y_{12}y_{15}$
y_{1245}	0
y_{1325}	$-y_{135} + y_{125} - y_{13}y_{25} + y_{12}y_{25} + y_{13}y_{15} - y_{12}y_{15}$
y_{1345}	0
y_{1425}	0
y_{1435}	0
y_{2345}	$+y_{345} - y_{245} - y_{35}y_{45} + y_{34}y_{45} + y_{25}y_{45} - y_{25}y_{34} - y_{24}y_{45} + y_{24}y_{25}$
y_{2435}	$-y_{34}y_{35} + y_{25}y_{34} + y_{24}y_{35} - y_{24}y_{25}$
y_{12345}	$+y_{1345} - y_{1245} + y_{34}y_{145} - y_{34}y_{125} - y_{24}y_{145} + y_{24}y_{125} - y_{13}y_{35}y_{45}$ $+y_{12}y_{35}y_{45} + y_{13}y_{34}y_{45} - y_{12}y_{34}y_{45} + y_{13}y_{15}y_{45} - y_{12}y_{15}y_{45}$ $-y_{13}y_{15}y_{34} + y_{12}y_{15}y_{34} - y_{13}y_{14}y_{45} + y_{12}y_{14}y_{45} + y_{13}y_{14}y_{15} - y_{12}y_{14}y_{15}$
y_{12435}	$-y_{34}y_{135} + y_{34}y_{125} + y_{24}y_{135} - y_{24}y_{125} - y_{13}y_{34}y_{35} + y_{12}y_{34}y_{35}$ $+y_{13}y_{24}y_{35} - y_{12}y_{24}y_{35} + y_{13}y_{15}y_{34} - y_{12}y_{15}y_{34} - y_{13}y_{15}y_{24} + y_{12}y_{15}y_{24}$
y_{13245}	$-y_{1345} + y_{1245} - y_{34}y_{145} + y_{34}y_{135} + y_{24}y_{145} - y_{24}y_{135} + y_{13}y_{25}y_{45}$ $-y_{12}y_{25}y_{45} - y_{13}y_{24}y_{45} + y_{12}y_{24}y_{45} - y_{13}y_{15}y_{45} + y_{12}y_{15}y_{45} + y_{13}y_{15}y_{24}$ $-y_{12}y_{15}y_{24} + y_{13}y_{14}y_{45} - y_{12}y_{14}y_{45} - y_{13}y_{14}y_{15} + y_{12}y_{14}y_{15}$
y_{13425}	$-y_{34}y_{135} + y_{34}y_{125} + y_{24}y_{135} - y_{24}y_{125} - y_{13}y_{25}y_{34} + y_{12}y_{25}y_{34}$ $+y_{13}y_{24}y_{25} - y_{12}y_{24}y_{25} + y_{13}y_{15}y_{34} - y_{12}y_{15}y_{34} - y_{13}y_{15}y_{24} + y_{12}y_{15}y_{24}$
y_{14235}	$+y_{1435} - y_{1425} + y_{35}y_{145} + y_{35}y_{124} - y_{34}y_{145} + y_{34}y_{135} - y_{25}y_{145} - y_{25}y_{124}$ $+y_{24}y_{145} - y_{24}y_{135} - y_{13}y_{24}y_{35} + y_{12}y_{24}y_{35} + y_{13}y_{15}y_{24} - y_{12}y_{15}y_{24}$ $+y_{13}y_{14}y_{35} - y_{12}y_{14}y_{35} - y_{13}y_{14}y_{15} + y_{12}y_{14}y_{15}$
y_{14325}	$-y_{1435} + y_{1425} - y_{35}y_{145} - y_{35}y_{134} + y_{34}y_{145} - y_{34}y_{125} + y_{25}y_{145} + y_{25}y_{134}$ $-y_{24}y_{145} + y_{24}y_{125} + y_{13}y_{25}y_{34} - y_{12}y_{25}y_{34} - y_{13}y_{15}y_{34} + y_{12}y_{15}y_{34}$ $-y_{13}y_{14}y_{25} + y_{12}y_{14}y_{25} + y_{13}y_{14}y_{15} - y_{12}y_{14}y_{15}$

	$c\mathcal{X}_{24}$
y_{123}	0
y_{124}	$+y_{14} - y_{12}$
y_{134}	0
y_{125}	0
y_{135}	0
y_{145}	0
y_{234}	$-y_{34} + y_{23}$
y_{235}	0
y_{245}	$+y_{45} - y_{25}$
y_{345}	0
y_{1234}	$+y_{14} + y_{14}y_{23} - y_{12} - y_{14}y_{34} + y_{12}y_{34} - y_{12}y_{23}$
y_{1324}	$+y_{134} + y_{123} - y_{14} - y_{14}y_{23} + y_{12}y_{23} - y_{12}y_{13}$
y_{1235}	0
y_{1245}	$+y_{145} - y_{125} + y_{14}y_{45} - y_{14}y_{15} - y_{12}y_{45} + y_{12}y_{15}$
y_{1325}	0
y_{1345}	0
y_{1425}	$-y_{145} + y_{125} - y_{14}y_{25} + y_{14}y_{15} + y_{12}y_{25} - y_{12}y_{15}$
y_{1435}	0
y_{2345}	$+y_{45} - y_{34}y_{45} - y_{25} + y_{25}y_{34} + y_{23}y_{45} - y_{23}y_{25}$
y_{2435}	$-y_{345} - y_{235} + y_{34}y_{35} - y_{25} + y_{25}y_{35} + y_{25}y_{34} - y_{23}y_{35} + y_{23}y_{25}$
y_{12345}	$+y_{145} - y_{125} - y_{34}y_{145} + y_{34}y_{125} + y_{23}y_{145} - y_{23}y_{125} + y_{14}y_{45} - y_{14}y_{15}$ $-y_{14}y_{34}y_{45} + y_{14}y_{23}y_{45} + y_{14}y_{15}y_{34} - y_{14}y_{15}y_{23} - y_{12}y_{45} + y_{12}y_{15}$ $+y_{12}y_{34}y_{45} - y_{12}y_{23}y_{45} - y_{12}y_{15}y_{34} + y_{12}y_{15}y_{23}$
y_{12435}	$+y_{1435} - y_{1235} + y_{125} + y_{34}y_{135} - y_{34}y_{125} - y_{23}y_{135} + y_{23}y_{125} + y_{14}y_{35}$ $+y_{14}y_{34}y_{35} + y_{14}y_{15}y_{35} - y_{14}y_{15}y_{34} - y_{12}y_{15} - y_{12}y_{34}y_{35} - y_{12}y_{15}y_{35}$ $+y_{12}y_{15}y_{34} + y_{12}y_{13}y_{35} - y_{12}y_{13}y_{15}$
y_{13245}	$+y_{1345} - y_{1325} - y_{145} + y_{45}y_{135} + y_{45}y_{123} + y_{34}y_{145} - y_{34}y_{135} - y_{25}y_{135} - y_{25}y_{123}$ $-y_{23}y_{145} + y_{23}y_{135} - y_{14}y_{45} + y_{14}y_{15} - y_{14}y_{23}y_{45} + y_{14}y_{15}y_{23} + y_{12}y_{23}y_{45}$ $-y_{12}y_{15}y_{23} - y_{12}y_{13}y_{45} + y_{12}y_{13}y_{15}$
y_{13425}	$-y_{1345} + y_{1325} + y_{125} - y_{45}y_{135} + y_{45}y_{134} + y_{34}y_{135} - y_{34}y_{125} + y_{25}y_{135} - y_{25}y_{134}$ $-y_{23}y_{135} + y_{23}y_{125} + y_{14}y_{25}y_{34} - y_{14}y_{15}y_{34} + y_{12}y_{25} - y_{12}y_{15} - y_{12}y_{25}y_{34}$ $+y_{12}y_{15}y_{34} + y_{12}y_{13}y_{25} - y_{12}y_{13}y_{15}$
y_{14235}	$-y_{1435} + y_{1235} - y_{145} + y_{34}y_{145} - y_{34}y_{135} - y_{23}y_{145} + y_{23}y_{135} - y_{14}y_{35} + y_{14}y_{15}$ $+y_{14}y_{25}y_{35} - y_{14}y_{23}y_{35} - y_{14}y_{15}y_{35} + y_{14}y_{15}y_{23} - y_{12}y_{25}y_{35} + y_{12}y_{23}y_{35}$ $+y_{12}y_{15}y_{35} - y_{12}y_{15}y_{23} - y_{12}y_{13}y_{35} + y_{12}y_{13}y_{15}$
y_{14325}	$+y_{145} - y_{125} - y_{34}y_{145} + y_{34}y_{125} + y_{23}y_{145} - y_{23}y_{125} + y_{14}y_{25} - y_{14}y_{15}$ $-y_{14}y_{25}y_{34} + y_{14}y_{23}y_{25} + y_{14}y_{15}y_{34} - y_{14}y_{15}y_{23} - y_{12}y_{25} + y_{12}y_{15}$ $+y_{12}y_{25}y_{34} - y_{12}y_{23}y_{25} - y_{12}y_{15}y_{34} + y_{12}y_{15}y_{23}$

	CT_{25}
y_{123}	0
y_{124}	0
y_{134}	0
y_{125}	$+y_{15} - y_{12}$
y_{135}	0
y_{145}	0
y_{234}	0
y_{235}	$-y_{35} + y_{23}$
y_{245}	$-y_{45} + y_{24}$
y_{345}	0
y_{1234}	0
y_{1324}	0
y_{1235}	$+y_{15} - y_{15}y_{35} + y_{15}y_{23} - y_{12} + y_{12}y_{35} - y_{12}y_{23}$
y_{1245}	$+y_{15} - y_{15}y_{45} + y_{15}y_{24} - y_{12} + y_{12}y_{45} - y_{12}y_{24}$
y_{1325}	$+y_{135} + y_{123} - y_{15} - y_{15}y_{23} + y_{12}y_{23} - y_{12}y_{13}$
y_{1345}	0
y_{1425}	$+y_{145} + y_{124} - y_{15} - y_{15}y_{24} + y_{12}y_{24} - y_{12}y_{14}$
y_{1435}	0
y_{2345}	$-y_{345} + y_{234} - y_{45} + y_{35}y_{45} - y_{24}y_{34} + y_{23} - y_{23}y_{45} + y_{23}y_{34}$
y_{2435}	$+y_{345} - y_{234} - y_{35} + y_{24} - y_{24}y_{35} + y_{24}y_{34} - y_{23}y_{34} + y_{23}y_{24}$
y_{12345}	$-y_{15}y_{45} + y_{15}y_{23} + y_{15} + y_{15}y_{35}y_{45} - y_{15}y_{24}y_{34} - y_{15}y_{23}y_{45} + y_{15}y_{23}y_{34}$ $-y_{12}y_{23} + y_{12}y_{45} - y_{12} - y_{12}y_{35}y_{45} + y_{12}y_{24}y_{34} + y_{12}y_{23}y_{45} - y_{12}y_{23}y_{34}$
y_{12435}	$+y_{15}y_{24} - y_{15}y_{35} - y_{15}y_{24}y_{35} + y_{15}y_{24}y_{34} - y_{15}y_{23}y_{34} + y_{15}y_{23}y_{24}$ $+y_{12}y_{35} - y_{12}y_{24} + y_{12}y_{24}y_{35} - y_{12}y_{24}y_{34} + y_{12}y_{23}y_{34} - y_{12}y_{23}y_{24}$
y_{13245}	$+y_{135} + y_{123} - y_{45}y_{135} - y_{45}y_{123} + y_{24}y_{135} + y_{24}y_{123} + y_{15}y_{45} - y_{15}y_{24} - y_{15}y_{23}$ $-y_{15} + y_{15}y_{23}y_{45} - y_{15}y_{23}y_{24} + y_{12}y_{23} - y_{12}y_{13} - y_{12}y_{23}y_{45} + y_{12}y_{23}y_{24}$ $+y_{12}y_{13}y_{45} - y_{12}y_{13}y_{24}$
y_{13425}	$+y_{1345} + y_{1324} + y_{1234} - y_{135} + y_{45}y_{135} - y_{45}y_{134} - y_{24}y_{135} + y_{24}y_{134} + y_{15}y_{24}$ $+y_{15}y_{134} + y_{15}y_{24}y_{34} - y_{15}y_{23}y_{34} + y_{15}y_{23}y_{24} - y_{12}y_{134} - y_{12}y_{24}y_{34}$ $+y_{12}y_{23}y_{34} - y_{12}y_{23}y_{24} + y_{12}y_{14}y_{34} - y_{12}y_{13}y_{34} + y_{12}y_{13}y_{24}$
y_{14235}	$+y_{145} + y_{124} - y_{35}y_{145} - y_{35}y_{124} - y_{15}y_{24} + y_{15}y_{35} - y_{15}y_{23} + y_{23}y_{145} + y_{23}y_{124}$ $-y_{15} + y_{15}y_{24}y_{35} - y_{15}y_{23}y_{24} + y_{12}y_{24} - y_{12}y_{14} - y_{12}y_{24}y_{35} + y_{12}y_{23}y_{24}$ $+y_{12}y_{14}y_{35} - y_{12}y_{14}y_{23}$
y_{14325}	$+y_{1435} - y_{1234} - y_{145} + y_{35}y_{145} + y_{35}y_{134} + y_{15}y_{23} - y_{23}y_{145} - y_{23}y_{134} + y_{15}$ $-y_{15}y_{134} - y_{15}y_{24}y_{34} + y_{15}y_{23}y_{34} + y_{12}y_{134} + y_{12}y_{24}y_{34} - y_{12}y_{23}y_{34}$ $-y_{12}y_{14}y_{34} + y_{12}y_{14}y_{23} + y_{12}y_{13}y_{34} - y_{12}y_{13}y_{14}$

	$c\mathcal{X}_{34}$
y_{123}	0
y_{124}	0
y_{134}	$+y_{14} - y_{13}$
y_{125}	0
y_{135}	0
y_{145}	0
y_{234}	$+y_{24} - y_{23}$
y_{235}	0
y_{245}	0
y_{345}	$+y_{45} - y_{35}$
y_{1234}	$+y_{124} - y_{123} - y_{14}y_{23} + y_{13}y_{23}$
y_{1324}	$-y_{14}y_{24} + y_{13}y_{24} + y_{14}y_{23} - y_{13}y_{23}$
y_{1235}	0
y_{1245}	0
y_{1325}	0
y_{1345}	$+y_{145} - y_{135} + y_{14}y_{45} - y_{13}y_{45} - y_{14}y_{15} + y_{13}y_{15}$
y_{1425}	0
y_{1435}	$-y_{145} + y_{135} - y_{14}y_{35} + y_{13}y_{35} + y_{14}y_{15} - y_{13}y_{15}$
y_{2345}	$+y_{245} - y_{235} + y_{24}y_{45} - y_{23}y_{45} - y_{24}y_{25} + y_{23}y_{25}$
y_{2435}	$-y_{245} + y_{235} - y_{24}y_{35} + y_{23}y_{35} + y_{24}y_{25} - y_{23}y_{25}$
y_{12345}	$+y_{1245} - y_{1235} + y_{45}y_{125} - y_{35}y_{125} - y_{45}y_{123} + y_{35}y_{123} + y_{24}y_{145} - y_{23}y_{145}$ $-y_{24}y_{125} + y_{23}y_{125} - y_{14}y_{23}y_{45} + y_{13}y_{23}y_{45} + y_{14}y_{15}y_{23} - y_{13}y_{15}y_{23}$
y_{12435}	$-y_{1245} + y_{1235} - y_{45}y_{125} + y_{35}y_{125} + y_{45}y_{124} - y_{35}y_{124} - y_{24}y_{135} + y_{23}y_{135}$ $+y_{24}y_{125} - y_{23}y_{125} + y_{14}y_{24}y_{35} - y_{13}y_{24}y_{35} - y_{14}y_{15}y_{24} + y_{13}y_{15}y_{24}$
y_{13245}	$-y_{24}y_{145} + y_{23}y_{145} + y_{24}y_{135} - y_{23}y_{135} - y_{14}y_{24}y_{45} + y_{13}y_{24}y_{45} + y_{14}y_{23}y_{45}$ $-y_{13}y_{23}y_{45} + y_{14}y_{15}y_{24} - y_{13}y_{15}y_{24} - y_{14}y_{15}y_{23} + y_{13}y_{15}y_{23}$
y_{13425}	$+y_{1425} - y_{1325} - y_{24}y_{135} + y_{23}y_{135} + y_{24}y_{125} - y_{23}y_{125} + y_{14}y_{25} - y_{13}y_{25}$ $+y_{14}y_{24}y_{25} - y_{13}y_{24}y_{25} + y_{14}y_{15}y_{25} - y_{13}y_{15}y_{25} - y_{14}y_{15}y_{24} + y_{13}y_{15}y_{24}$
y_{14235}	$-y_{24}y_{145} + y_{23}y_{145} + y_{24}y_{135} - y_{23}y_{135} - y_{14}y_{24}y_{35} + y_{13}y_{24}y_{35} + y_{14}y_{23}y_{35}$ $-y_{13}y_{23}y_{35} + y_{14}y_{15}y_{24} - y_{13}y_{15}y_{24} - y_{14}y_{15}y_{23} + y_{13}y_{15}y_{23}$
y_{14325}	$-y_{1425} + y_{1325} + y_{24}y_{145} - y_{23}y_{145} - y_{24}y_{125} + y_{23}y_{125} - y_{14}y_{25} + y_{13}y_{25}$ $-y_{14}y_{23}y_{25} + y_{13}y_{23}y_{25} - y_{14}y_{15}y_{25} + y_{13}y_{15}y_{25} + y_{14}y_{15}y_{23} - y_{13}y_{15}y_{23}$

	Cx_{35}
y_{123}	0
y_{124}	0
y_{134}	0
y_{125}	0
y_{135}	$+y_{15} - y_{13}$
y_{145}	0
y_{234}	0
y_{235}	$+y_{25} - y_{23}$
y_{245}	0
y_{345}	$-y_{45} + y_{34}$
y_{1234}	0
y_{1324}	0
y_{1235}	$+y_{125} - y_{123} - y_{15}y_{23} + y_{13}y_{23}$
y_{1245}	0
y_{1325}	$-y_{15}y_{25} + y_{15}y_{23} + y_{13}y_{25} - y_{13}y_{23}$
y_{1345}	$+y_{15} - y_{15}y_{45} + y_{15}y_{34} - y_{13} + y_{13}y_{45} - y_{13}y_{34}$
y_{1425}	0
y_{1435}	$+y_{145} + y_{134} - y_{15} - y_{15}y_{34} + y_{13}y_{34} - y_{13}y_{14}$
y_{2345}	$+y_{25} - y_{25}y_{45} + y_{25}y_{34} - y_{23} + y_{23}y_{45} - y_{23}y_{34}$
y_{2435}	$+y_{245} + y_{234} - y_{25} - y_{25}y_{34} + y_{23}y_{34} - y_{23}y_{24}$
y_{12345}	$+y_{125} - y_{123} - y_{45}y_{125} + y_{34}y_{125} + y_{45}y_{123} - y_{34}y_{123} - y_{15}y_{23} + y_{15}y_{23}y_{45}$ $-y_{15}y_{23}y_{34} + y_{13}y_{23} - y_{13}y_{23}y_{45} + y_{13}y_{23}y_{34}$
y_{12435}	$+y_{1245} + y_{1324} + y_{1234} - y_{125} + y_{45}y_{125} - y_{34}y_{125} - y_{45}y_{124} + y_{34}y_{124} + y_{15}y_{124}$ $+y_{15}y_{23}y_{34} - y_{15}y_{23}y_{24} + y_{13}y_{24} - y_{13}y_{23}y_{34} + y_{13}y_{23}y_{24} + y_{13}y_{14}y_{24}$ $-y_{13}y_{124}$
y_{13245}	$+y_{15}y_{23} + y_{15}y_{25}y_{45} - y_{15}y_{23}y_{45} + y_{15}y_{23}y_{24} - y_{13}y_{23} - y_{13}y_{25}y_{45}$ $+y_{13}y_{23}y_{45} - y_{13}y_{23}y_{24}$
y_{13425}	$-y_{15}y_{25} - y_{15}y_{25}y_{34} + y_{15}y_{23}y_{34} - y_{15}y_{23}y_{24} + y_{13}y_{25} + y_{13}y_{25}y_{34}$ $-y_{13}y_{23}y_{34} + y_{13}y_{23}y_{24}$
y_{14235}	$+y_{1425} - y_{1324} + y_{25}y_{145} + y_{25}y_{124} - y_{23}y_{145} - y_{23}y_{124} + y_{15}y_{23} - y_{15}y_{124}$ $+y_{15}y_{23}y_{24} - y_{13}y_{24} - y_{13}y_{23}y_{24} - y_{13}y_{14}y_{24} + y_{13}y_{14}y_{23} + y_{13}y_{124}$
y_{14325}	$-y_{25}y_{145} - y_{25}y_{134} + y_{23}y_{145} + y_{23}y_{134} + y_{15}y_{25} - y_{15}y_{23} + y_{15}y_{25}y_{34}$ $-y_{15}y_{23}y_{34} - y_{13}y_{25}y_{34} + y_{13}y_{23}y_{34} + y_{13}y_{14}y_{25} - y_{13}y_{14}y_{23}$

	cx_{45}
y_{123}	0
y_{124}	0
y_{134}	0
y_{125}	0
y_{135}	0
y_{145}	$+y_{15} - y_{14}$
y_{234}	0
y_{235}	0
y_{245}	$+y_{25} - y_{24}$
y_{345}	$+y_{35} - y_{34}$
y_{1234}	0
y_{1324}	0
y_{1235}	0
y_{1245}	$+y_{125} - y_{124} - y_{15}y_{24} + y_{14}y_{24}$
y_{1325}	0
y_{1345}	$+y_{135} - y_{134} - y_{15}y_{34} + y_{14}y_{34}$
y_{1425}	$-y_{15}y_{25} + y_{14}y_{25} + y_{15}y_{24} - y_{14}y_{24}$
y_{1435}	$-y_{15}y_{35} + y_{14}y_{35} + y_{15}y_{34} - y_{14}y_{34}$
y_{2345}	$+y_{235} - y_{234} - y_{25}y_{34} + y_{24}y_{34}$
y_{2435}	$-y_{25}y_{35} + y_{24}y_{35} + y_{25}y_{34} - y_{24}y_{34}$
y_{12345}	$+y_{1235} - y_{1234} + y_{35}y_{125} - y_{34}y_{125} - y_{35}y_{123} + y_{34}y_{123} + y_{15}y_{123} - y_{14}y_{123}$ $+y_{15}y_{24}y_{34} - y_{14}y_{24}y_{34}$
y_{12435}	$-y_{35}y_{125} + y_{34}y_{125} + y_{35}y_{124} - y_{34}y_{124} + y_{15}y_{24}y_{35} - y_{14}y_{24}y_{35} - y_{15}y_{24}y_{34}$ $+y_{14}y_{24}y_{34}$
y_{13245}	$+y_{1325} - y_{1324} + y_{25}y_{135} - y_{24}y_{135} + y_{25}y_{123} - y_{24}y_{123} - y_{15}y_{123} + y_{14}y_{123}$
y_{13425}	$-y_{25}y_{135} + y_{24}y_{135} + y_{25}y_{134} - y_{24}y_{134} + y_{15}y_{25}y_{34} - y_{14}y_{25}y_{34} - y_{15}y_{24}y_{34}$ $+y_{14}y_{24}y_{34}$
y_{14235}	$+y_{15}y_{25}y_{35} - y_{14}y_{25}y_{35} - y_{15}y_{24}y_{35} + y_{14}y_{24}y_{35}$
y_{14325}	$-y_{15}y_{25}y_{34} + y_{14}y_{25}y_{34} + y_{15}y_{24}y_{34} - y_{14}y_{24}y_{34}$

REFERENCES

- [1] E. Graff, *On braids and links up to link-homotopy*, preprint arXiv:2210.01539.
- [2] M.N. Gusarov, *Variations of knotted graphs*. The geometric technique of n -equivalence. (Russian), *Algebra i Analiz* 12 (2000), no. 4, 79–125; translation in *St. Petersburg Math. J.* **12** (2001), no. 4, 569–604.
- [3] N. Habegger and X.-S. Lin, *The classification of links up to link-homotopy*, *J. Amer. Math. Soc.* 3:2 (1990), 389–419.
- [4] K. Habiro, *Claspers and finite type invariants of links*, *Geom. Topol.* **4** (2000), 1–83.
- [5] Hughes, *Structured groups and link-homotopy*, *J. Knot Theory Ramifications*, **2** (1993), no.1, 37–63.
- [6] Y. Kotorii, *A relation between Milnor's μ -invariants and HOMFLYPT polynomials*, *J. Knot Theory Ramifications*, 25, 2016, no. 13, 1650072, 12pp.
- [7] Y. Kotorii and A. Mizusawa, *HL-homotopy of handlebody-links and Milnor's invariants*, *Topology Appl.* **221** (2017), 715–736.
- [8] Y. Kotorii and A. Mizusawa, *Homotopy classes of 4-component links and claspers*, arXiv:math/1910.08653.
- [9] Y. Kotorii and A. Mizusawa, *An algorithm which determine whether given two 4-component links are link-homotopic*, a talk in "MSJ Autumn Meeting", 22 Sep (2020), <http://www.mathsoc.jp/assets/file/activity/meeting/kumamoto20sept/summary20sept.ja.20200822.pdf>, p.87.
- [10] J. P. Levine, *Surgery on links and the $\bar{\mu}$ -invariants*, *Topology*, **26**, (1987), 45–61.
- [11] J. P. Levine, *An approach to homotopy classification of links*, *Trans. Amer. Math. Soc.* **306** (1988), 361–387.
- [12] J-B. Meilhan, *On surgery along Brunnian links in 3-manifolds*, *Alge. Geom. Topol.* 6 (2006), 2417–2453.
- [13] J-B. Meilhan, Y. Yasuhara, *On C_n -moves for links*. *Pacific J. Math.* **238** (2008), no. 1, 119–143.
- [14] J-B. Meilhan, Y. Yasuhara, *Milnor invariants and the HOMFLYPT polynomial*, *Geom. Topol.* **16** (2012), no.2, 889–917.
- [15] J. Milnor, *Link groups*, *Annals of Mathematics* (2), **59** (1954), p177–195.
- [16] J. Milnor, *Isotopy of links*, *Algebraic geometry and topology, A symposium in honor of S. Lefschetz*, pp. 280–306, Princeton University Press, Princeton, N. J., 1957.
- [17] A. Mizusawa Web page: <https://drive.google.com/drive/folders/1prhSLrcqolUZCQa3A6Ix2iWrvGu9FyGG>.
- [18] A. Mizusawa and R. Nikkuni *A homotopy classification of two-component spatial graphs up to neighborhood equivalence*, *Topology Appl.* **196** (2015), part B, 710–718.
- [19] K. Taniyama and A. Yasuhara, *Clasp-pass moves on knots, links and spatial graphs*, *Topology Appl.* **122** (2002), 501–529.
- [20] A. Yasuhara, *Self delta-equivalence for links whose Milnor's isotopy invariants vanish*, *Trans. Amer. Math. Soc.* **361** (2009), 4721–4749.

(Kotorii) MATHEMATICS PROGRAM, GRADUATE SCHOOL OF ADVANCED SCIENCE AND ENGINEERING, HIROSHIMA UNIVERSITY, 1-7-1 KAGAMIYAMA HIGASHI-HIROSHIMA CITY, HIROSHIMA 739-8521 JAPAN

(Kotorii) INTERNATIONAL INSTITUTE FOR SUSTAINABILITY WITH KNOTTED CHIRAL META MATTER (SKCM²), HIROSHIMA UNIVERSITY, 1-7-1 KAGAMIYAMA HIGASHI-HIROSHIMA CITY, HIROSHIMA 739-8521 JAPAN

(Kotorii) INTERDISCIPLINARY THEORETICAL AND MATHEMATICAL SCIENCES PROGRAM, RIKEN,
2-1, HIROSAWA, WAKO, SAITAMA 351-0198, JAPAN

Email address: `kotorii@hiroshima-u.ac.jp`

(Mizusawa) FACULTY OF SCIENCE AND ENGINEERING, WASEDA UNIVERSITY, 3-4-1 OKUBO, SHINJUKU-
KU, TOKYO 169-8555, JAPAN

Email address: `a_mizusawa@aoni.waseda.jp`