

# MERIDIONAL RANK OF WHITEHEAD DOUBLES

EDERSON R. F. DUTRA

ABSTRACT. We prove that the meridional rank and the bridge number of the Whitehead double of a prime algebraically tame knot coincide. Algebraically tame knots are a broad generalization of torus knots and iterated cable knots.

## 1. INTRODUCTION

Let  $\mathfrak{k} \subseteq S^3$  be a knot. The *bridge number* of  $\mathfrak{k}$ , denoted by  $b(\mathfrak{k})$ , is defined as the minimal number of bridges in a bridge presentation of  $\mathfrak{k}$ . A *meridian* of  $\mathfrak{k}$  is an element of  $\pi_1(S^3 \setminus \mathfrak{k})$  which is represented by a curve freely homotopic to the boundary path of a disk in  $S^3$  that intersects  $\mathfrak{k}$  in exactly one point. The *meridional rank* of  $\mathfrak{k}$ , denoted by  $w(\mathfrak{k})$ , is defined as the minimal number of meridians needed to generate  $\pi_1(S^3 \setminus \mathfrak{k})$ . It is known that any bridge presentation of  $\mathfrak{k}$  containing  $b$  bridges yields a generating set of  $\pi_1(S^3 \setminus \mathfrak{k})$  consisting of  $b$  meridians. Therefore we always have the inequality  $w(\mathfrak{k}) \leq b(\mathfrak{k})$ .

It was asked by S. Cappell and J. Shaneson [16, Problem 1.11] as well as by K. Murasugi whether the equality  $b(\mathfrak{k}) = w(\mathfrak{k})$  always holds. To this day no counterexamples are known but the equality has been verified for many classes of knots (using a variety of techniques): knots whose group is generated by two meridians [10], (generalized) Montesinos links [9, 17], torus knots [18], iterated cable knots [12, 13], knots whose exterior is a graph manifold [7], links of meridional rank 3 whose double branched covers are graph manifolds [8], and recently for twisted and arborescent links [3, 4].

An interesting result proved recently by R. Blair, A. K̆uchukova, R. Velazquez, and P. Villanueva [6] states that the bridge number of any knot equals its Wirtinger number, an invariant closely related to the meridional rank. This result therefore establishes a weak version of Cappell and Shaneson's question, and also points to new approaches to this problem.

In this article we show that the conjecture holds for Whitehead doubles of prime algebraically tame knots and we also show that the class of prime algebraically tame knots is closed under braid satellites.

**Theorem 1.1.** *Let  $\mathfrak{k}$  be a Whitehead double of a prime algebraically tame knot. Then it holds  $w(\mathfrak{k}) = b(\mathfrak{k})$ .*

**Theorem 1.2.** *The class of prime algebraically tame knots is closed under taking satellites with braid pattern.*

---

Research supported by FAPESP, São Paulo Research Foundation, grants 2018/08187-6 and 2021/12276-7.

**Acknowledgments.** I would like to thank the faculty of mathematics of the University of Regensburg for the hospitality during my one year visit as a pos-doctoral guest in Regensburg, in special to prof. Stefan Friedl and Filip Misev for helpful conversations during the preparation of this article and for Claudius Zibrowius for a nice office atmosphere.

## 2. BASIC DEFINITIONS

In this section we fix the notation needed to prove Theorem 1.1 and Theorem 1.2. We closely follow the notation from [11]. Let  $\mathfrak{k} \subseteq S^3$  be a knot. The knot exterior of  $\mathfrak{k}$  is defined as

$$E(\mathfrak{k}) := S^3 \setminus \text{Int } V(\mathfrak{k})$$

where  $V(\mathfrak{k})$  is a regular neighborhood of  $\mathfrak{k}$ . Let  $x_0 \in \partial E(\mathfrak{k}) = \partial V(\mathfrak{k})$ . The group of  $\mathfrak{k}$  is defined as  $G(\mathfrak{k}) := \pi_1(E(\mathfrak{k}), x_0)$  and the peripheral subgroup of  $\mathfrak{k}$  is defined as  $P(\mathfrak{k}) = \pi_1(\partial E(\mathfrak{k}), x_0)$ .

A meridian of  $\mathfrak{k}$  was previously defined as an element of  $G(\mathfrak{k})$  represented by a curve freely homotopic to the boundary path of a disk which intersects  $\mathfrak{k}$  in exactly one point. For our purposes, however, we need a fixed meridian.

Let  $\mu \subset \partial V(\mathfrak{k})$  be the boundary of a meridional disk of  $V(\mathfrak{k})$  such that  $x_0 \in \mu$ . Define  $m := [\mu] \in P(\mathfrak{k})$ . Thus  $m$  is a meridian of  $\mathfrak{k}$  as defined previously and any other meridian of  $\mathfrak{k}$  is conjugate to  $m$ .

Let also  $\lambda \subseteq \partial E(\mathfrak{k})$  be a longitudinal curve of  $\mathfrak{k}$ , i.e. a simple closed curve that bounds an orientable surface in  $E(\mathfrak{k})$ , such that  $x_0 = \lambda \cap \mu$ . Define  $l := [\lambda] \in P(\mathfrak{k})$ .

Observe that  $\{m, l\}$  is a basis for  $P(\mathfrak{k})$ .

**2.1. Satellite knots.** We recall the construction of satellite knots. Let  $\mathfrak{k}_1 \subseteq S^3$  be a non-trivial knot. Let  $V \subseteq S^3$  be a standardly embedded unknotted solid torus and let  $\mathfrak{k}_0$  a knot contained in the interior of  $V$  such that  $\mathfrak{k}_0$  intersects each meridional disk of  $V$  in at least one point. For any homeomorphism  $h$  from  $V$  onto a regular neighborhood  $V(\mathfrak{k}_1)$  of  $\mathfrak{k}_1$  we call the knot  $\mathfrak{k}_h := h(\mathfrak{k}_0)$  a *satellite knot with companion  $\mathfrak{k}_1$  and pattern  $(V, \mathfrak{k}_0)$* , see Figure 1. We will be specially concerned with

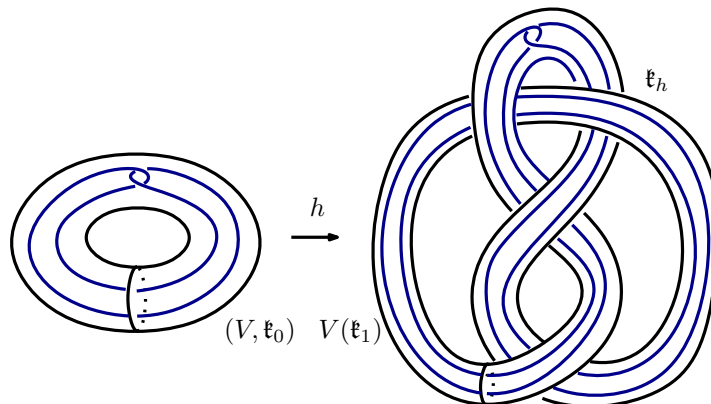

FIGURE 1. Whitehead double of the figure-eight knot.

the following classes of satellite knots:

- If  $(V, \mathfrak{k}_0)$  is the pattern described in Figure 1, then  $\mathfrak{k}_h$  is called a *Whitehead double* of  $\mathfrak{k}_1$ .
- If  $\mathfrak{k}_0$  lies in a torus  $T \subseteq \text{Int}(V)$  which is parallel to  $\partial V$ , then  $\mathfrak{k}_h$  is called a *cable knot on  $\mathfrak{k}_1$* .
- If  $\mathfrak{k}_0$  is a closed braid standardly embedded in  $V$  as shown in Figure 2, i.e. any meridional disk  $p \times D^2 \subseteq V$  intersects  $\mathfrak{k}_0$  in exactly  $n$  points, then  $\mathfrak{k}_h$  is called a *satellite knot with braid pattern*.

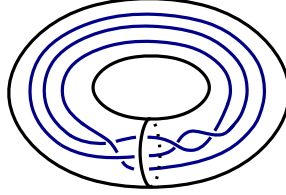

FIGURE 2.  $\mathfrak{k}_0$  is the closed braid  $\hat{\beta}$  where  $\beta = \sigma_2 \sigma_1^{-1} \sigma_2^2$ .

The exterior of a satellite knot  $\mathfrak{k} = h(\mathfrak{k}_0)$  clearly decomposes as  $E(\mathfrak{k}) = h(V \setminus \text{Int } V(\mathfrak{k}_0)) \cup E(\mathfrak{k}_1)$  and  $h(V \setminus \text{Int } V(\mathfrak{k}_0)) \cap E(\mathfrak{k}_1) = h(\partial V) = \partial E(\mathfrak{k}_1)$  where  $V(\mathfrak{k}_0) \subseteq \text{Int}(V)$  is a regular neighborhood of  $\mathfrak{k}_0$  in  $V$ . The Theorem of Seifert and van-Kampen implies that

$$G(\mathfrak{k}) = \pi_1(V \setminus \text{Int } V(\mathfrak{k}_0)) *_{(\alpha, C, \omega)} G(\mathfrak{k}_1)$$

where

- $C := \langle m_e, l_e \rangle \cong \mathbb{Z} \oplus \mathbb{Z}$ .
- $\alpha : C \rightarrow \pi_1(V \setminus \text{Int } V(\mathfrak{k}_0))$  is given by

$$\alpha(m_e) = m_V \quad \text{and} \quad \omega(l_e) = l_V$$

where  $m_V$  is a meridian of  $V$  and  $l_V$  is a meridian of the solid torus  $S^3 \setminus \text{Int } V$  (and therefore a longitude of  $V$ ).

- $\omega : C \rightarrow G(\mathfrak{k}_1)$  is defined by

$$\omega(m_e) = h_*(m_V) \quad \text{and} \quad \omega(l_e) = h_*(l_V)$$

where  $h_*$  is the induced isomorphism  $\pi_1(\partial V) \rightarrow P(\mathfrak{k}_1)$ .

Observe that we can always take  $h_*(m_V)$  as the fixed meridian of  $\mathfrak{k}_1$  and therefore denote  $h_*(m_V)$  simply by  $m_1$ .

The main tool that we are going to use in this paper is the theory of folding in graph of groups developed in [22] which is a slightly variation of the theory developed in [15]. For this reason, we will always consider the amalgamated free product

$$G(\mathfrak{k}) = \pi_1(V \setminus \text{Int } V(\mathfrak{k}_0)) *_{(\alpha, C, \omega)} G(\mathfrak{k}_1)$$

as a graph of groups  $\mathbb{A}$  having a pair of vertices  $v_0$  and  $v_1$  such that

$$A_{v_0} = \pi_1(V \setminus \text{Int } V(\mathfrak{k}_0)) \quad \text{and} \quad A_{v_1} = G(\mathfrak{k}_1)$$

and a single edge pair  $\{e, e^{-1}\}$  with  $\alpha(e) = v_0$  and  $\omega(e) = v_1$  such that

$$A_e = A_{e^{-1}} := C = \langle m_e, l_e \rangle.$$

The boundary monomorphisms  $\alpha_e : A_e \rightarrow A_{v_0}$  and  $\omega_e : A_e \rightarrow A_{v_1}$  coincide with the monomorphisms defined before, that is,  $\alpha_e := \alpha$  and  $\omega_e := \omega$ , see Figure 3.

$$A_{v_0} = \pi_1(V \setminus \text{Int } V(\mathfrak{k}_0)) \xleftarrow{\alpha_e} A_e = \langle m_e, l_e \rangle \xrightarrow{\omega_e} A_{v_1} = G(\mathfrak{k}_1)$$

FIGURE 3. The graph of groups  $\mathbb{A}$ .

**2.2. The group of the braid space and cable space.** Assume that  $\mathfrak{k}_0 \subset V$  is a closed braid, i.e.  $\mathfrak{k}_0 = \hat{\beta}$  where  $\beta$  is an  $n$ -braid whose associate permutation  $\tau \in S_n$  is cycle of length  $n$ . The *braid space* of  $\beta$  is defined as

$$BS(\beta) := V \setminus \text{Int } V(\hat{\beta})$$

where  $V(\hat{\beta})$  is a regular neighborhood of  $\mathfrak{k}_0 = \hat{\beta}$ . We can construct  $BS(\beta)$  as a mapping torus in the following way. Let  $D^2 = \{z \in \mathbb{C} \mid \|z\| \leq 1\}$  and

$$\Sigma = D^2 \setminus \text{Int}(\delta_1 \cup \dots \cup \delta_n)$$

where  $\delta_1$  is a small disk in the interior of  $D^2$ ,  $\delta_i = \rho_0^{i-1}(\delta_1)$  for  $2 \leq i \leq n$  and where  $\rho_0 : D^2 \rightarrow D^2$  is a rotation by an angle of  $2\pi/n$  about the origin  $x_0 := 0$ . It is known that there is a homeomorphism  $\rho : (\Sigma, x_0) \rightarrow (\Sigma, x_0)$  such that  $\rho(\delta_i) = \delta_{\tau(i)}$  for all  $1 \leq i \leq n$  and

$$BS(\beta) \cong \Sigma \times [0, 1]/(x, 0) \sim (\rho(x), 1)$$

In the case of a cable pattern the homeomorphism  $\rho$  is a rotation about  $x_0$  through an angle of  $2\pi(m/n)$  for some integer  $m$  such that  $\text{gcd}(m, n) = 1$ . In this case we denote  $BS(\beta)$  by  $CS(n, m)$ .

Denote the free generators of  $\pi_1(\Sigma, x_0)$  corresponding to the boundary paths of the removed disks  $\delta_1, \dots, \delta_n$  by  $x_1, \dots, x_n$  respectively. Let  $t \in \pi_1(BS(\beta), x_0)$  be the element represented by the loop  $x_0 \times I \subset BS(\beta)$ . Therefore,

$$\pi_1(BS(\beta), x_0) = \pi_1(\Sigma, x_0) \rtimes \mathbb{Z}$$

where the action of  $\mathbb{Z} = \langle t \rangle$  on  $\pi_1(\Sigma, x_0)$  is given by

$$tx_it^{-1} = a_i x_{\tau(i)} a_i^{-1} \quad \text{for } 1 \leq i \leq n$$

for some words  $a_1, \dots, a_n \in \pi_1(\Sigma, x_0)$ . Observe that in the case of a cable space  $a_i = 1$  for all  $1 \leq i \leq n$ . Any element of  $\pi_1(BS(\beta), x_0)$  is therefore uniquely written in the form  $wt^z$  with  $w \in \pi_1(\Sigma, x_0) \cong F(x_1, \dots, x_n)$  and  $z \in \mathbb{Z}$ . Note also that  $\pi_1(\Sigma, x_0) = \langle\langle x_1 \rangle\rangle$  (normal closure) as any two elements of  $\{x_1, \dots, x_n\}$  are conjugate in  $\pi_1(BS(\beta), x_0)$ .

Let  $A$  denote  $\pi_1(BS(\beta), x_0)$ . We say that a subgroup  $U \leq A$  is *meridional* if  $U$  is generated by finitely many conjugates of  $x_1$ . For example,  $\pi_1(\Sigma, x_0) \leq A$  is meridional. We will need the following result from [7] which explains the behavior of the meridional subgroups with respect to the peripheral subgroups

$$P_V := \pi_1(\partial V(\mathfrak{k}_0), x_0) \quad \text{and} \quad C_V := \pi_1(\partial V, x_0).$$

Observe that  $C_V$  is generated by  $m_V, l_V$  and  $P_V$  is generated by  $x_1, t^n$ .

**Lemma 2.1.** *Let  $U = \langle g_1 x_1 g_1^{-1}, \dots, g_k x_1 g_k^{-1} \rangle$  with  $k \geq 0$  and  $g_1, \dots, g_k \in A$ .*

*Then either  $U = \pi_1(\Sigma, x_0)$  (and in this case  $k \geq n$ ) or  $U$  is freely generated by  $h_1 x_1 h_1^{-1}, \dots, h_m x_1 h_m^{-1}$  with  $m \leq k$  and  $h_1, \dots, h_m \in A$  such that:*

- (1) for any  $g \in A$  one of the following holds:
  - (a)  $gP_V g^{-1} \cap U = \{1\}$ .

(b)  $gP_V g^{-1} \cap U = g\langle x_1 \rangle g^{-1}$  and  $gx_1 g^{-1}$  is in  $U$  conjugate to  $h_l x_1 h_l^{-1}$  for some  $l \in \{1, \dots, m\}$ .

(2) for any  $g \in A$  the subgroups  $gC_V g^{-1}$  and  $U$  intersect trivially.

*Remark 2.2.* The previous lemma tells us that the minimal number of conjugates of  $x_1$  needed to generate a given meridional subgroup  $U \leq A$  coincides with the rank of  $U$ , i.e. the minimal number of elements needed to generate  $U$ .

**2.3. The centralizer of the meridian.** This subsection is devoted to show a well-known fact, see [2, Theorem 2.5.1] for example, that says that almost no element in the knot group commutes with the meridian.

**Lemma 2.3.** *Let  $\mathfrak{k}$  be a non-trivial prime knot and  $g \in G(\mathfrak{k})$ . Then*

$$gmg^{-1} = m \text{ iff } g \in P(\mathfrak{k}).$$

*Proof.* It is proved in Lemma 3.1 of [21] that the peripheral subgroup of  $\mathfrak{k}$  is mal-normal in  $G(\mathfrak{k})$ , i.e.  $gP(\mathfrak{k})g^{-1} \cap P(\mathfrak{k}) = 1$  for all  $g \in G(\mathfrak{k}) \setminus P(\mathfrak{k})$ , unless  $\mathfrak{k}$  is a torus knot or a cable knot or a composite knot. The last case does not occur since  $\mathfrak{k}$  is assumed to be prime. In the case of a torus knot it is shown in Lemma 3.2 of [21] that  $gmg^{-1} \cap P(\mathfrak{k}) = 1$  for all  $g \in G(\mathfrak{k}) \setminus P(\mathfrak{k})$ .

We therefore need to consider the case where  $\mathfrak{k}$  is a cable knot. Thus  $G(\mathfrak{k})$  splits as  $\pi_1(\mathbb{A}, v_0)$  where  $\mathbb{A}$  is the graph of groups described in the previous subsection. Observe that the meridian of  $\mathfrak{k}$  is represented by the reduced  $\mathbb{A}$ -path  $x_1 \in A_{v_0} = \pi_1(CS(n, m), x_0)$ , that is,  $m = [x_1] \in \pi_1(\mathbb{A}, v_0)$ .

Let  $g \in G(\mathfrak{k}) = \pi_1(\mathbb{A}, v_0)$  such that  $gmg^{-1} = m$ . We can write  $g = [p]$  where

$$p = a_0, e, a_1, \dots, a_{2l-1}, e^{-1}, a_{2l}$$

is a reduced  $\mathbb{A}$ -path of length  $2l \geq 0$ . Then  $gmg^{-1} = m$  implies that the  $\mathbb{A}$ -paths

$$a_0, e, a_1, \dots, e^{-1}, a_{2l} \cdot x_1 \cdot a_{2l}^{-1}, e, \dots, a_1^{-1}, e^{-1}, a_0^{-1} \text{ and } x_1$$

are equivalent, see [22, p.612] or [15, Definition 2.3]. If  $l \geq 1$  then we can apply a reduction to  $px_1p^{-1}$ . Since  $p$  is reduced we conclude that  $a_{2l}x_1a_{2l}^{-1}$  is conjugate in the free group  $F_n = \langle x_1, \dots, x_n \rangle \leq A_{v_0}$  to an element of  $\alpha_e(A_e) = C_V$ . A simple homology argument shows that this cannot occur. Thus  $l = 0$  and so the equality  $gmg^{-1} = m$  reduces to  $a_0x_1a_0^{-1} = x_1$ . Write  $a_0 = ut^z$  where  $u \in F_n$  and  $z \in \mathbb{Z}$ . Then

$$a_0x_1a_0^{-1} = ux_{\tau^z(i)}u^{-1}.$$

Hence  $a_0x_1a_0^{-1} = x_1$  iff  $\tau^z(1) = 1$ . The second equality holds only when  $z = nk$  for some  $k$ . Since  $ux_1u^{-1} = x_1$  in  $F_n$  we conclude that  $u = x_1^w$  for some  $w \in \mathbb{Z}$ . Therefore,  $g = x_1^w(t^n)^k$  which shows that  $g \in P_V = P(\mathfrak{k})$ .  $\square$

**2.4. Algebraically tame knots.** Let  $\mathfrak{k} \subseteq S^3$  be a knot. We call a subgroup  $U \leq G(\mathfrak{k})$  *meridional* if  $U$  is generated by finitely many meridians of  $\mathfrak{k}$ . The minimal number of meridians needed to generate a meridional subgroup  $U$ , denoted by  $w(U)$ , is called the *meridional rank* of  $U$ . Observe that the knot group  $G(\mathfrak{k})$  is meridional and  $w(G(\mathfrak{k}))$  equals the meridional rank  $w(\mathfrak{k})$  of  $\mathfrak{k}$ .

**Definition 2.4.** A meridional subgroup  $U = \langle g_1mg_1, \dots, g_rmg_r \rangle \leq G(\mathfrak{k})$  of meridional rank  $r := w(U)$  is called *tame* if the following hold:

(1) the meridians  $g_img_i$  and  $g_jmg_j$  ( $1 \leq i \neq j \leq r$ ) are not conjugate in  $U$ .

(2) for any  $g \in G(\mathfrak{k})$  either  $U \cap gP(\mathfrak{k})g^{-1} = 1$  or

$$U \cap gP(\mathfrak{k})g^{-1} = g\langle m \rangle g^{-1}$$

and  $gm g^{-1}$  is in  $U$  conjugate to  $g_i m g_i$  for some  $1 \leq i \leq r$ .

**Definition 2.5.** A non-trivial knot  $\mathfrak{k}$  is called *algebraically tame* if any meridional subgroup of  $G(\mathfrak{k})$  that is generated by less than  $b(\mathfrak{k})$  meridians is tame.

*Remark 2.6.* Observe that for any algebraically tame knot  $\mathfrak{k}$  the equality  $w(\mathfrak{k}) = b(\mathfrak{k})$  holds since otherwise  $G(\mathfrak{k})$  would be a tame subgroup.

*Remark 2.7.* A (possibly) larger class of knots (called meridionally tame knots) is defined in [7]. The author does not know any example of a prime knot that is algebraically tame but not meridionally tame.

**Example 2.8.** Whitehead doubles are never algebraically tame since their exterior contains a properly immersed  $\pi_1$ -injective pair of pants in which two boundary components are mapped to meridional curves of  $\mathfrak{k}$ , see [1].

**Proposition 2.9.** *Two bridge knots, torus knots and prime three bridge knots are algebraically tame.*

*Proof.* First assume that  $\mathfrak{k}$  is a 2-bridge knot. Thus we need to show that any meridional subgroup generated by a single meridian is tame. Let  $U = \langle ama^{-1} \rangle \leq G(\mathfrak{k})$ . We can assume that  $a = 1$ . Since  $\mathfrak{k}$  is neither a cable knot nor a composite knot, Lemma 2.3 implies that  $gP(\mathfrak{k})g^{-1} \cap U \neq 1$  iff  $g \in P(\mathfrak{k})$ . Therefore

$$gP(\mathfrak{k})g^{-1} \cap U \neq 1 \quad \text{iff} \quad gP(\mathfrak{k})g^{-1} \cap U = \langle m \rangle.$$

Clearly  $gm g^{-1}$  is conjugate in  $U$  to  $m$ .

Assume now that  $\mathfrak{k}$  is a torus knot. It is shown in Theorem 1.2 of [18] that any meridional subgroup of  $\mathfrak{k}$  of meridional rank  $< b(\mathfrak{k})$  is freely generated by meridians. This shows condition (1) of tameness. Condition (2) is implicit in [18] and an explicit argument is given in [7, Lemma 6.1].

The algebraic tameness of prime 3-bridge knots follows from the proof of Proposition 7.1 of [7].  $\square$

### 3. THE PATTERN SPACE OF A WHITEHEAD DOUBLE

In this section we study the fundamental group of the pattern space  $E := V \setminus \text{Int } V(\mathfrak{k}_0)$  where  $(V, \mathfrak{k}_0)$  is the Whitehead pattern and  $V(\mathfrak{k}_0)$  is a regular neighborhood of  $\mathfrak{k}_0$  in the interior of  $V$ . Let  $\Sigma \subseteq E$  be the properly embedded pair

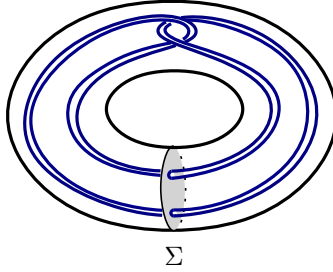

FIGURE 4. The pattern space  $E = V \setminus \text{Int } V(\mathfrak{k}_0)$ .

of pants shown in Figure 4 and let  $E_0$  be the space obtained from  $E$  by cutting along  $\Sigma$ , see Figure 5. The group  $\pi_1(E_0, e_0)$  (resp.  $\pi_1(\Sigma, \sigma_0)$ ) is freely generated by the elements  $x_1$  and  $x_2$  (resp.  $y_1$  and  $y_2$ ) whose representatives are described in Figure 5. It follows from the theorem of Seifert and van-Kampen that  $\pi_1(E, e_0)$  splits as an HNN extension:

$$\pi_1(E, e_0) = \pi_1(E_0, e_0) *_{(\alpha, \pi_1(\Sigma, \sigma_0), \omega)}$$

where:

- $\alpha : \pi_1(\Sigma, \sigma_0) \rightarrow \pi_1(E_0, e_0)$  is given by

$$\alpha(y_1) = x_2 x_1^{-1} x_2^{-1} \quad \text{and} \quad \alpha(y_2) = x_1.$$

- $\omega : \pi_1(\Sigma, \sigma_0) \rightarrow \pi_1(E_0, e_0)$  is given by

$$\omega(y_1) = x_2 x_1^{-1} x_2^{-1} x_1 x_2^{-1} \quad \text{and} \quad \omega(y_2) = x_2.$$

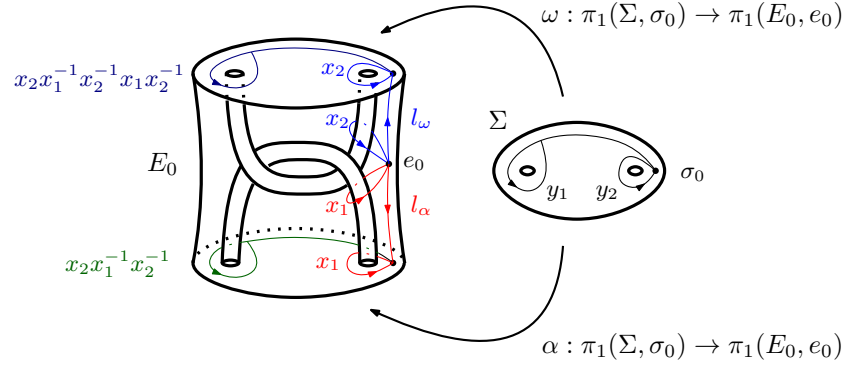

FIGURE 5. The fundamental groups of  $E_0$  and  $\Sigma$ .

A presentation for  $\pi_1(E, e_0)$  is therefore given by

$$\pi_1(E, e_0) = \langle x_1, x_2, l_V \mid l_V x_2 x_1^{-1} x_2^{-1} x_1 x_2^{-1} l_V^{-1} = x_2 x_1^{-1} x_2^{-1} \quad \text{and} \quad l_V x_2 l_V^{-1} = x_1 \rangle$$

where  $l_V$  is represented by the path  $l_\alpha l_\omega^{-1}$  (which is a longitude of  $V$ ). The meridian of  $V$  (which coincides with the outer boundary of  $\Sigma$ ) represents the element

$$m_V := x_2 x_1^{-1} x_2^{-1} x_1 = \alpha(y_1 y_2) = \omega(y_1 y_2) = x_2 x_1^{-1} x_2^{-1} x_1 x_2^{-1} x_2.$$

Define  $C_V := \langle m_V, l_V \rangle \cong \pi_1(\partial V, e_0) \leq \pi_1(\partial E, e_0)$ .

For the next lemmas we denote the subgroups  $\alpha(\pi_1(\Sigma, \sigma_0))$  and  $\omega(\pi_1(\Sigma, \sigma_0))$  of  $\pi_1(E_0, e_0)$  by  $U_\alpha$  and  $U_\omega$  respectively.

**Lemma 3.1.**  $U_\alpha$  and  $U_\omega$  are conjugacy separable in  $\pi_1(E_0, e_0)$  meaning that the intersection  $U_\alpha \cap g U_\omega g^{-1}$  is trivial for all  $g \in \pi_1(E_0, e_0)$ .

*Proof.* The lemma follows by a simple homology argument.  $\square$

**Lemma 3.2.** Let  $a \in \pi_1(E_0, e_0)$ . Then the following hold:

- (1)  $a \langle m_V \rangle a^{-1} \cap U_\alpha \neq 1$  iff  $a \in U_\alpha$ . Similarly,  $a \langle m_V \rangle a^{-1} \cap U_\omega \neq 1$  iff  $a \in U_\omega$
- (2)  $a \langle x_1 \rangle a^{-1} \cap U_\alpha \neq 1$  iff  $a = u x_2^\varepsilon x_1^k$  with  $u \in U_\alpha$ ,  $\varepsilon \in \{0, 1\}$  and  $k \in \mathbb{Z}$ .  
Similarly,  $a \langle x_2 \rangle a^{-1} \cap U_\omega \neq 1$  iff  $a = u (x_2 x_1^{-1})^\varepsilon x_2^k$  with  $u \in U_\omega$ ,  $\varepsilon \in \{0, 1\}$  and  $k \in \mathbb{Z}$ .

- (3)  $aU_\alpha a^{-1} \cap U_\alpha \neq 1$  iff  $a = u_1 x_2^\varepsilon u_2$  with  $u_1, u_2 \in U_\alpha$  and  $\varepsilon \in \{-1, 0, 1\}$ .  
 Similarly,  $aU_\omega a^{-1} \cap U_\omega \neq 1$  iff  $a = u_1 (x_2 x_1^{-1})^\varepsilon u_2$  with  $u_1, u_2 \in U_\omega$  and  $\varepsilon \in \{-1, 0, 1\}$

*Proof.* We prove the above claims for  $U_\alpha$ . The argument for  $U_\omega$  is similar. We identify  $\pi_1(E_0, e_0)$  with the fundamental group of the rose  $R_2$  with two petals.

Let  $p : (\Gamma, u_0) \rightarrow (R_2, v)$  be the covering corresponding to  $U_\alpha = \langle x_1, x_2 x_1^{-1} x_2^{-1} \rangle$ , see Figure 6.

- (1) The result follows from the fact a lifting  $\tilde{m}$  of  $m_V^k = (x_2 x_1^{-1} x_2^{-1} x_1)^k$  is closed iff  $\tilde{m}$  starts (and therefore also ends) at the vertex  $u_0$ .

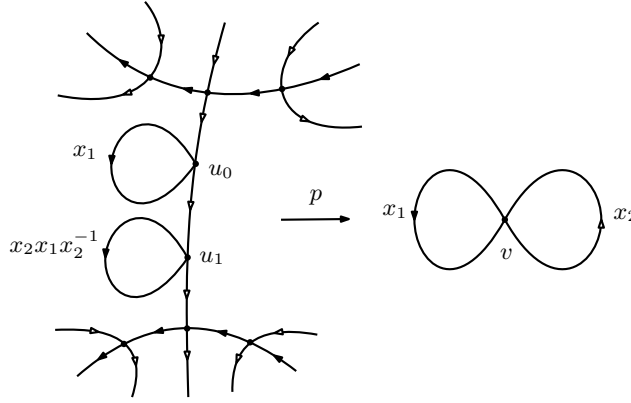

FIGURE 6. The covering corresponding to  $U_\alpha = \langle x_2 x_1 x_2^{-1}, x_1 \rangle$ .

- (2) The argument is similar to the argument given in (1). A lifting of  $\tilde{l}$  of  $x_1^z$  is closed iff  $\tilde{l}$  starts at  $u_0$  or at  $u_1$ . Therefore any lifting of  $a$  starting at  $u_0$  either terminates at  $u_0$  (which implies that  $a$  lies in  $U_\alpha$ ) or terminates at  $u_1$  (which implies that  $a = u x_2 x_1^k$  with  $u \in U_\alpha$  and  $k \in \mathbb{Z}$ ).

- (3) First observe that reduced words (in the basis  $\{x_1, x_2\}$  of  $\pi_1(E_0, e_0)$ ) that represent elements of  $U_\alpha$  are of the form

$$(*) \quad x_1^{n_0} \cdot x_2 x_1^{n_1} x_2^{-1} \cdot x_1^{n_2} \cdot \dots \cdot x_1^{n_{d-1}} \cdot x_2 x_1^{n_d} x_2^{-1}$$

with  $n_0, n_d \in \mathbb{Z}$  and  $n_1, \dots, n_{d-1} \in \mathbb{Z} \setminus \{0\}$ .

After multiplying  $a$  on the right and on the left by elements of  $U_\alpha$  we can assume that whenever  $a = u_1 a' u_2$  with  $u_1, u_2 \in U_\alpha$  and  $|a'| \leq |a|$  then  $u_1 = u_2 = 1$ , where  $|a|$  denotes the word length of  $a$  with respect to the basis  $\{x_1, x_2\}$ . We will refer to this assumption as the *length assumption on a*.

We will show that  $a = x_2^\varepsilon$  for some  $\varepsilon \in \{-1, 0, 1\}$ . First observe that if  $a = x_2^s$  with  $s \in \mathbb{Z}$  then (\*) implies that  $aU_\alpha a^{-1} \cap U_\alpha \neq 1$  iff  $s \in \{-1, 0, 1\}$ .

Assume that  $a$  is not a power of  $x_2$ . The length assumption on  $a$  implies that  $a$  can be written as  $x_2^r \cdot b \cdot x_2^s$  with  $r, s \in \mathbb{Z} \setminus \{0\}$  and the first and last letters in  $b$  are  $x_1^{\pm 1}$ . If  $s \neq -1$  then for any  $u \in U$  the reduced word that represents  $aua^{-1}$  contains the initial sub-word  $x_2^r b$ . From (\*) we conclude that that  $r = 1$ . But  $b = x_1^l c$  for some  $l \neq 0$  and some  $c$  (which might be trivial). Thus

$$a = x_2 x_1^l c x_2^s = x_2 x_1^l x_2^{-1} \cdot x_2 c x_2^s.$$



with  $x_2x_1^lx_2^{-1} \in U$  and  $|x_2cx_2^s| < |a|$ , a contradiction to the length assumption. Assume now that  $s = -1$ . The assumption on  $b$  implies that  $b = cx_1^l$  for some  $l \neq 0$ . Thus

$$a = x_2^rx_2^{-1} = x_2^rcx_1^lx_2^{-1} = x_2^rcx_2^{-1} \cdot x_2x_1^lx_2^{-1}$$

with  $x_2x_1^lx_2^{-1} \in U$  and  $|x_2^rcx_2^{-1}| < |a|$  which contradicts the length assumption.  $\square$

*Remark 3.3.* It follows from item (1) that  $a\langle m_V \rangle a^{-1} \cap U_\alpha$  is either trivial or equal to  $a\langle m_V \rangle a^{-1}$ . Item (2) implies that  $a\langle x_1 \rangle a^{-1} \cap U_\alpha$  is either trivial or equal to  $a\langle x_1 \rangle a^{-1}$ . The same claims also holds for  $U_\omega$ .

From Lemma 3.2(3) we immediately obtain the following corollary.

**Corollary 3.4.**  $N_{\pi_1(E_0, e_0)}(U_\alpha) = U_\alpha$  and  $N_{\pi_1(E_0, e_0)}(U_\omega) = U_\omega$  where  $N_{\pi_1(E_0, e_0)}(U)$  denotes the normalizer of  $U \leq \pi_1(E_0, e_0)$ .

We will consider subgroups of  $\pi_1(E, e_0)$  that are generated by conjugates of  $x_1$  and  $x_2$ . We call such subgroups *meridional*. We define the meridional rank  $\bar{w}(U)$  of a meridional subgroup  $U \leq \pi_1(E, e_0)$  as the minimal number of conjugates of  $x_1$  and  $x_2$  needed to generate  $U$ .

**Definition 3.5.** A meridional subgroup  $U = \langle g_1x_{i_1}g_1^{-1}, \dots, g_lx_{i_l}g_l^{-1} \rangle \leq \pi_1(E, e_0)$  with  $l = \bar{w}(U)$  is *good* if there is a partitioned  $J_1, \dots, J_d$  of  $\{1, \dots, l\}$  such that:

- (1)  $U = U_1 * \dots * U_d$  where  $U_s$  ( $1 \leq s \leq d$ ) is generated by  $\{g_kx_{i_k}g_k^{-1} \mid k \in J_s\}$ .
- (2) for any  $h \in \pi_1(E, e_0)$  one of the following holds:
  - (a)  $U \cap hC_Vh^{-1} = 1$ .
  - (b)  $U \cap hC_Vh^{-1} = \langle hm_Vh^{-1} \rangle$  and there are  $1 \leq s \leq d$  with  $|J_s| \geq 2$  and  $u \in U$  such that  $hm_Vh^{-1}$  lies in  $uU_su^{-1}$ .

The main result of this section says that meridional subgroups are almost good in the sense that they are contained in a larger good subgroup whose rank does not increase.

**Proposition 3.6.** *Any meridional subgroup  $U \leq \pi_1(E, e_0)$  is contained in a good meridional subgroup  $\bar{U} \leq \pi_1(E, e_0)$  with  $\bar{w}(\bar{U}) \leq \bar{w}(U)$ .*

**3.1. Proof of Proposition 3.6.** We consider the HNN extension

$$\pi_1(E, e_0) = \pi_1(E_0, e_0) *_{(\alpha, \pi_1(\Sigma, \sigma_0), \omega)}$$

as a graph of groups  $\mathbb{A}$  having a single vertex  $v$  with group  $A_v = \pi_1(E_0, e_0)$  and a single edge pair  $e, e^{-1}$  with  $\alpha(e) = \omega(e) = v$  and group  $A_e = A_{e^{-1}} = \pi_1(\Sigma, \sigma_0)$ . The boundary monomorphisms  $\alpha_e, \omega_e : A_e \rightarrow A_v$  are given by  $\alpha_e = \alpha$  and  $\omega_e = \omega$ .

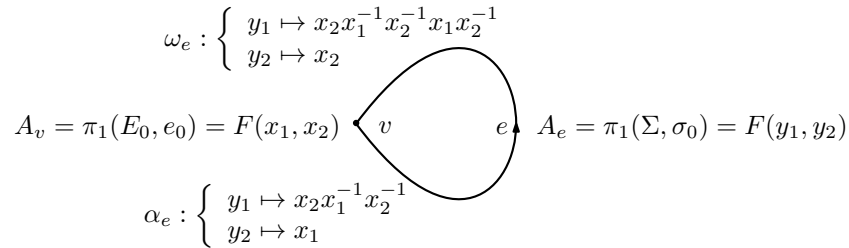

FIGURE 7. The graph of groups  $\mathbb{A}$ .

The idea of the proof is to look at  $\mathbb{A}$ -graphs that possibly represent good meridional subgroups of  $\pi_1(E, e_0) \cong \pi_1(\mathbb{A}, v)$ . We start by defining  $\mathbb{A}$ -graphs of cyclic and non-cyclic type which will serve as the building blocks of the  $\mathbb{A}$ -graph we are going to consider.

We say that a folded  $\mathbb{A}$ -graph  $\mathcal{B}$  is of *cyclic type* if the following hold:

- (1) the underlying graph of  $\mathcal{B}$  is an interval  $f_1, \dots, f_d$  of length  $d \geq 0$ .

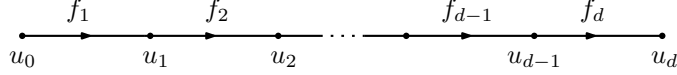

FIGURE 8. The underlying graph of an  $\mathbb{A}$ -graph of cyclic type.

- (2) for each  $u \in VB = \{u_0, \dots, u_d\}$  the corresponding vertex group  $B_u \leq A_v$  is generated by a single conjugate of  $x_1$  or  $x_2$ .
- (3) for each  $f \in EB = \{f_1^{\pm 1}, \dots, f_d^{\pm 1}\}$  the corresponding edge group  $B_f \leq A_e$  is generated by a single conjugate of  $y_1$  or  $y_2$ .

We say that a folded  $\mathbb{A}$ -graph  $\mathcal{B}$  is of *non-cyclic type* if the following hold:

- (1) the underlying graph  $B$  of  $\mathcal{B}$  contains an interval  $f_1, \dots, f_d$  of length  $d \geq 2$  with  $u_0 = \alpha(f_1)$  and  $u_i = \omega(f_i)$  for  $i = 1, \dots, d$  such that

$$B \setminus \{f_1^{\pm 1}, \dots, f_d^{\pm 1}\} = l_1 \cup l_2 \cup l_3 \cup l_4$$

where  $l_k$  ( $1 \leq k \leq 4$ ) is an interval of length  $d_k \geq 0$  with  $u_0 = \alpha(l_1) = \alpha(l_2)$  and  $u_d = \alpha(l_3) = \alpha(l_4)$ , see Figure 9.

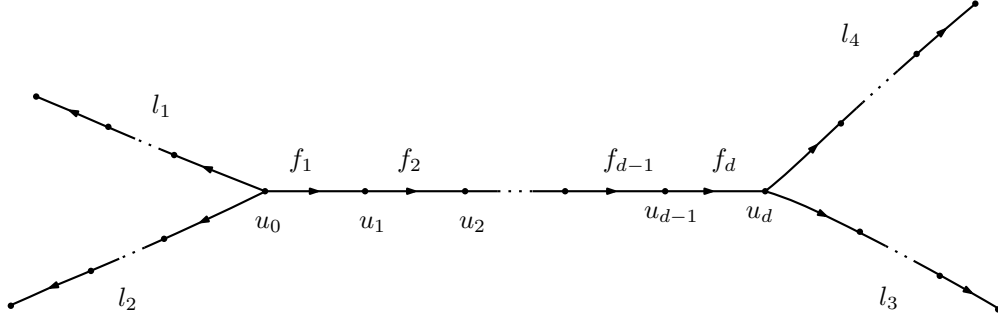

FIGURE 9. The underlying graph of an  $\mathbb{A}$ -graph of non-cyclic type.

- (2) for each  $i \in \{1, 2, 3, 4\}$  the sub- $\mathbb{A}$ -graph  $\mathcal{B}_i$  of  $\mathcal{B}$  that is carried by the interval  $l_i$  is an  $\mathbb{A}$ -graph of cyclic type.
- (3) for each  $1 \leq i \leq d$ ,  $B_{f_i} = A_{e_i} = A_e = \langle y_1, y_2 \rangle$  where  $e_i := [f_i] \in EA$ .
- (4) for each  $1 \leq i \leq d - 1$ ,  $B_{u_i} = A_v = \langle x_1, x_2 \rangle$ .
- (5) the vertex groups at  $u_0 = \alpha(f_1)$  and  $u_d = \omega(f_d)$  are given by:

$$B_{u_0} = o_{f_1} \alpha_{e_1} (A_{e_1}) o_{f_1}^{-1} = o_{f_1} \langle \alpha_{e_1}(y_1), \alpha_{e_1}(y_2) \rangle o_{f_1}^{-1} \leq A_{v_0}$$

and

$$B_{u_d} = t_{f_d}^{-1} \omega_{e_d} (A_{e_d}) t_{f_d} = t_{f_d}^{-1} \langle \omega_{e_d}(y_1), \omega_{e_d}(y_2) \rangle t_{f_d} \leq A_{v_0}.$$

We say that a connected sub- $\mathbb{A}$ -graph  $\mathcal{B}'$  of  $\mathcal{B}$  is *non-degenerate* if  $\mathcal{B}'$  contains at least one vertex with  $B_u = A_v$ , or in other words, if  $\mathcal{B}'$  contains at least one of the vertices  $u_1, \dots, u_{d-1}$ .

Let  $\mathcal{B}$  be an  $\mathbb{A}$ -graph of cyclic or non-cyclic type. It follows from the definition combined with [15, Proposition 2.4] that the subgroup  $U := U(\mathcal{B}, u_0) \leq \pi_1(\mathbb{A}, v)$  represented by  $\mathcal{B}$  is meridional. If  $\mathcal{B}$  is of cyclic type, then we further see that  $U(\mathcal{B}, u_0)$  is generated by a single conjugate of  $x_1$  or  $x_2$ ; hence  $w(U) = 1$ . If  $\mathcal{B}$  is of non-cyclic type, then is not hard to see that the sub- $\mathbb{A}$ -graph  $\mathcal{B}_0$  carried by  $f_1, \dots, f_d$  carries the fundamental group of  $\mathcal{B}$ , i.e. the natural inclusion of  $\mathcal{B}_0$  into  $\mathcal{B}$  induces an isomorphism  $\pi_1(\mathbb{B}_0, u_0) \rightarrow \pi_1(\mathbb{B}, u_0)$ ; hence  $U = U(\mathcal{B}_0, u_0)$ . Moreover, to  $\mathcal{B}_0$  we associate a manifold  $X_{\mathcal{B}_0}$  whose fundamental group is canonically isomorphic to  $\pi_1(\mathbb{B}_0, u_0)$  as shown in Figure 10. Since  $\mathcal{B}$  and therefore also  $\mathcal{B}_0$  are folded we

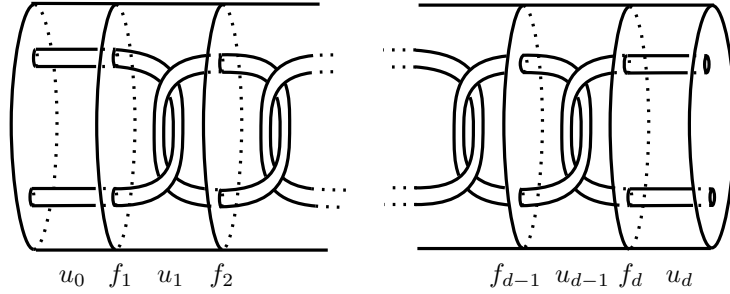

FIGURE 10. The manifold  $X_{\mathcal{B}_0}$ .

conclude from [22, Proposition 6] that  $U = U(\mathcal{B}_0, u_0)$  is isomorphic to  $\pi_1(\mathbb{B}, u_0)$  and hence isomorphic to  $\pi_1(\mathbb{B}_0, u_0) \cong \pi_1(X_{\mathcal{B}_0})$ . Thus  $U$  is generated by  $d$  conjugates of  $x_1$  and  $x_2$ . Since the first homology group of  $X_{\mathcal{B}_0}$  is isomorphic to  $\mathbb{Z}^d$  we can conclude that  $w(U) = \text{rank}(U) = \text{rank}(\pi_1(X_{\mathcal{B}_0})) = d$ .

Let  $\mathcal{B}$  be an arbitrary  $\mathbb{A}$ -graph. We define  $\text{Ess}(\mathcal{B})$  as the  $\mathbb{A}$ -graph that is obtained from  $\mathcal{B}$  by removing all vertices and edges with non-trivial group. Any component of  $\text{Ess}(\mathcal{B})$  is called an *essential piece* of  $\mathcal{B}$ .

**Definition 3.7.** We say that an  $\mathbb{A}$ -graph  $\mathcal{B}$  is *good* if the following hold:

- (G1) the underlying graph of  $\mathcal{B}$  is a finite tree.
- (G2) if  $\mathcal{B}'$  is an essential piece of  $\mathcal{B}$ , then  $\mathcal{B}'$  is either an  $\mathbb{A}$ -graph of cyclic type (in this case we say that  $\mathcal{B}'$  is a *cyclic essential piece* of  $\mathcal{B}$ ) or  $\mathcal{B}'$  is a non-degenerate sub- $\mathbb{A}$ -graph of some  $\mathbb{A}$ -graph of non-cyclic type (in this case we say that  $\mathcal{B}'$  is a *non-cyclic essential piece* of  $\mathcal{B}$ ).

The set of vertices and edges with non-trivial group in a good  $\mathbb{A}$ -graph can be decomposed as follows. Let  $\mathcal{B}$  be a good  $\mathbb{A}$ -graph. We define

$$V_{\mathcal{B}} := \{u \in VB \mid B_u \neq 1\} \quad \text{and} \quad E_{\mathcal{B}} := \{f \in EB \mid B_f \neq 1\}.$$

The set  $V_{\mathcal{B}}$  is partitioned into three types of vertices, namely, the set of:

- (1) *cyclic vertices* which consists of all vertices  $u \in V_{\mathcal{B}}$  such that  $B_u$  is generated by a single conjugate of  $x_1$  or  $x_2$ .

- (2) *almost full vertices* which consists of all vertices  $u \in VB$  for which there is an edge  $f \in Star_B(u)$  such that  $B_f = \langle y_1, y_2 \rangle$  and

$$B_u = \langle o_f \alpha_{e'}(y_1) o_f^{-1}, o_f \alpha_{e'}(y_2) o_f^{-1} \rangle$$

where  $e' = [f] \in EA$ . Observe that  $B_{\omega(f)} = A_v$ .

- (3) *full vertices* which consists of all vertices  $u$  such that  $B_u = A_v = \langle x_1, x_2 \rangle$ .

Similarly,  $E_{\mathcal{B}}$  is partitioned into two types of edges, namely, the set of:

- (1) *cyclic edges* which consists of all edges  $f \in EB$  such that  $B_f$  is generated by a single conjugate of  $y_1$  or  $y_2$ .  
(2) *full edges* which consists of all edges  $f \in EB$  such that  $B_f = \langle y_1, y_2 \rangle$ .

**Lemma 3.8.** *Let  $\mathcal{B}$  be a good  $\mathbb{A}$ -graph and let  $u \in VB$  and  $f \in Star_B(u)$ . Assume that  $e' = [f] \in EA = \{e, e^{-1}\}$ . Then the following hold:*

- (1) *If  $B_u$  is generated by a single conjugate of  $x_1$  (in particular  $u$  is cyclic) and*

$$o_f \alpha_{e'}(A_{e'}) o_f^{-1} \cap B_u \neq 1$$

*then  $e' = e$  and up to auxiliary moves we can assume that  $B_u = \langle x_1 \rangle$  and  $o_f = x_2^{-\varepsilon}$  with  $\varepsilon \in \{0, 1\}$ .*

*Similarly, if  $B_u$  is generated by a single conjugate of  $x_2$  and*

$$o_f \alpha_{e'}(A_{e'}) o_f^{-1} \cap B_u \neq 1$$

*then  $e' = e^{-1}$  and up to auxiliary moves we can assume that  $B_u = \langle x_2 \rangle$  and  $o_f = (x_2 x_1^{-1})^{-\varepsilon}$  with  $\varepsilon \in \{0, 1\}$ .*

- (2) *If  $B_u \neq A_v$  is generated by two conjugates of  $x_1$  (in particular  $u$  is almost full) and*

$$B_u \cap o_f \alpha_{e'}(A_{e'}) o_f^{-1} \neq 1$$

*then  $e' = e$  and up to auxiliary moves  $o_f = x_2^{\varepsilon}$  with  $\varepsilon \in \{-1, 0, 1\}$ .*

*Similarly, if  $B_u \neq A_v$  is generated by two conjugates of  $x_2$  (in particular  $u$  is almost full) and*

$$B_u \cap o_f \alpha_{e'}(A_{e'}) o_f^{-1} \neq 1$$

*then  $e' = e^{-1}$  and up to auxiliary moves  $o_f = (x_2 x_1^{-1})^{\eta}$  with  $\eta \in \{-1, 0, 1\}$ .*

*Proof.* Assume that  $B_u = \langle g x_1 g^{-1} \rangle \leq A_v$  with  $g \in A_v = \pi_1(E_0, e_0)$ . Lemma 3.1 implies that  $e' = e$ . Lemma 3.2(2) implies that

$$o_f^{-1} g = \alpha_e(c) x_2^{\varepsilon} x_1^k$$

with  $c \in A_e$ ,  $\varepsilon \in \{0, 1\}$  and  $k \in \mathbb{Z}$ . Therefore

$$o_f = g^{-1} x_1^k x_2^{-\varepsilon} \alpha_e(c).$$

This implies that after applying auxiliary moves to  $\mathcal{B}$  based on  $u$  and on  $f$  we can assume that  $B_u = \langle x_1 \rangle$  and  $o_f = x_2^{-\varepsilon}$ .

- (2) After applying an auxiliary move of type A0 based on  $u$  we can assume that

$$B_u = \alpha_e(A_e) = \langle \alpha_e(y_1), \alpha_e(y_2) \rangle = \langle x_2 x_1^{-1} x_2^{-1}, x_1 \rangle \leq A_v.$$

By hypothesis  $o_f \alpha_{e'}(A_{e'}) o_f^{-1} \cap B_u \neq 1$ . Thus, by Lemma 3.1, it holds  $e' = e$  and by Lemma 3.2(3) it holds

$$o_f = u x_2^{\varepsilon} \alpha_e(c)$$

with  $b \in B_u$  and  $c \in A_e$ . Therefore, after applying auxiliary moves based on  $u$  and of  $f$ , we can assume that  $o_f = x_2^{\bar{c}}$ .  $\square$

**Collapsing essential pieces.** In addition to auxiliary moves as defined in [22, subsection 1.5] we will also need another preprocessing move which is the inverse of a type IIA fold.

Let  $\mathcal{B}$  be a good  $\mathbb{A}$ -graph. Let  $\mathcal{B}'$  be an essential piece of  $\mathcal{B}$  such that  $\mathcal{B}'$  contains at least one edge (and hence  $\mathcal{B}$  contains at least one edge with non-trivial group) and let  $u \in VB'$ . Choose  $u' \in VB' \setminus \{u\}$  such that:

- (i)  $val_{B'}(u') = 1$  (in a finite tree there are at least two vertices with this property).
- (ii) if  $u'' \in VB' \setminus \{u\}$  with  $val_{B'}(u'') = 1$  then, up to conjugacy,  $B_{u'}$  is a subgroup of  $B_{u''}$ .

Let  $f' \in EB'$  be the edge starting at  $u'$ . Denote  $u'' := \omega(f') \in VB'$  and  $e' = [f'] \in EA$ . We define a new  $\mathbb{A}$ -graph  $\bar{\mathcal{B}}$  as follows:

1. if  $u'$  is not full, then from the definition of  $\mathbb{A}$ -graphs of cyclic and non-cyclic type we see that  $B_{u'} = o_{f'} \alpha_{e'}(B_{f'}) o_{f'}^{-1}$ . In this case we replace the vertex group  $B_{u'}$  by  $\bar{B}_{u'} = 1$  and the edge group  $B_{f'} \leq A_{e'}$  by  $\bar{B}_{f'} = 1$ , see Figure 11.

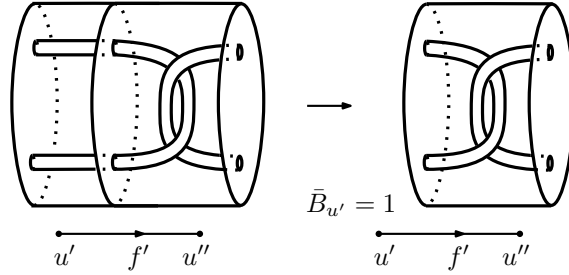

FIGURE 11. Case 1:  $u'$  is not full.

2. if  $u'$  is full, then there are two cases:
  - (a)  $u''$  is full or  $u''$  is almost full and equal to  $u$ . Observe that if the second option occurs, then the choice of  $u'$  guarantees that  $\mathcal{B}'$  contains only the edge  $f'$ . As  $u'$  is full we have

$$\begin{aligned} B_u = A_v &= \langle x_1, x_2 \rangle \\ &= o_{f'} \langle x_1, x_2 \rangle o_{f'}^{-1} \\ &= \langle o_{f'} \alpha_{e'}(y_2) o_{f'}^{-1}, o_{f'} x_i o_{f'}^{-1} \rangle \end{aligned}$$

where  $i \in \{1, 2\}$  depends on  $e' := [f']$ . In this case we do the following:

- (i) replace the edge group  $B_{f'} = A_{e'} = \langle y_1, y_2 \rangle$  by  $\bar{B}_{f'} = 1$ .
- (ii) replace the vertex group  $B_{u'} = A_v$  by  $\bar{B}_{u'} = \langle o_{f'} x_i o_{f'}^{-1} \rangle$ .
- (iii) If  $u''$  is full then we do not change the vertex group at  $u''$ , i.e.  $\bar{B}_{u''} = B_{u''}$ , and if  $u''$  is almost full then we replace

$$B_{u''} = \langle t_{f'}^{-1} \omega_{e'}(y_1) t_{f'}, t_{f'}^{-1} \omega_{e'}(y_2) t_{f'} \rangle$$

by  $\bar{B}_{u''} = \langle t_{f'}^{-1} \omega_{e'}(y_2) t_{f'} \rangle$ , see Figure 12.

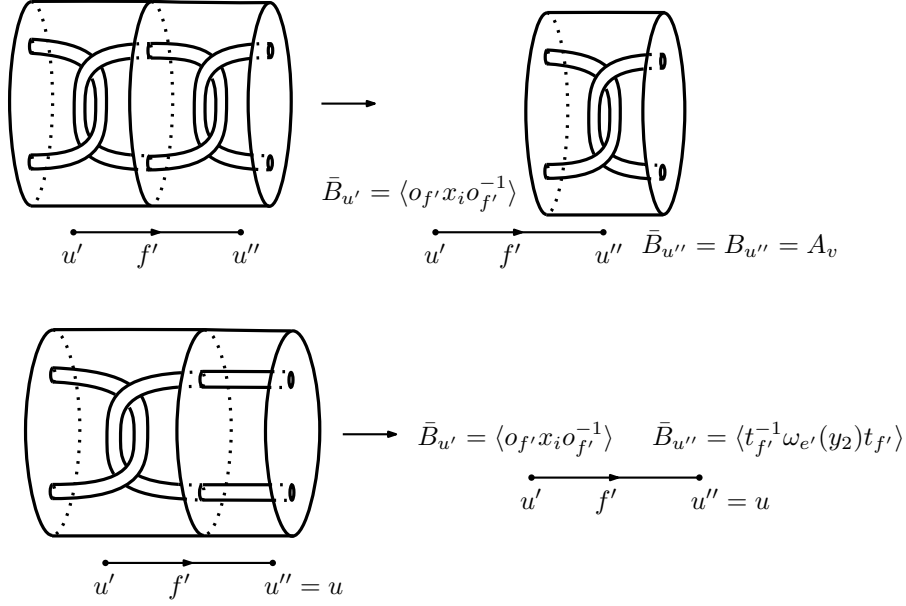
FIGURE 12. Case (2.a):  $u''$  is full or  $u''$  is almost full and  $u'' = u$ .

- (b)  $u''$  is not full and distinct from  $u$ . The choice of  $u'$  implies that  $u$  is cyclic and  $\text{val}_{B'}(u'') = 2$ . Let  $f''$  be the edge in  $\text{Star}_{B'}(u'')$  distinct from  $(f')^{-1}$  and  $e'' := [f'']$ . The previous lemma implies that there is  $h \in B_{u'} = A_v$  and  $i, j \in \{1, 2\}$  such that

$$B_{u'} = A_v = \langle o_{f'} \alpha_{e'}(y_j) o_{f'}^{-1}, h x_i h^{-1} \rangle$$

and

$$o_{f''} \alpha_{e''}(B_{f''}) o_{f''}^{-1} = \langle t_{f'}^{-1} \omega_{e'}(y_j) t_{f'} \rangle,$$

see Figure 13. In this case we replace the edge group  $B_{f'} = A_e = \langle y_1, y_2 \rangle$  by  $\bar{B}_{f'} = 1$  and the vertex group  $B_{u'}$  by  $\bar{B}_{u'} = \langle h x_i h^{-1} \rangle$ .

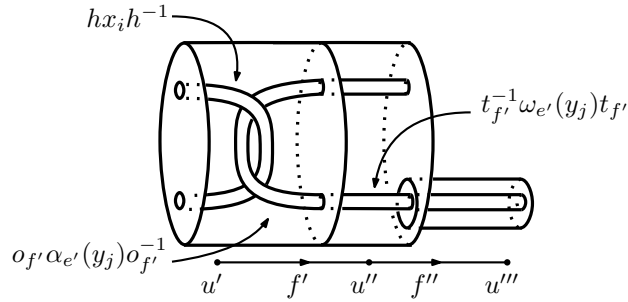
FIGURE 13. Case (2.b):  $u''$  is not full and  $u'' \neq u$ 

It is not hard to see that  $\bar{\mathcal{B}}$  is indeed good. We say that  $\bar{\mathcal{B}}$  is obtained from  $\mathcal{B}$  by unfolding along the edge  $f$ . After repeating this procedure finitely many times we obtain a good  $\mathbb{A}$ -graph  $\tilde{\mathcal{B}}$  in which all edge groups in  $\mathcal{B}'$  are trivial and  $\tilde{B}_u = B_u$

if  $u$  is cyclic or full (in  $\mathcal{B}$ ) and  $\tilde{B}_u$  is generated by a conjugate of  $x_1$  or  $x_2$  if  $u$  is almost full (in  $\mathcal{B}$ ). We say that  $\tilde{\mathcal{B}}$  is obtained from  $\mathcal{B}$  by collapsing  $\mathcal{B}'$  into  $u$ . It is clear from the definition that the labels of edges are not affected in these moves.

Let  $\mathcal{B}$  be a good  $\mathbb{A}$ -graph. The *rank of  $\mathcal{B}$* , denoted  $\text{rank}(\mathcal{B})$ , is defined as the rank of  $\pi_1(\mathbb{B}, u_0)$ . The number of full vertices (resp. full edges) in  $\mathcal{B}$  is denoted by  $v_{\text{full}}(\mathcal{B})$  (resp.  $e_{\text{full}}(\mathcal{B})$ ).

**Lemma 3.9.** *Let  $\mathcal{B}$  be a good  $\mathbb{A}$ -graph with base vertex  $u_0 \in VB$ . Let  $\mathcal{B}_1, \dots, \mathcal{B}_r$  (resp.  $\mathcal{B}_{r+1}, \dots, \mathcal{B}_l$ ) be the cyclic (resp. non-cyclic) essential pieces of  $\mathcal{B}$ . Then*

$$\text{rank}(\mathcal{B}) = r + \sum_{i=r+1}^l (v_{\text{full}}(\mathcal{B}_i) + 1)$$

and the subgroup  $U(\mathcal{B}, u_0) \leq \pi_1(\mathbb{A}, v) = \pi_1(E, e_0)$  represented by  $\mathcal{B}$  is generated by  $\text{rank}(\mathcal{B})$  conjugates of  $x_1$  and  $x_2$ .

If  $\mathcal{B}$  is folded, then  $U(\mathcal{B}, u_0)$  is good and  $w(U(\mathcal{B}, u_0)) = \text{rank}(\mathcal{B})$ .

*Proof.* For each  $i = 1, \dots, l$  let  $u_i$  be an arbitrary vertex of  $\mathcal{B}_i$ . Let further  $p_i$  be a  $\mathbb{B}$ -path from  $u_0$  to  $u_i$  such that its underlying path is reduced. Since the group of any edge and the group of any vertex that is not in  $\text{Ess}(\mathcal{B})$  is trivial, the fundamental group of  $\mathbb{B}$  splits as

$$\pi_1(\mathbb{B}, u_0) = p_1 \pi_1(\mathbb{B}_1, u_1) p_1^{-1} * \dots * p_l \pi_1(\mathbb{B}_l, u_l) p_l^{-1},$$

where  $p_i \pi_1(\mathbb{B}_i, u_i) p_i^{-1}$  consists of all elements of  $\pi_1(\mathbb{B}, u_0)$  represented by paths of the form  $p_i p p_i^{-1}$  where  $p$  is a closed path in  $\mathbb{B}_i$  based at  $u_i$ .

Grushko's Theorem [14] implies that  $\text{rank}(\mathcal{B}) = \sum \text{rank}(\mathcal{B}_j)$ . As observed before the rank of any cyclic piece is 1 and the rank of any non-cyclic piece  $\mathcal{B}_{r+i}$  is  $v_{\text{full}}(\mathcal{B}_i) + 1$ . Therefore we have the right formula for  $\text{rank}(\mathcal{B})$ .

Assume now that  $\mathcal{B}$  is folded. It follows from [22, Proposition 6] that  $U(\mathcal{B}, u_0)$  is isomorphic to  $\pi_1(\mathbb{B}, u_0)$ . From this fact we readily conclude that  $w(U(\mathcal{B}, u_0)) = \text{rank}(\mathcal{B})$  and that  $U(\mathcal{B}, u_0) = U_1 * \dots * U_l$  where

$$U_i := \phi(p_i \pi_1(\mathbb{B}_i, u_i) p_i^{-1}) \cong \pi_1(\mathbb{B}_i, u_i) \quad \text{for } i = 1, \dots, l.$$

This shows that condition (1) of the definition of good subgroups of  $\pi_1(E, e_0)$  is satisfied.

It remains to show that (2) also holds. Let  $h \in \pi_1(E, e_0) = \pi_1(\mathbb{A}, v)$ . Since the underlying graph of  $\mathcal{B}$  is a tree and  $l_V$  is represented by the closed  $\mathbb{A}$ -path  $1, e, 1$ , we conclude that

$$U(\mathcal{B}, u_0) \cap h C_V h^{-1} \leq h \langle m_V \rangle h^{-1}.$$

Assume that  $h m_V^z h^{-1} \in U(\mathcal{B}, u_0)$  for some  $z \neq 0$ . The Normal Form Theorem [15, Proposition 2.4] combined with the foldedness of  $\mathcal{B}$  implies that there must be a vertex  $u \in VB$  such that  $B_u$  contains  $a m_V^z a^{-1}$  for some  $a \in A_v$ . Since no cyclic subgroup of  $A_v$  contains  $m_V^z$  it follows that  $u$  is either almost full or full (in particular  $u$  lies in a non-cyclic essential piece of  $\mathcal{B}$ ). Thus  $B_u$  also contains  $a m_V a^{-1}$ . This shows that for any  $h \in \pi_1(E, e_0)$  one of conditions (2.a) or (2.b) from the definition of good subgroups holds.  $\square$

*proof of Proposition 3.6.* Let  $U = \langle g_1 x_{i_1} g_1^{-1}, \dots, g_k x_{i_k} g_k^{-1} \rangle$  be a meridional subgroup of  $\pi_1(E, e_0)$  of meridional rank  $k := w(U)$ . Since  $\pi_1(E, e_0)$  splits as  $\pi_1(\mathbb{A}, v)$ , where  $\mathbb{A}$  is the graph of groups described above, each  $g_s$  ( $1 \leq s \leq k$ ) can be written as  $g_s = [p_s]$  where  $p_s$  is a (non-necessarily reduced) closed  $\mathbb{A}$ -path of positive length.

We define  $\mathcal{B}_0$  as follows (see figure 28). Start with a vertex  $u_0$  and for each  $1 \leq s \leq k$  we glue an interval  $l_s$  subdivided into  $length(p_s)$  segments to  $u_0$ . The label of each  $l_s$  is defined so that  $\mu(l_s) = p_s$ . The vertex group at  $\omega(l_s)$  is  $\langle x_{i_s} \rangle$  and the remaining vertex and edge groups are trivial.

Note that  $\mathcal{B}_0$  is good since all components of  $\text{Ess}(\mathcal{B}_0)$  are (degenerate)  $\mathbb{A}$ -graphs of cyclic type. Note further that  $\pi_1(\mathbb{B}_0, u_0)$  is freely generated by

$$[l_1 x_{i_1} l_1^{-1}], \dots, [l_k x_{i_k} l_k^{-1}]$$

and, by definition,  $[l_s x_{i_s} l_s^{-1}]$  is mapped onto  $g_s x_{i_s} g_s^{-1}$ . Therefore  $U(\mathcal{B}_0, u_0) = U$  and  $k = w(U) = \text{rank}(\mathcal{B}_0)$ .

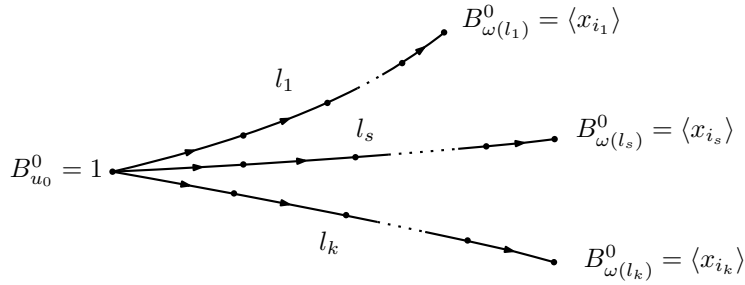

FIGURE 14. The  $\mathbb{A}$ -graph  $\mathcal{B}_0$ .

**Definition 3.10.** We define the *complexity* of a good  $\mathbb{A}$ -graph  $\mathcal{B}$  as the tuple

$$c(\mathcal{B}) = (\text{rank}(\mathcal{B}), |EB|, |EB| - e_{full}(\mathcal{B}), |EB| - |E_{\mathcal{B}}|) \in \mathbb{N}_0^4.$$

Recall that  $e_{full}(\mathcal{B})$  denotes the number of full edges in  $\mathcal{B}$  and  $E_{\mathcal{B}}$  denotes the set of edges in  $\mathcal{B}$  with non-trivial group. Throughout the proof we assume that  $\mathbb{N}_0^4$  is equipped with the lexicographic order.

A straightforward inspection of the various cases reveals that all auxiliary moves preserve both goodness and the complexity, i.e. if  $\mathcal{B}'$  is obtained from a good  $\mathbb{A}$ -graph by an auxiliary move then  $\mathcal{B}'$  is also good and  $c(\mathcal{B}') = c(\mathcal{B})$ .

Now choose a good  $\mathbb{A}$ -graph  $\mathcal{B}$  such that the following hold:

- (1)  $U \leq U(\mathcal{B}, u_0)$  for some vertex  $u_0$  of  $\mathcal{B}$ .
- (2) the complexity of  $\mathcal{B}$  is minimal among all good  $\mathbb{A}$ -graphs satisfying condition (1).

Since  $\mathcal{B}_0$  is good and  $U(\mathcal{B}_0, u_0) = U$  we conclude that  $\text{rank}(\mathcal{B}) \leq \text{rank}(\mathcal{B}_0) = k = w(U)$ . Thus  $w(U(\mathcal{B}, u_0)) \leq w(U)$ . It remains to show that  $U(\mathcal{B}, u_0)$  is good. According to Lemma 3.9 it suffices to show that  $\mathcal{B}$  is folded. We will argue by contradiction. Thus assume that  $\mathcal{B}$  is not folded. Since the underlying graph of  $\mathcal{B}$  is a tree, only folds of type IA and folds of type IIA can be applied to  $\mathcal{B}$ .

(IA) Assume that a fold of type IA can be applied to  $\mathcal{B}$ . Thus there are edges  $f_1$  and  $f_2$  in  $\mathcal{B}$  with  $u := \alpha(f_1) = \alpha(f_2)$  and  $e' = [f_1] = [f_2] \in EA$  such that

$$o_{f_2} = b o_{f_1} \alpha_{e'}(c)$$

for some  $b \in B_u$  and some  $c \in A_{e'}$ . After applying auxiliary moves to  $\mathcal{B}$  (see [22, section 1.5]) we can assume that the fold is elementary, that is,  $o_{f_2} = o_{f_1}$ .



Let  $\mathcal{B}'$  be any  $\mathbb{A}$ -graph that is obtained from  $\mathcal{B}$  by collapsing the essential pieces containing  $\omega(f_1)$  and  $\omega(f_2)$ ; hence, there are no edges with non-trivial group in  $\mathcal{B}'$  starting at  $w(f_1)$  or  $w(f_2)$ . Since the label of  $f_1$  and  $f_2$  is not affected, the elementary fold that identifies  $f_1$  and  $f_2$  can also be applied to  $\mathcal{B}'$ .

Let  $\mathcal{B}''$  be the  $\mathbb{A}$ -graph obtained from  $\mathcal{B}'$  by this fold and let  $y$  be the image of  $\omega(f_1)$  (hence also of  $\omega(f_2)$ ) under the fold. According [22, Proposition 7] we have  $U(\mathcal{B}'', u_0'') = U(\mathcal{B}, u_0)$ . Since the vertex groups  $B'_{\omega(f_1)}$  and  $B'_{\omega(f_2)}$  are replaced by

$$B''_y = \langle B'_{\omega(f_1)}, B'_{\omega(f_2)} \rangle \leq A_{[y]}$$

we see that  $B''_y$  is generated by at most four conjugates of  $x_1$  and  $x_2$ . If  $B''_y$  is not cyclic, then we replace  $B''_y$  by  $B'''_y = A_v = \langle x_1, x_2 \rangle$ . In this way we obtain a good  $\mathbb{A}$ -graph  $\mathcal{B}'''$  such that

$$U \leq U(\mathcal{B}'', u_0'') \leq U(\mathcal{B}''', u_0''').$$

The complexity decreases since  $\text{rank}(\mathcal{B}''') \leq \text{rank}(\mathcal{B})$  and  $|EB'''| = |EB| - 2$ .

(IIA) Assume that no fold of type IA can be applied to  $\mathcal{B}$ . Since  $\mathcal{B}$  is not folded a fold of type IIA can be applied to  $\mathcal{B}$ . Thus there is  $f \in EB$  with  $u := \alpha(f)$ ,  $u' := \omega(f)$  and  $e' := [f] \in EA = \{e, e^{-1}\}$  such that

$$(3.1) \quad o_f \alpha_{e'}(B_f) o_f^{-1} \neq o_f \alpha_{e'}(A_{e'}) o_f^{-1} \cap B_u.$$

Since all edges with non-trivial group lie in some essential piece and these  $\mathbb{A}$ -graphs are folded by definition, we conclude that  $B_f = 1$ . Thus (3.1) means that

$$(3.2) \quad o_f \alpha_{e'}(A_{e'}) o_f^{-1} \cap B_u \neq 1.$$

To simplify the argument we assume that  $e' = e$ . The case where  $f$  is of type  $e^{-1}$  is entirely analogous. We need to consider various cases depending on the vertex groups  $B_u$  and  $B_{u'}$ .

*Case 1:  $u$  is full, that is,  $B_u = A_v = \langle x_1, x_2 \rangle$ .* The assumption that no fold of type IA can be applied to  $\mathcal{B}$  implies that there is at most one edge in  $\text{Star}_{\mathcal{B}}(u) \setminus \{f\}$  which is necessarily of type  $e^{-1}$ . We need to consider all possibilities for  $B_{u'}$ .

(a)  $B_{u'}$  is trivial. We define  $\mathcal{B}'$  as the  $\mathbb{A}$ -graph that is obtained from  $\mathcal{B}$  by replacing the edge group  $B_f = 1$  by  $B'_f = A_e = \langle y_1, y_2 \rangle$  and the vertex group  $B_{u'} = 1$  by

$$B'_{u'} = t_f^{-1} \omega_e(A_e) t_f = t_f^{-1} \langle \omega_e(y_1), \omega_e(y_2) \rangle t_f \leq A_v,$$

see Figure 15. Then  $\mathcal{B}'$  is good since this move simply “enlarges” the essential piece

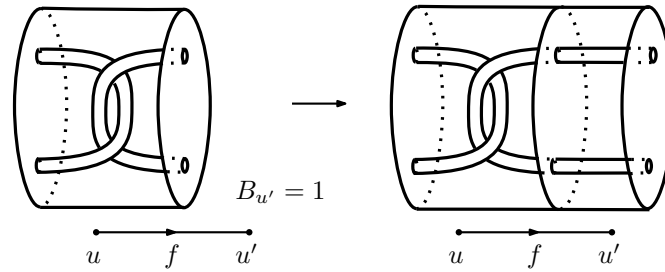

FIGURE 15. Case (1.a):  $B'_{u'} = t_f^{-1} \langle \omega_e(y_1), \omega_e(y_2) \rangle t_f$

that contains  $u$ . Moreover,  $c(\mathcal{B}') < c(\mathcal{B})$  since  $\text{rank}(\mathcal{B}') = \text{rank}(\mathcal{B})$ ,  $|EB'| = |EB|$  and  $e_{\text{full}}(\mathcal{B}') = e_{\text{full}}(\mathcal{B}) + 2$ .

(b)  $u'$  is cyclic. We first consider the case  $\text{Star}_{\mathcal{B}}(u') \cap E_{\mathcal{B}}$  is empty. We define  $\mathcal{B}'$  as the  $\mathbb{A}$ -graph that is obtained from  $\mathcal{B}$  by replacing the edge group  $B_f = 1$  by  $B'_f = A_e = \langle y_1, y_2 \rangle$  and the vertex group  $B_{u'}$  by  $B'_{u'} = A_v = \langle x_1, x_2 \rangle$ , see Figure 16. It is not hard to see that  $\mathcal{B}'$  is good. The complexity decreases since  $\text{rank}(\mathcal{B}') = \text{rank}(\mathcal{B})$ ,  $EB' = EB$  and  $e_{\text{full}}(\mathcal{B}') = e_{\text{full}}(\mathcal{B}) + 2$ .

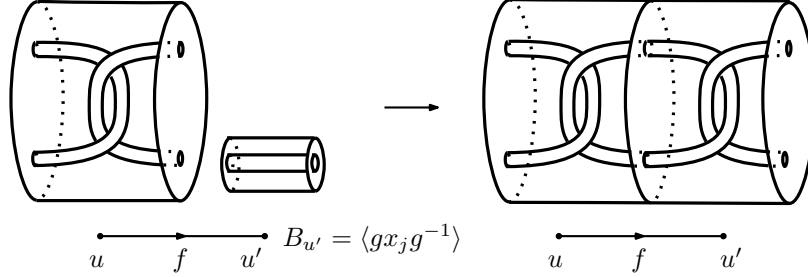

FIGURE 16. Case (1.b).

Assume now that  $\text{Star}_{\mathcal{B}}(u') \cap E_{\mathcal{B}} \neq \emptyset$ . It follows immediately from the definition of  $\mathbb{A}$ -graphs of (non-)cyclic type that  $\text{Star}_{\mathcal{B}}(u') \cap E_{\mathcal{B}}$  contains exactly one edge, say  $h$ , such that

$$B_h = \langle cy_i c^{-1} \rangle \quad \text{and} \quad B_{u'} = o_h \langle \alpha_{e''} (cy_i c^{-1}) \rangle o_h^{-1}$$

for some  $i \in \{1, 2\}$  and some  $c \in A_e$  where  $e'' := [h] \in EA$ . Let  $\mathcal{B}'$  be the  $\mathbb{A}$ -graph obtained from  $\mathcal{B}$  by doing the following:

- (a) replace the edge group  $B_h = \langle cy_i c^{-1} \rangle$  by  $B'_h = 1$ .
- (b) replace the edge group  $B_f = 1$  by  $B'_f = A_e = \langle y_1, y_2 \rangle$ .
- (c) replace the vertex group  $B_{u'} = o_h \langle \alpha_{e''} (cy_i c^{-1}) \rangle o_h^{-1}$  by

$$B_{u'} = t_f^{-1} \omega_e(A_e) t_f = t_f^{-1} \langle \omega_e(y_1), \omega_e(y_2) \rangle t_f \leq A_v.$$

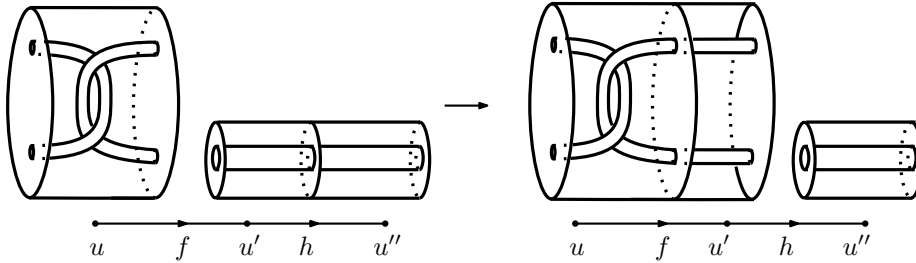

FIGURE 17. Case (1.b).

It is not hard to see that  $\mathcal{B}'$  is good. Moreover,  $c(\mathcal{B}') < c(\mathcal{B})$  since  $\text{rank}(\mathcal{B}') = \text{rank}(\mathcal{B})$ ,  $|EB'| = |EB|$  and  $e_{\text{full}}(\mathcal{B}') = e_{\text{full}}(\mathcal{B}) + 2$ .

(c)  $u'$  is almost full. By definition there is an unique edge  $h \in EB$  such that  $B_h = A_{e''} = \langle y_1, y_2 \rangle$ ,  $B_{u''} = A_v = \langle x_1, x_2 \rangle$  and

$$B_{u'} = o_h \alpha_{e''} (A_{e''}) o_h^{-1} = o_h \langle \alpha_{e''}(y_1), \alpha_{e''}(y_2) \rangle o_h^{-1}$$

where  $e'' := [h] \in EA$  and  $u'' = \omega(h) \in VB$ . After unfolding along edges with cyclic group in the essential piece that contains  $u'$  we can assume that  $Star_B(u') \cap E_B = \{h\}$ .

If  $e'' = e$  then we define  $\mathcal{B}'$  as the  $\mathbb{A}$ -graph that is obtained from  $\mathcal{B}$  by replacing the edge group  $B_f = 1$  by  $B'_f = A_e$  and the vertex group  $B_{u'}$  by  $B'_{u'} = A_v = \langle x_1, x_2 \rangle$ . Thus  $\mathcal{B}'$  is good and  $u'$  becomes a full vertex, see Figure 18. The complex-

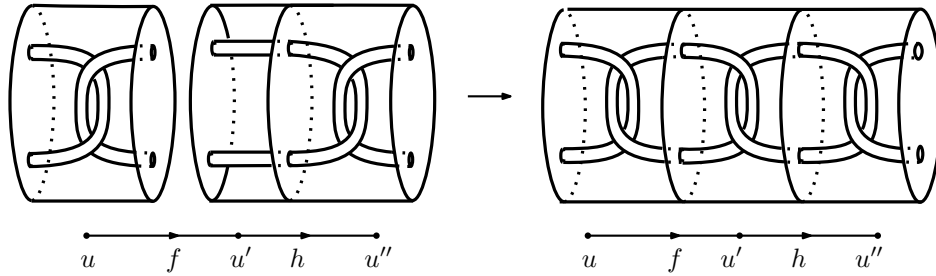

FIGURE 18. Case (1.c).

ity decreases since  $rank(\mathcal{B}') = rank(\mathcal{B})$ ,  $EB' = EB$  and  $e_{full}(\mathcal{B}') = e_{full}(\mathcal{B}) + 2$ .

If  $e'' = e^{-1}$  then the previous move does not yield a good marked  $\mathbb{A}$ -graph since  $f^{-1}$  and  $h$  can then be folded and so cannot lie in an  $\mathbb{A}$ -graph of non-cyclic type. In this case we define a new good  $\mathbb{A}$ -graph in which a fold of type IA can be applied to.

First let  $\mathcal{B}'$  be the  $\mathbb{A}$ -graph that is obtained from  $\mathcal{B}$  by collapsing the essential piece that contains  $u$  into  $u$ . Thus  $B'_u = B_u = \langle x_1, x_2 \rangle$  since  $u$  is full. After applying an auxiliary move of type A2 based on the edge  $f$  to  $\mathcal{B}'$  we can assume that  $o_f = 1$ .

Now let  $\mathcal{B}''$  be the  $\mathbb{A}$ -graph that is obtained from  $\mathcal{B}'$  by pushing the element  $x_1$  along  $f$ , that is, we replace  $B'_u = \langle x_1, x_2 \rangle$  by  $B''_u = \langle x_2 \rangle$  and  $B'_{u'} = B_{u'}$  by  $B''_{u'} = A_v$ , see Figure 19. The assumption that  $Star_B(u')$  contains only  $h$  ensures

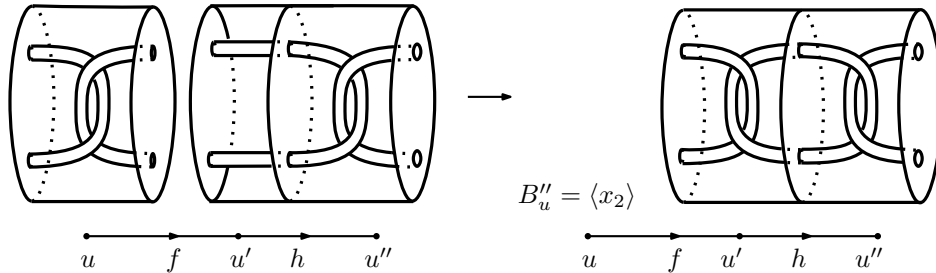

FIGURE 19. Case (1.c).

that  $\mathcal{B}''$  is good. Moreover,  $rank(\mathcal{B}') = rank(\mathcal{B})$ .

Since  $f^{-1}$  and  $h$  are of same type and  $B''_{u'} = A_v$  it follows that a fold of type IA that identifies  $f^{-1}$  with  $h$  can be applied to  $\mathcal{B}''$ . After folding these edges we obtain a good  $\mathbb{A}$ -graph  $\mathcal{B}'''$ . To see that the rank decreases observe that the vertex groups  $B''_u = \langle x_2 \rangle$  and  $B''_{u'} = A_v = \langle x_1, x_2 \rangle$  are replaced by  $A_v = \langle x_1, x_2 \rangle$ . Thus  $c(\mathcal{B}''') < c(\mathcal{B})$ .

(d)  $u'$  is full, that is,  $B_{u'} = A_v = \langle x_1, x_2 \rangle$ . In this case we simply replace  $B_f = 1$  by  $B'_f = A_e = \langle y_1, y_2 \rangle$ , see Figure 20. The assumption that no fold of type IA guarantees that  $\mathcal{B}'$  is good. Moreover,  $\text{rank}(\mathcal{B}') \leq \text{rank}(\mathcal{B}) - 1$  which implies that  $c(\mathcal{B}') < c(\mathcal{B})$ .

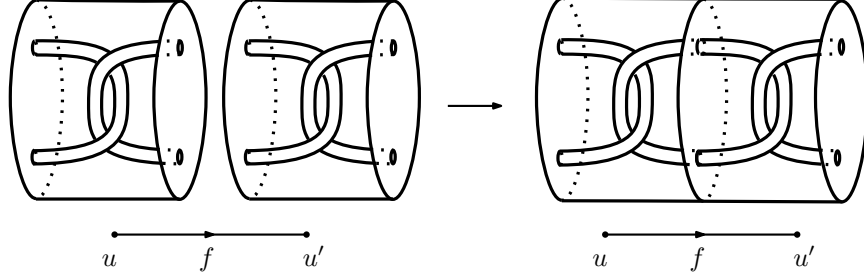

FIGURE 20. Case (1.d).

*Case 2:  $u$  is almost full.* By definition, there is a unique edge  $h \in \text{Star}_{\mathcal{B}}(u)$  such that  $B_h = A_{e''} = \langle y_1, y_2 \rangle$ ,  $B_{u''} = A_v = \langle x_1, x_2 \rangle$  and

$$B_u = o_h \alpha_{e''} (A_{e''}) o_h^{-1} = o_h \langle \alpha_{e''}(y_1), \alpha_{e''}(y_2) \rangle o_h^{-1},$$

where  $e'' = [h] \in EA$  and  $u'' = \omega(h) \in VB$ . Since

$$o_h \alpha_{e''} (A_{e''}) o_h^{-1} \cap o_f \alpha_e (A_e) o_f^{-1} = B_u \cap o_f \alpha_e (A_e) o_f^{-1} \neq 1$$

it follows from Lemma 3.8(2) that  $e'' = e$ . Lemma 3.8(2) further implies that

$$B_u \cap o_f \alpha_e (A_e) o_f^{-1} = o_f \langle \alpha_e(y_i) \rangle o_f^{-1}$$

for some  $i \in \{1, 2\}$ . We can assume that  $u'$  is not full since otherwise we apply the argument given in Case 1 to  $f^{-1}$ . We distinguish two cases depending on the vertex group  $B_{u'}$ .

(a)  $B_{u'} = 1$ . We define  $\mathcal{B}'$  as the  $\mathbb{A}$ -graph obtained from  $\mathcal{B}$  by doing the following:

- (1) replace  $B_f = 1$  by  $B'_f = \langle y_i \rangle$ .
- (2) replace  $B_{u'} = 1$  by  $B'_{u'} = \langle t_f^{-1} \omega_e(y_i) t_f \rangle$ .

The construction of  $\mathcal{B}'$  is described in Figure 21. The assumption that no fold of type IA can be applied to  $\mathcal{B}$  ensure that  $\mathcal{B}'$  is good. Moreover, the complexity decreases as  $\text{rank}(\mathcal{B}') = \text{rank}(\mathcal{B})$ ,  $|EB'| = |EB|$ ,  $e_{full}(\mathcal{B}') = e_{full}(\mathcal{B})$  and  $|E_{\mathcal{B}'}| = |E_{\mathcal{B}}| + 2$ .

(b)  $B_{u'} \neq 1$ . Let  $\mathcal{B}(u)$  (resp.  $\mathcal{B}(u')$ ) denote the essential piece that contains  $u$  (resp.  $u'$ ). We first construct  $\mathcal{B}'$  by collapsing  $\mathcal{B}(u')$  into  $u'$  (hence  $B'_{u'} \neq 1$ ) and by collapsing cyclic edges in  $\mathcal{B}(u)$  so that  $\text{Star}_{\mathcal{B}'}(u) \cap E_{\mathcal{B}'} = \{h\}$ .

Let now  $\mathcal{B}''$  be the  $\mathbb{A}$ -graph that is obtained from  $\mathcal{B}'$  by replacing the vertex group  $B'_u = B_u$  by  $B''_u = A_v$ , see Figure 22. Note that the rank increases by one,

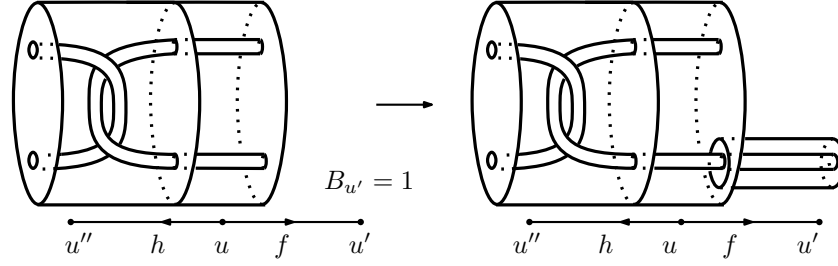
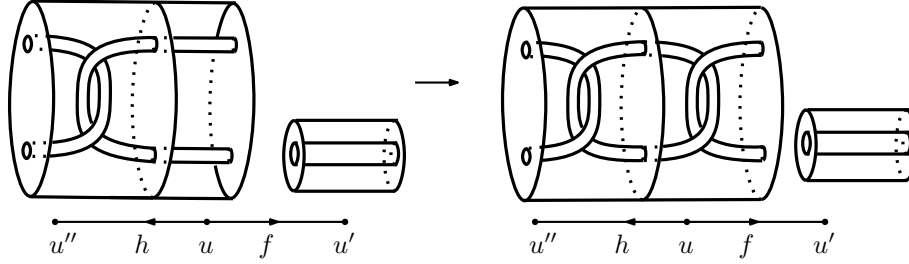

FIGURE 21. Case (2.a).

hence  $c(\mathcal{B}'') > c(\mathcal{B})$ . The edges  $f$  and  $h$  can be folded since  $u$  is full in  $\mathcal{B}''$  and  $f$  and  $h$  are of same type. The  $\mathbb{A}$ -graph that is obtained by this fold is good and its rank is at most  $\text{rank}(\mathcal{B})$  since the vertices  $u'$  and  $u''$  are identified. The complexity decreases because the number of edges decreases.

 FIGURE 22. Case (2.b). The construction of  $\mathcal{B}''$ .

*Case 3:  $u$  is cyclic.* As in the previous case we can assume that  $u'$  is not full. As  $u$  is cyclic we have  $B_u = \langle gx_i g^{-1} \rangle$  for some  $g \in A_v$  and some  $i \in \{1, 2\}$ . Since the intersection  $B_u \cap o_f \alpha_e(A_e) o_f^{-1}$  is non-trivial, Lemma 3.1 implies that  $i = 1$ . Lemma 3.8(1) tells us that after auxiliary moves we have  $B_u = \langle x_1 \rangle$  and  $o_f = x_2^{-\varepsilon}$  for some  $\varepsilon \in \{0, 1\}$ . We distinguish two cases depending on the vertex group  $B_{u'}$ .

(a)  $B_{u'} = 1$ . In this case we simply replace the edge group  $B_f = 1$  by  $B'_f = \langle y_i \rangle$  and the vertex group  $B_{u'} = 1$  by

$$B'_{u'} = \langle t_f^{-1} \omega_e(y_i) t_f \rangle \leq A_v.$$

Observe that  $i = 1$  if  $\varepsilon = 1$  and  $i = 2$  if  $\varepsilon = 0$ . The new  $\mathbb{A}$ -graph is clearly good. The complexity decreases because  $\text{rank}(\mathcal{B}') = \text{rank}(\mathcal{B})$ ,  $|EB'| = |EB|$ ,  $e_{full}(\mathcal{B}') = e_{full}(\mathcal{B})$  and  $|E_{\mathcal{B}'}| = |E_{\mathcal{B}}| + 2$ .

(b)  $B_{u'} \neq 1$ . Let  $\mathcal{B}(u)$  (resp.  $\mathcal{B}(u')$ ) denote the essential piece of  $\mathcal{B}$  that contains the vertex  $u$  (resp. the vertex  $u'$ ). We need to consider various cases depending on  $\mathcal{B}(u)$  and  $\mathcal{B}(u')$ .

*$\mathcal{B}(u)$  and  $\mathcal{B}(u')$  are cyclic essential pieces.* We first collapse  $\mathcal{B}(u)$  and  $\mathcal{B}(u')$  into  $u$  and  $u'$  respectively. Then we replace the vertex group  $B_{u'}$  by  $B'_{u'} = A_v = \langle x_1, x_2 \rangle$ , the vertex group  $B_u$  by  $\alpha_e(A_e) = \langle x_2 x_1^{-1} x_2^{-1}, x_1 \rangle \leq A_v$  and the edge group  $B_f = 1$

by  $B'_f = A_e = \langle y_1, y_2 \rangle$ , see Figure 23. This  $\mathbb{A}$ -graph is good and its complexity decreases since the number of full edges increase by two. Note that this move turns  $u$  (resp.  $u'$ ) into an almost full vertex (resp. full vertex).

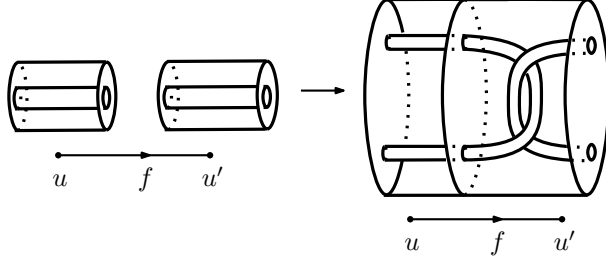

FIGURE 23. Case (3).

$\mathcal{B}(u)$  is a non-cyclic essential piece. After collapsing  $\mathcal{B}(u')$  into  $u'$  we can assume that the vertex group  $B_{u'}$  is cyclic and  $\text{Star}_{\mathcal{B}}(u') \cap E_{\mathcal{B}} = \emptyset$ . Let  $u''$  be the closest full vertex in  $\mathcal{B}(u)$  to  $u$  and let  $f_1, \dots, f_k$  be the shortest path from  $u$  to  $u''$ . After collapsing  $\mathcal{B}(u)$  into  $u$  we can assume that  $B_u = \langle x_1 \rangle$  and  $B_{u''} = \langle gx_i g^{-1} \rangle$  for some  $g \in A_v$  and some  $i \in \{1, 2\}$ . It follows from Lemma 3.8 that  $[f_i] = e$  if  $i \in \{1, \dots, k\}$  is odd and  $[f_i] = e^{-1}$  if  $i \in \{1, \dots, k\}$  is even.

Let  $\mathcal{B}'$  be the  $\mathbb{A}$ -graph obtained from  $\mathcal{B}$  by replacing the vertex groups  $B_u$  and  $B_{u'}$  by  $B'_u = A_v = \langle x_1, x_2 \rangle$  and  $B'_{u'} = A_v = \langle x_1, x_2 \rangle$  and replacing the edge group  $B_f = 1$  by  $B'_f = A_e = \langle x_1, x_2 \rangle$ . Thus  $u$  and  $u'$  (resp.  $f$ ) are full vertices (resp. full edge) in  $\mathcal{B}'$ . Observe further that  $\mathcal{B}'$  is good and represents a meridional subgroup that contains  $U(\mathcal{B}, u_0)$  because we are replacing vertex groups and edge groups by larger ones. The only issue we need to solve is the rank which increase by one in going from  $\mathcal{B}$  to  $\mathcal{B}'$ . We remedy this as follows. Since  $u$  and  $u'$  are full vertices and  $[f_i] = e$  we conclude that the vertex  $u'' = \omega(f_k)$  folds onto  $u$  or  $u'$  depending on the parity of  $d$ , see Figure 24. Thus the rank of the resulting  $\mathbb{A}$ -graph clearly drops back to  $\text{rank}(\mathcal{B})$ . Since the number of edges decreases we see that  $c(\mathcal{B}') < c(\mathcal{B})$ .

$\mathcal{B}(u)$  is cyclic and  $\mathcal{B}(u')$  is non-cyclic. We modify  $\mathcal{B}$  to fall in the previous case. After unfolding along some edges in  $\mathcal{B}(u')$  we can assume that  $\{h\} = \text{Star}_{\mathcal{B}}(u') \cap E_{\mathcal{B}}$ . Observe that  $u'$  either cyclic or almost full.

Let  $\mathcal{B}'$  be the  $\mathbb{A}$ -graph obtained from  $\mathcal{B}$  by doing the following:

- (1) replace all vertex and edge groups in  $\mathcal{B}(u)$  by trivial groups.
- (2) replace  $B_{u'}$  by  $B'_{u'} = \langle t_f^{-1} \omega_e(y_1) t_f \rangle$ .
- (3) replace  $B_h$  by  $B_h = 1$ .

Thus  $\mathcal{B}'$  is good and the rank is not affected. Now a fold along the edge  $h^{-1}$  can be applied to  $\mathcal{B}'$ . To see that we fall in the previous case observe that the essential piece of  $\mathcal{B}'$  that contains  $u'$  is cyclic (as it contains only the vertex  $u'$ ) and the essential piece of  $\mathcal{B}'$  that contains  $u'' := \omega(h)$  is non-cyclic since  $u'$  is not full in  $\mathcal{B}$ .  $\square$

#### 4. MERIDIONAL RANK OF WHITEHEAD DOUBLES

In this section we prove Theorem 1.1. We follow the notation introduced in Section 2. We will first compute the bridge number of the Whitehead double of

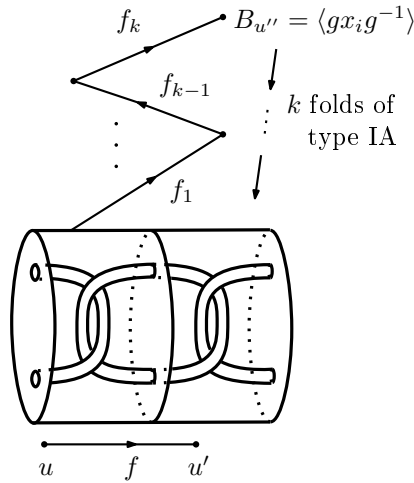

FIGURE 24. Case (2.b).  $u''$  folds onto  $u$  or  $u'$ .

an arbitrary knot. Thus let  $\mathfrak{k}_1$  be an arbitrary non-trivial knot and let  $\mathfrak{k}$  be a Whitehead double of  $\mathfrak{k}_1$ . We compute  $b(\mathfrak{k})$  using the notion of plat presentations.

We say that a knot  $\mathfrak{k}'$  is a plat on  $2n$ -strings (or simply a  $2n$ -plat) if  $\mathfrak{k}'$  is the union of a braid with  $2n$  strings and  $2n$  unlinked and unknotted arcs which connect pairs of consecutive strings of the braid at the top and at the bottom endpoints, see Figure 25. Any knot admits a plat presentation, that is, it is ambient isotopic to a plat. According to [5, Theorem 5.2] the minimal  $n$  such that  $\mathfrak{k}'$  admits a plat presentation with  $2n$ -strings coincides with the bridge number of  $\mathfrak{k}'$ .

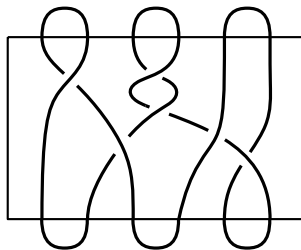
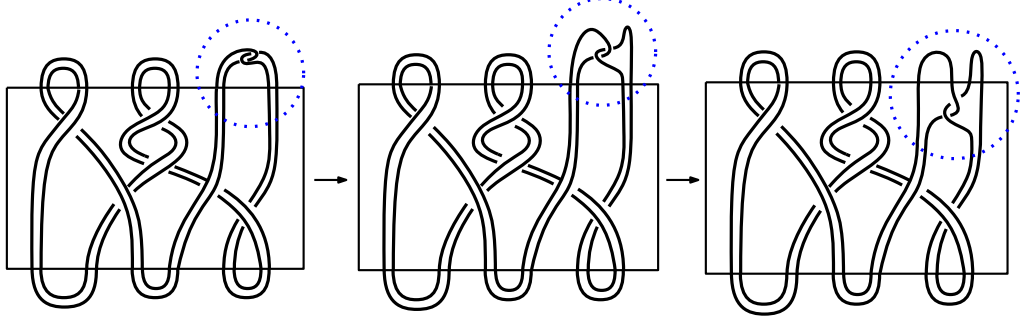

FIGURE 25. A 6-plat.

We show that  $b(\mathfrak{k}) = 2b(\mathfrak{k}_1)$ . A plat presentation with  $2(2b(\mathfrak{k}_1))$ -strings for  $\mathfrak{k}$  is described in Figure 26. Hence  $b(\mathfrak{k}) \leq 2b(\mathfrak{k}_1)$ . On the other hand, as the index of the Whitehead pattern  $(V, \mathfrak{k}_0)$  is 2, it follows from [19] (see also [20]) that  $b(\mathfrak{k}) \geq 2b(\mathfrak{k}_1)$ .

We now show that if  $\mathfrak{k}_1$  is prime and algebraically tame then  $w(\mathfrak{k}) = b(\mathfrak{k})$ . Let  $\mathbb{A}$  be the graph of groups described in subsection 2.2. Recall that  $A_{v_0} = \pi_1(E, e_0) = \langle x_1, x_2, l_V \mid l_V \cdot x_2 x_1^{-1} x_2^{-1} x_1 x_2^{-1} \cdot l_V^{-1} = x_2 x_1^{-1} x_2^{-1}, l_V \cdot x_2 \cdot l_V^{-1} = x_1 \rangle$ . By choosing the base point appropriately we can assume that  $m = [x_1] \in \pi_1(\mathbb{A}, v_0)$  is the fixed meridian of  $\mathfrak{k}$ .

FIGURE 26. Whitehead double of  $\mathfrak{k}_1$ .

We say that an  $\mathbb{A}$ -graph  $\mathcal{B}$  is *tame* if the following hold:

(T0)  $\mathcal{B}$  is  $\pi_1$ -surjective meaning that the induced homomorphism

$$\phi : \pi_1(\mathbb{B}, u_0) \rightarrow \pi_1(\mathbb{A}, v_0) \cong G(\mathfrak{k})$$

is surjective for some (and therefore) any vertex  $u_0$  of type  $v_0$ .

(T1) the underlying graph  $B$  is a finite tree.

(T3) edge groups are either trivial or equal to  $\langle m_e \rangle$ .

(T3) for each vertex  $u \in VB$  of type  $v_0$  the vertex group  $B_u \leq A_{v_0}$  is good.

(T4) for each vertex  $u \in VB$  of type  $v_1$  the following hold:

(a)  $B_u = \langle g_1 m_1 g_1^{-1}, \dots, g_r m_1 g_r^{-1} \rangle$  where  $r = w(B_u) < b(\mathfrak{k}_1)$ .

(b) for each  $i = 1, \dots, r$  there is an edge  $f_i \in \text{Star}_B(u) \cap E_{\mathcal{B}}$  such that  $g_i m_1 g_i^{-1}$  is (in  $B_u$ ) conjugate to  $o_{f_i} m_1 o_{f_i}^{-1} = o_{f_i} \alpha_e(m_e) o_{f_i}^{-1}$ .

The complexity of a tame  $\mathbb{A}$ -graph is defined as the triple

$$c(\mathcal{B}) := (c_1(\mathcal{B}), |EB|, |EB| - |E_{\mathcal{B}}|) \in \mathbb{N}_0^3$$

where

$$c_1(\mathcal{B}) := \sum_{\substack{u \in VB \\ [u] = v_0}} \bar{w}(B_u)$$

Recall that  $\bar{w}(B_u)$  denotes the minimal number of conjugates (in  $A_{v_0}$ ) of  $x_1$  and  $x_2$  needed to generate  $B_u$ . The set  $\mathbb{N}_0^3$  is equipped with the lexicographic order.

A straightforward inspection of the various cases reveals that all auxiliary moves preserve tameness and complexity, i.e. if  $\mathcal{B}'$  is obtained from a tame  $\mathbb{A}$ -graph  $\mathcal{B}$  by an auxiliary move then  $\mathcal{B}'$  is also tame and  $c(\mathcal{B}') = c(\mathcal{B})$ .

*proof of Theorem 1.1.* We want to show that  $w(\mathfrak{k}) = b(\mathfrak{k})$ . The proof will be contradiction. Thus assume that

$$G(\mathfrak{k}) = \langle g_1 m g_1^{-1}, \dots, g_l m g_l^{-1} \rangle$$

with  $l < b(\mathfrak{k})$ . Each  $g_i$  can be written as  $g_i = [p_i]$  where  $p_i$  is a non-necessarily reduced  $\mathbb{A}$ -path from  $v_0$  to  $v_0$  of positive length.

We define an  $\mathbb{A}$ -graph  $\mathcal{B}_0$  as follows. Start with a vertex  $u_0$  of type  $v_0$  and for each  $1 \leq s \leq l$  we glue an interval  $l_s$  subdivided into  $\text{length}(p_s)$  segments to  $u_0$ . The label of  $l_s$  is defined so that  $\mu(l_s) = p_s$ . The vertex group of  $\omega(l_s)$  is  $\langle m \rangle$  and the remaining vertex and edge groups are trivial. Therefore

$$\phi([l_s m l_s^{-1}]) = [\mu(l_s) m \mu(l_s)^{-1}] = [p_s m p_s^{-1}] = g_s x_{i_s} g_s^{-1},$$



and  $\mathcal{B}_0$  is  $\pi_1$ -surjective. Observe that  $\mathcal{B}_0$  is tame since the only non-trivial vertex groups are cyclically generated by the meridian  $m = [x_1] \in A_{v_0}$ , and so are good subgroups of  $A_{v_0}$ .

The claim that  $w(\mathfrak{k}) < b(\mathfrak{k})$  therefore implies the existence of a tame  $\mathbb{A}$ -graph.

Now choose a tame  $\mathbb{A}$ -graph  $\mathcal{B}$  such that  $c(\mathcal{B})$  is minimal. Since  $\mathcal{B}_0$  is tame it follows that  $c_1(\mathcal{B}) \leq c_1(\mathcal{B}_0) = l < b(\mathfrak{k})$ .

Since all edge groups in  $\mathcal{B}$  are proper subgroups of  $A_e = \langle m_e, l_e \rangle$  we conclude that  $\mathcal{B}$  is not folded. As the underlying graph of  $\mathcal{B}$  is a tree we conclude that a fold of type IA or a fold of type IIA can be applied to  $\mathcal{B}$ . We consider these two cases separately.

**Fold of type IA.** In this case a pair of distinct edges  $f_1$  and  $f_2$  starting at a common vertex  $u := \alpha(f_1) = \alpha(f_2) \in VB$  can be folded. After auxiliary moves we can assume that the fold is elementary, that is,  $f_1$  and  $f_2$  have same label:

$$(a, e', b) := (o_{f_1}, [f_1], t_{f_1}) = (o_{f_2}, [f_2], t_{f_2}) \in A_{[u]} \times EA \times A_{[\omega(f_1)]}.$$

Put  $y_1 := \omega(f_1)$  and  $y_2 := \omega(f_2)$ .

Let  $\mathcal{B}'$  be the  $\mathbb{A}$ -graph that is obtained from  $\mathcal{B}$  by folding  $f_1$  and  $f_2$ . By definition, the edge groups  $B_{f_1}$  and  $B_{f_2}$  are replaced by

$$B'_f = \langle B_{f_1}, B_{f_2} \rangle \leq A_e$$

and the vertex groups  $B_{y_1}$  and  $B_{y_2}$  are replaced by

$$B'_y = \langle B_{y_1}, B_{y_2} \rangle \leq A_{[y]},$$

see Figure 27. Observe that  $B'_f$  is either trivial or generated by  $m_e$  and that  $B'_y \leq A_{[y_1]} = A_{[y_2]}$  is meridional, that is, generated by conjugates of  $x_1$  and  $x_2$  if  $[y_1] = v_0$  and generated by conjugates of  $m_1$  if  $[y_1] = v_1$ . We consider two cases

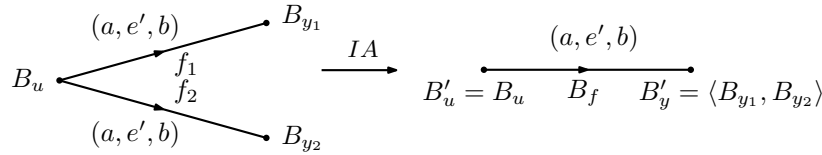

FIGURE 27. An elementary fold of type IA.

depending on the type  $e'$  of  $f_1$  and  $f_2$ .

*Case 1:  $e' = e$ .* In this case  $u$  is of type  $v_0$  and  $y_1$  and  $y_2$  are of type  $v_1$ . The only tameness condition that is not trivially satisfied is condition (T4.a). Condition (T4.b) says that there are  $w(B_{y_i})$  edges in

$$S_i := \text{Star}_B(y_i) \cap EB = \{f \in EB \mid B_f \neq 1 \text{ and } \alpha(f) = y_i\}.$$

Let  $f \in S_1 \cup S_2$ . Since  $B_f = \langle m_e \rangle$  it follows that  $t_f^{-1} m_v t_f \in B_{\omega(f)}$ . Condition (2) in the definition of good subgroups of  $A_{v_0} = \pi_1(E, e_0)$  then implies that  $\bar{w}(B_{\omega(f)}) \geq 2$ . Therefore, if  $\omega(f) \neq \omega(f')$  for all  $f \in S_1$  and all  $f' \in S_2$  (or equivalently, if  $f_1^{-1} \cup f_2^{-1}$

is not contained in  $S_1 \cup S_2$ ) then

$$\begin{aligned} 2w(B'_y) &\leq 2w(B_{y_1}) + 2w(B_{y_2}) \\ &\leq 2|S_1| + 2|S_2| \\ &\leq \sum_{f \in S_1 \cup S_2} \bar{w}(B_{\omega(f)}) \\ &\leq c_1(\mathcal{B}) \end{aligned}$$

and so  $2w(B'_y) \leq c_1(\mathcal{B}) \leq l < b(\mathfrak{k}) = 2b(\mathfrak{k}_1)$  which implies that  $w(B'_y) < b(\mathfrak{k}_1)$ . If  $f_1^{-1} \in S_1$  and  $f_2^{-1} \in S_2$  then, since  $B_{y_i} \leq A_{v_1}$  is tame and the meridian

$$t_{f_i}^{-1} m_1 t_{f_i} = b^{-1} m_1 b$$

lies in  $B_{y_i}$ , we can assume that  $b^{-1} m_1 b$  is part of a minimal meridional generating set of  $B_{y_i}$ . Thus

$$w(B'_y) \leq w(B_{y_1}) + w(B_{y_2}) - 1.$$

The same computation as above with the summation taken over the set  $S_1 \cup S_2 \setminus \{f_1^{-1}\}$  shows that  $w(B'_y) < b(\mathfrak{k}_1)$ . Therefore  $\mathcal{B}$  is tame. Since no vertex of type  $v_0$  is affected we see that  $c_1(\mathcal{B}') \leq c_1(\mathcal{B})$  and since the number of edges drops by two we conclude that  $c(\mathcal{B}') < c(\mathcal{B})$ .

*Case 2.*  $e' = e^{-1}$ . Thus  $u$  is of type  $v_1$  and  $y_1$  and  $y_2$  are of type  $v_0$ . It follows from Proposition 3.6 that  $B'_y = \langle B_{y_1}, B_{y_2} \rangle \leq A_{v_0}$  is contained in a good subgroup  $B''_y \leq A_{v_0}$  such that  $\bar{w}(B''_y) \leq \bar{w}(B'_w)$ .

Let  $\mathcal{B}''$  be the  $\mathbb{A}$ -graph that is obtained from  $\mathcal{B}'$  by replacing the vertex group  $B'_y$  by  $B''_y \leq A_{v_0}$ . Thus  $\mathcal{B}''$  is tame and

$$c_1(\mathcal{B}'') - c_1(\mathcal{B}) = \bar{w}(B''_y) - \bar{w}(B_{y_1}) - \bar{w}(B_{y_2}) \leq 0.$$

Since two edges are identified we conclude that  $c(\mathcal{B}'') < c(\mathcal{B})$  which contradicts our choice of  $\mathcal{B}$ .

**Fold of type IIA.** We can assume that no fold of type IA is applicable to  $\mathcal{B}$ . By definition of type IIA folds, there is an edge  $f \in EB$  such that

$$B_f \neq \alpha_{e'}^{-1}(o_f^{-1} B_x o_f)$$

where  $e' := [f] \in EA$  and  $x := \alpha(f) \in VB$ . Let  $y$  denote the vertex  $\omega(f) \in VB$ . We consider two cases depending on the type  $e'$  of  $f$ .

*Case 1.*  $e' = e^{-1}$ . Thus  $x$  is of type  $v_1$  and  $B_x$  is a tame subgroup of  $A_{v_1} = G(\mathfrak{k}_1)$ . Assume that

$$B_x = \langle h_1 m_1 h_1^{-1}, \dots, h_r m_1 h_r^{-1} \rangle$$

where  $r = w(B_x)$ . From

$$\alpha_{e^{-1}}^{-1}(o_f^{-1} B_x o_f) \neq 1$$

it follows that

$$o_f \alpha_{e^{-1}}(A_e) o_f^{-1} \cap B_x \neq 1.$$

The tameness of the meridional subgroup  $B_x \leq A_{v_1}$  implies that

$$o_f \alpha_{e^{-1}}(A_e) o_f^{-1} \cap B_x = o_f \langle m_1 \rangle o_f^{-1}$$

and  $o_f m_1 o_f^{-1}$  is in  $B_x$  conjugate to  $h_i m_1 h_i^{-1}$  for some  $1 \leq i \leq r$ . Condition (T4.b) says that there is  $g \in Star_B(x) \cap E_B$  such that  $o_g m_1 o_g^{-1}$  is in  $B_u$  conjugate to  $h_i m_1 h_i^{-1}$ . Hence,  $o_g m_1 o_g^{-1}$  and  $o_f m_1 o_f^{-1}$  are conjugate in  $B_x$ . Lemma 2.3 then

implies that  $o_f = ao_g c$  for some  $a \in B_x$  and some  $c \in P(\mathfrak{k}_1)$ . This equality implies that a fold of type IA can be applied to  $\mathcal{B}$  since  $P(\mathfrak{k}_1) = \alpha_{e^{-1}}(A_{e^{-1}}) = \omega_e(A_e)$ , which contradicts our assumption on  $\mathcal{B}$ .

*Case 2.*  $e' = e$ . Hence  $x$  is of type  $u_0$  and so  $B_x$  is a good subgroup of  $A_{v_0}$ . Thus

$$o_f \alpha_e(A_e) o_f^{-1} \cap B_u = o_f C_V o_f^{-1} \cap B_u = o_f \langle m_V \rangle o_f^{-1}$$

since  $o_f \alpha_e(A_e) o_f^{-1} \cap B_u$  is non-trivial.

Let  $\mathcal{B}'$  be the  $\mathbb{A}$ -graph that is obtained from  $\mathcal{B}$  by replacing  $B_y$  by

$$B'_y = \langle B_y, t_f^{-1} m_1 t_f \rangle$$

and  $B_f = 1$  by  $B'_f = \langle m_e \rangle$ . The only tameness condition that is not trivially satisfied is condition (T4.a), i.e.  $w(B'_y) < b(\mathfrak{k}_1)$ . To see this we apply the same computation as in the case of a fold of type IA based on an edge of type  $e$ . The complexity clearly decreases since no vertex of type  $v_0$  is affected,  $|EB'| = |EB|$  and  $|E_{\mathcal{B}'}| = |E_{\mathcal{B}}| + 2$ .  $\square$

$$\begin{array}{ccc} B_x & \xrightarrow{(o_f, e, t_f)} & B_y \\ \longleftarrow & & \longrightarrow \\ & B_f = 1 & \end{array} \quad \xrightarrow{IIA} \quad \begin{array}{ccc} B_x & \xrightarrow{(o_f, e, t_f)} & B'_y = \langle B_y, t_f^{-1} m_1 t_f \rangle \\ \longleftarrow & & \longrightarrow \\ & B'_f = \langle m_e \rangle & \end{array}$$

FIGURE 28. An elementary fold of type IIA when  $[f] = e$ .

## 5. ALGEBRAICALLY TAME KNOTS AND BRAID SATELLITES

In this section we prove Theorem 1.2. We follow the notation from Section 2. Let  $\mathfrak{k}_1$  be a prime algebraically tame knot and let  $\mathfrak{k}$  be a braid satellite of  $\mathfrak{k}_1$  with braid pattern  $\beta$ . We want to show that  $\mathfrak{k}$  is algebraically tame. To this end we must show that any meridional subgroup of  $G(\mathfrak{k})$  that is generated by less than  $b(\mathfrak{k})$  meridians is tame where  $n$  is the number of strand of  $\beta$ . Let  $\mathbb{A}$  be the graph of groups described in Section 2. Recall that

$$A_{v_0} = F(x_1, \dots, x_n) \rtimes \langle t \rangle$$

where the action of  $\langle t \rangle \cong \mathbb{Z}$  in  $F(x_1, \dots, x_n)$  is given by

$$t x_i t^{-1} = a_i x_{\tau(i)} a_i^{-1} \quad \text{for } 1 \leq i \leq n$$

where  $a_1, \dots, a_n \in F(x_1, \dots, x_n)$  and  $\tau \in S_n$  is the permutation associated to  $\beta$ . By choosing the base point appropriately we can assume that  $m = [x_1] \in \pi_1(\mathbb{A}, v_0)$  is the fixed meridian of  $\mathfrak{k}$ .

Thus let  $U \leq G(\mathfrak{k})$  be a meridional subgroup with  $r := w(U) < b(\mathfrak{k})$  (it follows from [19] that  $b(\mathfrak{k}) = nb(\mathfrak{k}_1)$ ). In order to show that  $U$  is tame we study  $\mathbb{A}$ -graphs that represent  $U$ . However, we do not consider arbitrary ones but only those that are ‘‘nice’’ in the following sense. We say that an  $\mathbb{A}$ -graph  $\mathcal{B}$  is *benign* if:

- (B0)  $\mathcal{B}$  represents  $U$ , that is,  $U(\mathcal{B}, u_0) = U$  for some vertex  $u_0 \in VB$  of type  $v_0 \in VA$ .
- (B1) the underlying graph of  $\mathcal{B}$  is a finite tree.
- (B2) the edge groups are either trivial or equal to  $\langle m_e \rangle$ .
- (B3) for each vertex  $u \in VB$  of type  $v_0$  the corresponding vertex group  $B_u$  is meridional (generated by conjugates in  $A_{v_0}$  of  $x_1$ ).

(B4) for each vertex  $u \in VB$  of type  $v_1$  the following hold:

- (a)  $B_u = \langle g_1 m_1 g_1^{-1}, \dots, g_r m_r g_r^{-1} \rangle$  such that  $r = w(B_u) < b(\mathfrak{k}_1)$ .
- (b) for each  $i = 1, \dots, r$  there is an edge  $f_i \in Star_B(u) \cap E_{\mathcal{B}}$  such that  $g_i m_i g_i^{-1}$  is (in  $B_u$ ) conjugate to  $o_{f_i} m_i o_{f_i}^{-1}$ .

The complexity of a benign  $\mathbb{A}$ -graph  $\mathcal{B}$  is defined as the triple

$$c(\mathcal{B}) := (c_1(\mathcal{B}), |EB|, |EB| - |E_{\mathcal{B}}|)$$

where

$$c_1(\mathcal{B}) = \sum_{\substack{u \in VB \\ [u] = v_0}} rank(B_u).$$

The same construction as in the previous section shows that there is a benign  $\mathbb{A}$ -graph such that  $c_1(\mathcal{B}_0) = r = w(U)$ . Now choose a benign  $\mathbb{A}$ -graph  $\mathcal{B}$  such that  $c(\mathcal{B})$  is minimal. An argument completely analogous to the one given in the previous section, with the obvious adjustments and using Lemma 2.1 instead of Proposition 3.6 and the notion of good subgroups, shows that if  $\mathcal{B}$  is not folded then there is a benign  $\mathbb{A}$ -graph that represents  $U$  and has smaller complexity. Therefore  $\mathcal{B}$  must be folded.

We now use the foldedness of  $\mathcal{B}$  to show that  $U$  is tame. According to Lemma 2.1, for each  $u \in VB$  with  $[u] = v_0$ , the corresponding vertex group  $B_u$  is freely generated by

$$g_{u,1} x_1 g_{u,1}^{-1}, \dots, g_{u,r_u} x_1 g_{u,r_u}^{-1}$$

where  $r_u := rank(B_u)$  and  $g_{u,i} \in A_{v_0}$ . For each such  $u$  let  $\gamma_u$  be a reduced  $\mathbb{B}$ -path from  $u_0$  to  $u$ . Then

$$S := \{m_{u,i} := [\mu(\gamma_u \cdot g_{u,i} x_1 g_{u,i}^{-1} \cdot \gamma_u^{-1})] \mid u \in VB \text{ s.t. } [u] = v_0 \text{ and } 1 \leq i \leq r_u\}$$

is a meridional generating set of  $U$  of minimal size. First observe that, as  $\mathcal{B}$  is folded,  $m_{u,i}$  is conjugate to  $m_{u',i'}$  iff  $u = u'$  and  $g_{u,i} x_1 g_{u,i}^{-1}$  is in  $B_u$  conjugate to  $g_{u,i'} x_1 g_{u,i'}^{-1}$ . Lemma 2.1 therefore implies that  $i = i'$  and so the meridians  $m_{u,i}$  are pairwise non conjugate. Next we show that for any  $g \in G(\mathfrak{k})$  either  $gP(\mathfrak{k})g^{-1} \cap U = 1$  or  $gP(\mathfrak{k})g^{-1} \cap U = g\langle m \rangle g^{-1}$  and  $gmg^{-1}$  is in  $U$  conjugate to some of the meridians in  $S$ . Assume that  $gpg^{-1} \in U$  for some non-trivial peripheral element  $p \in P(\mathfrak{k})$ . The foldedness of  $\mathcal{B}$  implies that there is  $u \in VB$  of type  $v_0$  such that  $B_u$  contains a conjugate (in  $A_{v_0}$ ) of  $p$ . Lemma 2.1 implies that:

- (1)  $p \in \langle x_1 \rangle$  and  $cx_1c^{-1} \in B_u$  for some  $c \in A_{v_0}$ .
- (2)  $cx_1c^{-1}$  is in  $B_u$  conjugate to  $g_{u,i} x_1 g_{u,i}^{-1}$  for some  $1 \leq i \leq r_u$ .

Therefore  $gP(\mathfrak{k})g^{-1} = g\langle m \rangle g^{-1}$  and  $gmg^{-1}$  is in  $U$  conjugate  $m_{u,i}$  for some  $u$  and some  $i$  as before. This completes the proof of the theorem.

## REFERENCES

1. I. Agol, *Pants immersed in hyperbolic 3-manifolds*, Pac. J. Math. 241 (2009) 201-214.
2. M. Aschenbrenner et al. *3-manifold groups*. Vol. 20. Zürich: European Mathematical Society, 2015.
3. Sebastian Baader, Ryan Blair and Alexandra Kjachukova, *Coxeter groups and meridional rank of links*, Mathematische Annalen **379**(3), 1533-1551 (2021).
4. S. Baader, R. Blair, A. Kjachukova and F. Misev, *The bridge number of arborescent links with many twigs*, arXiv:2008.00763 [math.GT].
5. J.S. Birman, *Braids, links and mapping class groups*, Annals of Mathematical studies **82** (University Press, Princeton, 1974).

6. R. Blair, A. Kjuchukova, R. Velazquez, and P. Villanueva, *Wirtinger systems of generators of knot groups*, Communications in Analysis and Geometry Volume **28**(2), 243–262 (2020).
7. M. Boileau, E. Dutra, Y. Jang and R. Weidmann, *Meridional rank of knots whose exterior is a graph manifold*, Topol. Appl. **228**, 458–485 (2017).
8. M. Boileau, Y. Jang and R. Weidmann, *Meridional rank and bridge number for a class of links*, Pac. J. Math. **292**(1), 61–80 (2017)
9. M. Boileau and H. Zieschang, *Nombre de ponts et générateurs méridiens des entrelacs de Montesinos*, Comment. Math. Helvetici **60** (1985), 270–279.
10. M. Boileau and B. Zimmermann, *The  $\pi$ -orbifold group of a link*, Math. Z. **200** (1989), 187–208.
11. G. Burde, H. Zieschang. Knots. Walter de Gruyter, 1985.
12. C. R. Cornwell, *Knot contact homology and representations of knot groups*, Journal of Topology **7** (2014) 1221–1242.
13. C. R. Cornwell and D. R. Hemminger, *Augmentation Rank of Satellites with Braid Pattern*, arXiv:1408.4110.
14. I. A. Grushko, *On the bases of a free product of groups*, Mat. Sb. 8 (1940) 169–182.
15. I. Kapovich, A. Myasnikov and R. Weidmann, *Foldings, graphs of groups and the membership problem*. Internat. J. Algebra Comput. **15** (2005), no. 1, 95–128.
16. R. (Ed.) Kirby. *Problems in low-dimensional topology*, In Proceedings of Georgia Topology Conference, Part 2, pages 35–473. Press, 1995.
17. M. Lustig and Y. Moriah, *Generalized Montesinos knots, tunnels and  $N$ -torsion*, Math. Ann. **295** (1992), 167–189.
18. M. Rost and H. Zieschang, *Meridional generators and plat presentations of torus links*, J. London Math. Soc. (2) **35** (1987), no. 3, 551–562.
19. H. Schubert. *Über einer numerische knoteninvarianten*. Math. Z. (61) 1954 245–288.
20. J. Schultens (2003). *Additivity of bridge numbers of knots*. Math. Proc. Cambridge Philos. Soc., 135, pp 539–544 doi:10.1017/S0305004103006832.
21. R. Weidmann, *On the rank of amalgamated products and product knot groups*, Math. Ann. **312** (1998) 761–771.
22. R. Weidmann, *The rank problem for sufficiently large fuchsian groups*, Proc. London Math. Soc. (3) **95** (2007), 609–652.

UNIVERSIDADE FEDERAL DE SÃO CARLOS, SÃO CARLOS, BRAZIL  
 Email address: edersondutra@dm.ufscar.br