

NON \mathbb{R} -COVERED ANOSOV FLOWS IN HYPERBOLIC 3-MANIFOLDS ARE QUASIGEODESIC

SERGIO R. FENLEY

ABSTRACT. The main result is that if an Anosov flow in a closed hyperbolic three manifold is not \mathbb{R} -covered, then the flow is a quasigeodesic flow. We also prove that if a hyperbolic three manifold supports an Anosov flow, then up to a double cover it supports a quasigeodesic flow. We prove the continuous extension property for the stable and unstable foliations of any Anosov flow in a closed hyperbolic three manifold, and the existence of group invariant Peano curves associated with any such flow.

Keywords: Anosov flows, quasigeodesic flows, geometric properties of flow lines, freely homotopic orbits, large scale geometry of flows.

Mathematics Subject Classification 2020: Primary: 57R30, 37E10, 37D20, 37C85; Secondary: 53C12, 37C27, 37D05, 37C86.

1. INTRODUCTION

This article studies geometric properties of Anosov flows in 3-manifolds, with a particular interest when the manifold is hyperbolic. The goal is to study the quasigeodesic property for such flows. A *quasigeodesic* is a rectifiable curve so that length along the curve is a uniformly efficient measure of distance, up to a bounded multiplicative distortion and additive constant, when lifted to the universal cover. Quasigeodesics are extremely important when the manifold is hyperbolic [Th1, Th2, Gr]. A flow with no point orbits is a quasigeodesic flow if all its orbits are quasigeodesics.

A suspension Anosov flow, or any suspension flow in any manifold for that matter, is quasigeodesic [Ze]. Any closed 3-manifold fibering over the circle with pseudo-Anosov monodromy is hyperbolic [Th2], hence the class of quasigeodesic flows in hyperbolic 3-manifolds is very large. What should a quasigeodesic flow in a hyperbolic 3-manifold look like? Calegari [Cal3] started the study of such flows, and this was greatly extended by work of Frankel [Fra1, Fra2, Fra3]. Frankel analyzed the universal circle associated with such flows and also the stable and unstable decomposition sets in the orbit space of such flows. He used the stable and unstable decompositions to prove that such flows always have closed orbits [Fra3].

Hence it is very natural to consider pseudo-Anosov flows in this setting and ask: given a pseudo-Anosov flow in a closed hyperbolic 3-manifold when is it quasigeodesic? In this article we will answer this question in the case of Anosov flows, that is, when there are no p -prong singularities with $p \geq 3$. More specifically we will consider topological Anosov flows: it is a weakening of the Anosov property allowing for less regularity. See precise definition in Section 2. Still the orbits of topological Anosov flows are C^1 curves, hence rectifiable.

Research partially supported by Simons foundation grant 637554, by National Science Foundation grant DMS-2054909 and by the Institute for Advanced Study.

In general it is very hard to decide whether an Anosov flow is quasigeodesic, or not, and this question has remained open until now. In fact the first result previously obtained is a negative one. A codimension one foliation is called \mathbb{R} -covered if the leaf space of the foliation lifted to the universal cover of the manifold is homeomorphic to the real line \mathbb{R} [Fe1]. An Anosov flow in a 3-manifold is called \mathbb{R} -covered if the stable and the unstable 2-dimensional foliations of the flow are \mathbb{R} -covered [Fe1]. It is enough to assume that one of these foliations is \mathbb{R} -covered [Ba1]. For Anosov flows in 3-manifolds, there are many examples: suspensions and geodesic flows for example. Using Dehn surgery on periodic orbits of suspensions and geodesic flows [Go, Fr], it was proved in [Fe1] that there are infinitely many examples of \mathbb{R} -covered Anosov flows in hyperbolic 3-manifolds.

The first result in hyperbolic manifolds was that any \mathbb{R} -covered Anosov flow in a closed hyperbolic 3-manifold is not quasigeodesic [Fe1]. The reason is as follows: An \mathbb{R} -covered Anosov flow is necessarily transitive [Ba1]. Let Φ be an \mathbb{R} -covered Anosov flow in a closed hyperbolic 3-manifold. Suppose that Φ is quasigeodesic. Since Φ is transitive then the flow is uniformly quasigeodesic, meaning that the quasigeodesic constants are uniform over all orbits. For any \mathbb{R} -covered Anosov flow in a hyperbolic 3-manifold, then up to a double cover where the stable foliation is transversely orientable, the following happens: every periodic orbit is freely homotopic to infinitely many other periodic orbits [Fe1]. Coherent lifts of the freely homotopic orbits all have the same ideal points in the sphere at infinity S_∞^2 of the canonical compactification of the universal cover. The uniform quasigeodesic behavior implies that the coherent lifts of the periodic orbits are a globally bounded Hausdorff distance from each other [Th1, Th2, Gr]. Hence they accumulate in the universal cover. This is impossible for coherent lifts of freely homotopic periodic orbits.

In this article we obtain a definitive answer to the quasigeodesic question for Anosov flows in hyperbolic 3-manifolds, by proving that \mathbb{R} -covered is the only obstruction:

Main Theorem. *Let Φ be a topological Anosov flow in a closed hyperbolic 3-manifold. Suppose that Φ is not \mathbb{R} -covered. Then Φ is a quasigeodesic flow.*

Convention. Any topological Anosov flow in a hyperbolic 3-manifold is orbitally equivalent to a (smooth) Anosov flow by recent results of Shannon [Sha]. Our results and techniques are not dependent on the regularity of the flow and its foliations. Hence we will abuse terminology, and many times refer to our flows as Anosov flows, even when they may only be topological Anosov flows.

In addition the Main Theorem concerns behavior of the foliations in the universal cover, so it is unaffected by taking finite lifts. Therefore whenever necessary we assume that the manifold is orientable or the foliations are transversely orientable. But orientability is not necessary for many intermediate steps in the proof.

The Main theorem has many consequences:

Theorem 1.1. *Let M be a hyperbolic 3-manifold admitting an Anosov flow. Then up to perhaps a double cover, M admits a quasigeodesic pseudo-Anosov flow. In any case M admits a one dimensional foliation by quasigeodesics, with a dense leaf.*

Roughly this goes as follows: if the flow is not \mathbb{R} -covered we use the Main Theorem. Otherwise up to a double cover if necessary, the stable foliation is

\mathbb{R} -covered and transversely orientable. Then one can produce a quasigeodesic pseudo-Anosov flow transverse to the stable foliation [Th3, Cal1, Fe6]. We explain in detail in Section 12 that the double cover may be necessary: this happens for example for many Fried surgeries on geodesic flows of closed, non orientable hyperbolic surfaces.

Another consequence concerns the continuous extension property. Suppose a topological Anosov flow Φ in a 3-manifold M has stable leaves which are C^1 . This can always be achieved up to orbit equivalence [BFP]. The leaves of the stable foliation are Gromov hyperbolic [Pla, Sul, Gr]. Hence if F is a leaf of the stable foliation in the universal cover \widetilde{M} , then it has a canonical compactification into a closed disk $F \cup S^1(F)$. The *continuous extension property* asks whether the embedding $F \rightarrow \widetilde{M}$ extends continuously to a map $F \cup S^1(F) \rightarrow \widetilde{M} \cup \mathbb{S}_\infty^2$, see [Ga] and Question 10.2 of [Cal2]:

The continuous extension property was first proved for fibrations over the circle in the celebrated article by Cannon and Thurston [Ca-Th]. This was an unexpected and very surprising result. Since then it has been extended to some classes of foliations: finite depth foliations [Fe5], \mathbb{R} -covered foliations [Th3, Fe6], and foliations with one sided branching [Fe6]. In general it is a very hard property to prove. For Anosov foliations this question is very complex, in part because these foliations do not have compact leaves. In this article we prove:

Theorem 1.2. *Let Φ be an Anosov flow in a hyperbolic 3-manifold. Then the stable and unstable foliations of Φ have the continuous extension property.*

The non \mathbb{R} -covered case is entirely new in terms of techniques: it is the first result proving the continuous extension property, where the key tool is not a transverse or almost transverse pseudo-Anosov flow which is quasigeodesic.

The quasigeodesic property also has consequences for the computation of the Thurston norm. We refer the reader to [Mos2] for that.

Finally the main theorem implies the existence of group invariant Peano curves as follows. Given an Anosov or pseudo-Anosov flow Φ in a closed 3-manifold M , let \mathcal{O} be the orbit space of the lifted flow $\widetilde{\Phi}$ in the universal cover \widetilde{M} . This orbit space is always homeomorphic to the plane \mathbb{R}^2 [Fe1, Fe-Mo]. The orbit space has one dimensional, possibly singular foliations $\mathcal{O}^s, \mathcal{O}^u$ which are the projections to \mathcal{O} of the two dimensional stable and unstable foliations in \widetilde{M} . In [Fe6] we produce an ideal boundary $\partial\mathcal{O}$ and ideal compactification $\mathcal{O} \cup \partial\mathcal{O}$ using only the one dimensional foliations $\mathcal{O}^s, \mathcal{O}^u$. The ideal boundary is always homeomorphic to a circle and the compactification is homeomorphic to a closed disk. In addition the fundamental group $\pi_1(M)$ naturally acts on all these objects. The results of this article lead to Peano curves associated with Anosov flows:

Theorem 1.3. *Let M be a hyperbolic 3-manifold admitting an Anosov flow Φ . Then there is a group invariant Peano curve $\eta : \partial\mathcal{O} \rightarrow \mathbb{S}_\infty^2$ where $\partial\mathcal{O}$ is boundary of the orbit space \mathcal{O} of a quasigeodesic flow in either M or a double cover of M .*

The quasigeodesic flow in Theorem 1.3 is the original flow Φ in the case that Φ is quasigeodesic – that is, when Φ is not \mathbb{R} -covered; or it is a pseudo-Anosov flow which is transverse to (say) the stable foliation of either Φ in M or the lift to a double cover of M – in the case that Φ is \mathbb{R} -covered.

The first result concerning group invariant Peano curves was again proved by Cannon and Thurston in the same seminal paper [Ca-Th]. They considered fibers of fibrations, which lift to properly embedded planes in \widetilde{M} . They proved that the embeddings in \widetilde{M} extend to the ideal compactifications, and proved that the

ideal maps are group invariant Peano curves. There are results concerning Peano curves for quasigeodesic pseudo-Anosov flows in hyperbolic 3-manifolds [Fe6, Fe7]. There are similar results for general quasigeodesic flows in hyperbolic 3-manifolds [Fra1, Fra2]. Finally there are also many results on Cannon-Thurston maps from the Kleinian group setting, see for example [Mj].

Remark 1.4. To prove the Main theorem we only use that M is atoroidal. By the geometrization theorem of Perelman this implies that M is hyperbolic, but that is an extremely hard result. In this article we will invariably state results and do arguments using atoroidal as an hypothesis. By atoroidal we mean “homotopically atoroidal”, that is, there is no π_1 -injective immersion of a torus into M . There is a slight difference between homotopically atoroidal and “geometrically atoroidal” – the second condition means that there is an embedded incompressible torus in M . If M has an Anosov flow, then M is irreducible, so the difference is only for small Seifert fibered spaces. But there are small Seifert fibered spaces that admit Anosov flows. For example let S be a compact hyperbolic 2-dimensional orbifold which has a finite cover which is a surface, and S is a sphere with 3 cone points. Then $M = T^1S$ is a small Seifert fibered space and the geodesic flow of S in M is an Anosov flow. These small Seifert fibered spaces are geometrically atoroidal but not homotopically atoroidal.

1.1. Examples of \mathbb{R} -covered and non \mathbb{R} -covered Anosov flows in hyperbolic 3-manifolds. The results of this article obviously lead naturally to the question as to the existence of both of these classes and how widespread they are. It turns out that both \mathbb{R} -covered and non \mathbb{R} -covered Anosov flows are very common in hyperbolic 3-manifolds. We already mentioned the existence of infinitely many \mathbb{R} -covered examples obtained by some Dehn surgeries on closed orbits of suspensions and geodesic flows [Fe1]. On the other hand any Anosov flow in a non orientable hyperbolic 3-manifold is non \mathbb{R} -covered [Fe3] and one can obtain these by doing Dehn surgery on suspensions of orientation reversing hyperbolic diffeomorphisms of the torus.

The wealth of examples was enormously extended by a recent article of Bonatti and Iakovougλου [Bo-Ia]. We just mention some results of [Bo-Ia] that show that both classes are extremely large.

To obtain examples of non \mathbb{R} -covered Anosov flows: Theorems 2 and 3 of [Bo-Ia] state that starting with a non \mathbb{R} -covered Anosov flow and doing appropriate Fried Dehn surgeries one obtains a non \mathbb{R} -covered Anosov flow. To get examples in hyperbolic 3-manifolds, start with a non \mathbb{R} -covered Anosov flow in a hyperbolic 3-manifold. Most Dehn surgeries will produce hyperbolic 3-manifolds. Theorems 5 and 6 of [Bo-Ia] provide many more examples which are non \mathbb{R} -covered.

To obtain examples of \mathbb{R} -covered Anosov flows: Theorems 4 and 7 of [Bo-Ia] produce a wide class of \mathbb{R} -covered Anosov flows by doing Dehn surgeries on suspensions. If the surgery coefficients are big in absolute value, then the resulting manifold is hyperbolic. Corollary 4.1 and Proposition 4.1 of [Bo-Ia] produce \mathbb{R} -covered examples starting with geodesic flows.

There are many more results in [Bo-Ia] showing either the \mathbb{R} -covered behavior or the non \mathbb{R} -covered behavior for Anosov foliations in 3-manifolds.

Many other possible examples can possibly be obtained as follows: start with an example as constructed in [BBY] using hyperbolic plugs. This is an extremely general construction producing an enormous amount of Anosov flows. Do Dehn surgeries on some periodic orbits to eliminate all tori. The resulting manifold is hyperbolic, and one can possibly determine whether the resulting flow is \mathbb{R} -covered or not using the methods of [Bo-Ia].

1.2. Some ideas on the proof of the Main Theorem. We will prove the contrapositive of the statement of the Main theorem. As a starting point of the analysis we use the following result: It was proved in [Fe7] that a topological Anosov flow Φ (even a pseudo-Anosov flow) in a hyperbolic 3-manifold is quasigeodesic if and only if there is a global bound K , so that any set of pairwise freely homotopic periodic orbits of Φ has cardinality bounded above by K . The strategy of the proof of our Main theorem is to assume that Φ is not quasigeodesic, hence this boundedness condition fails. We then prove that this implies that Φ is \mathbb{R} -covered.

In very rough terms what we will do is the following: assume that the flow is not quasigeodesic. Then we will produce an appropriate essential lamination in M which will imply that the flow is \mathbb{R} -covered.

To do that we will employ a standard form for the flow as follows. Using results of Candel [Cand] it was proved previously in [BFP] that Φ is orbitally equivalent to a topological Anosov flow so that the stable leaves are C^1 with a leafwise Riemannian metric making every leaf a hyperbolic surface (meaning gaussian curvature constant and equal to -1). In addition the flow lines are geodesics in the stable leaves.

By assumption we have arbitrarily big sets of pairwise freely homotopic periodic orbits. We realize the free homotopies between the periodic orbits so that intersections with stable leaves are geodesics in the respective leaves. These are immersed annuli in M . These immersed annuli are chosen so that they are uniquely determined by the periodic orbits. If there are more orbits freely homotopic to a given orbit then the annuli can be put together forming bigger annuli. In other words one can concatenate the free homotopies in a nice way. We take limits of these big annuli when the number of freely homotopic orbits goes to infinity. We can take limits and they are well behaved in part because of the canonical form of the free homotopy annuli: the stable leaves are hyperbolic surfaces and the intersections of the annuli with these stable leaves are geodesics in the leaves. This is one main reason for the setup with the metric on the stable leaves and the flow lines geodesics in these stable leaves. Even with this setup it is very difficult to understand the limits. We will explain more in Subsection 3.3 once we have defined lozenges and other objects associated with free homotopies. The limits of the bigger and bigger free homotopy annuli, when lifted to the universal cover, are what we call *walls*. The walls are properly embedded planes in the universal cover, and intersect an \mathbb{R} worth set of stable leaves. The goal is to prove that this is the set of all stable leaves in \widetilde{M} , and hence Φ is \mathbb{R} -covered. To do that we study properties of these walls and certain subsets of the orbit space in \widetilde{M} , called *bi-infinite blocks*, associated with the walls. A lot of the analysis is done without assuming that M is atoroidal. But the atoroidal hypothesis is used in many places to obtain stronger results.

One goal is to understand the projection of the walls in M . There are two main cases: either the projection of a wall does not self intersect transversely or it does. In the first case one shows, in the case that M is atoroidal, that the projection of a wall to M has closure which is a lamination – in other words any tangent intersection of two walls leads to equality of these walls. This last fact in general holds only when M is atoroidal. We study the complementary regions of this lamination and eventually prove that Φ is \mathbb{R} -covered. In the second case there are transverse self intersections when projecting to M . We then study a type of “convex hull” in \widetilde{M} associated with such a wall. This convex hull is obtained using the hyperbolic metric in the stable leaves and using that walls intersect

such leaves in geodesics. There are two subcases: if the convex hull is all of \widetilde{M} , then the \mathbb{R} -covered property follows. Otherwise we do a very careful analysis of the boundary components of the convex hull. Using this analysis we are then able to produce walls without transverse self intersections when projected to M , and the proof reduces to the first case.

Remark 1.5. As explained in the beginning of this description the lack of quasi-geodesic behavior is equivalent to a property involving the number of freely homotopic periodic orbits, and that is what we analyze in this article. In particular we stress that the arguments in this article never analyze the quasigeodesic property for flow lines directly. As explained in the description above, we will analyze freely homotopic periodic orbits and sets in M or \widetilde{M} which are generated by them, which will eventually connect with the \mathbb{R} -covered property. On the other hand, it is true that geometric properties of flow lines are used in several places: for example a global bound of the Hausdorff distance between corner orbits of lozenges, also a global bound of the Hausdorff distance between boundary orbits of bands (lozenges and bands to be defined later). These properties are true for any Anosov flow in a 3-manifold, and not just in hyperbolic manifolds.

We remark again that we will provide more details about the proof of the Main Theorem in Subsection 3.3 after we have defined certain terms used in the proof, such as for example perfect fits and lozenges.

1.3. Brief description of sections. The next section describes the main objects and properties of topological Anosov flows. The Main Theorem is proved in Sections 3 to 10. Section 3 analyzes bands and limits of lozenges and bands. Section 4 describes walls associated with the limits of bands. The case with a wall with no transverse self intersections when projected to M is worked out in Sections 5 and 6. The case where all walls self intersect transversely when projected to M is worked out in Sections 7 to 10. Many examples of walls are described in detail in Section 11. Theorem 1.1, concerning production of quasigeodesic flows, is proved in Section 12. Theorem 1.2, which proves the continuous extension for Anosov foliations, is proved in Section 13. Theorem 1.3, which produces group invariant Peano curves, is proved in Section 14. The final section, Section 15 explains some open questions in the subject.

1.4. Acknowledgements — We thank Rafael Potrie for many suggestions to a preliminary version of this article. We thank Thomas Barthelme who suggested Theorem 1.1 to us.

2. BACKGROUND ON TOPOLOGICAL ANOSOV FLOWS

The manifold M is equipped with a Riemannian metric. For definitions and fundamental properties and results on Anosov flows we refer to [An, Ka-Ha]. In this article we will consider a generalization of this:

Definition 2.1. (topological Anosov flow) Let Φ be a flow on a closed 3-manifold M . We say that Φ is a *topological Anosov flow* if the following conditions are satisfied:

- For each $x \in M$, the flow line $t \rightarrow \Phi(x, t)$ is C^1 , and it is not a single point. The tangent vector bundle $D_t\Phi$ is C^0 in M .

- There are two transverse topological foliations Λ^s, Λ^u which are two dimensional, with leaves saturated by the flow and so that Λ^s, Λ^u intersect exactly along the flow lines of Φ . These are called the stable (Λ^s) and the unstable (Λ^u) foliation of the flow Φ .

- In a stable leaf all orbits are forward asymptotic, but no two distinct orbits are backwards asymptotic. Conversely in an unstable leaf all orbits are backwards asymptotic and no two distinct orbits are forward asymptotic.

We remark that a priori there are no stable and unstable one dimensional bundles associated with a topological Anosov flow [BFP]. Hence, in general there are no one dimensional strong stable and strong unstable foliations. We only have the two dimensional stable and unstable foliations Λ^s, Λ^u .

As mentioned in the introduction, if M is atoroidal, then Φ is orbitally equivalent to an Anosov flow [Sha]. For this reason we will abuse notation and many times refer to our flows as Anosov flows. The arguments in this article only use the topological Anosov flow behavior.

Notation/definition: We denote by $\pi : \widetilde{M} \rightarrow M$ the universal covering of M , and by $\pi_1(M)$ the fundamental group of M , considered as the group of deck transformations on \widetilde{M} . The lifted foliations to \widetilde{M} are denoted by $\widetilde{\Lambda}^s, \widetilde{\Lambda}^u$. If $x \in M$ let $\Lambda^s(x)$ denote the leaf of Λ^s containing x . Similarly one defines $\Lambda^u(x)$ and in the universal cover $\widetilde{\Lambda}^s(x), \widetilde{\Lambda}^u(x)$. If α is an orbit of Φ , similarly define $\Lambda^s(\alpha), \Lambda^u(\alpha)$, etc... Let also $\widetilde{\Phi}$ be the lifted flow to \widetilde{M} .

The deck transformations will also be called covering translations.

We review the results about the topology of $\widetilde{\Lambda}^s, \widetilde{\Lambda}^u$ that we will need. We refer to [Fe3, Fe4] for more details and proofs. We note that in [Fe4] the definitions and results are stated for the more general situation of pseudo-Anosov flows, which imply the statements here. In a pseudo-Anosov flow one allows finitely many p -prong orbits, with $p \geq 3$. The orbit space of $\widetilde{\Phi}$ in \widetilde{M} is homeomorphic to the plane [Fe1, Fe4]. The orbit space is denoted by \mathcal{O} which is the quotient space $\widetilde{M}/\widetilde{\Phi}$. There is an induced action of $\pi_1(M)$ on \mathcal{O} . Let

$$\Theta : \widetilde{M} \rightarrow \mathcal{O} \cong \mathbb{R}^2$$

be the projection map. It is naturally $\pi_1(M)$ equivariant. If L is a leaf of $\widetilde{\Lambda}^s$ or $\widetilde{\Lambda}^u$, then $\Theta(L) \subset \mathcal{O}$ is homeomorphic to \mathbb{R} . The foliations $\widetilde{\Lambda}^s, \widetilde{\Lambda}^u$ induce $\pi_1(M)$ invariant 1-dimensional foliations $\mathcal{O}^s, \mathcal{O}^u$ in \mathcal{O} . If x is a point of \mathcal{O} , then $\mathcal{O}^s(x)$ (resp. $\mathcal{O}^u(x)$) is the leaf of \mathcal{O}^s (resp. \mathcal{O}^u) containing x .

Definition 2.2. Let L be a leaf of $\widetilde{\Lambda}^s$ or $\widetilde{\Lambda}^u$. If ζ is a ray in $\Theta(L)$ then $A = \Theta^{-1}(\zeta)$ is called a half leaf of L . If ζ is an open segment in $\Theta(L)$ with compact closure, it defines a flow band L_1 of L by $L_1 = \Theta^{-1}(\zeta)$.

We abuse convention and call a leaf L of $\widetilde{\Lambda}^s$ or $\widetilde{\Lambda}^u$ *periodic* if there is a non trivial covering translation g of \widetilde{M} with $g(L) = L$. Equivalently $\pi(L)$ contains a periodic orbit of Φ . In the same way an orbit γ of $\widetilde{\Phi}$ is *periodic* if $\pi(\gamma)$ is a periodic orbit of Φ . Observe that in general the stabilizer of an element α of \mathcal{O} is either trivial, or an infinite cyclic subgroup of $\pi_1(M)$.

If $F \in \widetilde{\Lambda}^s$ and $G \in \widetilde{\Lambda}^u$ then F and G intersect in at most one orbit. Also suppose that a leaf $F \in \widetilde{\Lambda}^s$ intersects two leaves $G, H \in \widetilde{\Lambda}^u$ and so does $L \in \widetilde{\Lambda}^s$. Then F, L, G, H form a *rectangle* in \widetilde{M} .

The following two generalizations of rectangles will be extremely important in this article: 1) perfect fits = the projection in the orbit space is a properly embedded rectangle with one corner removed; and 2) lozenges = the projection in \mathcal{O} is a rectangle with two opposite corners removed.

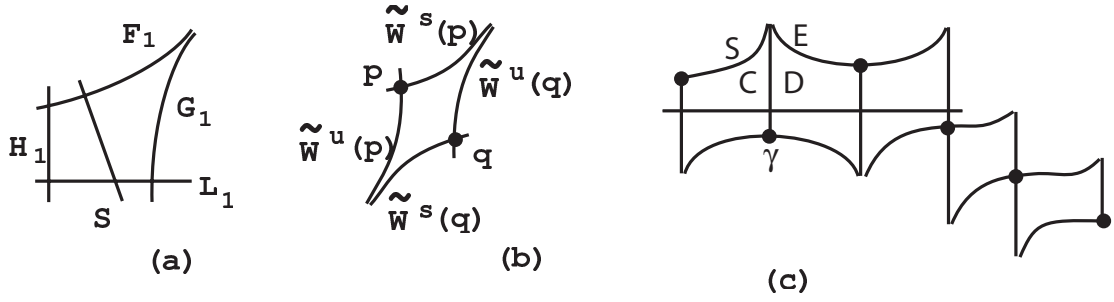

FIGURE 1. a. A perfect fit. The half leaves F_1, G_1 of F, G depict the perfect fit between F, G . Here F_1, G_1 do not intersect, but any S intersecting L between G and H intersects F_1 ; b. A lozenge. p, q are the corners of the lozenge; c. A chain of lozenges.

Definition 2.3. ([Fe2, Fe3, Fe4]) Perfect fits - Two leaves $F \in \tilde{\Lambda}^s$ and $G \in \tilde{\Lambda}^u$, form a perfect fit if $F \cap G = \emptyset$ and there are half leaves F_1 of F and G_1 of G and also flow bands $L_1 \subset L \in \tilde{\Lambda}^s$ and $H_1 \subset H \in \tilde{\Lambda}^u$, so that the set

$$\overline{F_1} \cup \overline{H_1} \cup \overline{L_1} \cup \overline{G_1}$$

separates M and forms an a rectangle R with a corner removed: The joint structure of $\tilde{\Lambda}^s, \tilde{\Lambda}^u$ in R is that of a rectangle as above without one corner orbit. The removed corner corresponds to the perfect fit of F and G which do not intersect.

We refer to Figure 1, a for perfect fits. There is a product structure in the interior of R : there are two stable boundary sides and two unstable boundary sides in R . An unstable leaf intersects one stable boundary side (not in the corner) if and only if it intersects the other stable boundary side (not in the corner).

Definition 2.4. ([Fe3, Fe4]) Lozenges - A lozenge is a region of \tilde{M} whose closure is homeomorphic to a rectangle with two corners removed. More specifically two points p, q define the corners of a lozenge if there are half leaves A, B of $\tilde{\Lambda}^s(p), \tilde{\Lambda}^u(p)$ defined by p and C, D half leaves of $\tilde{\Lambda}^s(q), \tilde{\Lambda}^u(q)$ so that A and D form a perfect fit and so do B and C . The sides of R are A, B, C, D . The sides are not contained in the lozenge, but are in the boundary of the lozenge. See Figure 1, b.

This is definition 4.4 of [Fe4]. Two lozenges are *adjacent* if they share a corner and there is a stable or unstable leaf intersecting both of the lozenges, see Figure 1, c. Therefore they share a side. A *chain of lozenges* is a collection $\{\mathcal{C}_i\}, i \in I$, of lozenges where I is an interval (finite or not) in \mathbf{Z} , so that if $i, i+1 \in I$, then \mathcal{C}_i and \mathcal{C}_{i+1} share a corner, see Figure 1, c. Consecutive lozenges may be adjacent or not. The chain is finite if I is finite. A chain \mathcal{C} is a *string of lozenges* if no two consecutive lozenges are adjacent. The chain depicted in (c) of Figure 1 is not a string of lozenges. But the subchain of the right 3 lozenges in this figure is a string of lozenges.

Important convention – We also use the terms half leaves, perfect fits, lozenges and rectangles for the projections of these objects in \tilde{M} to the orbit space \mathcal{O} .

Definition 2.5. Suppose A is a flow band in a leaf of $\tilde{\Lambda}^s$. Suppose that for each orbit γ of $\tilde{\Phi}$ in A there is a half leaf B_γ of $\tilde{\Lambda}^u(\gamma)$ with boundary γ so that: for any two orbits γ, β in A then a stable leaf intersects B_β if and only if it intersects

B_γ . This defines a stable product region which is the union of the B_γ . Similarly define unstable product regions.

It follows that B_γ varies continuously with γ ([Fe4] page 641).

Theorem 2.6. ([Fe4], Theorem 4.10) *Let Φ be a topological Anosov flow. Suppose that there is a stable or unstable product region. Then Φ is topologically conjugate to a suspension Anosov flow.*

We say that two orbits γ, α of $\tilde{\Phi}$ (or the leaves $\tilde{\Lambda}^s(\gamma), \tilde{\Lambda}^s(\alpha)$) are connected by a chain of lozenges $\{\mathcal{C}_i\}, 1 \leq i \leq n$, if γ is a corner of \mathcal{C}_1 and α is a corner of \mathcal{C}_n . If a lozenge \mathcal{C} has corners β, γ and if g in $\pi_1(M) - \{id\}$ satisfies $g(\beta) = \beta, g(\gamma) = \gamma$ (and so $g(\mathcal{C}) = \mathcal{C}$), then $\pi(\beta), \pi(\gamma)$ are closed orbits of Φ which are freely homotopic to the inverse of each other.

Theorem 2.7. ([Fe4], Theorem 4.8) *Let Φ be a topological Anosov flow in M closed and let $F_0 \neq F_1 \in \tilde{\Lambda}^s$. Suppose that there is a non trivial covering translation g with $g(F_i) = F_i, i = 0, 1$. Let $\alpha_i, i = 0, 1$ be the periodic orbits of $\tilde{\Phi}$ in F_i so that $g(\alpha_i) = \alpha_i$. Then α_0 and α_1 are connected by a finite chain of lozenges $\{\mathcal{C}_i\}, 1 \leq i \leq n$ and g leaves invariant each lozenge \mathcal{C}_i as well as their corners.*

This means that each free homotopy of closed orbits generates a chain of lozenges preserved by a non trivial element g of $\pi_1(M)$.

The Main Theorem concerns the leaf space of Λ^s, Λ^u . If this leaf space is Hausdorff, then it is homeomorphic to \mathbb{R} [Fe1]. Suppose that the leaf space of $\tilde{\Lambda}^s$ (or $\tilde{\Lambda}^u$) is not Hausdorff. Two points of this space are non separated if they do not have disjoint neighborhoods in the respective leaf space. For the Main Theorem it is very important to understand the structure of non separated leaves. Here is one example: suppose that C, D are adjacent lozenges intersecting a common stable leaf. A possible depiction of this is in Figure 1 (c), the first two lozenges on the left part of the figure. The lozenges share a corner γ and the stable leaf $\tilde{\Lambda}^s(\gamma)$ is entirely contained in the boundary of $C \cup D$. There are two other stable leaves S, E which have half leaves in the boundary of C and D respectively. By the definition of lozenges, it follows that S, E are distinct, but they are non separated from each other.

As it turns out the structure of non separated leaves in general is very similar to the above, and it exhibits a rigid behavior. The main result concerning non Hausdorff behavior in the leaf spaces of $\tilde{\Lambda}^s, \tilde{\Lambda}^u$ is the following:

Theorem 2.8. ([Fe4], Theorem 4.9) *Let Φ be a topological Anosov flow in M^3 . Suppose that $F \neq L$ are not separated in the leaf space of $\tilde{\Lambda}^s$. Let V_0 be the component of $\tilde{M} - F$ containing L . The following happens:*

- F and L are periodic.
- Let α be the periodic orbit in F and β the periodic orbit in L . H_0 be the component of $(\tilde{\Lambda}^u(\alpha) - \alpha)$ contained in V_0 .
- Let g be a non trivial covering translation with $g(H_0) = H_0$, and g leaves invariant the components of $(F - \alpha)$. Then $g(L) = L$.
- This produces periodic orbits $\pi(\alpha), \pi(\beta)$ of Φ which are freely homotopic in M .
- Theorem 2.7 then implies that α and β are connected by a finite chain of lozenges $\{A_i\}, 1 \leq i \leq n$, where consecutive lozenges are adjacent and all intersect a common stable leaf E .
- There is an even number of lozenges in the chain, see Figure 2.

- In addition let $\mathcal{B}_{F,L}$ be the set of leaves of $\tilde{\Lambda}^s$ non separated from F and L . Put an order in $\mathcal{B}_{F,L}$ as follows: The set of orbits of E contained in the union of the lozenges and their sides is an interval. Put an order in this interval. If $R_1, R_2 \in \mathcal{B}_{F,L}$ let α_1, α_2 be the respective periodic orbits in R_1, R_2 . Then $\tilde{\Lambda}^u(\alpha_i) \cap E \neq \emptyset$ and let $a_i = \tilde{\Lambda}^u(\alpha_i) \cap C$. We define $R_1 < R_2$ in $\mathcal{B}_{F,L}$ if a_1 precedes a_2 in the order of the set of orbits of C .
- Then $\mathcal{B}_{F,L}$ with this order, is either order isomorphic to $\{1, \dots, n\}$ for some $n \in \mathbf{N}$; or $\mathcal{B}_{F,L}$ is order isomorphic to the integers \mathbf{Z} .
- In addition if there are $Z, S \in \tilde{\Lambda}^s$ so that $\mathcal{B}_{Z,S}$ is infinite, then there is an incompressible torus in M transverse to Φ . In particular M cannot be atoroidal.
- Also if there are F, L distinct leaves of $\tilde{\Lambda}^s$ non separated from each other as above, then there are periodic orbits τ, η of Φ which are freely homotopic to the inverse of each other.
- Finally up to covering translations, there are only finitely many non Hausdorff points in the leaf space of $\tilde{\Lambda}^s$.

The same happens for Λ^u .

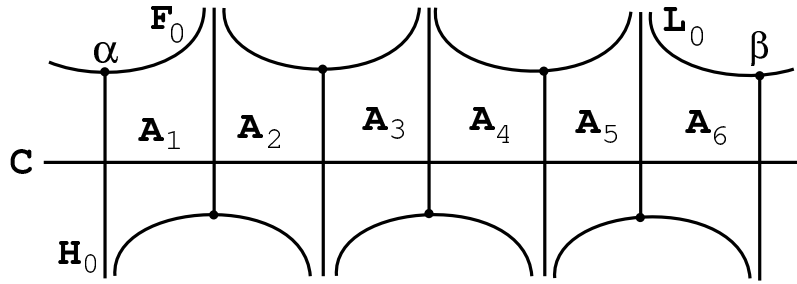

FIGURE 2. A chain of adjacent lozenges $\{A_i, 1 \leq i \leq n\}$ connecting non separated leaves F, L in $\tilde{\Lambda}^s$. Here F_0 is a half leaf of F contained in the boundary of A_1 and similarly G_0 is a half leaf of H contained in the boundary of A_6 .

Notice that $\mathcal{B}_{F,L}$ is a discrete set in this order. For detailed explanations and proofs, see [Fe3, Fe4].

Definition 2.9. A product open set is an open set Y in \tilde{M} or \mathcal{O} so that the induced stable and unstable foliations in Y satisfy the following: every stable leaf intersects every unstable leaf.

For example, if stable leaves A, B both intersect unstable leaves C, D , then the four of them bound a compact rectangle whose interior is a product open set. In our explorations we will also consider the closure of the open product set (in \tilde{M} or \mathcal{O}) which is the open set union its boundary components.

We stress that product open sets and product regions in general are not the same, and the second class is a subset of the first. Any pseudo-Anosov flow has product open sets, but only suspensions have product regions.

We finish this section with 3 more technical results, which are from [Fe7].

Proposition 2.10. (Proposition 4.6 of [Fe7] - periodic double perfect fits) Suppose that two disjoint half leaves of a leaf S of $\tilde{\Lambda}^s$ (or $\tilde{\Lambda}^u$) make a perfect fit respectively with A, B which are leaves of $\tilde{\Lambda}^u$ (or $\tilde{\Lambda}^s$). Suppose that A, B are in

the same complementary component of $\widetilde{M} - S$. Then A, B and S are all periodic and left invariant by the same non trivial covering translation ζ .

Lemma 2.11. (Lemma 4.5 of [Fe7]) *Let Φ be an Anosov flow with an upper bound on the cardinality of sets of pairwise non separated stable leaves in \widetilde{M} . Then there are no product open sets with a single corner or no corner.*

Remark 2.12. If there is no bound as above, it follows that there is a stable leaf in \widetilde{M} which is not separated from infinitely many stable leaves. Then there is what is called a *scalloped region* in \widetilde{M} and an immersed torus transverse to the flow [Fe4]. When M is atoroidal this does not happen.

Theorem 2.13. (Theorem 5.2 of [Fe7]) *Let Φ be an Anosov flow. There is a constant a_0 depending only on the geometry of M and the flow Φ , so that if α, β are corner orbits of a lozenge C in \widetilde{M} , then α, β are a bounded Hausdorff distance from each other: $d_H(\alpha, \beta) < a_0$, where d_H is the Hausdorff distance in \widetilde{M} .*

3. LIMITS OF LOZENGES AND CANONICAL BANDS

The proof of the Main Theorem will involve the analysis of limits of free homotopies between periodic orbits. By Theorem 2.7, any free homotopy between periodic orbits is represented by a chain of lozenges. Therefore we will need to understand limits of lozenges and limits of chains of lozenges. This is the goal of this section. When one takes limits of the chains of lozenges we will obtain what we call blocks and bi-infinite blocks. Also associated with the lozenges there will be geometric sets in \widetilde{M} which are called bands, and the limits of the geometric sets associated with chains of lozenges will be called walls. This analysis will involve a type of product open sets called ideal quadrilaterals.

Definition 3.1. An (i, j) ideal quadrilateral in \widetilde{M} or \mathcal{O} is a product open set Q satisfying the following conditions. Here $i + j = 4$. The boundary of Q is made up of 4 pieces $S_k, 1 \leq k \leq 4$ which are either leaves, half leaves or flow bands alternatively in leaves of $\widetilde{\Lambda}^s, \widetilde{\Lambda}^u$ so that either $S_k, S_{k+1}(\text{mod } 4)$ intersect in a corner of Q or make a perfect fit. These pieces in the boundary are called the sides of Q .

We will call a side of Q compact if its projection to \mathcal{O} is compact.

We describe the possibilities. First of all a $(0, 4)$ ideal quadrilateral is an actual quadrilateral or a rectangle in the orbit space. In Proposition 4.4 of [Fe7] we proved that there are no $(4, 0)$ or $(3, 1)$ ideal quadrilaterals. The $(1, 3)$ ideal quadrilaterals will be a crucial ingredient in this article. Whenever two leaves make a perfect fit one can produce infinitely many such $(1, 3)$ ideal quadrilaterals, by direct checking of the definition of perfect fits. As for $(2, 2)$ ideal quadrilaterals there are two possibilities: the first is that there is no full leaf of $\widetilde{\Lambda}^s$ or $\widetilde{\Lambda}^u$ which is a side of Q , in which case Q is a lozenge. Equivalently the corners alternate with the perfect fits. The other option is that there is a full leaf, say S_1 contained in ∂Q . In this case this full leaf S_1 makes a perfect fit with S_2 and S_4 . This can be obtained as the union of two $(1, 3)$ quadrilaterals, so that two compact sides are glued together.

Notice that there are other types of product open sets which are not ideal quadrilaterals: one is depicted in Figure 2, the union \mathcal{D} of the lozenges $A_i, 1 \leq i \leq 6$, plus the half leaves contained in the boundary of both A_i and A_{i+1} . In this example the product open set \mathcal{D} has two unstable half leaves (subsets of $\widetilde{\Lambda}^u(\alpha), \widetilde{\Lambda}^u(\beta)$) contained in the boundary. The boundary also contains 3 stable

leaves non separated from each other, one of which makes a perfect fit with $\tilde{\Lambda}^u(\alpha)$, as well as parts of other 4 stable leaves: F_0, L_0 and two other stable leaves between F, L .

Two ideal quadrilaterals Q_1, Q_2 are said to be *adjacent* if there a side S_1 of Q_1 and a side S_2 of Q_2 which are the same set in \tilde{M} . In particular if S_1 is either a flow band or a half leaf, then Q_1, Q_2 share a corner.

3.1. Blocks. In previous works [Fe4, Fe5, Fe7] we considered chains of lozenges. Here we have to consider a more general object which also allows for (1, 3) ideal quadrilaterals.

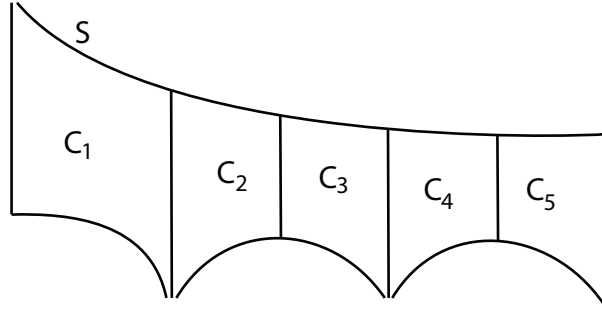

FIGURE 3. A finite block. Assuming that S is a stable leaf, then this is a stable adjacent block. It has 5 elements, C_1, \dots, C_5 . The element C_1 is a lozenge, and C_2 through C_5 are (1, 3) ideal quadrilaterals.

Definition 3.2. (block, adjacent block, odd block) A block is a finite or infinite collection indexed by a connected set in \mathbb{Z} . The elements of the collection are either lozenges or (1, 3) ideal quadrilaterals. Consecutive elements share a corner. If the consecutive elements have sides whose interiors intersect, then the respective sides are the same set in \tilde{M} , that is the two ideal quadrilaterals are adjacent. The block is called adjacent if there is a stable or unstable leaf which intersects all of the elements. If there is a stable leaf intersecting all elements then the block is called a stable adjacent block, and similarly in the unstable case. The block is called odd if there is a finite, odd number of elements in it.

Figure 3 shows a simple of a finite adjacent block. Figure 4 shows a more involved example of a finite block, which is made up of the union of a stable adjacent block and an unstable adjacent block, both of which have more than one element.

Convention – Throughout the article we assume the following convention: Suppose that \mathcal{C} is a block. When we talk about the set of stable leaves which intersect \mathcal{C} we also include a leaf E of $\tilde{\Lambda}^s$ so that there are consecutive elements C_i, C_{i+1} in \mathcal{C} so that E contains a side of C_i and a side of C_{i+1} and E separates C_i from C_{i+1} . Notice that the elements C_i, C_{i+1} may be adjacent along E or not. Equivalently we could say that this set is the smallest connected set in the leaf space of $\tilde{\Lambda}^s$ which contains all leaves intersecting an element of \mathcal{C} . Similarly for the unstable foliation.

3.2. Good form of the flow Φ . In [BFP] it is proved that Φ is orbitally equivalent to a topological Anosov flow Ψ satisfying the following:

- The weak stable foliation of Ψ has smooth leaves.

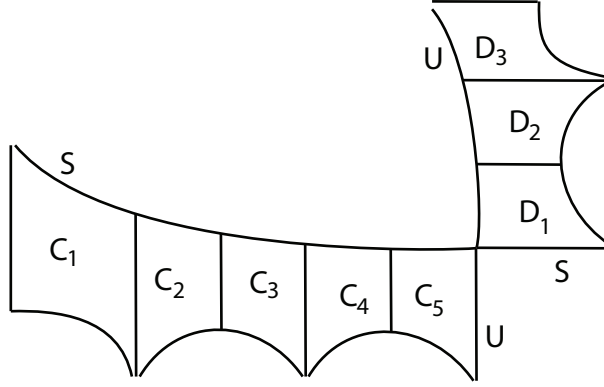

FIGURE 4. A more involved finite block. We assume that S is a stable leaf and U is an unstable leaf. The block is made up of 8 elements C_1, \dots, C_5 and D_1, D_2, D_3 . The C 's form a stable adjacent block with one lozenge and 4 (1, 3) ideal quadrilaterals. The D 's form an unstable adjacent block, with one lozenge D_3 and two (1, 3) ideal quadrilaterals, D_1, D_2 .

- There is a leafwise Riemannian metric g in the tangent space of the weak stable foliation Λ_Ψ^s of Ψ , such that the leaves of Λ_Ψ^s are hyperbolic surfaces with the metric g .
- The flow lines of Ψ are geodesics in the respective leaves of Λ_Ψ^s with the hyperbolic metrics given by g_1 .

This is Corollary 5.23 of [BFP]. Its construction uses ideas of [Cal3], see also [Cal4]. We briefly describe it. First using Candel's theorem [Cand] put a metric in M which is leafwise hyperbolic. In Proposition 5.14 of [BFP] it is proved that the flow lines of $\tilde{\Phi}$ are uniform quasigeodesics in leaves of $\tilde{\Lambda}^s$ (of the flow $\tilde{\Phi}$). This implies [Fe1] that for each leaf E of $\tilde{\Lambda}^s$ the ideal points of $S^1(E)$ are described as follows: let y be the common forward ideal point of all flow lines in E . For any other point x in $S^1(E)$ there is a unique flow line in E with negative ideal point x . Form a new flow as follows: consider all the geodesics in E with ideal point y . Consider the flow with flow lines these geodesics, moving at speed 1 towards y . Do this for all leaves E of $\tilde{\Lambda}^s$. This induces a continuous flow Ψ in \tilde{M} which is $\pi_1(M)$ invariant, inducing a flow in M . The orbit spaces of Φ and Ψ are $\pi_1(M)$ equivariantly homeomorphic. This implies that Ψ is orbitally equivalent to Φ , in particular Ψ is also a topological Anosov flow. In this article we will prove the result for Ψ , which implies the result for Φ as well. So we can start with Ψ instead of Φ .

Conclusion – We will assume that Λ^s is a foliation by hyperbolic leaves, and the flow lines of Φ are geodesics in the respective leaves of Λ^s .

Convention – Throughout this article we will work with bands and walls (see later for definitions of these objects) transverse to the stable foliation $\tilde{\Lambda}^s$, starting with a metric in M so that in each leaf of Λ^s the metric is a hyperbolic metric. Conversely we could have considered the unstable foliation throughout.

3.3. More information about the proof of the Main theorem. To prove the Main theorem, we consider bigger and bigger sets of freely homotopic periodic orbits. By Theorem 2.7, this leads to longer and longer chains of lozenges. If

M is atoroidal we can extract big subchains which are strings of lozenges. As explained in the introduction, in Subsection 1.2, we take limits of the annuli associated with the big sets of freely homotopic periodic orbits. It is very hard to understand the limits of these by themselves, and we use the associated strings of lozenges to understand this.

One basic question here is: what is the limit of a sequence of lozenges? Clearly one possibility is that a sequence of lozenges can limit to a lozenge. But it is very easy to see that another possibility is that the sequence of lozenges can converge to an adjacent chain of lozenges. We prove in Proposition 3.5 that there is only one additional possibility for the limit: an adjacent block. Recall from Subsection 1.2 that we will use walls obtained as limits of lifts of annuli associated with big strings of lozenges. Hence a wall is associated with what is called a *bi-infinite block*. The goal of this section is to understand limits of lozenges and some properties of blocks.

To proceed with the proof of the Main Theorem, we will need to understand transverse and tangential intersections of walls. We use the bi-infinite blocks to understand that. In particular in the case of M atoroidal this can be used to show that a tangent intersection between a wall L and a translate $\gamma(L)$ implies that they are exactly the same set. In the case of a transverse intersection we will prove a linking property, which implies both L and $\gamma(L)$ intersect exactly the same set of stable leaves in \widetilde{M} . All of these properties are very hard to understand and prove using only the walls themselves. The lozenges and bi-infinite blocks make this study possible.

Then as explained in Subsection 1.2: in the case no transverse intersections between walls, we produce a lamination in M coming from walls, and eventually show that Φ is \mathbb{R} -covered. In the case of transverse intersections, we produce a “convex hull” associated with walls, which also proves the \mathbb{R} -covered property.

3.4. Bands. We now describe one of the fundamental objects we will use in this article. Eventually we will go from large sets of freely homotopic periodic orbits to walls in \widetilde{M} by a limiting process.

Bands associated with lozenges

Let C be a lozenge in \widetilde{M} . We build a canonical set which we will call a *band* associated with it. Let α, β be the corners orbits of C . We construct the band (or canonical band) B associated with C as follows: the boundary of B is the union of the orbits α, β . For any stable leaf E intersecting C , let $\alpha_E = \widetilde{\Lambda}^u(\alpha) \cap E$ and $\beta_E = \widetilde{\Lambda}^u(\beta) \cap E$. These are two orbits in E , hence two geodesics in E . Let ℓ_E be the geodesic in E with ideal points which are the different negative ideal points of α_E, β_E in $S^1(E)$. Notice that ℓ_E is everywhere transverse to the flow $\widetilde{\Phi}$ restricted to E . The band B is:

$$B = \alpha \cup \beta \cup \{\ell_E, \text{ for } E \cap C \neq \emptyset\}$$

Notice that the band B is a subset of \widetilde{M} . The band B comes equipped with a one dimensional foliation which is made up of intersections with leaves of $\widetilde{\Lambda}^s$, each leaf of this foliation is a geodesic in the corresponding leaf of $\widetilde{\Lambda}^s$. We parametrize the leaves as $\ell_t, 0 \leq t \leq 1$ where (say) $\ell_0 = \alpha, \ell_1 = \beta$. Let E_t be the leaf of $\widetilde{\Lambda}^s$ containing ℓ_t .

We stress that a band denotes an object that is very different from a flow band: a flow band is a bounded interval of flow lines in either a stable or unstable leaf.

By definition a band is a union of geodesics in different stable leaves, most of which are transverse to the flow lines and the boundary ones are tangent to flow lines.

We will later define a wall, which will be a union of bands, so that consecutive bands share a boundary component. By *infinite strip* we mean the set $[0, 1] \times \mathbb{R}$ with the induced topology from inclusion in \mathbb{R}^2 .

Lemma 3.3. *The band B is the image of a continuous embedding of an infinite strip into \widetilde{M} . In addition B is a closed subset of \widetilde{M} .*

Proof. Let $U = \widetilde{\Lambda}^u(\beta), V = \widetilde{\Lambda}^u(\alpha)$. First we show continuous change of the curves ℓ_t when t is in $(0, 1)$. For any $t, \in (0, 1)$ the curve ℓ_t is a geodesic in E_t , with ideal points the ideal points of $U \cap E_t$ and $V \cap E_t$. Let r_t be a ray in ℓ_t with ideal point the ideal point of $U \cap E_t$ and v_t the complementary ray. We choose the starting points of r_t varying continuously with t and the rays r_t in coherent directions. In an unstable leaf, the flow lines are backwards asymptotic, hence $r_t, r_{t'}$ are asymptotic for any $t, t' \in (0, 1)$. In the same way $v_t, v_{t'}$ are also asymptotic. Since the hyperbolic metrics in leaves of $\widetilde{\Lambda}^s$ vary continuously, this shows continuity of the curves ℓ_t with t for t in $(0, 1)$.

Notice that $B \cap E_1 = U \cap E_1$.

To get the continuity at say $t = 1$ we consider a point p in $B \cap E_1$ and a transversal τ to $\widetilde{\Lambda}^s$ starting at p and intersecting E_t for t close to 1, say $t > t_0$. Then consider the trivialization of $R = \cup\{S^1(E_t), t_0 \leq t \leq 1\}$ using the unit tangent bundle to $\widetilde{\Lambda}^s$ restricted to τ . The geodesic $U \cap E_t$ has ideal points x_t, y_t in $S^1(E_t)$, with x_t corresponding to the negative ideal point. The geodesics ℓ_t have one ideal point x_t which clearly converges to x_1 as $t \rightarrow 1$ in the local trivialization. The other endpoint of ℓ_t in $S^1(E_t)$ is the negative ideal point of $V \cap E_t$ for $0 < t < 1$. The geodesics $V \cap E_t$ have one ideal point which is the forward ideal point of all flow lines of E_t , hence this is the same as the forward ideal point of $U \cap E_t$, that is it is y_t . Let z_t be the other ideal point of $V \cap E_t$. Since the flow lines $U \cap E_t$ converge to $U \cap E_1$ as $t \rightarrow 1$, it follows that y_t converges to y_1 in the local trivialization. If the other ideal point z_t of $V \cap E_t$ does not converge to y_1 in the local trivialization of R , it follows that there is a subsequence z_{t_k} converging converge to a point $w \neq y_1$ in $S^1(E_1)$. We first rule out $w = x_1$: if that were the case then the flow lines in E_t with negative ideal point z_{t_k} converge to β . But since these flow lines are in V this would imply V intersects U , contradiction. Hence the intersections $V \cap E_{t_k}$ converge to a geodesic in E_1 . Since V is properly embedded the limit is in V . In other words V intersects E_1 . But this is impossible, since V, E_1 make a perfect fit. Hence the ideal points z_t converge to y_1 .

This shows that ℓ_t (with ideal points x_t, z_t) converges to ℓ_1 (with ideal points x_1, y_1) as $t \rightarrow 1$ in the local trivialization of R .

Now we will analyze the closed property for B . Since ℓ_t varies continuously we orient them coherently as follows. We orient the curves ℓ_t in a continuous manner and so that for $t = 1$ the orientation is the positive flow direction in $\ell_1 = \beta$. With this choice, for any $0 < t < 1$, it follows that any negative ray of ℓ_t is asymptotic to a backwards ray (with respect to the flow) of $\ell_1 = \beta$. See Figure 5. This property will be used throughout the article in some varied settings so we explain it carefully here, following the notation of the first part of the proof. The geodesics ℓ_t have ideal points z_t, x_t . The x_t converge to x_1 , so the direction of x_t in ℓ_t corresponds to the direction of x_1 in ℓ_1 . In ℓ_1 , the point x_1 is the negative ideal point of the flow line ℓ_1 . In addition ℓ_t is asymptotic (in E_t) in

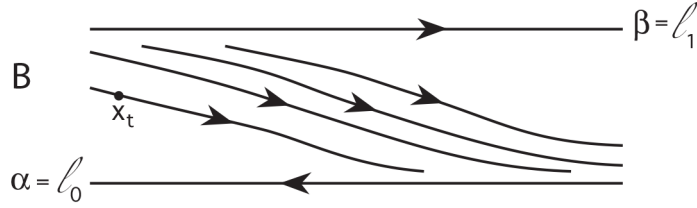

FIGURE 5. A band B . The figure depicts the foliation $\tilde{\Lambda}^s \cap B$, with its geometric behavior: the leaves in the interior are asymptotic to the boundary leaves in the negative flow direction. The arrows in l_0 and l_1 indicate the flow direction in these flow lines.

the x_t direction with the flow line $U \cap E_t$. This flow line is asymptotic in the negative flow direction with $U \cap E_1 = l_1$. It follows that l_t is asymptotic in the x_t direction with l_1 in the negative flow direction of l_1 – as we wanted to prove. In the same way any positive ray of l_t ($0 < t < 1$) is asymptotic to a ray of α which is backwards with respect to the flow in $l_0 = \alpha$. Notice that in α the flow direction and the positive orientation direction differ from each other, see Figure 5.

We now prove the closed property. Suppose that p_i is a sequence in B which converges to p in \tilde{M} . We want to show that p is in B . If there is a subsequence of p_i which is either entirely contained in E_0 or E_1 this follows since α and β are properly embedded in \tilde{M} , being flow lines of $\tilde{\Phi}$.

Hence up to removing finitely many terms we assume that p_i is never in E_0 or E_1 . Let $t_i \in (0, 1)$ with $p_i \in E_{t_i}$. If up to a subsequence t_i is in a compact subinterval J of $(0, 1)$, then the following happens. Fix a compact transversal τ' to $\tilde{\Lambda}^s$, with τ' contained in B and intersecting exactly the leaves l_t for $t \in J$. By compactness of J the following occurs: for any $k > 0$, then in the positive direction of any leaf l_t , after a fixed distance d_k from τ' along any l_t ($t \in J$) then l_t is less than $1/k$ from $l_0 = \alpha$. Again using that α, β are properly embedded in \tilde{M} , it follows that p_i has to have distance from τ' along l_{t_i} which is bounded: this is because if not they get closer and closer to either α or β and since α and β are properly embedded, the sequence p_i would escape in \tilde{M} . Hence sequences in the set $\cup \{l_t, t \in J\}$ can only converge to points in the same set.

Finally suppose that p_i is in l_{t_i} where for simplicity we assume that $t_i \rightarrow 1$ and so that p_i converges to p in \tilde{M} . We also know that there are $q_i \in l_{t_i}$ with q_i converging to q a point in l_1 . We want to show that p is also in l_1 . Suppose this is not the case.

First think of the case that p is in E_1 as well. Since we are assuming that p is not in l_1 , it follows that l_{t_i} also converges to a geodesic v in E_1 through the point p , besides converging to l_1 . This uses that the hyperbolic metrics in different leaves of $\tilde{\Lambda}^s$ vary continuously, so any connected component of a limit of geodesics is a geodesic. Fix a round disk D in E_1 containing in the interior both q and p . Fix a neighborhood of D in \tilde{M} where the foliation $\tilde{\Lambda}^s$ is topologically a product. Hence there are approximating disks D_i in E_{t_i} . The points p_i, q_i are in D_i for i big enough, so the segments of l_{t_i} between also are contained in D_i , as D_i is convex. As a result these segments have bounded length. Hence these segments are supposed to converge to a subsegment of l_1 (because of bounded length), showing that p is in l_1 . This finishes this case.

Suppose now that p is not in E_1 . Hence it is in a leaf F of $\widetilde{\Lambda}^s$ non separated from E_1 . Recall that in general the foliation Λ^s is not \mathbb{R} -covered. However, by construction ℓ_t is always contained in the region of \widetilde{M} bounded by $U \cup V$. The closure of this region is disjoint from F , hence this is impossible.

This proves that B is properly embedded, proving the lemma. \square

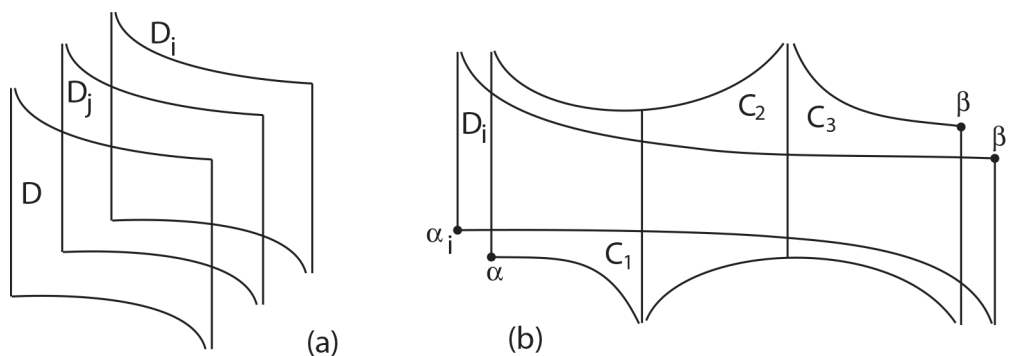

FIGURE 6. (a) A sequence of lozenges D_i converging to a single lozenge D , (b) A sequence of lozenges D_i converging to a union of 3 lozenges C_1, C_2, C_3 . In the figure the lozenges D_i are long horizontally and in the limit split into 3 lozenges.

3.5. Limits of lozenges. In Theorem 5.2 of [Fe7] we proved that there is a global constant $a_0 > 0$ so that if α, β are corners of a lozenge, then the Hausdorff distance between α and β is finite and bounded above by a_0 . See Theorem 2.13 here. It will be crucial for us, when constructing walls in \widetilde{M} , to understand well limits of sequences of lozenges. Suppose that D_i is a sequence of lozenges with corners α_i, β_i . Suppose that the sequence β_i converges to an orbit β . Then bounded Hausdorff distance implies that α_i all intersect a fixed compact set. So up to subsequence the α_i converge to an orbit α .

The simplest situation is that such a limit is a lozenge itself. This always occurs, for example in the case of the geodesic flow, and for any \mathbb{R} -covered Anosov flow. This is depicted in Figure 6 (a) where the sequence D_i converges to the lozenge D . It is very easy to see that another theoretical possibility is that the sequence D_i converges to a union of adjacent lozenges. This is depicted in Figure 6 (b) where the limit of the sequence D_i is the union of the lozenges C_1, C_2, C_3 . In the figure, the corners β_i of D_i converge to β . The other corners α_i of D_i converge to α . The figure depicts the situation that α, β are connected by a finite chain of lozenges.

However there is still a more complicated possibility. This is depicted in Figure 7. This figure is more complex and harder to understand, so we explain it in more detail. For simplicity let us assume that the vertical leaves in the figure are unstable leaves. The curved leaves, slightly horizontal, are stable leaves. In the figure we depict one of the lozenges of the sequence, denoted D_i , this has corners α_i, β_i which converge to orbits α, β , when $i \rightarrow \infty$. The limits α, β are connected by a collection of 3 objects: the first is an actual lozenge with corners α, α' , this is C_1 in the figure. The second object is C_2 , which is a (1, 3) ideal quadrilateral with corners α', β', β'' . The third object is C_3 , which is also a (1, 3) ideal quadrilateral, and has corners β, β', β'' . There is a stable leaf intersecting all of C_1, C_2 and C_3 . In addition there are further lozenges associated with this situation: the pair of

adjacent quadrilaterals C_2, C_3 is contained in a pair of adjacent lozenges B_2, B_3 . For this property see Proposition 2.10. The lozenge B_2 is the union of C_2 and Z_2 . The set Z_2 is disjoint from the limit of the D_i . Similarly for C_3 . The leaf $\tilde{\Lambda}^u(\beta)$ is periodic, however β is not the periodic orbit in it. The periodic orbit in $\tilde{\Lambda}^u(\beta)$ is the orbit δ . The corners of the periodic lozenge $B_3 = C_3 \cup Z_3$ are β'' and δ . In the same way there is a periodic orbit μ in $\tilde{\Lambda}^s(\alpha)$ and μ, α are distinct orbits. This will be used throughout this article. There is a lozenge B which has one side in $\tilde{\Lambda}^u(\alpha')$ and one side in $\tilde{\Lambda}^s(\alpha)$. It is visible in Figure 7. This lozenge intersects the lozenge C_1 , however B neither contains C_1 nor is contained in C_1 .

Convention. There is non uniqueness involved in the objects obtained in the limiting process above: the lozenge C_1 is uniquely determined, and so is the union $C_2 \cup C_3$ (including the common boundary side). This union is a $(2, 2)$ ideal quadrilateral which is not a lozenge. It can be split in uncountably many ways as a union of $(1, 3)$ ideal quadrilaterals. In other words, the orbit β'' is not uniquely determined by the limiting process. We will do the following: using $\tilde{\Lambda}^u(\alpha'), \tilde{\Lambda}^u(\beta)$ and the stable leaf S entirely contained in $\partial(C_2 \cup C_3)$, Proposition shows that S is periodic, and it has a unique periodic orbit ν in it. As a convention we will always choose the splitting of $(C_2 \cup C_3)$ to that β'' is the periodic orbit ν in S . This convention will always be used throughout the article whenever we express a $(2, 2)$ ideal quadrilateral which is not a lozenge as a union of two $(1, 3)$ ideal quadrilaterals.

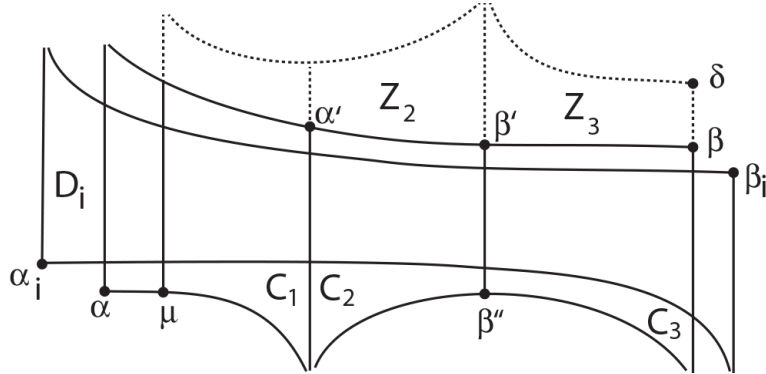

FIGURE 7. A sequence of lozenges D_i converging to a union of 3 elements C_1, C_2, C_3 . The first is a lozenge, and C_2, C_3 are $(1, 3)$ ideal quadrilaterals.

Our next goal is to show that this is the most complicated possibility for the limit, the other two being a single lozenge, or an adjacent chain of lozenges. This will be a crucial ingredient in our analysis. We first need a technical result:

Lemma 3.4. *Suppose that Φ is an Anosov flow so that for any leaf E of $\tilde{\Lambda}^s$ (or $\tilde{\Lambda}^u$) the set of leaves non separated from E in $\tilde{\Lambda}^s$ (or $\tilde{\Lambda}^u$) is finite. In addition suppose that Φ is not orbitally equivalent to a suspension Anosov flow. Then there is no product open set Q in \mathcal{O} so that the boundary of Q has a single corner or no corner. In particular this holds if M is atoroidal.*

Proof. This is the exact statement of Lemma 4.5 of [Fe7], except that the hypothesis there is that the flow Φ is bounded. The bounded hypothesis (see Definition 1.1 of [Fe7]) means that the cardinality of any set of pairwise freely homotopic

periodic orbits of Φ is bounded and Φ is not orbitally equivalent to a suspension. The bounded hypothesis definitely does not follow from the hypothesis of this lemma – for example consider an \mathbb{R} -covered Anosov flow in M hyperbolic. However, what is used in the proof of Lemma 4.5 of [Fe7], is the weaker property that the set of leaves non separated from a leaf in $\tilde{\Lambda}^s$ or $\tilde{\Lambda}^u$ is finite. If this set is not a singleton, then all leaves are periodic, left invariant by the same non trivial deck transformation see Theorem 2.8, which ties in with the bounded hypothesis. Hence the same proof as the proof of Lemma 4.5 of [Fe7] implies the result of this lemma.

If M is atoroidal then Theorem 2.8 implies that the set of leaves non separated from any E is finite. \square

Proposition 3.5. *Let (D_k) be a sequence of lozenges with corners α_k, τ_k , which both converge respectively to δ_0, δ_1 . Then the lozenges D_k converge to either a lozenge, or an adjacent chain of lozenges connecting δ_0, δ_1 containing more than one lozenge; or to a lozenge and a chain of adjacent $(1, 3)$ ideal quadrilaterals, all intersecting a common stable or unstable leaf.*

Remark 3.6. We abuse notation here: we include in the adjacent chain of lozenges also the half leaves which are common boundaries of adjacent lozenges in the chain. With this convention the adjacent chain of lozenges becomes a connected set, which is an product open set. The same convention applies to blocks. In other words the limit of the sequence D_k is an adjacent block. We also abuse notation and many times denote the same way the block \mathcal{B} and the open set in \tilde{M} associated with it.

Proof. Notice that Φ is not orbitally equivalent to a suspension, since there are lozenges.

The case where one of the sequences $(\tilde{\Lambda}^s(\alpha_k)), (\tilde{\Lambda}^u(\alpha_k)), (\tilde{\Lambda}^s(\tau_k)), (\tilde{\Lambda}^u(\tau_k))$ has a constant subsequence (which would be equal to $\tilde{\Lambda}^s(\delta_0)$ in the first case), is easier to deal with than the general case. We do the more complicated case when this does not happen. The simpler case follows from the more general analysis. Up to a subsequence we may assume the following facts: each of the sequences above is by pairwise distinct leaves, every element of any of these sequences intersects a foliated neighborhood of the corresponding limit orbit; and finally the sequences are monotonic in the respective leaf spaces.

We first define a limit product set. The boundary of this set has δ_0, δ_1 as the only corners. The union of this set and its boundary will be shown to have the structure defined in the statement of the lemma.

Let I_k^s be the open interval of stable leaves intersecting the lozenge D_k . Similarly let I_k^u the open interval of unstable leaves. The monotonicity of the sequences $(\tilde{\Lambda}^s(\alpha_k))$, etc.. implies that the sequence (I_k^s) is monotonic – meaning either $I_k^s \subset I_i^s$ for all $i > k$ or vice versa. In addition one of the sequences $(I_k^s), (I_k^u)$ is monotonically increasing and the other is monotonically decreasing. It follows that (I_k^s) converges to an interval, whose interior, denoted by I^s has $\tilde{\Lambda}^s(\delta_0), \tilde{\Lambda}^s(\delta_1)$ as boundary points – and possibly other leaves as well. Similarly let I^u be the interior of the limit of (I_k^u) . This is obvious for the monotonic increasing sequence. Suppose that (I_k^s) is monotonic decreasing. A priori it could be that it converges to a single leaf S . But then $\tilde{\Lambda}^u(\alpha_k) \cap S$ converges to the orbit δ_0 which is in S . This in turn would force $\tilde{\Lambda}^u(\tau_k) \cap S$ to escape to infinity in S , and cannot converge to an orbit δ_1 . We conclude that both I^s, I^u are non empty.

We define the set R to be the set of flow lines η of $\tilde{\Phi}$ so that $\tilde{\Lambda}^s(\eta) \in I^s$ and $\tilde{\Lambda}^u(\eta) \in I^u$.

We claim that R is the interior of the limit of the lozenges D_k . Let η be a flow line in R . Hence for k big enough $\tilde{\Lambda}^s(\eta)$ is in I_k^s and $\tilde{\Lambda}^u(\eta)$ is in $I^u(k)$. In particular η is contained in the lozenge D_k . This also works for a small product neighborhood of η . Hence η is contained in any possible limit of the sequence (D_k) . Conversely if η is contained in the interior of a limit of the (D_k) then $\tilde{\Lambda}^s(\eta)$ is contained in I^s , and $\tilde{\Lambda}^u(\eta)$ is contained in I^u so η is in R . This proves the claim.

Finally we show that R is a product open set. Let X be in I^s and Y in I^u . Then we explained above that there is a neighborhood N_0 of X in I^s which is contained in I_k^s for any k big enough, and similarly for a neighborhood N_1 of Y in I^u for the unstable direction. Any stable leaf Z in N_0 intersects the lozenge D_k and likewise any unstable leaf V in N_1 intersects the lozenge D_k . But D_k is a lozenge, so it is a product open set, and it follows that Z intersects V . In addition the intersection $Z \cap V$ is in R . It follows that the set R is product foliated: each leaf of $\tilde{\Lambda}^s|_R$ intersects each leaf of $\tilde{\Lambda}^u|_R$. Since I^s, I^u are open intervals then R is open as well, that is, it is a product open set.

Notice that the orbits δ_0, δ_1 uniquely determine the intervals I^s, I^u (in case there are such intervals). Therefore there is only one possibility for the set R . This shows that any subsequence of the original (D_k) will produce the same region R and proves that the sequence of lozenges converges to a region with interior R .

Now we analyze the boundary of product open set R . Any corner in the boundary of R has to be the limit of corners of D_k (by our monotonicity assumption, the corners of D_k also vary monotonically). It follows that the boundary of R has exactly two corners, which are δ_0, δ_1 . In addition the boundary of R contains stable and unstable half leaves through these orbits. The stable half leaves of δ_0, δ_1 in the boundary of R are not contained in the same stable leaf and they are boundary points of I^s . We need to be careful here, the limit of a sequence x_i in I^s converging to the boundary may converge to more than one stable leaf in $\tilde{\Lambda}^s$, because the leaf space of $\tilde{\Lambda}^s$ may be non Hausdorff. $\tilde{\Lambda}^s(\delta_0)$ is one specific such limit in the boundary of I^s . There may be other (full) leaves contained in the boundary of R , in which case they will be non separated from respective half leaves through the corners of R . Let Z_0 be the half leaf of $\tilde{\Lambda}^s(\delta_0)$ with endpoint δ_0 which is contained in the boundary of R . Similarly let Y_0 be the half leaf of $\tilde{\Lambda}^u(\delta_0)$ contained in the boundary of R . Similarly define Z_1, Y_1 half leaves of $\tilde{\Lambda}^s(\delta_1), \tilde{\Lambda}^u(\delta_1)$ respectively in the boundary of R .

The detailed description of the boundary of R is quite delicate. We start by analyzing the situation that there is a stable leaf X contained in the boundary of R and non separated from Z_0 . We first show that in this case, there is no unstable leaf V non separated from Y_1 and contained in the boundary of R as well. Suppose by way of contradiction that this occurs. This is depicted in Figure 8, a. Several leaves which will be constructed in the argument here are depicted in this figure. In this case there is a unique unstable leaf V_1 making a perfect fit with X and separating it from δ_0 . This is because X and Z_0 are non separated and therefore connected by a chain of lozenges, all intersecting a common stable leaf (see Theorem 2.8). Then V_1 is the (unique) unstable leaf which has a half leaf in the boundary of two consecutive lozenges, one of which has a stable side contained in X .

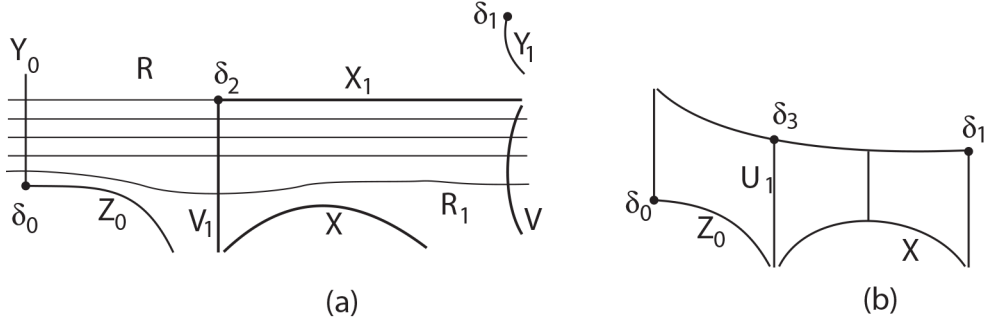

FIGURE 8. a. This situation results in a disallowed product open set R_1 with only one corner, (b) A depiction of a product open set with $(1, 3)$ ideal quadrilaterals.

In addition this leaf V_1 is contained in I^u . In the same way there is a unique stable leaf X_1 making a perfect fit with V and separating it from δ_1 , and in addition X_1 is in I^s . Hence V_1, X_1 intersect, and the intersection δ_2 is an orbit in R . Let now R_1 be the subregion of R which is cut up by $\tilde{\Lambda}^s(\delta_2) \cup \tilde{\Lambda}^u(\delta_2)$ and which contains both X and V in its closure. Then R_1 is also a product open set. But now this open set has a unique corner which is δ_2 . This is impossible by Lemma 3.4.

We conclude that if there is X stable leaf in the boundary of R as above, then there is no V unstable leaf in the boundary of R as above. By hypothesis there is a finite collection of stable leaves $\tilde{\Lambda}^s(\delta_0), X_1, \dots, X_j$ pairwise non separated from each other, so that the X 's are exactly those contained in the boundary of R . For simplicity of depiction we show in Figure 8, (b) the case when there is only one leaf X_k (that is $j = 1$) which is equal to X in this case.

We obtain further properties of the region R and its boundary in this case. First we claim that any leaf in I^s intersects $\tilde{\Lambda}^u(\delta_1)$ (obviously in Y_1). If that were not the case there would be a non empty subinterval of I^s , call it J so that any leaf in J does not intersect $\tilde{\Lambda}^u(\delta_0)$. The interval J is half closed. But because there is no leaf of $\tilde{\Lambda}^u$ non separated from $\tilde{\Lambda}^u(\delta_1)$ contained in the boundary of R , then the interior of J and a corresponding subregion of R would be an unstable product region. Since Φ is not topologically conjugate to a suspension this is impossible by Theorem 2.6. In addition if $\tilde{\Lambda}^u(\delta_1)$ does not make a perfect fit with X_j , similar arguments produce a stable product region, also a contradiction. We conclude that $\tilde{\Lambda}^u(\delta_1)$ and X_j make a perfect fit.

We now analyze this to prove that R is either a finite chain of adjacent lozenges from δ_0 to δ_1 , or a stable adjacent block that includes some $(1, 3)$ ideal quadrilaterals. The leaves $\tilde{\Lambda}^s(\delta_0), X_k$'s are all periodic and left invariant by a common non trivial deck transformation g . This deck transformation also fixes $\tilde{\Lambda}^u(\delta_1)$ since it makes a perfect fit with X_j , and g fixes the distinct leaves $\tilde{\Lambda}^s(\delta_0), X_1$.

Recall that $\tilde{\Lambda}^s(\delta_1)$ cannot intersect $\tilde{\Lambda}^u(\delta_0)$ for otherwise one would see such intersections in the approximating lozenges D_i . Let η_0, η_1 be the periodic orbits in $\tilde{\Lambda}^s(\delta_0), \tilde{\Lambda}^u(\delta_1)$. The question of whether they are the orbits δ_0, δ_1 themselves is crucial here. Nevertheless η_0, η_1 are connected by a chain of adjacent lozenges, all intersecting a common stable leaf. Let these lozenges be G_0, G_1, \dots, G_{2j} . Each X_k generates two adjacent lozenges G_{2k-1}, G_{2k} .

Suppose first that $\tilde{\Lambda}^s(\delta_1)$ makes a perfect fit with $\tilde{\Lambda}^u(\delta_0)$. This is what is depicted in Figure 8, b. Then in particular $\tilde{\Lambda}^s(\delta_1)$ intersects both lozenges G_{2j-1}, G_{2j} . It cuts each such lozenge into a (1, 3) ideal quadrilateral, with one side a half leaf contained in X_j . The same happens for all X_k for $1 \leq k \leq j$. Let U_1 be the unique unstable leaf making a perfect fit with Z_0 and separating it from δ_1 . In other words U_1 has a half leaf which is in the boundary of the first lozenge G_0 . Since $\tilde{\Lambda}^s(\delta_1)$ makes a perfect fit with $\tilde{\Lambda}^u(\delta_0)$ let δ_3 be the intersection of $\tilde{\Lambda}^s(\delta_1)$ and U_1 . It is one corner of the (1, 3) ideal quadrilateral obtained by cutting G_1 with $\tilde{\Lambda}^s(\delta_1)$. Then $\tilde{\Lambda}^s(\delta_3)$ makes a perfect fit with $\tilde{\Lambda}^u(\delta_0)$ and $\tilde{\Lambda}^u(\delta_3) = U_1$ makes a perfect fit with $\tilde{\Lambda}^s(\delta_0)$. In other words δ_0, δ_3 are the corners of a lozenge C . From δ_3 to δ_1 we have an even number of adjacent (1, 3) ideal quadrilaterals, all intersecting a common stable leaf. The description is finished in this case.

We continue the analysis of the case that there is some stable leaf X as above. Recall that X is contained in the boundary of R and X is non separated from $\tilde{\Lambda}^s(\delta_0)$. We now analyze the case that $\tilde{\Lambda}^s(\delta_1)$ does not make a perfect fit with $\tilde{\Lambda}^u(\delta_0)$. Since R is a product open set and there are no product regions, it follows that there are some leaves $T_k, 1 \leq k \leq n$, all non separated from $\tilde{\Lambda}^s(\delta_1)$ and which are contained in the boundary of R .

This argument using that there are no product regions will be used many times, so we give more details than were given before: let β be an orbit in R so that $\tilde{\Lambda}^u(\beta)$ intersects $\tilde{\Lambda}^u(\delta_1)$ and $\tilde{\Lambda}^s(\beta)$ intersects $\tilde{\Lambda}^s(\delta_0)$. Let R_0 be a subregion of R cut off by $\tilde{\Lambda}^u(\beta) \cup \tilde{\Lambda}^s(\beta)$ and containing in its closure a half leaf of $\tilde{\Lambda}^s(\delta_1)$ and a half leaf of $\tilde{\Lambda}^u(\delta_0)$. Since $\tilde{\Lambda}^s(\delta_1)$ does not make a perfect fit with $\tilde{\Lambda}^u(\delta_0)$ there is a first unstable leaf A_1 intersecting $\tilde{\Lambda}^s(\beta)$, intersecting R_0 and not intersecting $\tilde{\Lambda}^u(\delta_1)$. It makes a perfect fit with $\tilde{\Lambda}^s(\delta_1)$. Then A_1 cuts a subregion R' of R_0 which is a product open set. If there is no stable leaf non separated from $\tilde{\Lambda}^s(\delta_1)$ and between A_1 and $\tilde{\Lambda}^u(\delta_0)$, then this shows that that R' is a product region – which is impossible since Φ is not orbitally equivalent to a suspension. Theorem 2.8 shows that there are finitely many leaves $T_i, 1 \leq i \leq n$ non separated from $\tilde{\Lambda}^s(\delta_1)$ between A_1 and $\tilde{\Lambda}^u(\delta_0)$. If the one closest to $\tilde{\Lambda}^u(\delta_0)$ (assume that to be T_n) does not make a perfect fit with a leaf non separated from $\tilde{\Lambda}^u(\delta_0)$, then redo the argument above with T_n in the place of $\tilde{\Lambda}^s(\delta_1)$. This would again show that there is a product region, contradiction. This shows that T_n makes a perfect fit with a leaf non separated from $\tilde{\Lambda}^u(\delta_0)$.

In addition if we exchange the roles of δ_0, δ_1 (in which case the T_1 plays the role of X in the previous argument), one deduces that $\tilde{\Lambda}^u(\delta_0)$ makes a perfect fit with T_n .

Showing that $\delta_1 = \eta_1$ – when $\tilde{\Lambda}^s(\delta_1)$ does not make a perfect fit with $\tilde{\Lambda}^u(\delta_0)$.

In other words, in this case, we want to show that δ_1 is the periodic orbit in $\tilde{\Lambda}^u(\delta_1)$. Suppose by way of contradiction that this is not the case. Suppose first that $\tilde{\Lambda}^s(\eta_1)$ separates $\tilde{\Lambda}^s(\delta_1)$ from δ_0 . Then, since R is a product open set, and $\tilde{\Lambda}^s(\eta_1)$ intersects R , it follows that $\tilde{\Lambda}^s(\eta_1)$ intersects $\tilde{\Lambda}^u(\delta_0)$. This is because $\tilde{\Lambda}^u(\delta_0)$ makes a perfect fit with T_n . Let U be the unstable leaf which has a half leaf in the sides of G_{2j-1} and G_{2j-2} (the lozenges G_k were described previously in this proof). By the above $\tilde{\Lambda}^s(\eta_1)$ intersects U in an orbit η_0 . Since both U and $\tilde{\Lambda}^s(\eta_1)$ are fixed by g , so is η_0 . This is a contradiction, as it would produce two periodic

orbits, η_1, η_0 in $\tilde{\Lambda}^s(\eta_1)$. The remaining possibility is that $\tilde{\Lambda}^s(\delta_1)$ separates $\tilde{\Lambda}^s(\eta_1)$ from δ_0 . However this is also impossible because of the following. Recall that η_1 is connected to η_0 by a chain of adjacent lozenges, all intersecting a common stable leaf. From $\tilde{\Lambda}^s(\eta_1)$ we follow along the stable leaves in the boundary of this chain of lozenges, and all non separated from $\tilde{\Lambda}^s(\eta_1)$. It follows that all of these are separated from η_0 by $\tilde{\Lambda}^s(\delta_1)$. But the last one of these stable leaves is supposed to make a perfect fit with $\tilde{\Lambda}^u(\eta_0)$. This is a contradiction. In addition there is more than one lozenge in the chain from η_0 to η_1 since there is X non separated from $\tilde{\Lambda}^s(\delta_0)$ in the boundary of R .

We conclude that in this situation one is forced to have $\eta_1 = \delta_1$, and consequently $\eta_0 = \delta_0$. In this case the orbits δ_0, δ_1 are connected by a chain of adjacent lozenges all intersecting a common stable leaf. In addition in this situation δ_0, δ_1 are both periodic, left invariant by the same non trivial deck translations, and so are all lozenges in the block.

This finishes the analysis that there is some X non separated from $\tilde{\Lambda}^s(\delta_0)$ contained in the boundary of R . The same happens if there is X non separated from $\tilde{\Lambda}^s(\delta_1)$ contained in the boundary of R . Notice that in either case there is no Y unstable entirely contained in ∂R , so that Y is non separated from either $\tilde{\Lambda}^u(\delta_0)$ or $\tilde{\Lambda}^u(\delta_1)$. Switching the roles of stable and unstable this also deals with the case that there is Y unstable non separated from $\tilde{\Lambda}^u(\delta_0)$ or $\tilde{\Lambda}^u(\delta_1)$ contained in ∂R . In this case there is no other stable leaf in the boundary of R . In addition δ_0, δ_1 are connected by either a chain of lozenges or a lozenge and an even number of $(1, 3)$ ideal quadrilaterals, all intersecting a common unstable leaf.

Finally we are left with the case that there is no other stable, or unstable leaf in ∂R . In this case the same analysis as above shows that $\tilde{\Lambda}^s(\delta_0)$ makes a perfect fit with $\tilde{\Lambda}^u(\delta_1)$ and $\tilde{\Lambda}^u(\delta_0)$ makes a perfect fit with $\tilde{\Lambda}^s(\delta_1)$. In other words δ_0, δ_1 are the corners of a lozenge.

This finishes the proof of Proposition 3.5. \square

Definition 3.7. (basic block) A basic block is a limit of a sequence of lozenges. It can be either a single lozenge, a stable adjacent block with an odd number > 1 of elements, or an unstable adjacent block with an odd number > 1 of elements.

In the cases of adjacent blocks it could be that the elements are all lozenges, or one element is a lozenge and the others are pairs of adjacent $(1, 3)$ ideal quadrilaterals.

3.6. Canonical bands and finite adjacent blocks. In this subsection we construct canonical bands associated with a basic block. Let \mathcal{C} be a basic block with elements $C_i, 0 \leq i \leq 2j$.

Bands for finite adjacent blocks intersecting a common stable leaf

First we consider the case that all elements in \mathcal{C} intersect a common stable leaf. Then every C_i intersects exactly the same set of stable leaves, which is an open interval I_0 . Without loss of generality we assume that C_0 is a lozenge. The other elements are grouped in consecutive pairs: either both elements C_{2k-1}, C_{2k} are adjacent lozenges or they are adjacent $(1, 3)$ ideal quadrilaterals. Let α be the initial corner of C_0 and β be the final corner in C_{2j} . We adjoin the leaves $\tilde{\Lambda}^s(\alpha), \tilde{\Lambda}^s(\beta)$ to the open interval I_0 to produce a closed interval I in the leaf space \mathcal{O}^s of $\tilde{\Lambda}^s$. The canonical band B associated with \mathcal{C} will intersect exactly the stable leaves in I . The intersection with each leaf in I is connected and it is a geodesic. The intersection of B with $\tilde{\Lambda}^s(\alpha)$ is exactly α and similarly for

the intersection with $\tilde{\Lambda}^s(\beta)$. For a leaf E in I_0 we consider the following: let $\eta_E = \tilde{\Lambda}^u(\alpha) \cap E$, $\gamma_E = \tilde{\Lambda}^u(\beta)$. These are both flow lines in E which are geodesics. Let $B \cap E$ be the geodesic in E with ideal points which are the negative ideal points of η_E and γ_E .

Remark 3.8. In the case of a stable adjacent block, the canonical band is transverse to the flow lines except at the boundary leaves.

Just as in the previous subsection one can prove the following:

Lemma 3.9. *The canonical band B is the image of a continuous embedding of an infinite strip into \tilde{M} . The band B is a closed subset of \tilde{M} .*

Proof. The proof is very similar to that of Lemma 3.3. Let \mathcal{F} be the foliation in B induced by $\tilde{\Lambda}^s \cap B$. Just as in Lemma 3.3 the interior leaves are asymptotic to each other in both directions, so they are a bounded distance from each other.

Parametrize I as E_t , $0 \leq t \leq 1$, with $\tilde{\Lambda}^s(\beta) = E_1$. Let $\ell_t = E_t \cap B$. Just as in Lemma 3.3 one proves that ℓ_t converges to ℓ_1 when $t \rightarrow 1$ and similarly for $t \rightarrow 0$. This shows the continuity.

Now we prove the closed property for B . Most of the proof of Lemma 3.3 carries over to our situation. It suffices to consider the situation that $p_i \in \ell_{t_i}$ converges to z , and $t_i \rightarrow 1$, $t_i < 1$, the other cases are dealt with exactly as in Lemma 3.3. Hence z is in a leaf F of $\tilde{\Lambda}^s$, with F non separated from E_1 . The case $F = E_1$ is again dealt with as in Lemma 3.3. So suppose that F is not E_1 . Now this is different from Lemma 3.3, because the block B may have more than one element and hence there may be other stable leaves in the boundary of I_0 which are not separated from $\tilde{\Lambda}^s(\beta)$. We analyze this more carefully.

Recall that the corners of the block \mathcal{C} are α, β .

Since p_i converges to z in F , then up to subsequence we assume that ℓ_{t_i} also converges to a geodesic ζ in F . At least one of the ideal points of ζ is a negative ideal point in F . Call it y . We now consider a closed interval of leaves of $\tilde{\Lambda}^s$ intersecting a transversal τ with an endpoint z and intersecting E_{t_i} for i big enough. Consider the local trivialization of the annulus $A = \cup_{x \in \tau} S^1(\tilde{\Lambda}^s(x))$. Since ℓ_{t_i} converges to ζ one of the ideal points of ℓ_{t_i} converges to y in the local trivialization of A . It follows that there is a closed interval J of unstable leaves all intersecting F with $\tilde{\Lambda}^u(z)$ in the interior of J satisfying the following: the ideal points of ℓ_{t_i} in E_{t_i} converging to y in A are negative ideal points of flow lines $U_i \cap E_{t_i}$, where the U_i are appropriate unstable leaves contained in J . Notice that since U_i intersects F it cannot be either $\tilde{\Lambda}^u(\alpha)$ or $\tilde{\Lambda}^u(\beta)$. But by construction the ideal points of ℓ_{t_i} are the negative ideal points of $\tilde{\Lambda}^u(\beta) \cap E_{t_i}$ and $\tilde{\Lambda}^u(\alpha) \cap E_{t_i}$. Since U_i is neither $\tilde{\Lambda}^u(\alpha)$ nor $\tilde{\Lambda}^u(\beta)$ this is a contradiction. This finishes the proof of the lemma. \square

Bands for basic blocks intersecting a common unstable leaf

In this case the band will split into subbands if $j > 0$.

Suppose first that there are only lozenges in the basic block \mathcal{C} , that is C_i is a lozenge for any $0 \leq i \leq 2j$. For each lozenge C_i construct the canonical band associated to it. The union is the canonical band B associated with the block. Each corner of a lozenge C_i is an orbit which is tangent to the canonical band constructed. The canonical band B can be decomposed into finitely many subbands, and outside of the boundaries of these subbands, the subbands are transverse to the flow lines in the respective leaves of $\tilde{\Lambda}^s$. For each individual

lozenge, the band satisfies the continuity and closed properties of Lemma 3.9, and so does the union.

Now suppose that there are $(1, 3)$ ideal quadrilaterals in \mathcal{C} . To be precise we assume that the first element C_0 is a lozenge and the other elements $C_i, 1 \leq i \leq 2j$ are $(1, 3)$ ideal quadrilaterals. For the lozenge C_0 we consider the canonical band B_0 associated to it. This satisfies the properties of continuity and being closed of Lemma 3.9. For the other elements, consider them in pairs C_{2i-1}, C_{2i} . For simplicity of notation consider C_1, C_2 with corner orbits ζ in ∂C_1 and μ in ∂C_2 , hence $\tilde{\Lambda}^u(\zeta) = \tilde{\Lambda}^u(\mu)$. The associated subband will be denoted by B . Let I be the closed interval of stable leaves from $\tilde{\Lambda}^s(\zeta)$ to $\tilde{\Lambda}^s(\mu)$, parametrized as $E_t, 0 \leq t \leq 1$ with $E_1 = \tilde{\Lambda}^s(\mu)$. Let V be the unstable leaf entirely contained in $\partial(C_1 \cup C_2)$. Let $\ell_0 = \zeta, \ell_1 = \mu$. For $0 < t < 1$ let ℓ_t be the geodesic in E_t with ideal points the negative ideal points of the flow lines $V \cap E_t$ and $\tilde{\Lambda}^u(\zeta) \cap E_t$. Now let

$$B_i = \bigcup_{0 \leq t \leq 1} \ell_t$$

be the band associated with $C_{2i-1} \cup C_{2i}$. Let B be the union of $B_i, 0 \leq i \leq 2j$.

Notice that in this case ζ, μ are asymptotic in the negative direction and the directions of the flow lines ζ, μ agree. Just as in Lemma 3.3, the ℓ_t vary continuously. For $0 < t < 1$ different ℓ_t are asymptotic to each other in both directions. This is because the ideal points are either the negative ideal points of $V \cap E_t$ or the negative ideal point of $\tilde{\Lambda}^u(\zeta) \cap E_t$. Hence for different t the corresponding rays of ℓ_t are asymptotic to each other. The proof that B is closed is easier in this case since there are no other stable leaves in the limit of $E_t, t \rightarrow 1$ which are between V and $\tilde{\Lambda}^u(\mu)$, which is the situation dealt with in Lemma 3.3.

Remark 3.10. In the case of an unstable adjacent block, the canonical band can have two possibilities: Let $C_i, 0 \leq i \leq 2j$ be the elements of the block.

- If there are only lozenges in the block then the canonical band has $2j + 1$ subbands, one for each lozenge C_i .

- If there is one lozenge and $2j$ elements which are $(1, 3)$ ideal quadrilaterals, then the canonical band has $j + 1$ subbands, one for the lozenge, and one for each pair of adjacent $(1, 3)$ quadrilaterals.

The bounded distance property.

Given a finite adjacent block \mathcal{C} with canonical band B , we let \mathcal{F} be the foliation in B induced by intersecting $\tilde{\Lambda}^s$ with B . By construction this foliation has leaf space which is a closed interval. This is a one dimensional foliation in B .

Proposition 3.11. *Let B be the canonical band associated with a finite adjacent block \mathcal{C} . Then any two leaves of \mathcal{F} are a finite Hausdorff distance from each other as subsets of \tilde{M} .*

Proof. Obviously the Hausdorff distance in question depends at least on how many elements there are in B .

The band B is decomposed into finitely many subbands, so that each subband has boundary components which are flow lines and in the interior the subband is transverse to the flow. We do the proof for such a subband, which we now assume is the original band and rename \mathcal{C} as well. This is enough to prove the result. Associated with \mathcal{C} there is a product open set R with only two corners α, β . Notice that with the subdivision of the original band, the resulting \mathcal{C} may not be a basic block. This occurs if the final \mathcal{C} is a union of two adjacent $(1, 3)$

ideal quadrilaterals. After the decomposition, there are unique unstable leaves U, V with a half leaf in ∂R . We first prove the following:

Claim 3.12. α, β are a finite Hausdorff distance from each other.

Proof. This is true if \mathcal{C} is a lozenge, by Theorem 5.2 of [Fe7].

Suppose next that \mathcal{C} is the union of two adjacent $(1, 3)$ quadrilaterals intersecting a common unstable leaf, then α, β are in the same unstable leaf, which we may assume is U . Then there are two adjacent lozenges C_1, C_2 and the $(1, 3)$ quadrilaterals are obtained by cutting C_1, C_2 along U . Up to switching C_1, C_2 , suppose α is in a stable side of C_1 and β in a stable side of C_2 . Then V is the unstable leaf entirely contained in $\partial(C_1 \cup C_2)$. Let γ be the periodic orbit in V . Backwards rays of α, β are asymptotic, hence a finite Hausdorff distance from each other. The leaf V makes a perfect fit with $\tilde{\Lambda}^s(\alpha)$. By Theorem 5.7 of [Fe7] a forward ray in $\tilde{\Lambda}^s(\alpha)$ is a finite Hausdorff distance from a backwards ray in V . Hence a forward ray of α is a finite distance from a backwards ray of γ . The same holds for a forward ray of β and a backwards ray of γ . It follows that forward rays in α and β are a finite Hausdorff distance from each other. This implies that α, β are a finite Hausdorff distance from each other.

The last situation to analyze is the case that \mathcal{C} is a stable adjacent basic block. If it is a union of lozenges, the claim follows from the lozenge case, so we assume \mathcal{C} has a lozenge and pairs of adjacent $(1, 3)$ ideal quadrilaterals. We refer to a previous figure, Figure 8, a. The block \mathcal{C} contains one lozenge and pairs of $(1, 3)$ ideal quadrilaterals, and \mathcal{C} has corners δ_0, δ_1 as in Figure 8, a (so $\{\alpha \cup \beta\} = \{\delta_0 \cup \delta_1\}$). Up to switching the roles of δ_1, δ_0 we may assume that $\tilde{\Lambda}^s(\delta_1)$ makes a perfect fit with $\tilde{\Lambda}^u(\delta_0)$ as in the figure. Again by Theorem 5.7 a forward ray of δ_1 is a finite Hausdorff distance from a backward ray of δ_0 . In addition $\tilde{\Lambda}^s(\delta_0)$ is non separated from stable leaves $X_i, 1 \leq i \leq j$, all in ∂R , with X_j making a perfect fit with $\tilde{\Lambda}^u(\delta_1)$. By Theorem 5.7 of [Fe7] a backward ray of δ_1 is a finite Hausdorff distance from a forward ray of a flow line in X_j . The X_i have periodic orbits which project to freely homotopic orbits of Φ . Hence forward rays in distinct X_i are a finite Hausdorff distance from each other (this could also be obtained by the harder result of Theorem 5.7 of [Fe7]). But $\tilde{\Lambda}^s(\delta_0)$ also has a periodic orbit which projects to M to a periodic orbit freely homotopic to one of these orbits. A forward ray of δ_0 is also a finite Hausdorff distance from these, so we conclude that a forward ray of δ_0 is a finite Hausdorff distance from a backward ray of δ_1 . We conclude that δ_0, δ_1 are a finite Hausdorff distance from each other in \tilde{M} .

This finishes the proof of the claim. \square

Next we analyze the interior leaves of \mathcal{F} , and prove that the whole band B is a finite Hausdorff distance from (say) β . Hence suppose that there are p_i in B so that $d(p_i, \beta)$ converges to infinity. In particular p_i are eventually not in $\alpha \cup \beta$ by the claim above. Up to a subsequence and deck translations g_i we assume that $g_i(p_i)$ converges to p . Let R be the product open set defined by the block \mathcal{C} with corners α, β . Then $g_i(R)$ is a product open set with corners $g_i(\alpha), g_i(\beta)$. Let $I^s(I^u)$ be the open set of stable (unstable) leaves intersecting \mathcal{C} .

We prove that up to a subsequence $(g_i(R))$ converges to a product open set. One concern is that $(g_i(R))$ may converge to a single stable or single unstable leaf. We first analyze this.

For p in \tilde{M} , let $E_p = \tilde{\Lambda}^s(p)$.

Claim 3.13. $g_i(I^s), g_i(I^u)$ cannot converge up to subsequence to a single leaf.

Proof. We first analyze the images $g_i(I^s)$. Suppose that up to a subsequence $g_i(I^s)$ converges to a single leaf F . Up to a subsequence there are distinct leaves S, Q of $\tilde{\Lambda}^s$ which have at least half leaves contained in the boundary of R and so that $\tilde{\Lambda}^u(p_i)$ intersects both S and Q . If $g_i(I^s)$ converges to a single leaf F , then so do the sequences $g_i(S), g_i(Q)$. This implies that $g_i(U), g_i(V)$ escape compact sets in \tilde{M} . In particular the distance from $g_i(p_i)$ to $g_i(U) \cup g_i(V)$ converges to infinity. This is a property that we will show is impossible. The property implies that distance from p_i to $U \cup V$ converges to infinity. Let ℓ_i be the intersection $B \cap E_{p_i}$. The geodesics $U \cap E_{p_i}, V \cap E_{p_i}, \ell_i$ in E_{p_i} are the sides of an ideal triangle T_i in E_{p_i} . Notice that all ideal triangles in the hyperbolic plane are isometric. The point p_i is on one side of this ideal triangle in E_{p_i} . A basic property of the hyperbolic plane implies that any point in any side of an ideal triangle is a bounded distance from the union of the two other sides, hence the distance from p_i to $U \cap E_{p_i} \cup V \cap E_{p_i}$ in E_{p_i} is bounded. This contradicts the property above. In particular this implies that $g_i(I^s)$ cannot converge to a single stable leaf even up to subsequence.

We cannot apply the same argument to $g_i(I^u)$ because the construction is not symmetric. For example the leaves of $\tilde{\Lambda}^u$ are not necessarily smooth. Suppose that $g_i(I^u)$ converges to a single leaf S . Hence $d(g_i(p_i), g_i(U))$ and $d(g_i(p_i), g_i(V))$ both converge to zero. The same is true for p_i, U, V . Now we analyze the situation in E_{p_i} . Again let $\ell_i = B \cap E_{p_i}$. As in the case for I^s , $U \cap E_{p_i}, V \cap E_{p_i}, \ell_i$ are the sides of an ideal geodesic triangle in E_{p_i} . The points p_i are in one side of this triangle. And the distance from p_i to the other two sides converges to zero (when $i \rightarrow \infty$) because $d(p_i, U), d(p_i, V) \rightarrow 0$. But this is impossible: there is a positive lower bound to the maximum distance from a point in a side of an ideal triangle in \mathbf{H}^2 to the other two sides. We conclude that $g_i(I^u)$ also cannot converge to a single (unstable) leaf. This proves the claim. \square

By the claim it follows that there is $a_1 > 0$ so that $g_i(C)$ contains a ball of radius a_1 centered in $g_i(p_i)$. Up to removing finitely many elements we may assume that the $g_i(R)$ pairwise intersect each other. We next now show that the intervals $g_i(I^s), g_j(I^s)$ do not branch from each other. This means the following: there are no $F \in g_i(I^s), L \in g_j(I^s)$ which are distinct but non separated from each other. Suppose this is not the case and let F, L as above. There is q in $g_i(R) \cap g_j(R)$. In addition F intersects $g_i(R)$ so there is q_1 in $F \cap g_i(R)$. But $g_i(R)$ is a product open set, so $\tilde{\Lambda}^s(q_1) = F$ intersects $\tilde{\Lambda}^u(q)$ and the intersection is in $g_i(R)$. In particular $\tilde{\Lambda}^u(q)$ intersects F . In the same way one proves that $\tilde{\Lambda}^u(q)$ intersects L , so F, L cannot be distinct but non separated from each other. It follows that the union $\cup_{i \in \mathbb{N}} g_i(I^s)$ is an open interval in the stable leaf space. Hence $(g_i(I^s))$ converges as $i \rightarrow \infty$ to an interval with non empty interior, which we denote by J^s . In the same way $g_j(I^u)$ converges to an interval with non empty interior, denoted by J^u . It is easy to see that the pair J^s, J^u determines a product open set, which is non empty. In addition the corners of $g_i(R)$ are $g_i(\alpha), g_i(\beta)$. The condition that p_i is not a bounded distance from $\alpha \cup \beta$ implies that these corners converge to infinity. This produces a product open set with no corners. This is impossible by Lemma 3.4.

This contradiction shows that there is $a_2 > 0$ (a priori depending on B) so that B is contained in the a_2 neighborhood of β . Hence any ℓ_t is in the a_2 neighborhood of β . In order to prove that the Hausdorff distance is finite we need to prove the converse inclusion for some fixed size neighborhood of ℓ_t . This

is much easier. To prove this we produce sequences p_n in ℓ_t and q_n in β as follows. Let d be the ambient distance in \widetilde{M} . Choose a point \underline{p}_0 in ℓ_t . The curve ℓ_t is a geodesic in E_t and hence it is properly embedded in \widetilde{M} . For $n > 0$ inductively choose p_{n+1} in ℓ_t so that $d(p_n, p_{n+1}) = 2a_2 + 1$. In addition choose these points p_n so they are nested in ℓ_t . Hence they escape in ℓ_t and also in \widetilde{M} . Similarly for $n < 0$, choose p_{n-1} so that $d(p_n, p_{n-1}) = 2a_2 + 1$ and with the nesting property. Then for each n choose q_n in β with $d(p_n, q_n) < a_2$.

Notice that $d(q_n, q_{n+1}) < 4a_2 + 1$. In addition q_n escapes in \widetilde{M} . We use the very important property: there are no x_n, y_n escaping in opposite rays of β with $d(x_n, y_n)$ bounded. Otherwise the orbit space of $\widetilde{\Phi}$ would not be Hausdorff. Hence as $n \rightarrow \infty$, the q_n escape in a single ray of β . The same happens for $n \rightarrow -\infty$.

We claim that the length in β from q_n to q_{n+1} is uniformly bounded, independent of n or t . Otherwise we can choose n_j so that length in β from q_{n_j} to q_{n_j+1} converges to infinity. This can be done over different ℓ_t as well. But $d(q_{n_j}, q_{n_j+1}) < 4a_2 + 1$. Using deck transformations and a subsequence this would again imply that the leaf space of $\widetilde{\Phi}$ is not Hausdorff, contradiction. This proves the claim. Hence there is $a_3 > 0$ so that a ray of β is in the a_3 neighborhood of a ray in ℓ_t . It follows that a ray of ℓ_t is a finite Hausdorff distance from a ray of β .

There is still one more property to prove which is the following: different rays of ℓ_t are not a finite distance from the same ray of β .

One of the rays in ℓ_t is asymptotic to a backwards ray of β . There are two possibilities. Suppose first the subblock \mathcal{C} is not a pair of adjacent $(1, 3)$ ideal quadrilaterals intersecting a common unstable leaf. Under this condition, then as explained in the first claim in the proof of this proposition (Proposition 3.11), a forward ray of β is a bounded distance from a backward ray of α , and a forward ray of α is a bounded distance from a backward ray of β . Since ℓ_t also has a ray asymptotic to a backward ray of α , this ray is a bounded distance from a forward ray of β . In other words two disjoint rays of ℓ_t cannot be a bounded distance from the same ray of β . This finishes the analysis in this case.

The last case is that the subblock \mathcal{C} is a union of two adjacent $(1, 3)$ ideal quadrilaterals both intersecting a common unstable leaf. Then α, β are in the same unstable leaf and ℓ_t has a ray asymptotic to a backward ray of β . As in the previous setup $U = \widetilde{\Lambda}^u(\beta)$, and V is the other unstable leaf in the boundary of the block. The other ray of ℓ_t is asymptotic to a backwards ray of $E_t \cap V$. This ray of $E_t \cap V$ is a finite Hausdorff distance from a forward ray in $\widetilde{\Lambda}^s(\beta)$ (since $U, \widetilde{\Lambda}^s(\beta)$ make a perfect fit). Hence this ray is a finite Hausdorff distance from a positive ray of β (again by Theorem 5.7 of [Fe7]). Again this shows that disjoint rays of ℓ_t cannot be a bounded distance from the same ray of β and concludes in this case as well.

This completes the proof of Proposition 3.11. \square

We now improve this result for canonical bands associated with lozenges. The *thickness* of a canonical band B is the supremum of the Hausdorff distances between leaves of \mathcal{F} in B . This uses the ambient distance in \widetilde{M} .

Corollary 3.14. *The thickness of canonical bands associated with lozenges is globally bounded.*

Proof. Let B be the canonical band and α, β be its corner orbits. By assumption α, β are the corners of a lozenge. By Theorem 5.2 of [Fe7], the Hausdorff distance between α and β is bounded by a global constant a_0 . We now refer to the proof

of the previous result, Proposition 3.11. Let B_i be a sequence of canonical bands with corners α_i, β_i and B_i associated with lozenges. Suppose there are p_i in B_i so that $d(p_i, \beta_i)$ converges to infinity. The above property implies that p_i are not in α_i . This is where the hypothesis is used. From here on, follow the proof of Proposition 3.11 to obtain a contradiction. \square

Remark 3.15. The global bound result of Corollary 3.14 is not true for general canonical bands. There is a positive constant b_0 so that if \mathcal{C} is a stable adjacent block made up of $2i + 1$ lozenges, then the minimum distance between points in the corners of \mathcal{C} is bounded below by $b_0 i$. Such stable adjacent blocks occur for example in the Bonatti-Langevin example [Bo-La], for any $i > 0$.

3.7. Limits of canonical bands of lozenges. We prove an improvement of Proposition 3.5. We first define geometric convergence.

Definition 3.16. (geometric convergence) A sequence of sets (V_k) in \widetilde{M} converges geometrically to a set V if the following holds:

- For any p in V there are p_k in V_k with $p_k \rightarrow p$.
- If (k_i) is a subsequence of the integers and (p_{k_i}) is a sequence which converges in \widetilde{M} and p_{k_i} is in V_{k_i} for all i , then p is in V .

Proposition 3.17. *Let (D_i) be a sequence of lozenges with corners α_i, β_i which converge respectively to α, β and so that (D_i) converges to a basic block \mathcal{C} . Then the canonical bands B_i associated with D_i converge geometrically to the canonical band B associated with \mathcal{C} .*

Proof. As in the proof of Proposition 3.5, let I_i^s be the open interval in the leaf space of $\widetilde{\Lambda}^s$ of leaves intersecting the lozenge D_i , and let I^s be the interior of the limit of the I_i^s . Similarly for I_i^u and I^u .

We start by proving the first property of Definition 3.16. First of all, the corners of D_i converge to α, β , so the full orbits α, β are in the limit of the D_i . Consider now E in I^s . For i big enough E is in I_i^s . We consider the case where \mathcal{C} is an adjacent block with more than one element, the case where \mathcal{C} is a single lozenge is simpler.

First suppose that \mathcal{C} is an adjacent block whose elements intersect a common stable leaf, let E be such a leaf. We refer to Figure 6, b, and Figure 7 for the arguments. The canonical band B intersects E in a geodesic g with ideal points the negative ideal points of $\widetilde{\Lambda}^u(\beta) \cap E$ and $\widetilde{\Lambda}^u(\alpha) \cap E$. The intersection of B_i with E is a geodesic g_i with ideal points the negative ideal points of $\widetilde{\Lambda}^u(\beta_i) \cap E$ and $\widetilde{\Lambda}^u(\alpha_i) \cap E$. Since α_i converges to α and similarly for β_i , then the geodesics g_i converge to g . Hence any p in g is the limit of a sequence (p_i) with p_i in g_i . In this case the intersection of B with E intersects less orbits than the intersection of B_i with E : the lozenges are shrinking in the stable direction and increasing in the unstable direction.

A similar argument holds if \mathcal{C} is an adjacent block whose elements all intersect a common unstable leaf. The difference is that the intersection of B with E intersects more orbits than the intersection of B_i with E . This finishes the proof that any p in B is the limit of (p_i) with p_i in B_i .

Now suppose that p is the limit of (p_{k_i}) with p_{k_i} in B_{k_i} . We need to show that p is in B . The limit of any subsequences of $(\alpha_i), (\beta_i)$ still converges to α, β respectively. The canonical band B does not change by taking a subsequence. Hence for the purposes of this argument we may assume for simplicity of notation that (k_i) is the original sequence of positive integers. With this understanding

let p be the limit of (p_i) with p_i in B_i . If up to subsequence the p_i are in $\tilde{\Lambda}^s(\beta_i)$ (or $\tilde{\Lambda}^s(\alpha_i)$) then p_i are in fact in β_i (or in α_i). Hence the limit p is in β (or α) – because the orbit space of $\tilde{\Phi}$ is Hausdorff. Therefore p is in B . So we assume from now on that p_i is never in $\tilde{\Lambda}^s(\beta_i) \cup \tilde{\Lambda}^s(\alpha_i)$.

Suppose first that all elements in \mathcal{C} intersect a common stable leaf. Recall the open intervals I_i^s . To these we adjoin $\tilde{\Lambda}^s(\alpha_i), \tilde{\Lambda}^s(\beta_i)$ to obtain closed intervals J_i^s in the leaf space of $\tilde{\Lambda}^s$. In addition adjoin $\tilde{\Lambda}^s(\alpha), \tilde{\Lambda}^s(\beta)$ to I^s to obtain the closed interval J^s . Parametrize J^s as $E_t, 0 \leq t \leq 1$ with $\tilde{\Lambda}^s(\alpha) = E_0$ and $\tilde{\Lambda}^s(\beta) = E_1$.

Let $U_i = \tilde{\Lambda}^u(\alpha_i), V_i = \tilde{\Lambda}^u(\beta_i), U = \tilde{\Lambda}^u(\alpha), V = \tilde{\Lambda}^u(\beta)$.

By hypothesis in this case it follows that I_i^s eventually increases, so assume it always increase. Hence p_i is in a leaf E_{t_i} in $I^s, 0 < t < 1$.

Suppose up to subsequence that t_i converges to t_0 . Suppose first that $0 < t_0 < 1$. The point p_i is in a geodesic g_i in E_{t_i} whose endpoints are the negative ideal of $U_i \cap E_{t_i}$ and $V_i \cap E_{t_i}$. We have that U_i converges to U and V_i converges to V , hence $U_i \cap E_{t_i}$ converges to $U \cap E_{t_0}$. In addition the leaves E_{t_i} and E_{t_0} are asymptotic to each other near the direction of the negative ideal point of $U \cap E_{t_0}$. Similarly for V_i . This shows that any limit point of points in g_i are in the geodesic g in E_{t_0} with ideal points the negative ideal points of $U \cap E_{t_0}$ and $V \cap E_{t_0}$. It follows that p is in g . But by definition, p is in the canonical band associated with the block B . This finishes the case $0 < t_0 < 1$.

Now without loss of generality, assume that $t_0 = 1$, that is $E_{t_0} = \tilde{\Lambda}^s(\beta)$. If p is in E_1 , and p is not in β , then a proof as in Lemma 3.3 shows this is a contradiction. Suppose now that p is in F distinct from $\tilde{\Lambda}^s(\beta)$, but non separated from $\tilde{\Lambda}^s(\beta)$. Then the proof of Lemma 3.9 shows that this is impossible. We conclude that p is in B , and that B is the geometric limit of the canonical bands B_i .

This finishes the proof when the limiting block has all elements intersecting a common stable leaf. Next assume that the limit block \mathcal{C} has elements which all intersect a common unstable leaf. The same proof applies, with the difference that the lozenges D_i increase in the stable direction, instead of decreasing.

This finishes the proof of Proposition 3.17. \square

4. CONSTRUCTION OF WALLS

We now define another object that will be extremely important for our analysis. Recall that throughout this article we assume a metric in M which makes each leaf of Λ^s into a hyperbolic surface. Conversely one could have considered the unstable foliation in place of the stable foliation, and an adjusted definition of walls below.

Definition 4.1. (Walls) A wall L is a properly embedded plane in \tilde{M} satisfying the following conditions. The collection of leaves of $\tilde{\Lambda}^s$ (resp. $\tilde{\Lambda}^u$) which is intersected by L is a copy of the real line in the leaf space of $\tilde{\Lambda}^s$ (resp. $\tilde{\Lambda}^u$), and each leaf of $\tilde{\Lambda}^s$ (resp. $\tilde{\Lambda}^u$) intersects L in a connected set (which could be empty). The leaves of the foliation \mathcal{F} induced in L by $\tilde{\Lambda}^s \cap L$ are geodesics in the respective leaves of $\tilde{\Lambda}^s$. This last property does not necessarily hold for intersections of L with unstable leaves. The foliation \mathcal{F} has a distinguished discrete set of leaves $\gamma_i, i \in \mathbf{Z}$, which are tangent to flow lines of $\tilde{\Phi}$ in respective leaves of $\tilde{\Lambda}^s$. For each $i \in \mathbf{Z}$, the curve γ_i separates γ_{i-1} from γ_{i+1} in L . The collection γ_i escapes in L if $|i| \rightarrow \infty$. For each i , γ_i, γ_{i+1} are the end corners of a finite adjacent block. Let B_i be the subset of L which is the closure of the region between γ_i and γ_{i+1} . Then B_i is the canonical band associated with the respective finite adjacent block. This

set has globally bounded finite thickness. The directions of the flow in γ_i and γ_{i+1} disagree. We stress that the $\{\gamma_i, i \in \mathbf{Z}\}$ may not be all the leaves of \mathcal{F} which are tangent to $\widetilde{\Phi}$. In addition, by a partial wall, we mean one which is a finite union of sets B_i as above, and L is a proper embedding of an infinite band.

We now describe the construction of walls associated with large sets of freely homotopic periodic orbits of Φ . In Theorem 5.10 of [Fe7] we proved that if Φ is an Anosov flow in M^3 atoroidal (hence M is hyperbolic, by Perelman's results) and Φ is not quasigeodesic, then the following happens: for each $i > 0$ there is a chain \mathcal{C}_i which is a string of lozenges with $2i$ lozenges and with periodic corners. The projection to M of the collection of corners produces a set of pairwise distinct freely homotopic orbits of Φ . Let β_{ij} , $-i \leq j \leq i$ be the consecutive corners of \mathcal{C}_i . For each i consider the union of the canonical bands associated with the lozenges in \mathcal{C}_i . This union is a partial wall. The last property uses the fact that \mathcal{C}_i is a string of lozenges. The canonical band associated with corners $\beta_{i,j}$ and $\beta_{i,j+1}$ is denoted by $B_{i,j}$. For each i the union of the canonical bands $B_{i,j}$, $-i \leq j \leq i-1$ – which is a partial wall – is denoted by O_i .

We will take limits of the partial walls associated with this sequence of string of lozenges as follows: Up to a subsequence i_k of i and deck transformations g_k assume there are p_k in the bands B_{i_k, j_k} with $g_k(p_k)$ converging to p_0 in \widetilde{M} . We assume that $|j_k - i_k|$ converges to infinity with k . Since any of the bands are canonical bands associated with lozenges, they have uniformly bounded thickness by Corollary 3.14. Hence up to subsequence we may assume that one of the corners, say $g_k(\beta_{i_k, j_k})$ converges to an orbit γ_0 . Since the Hausdorff distance between orbits which are corners of a lozenge are globally bounded, we may assume that $g_k(\beta_{i_k, j_{k+1}})$ also converges, and to an orbit γ_1 . By Proposition 3.17 the bands $g_k(B_{i_k, j_k})$ converge to the canonical band associated with γ_0, γ_1 . This is an odd adjacent block. We denote it by D_0 . The results of the previous section show this is a finite wall, with uniformly bounded thickness.

Using a diagonal process assume that for each n , the bands $g_k(B_{i_k+n, j_k+n})$ also converge, let the limits be denoted by D_n , and let the limits of the boundary orbits be γ_n, γ_{n+1} . Notice that given n , these bands only exist if $|j_k+n|, |j_k+n+1| \leq i_k$. Since n is fixed, this is satisfied whenever k is big enough.

Any limit of the partial walls $g_k(O_k)$ is a wall. The collection of all such limits is denoted by \mathcal{L} . Just for definiteness we state the following result:

Lemma 4.2. *If L_n is a collection of walls obtained by the process above, and L_n converges to a set L , then L is also a wall and L is contained in \mathcal{L} .*

5. TRANSLATES WITH NO TRANSVERSE INTERSECTIONS

In this section we work toward the proof of the Main theorem under the following condition: suppose there is a wall G as constructed in the limit process of the last section, such that no deck translate of G intersects G transversely. This is existence, this is not saying that all limit walls satisfy this property. By a *transversal intersection* of a wall L we mean there is γ a deck transformation, so that $\gamma(L), L$ intersect in a point p satisfying the following: p is in a leaf E of $\widetilde{\Lambda}^s$, and $L \cap E, \gamma(L) \cap E$ are transverse geodesics in E intersecting in p .

Standing hypothesis Throughout the proof of the main theorem, we assume that there are bigger and bigger strings of freely homotopic orbits and we produce all limits of canonical bands associated with them, as in the previous section, generating the closed set of walls, denoted by \mathcal{L} . This setup does not use that

M is atoroidal. The atoroidal hypothesis will be used in some specific places to obtain further results.

Let then L be a wall and suppose that $\gamma(L), L$ intersect, but not transversely. Ideally one would like to prove that this always implies that $L = \gamma(L)$. However this is not necessarily true in general. But when M is atoroidal, this turns out to be true. We analyze these non transverse intersections to start with.

Definition 5.1. (corners and pivots of walls) Given a wall L a corner of L is a flow line of $\tilde{\Phi}$ which is contained in L . A pivot of L is a corner of L which is also a limit of a sequence of corners of the chains of lozenges used to produce L .

Notice that a corner of L is always a corner of an element of the bi-infinite block associated with L so that η is contained in L . In general there are corners of L which are not pivots of L . This happens if a sequence of lozenges converges to an adjacent block (associated with L) with more than one element: if it is an unstable adjacent block, then there are intermediate corners are not pivots, while the end corners are pivots. In a stable adjacent block, only the end orbits are corners in L . No other corner of an element in the block is contained in L .

Distinguishing pivots from corners that are not pivots – An important property that distinguishes pivots from corners which are not pivots is the following: In a pivot the two adjoining elements of the block associated with L are not adjacent, they are in opposite quadrants. In a corner that is not a pivot the adjoining elements are adjacent. In the first case the set of stable leaves intersected by the elements is monotonic when it crosses the pivot, and the same for the unstable foliation. In the case of corner which is not a pivot, one of them is not monotonic: the unstable leaf through the corner is a local (say) maximum of the unstable leaves nearby intersecting the block. Corners that are not pivots only occur in unstable adjacent blocks with more than one element.

Let α be an orbit of $\tilde{\Phi}$. A *quadrant* Q associated with α is one of the connected components of $\tilde{M} - (\tilde{\Lambda}^s(\alpha) \cup \tilde{\Lambda}^u(\alpha))$. There are four quadrants associated with α . Two quadrants are adjacent if they intersect a common stable or unstable leaf. Let α be an orbit of $\tilde{\Phi}$ contained in a wall L . There are two subbands of L which have α as a boundary component. Each of these subbands enters a distinct quadrant associated with α . The quadrants may be adjacent or not.

Study of properties of non transverse intersections between translates

These properties, which we describe now, are a progression to prove that non transversal intersection implies $L = \gamma(L)$ when M is atoroidal. In Lemma 5.2 we prove that if $L, \gamma(L)$ intersect, but non transversely, then $L, \gamma(L)$ share a corner. In Lemma 5.3 we prove that if a wall L has a periodic corner, then all corners are periodic and there are no (1, 3) ideal quadrilaterals in the bi-infinite block \mathcal{C} associated with L . In Lemma 5.4 we prove that if \mathcal{C} as above has a basic block which is an adjacent block with more than one element, all of which are lozenges, then all the corners of L are periodic. All of these results do not need M atoroidal. In Lemma 5.5 we need to assume M atoroidal – here we prove that if $L, \gamma(L)$ share a corner η and enter the same quadrant Q of η , then $L, \gamma(L)$ agree on the subbands entering Q . For this we also need that γ preserves orientations. In the proof of this result, the atoroidal hypothesis is only used when the corners of L are periodic. The next result is Lemma 5.7 which does not need M atoroidal: assume γ preserves orientations, $L, \gamma(L)$ share a corner orbit η , but $L, \gamma(L)$ do not enter exactly the same quadrants at η . Then all corners of $L, \gamma(L)$ are periodic. The final result is Proposition 5.8, which shows that if M atoroidal, and γ preserves

orientations, then non transversal intersection implies $L = \gamma(L)$. Some of the proofs are very intricate because there are many possibilities to be analyzed.

Lemma 5.2. *Let L be a wall. Let γ in $\pi_1(M)$ so that $\gamma(L)$ and L intersect, but not transversely. Then L and $\gamma(L)$ share a corner orbit.*

Proof. Let p be a point of intersection of L and $\gamma(L)$. Let E be the leaf of $\tilde{\Lambda}^s$ which contains p . Then $L \cap E, \gamma(L) \cap E$ are geodesics in E intersecting at p , but not transversely. As the leaves of $\tilde{\Lambda}^s$ have the hyperbolic metric, it follows that $L \cap E = \gamma(L) \cap E$. Denote this intersection by μ .

If μ is tangent to the flow, the result is obvious. Assume then that μ is transverse to the flow and we will produce a common corner of L and $\gamma(L)$.

Let \mathcal{C} be the bi-infinite block associated with L and \mathcal{E} the bi-infinite block associated with $\gamma(L)$. There are several possibilities to consider. Let R be the basic adjacent block in \mathcal{C} which contains μ and R_γ the one in \mathcal{E} containing μ . Both R and R_γ are adjacent blocks, hence associated with product open sets, denoted in same way, see Remark 3.6. It follows that μ intersects all unstable leaves which intersect R and likewise for R_γ . Hence R, R_γ intersect exactly the same set of unstable leaves. This is not a priori true for the stable foliation. We also stress that it is not necessarily true that $R_\gamma = \gamma(R)$.

Case 1 – One of R or R_γ is a stable adjacent block.

Up to switching R, R_γ assume that R is a stable adjacent block. Either the first or the last element of R is a lozenge, which we denote by C . Let β be a corner of C which is also a pivot of \mathcal{C} . Hence there is a half leaf U' of $U := \tilde{\Lambda}^u(\beta)$ which is exactly the intersection of U with the boundary ∂R .

Suppose first that the full leaf U is contained in the boundary of R_γ . Since C is an element of \mathcal{C} then every unstable leaf intersecting C intersects R and hence intersects R_γ as well. It follows that $\tilde{\Lambda}^s(\beta)$ has a half leaf S contained in R_γ . In addition $U_2 = U - U'$ is also a half leaf of U contained in ∂R_γ . It follows that every stable leaf intersecting U_2 also intersects R_γ . Since R_γ is a product open set then every stable leaf intersecting U_2 also intersects every unstable leaf intersecting S . The set D of points whose unstable leaf intersects S and whose stable leaf intersects U_2 is a product open set. Hence by Lemma 3.4 D has to have another corner, call it α . Since U_2 is entirely contained in ∂R_γ and S is entirely contained in R_γ , it follows by the definition of D , that D is a lozenge and its corners are β and α . Notice that D is contained in R_γ . Hence C, D are adjacent lozenges contained in the block R_γ , which necessarily is an unstable adjacent block. It follows that β is a pivot of R and it is a corner of R_γ which is not a pivot. It follows that β is a common corner of both R and R_γ . This proves the lemma in this situation.

The remaining possibility is that U intersects R_γ in a half leaf, which we denote by U_2 . Let $\alpha = \partial U_2$, it is an orbit of $\tilde{\Phi}$, also a pivot of R_γ . What we want to prove is that $U_2 = U'$, which will imply that β is a corner of both R, R_γ .

Suppose first that U_2 and U' do not contain a common half leaf of U . Since μ is contained in both R and R_γ it follows that $U_2 \cap U'$ is a non empty flow band in U . It follows that $\tilde{\Lambda}^s(\alpha)$ intersects the lozenge C . We refer to Figure 9, a. Let δ be the other intersection of $\tilde{\Lambda}^s(\alpha)$ with ∂C (the first intersection is α). Since every unstable leaf intersecting C intersects μ , then it also intersects R_γ . It follows that the flow band in $\tilde{\Lambda}^s(\alpha)$ from α to δ is contained in R_γ . Since U_2 (which is contained in ∂R_γ) intersects the other component of $\tilde{M} - \tilde{\Lambda}^s(\beta)$, but $\tilde{\Lambda}^u(\delta)$ does not, it follows that R_γ does not intersect $\tilde{\Lambda}^u(\delta)$. It follows that δ

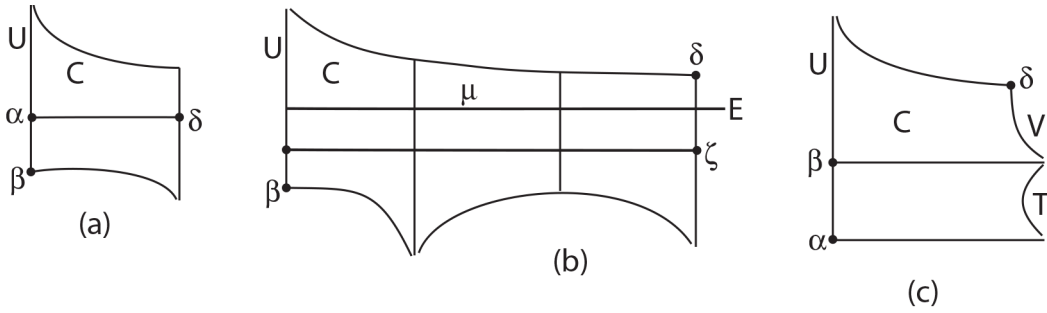

FIGURE 9. Several options in the proof of Case 1.

is also a pivot of R_γ . But then $\tilde{\Lambda}^s(\alpha)$ contains two pivots of R_γ (the pivots are α, δ). This is impossible. We conclude that this situation cannot occur.

Hence U_2, U' share a half leaf. We want to prove that $\alpha = \beta$ which will finish the proof in this case. Suppose this is not the case. Suppose first that that $\tilde{\Lambda}^s(\alpha)$ intersects C , see Figure 9, b. In this case let δ be the other corner of the block R . In the figure we depict the case that R has some $(1, 3)$ ideal quadrilaterals, but the situation of lozenges only in R is dealt with in the same way. Let $V = \tilde{\Lambda}^u(\delta)$. Then μ is a geodesic in $E = \tilde{\Lambda}^s(\mu)$ which has ideal points the negative ideal points of $U \cap E$ and $V \cap E$. Since R_γ intersects the same set of unstable leaves, then R_γ does not intersect V but has parts of the boundary in V . Let $\zeta = \tilde{\Lambda}^s(\alpha) \cap V$. Since μ is contained in R_γ it follows that ζ is a boundary point of R_γ . This is impossible, one cannot have two corner orbits (the orbits would be α, ζ) in the same leaf of $\tilde{\Lambda}^s$ because R_γ is a basic block – it only has 2 corners and the corners are not in the same stable or unstable leaf. We conclude that this situation does not occur.

The other situation is that α is not in the closure of the half leaf U' . This is depicted in Figure 9, c. This is similar to the case above when the entire leaf U was contained in ∂R_γ . Let A be half leaf of $\tilde{\Lambda}^s(\beta)$ which intersects the boundary of R . Here R_γ intersects the component of $\tilde{M} - \tilde{\Lambda}^s(\beta)$ disjoint from C . This implies that the set of unstable leaves intersecting R (and R_γ as well) is exactly the set of leaves intersecting the half leaf A . Since α is a pivot of R_γ it follows that R_γ intersects stable leaves which do not intersect the lozenge C . In this case let δ be the other corner of the lozenge C . It follows that there an unstable leaf T which is entirely contained in ∂R_γ which is also non separated from $V := \tilde{\Lambda}^u(\delta)$. Notice that V also has a half leaf contained in the boundary of R_γ , see Figure 9, c. It follows that R_γ is an unstable adjacent block. Then we are finished: β is a pivot of R and it is also a corner of R_γ .

Case 2 – The blocks R and R_γ are both unstable adjacent blocks with more than one element.

There are several possibilities, some of them we deal with in the same way as in Case 1. The geodesic μ in E has ideal points the negative ideal points of two distinct flow lines δ_1, δ_2 in E . Let $U = \tilde{\Lambda}^u(\delta_1), V = \tilde{\Lambda}^u(\delta_2)$. Also the block R has a subblock which contains μ , this is either a lozenge or a union of two adjacent $(1, 3)$ ideal quadrilaterals forming a $(2, 2)$ ideal quadrilateral which is not a lozenge. In either case let this subblock be denoted by \mathcal{B} . In the same way we define \mathcal{B}_γ : it is the subblock of R_γ containing μ .

Suppose first that both subblocks $\mathcal{B}, \mathcal{B}_\gamma$ are single lozenges. Then the proof that this leads to a common corner is exactly as is done in the proof of Case 1.

Suppose now that one of the subblocks is a lozenge and the other is a union of a pair of $(1, 3)$ ideal quadrilaterals which have a common stable side. Then the proof is the same as in the beginning of the proof of Case 1.

Finally suppose that both blocks are unions of pairs of $(1, 3)$ ideal quadrilaterals. The unstable sides of these blocks are contained in U, V . Each of the pairs $\mathcal{B}, \mathcal{B}_\gamma$ has a full unstable leaf contained in its boundary – this unstable leaf can only be U or V . Suppose first that U is contained in the boundary of (say) \mathcal{B} and V is contained in the boundary of \mathcal{B}_γ . Then U makes a perfect fit with two stable leaves which intersect V and similarly for V . This is impossible. Hence either U is contained in the unstable boundary of both $\mathcal{B}, \mathcal{B}_\gamma$ or V is. Without loss of generality assume that U is contained in both unstable boundaries. Hence the stable leaves in the boundary of $\mathcal{B}, \mathcal{B}_\gamma$ making a perfect fit with U are the same leaves, and so are the intersections with the unstable leaf V . It follows that $\mathcal{B} = \mathcal{B}_\gamma$ and hence they share corner orbits.

This finishes the proof of Lemma 5.2. \square

We also need the following two simple results:

Lemma 5.3. *Let L be a wall, with associated bi-infinite block \mathcal{C} . Suppose that a corner of \mathcal{C} is periodic. Then there are no $(1, 3)$ ideal quadrilaterals in \mathcal{C} , that is, the elements of \mathcal{C} are all lozenges. In addition all corners of \mathcal{C} are periodic.*

Proof. Suppose that a corner δ of \mathcal{C} is periodic, left invariant by a non trivial deck transformation γ . Up to taking a power of γ assume it preserves both transversal orientations. Recall that a corner of L is also a corner of \mathcal{C} .

Suppose by way of contradiction that δ is a corner of an element C of \mathcal{C} which is a $(1, 3)$ ideal quadrilateral. There is C_1 another $(1, 3)$ quadrilateral in \mathcal{C} which is adjacent to C along a flow band. Let δ_1 be other corner of the union $C \cup C_1$. It follows that a half leaf of either $\tilde{\Lambda}^s(\delta)$ or $\tilde{\Lambda}^u(\delta)$ is a side of C . Assume without loss of generality that a half leaf of $\tilde{\Lambda}^s(\delta)$ is a side of C . Let Z be the unique unstable leaf which is entirely contained in the boundary of $C \cup C_1$. Since $\gamma(\tilde{\Lambda}^s(\delta)) = \tilde{\Lambda}^s(\delta)$ and Z makes a perfect fit with $\tilde{\Lambda}^s(\delta)$ it follows that $\gamma(Z) = Z$. This uses the orientation hypothesis. In the same way Z makes a perfect fit with $\tilde{\Lambda}^s(\delta_1)$ so $\gamma(\tilde{\Lambda}^s(\delta_1)) = \tilde{\Lambda}^s(\delta_1)$. On the other hand $\tilde{\Lambda}^u(\delta_1) = \tilde{\Lambda}^u(\delta)$, so also $\gamma(\tilde{\Lambda}^u(\delta_1)) = \tilde{\Lambda}^u(\delta_1)$. So γ fixes the intersection of $\tilde{\Lambda}^s(\delta_1)$ with $\tilde{\Lambda}^u(\delta_1)$, which is exactly δ_1 . In other words $\gamma(\delta_1) = \delta_1$. This is a contradiction because we obtain two distinct orbit δ, δ_1 in $\tilde{\Lambda}^u(\delta)$ which are both invariant under γ .

It follows that δ cannot be the corner of a $(1, 3)$ ideal quadrilateral in \mathcal{C} . Hence δ is the corner of two lozenges in \mathcal{C} . The other corners of these lozenges are also invariant under γ . We can now restart the analysis with these two invariant corners and proceed. It follows that all corners of \mathcal{C} are invariant under γ and there are no $(1, 3)$ ideal quadrilaterals in \mathcal{C} . \square

Lemma 5.4. *Let L be a wall with associated bi-infinite block \mathcal{C} . Suppose that \mathcal{C} has a basic block R which is either a stable adjacent block or an unstable adjacent block, which consists entirely of lozenges, and more than one lozenge. Hence the corners of R are periodic. It follows that all corners of \mathcal{C} are periodic.*

Proof. Assume without loss of generality that R is a stable adjacent block. Let C_0, C_1, \dots, C_{2j} be the elements of R . Let Z be the stable leaf entirely contained in $\partial(C_{2j-1} \cup C_{2j})$. Since $j \geq 1$, it follows that Z is periodic. Let U be the unstable

leaf with a half leaf in the boundary of C_{2j} and U making a perfect fit with Z . Then U is periodic and let α be the periodic orbit of in U .

We want to show that α is a corner of C_{2j} . This is exactly what is done in the subsection “Showing that $\delta_1 = \eta_1$ ” in the end of the proof of Proposition 3.5. There it was shown that the orbit corresponding here to the corner of C_{2j} not in Z , has to be the periodic orbit in the unstable leaf corresponding to U here. In other words this corner orbit of C_{2j} is α .

The last statement follows from the previous lemma. \square

We first analyze two configurations, which will come up in some arguments.

Configuration 0 – Let H be a wall with associated bi-infinite block \mathcal{H} . Let α a pivot of H . Let $Z \in \tilde{\Lambda}^s$ intersecting $\tilde{\Lambda}^u(\alpha)$, let $S \in \tilde{\Lambda}^u$ intersecting $\tilde{\Lambda}^s(\alpha)$, and so that Z, S make a perfect fit. Let P be the quadrant at α so that contains the perfect fit between half leaves of Z, S . Then H cannot enter P .

The proof is by contradiction. Suppose this occurs. Let W be the element of \mathcal{H} with a corner in α and contained in P . Suppose first that the element W is a lozenge. Then it has a side contained in a stable leaf T_0 making a perfect fit with $\tilde{\Lambda}^u(\alpha)$ and a side in a leaf T_1 making a perfect fit with $\tilde{\Lambda}^s(\alpha)$. Both T_0, T_1 are contained in P . The leaves T_0, T_1 have to intersect in the other corner of the lozenge, but Z separates T_0 from T_1 showing this situation is impossible.

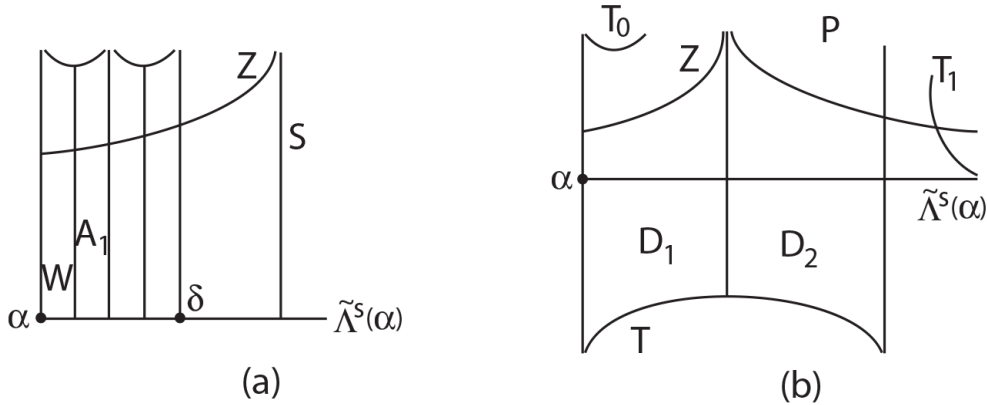

FIGURE 10. (a) Figure used for Configuration 0, (b) Figure used to start the analysis of Configuration 1.

Suppose now that W is a $(1, 3)$ ideal quadrilateral. The situation is fairly symmetric here in terms of stable and unstable so we assume that the pair of adjacent ideal quadrilaterals, one of which is W , intersects a common stable leaf. Let $A_1 \neq \tilde{\Lambda}^u(\alpha)$ be the unstable leaf which also has a half leaf in the boundary of the union of the pair of $(1, 3)$ ideal quadrilaterals. We refer to Figure 10, a. The important thing to notice is that A_1 intersects $\tilde{\Lambda}^s(\alpha)$ and the intersection is a corner of the union of the pair of $(1, 3)$ ideal quadrilaterals.

Iterate until the last pair of ideal quadrilaterals in the basic block of \mathcal{H} containing W , with a last corner denoted by δ which is still in $\tilde{\Lambda}^s(\alpha)$. A priori this could be the last corner of the basic block of \mathcal{H} containing W (that is δ would be a pivot of the basic block), or there could be one more element in the basic block, which necessarily would be a lozenge. Here is where we are going to use the fact that α is a pivot, so it is the first corner in the basic block. Since we only had pairs of quadrilaterals, we have an even number of elements, so there is one

last element which necessarily is a lozenge. This lozenge has a corner in δ and is contained in P . The analysis of the lozenge case shows that this is impossible.

This finishes the analysis of Configuration 0.

Configuration 1 – Suppose that α is a corner of a wall H and α is in the boundary of a lozenge D_1 , part of two adjacent lozenges D_1, D_2 and so that either $\tilde{\Lambda}^s(\alpha)$ or $\tilde{\Lambda}^u(\alpha)$ intersects the interior of D_1 and D_2 . Let P be the quadrant at α which contains half leaves of two distinct stable leaves which are in the boundary of $D_1 \cup D_2$. Then H cannot enter the quadrant P .

We refer to Figure 10, b. Let \mathcal{H} be the bi-infinite block associated with H . We assume by contradiction this is not true and let W be the element of \mathcal{H} with a corner in α and contained in the quadrant P . Without loss of generality assume that $\tilde{\Lambda}^s(\alpha)$ intersects the interiors of D_1, D_2 . Let Z be the stable leaf which contains a half leaf in boundary of D_1 and Z intersecting $\tilde{\Lambda}^u(\alpha)$. Let T be the stable leaf which is entirely contained in $\partial(D_1 \cup D_2)$. Suppose first that W is a lozenge. Two of the sides of W are half leaves in $\tilde{\Lambda}^s(\alpha)$ and $\tilde{\Lambda}^u(\alpha)$. The other two sides are in leaves T_0 that make a perfect fit with $\tilde{\Lambda}^u(\alpha)$ and T_1 which makes a perfect fit with $\tilde{\Lambda}^s(\alpha)$. The leaf Z separates T_0 from T_1 , so T_0, T_1 could not intersect, contradicting the lozenge possibility.

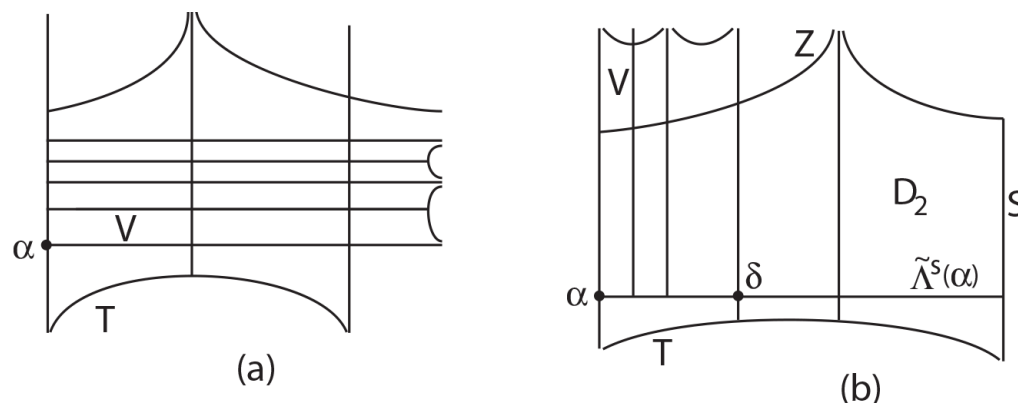

FIGURE 11. Possibilities associated with Configuration 1.

The other possibility is that W is a $(1, 3)$ ideal quadrilateral. This is part of a pair of adjacent ideal quadrilaterals. Suppose first this pair intersects a common unstable leaf as in Figure 11, a. Then the other corner of the union of the two adjacent $(1, 3)$ ideal quadrilaterals is still in $\tilde{\Lambda}^u(\alpha)$ as in Figure 11, a. If there are more pairs of adjacent quadrilaterals, this last property keeps occurring, until the last element in the basic block of the basic block of \mathcal{H} containing with W which is either a lozenge or a $(1, 3)$ ideal quadrilateral. If it is a lozenge, then it still has a corner in $\tilde{\Lambda}^u(\alpha)$, and we obtain a contradiction as in the case of initial element is a lozenge. Otherwise the last element is a $(1, 3)$ ideal quadrilateral, and the first element of the basic block is a lozenge. Without loss of generality we may assume that this first element has a corner in α . Let this lozenge be denoted by C . Then C is in the quadrant at α which contains the leaf T . Then one stable side of the lozenge is contained in T and intersects an unstable leaf which makes a perfect fit with $\tilde{\Lambda}^s(\alpha)$. This is impossible.

The last situation is that the two adjacent $(1, 3)$ ideal quadrilaterals (one of which is W) intersect a common stable leaf. This is depicted in Figure 11, b. Then we have a finite collection of such pairs, the corners of which are always in $\tilde{\Lambda}^s(\alpha)$. Let δ be the last such corner. So we still have that $\tilde{\Lambda}^u(\delta)$ intersects Z . Again it could be that the final element of the basic block is a lozenge with corner δ . The same proof as the case that W is a lozenge shows that this is impossible. Otherwise δ is a pivot in the wall H . The next element of \mathcal{H} is in the quadrant at δ which does not intersect Z or $\tilde{\Lambda}^u(\alpha)$. This quadrant has the property that it contains a perfect fit between a stable leaf T and an unstable leaf S which make a perfect fit and so that $T \cap \tilde{\Lambda}^u(\delta) \neq \emptyset$ and $S \cap \tilde{\Lambda}^s(\delta) \neq \emptyset$. This is impossible, by Configuration 0 – which needs that δ is a pivot.

This finishes the analysis of Configuration 1.

We stress that we have to assume that α is a pivot in Configuration 0, but α only needs to be a corner in the analysis of Configuration 1.

Lemma 5.5. *Assume that M is atoroidal. Suppose that L is a wall and γ is a deck transformation such that both L and $\gamma(L)$ contain the same orbit η of $\tilde{\Phi}$ and both L and $\gamma(L)$ enter the same quadrant Q associated with η . Suppose that γ preserves the transverse orientations to $\tilde{\Lambda}^s, \tilde{\Lambda}^u$. Then the subbands of $L, \gamma(L)$ with boundary in η and entering Q are the same.*

Proof. Let \mathcal{C} (resp. \mathcal{E}) be the bi-infinite block associated with L (resp. $\gamma(L)$).

The proof is long because there are many possibilities.

Case 1 - The elements of both \mathcal{C} and \mathcal{E} adjoining η in the quadrant Q are lozenges.

In this case since the lozenges share a corner and intersect in the interior, it follows that these lozenges are the same. Let C be this lozenge. It does not immediately follow that the subbands of L and $\gamma(L)$ are the same because one or both the basic blocks in \mathcal{C}, \mathcal{E} could be a stable adjacent block with more than one element. Let α be the other corner of the initial lozenge in the block.

Case 1.1 - One of the basic blocks in \mathcal{C} or \mathcal{E} starting with η is a stable adjacent block with more than one element.

Without loss of generality assume that the basic block of \mathcal{C} satisfies this. In particular η is a pivot in L . Suppose first that the corresponding block in \mathcal{E} is also a stable adjacent block with more than one element. Since the first element of the basic block in \mathcal{C} is a lozenge with a corner η , and the basic block is a stable adjacent block, then the other elements are either $(1, 3)$ ideal quadrilaterals or lozenges, all intersecting a common stable leaf. Hence they all have a side contained in a stable leaf non separated from $\tilde{\Lambda}^s(\eta)$, and also a stable side either contained in $\tilde{\Lambda}^s(\alpha)$ (in the case the additional elements are $(1, 3)$ ideal quadrilaterals), or in stable leaves non separated from $\tilde{\Lambda}^s(\alpha)$ (case that additional elements are lozenges). It follows that the elements are the same for \mathcal{C} and \mathcal{E} . If the blocks are the same, then the subbands are the same and we finish this part of the analysis. If the blocks are not the same, then one of them has more elements. Notice that the intersection of these basic blocks is one of the basic blocks, which we assume is the block in \mathcal{C} without loss of generality.

Suppose first that the additional elements in the basic block in \mathcal{E} are lozenges. Lemma 5.4 implies that all the corners of \mathcal{E} , and hence of \mathcal{C} , are periodic. To deal with this situation we will have to use the fact that M is atoroidal.

By hypothesis $L, \gamma(L)$ share the corner η . Let $\beta = \gamma^{-1}(\eta)$ which is a corner in L as well. Hence β and $\gamma(\beta)$ are corner orbits of L . Suppose for a moment that $\gamma(\beta) = \beta$. Since γ preserves transverse orientations to $\tilde{\Lambda}^s, \tilde{\Lambda}^u$, then γ preserves any lozenge in a chain with a corner β . Therefore γ preserves all lozenges associated with L . Since L is made up of canonical bands this implies that $\gamma(L)$ is equal to L . This finishes the proof in this case.

Assume therefore that $\gamma(\beta)$ is not β . Since β is periodic it has a non trivial isotropy group, let ζ be a generator of the subgroup of this isotropy group which preserves all transverse orientations. Since ζ preserves transverse orientations to $\tilde{\Lambda}^s, \tilde{\Lambda}^u$ and \mathcal{C} is a chain of lozenges, it follows that ζ preserves all lozenges of \mathcal{C} and hence all corners of \mathcal{C} . In addition ζ is a generator of the subgroup of the stabilizer of any of these corners which preserves transverse orientations: this is obtained by switching the corners. Then since $\gamma(\beta)$ is a corner of L , it is preserved by ζ and therefore,

$$\gamma^{-1}\zeta\gamma(\beta) = \beta, \quad \text{which implies that} \quad \gamma^{-1}\zeta\gamma = \zeta^i$$

for some non zero integer i . In the same way starting with the periodic orbit $\gamma(\beta)$ which is a corner of L , one obtains that

$$\gamma\zeta\gamma^{-1}(\gamma(\beta)) = \gamma(\beta), \quad \text{so} \quad \gamma\zeta\gamma^{-1} = \zeta^j$$

for some j non zero integer. These two equations imply $\zeta^{ij} = \zeta$. Hence either $i = j = 1$ or $i = j = -1$. In the second case we have that $\gamma^2\zeta\gamma^{-2} = \zeta$. So in either case γ^2, ζ generate a \mathbb{Z}^2 subgroup of $\pi_1(M)$. Notice that $\pi_1(M)$ is torsion free.

A \mathbb{Z}^2 subgroup of $\pi_1(M)$ contradicts M being atoroidal. It follows that we cannot have that the additional elements in the basic block of \mathcal{E} are lozenges.

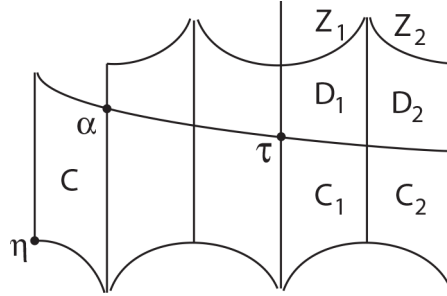

FIGURE 12. Figure for Case 1.1. C_1, C_2 are the first two elements in \mathcal{E} which are not elements of \mathcal{C} .

The other situation to be analyzed is that the additional elements in \mathcal{E} are all pairs of adjacent $(1, 3)$ ideal quadrilaterals. In Figure 12 we depict an example so the block in \mathcal{C} has 3 elements and the block in \mathcal{E} has 5 elements. The last two elements in \mathcal{E} are adjacent $(1, 3)$ ideal quadrilaterals C_1, C_2 . Let D_1, D_2 be the two adjacent lozenges containing C_1, C_2 respectively. Let τ be the corner of C_1 which is also a corner of the block in \mathcal{C} . Hence τ is a pivot of \mathcal{C} . Then we are in the situation of Configuration 1. It was shown in the analysis of Configuration 1 that L cannot enter the quadrant of τ containing the pair of non separated stable leaves Z_1, Z_2 with sides in $\partial(D_1 \cup D_2)$. But since τ is a pivot of \mathcal{C} , then L has to enter that quadrant of τ . This contradiction shows that this case cannot happen.

We conclude that if both elements adjoining η are lozenges and the blocks \mathcal{C} and \mathcal{E} are stable adjacent blocks, then the blocks are the same, so the subbands of $L, \gamma(L)$ adjoining η are the same, and this obtains the lemma in this case.

We continue the analysis of Case 1.1. The next situation to consider is that the basic block of \mathcal{C} starting with C is a stable adjacent block, and \mathcal{E} has a basic block starting with C which is either a single lozenge or an unstable adjacent block with more than one element. We analyze each in turn.

Suppose first that the basic block in \mathcal{E} ends with C , that is, α is a pivot of \mathcal{E} . If the basic block in \mathcal{C} has only lozenges, then all corners are periodic leading to a contradiction to M atoroidal as proved above. If all other elements of the basic block in \mathcal{C} are $(1, 3)$ ideal quadrilaterals do the following: analyze the pivot α of \mathcal{E} and the next element of \mathcal{E} beyond α . The analysis of Configuration 1 produces a contradiction, because α is a pivot of \mathcal{E} , and so \mathcal{E} enters the quadrant at α opposite to C .

Finally suppose that the basic block in \mathcal{E} containing C does not end in C . Then α is a corner orbit of \mathcal{E} which is not a pivot, and the basic block in \mathcal{E} is an unstable adjacent block with more than one element. If the additional elements in the basic block of \mathcal{E} are lozenges, then all corners are periodic and we obtain a contradiction to M atoroidal as before. The other possibility is that the remaining elements are pairs of adjacent $(1, 3)$ quadrilaterals all intersecting a common unstable leaf, which also intersects C . The additional corners of the union of these pairs are always in $\tilde{\Lambda}^u(\alpha)$. Let δ be the last such corner. Now δ is a pivot of \mathcal{E} , and we are in the situation just analyzed, which produced a contradiction.

This finishes the proof in Case 1.1.

Case 1.2 - Suppose that none of the basic blocks in \mathcal{C}, \mathcal{E} with a corner in η and entering Q is a stable adjacent block with more than one element.

In this case the basic blocks are either a single lozenge or an unstable adjacent subblock with more than one element. In either case the subband associated with it is the canonical band associated with the lozenge C . This is one aspect where there is an asymmetry between the stable and unstable foliations. So the bands L and $\gamma(L)$ agree in this subband with boundary η .

This finishes the analysis of Case 1.

Case 2 - Up to switching, the element in \mathcal{C} with a corner η and contained in Q is a lozenge and the corresponding element in \mathcal{E} is a $(1, 3)$ ideal quadrilateral.

Let C be the lozenge in \mathcal{C} with a corner in η and contained in the quadrant Q . Let E_1, E_2 the adjacent $(1, 3)$ quadrilaterals, which are elements of \mathcal{E} and (say) E_1 has a corner in η and is contained in Q . We first claim that E_2 is also contained in Q . Otherwise η is an interior point in the compact side of the $(2, 2)$ ideal quadrilateral which is the union of E_1, E_2 . But in that case the orbit η is not contained in the canonical band associated with the basic block containing E_1, E_2 , contrary to assumption. The boundary of the union of E_1, E_2 has a corner in η and contains one side of C . Suppose without loss of generality that it is an unstable side of C , which is then a half leaf of $\tilde{\Lambda}^u(\eta)$. Then the stable leaf A which is contained in the boundary of $E_1 \cup E_2$ makes a perfect fit with $\tilde{\Lambda}^u(\eta)$ and hence it contains a stable side of the lozenge C . But A is supposed to make

a perfect fit with another unstable leaf which intersects $\tilde{\Lambda}^s(\eta)$ (besides $\tilde{\Lambda}^u(\eta)$). This is impossible since C is a lozenge.

This shows that Case 2 cannot happen. Finally we have:

Case 3 - The elements in the blocks \mathcal{C}, \mathcal{E} adjoining η are both (1, 3) ideal quadrilaterals

The (1, 3) ideal quadrilaterals are part of a pair of adjacent ones forming a (2, 2) ideal quadrilateral. If the pairs for both \mathcal{C} and \mathcal{E} intersect a common stable leaf or a common unstable leaf, then the (2, 2) ideal quadrilaterals are exactly the same. Let C_1, C_2 be these ideal quadrilaterals. If there is an unstable leaf intersecting both C_1, C_2 , then the subband is the same and the result is proved.

Next suppose that C_1, C_2 intersect a common stable leaf. Here the blocks in \mathcal{C} and \mathcal{E} are stable adjacent blocks and more analysis is needed. Since the orbit η is contained in the walls $L, \gamma(L)$ and it is part of a stable adjacent block in each of them, it follows that η is a pivot of both \mathcal{C} and \mathcal{E} . Each basic block in \mathcal{C} and \mathcal{E} containing C_1, C_2 has a number of pairs of adjacent (1, 3) ideal quadrilaterals and one lozenge at the end. It is at the end, because the subblocks start at η and the initial elements are (1, 3) ideal quadrilaterals. The lozenge at the end of each block has a side in $\tilde{\Lambda}^s(\eta)$ and this makes a perfect fit with an unstable leaf. Hence this unstable leaf is the same for both of them. Call it U . It intersects a stable leaf S which is non separated from the stable leaf entirely contained in $\partial(C_1 \cup C_2)$. Since the first pair C_1, C_2 is the same for both \mathcal{C} and \mathcal{E} it follows that S is the same for both \mathcal{C} and \mathcal{E} . It now follows easily that the number of pairs is the same for \mathcal{C} and \mathcal{E} , and the other corner of the blocks for \mathcal{C}, \mathcal{E} are the same (this corner is $U \cap S$). Hence the blocks are the same and the canonical band associated with the block is the same. This finishes the analysis in this case.

The remaining case is when the pair of adjacent (1, 3) ideal quadrilaterals for one of \mathcal{C} or \mathcal{E} intersects a common stable leaf and the other intersects a common unstable leaf. Again without loss of generality assume that the block in \mathcal{C} intersects a common unstable leaf. Hence the basic block in \mathcal{C} is an unstable adjacent block with more than one element, and likewise the basic block in \mathcal{E} is a stable adjacent block. Let C_1, C_2 be the initial elements of the basic block in \mathcal{C} and E_1, E_2 the corresponding elements in the basic block in \mathcal{E} , see Figure 13, a. Let U be the unstable leaf entirely contained in $\partial(C_1 \cup C_2)$, and let S be the stable leaf entirely contained in $\partial(E_1 \cup E_2)$. By the description of the stable adjacent blocks, it follows that U should intersect a stable leaf non separated from S . This is impossible, showing this case cannot happen.

This finishes the proof of Lemma 5.5. □

Remark 5.6. In the previous result the atoroidal hypothesis is only used when the corners of L are periodic.

Lemma 5.7. *Suppose that L is a wall, and $\gamma(L)$ is a deck translate sharing a corner η with L . Suppose that γ preserves the transversal orientations to $\tilde{\Lambda}^s, \tilde{\Lambda}^u$. Suppose that the pair of quadrants at η that L enters are not exactly the same as the pair of quadrants at η that $\gamma(L)$ enters. Then all corners of L are periodic, and so are all corners of $\gamma(L)$.*

Proof. Let \mathcal{C}, \mathcal{E} be the bi-infinite blocks associated with L and $\gamma(L)$ respectively. Consider the quadrants of η . There are two possibilities: either L and $\gamma(L)$ enter a common quadrant or not.

Notice that we do not know a priori whether η is a pivot of L or not.

Case 1 - Suppose that L and $\gamma(L)$ enter the same quadrant Q of η .

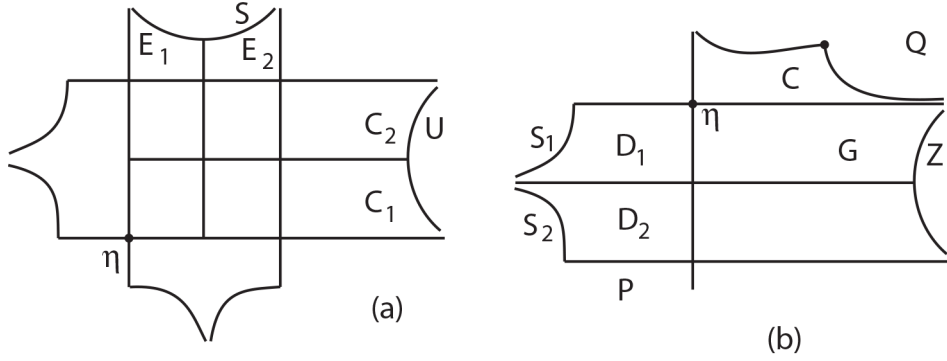

FIGURE 13. a. Figure for Case 3 of Lemma 5.5, b. Figure for Case 1.1 of Lemma 5.7.

By the previous lemma, using also Remark 5.6, either the corners of L and $\gamma(L)$ are periodic – in which case the lemma is proved; or the bands L and $\gamma(L)$ agree on the subband with a boundary in η and entering Q . So assume the second option occurs and we analyze that. There is an element C of \mathcal{C} with a corner η and contained in Q . The element C is also an element of \mathcal{E} because since the bands agree, then the corresponding subblocks in \mathcal{C}, \mathcal{E} also agree.

In particular since the quadrants of η that L and $\gamma(L)$ are not the same, it follows that one of \mathcal{C} or \mathcal{E} has adjacent elements with common corner η . Without loss of generality assume that L satisfies this property ($\gamma(L)$ may also satisfy this property with adjoining element adjacent along another side of C or η may be a pivot of $\gamma(L)$).

Case 1.1 - C is a lozenge.

Suppose first that the adjoining element G of \mathcal{C} is adjacent to C along $\tilde{\Lambda}^u(\eta)$. Then G, C are part of the same adjacent block of \mathcal{C} which is a stable adjacent block. Then the element G is forced to be a $(1, 3)$ ideal quadrilateral. In this case the band associated with this subblock has boundary orbits one which is the other corner of C and one which is on the component of $\tilde{M} - \tilde{\Lambda}^u(\eta)$ not containing C . Since the basic block is a stable adjacent block, this would imply that η is not a corner orbit of L , contradiction.

Suppose on the other hand that the adjoining element G in \mathcal{C} is adjacent to C along $\tilde{\Lambda}^s(\eta)$. Then the adjacent basic block of \mathcal{C} containing C and G is an unstable adjacent block. There are two possibilities: either G is a lozenge or G is a $(1, 3)$ ideal quadrilateral. Suppose first that D is a lozenge, hence C, D are adjacent lozenges. Lemma 5.3 implies that η is a periodic orbit. Lemma 5.4 implies that all corners of L are periodic and finishes the proof. Suppose on the other hand that G is a $(1, 3)$ ideal quadrilateral. The two adjacent $(1, 3)$ ideal quadrilaterals (one of which is G) are contained in adjacent lozenges D_1, D_2 . The leaf $\tilde{\Lambda}^u(\eta)$ intersects the interior of D_1 and D_2 . There is an unstable leaf Z entirely contained in $\partial(D_1 \cup D_2)$. Let S_1, S_2 be the other unstable leaves containing half leaves in the boundary of D_1, D_2 respectively. Then S_1 intersects $\tilde{\Lambda}^s(\eta)$. Let P be the quadrant at η that contains S_2 , see Figure 13, b. Consider now the other element Y of \mathcal{E} with a corner in η as well. If Y were adjacent to the lozenge C along $\tilde{\Lambda}^u(\eta)$, then the basic block in \mathcal{E} would be a stable adjacent block and η would not be contained in the wall $\gamma(L)$, contradiction to assumption. It follows that the element Y of \mathcal{E} is contained in the quadrant P . We are now exactly

in the situation described in Configuration 1. Here the quadrant in question is P , the lozenges are D_1, D_2 . The analysis of Configuration 1 shows that this is impossible, so this cannot occur. This finishes the case that C is a lozenge.

Case 1.2 - C is a (1, 3) ideal quadrilateral.

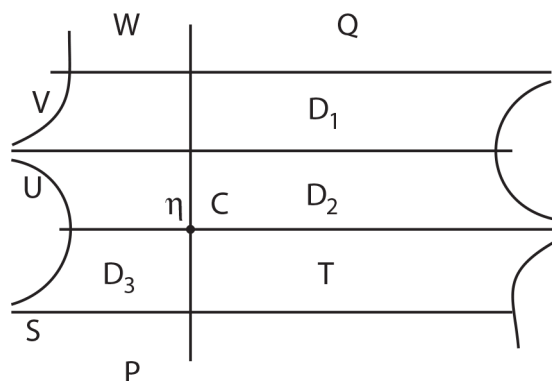

FIGURE 14. Figure for Case 1.2.

Let T be the element of \mathcal{C} which is adjacent to C with common corner η . If T is adjacent to C along $\tilde{\Lambda}^u(\eta)$ then C, T are part of a stable adjacent block. As in Case 1.1, η would not be a corner orbit of L , contradiction. It follows that C, T are adjacent along $\tilde{\Lambda}^s(\eta)$ and they are part of an unstable adjacent basic block which is contained in \mathcal{C} . Then C is part of a lozenge D_2 , and there is another lozenge D_1 adjacent to D_2 along a stable side, and so that D_2 separates D_1 from $\tilde{\Lambda}^s(\eta)$, see Figure 14. This is because C is part of a pair of adjacent ideal quadrilaterals, and η is a corner orbit of the union. In addition T is contained in another lozenge D_3 which is adjacent to D_2 along $\tilde{\Lambda}^s(\eta)$. Let U be the unstable leaf entirely contained in $\partial(D_2 \cup D_3)$ and let V be the unstable leaf with a half leaf in ∂D_1 and not contained in Q . Let W be the quadrant at η containing V . Let P be the quadrant at η opposite to Q . Consider the other element of \mathcal{E} with corner η : if this other element is in the quadrant W , then we are exactly in the situation of Configuration 1, where the quadrant is W and the non separated leaves are U, V . This is impossible by the analysis of Configuration 1. If the other element of \mathcal{E} with corner η is in the quadrant P , then η is a pivot of \mathcal{E} . Here we are in the situation analyzed in Configuration 0, where we use the leaves U, S which make a perfect fit and intersect $\tilde{\Lambda}^s(\eta), \tilde{\Lambda}^u(\eta)$ respectively. The analysis of Configuration 0 shows that this is impossible.

This finishes the analysis of Case 1. Notice that there was one situation possible in this case, which was that the adjoining elements to η in \mathcal{C} are both lozenges and all corners of L are periodic. This is the conclusion we wanted.

Case 2 - L and $\gamma(L)$ do not enter the same quadrant of η .

Either L (and then also $\gamma(L)$) enters adjacent quadrants of η or L (and hence also $\gamma(L)$) enters opposite quadrants of η .

Suppose first that L enters adjacent quadrants of η . We initially consider the case that the elements in \mathcal{C} with corner η are adjacent along $\tilde{\Lambda}^s(\eta)$. Then the block containing them is an unstable adjacent block. If all elements are lozenges, then as in Case 1 this leads to all corners of L being periodic and this completes the proof in this case. If at least one of them is part of a pair of adjacent (1, 3) ideal

quadrilaterals, then they are contained in adjacent lozenges D_1, D_2 . Let P be the quadrant at η which intersects two non separated stable leaves which contain sides in D_1, D_2 respectively. This quadrant P intersects $\gamma(L)$ by hypothesis, and contains S_2 and a half leaf of S_1 . Now we are in the situation of Configuration 1, whose analysis shows this is impossible.

If the elements in \mathcal{C} with corner η are adjacent along $\tilde{\Lambda}^u(\eta)$ then the associated block in \mathcal{C} is a stable adjacent block. Then η is not a corner orbit of \mathcal{C} , contradiction.

Finally suppose that L (and hence $\gamma(L)$) do not enter adjacent quadrants at η . It follows that η is a pivot of both L and $\gamma(L)$. We will show this leads to a contradiction. Choose a transverse orientation to $\tilde{\Lambda}^s$. Now put a transverse orientation to $\tilde{\Lambda}^u$ so that when one crosses a pivot in L in the positive transverse orientation to $\tilde{\Lambda}^s$, then one also crosses the pivot in the positive transverse orientation to $\tilde{\Lambda}^u$. This is possible because \mathcal{C} is a limit of longer and longer strings of lozenges, and strings of lozenges have this coherence property.

Now consider the situation from the point of view of $\gamma(L)$ when one crosses η in the positive transverse orientation to $\tilde{\Lambda}^s$. Since \mathcal{C}, \mathcal{E} intersect disjoint quadrants of η it follows that $\gamma(L)$ crosses η going in the negative transverse orientation to $\tilde{\Lambda}^u$. Now we use that γ preserves transversal orientations to $\tilde{\Lambda}^s, \tilde{\Lambda}^u$. Translating back by γ^{-1} there is a pivot in L so that crossing it in the positive transverse orientation to $\tilde{\Lambda}^s$ is crossing in the negative transverse orientation to $\tilde{\Lambda}^u$. This is contradiction. This shows this last case cannot happen.

This finishes the proof of lemma 5.7. \square

Now we use the previous lemmas to obtain an important conclusion when M is atoroidal.

Proposition 5.8. *Suppose that L is a wall. Suppose that M is atoroidal. Let γ be a non trivial deck transformation so that $\gamma(L)$ and L intersect, but not transversely. Suppose that γ preserves transversal orientations to $\tilde{\Lambda}^s, \tilde{\Lambda}^u$. Then $\gamma(L) = L$. If a corner of L is periodic, then γ preserves all corners of L .*

Proof. The proof is by contradiction. Let $L, \gamma(L)$ which intersect, but not transversely. We assume that L is not equal to $\gamma(L)$ and we obtain a contradiction.

By Lemma 5.2 $L, \gamma(L)$ share a corner η_0 . By Lemma 5.5 if $L, \gamma(L)$ enter the same quadrant Q of η_0 , then $L, \gamma(L)$ have identical subbands with a boundary in η_0 and entering Q . Let η_1 be the other boundary component of this subband, which is a corner of both $L, \gamma(L)$. This can be iterated, and in the other direction too. Since $L, \gamma(L)$ are distinct, one eventually reaches a common corner η_2 so that $L, \gamma(L)$ do not enter exactly the same pair of quadrants of η_2 . By the previous lemma, this shows that all corners of L are periodic and all elements of \mathcal{C} are lozenges. So in any case all corners of L and $\gamma(L)$ are periodic.

By hypothesis $L, \gamma(L)$ share a corner. Now use the argument contained in the analysis of Case 1.1 of Lemma 5.5: that analysis produces a \mathbb{Z}^2 subgroup of $\pi_1(M)$, contradicting that M is atoroidal.

We already proved that $\gamma(L) = L$. Finally if a corner of \mathcal{C} is periodic, then again the analysis in Case 1.1 of Lemma 5.5 implies that γ preserves all corners of \mathcal{C} . This finishes the proof of the proposition. \square

6. THE CASE WITH NO TRANSVERSE INTERSECTIONS

We now start the actual proof of the Main Theorem. In this section we consider the case that there is a wall L so that no deck translate of L intersects L

transversely. With this hypothesis, we know from Proposition 5.8 that since M is atoroidal, then if $\gamma(L)$ is a deck translate intersecting L then $\gamma(L) = L$. As a consequence we have the following result. Suppose that a foliation \mathcal{G} is fixed. A *leafwise geodesic lamination* is a lamination in M transverse to \mathcal{G} and intersecting the leaves of \mathcal{G} in geodesics. In this article we only consider the foliation $\mathcal{G} = \Lambda^s$ for leafwise geodesic laminations.

Corollary 6.1. *Suppose that M is atoroidal and Λ^s, Λ^u are transversely orientable. If L is a wall so that $\pi(L)$ has no transverse self intersections, then the closure of $\pi(L)$ is a leafwise geodesic lamination in M .*

We fix such a wall L and let \mathcal{L} be the leafwise geodesic lamination in M obtained by completing $\pi(L)$. We have the following extremely important property.

Proposition 6.2. *There is $\epsilon > 0$ so that if E is a leaf of $\tilde{\Lambda}^s$, r_1, r_2 are boundary leaves of a complementary region of the lamination $\tilde{\mathcal{L}} \cap E$, and there are $x_i \in r_i$ with $d_E(x_1, x_2) < \epsilon$, then the geodesics r_1, r_2 in E are asymptotic in E .*

Proof. This will use properties of the lamination \mathcal{L} and of Anosov flows.

We do the proof by contradiction. Suppose that there are leaves E_i of $\tilde{\Lambda}^s$ and boundary leaves ℓ_i, α_i of complementary regions of $\tilde{\mathcal{L}} \cap E_i$ with points that are less than ϵ_i apart in E_i , with $\epsilon_i \rightarrow 0$, but ℓ_i, α_i not asymptotic in E_i . There is fixed $a_4 > 0$ satisfying the following: Choose p_i, q_i in ℓ_i, α_i respectively which are at a distance 1 from each other in E_i and so that

$$d_{E_i}(p_i, \alpha_i) > a_4, \quad d_{E_i}(q_i, \ell_i) > a_4$$

Choose rays r_i in ℓ_i , s_i in α_i starting in p_i, q_i respectively and which get ϵ_i close to each other in E_i at some point. Using that M is compact, then up to a subsequence and deck transformations assume that p_i, q_i converge respectively to points p, q both in a leaf of $\tilde{\Lambda}^s$ denoted by E . Let L_i, G_i be the leaves of $\tilde{\mathcal{L}}$ containing p_i, q_i respectively. These are walls.

Since \mathcal{L} is a lamination, then p, q are in leaves of $\tilde{\mathcal{L}}$, so let L, G be the leaves of $\tilde{\mathcal{L}}$ containing p, q respectively. In particular L, G are walls. Let ℓ, α be the intersections $L \cap E, G \cap E$ respectively. First of all notice that ℓ, α are not the same since $d_{E_i}(p_i, \alpha_i) > a_4$ and vice versa for q_i . In addition ℓ_i, α_i have points far away from p_i, q_i respectively, which are ϵ_i close to each other with $\epsilon_i \rightarrow 0$.

Claim 6.3. *For big enough i , we have that $\ell_i \subset L, \alpha_i \subset G$.*

Proof. Choose laminated boxes B_0, B_1 of $\tilde{\mathcal{L}}$ near p, q respectively. The leaf of $\tilde{\mathcal{L}}$ through p_i intersects B_0 for i big enough and the intersection is a disk, and similarly for q_i in B_1 . Given any such i , the intersections of these disks with E_i are in the boundary of a complementary region of $E_i \cap \tilde{\mathcal{L}}$. Up to subsequence it follows that for all leaves F of $\tilde{\Lambda}^s$ intersecting B_0, B_1 , the intersections $F \cap L_i, F \cap G_i$ are boundary leaves of a fixed complementary region of $\tilde{\mathcal{L}} \cap F$. Hence one obtains that after removing finitely many elements, then p_i, p_j are in the same local leaf of $\tilde{\mathcal{L}}$. Similarly for q_i, q_j . The claim follows. \square

Claim 6.4. *The leaves ℓ, α of $\tilde{\mathcal{L}} \cap E$ are asymptotic.*

Proof. This is fairly simple. If ℓ, α are not asymptotic, then they have a common perpendicular in E : the distance between points in ℓ, α decreases until both points are in the common perpendicular then it increases on the other side of these perpendicular points. So from p, q and in a given direction, the distance

between points in ℓ, α either always increases, or decreases for a fixed finite length then increases monotonically. Let a_5 be the minimum of the distance between points in ℓ, α . Then for big enough i one sees the same behavior between ℓ_i, α_i : the distance between decreases to close to a_5 then increases. This means that the distance cannot get close to ϵ_i if ϵ_i is smaller than $a_5/2$ and i is big enough. This contradiction proves the claim. \square

Continuation of the proof of Proposition 6.2.

Recall that L, G are walls and E is a leaf of $\tilde{\Lambda}^s$ and $\ell = L \cap E$, $\alpha = G \cap E$. We will now prove that ℓ_i, g_i are asymptotic in E_i for i big enough.

Consider first the case that the common ideal point of ℓ, α in $S^1(E)$ is not the common forward ideal point of flow lines in E . Then it is a backwards ideal point in $S^1(E)$ and for i big enough, E_i is asymptotic to E in that direction of E . This follows from the properties of walls: for every flow line η contained in a wall L_0 , the nearby leaves of the foliation $\tilde{\Lambda}^s \cap L_0$ are asymptotic in \tilde{M} to η in the negative flow direction of η . In particular ℓ_i is asymptotic in \tilde{M} to ℓ and α_i is asymptotic to α . Since ℓ, α are asymptotic in this direction, then so are ℓ_i, α_i . Using the local product structure of foliations (applied to $\tilde{\Lambda}^s$) it follows that ℓ_i, α_i are asymptotic in E_i as well, as we wanted to prove.

The other case is that the common ideal point of ℓ, α in $S^1(E)$ is the common forward ideal point of all flow lines of $\tilde{\Phi}$ in E . Let x be this point. This case is much more complex. In this case the rays of ℓ_i are not asymptotic to the ray of ℓ in the x direction, since in the positive flow direction of ℓ the nearby leaves of $\tilde{\Lambda}^s$ expand away from E . Since ℓ, α have ideal point x , it follows that ℓ, α are flow lines of $\tilde{\Phi}$ contained in E . In other words ℓ, α are corner orbits of the walls L, G . Up to a subsequence assume every E_i is in the same component of $\tilde{M} - E$.

Let \mathcal{C}, \mathcal{E} be the bi-infinite blocks associated with the walls L, G . Let C, D be the corresponding elements of \mathcal{C}, \mathcal{E} which have a corner in ℓ, α respectively and which intersect E_i . We now prove a simple result that will be very useful for us.

Lemma 6.5. *Let H be a wall and let δ be a leaf of the foliation \mathcal{F} induced by $H \cap \tilde{\Lambda}^s$ in H , and so that δ is not a flow line. Let \mathcal{H} be the bi-infinite block associated with H . Let S in $\tilde{\Lambda}^s$ so that $\delta = H \cap S$. Let U, V in $\tilde{\Lambda}^u$ so that the ideal points of δ in $S^1(S)$ are the negative ideal points of $U \cap S$ and $V \cap S$. Let F in $\tilde{\Lambda}^s$ also intersecting H . Let I the interval of leaves of $\tilde{\Lambda}^s$ intersecting H between F and E , including F, E . Suppose that for any leaf Z in I then the ideal points of $Z \cap H$ are both negative ideal points in $S^1(Z)$. Then for any Z in I the ideal points of $Z \cap H$ are the negative ideal points of $Z \cap U$ and $Z \cap V$. In other words the leaves U, V are constant until H hits a corner orbit, or equivalently until the first time H does not intersect one of U or V . Finally the leaves U, V are constant for any Z in an element of \mathcal{H} .*

Proof. The leaf δ is in a basic block of \mathcal{H} , which we denote by \mathcal{B} . If the basic block is a lozenge, there are unique unstable leaves U, V containing half leaves in the boundary of \mathcal{B} . The corners of the lozenge are leaves of $H \cap \tilde{\Lambda}^s$ which are tangent to the flow. Hence any leaf F as above has to intersect the lozenge. It follows that for any Z between E and F , the ideal points of $Z \cap H$ are the negative ideal points of $U \cap Z$ and $V \cap Z$ as desired. For any $T \in \tilde{\Lambda}^s$ intersecting H outside the lozenge, it does not intersect at least one of U, V , and if it is a leaf containing a side of the lozenge, it contains a corner of the lozenge, which is say in U and then T does not intersect V .

If the basic block \mathcal{B} is a stable adjacent block, then again there are only two unstable leaves U, V with half leaves contained in $\partial\mathcal{B}$. The corners of \mathcal{B} are contained in H , a similar analysis as in the lozenge case yields the result.

Finally suppose the block \mathcal{B} is an unstable adjacent block. Let O_1 be the element of P containing δ . The element O_1 could be either a lozenge or one of a pair of stable adjacent $(1, 3)$ ideal quadrilaterals. If it is a lozenge, the corners of the lozenge are contained in H and the result follows as above. Otherwise let O_2 be the adjacent $(1, 3)$ ideal quadrilateral forming a pair with O_1 , and so that there is a unique unstable leaf U entirely contained in $\partial(O_1 \cup O_2)$. In addition there is a unique unstable leaf V so that $V \cap \partial(O_1 \cup O_2)$ is a non empty flow band in V . The two corners of $O_1 \cup O_2$ are orbits contained in H . For any $Z \in \tilde{\Lambda}^s$ intersecting $O_1 \cup O_2$, including the stable leaf with a flow band which is a side of both O_1 and O_2 (or equivalently the stable leaf separating O_1 from O_2), then Z intersects H and the ideal points of $Z \cap H$ are the negative ideal points of $H \cap U$ and $H \cap V$. At the corners of $O_1 \cup O_2$, the wall H intersects V but not U and any other stable leaf does not intersect at least one of U or V , proving the result in this case as well. \square

Continuation of the proof of Proposition 6.2.

By the lemma, there are unstable leaves U_0, U_1 so that the leaves of $L \cap Z$ for any Z intersecting the element C have ideal points which are the negative ideal points of $U_0 \cap Z$ and $U_1 \cap Z$. Since $L \cap E = \ell$ is a flow line of $\tilde{\Phi}$ it follows that up to switching $U_0 = \tilde{\Lambda}^u(\ell)$. Then it follows that U_1 does not intersect E , but for any Z intersecting C , then Z intersects U_1 . It follows that U_1 makes a perfect fit with a stable leaf non separated from E . There is then a unique unstable leaf U_2 which makes a perfect fit with E and is either equal to U_1 or separates E from U_1 . Recall that $E = \tilde{\Lambda}^s(\ell) = \tilde{\Lambda}^s(\alpha)$.

In the same way there are unstable leaves V_0, V_1 satisfying the following: the ideal points of $G \cap Z$ with Z leaf of $\tilde{\Lambda}^s$ intersecting the element D are given by the negative ideal points of $V_0 \cap Z$ and $V_1 \cap Z$. Without loss of generality assume that $V_0 = \tilde{\Lambda}^u(\alpha)$. Then as in the case of L , it follows that V_1 makes a perfect fit with a stable leaf non separated from E . Let V_2 making a perfect fit with E and either equal to V_1 or separating it from E .

By assumption ℓ, α are distinct flow lines in E_0 , hence U_0, V_0 are distinct leaves. If $U_1 = V_1$ then the intersections of L, G with F near E are asymptotic, and so ℓ_i, α_i are asymptotic for i big enough, as we wanted to prove. So we assume that U_1, V_1 are distinct unstable leaves. There are two possibilities here:

Situation 1 – None of U_1, V_1 separates the other from E .

This is equivalent to U_1, U_0, V_0, V_1 all intersecting a stable leaf Z (Z intersects C) and so that in Z the flows line intersection of the above leaves with Z are linearly ordered. In this case the leaves U_2, V_2 are distinct leaves, contained in the same component of $\tilde{M} - E$, and both making a perfect fit with E . Then Theorem 2.10 implies that E, U_2, V_2 are all periodic, and left invariant by the same non trivial deck transformation ζ . Let δ be the periodic orbit in E . We assume that ζ acts on δ moving points backwards. Then U_2, V_2 are connected by a pair of adjacent lozenges, denoted by D_1, D_2 . The leaf E is entirely contained in $\partial(D_1 \cup D_2)$. Let S, S' be the other stable leaves which have half leaves in the boundary of D_1, D_2 .

Since ℓ, α are distinct orbits in E , at least one of them is not the periodic orbit in E . Without loss of generality assume that ℓ is such an orbit. We depict this in Figure 15, a. Up to switching S, S' assume $\tilde{\Lambda}^u(\ell)$ intersects S . We consider the

two quadrants at ℓ which contain U_2, V_2 : let W be the one that contains δ and let Q the other quadrant that contains one of U_2, V_2 . Suppose that L enters the quadrant W , in which case U_2 intersects S' – notice this is not depicted in Figure 15, a. Then we are in the situation of Configuration 1, which showed that this is impossible. Since L enters $W \cup Q$ as it intersects E_i which intersect $D_1 \cup D_2$, it follows that L enters Q . This is what is depicted in Figure 15, a. Here U_2 has a half leaf contained in Q .

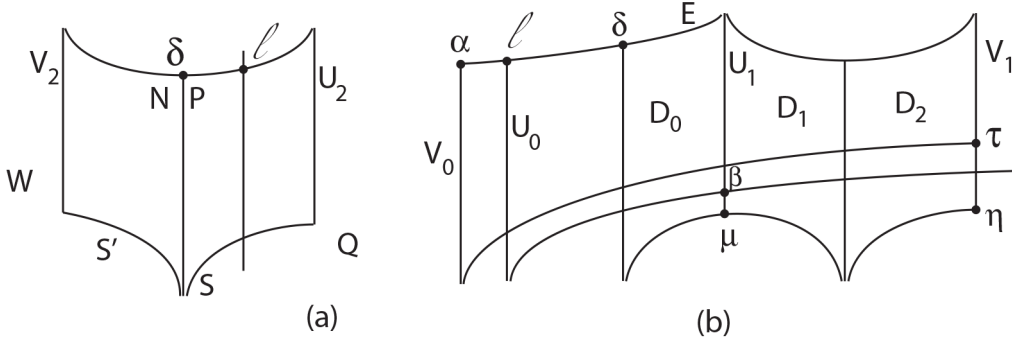

FIGURE 15. a. Figure for Situation 1, b. Figure for Situation 2.

Let A be the component of $\widetilde{M} - E$ which contains U_2, V_2 . Let P, N be the quadrants of δ contained in A and so that P contains the quadrant Q at ℓ . Notice that P, N are quadrants at δ and W, Q are quadrants at ℓ . In particular $Q \subset P$ and not equal, and similarly $N \subset W$ and not equal. Now iterate L by ζ^n , $n \rightarrow \infty$. Then $\zeta^n(\ell)$ converges to δ so $\zeta^n(L)$ converges to a wall K which contains δ and whose intersection with the component A of $\widetilde{M} - E$ is contained in P .

Now do the same with the orbit α which is the intersection of $\gamma(L)$ with E . Using the setup of Configuration 1, we obtain that $\widetilde{\Lambda}^u(\alpha)$ cannot intersect S . So either $\alpha = \delta$ or $\widetilde{\Lambda}^u(\alpha)$ intersects S' . In any case $\gamma(L) \cap A$ is contained in the quadrant N at δ . Again apply ζ^n : $\zeta^n(\alpha)$ converges to δ as $n \rightarrow \infty$, and $\zeta^n(G)$ converges to a wall H containing δ and so that $H \cap A \subset N$.

We conclude that H, K both contain δ but are distinct. This is impossible, by Lemma 5.8. This shows that Situation 1 cannot happen.

Situation 2 – One of U_1, V_1 separates the other from E .

In particular $U_2 = V_2$. Without loss of generality we assume that U_1 separates E from V_1 . We refer to Figure 15, b. This shows that the basic block in \mathcal{E} containing D is a stable adjacent block. The orbit α is a corner orbit of this block, let τ be the other corner orbit. Notice that τ is contained in V_1 .

In the same way ℓ is a corner orbit of the block in \mathcal{C} containing C . For simplicity in the figure we denote the case that U_1 makes a perfect fit with E . Let δ be the periodic orbit in E , η the periodic orbit in V_1 , and μ the periodic orbit in U_1 . As in the previous case let ζ be a generator of the stabilizer of E, U_1, V_1 , and assume as in Situation 1 that ζ acts pushing points backwards along δ .

We first consider the iterates $\zeta^n(G)$ of the wall G , and let $n \rightarrow \infty$. Then as in the previous case $\zeta^n(\alpha)$ converges to δ as $n \rightarrow \infty$. Hence $\zeta^n(G)$ converges to a wall H which contains δ . Notice that ζ acts in η pushing points forwards: this is because $\pi(\delta)$ is freely homotopic to the inverse of $\pi(\eta)$. But since V_1 is an unstable leaf, then ζ still acts in the orbit space of V_1 as a contraction. Hence

$\zeta^n(\tau)$ converges to η . The images under ζ^n of the band in G from α to τ are all isometric, hence they converge to the canonical band with corners δ, τ . It follows that H is a wall containing both δ and η .

On the other hand applying ζ^n to L one obtains: $\zeta^n(\ell)$ also converges to δ as $n \rightarrow \infty$, and $\zeta^n(L)$ converges to a wall T containing δ . In addition either L does not intersect U_1 or intersects it in an orbit β . Hence the limit T either does not intersect U_1 or intersects it in the orbit μ . Regardless T is distinct from H , but both are walls containing δ . Again this is a contradiction to Proposition 5.8. This shows that Situation 2 cannot happen either.

This contradiction shows that the assumption U_1, V_1 are distinct is impossible. Hence $U_1 = V_1$ and it follows that ℓ_i, g_i have to be asymptotic in E_i for i big enough. This finishes the proof of Proposition 6.2. \square

6.1. Ruling out the case that \mathcal{L} is a foliation. Conceivably, \mathcal{L} could be a foliation, we deal with this possibility first.

Proposition 6.6. *\mathcal{L} cannot be a foliation.*

Proof. Suppose by way of contradiction that \mathcal{L} is a foliation. Then \mathcal{L} is a foliation transverse to Λ^s and intersecting its leaves in geodesics. This was analyzed in detail by Calegari in [Cal1], section 4. He proved that there is what is called a *funnel leaf* E in $\tilde{\Lambda}^s$. This means that all the leaves of $\tilde{\mathcal{L}} \cap E$ (which are all geodesics in E) have a common ideal point in $S^1(E)$.

We now have two funnel foliations in E : one which is given by leaves of $\tilde{\mathcal{L}} \cap E$ and is denoted by $\mathcal{W}_{\mathcal{L}}$ and one which is given by the flow lines of $\tilde{\Phi}$ in E denoted by $\mathcal{W}_{\tilde{\Phi}}$. Both of these foliations are by geodesics.

Let x_1 be the funnel point of $\mathcal{W}_{\mathcal{L}}$ and x_2 be the funnel point of $\mathcal{W}_{\tilde{\Phi}}$. They may or may not be the same point (we want to show they are the same point). Let now x be a point in $S^1(E)$ distinct from both x_1, x_2 and I an open interval in $S^1(E)$ containing x and whose closure is disjoint from x_1, x_2 . The geodesics with one ideal point in x_1 and another in $y \in I$ are asymptotic in the y direction to the geodesics with one ideal point in x_2 and the other in y . The first is a leaf of $\mathcal{W}_{\mathcal{L}}$ and the second is a leaf of $\mathcal{W}_{\tilde{\Phi}}$. So there are disks D_i in E of radii converging to infinity where the directions of $\mathcal{W}_{\mathcal{L}}$ and $\mathcal{W}_{\tilde{\Phi}}$ in D_i are less than $1/i$ from each other throughout D_i . Up to a subsequence and deck translations we obtain a leaf F of $\tilde{\Lambda}^s$ so that the foliations $\tilde{\mathcal{L}} \cap F$ and $\tilde{\Phi}|_F$ are the same.

Since M is atoroidal, then every leaf of $\tilde{\Lambda}^s$ is dense. It now follows that for every leaf G of $\tilde{\Lambda}^s$, the foliations $\tilde{\mathcal{L}} \cap G$ and $\tilde{\Phi}|_G$ are the same. In particular this shows that if L is a leaf of $\tilde{\mathcal{L}}$, then the foliation induced by $\tilde{\Lambda}^s \cap L$ has all leaves which are flow lines.

This is a contradiction to the properties of walls. This contradiction shows that \mathcal{L} cannot be a foliation and finishes the proof of the proposition. \square

6.2. The complementary regions of \mathcal{L} . Here we prove that the complementary regions of \mathcal{L} are particularly simple.

Proposition 6.7. *Suppose that M is atoroidal. Let E be a leaf of $\tilde{\Lambda}^s$. The complementary regions of $\tilde{\mathcal{L}} \cap E$ are finite sided ideal polygons in E . The complementary regions of \mathcal{L} are open solid tori or open solid Klein bottles, which are obtained as suspensions of homeomorphisms of finite sided ideal polygons.*

Proof. Taking a double cover if necessary we assume that M is orientable. This does not affect the conclusion of the Proposition. First of all \mathcal{L} is not a foliation, hence there are complementary regions, which obviously are open. Any leaf S of Λ^s is dense in M , because M is atoroidal, hence S hence intersects a complementary region.

Let ϵ_0 be the constant given by Proposition 6.2. Choose $\epsilon < \epsilon_0/2$. Any leaf F of $\tilde{\Lambda}^s$ is isometric to \mathbb{H}^2 . Any complementary region of $\tilde{\mathcal{L}} \cap F$ contains at least an ideal triangle. The ϵ is also chosen much smaller than the inradius of an ideal hyperbolic triangle.

A lot of the arguments are done in M . Consider the set B_0 of point x in $M - \mathcal{L}$ so that x is in a complementary region of $F \cap \mathcal{L}$ (F leaf of Λ^s) and the distance along F from x to a boundary leaf of $F \cap \mathcal{L}$ is exactly ϵ . This set is non empty.

We claim that each component of B of B_0 is a closed surface which is transverse to Λ^s and intersects it in a one dimensional foliation in B . Parts of this analysis are similar to what was done by Thurston in [Th3]. Let $x \in B$. If x is ϵ distant from exactly one boundary leaf of $F \cap \mathcal{L}$, then $B \cap F$ is locally one dimensional near x . Since \mathcal{L} is transverse to Λ^s , the same happens for leaves F' of Λ^s near F and with the corresponding complementary regions. Therefore B is two dimensional near x and $\mathcal{L} \cap \Lambda^s$ induces a one dimensional foliation in B near x .

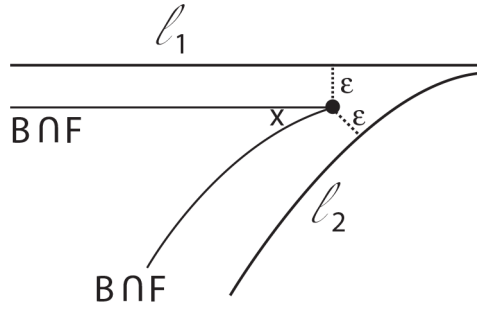

FIGURE 16. l_1, l_2 are boundary leaves in $F \cap \mathcal{L}$. x is a cusp point of $B \cap F$.

Suppose now that x is a point in $B \cap F$ which is ϵ away from at least two boundary leaves l_1, l_2 of $F \cap \mathcal{L}$. Then there are exactly two such leaves in the boundary of the same complementary region of $F \cap \mathcal{L}$. By Proposition 6.2 the leaves l_1, l_2 are asymptotic in one direction and hence they diverge from each other in the other direction, see Figure 16. This implies that locally near x the set $B \cap F$ is also one dimensional and forms a cusp at x , see Figure 16. In particular moving in different directions in l_1, l_2 from points ϵ close to x , the leaves l_1, l_2 get closer than ϵ to each other in one direction and farther than ϵ from each other in the opposite direction. Therefore one can also see this behavior in leaves F' of Λ^s near F along x . In other words $B \cap F'$ is one dimensional locally and has a cusp x' which is near x in M . We conclude that B is a surface and $\Lambda^s \cap B$ induces a one dimensional foliation in B .

An important property is that the surface B cannot accumulate anywhere in M : otherwise one would get two local sheets of B very near each other. In that case one of the sheets would have to be either $< \epsilon$ or $> \epsilon$ from the boundary, which is impossible.

We conclude that B is compact. In addition B has an induced one dimensional foliation given by $\Lambda^s \cap B$. Since B is obviously two sided and M is orientable,

it follows that B is a two dimensional torus. Notice also that the set of “cusp” points in B is locally one dimensional by the above arguments. The arguments also show that any such cusp curve cannot accumulate anywhere in B , hence the set of cusp curves is a finite set of closed curves in B . In addition any such cusp curve is transverse to Λ^s , so it is π_1 injective in M , and hence in B as well.

If B has no cusp points then B will ϵ track a single leaf L of Λ^s . It follows that L is also a torus, and it is isotopic to B . But then L would be compressible, contradicting the fact that leaves of \mathcal{L} are incompressible. The last fact is because leaves of $\tilde{\mathcal{L}}$ are planes in \tilde{M} . Fix μ one such cusp curve.

So far we have not used that M is atoroidal, which will now be used. If M is atoroidal and B is an embedded torus in M , then either B bounds a solid torus, or B is contained in a three ball. The first option is impossible because of the following. Then μ (the cusp curve above) is closed and it is transverse to Λ^s . By Novikov’s theorem μ cannot be null homotopic, hence cannot be contained in a closed ball. Hence B bounds a solid torus V in M .

The non empty set of cusp curves in B forms a finite set of closed curves which are not null homotopic in B , and are pairwise isotopic. Let \mathcal{U} be the one dimensional foliation in B obtained by intersecting B with leaves of Λ^s . We want to show that this is a foliation by closed curves in B , each of which bounds a disk in V and bounds a disk in the respective leaf of Λ^s containing it.

The cusp curves in B cut up B into finitely many annuli, and the boundaries are transverse to \mathcal{U} . Suppose that there is one one annulus, denoted by A so that the foliation \mathcal{U} in A is not a product. There is a leaf of \mathcal{U} intersecting one boundary component of A but not the other. This leaf limits to a closed leaf of \mathcal{U} in the interior of A . The annulus A is ϵ close to a single leaf S of \mathcal{L} . The foliation \mathcal{U} in A pushes along leaves of Λ^s to a foliation of an annulus in S . This foliation is part of the foliation $\Lambda^s \cap S$. Summarizing: in S the foliation $\Lambda^s \cap S$ has a closed leaf α and also has a leaf β which has a point ϵ near a cusp, hence β is asymptotic to another leaf of \mathcal{L} – by Proposition 6.2. Lift S to a leaf L of $\tilde{\mathcal{L}}$, and lift α, β to $\tilde{\alpha}, \tilde{\beta}$. Notice that S is an annulus. In addition the set of curves $\tilde{\beta}$ as above fills one complementary component of $\tilde{\alpha}$ in L . But in a wall this is impossible: there are many corner leaves in any component of $L - \tilde{\alpha}$, and they are not asymptotic to $\tilde{\alpha}$.

Now the foliation \mathcal{U} restricted to any annulus is a product. Suppose that a leaf of \mathcal{U} has a return to μ which is not the initial point. Lift to \tilde{M} : any lift of B is an infinite cylinder and there is a unique lift $\tilde{\mu}$ of μ to this cylinder. The above implies that the lift of the leaf of \mathcal{U} to this cylinder intersects $\tilde{\mu}$ in more than one point. But $\tilde{\mu}$ is a transversal to $\tilde{\Lambda}^s$, so again Novikov’s theorem implies that this is impossible.

This now proves that all leaves of \mathcal{U} are closed and in fact they lift to closed curves in \tilde{M} . It follows that they bound disks in the respective leaves of Λ^s . The boundary does not intersect \mathcal{L} , so the disks do not intersect \mathcal{L} either and are contained in complementary regions of \mathcal{L} .

This finishes the proof of the Proposition 6.7. □

We are now ready to prove one case of our Main theorem.

Theorem 6.8. *Let M be atoroidal. Suppose that for some wall L , every deck translate $\gamma(L)$ does not intersect L transversely. Then Φ is \mathbb{R} -covered.*

Proof. Up to a finite cover we may assume that M is orientable and Λ^s, Λ^u are transversely orientable. The hypothesis imply that \mathcal{L} is a leafwise geodesic

lamination in M , with leaves being projections of walls to M . The previous proposition shows that \mathcal{L} is not a foliation, and the complementary regions of \mathcal{L} intersect leaves of Λ^s with components which are finite sided ideal polygons.

The proof will be by contradiction. Assume that Φ is not \mathbb{R} -covered, and choose distinct leaves Y_1, Y_2 of $\tilde{\Lambda}^s$ which are non separated from each other and with half leaves part of the boundary of adjacent lozenges C_1, C_2 as in Figure 17, a. Let α_i be the periodic orbits in Y_i . Let U_i be the unstable leaf of α_i . Let Y be the leaf of $\tilde{\Lambda}^s$ entirely contained in $\partial(C_1 \cup C_2)$. Let α be the periodic orbit in Y and let $U = \tilde{\Lambda}^u(\alpha)$. Let γ be a generator of the stabilizer of α , which is also a generator of the stabilizer of α_1, α_2 .

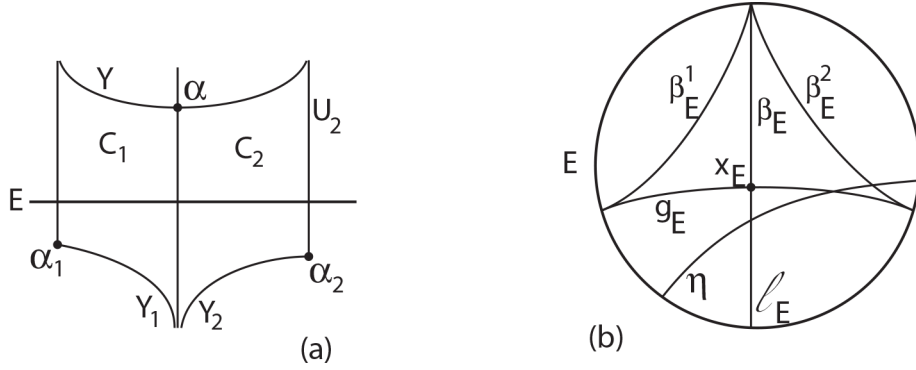

FIGURE 17. a. Non separated stable leaves, b. The segment ℓ_E and the case that η intersects it transversely.

We will consider the set \mathcal{H} of stable leaves E which intersects C_1 . Each such leaf E intersects U_1, U_2, U in flow lines which are geodesics in E . Let these intersections be $\beta_E^1, \beta_E^2, \beta_E$ respectively. Consider the geodesic g_E in E with ideal points the negative limit points of β_E^1, β_E^2 .

Let x_E be the intersection point of g_E and β_E , see Figure 17, b. Let ℓ_E be the ray of β_E starting at x_E and with ideal point the negative ideal point of β_E . We define

$$S = \bigcup_{E \in \mathcal{H}} \ell_E$$

Notice that S is a subset of $U = \tilde{\Lambda}^u(\alpha)$. The points x_E vary continuously with E in \mathcal{H} because the geodesics g_E vary continuously as they are asymptotic to each other (for different E) in both directions. Similarly β_E also varies continuously with E as they are all flow lines in U . Hence the boundary component of ∂S made up by the points β_E is a continuous curve in U . The set S is also γ invariant, since all objects are γ invariant: U_1, U_2, U, \mathcal{H} and so on. Hence the projection $\pi(S)$ is a subannulus of the annulus $\pi(U)$ in M .

The main property we need is the technical result below. By a transverse intersection of S with a leaf L of $\tilde{\mathcal{L}}$ we mean a point p in $L \cap S$ so that if $E = \tilde{\Lambda}^s(p)$, then $\eta = E \cap L$ intersects S transversely.

Lemma 6.9. *The set S has no transverse intersection with the leaves of $\tilde{\mathcal{L}}$.*

Proof. We do the proof of the lemma by contradiction. Suppose the lemma is false. Then there is $E \in \mathcal{H}$ so that ℓ_E intersects $\eta := L \cap E$ transversely.

We refer to Figure 17, b. Let I_i be the open interval in $S^1(E)$ between the ideal point of ℓ_E and the negative ideal point of β_E^i which does not contain the positive ideal point of all flow lines in E . Since η intersects ℓ_E transversely, it follows that η has at least one ideal point in $I_1 \cup I_2$. We assume without loss of generality that η has an ideal point in I_1 . This is depicted in Figure 17, b.

The main idea to obtain a contradiction is that the pair of adjacent lozenges C_1, C_2 prevents the lozenges or ideal quadrilaterals in the bi-infinite block associated with L from closing up. There are various possibilities depending on whether the elements of the bi-infinite block are lozenges or (1, 3) ideal quadrilaterals.

Let \mathcal{C} be the bi-infinite block associated with L . Let \mathcal{B} be the basic block of \mathcal{C} containing η . The geodesic η is transverse to the flow in E . The ray of η which has ideal point in I_1 is asymptotic to a flow line τ in E which has negative ideal point in I_1 . Let $Z = \widetilde{\Lambda}^u(\tau)$. Part of the boundary of \mathcal{B} is contained in Z : it could be the full leaf Z (for example when there are adjacent (1, 3) ideal quadrilaterals in \mathcal{B}), or a half leaf of Z (for example when \mathcal{B} is a single lozenge with an unstable side contained in Z), or a bounded flow band (two or more adjacent (1, 3) ideal quadrilaterals).

There are three possibilities for \mathcal{B} : a single lozenge, a stable adjacent block, an unstable adjacent block.

Case 1 - \mathcal{B} is a single lozenge.

Denote the lozenge by C . The lozenge C has one unstable side contained in Z . It has a stable side, contained in a leaf F which makes a perfect fit Z . Notice that C has to intersect C_1 because η intersects C_1 . There are two possibilities for F depending on which component of $\widetilde{M} - Y$ it is contained in. In both cases it follows that the other unstable side of C is contained in a leaf V which has to intersect C_1 as well. See example in Figure 18, a, where F is contained in the component of $\widetilde{M} - Y$ which does contains C_1 . This implies that η is contained in C_1 . But then η does not intersect U , contradiction. We conclude that Case 1 cannot happen.

The analysis of Case 1 highlights how the adjacent pair of lozenges C_1, C_2 traps the basic block \mathcal{B} in the case of \mathcal{B} being a lozenge. A similar situation happens more generally.

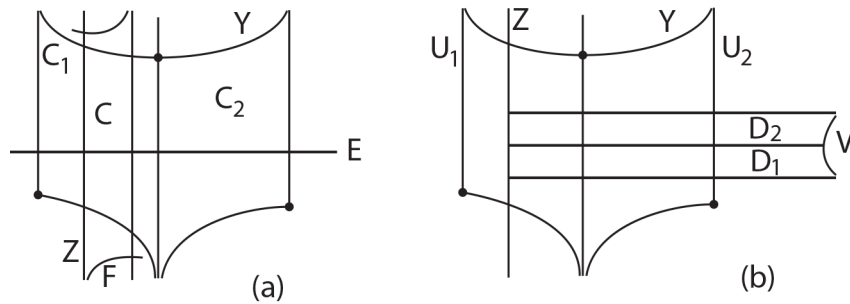

FIGURE 18. a. Case when \mathcal{B} is a single lozenge, b. Case when \mathcal{B} is an unstable adjacent block.

Case 2 - \mathcal{B} is an unstable adjacent block.

If the element of \mathcal{B} containing η is a lozenge, the proof of Case 1 shows that V has to intersect C_1 , hence as in Case 1, η does not intersect U , contrary to assumption. If the element of \mathcal{B} containing η is an (1, 3) ideal quadrilateral, then

there is a pair of adjacent $(1, 3)$ quadrilaterals D_1, D_2 in \mathcal{B} intersecting a common unstable leaf. In this case either the full leaf V is contained in $\partial(D_1 \cup D_2)$ or the full leaf V is contained in $\partial(D_1 \cup D_2)$. Suppose first that the full leaf Z is contained in $\partial(D_1 \cup D_2)$. Then V intersects C_1 , and so η does not intersect U , again a contradiction.

Suppose now that V is contained in $\partial(D_1 \cup D_2)$. The only possibility is that V is contained in the component of $\widetilde{M} - U_2$ that does not contain U , see Figure 18, b. In this case we do not yet obtain a contradiction, this is because it allows η to intersect C_2 . But recall that the basic block has an odd number of elements and one element in the end is a lozenge. As long as there are adjacent $(1, 3)$ ideal quadrilaterals, one unstable side is contained in Z and the other unstable side is a leaf non separated from V and contained in the component of $\widetilde{M} - U_2$ not containing U . Eventually one arrives at the lozenge in the end of the basic block, call this lozenge C . It has one unstable side contained in the leaf Z and the other unstable side contained in a leaf non separated from V . Let S be the other stable leaf with a side in C . Then S makes a perfect fit with Z . If S is contained in the component of $\widetilde{M} - Y$ not containing U_1 then this is disallowed as in Configuration 1 analysis. If S is contained in the component of $\widetilde{M} - Y_1$ not containing U_2 this is disallowed as in the analysis of Configuration 0.

This finishes the proof of Case 2.

Case 3 - \mathcal{B} is a stable adjacent block.

Suppose that the “first” element of \mathcal{B} (the one which has an unstable side contained in Z) is a lozenge C . then it has one unstable side contained in Z . The proof of Case 1 shows that the other unstable side is contained in a leaf V_1 which intersects C_1 . A pair of adjacent $(1, 3)$ quadrilaterals which have one side in V_1 will have the other unstable half leaf in the boundary (call it V_2) also intersecting C_1 . By induction the final unstable leaf in the boundary of elements in \mathcal{B} also intersects C_1 . This contradicts the fact that η intersects C_2 .

Suppose now that the first element is a $(1, 3)$ ideal quadrilateral. It is in a pair of $(1, 3)$ ideal quadrilaterals, where all unstable sides intersect C_1 . This keeps on happening, and also with the final lozenge. Again we conclude that the final unstable side intersects C_1 , contradicting that η intersects C_2 . This shows that Case 3 cannot happen either.

This finishes the proof of Lemma 6.9. □

Completion of the proof of Theorem 6.8.

The previous lemma shows that S does not intersect leaves of $\widetilde{\mathcal{L}}$ transversely. The projection $\pi(S)$ of S is a subannulus of $\pi(U)$, see Figure 19, a. We need to understand this subannulus better. The surface S is the union of ℓ_E where E runs through all stable leaves intersecting both U_1, U_2 . Each ℓ_E is a negative ray in a flow line in U . All negative rays in U are asymptotic. Recall that $\alpha = U \cap Y$ is periodic, invariant under γ . It follows that $\pi(\alpha)$ is a periodic orbit, contained in the annulus $\pi(U)$. The projections $\pi(\ell_E)$ are all asymptotic to $\pi(\alpha)$. On the other end of ℓ_E we have the point x_E and the collection of these is a continuous curve, also invariant by γ . Hence it projects to a simple closed curve δ in $\pi(U)$.

As a conclusion we obtain that $\pi(S)$ is a half open annulus with compact closure in $\pi(U)$ with a boundary component δ contained in $\pi(S)$ and the other boundary component $\pi(\alpha)$ disjoint from $\pi(S)$.

We proved in Lemma 6.9 that S does not intersect any wall transversely, and so $\pi(S)$ does not intersect any projection of a wall transversely. Since $\pi(\alpha)$ is

in the boundary of $\pi(S)$ it now follows that $\pi(\alpha)$ does not intersect any wall transversely.

This is the important property we want. Lifting to \widetilde{M} it follows that α does not intersect any wall in $\widetilde{\mathcal{L}}$ transversely.

Consider the situation in $Y = \widetilde{\Lambda}^s(\alpha)$. Then Y intersects $\widetilde{\mathcal{L}}$ and the complementary regions of $\widetilde{\mathcal{L}} \cap Y$ are finite sided ideal polygons. Since α does not intersect $\widetilde{\mathcal{L}} \cap Y$ transversely then either α is a leaf of $\widetilde{\mathcal{L}} \cap Y$ or α is a diagonal in a complementary region of $\widetilde{\mathcal{L}} \cap Y$. We analyze each case separately, showing that each case is impossible. Notice that $\alpha, Y, \widetilde{\mathcal{L}} \cap Y$ are all invariant under the non trivial deck transformation γ .

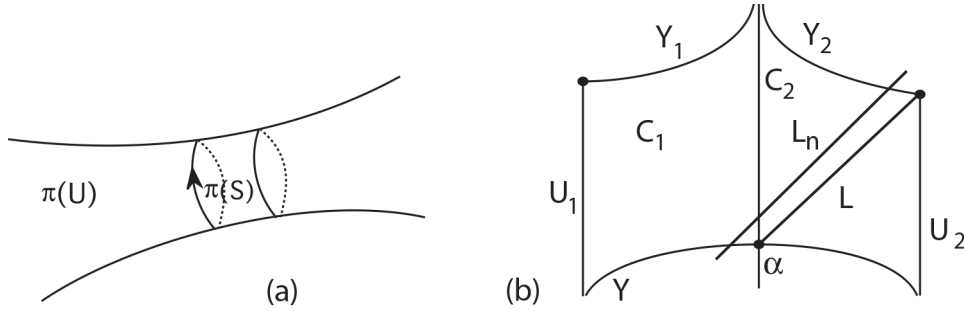

FIGURE 19. a. The unstable leaf $\pi(U)$ and the annulus $\pi(S)$ with compact closure in $\pi(U)$, b. Walls L_n converging to wall L .

Situation 1 – There is a complementary region B of $\widetilde{\mathcal{L}} \cap Y$ so that α is either a boundary component of B or α is a diagonal of B .

In either case since $\gamma(\alpha) = \alpha$ and $\gamma(\widetilde{\mathcal{L}} \cap Y) = \widetilde{\mathcal{L}} \cap Y$, it follows that $\gamma(B) = B$. But this is impossible since γ has only two fixed points in $S^1(Y)$, but B has at least 3 ideal points. All ideal points of B need to be fixed. We conclude that this situation cannot happen.

Situation 2 – α is a leaf of $\widetilde{\mathcal{L}} \cap Y$ which is not isolated on both sides.

Let $G \in \widetilde{\mathcal{L}}$ be the wall containing α , and let \mathcal{H} be the bi-infinite block associated with G . Since α and hence G is not isolated on both sides, there are sequences of walls L_n, G_n in $\widetilde{\mathcal{L}}$ so that L_n, G_n converge to G , and G separates L_n from G_m for any n, m .

Recall that α is periodic, and since $\alpha \subset G$, α is a corner orbit of G . Lemma 5.3 implies that all the corner orbits of \mathcal{H} are periodic and all elements of \mathcal{H} are lozenges. We consider the two elements of \mathcal{H} with a corner α . If these two lozenges are C_1, C_2 then there is a basic block of \mathcal{H} containing both of them, and this basic block is a stable adjacent block. But since it is a stable adjacent block, then the only corner orbits of the basic block of \mathcal{H} which are corners of G are the pivots of the basic block, and α could not be a corner orbit of G , contradiction. The same proof disallows the case that none of the elements of \mathcal{H} with a corner in α are C_1 or C_2 . It follows that one and only of C_1, C_2 is an element of \mathcal{H} . In particular α is a pivot of G .

Without loss of generality we assume that this element of \mathcal{H} is C_2 . We refer to Figure 19, b. Up to switching L_n with G_n assume that L_n intersects $Y = \widetilde{\Lambda}^s(\alpha)$ in the boundary of C_1 for n big enough, see Figure 19, b. As L_n converges to L , then for n big enough L_n intersects both C_1 and C_2 .

We study the wall L_n . For n big, L_n intersects S , the subset of U described above. Fix one such n and let p in $L_n \cap S$. Then p is in a leaf E of $\tilde{\Lambda}^s$. Let $\eta = E \cap L_n$. Lemma 6.9 shows that η does not intersect S transversely, hence the direction of η at p is the direction of ℓ_E : in other words η is a flow line of $\tilde{\Phi}$, rather than being transverse to the foliation by flow lines in E . It follows that η is a corner orbit of L_n . Notice that p is in η and p is in U , hence η is an orbit in $U = \tilde{\Lambda}^u(\alpha)$.

Recall that we assumed that n is big enough so that L_n intersects Y in the half leaf defined by α and contained in the boundary of C_1 . Let \mathcal{E} be the bi-infinite block associated with L_n .

First notice that η is a pivot of \mathcal{E} . The reason is that L_n intersects both C_1, C_2 so if there were adjacent elements of \mathcal{E} at η , the basic block of \mathcal{E} would be a stable adjacent block, and η would not be a corner.

This leads to a contradiction as follows: since η is a pivot, then at least one of the two elements of \mathcal{E} with a corner at η is contained in a quadrant at η that intersects the leaf Y (these quadrants do not intersect Y_1 or Y_2). In one of these quadrants Y makes a perfect fit with U_1 , and in the other quadrant Y makes a perfect fit with U_2 . In addition $\tilde{\Lambda}^s(\eta)$ intersects both U_1, U_2 , and $\tilde{\Lambda}^u(\eta)$ intersects Y . The analysis of Configuration 0 now shows that this situation is impossible. This uses that η is a pivot of L_n .

The contradiction is derived from assuming that Λ^s is not \mathbb{R} -covered. We conclude that in this case Λ^s is \mathbb{R} -covered and hence Φ is \mathbb{R} -covered.

This finishes the analysis of the Main theorem in the case that there is a wall L and for any γ in $\pi_1(M)$ $\gamma(L)$ does not intersect L transversely, and finishes the proof of Theorem 6.8. \square

7. THE CASE OF TRANSVERSE INTERSECTIONS

New assumption – From now on in the proof of the Main Theorem we assume that for any wall L obtained by our limiting process there is a deck transformation γ so that $\gamma(L)$ intersects L transversely.

We will prove that the bi-infinite blocks \mathcal{C} of L and \mathcal{E} of $\gamma(L)$ are linked. A very common possibility is that both \mathcal{C} and \mathcal{E} are bi-infinite strings of lozenges which are interlocked as in Figure 20. But a priori there are more complicated possibilities with adjacent blocks with $(1, 3)$ ideal quadrilaterals.

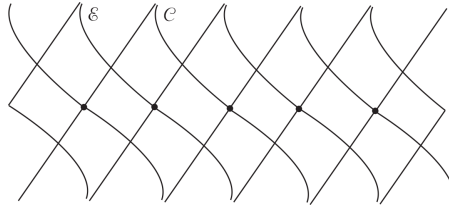

FIGURE 20. Interlocked strings of lozenges \mathcal{C}, \mathcal{E} .

Proposition 7.1. (*linking*) *Assume that M is atoroidal and Λ^s, Λ^u are transversely orientable. Let L be a wall with associated bi-infinite block \mathcal{C} and γ in $\pi_1(M)$ so that $\gamma(L)$ intersects L transversely at some point. Let \mathcal{E} be the bi-infinite block of $\gamma(L)$. Then \mathcal{C}, \mathcal{E} intersect the same set of stable leaves and the same set of unstable leaves. Any corner orbit of L is contained in the interior of a basic block of \mathcal{E} and vice versa. Finally for every leaf F intersected by L , then $L \cap F, \gamma(L) \cap F$ are geodesics in F which intersect transversely.*

Proof. Let \mathcal{X}_0 be the set of stable leaves intersecting L and \mathcal{X}_1 the corresponding set for $\gamma(L)$. Both are properly embedded copies of \mathbb{R} in the stable leaf space. The main property we want to prove is that $\mathcal{X}_0 = \mathcal{X}_1$. Let v be a point of transverse intersection of L and $\gamma(L)$, and let $E = \tilde{\Lambda}^s(v)$, hence v is a point in both geodesics

$$g_1 = L \cap E, \quad \text{and} \quad g_2 = \gamma(L) \cap E.$$

Clearly the set of stable leaves where $L, \gamma(L)$ intersect transversely is open. Also the set of orbits of $\tilde{\Phi}$ contained in $L, \gamma(L)$ is discrete. Hence we can assume that neither g_1, g_2 has an ideal point which is the positive ideal point of flow lines in E . Hence there are 4 distinct flow lines which have negative ideal points the ideal points of $g_1 \cup g_2$ in E . Let Z, U, W, V be the unstable leaves through these flow lines. We assume that Z, U, W, V are nested, that is, $Z \cap E, U \cap E, W \cap E$ and $V \cap E$ are nested flow lines in E . We assume that the negative ideal points of $U \cap E, V \cap E$ are the ideal points of $g_1 = L \cap E$ and the negative ideal points of $Z \cap E, W \cap E$ are the ideal points of $g_2 = \gamma(L) \cap E$.

Fix a component A of $\tilde{M} - E$. As long as a stable leaf F in A intersects all Z, U, W, V then $L, \gamma(L)$ intersect F and the ideal points of $L \cap F, \gamma(L) \cap F$ are the negative ideal points of $L \cap F$ and $\gamma(L) \cap F$ and they are linked.

Hence there is a first leaf stable leaf E_0 in \mathcal{X}_0 which stops intersecting either U or V . Recall that E_0 still intersects one of them. The same happens for the pair Z, W and $\gamma(L)$. There is a first leaf E_1 in A , so that E_1 is in \mathcal{X}_1 , and E_1 intersects one of Z, W but not the other. There are two possibilities.

Case 1 – There are leaves $F \in \tilde{\Lambda}^s$ in A intersecting three of Z, U, W, V but not all four of them.

This is the simpler case. The leaf of Z, U, W, V not intersecting F has to be an end leaf, that is, either Z or V . Without loss of generality we assume it is V . Hence there is a first such leaf with this behavior, which is the leaf E_0 that we defined above. Notice that in this case E_0 is still in \mathcal{X}_1 and E_0 separates E from E_1 . We know that E_0 intersects U , and it follows that the intersection of L with E_0 is the orbit $U \cap E_0$.

The intersection of $\gamma(L)$ with E_0 is the geodesic with ideal points which are the negative ideal points of $Z \cap E_0$ and $W \cap E_0$. But the pair of ideal points of the flow line $U \cap E_0$ (both positive and negative) link with the negative ideal points of $Z \cap E_0, W \cap E_0$. This is because Z, U, W, V are nested. Hence $\gamma(L) \cap E_0$ intersects $L \cap E_0$ transversely and $L \cap E_0$ is a corner of L . The leaves of $\tilde{\Lambda}^s \cap L$ which are tangent to the flow lines of $\tilde{\Phi}$ form a discrete set of leaves. It follows that $\mathcal{X}_0, \mathcal{X}_1$ contain an open interval I of stable leaves with E_0 in the interior and there is F in I with $F \cap L, F \cap \gamma(L)$ intersecting transversely, both not flow lines of $\tilde{\Phi}$, and E_0 separating F from E . In this case we can restart the analysis with F instead of E . The leaves Z, U, W will remain the same, but V will be replaced by another leaf.

This case is what we want to show always happens: if the intersection of (say) L with stable leaves becomes a flow line in a stable leaf G then G still intersects $\gamma(L)$ and $G \cap \gamma(L)$ intersects $G \cap L$ transversely. The other case to consider is:

Case 2 – For any stable leaf F in that component of $\tilde{M} - E$, then all four Z, U, W, V intersect F or at most two of them intersect F .

This happens when the stable leaves stop intersecting one of U, V at the same time they stop intersecting one of Z, W . It follows that there are two possibilities here: either $E_0 = E_1$ or they are distinct but non separated from each other.

Case 2.1 – E_0, E_1 are distinct but non separated.

In this case E_0 is in \mathcal{X}_0 but not in \mathcal{X}_1 , since E_1 is in \mathcal{X}_1 , and E_0, E_1 are distinct and non separated. Also E_0 intersects one of U, V but not the other, and E_1 intersects one of Z, W but not the other.

Put a transverse orientation to $\tilde{\Lambda}^s$ so that E_1 is on the positive side of E . Put a transverse orientation to $\tilde{\Lambda}^u$ so that U is on the positive side of Z . Let T_0 be the one of U, V which is intersected by E_0 , and T_1 the one of Z, W intersected by E_1 .

Suppose first that T_1 is on the positive side of T_0 . In this case T_0 cannot be V , since V is on the positive side of both W and Z , so T_0 has to be U and T_1 has to be W . Let $\alpha = E_0 \cap U$. By construction this is contained in L and it is a corner orbit of \mathcal{C} . Let \mathcal{R} be the basic block of \mathcal{C} which intersects E . In addition the leaf E_0 does not intersect all the unstable leaves that the basic block \mathcal{R} intersects – this is because E_1 contains part of the boundary of \mathcal{R} and so there are unstable leaves intersecting E_1 which intersect \mathcal{R} and these unstable leaves do not intersect E_0 . See Figure 21, a.

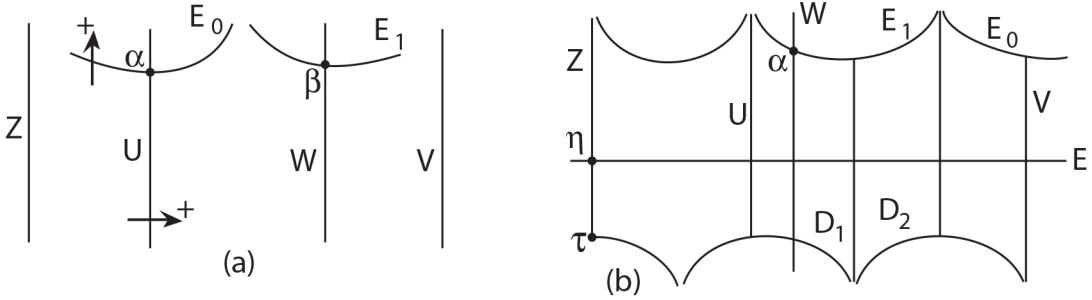

FIGURE 21. a. The figure when T_1 is on the positive side of T_0 , the arrows indicate the positive transversal orientation; b) The case that T_1 is on the negative side of T_0 .

It follows that α is a pivot of L and \mathcal{C} . This is because E_1 intersects the boundary of \mathcal{R} . Hence \mathcal{R} is a stable adjacent block and α is a pivot. In the same way $\beta := E_1 \cap W$ is a pivot of $\gamma(L)$. This is a contradiction to γ preserving orientation: in L when one moves positively transverse to $\tilde{\Lambda}^s$, that is, from E to E_0 , then eventually one moves negatively transverse to $\tilde{\Lambda}^u$. The last fact occurs when L crosses the pivot α , in the direction from E to E_0 . In terms of unstable leaves, L moves from intersecting W to not intersecting W , but intersecting E_0 , that is, in the negative direction. Since α is a pivot, it determines the global direction of moving transversely to the unstable foliation.

In $\gamma(L)$ when one moves positively transversely to $\tilde{\Lambda}^s$ one moves positively transversely to $\tilde{\Lambda}^u$: that is from U to W . By assumption all deck transformations of $\pi_1(M)$ preserve transversal orientations, hence this is a contradiction. This contradiction shows that this case cannot happen.

The other possible situation is that T_1 is in the negative side of T_0 . There are two possibilities here. Suppose first that E_1 intersects W . This forces E_0 to

intersect V . We refer to Figure 21, b. Notice that Z makes a perfect fit with a stable leaf non separated from E_0 , and U makes a perfect fit with a stable leaf non separated from E_1 (which is also non separated from E_0). The figure displays the simplest situation. The full leaf E_1 is contained in $\partial(D_1 \cup D_2)$, where D_1, D_2 are adjacent lozenges intersecting a common stable leaf (an example is the leaf E).

We want to prove that $\alpha := W \cap E_1$ is the periodic orbit in E_1 . Suppose it is not. Let \mathcal{B} be the basic block of \mathcal{E} intersecting E . This block has half leaves of Z and W contained in its boundary. The properties above imply there is a stable leaf S making a perfect fit with Z and entirely contained in $\partial\mathcal{R}$. It follows that \mathcal{B} is a stable adjacent block with more than one element. There is a half leaf of E_1 contained in the boundary of the region \mathcal{B} , and also a half leaf of W in this boundary. It follows that α is a pivot of \mathcal{B} . The other corner η of \mathcal{B} is in Z . Let τ be the periodic orbit in Z . By assumption α is not periodic. Then either 1) $\tilde{\Lambda}^s(\eta)$ intersects $\tilde{\Lambda}^u(\alpha)$ producing a corner of \mathcal{B} in $\tilde{\Lambda}^u(\alpha)$ besides α – a contradiction; or 2) $\tilde{\Lambda}^s(\tau)$ separates $\tilde{\Lambda}^s(\eta)$ from a stable leaf in the boundary of \mathcal{B} which makes a perfect fit with $\tilde{\Lambda}^u(\alpha)$ – also a contradiction.

We conclude that α is the periodic orbit in E_1 . It follows that all corners of \mathcal{E} are periodic and hence so are the corners of \mathcal{C} . Notice that E_0, E_1 are non separated from each other. Hence there is a non trivial deck transformation ζ leaving both E_0, E_1 invariant. In addition the corners of \mathcal{E} are connected to the corners of \mathcal{C} by chain of lozenges. In other words α and $\gamma(\alpha)$ are connected by a chain of lozenges. As in the proof of Proposition 5.8 this implies that γ, ζ generate a \mathbf{Z}^2 subgroup of $\pi_1(M)$. This is impossible, since M is atoroidal. This shows this case cannot happen.

In the same way one rules out the case that E_0 intersects U by switching the roles of L and $\gamma(L)$.

The next possibility in this case is that E_1 intersects Z and E_0 intersects U . This case is exactly the same as the previous one by switching L with $\gamma(L)$.

Finally the remaining possibility in this case is that E_1 intersects Z and E_0 intersects V . Then an analysis as in the situation that T_1 is in the positive side of T_0 of this Case 2.1, shows that $E_1 \cap Z$ is a pivot of $\gamma(L)$ and $E_0 \cap V$ is a pivot of L . As in that analysis this leads to the contradiction that γ preserves all orientations in \tilde{M} . This shows that this case cannot happen.

Case 2.2 – $E_0 = E_1$.

Given that E_0 intersects one of U, V but not both, and one of Z, W but not both there are two possibilities: i) E_0 intersects U and W , but does not intersect either of Z or V . ii) E_0 intersects both Z, U but not none of W, V ; or E_0 intersects both W, V , but none of Z, U .

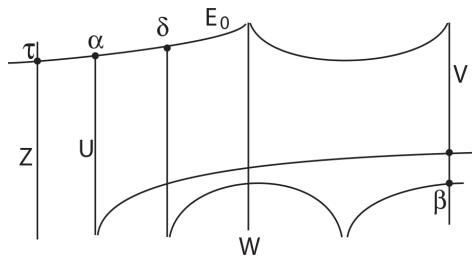

FIGURE 22. The depiction of the leaves in Case 2.2.

We deal with possibility ii) First. Up to switching L with $\gamma(L)$ assume that E_0 intersects both Z, U , but does not intersect either of W, V . We depict this in Figure 22. The argument will be very similar to one in Situation 2 of Lemma 6.5 producing two different walls with a common corner orbit, which is a contradiction. Hence we will only review the main points. The intersections $\alpha := L \cap E_0$, $\tau := \gamma(L) \cap E_0$ are both tangent to the flow and hence orbits of $\tilde{\Phi}$. The leaf V makes a perfect fit with a stable leaf which is distinct from E_0 , but non separated from E_0 . It follows that E_0, W, V are all periodic, and left invariant by a non trivial deck transformation ζ . Let δ be the periodic orbit of $\tilde{\Phi}$ in E_0 and β the periodic orbit in V . We assume ζ acts pushing points backwards in δ . The basic block of \mathcal{C} intersecting E is necessarily a stable adjacent block with α one corner orbit. Either $\alpha = \delta$ and the other corner of this basic block is β or the other corner orbit is an orbit in V . In any case $\zeta^n(L)$ converges (as $n \rightarrow \infty$) to a wall L_0 which has both δ and β as corner orbits. These are the only corner orbits in this stable adjacent block. Now apply ζ^n to $\gamma(L)$. Then $\zeta^n(\tau)$ also converges to δ , so $\zeta^n(\gamma(L))$ converges to a wall L_1 with δ as a corner orbit as well. Either $\gamma(L)$ does not intersect W and hence L_1 does not intersect V , or $\gamma(L)$ intersects W in an orbit, and then L_1 intersects W in the periodic orbit of W . In either case L_0, L_1 are distinct walls. This contradicts the result of Proposition 5.8.

Finally suppose that E_0 intersects both U, W , but none of Z, V . Hence Z makes a perfect fit with a stable leaf non separated from E_0 (could be E_0 itself). The same happens for V . This is very similar to Situation 1 in Lemma 6.5. It follows that Z, V, E_0 are all periodic, left invariant by a non trivial deck transformation ζ , which we assume is a generator of the stabilizer of this set of leaves. In addition let δ be the periodic orbit in E_0 , and assume that ζ acts pushing points backwards in δ . Applying ζ^n one obtains that $\zeta^n(L)$, $\zeta^n(\gamma(L))$ converge to distinct walls L_0, L_1 both containing δ – as in Situation 1 of Lemma 6.5. This is a contradiction and shows that this cannot happen.

From this analysis we conclude that Case 2 cannot happen, and therefore Case 1 happens always. It follows that $\mathcal{X}_0 = \mathcal{X}_1$. Hence $L, \gamma(L)$ intersect the same set of stable leaves. Let \mathcal{Z}_0 (resp. \mathcal{Z}_1) be the set of unstable leaves intersected by L (resp. $\gamma(L)$). The arguments show that for any E intersected by L then $E \cap L$, $E \cap \gamma(L)$ are transverse geodesics in E . Hence any corner orbit ν of $\gamma(L)$ intersects a basic block of \mathcal{C} . Therefore $\tilde{\Lambda}^u(\nu)$ is in \mathcal{Z}_0 . This implies that $\mathcal{Z}_1 \subset \mathcal{Z}_0$. Switching the roles of $L, \gamma(L)$ it follows that $\mathcal{Z}_0 \subset \mathcal{Z}_1$.

This finishes the proof of Proposition 7.1. \square

8. THE CONVEX HULL

Next we introduce the set \mathcal{V} which will be a form of a convex hull associated with a collection of walls which intersect transversely. Fix a wall L . By our standing assumption there is γ in $\pi_1(M)$ so that $L, \gamma(L)$ intersect transversely at some point. Let

$$\mathcal{P} = \{ \gamma \in \pi_1(M), \text{ so there are } \gamma_0 = id, \gamma_1, \dots, \gamma_n = \gamma, \}$$

and $\gamma_i(L), \gamma_{i-1}(L)$ are either equal or intersect transversely for all $1 \leq i \leq n$

Let also

$$\mathcal{G} = \{ \gamma(L), \text{ so that } \gamma \in \mathcal{P} \}$$

First we establish a basic lemma:

Lemma 8.1. *For any γ in \mathcal{P} , the walls $L, \gamma(L)$ intersect exactly the same set of leaves of $\tilde{\Lambda}^s$ and $\tilde{\Lambda}^u$.*

Proof. Let γ in \mathcal{P} and $\gamma_0 = id, \gamma_1, \dots, \gamma_n = \gamma$ so that $\gamma_{i-1}(L), \gamma_i(L)$ intersect transversely. By Proposition 7.1 for any i , the walls $\gamma_i(L), \gamma_{i-1}(L)$ are linked and intersect exactly the same set of stable and unstable leaves. The lemma follows by induction. \square

Strategy for the completion of the proof of the Main theorem.

By the previous lemma any wall in \mathcal{G} intersects exactly the same set of stable leaves, and this set is homeomorphic to a properly embedded copy of the reals in the stable leaf space. The goal is to show that this is all of the leaf space of $\tilde{\Lambda}^s$ – which immediately implies that Λ^s is \mathbb{R} -covered and finishes the proof of the Main theorem.

To prove this property we introduce the convex hull \mathcal{V} of \mathcal{G} as follows.

Let E be a leaf of $\tilde{\Lambda}^s$ intersecting some wall in \mathcal{G} . Hence there is β in \mathcal{P} so that E intersects $\beta(L)$. By the lemma for any γ in \mathcal{P} then E intersects $\gamma(L)$. We first define the convex hull in E . Let

$$\mathcal{V}_E = \{ \text{convex hull in } E \text{ of the union of } E \cap \gamma(L), \gamma \in \mathcal{P} \}$$

Finally let

$$\mathcal{V} = \bigcup \{ \mathcal{V}_E, E \in \tilde{\Lambda}^s, E \cap \gamma(L) \neq \emptyset, \text{ for } \gamma \in \mathcal{P} \}$$

The leaf L is fixed throughout the discussion.

Definition 8.2. (convex hull of L) The set \mathcal{V} is called the *convex hull of L* .

Our goal is to show that under the New assumption of Section 7 the set \mathcal{V} is all of \tilde{M} and hence Λ^s is \mathbb{R} -covered. In fact we will show that if \mathcal{V} is not all of \tilde{M} , then the New assumption fails and we can use the previous analysis.

Remark 8.3. Notice that \mathcal{V}_E is open for any E . Otherwise for some E , \mathcal{V}_E is not open, but since it is convex, it follows that some boundary geodesic ℓ of \mathcal{V}_E is contained in \mathcal{V}_E . This can only occur if ℓ is $\gamma(L) \cap E$ for some γ in $\pi_1(M)$. But by the condition on L , ℓ transversely intersects some $\beta(L) \cap E$. Hence ℓ would not be in the boundary of \mathcal{V}_E . Hence \mathcal{V}_E is open.

Definition 8.4. A set W in \tilde{M} is precisely invariant if for any β in $\pi_1(M)$ such that $\beta(W) \cap W$ is not empty then $\beta(W) = W$.

Lemma 8.5. *The set \mathcal{V} is precisely invariant.*

Proof. Let β in $\pi_1(M)$ so that $\beta(\mathcal{V}) \cap \mathcal{V} \neq \emptyset$, so there is x in the intersection. Let E be the stable leaf through $\beta^{-1}(x)$ – a point in \mathcal{V} as well. Hence $\beta^{-1}(x)$ is in $E \cap \mathcal{V}$. It follows that $\beta(E \cap \mathcal{V})$ intersects $\beta(E) \cap \mathcal{V}$.

Recall that $\mathcal{V} \cap E$ is the interior of the convex hull in E of the set of geodesics $\gamma(L) \cap E$, where $\gamma \in \mathcal{P}$. Similarly $\beta(E) \cap \mathcal{V}$ is the interior of the convex hull of $\alpha(L) \cap \beta(E)$ where $\alpha \in \mathcal{P}$. Since $\beta(E \cap \mathcal{V})$ intersects $\beta(E) \cap \mathcal{V}$, it follows that there are $\gamma \in \mathcal{P}, \alpha \in \mathcal{P}$ so that either $\beta\gamma(L)$ intersects $\alpha(L)$ transversely.

\mathcal{G} is the set of deck translates of L so that there is a finite sequence of deck translates of L starting with L , and consecutive ones are either equal or intersect transversely. Hence β sends some element $\gamma(L)$ of \mathcal{G} to an element of \mathcal{G} .

Let now $\delta(L)$ be a generic element of \mathcal{G} . Either $\delta(L) = L$ or there is a sequence of deck translates of L from $\gamma(L)$ to $\delta(L)$, so consecutive ones intersect transversely. Just take the inverse of a sequence from L to $\gamma(L)$, and then a sequence from L to $\delta(L)$. Applying β one gets a sequence of consecutively transverse translates from $\beta\gamma(L)$ to $\beta\delta(L)$. Since $\beta\gamma(L)$ is either an $\alpha(L)$ or intersects an $\alpha(L)$ transversely, there is a sequence of consecutively transverse translates from L to $\beta\gamma(L)$. Again concatenating with $\beta\gamma(L)$ to $\beta\delta(L)$ one produces a sequence from L to $\beta\delta(L)$. Hence $\beta\delta(L)$ is in \mathcal{G} .

In particular $\beta(\mathcal{G})$ is a subset of \mathcal{G} . In the same way $\beta^{-1}(\mathcal{G})$ is also a subset of \mathcal{G} , and consequently $\beta(\mathcal{G}) = \mathcal{G}$. Since \mathcal{V} is obtained by taking the interior of the convex hull of $\eta(L) \cap E$ with $\eta(L)$ in \mathcal{G} , it follows that $\beta(\mathcal{V}) = \mathcal{V}$.

This proves the Lemma 5.5. \square

A quick consequence is:

Corollary 8.6. *The subset \mathcal{P} of $\pi_1(M)$ is a subgroup of $\pi_1(M)$.*

Proof. Clearly we use the previous lemma. Let β in \mathcal{P} . Then $\beta(L) \in \mathcal{G}$, hence $\beta(\mathcal{V}) \cap \mathcal{V} \neq \emptyset$. By the lemma $\beta(\mathcal{V}) = \mathcal{V}$, which then implies that $\beta(\mathcal{P}) = \mathcal{P}$. Hence \mathcal{P} is closed under multiplication. The above also implies that $\beta^{-1}(\mathcal{P}) = \mathcal{P}$ so \mathcal{P} is also closed under taking inverses, and \mathcal{P} is a subgroup of $\pi_1(M)$. \square

We now prove a further property:

Lemma 8.7. *The set \mathcal{V} is open.*

Proof. Let p in \mathcal{V} . Then p is in a leaf E of $\tilde{\Lambda}^s$. There are finitely many $\gamma_1, \dots, \gamma_k$ in \mathcal{P} so that p is in the interior of the convex hull c_E in E of

$$\bigcup_{i=1}^k (\gamma_i(L) \cap E)$$

There is $\epsilon > 0$ so that a disk of radius 2ϵ centered at p is contained in the interior (in E) of c_E . Let

$$g_i = \gamma_i(L) \cap E, \quad 1 \leq i \leq k$$

Let $\tau = c(t)$, $-1 < t < 1$ be an open transversal to $\tilde{\Lambda}^s$ with $c(0) = p$. Let E_t be the stable leaf through $\tau(t)$. By reducing τ if necessary, assume it only intersects leaves of $\tilde{\Lambda}^s$ which intersect L (hence intersect $\gamma(L)$ for any γ in \mathcal{P}).

By the properties of walls, for any $1 \leq i \leq k$ and if $t \rightarrow 0$, then $\gamma_i(L) \cap E_t$ converges to g_i in \tilde{M} as $t \rightarrow 0$. Therefore for t sufficiently small the interior of the convex hull of

$$\bigcup_{i=1}^k (\gamma_i(L) \cap E_t)$$

contains an ϵ disk in E_t centered at $c(t)$. This shows that \mathcal{V} contains an open set in \tilde{M} containing p . Hence \mathcal{V} is open as desired. \square

9. BOUNDARY COMPONENTS OF \mathcal{V}

As mentioned before we eventually want to show that $\mathcal{V} = \widetilde{M}$. The proof is by contradiction. We assume that $\mathcal{V} \neq \widetilde{M}$ and eventually prove that the New assumption fails. We first analyze properties of boundary components of \mathcal{V} .

Let \mathcal{H}_0 be the subset of the leaf space \mathcal{H} of $\widetilde{\Lambda}^s$ which is the set of stable leaves intersecting the wall L . Recall that \mathcal{H}_0 is a properly embedded copy of \mathbb{R} in \mathcal{H} . First we prove the following very useful result:

Lemma 9.1. *Let L be an arbitrary wall in $\widetilde{\mathcal{L}}$. Let η be an intersection of L with a leaf E of $\widetilde{\Lambda}^s$. Suppose that one ideal point of η is the negative ideal point of $U \cap E$, where U is a leaf in $\widetilde{\Lambda}^u$. Then every leaf G of $\widetilde{\Lambda}^s$ that intersects U , also intersects L . In other words if U is an unstable leaf which is part of the boundary of some element in the bi-infinite block associated with L , then every stable leaf intersecting U intersects L .*

Proof. Let \mathcal{C} be the bi-infinite block associated with L . Clearly the set of stable leaves which intersects both L and U is an open set. So we may assume that both ideal points of η are negative ideal points in the stable leaf containing it. Let C be the element of \mathcal{C} containing η . Parametrize the stable leaves intersecting U as $E_t, t \in \mathbb{R}$, where $E_0 = E$. We will consider $t > 0$. As long as E_t intersects C then E_t intersects U and E_t also intersects L . The first possibility is that this happens for all $t > 0$ and we get that any stable leaf intersecting U in that component of $\widetilde{M} - E$ also intersects L .

Otherwise there is a smallest $t_0 > 0$ so that E_{t_0} does not intersect C . Notice that E_{t_0} intersects U . This can only happen if $E_{t_0} \cap U = \beta$ is a corner of C . Consider the next element D of \mathcal{C} which also has a corner β . It could be that β is not a pivot, hence C, D are adjacent along a stable leaf (which is $\widetilde{\Lambda}^s(\beta)$). In that case for any $t > t_0$ sufficiently close to t_0 then E_t intersects D , and hence L , and $L \cap E_t = \eta'$ has an ideal point which is the negative ideal point of $E_t \cap U$. In this case we restart the analysis with the element D of \mathcal{C} instead of C . Otherwise β is a pivot. But the same conclusion happens.

The leaf U can intersect at most one pivot, and the number of corners in U until hitting a pivot is bounded. This implies the result of the lemma. \square

Notice that the result only holds for those U which are part of boundary of the elements of \mathcal{C} . For an unstable leaf Z intersecting the interior of one of those elements, the result is most likely not true.

Proposition 9.2. *Let W be a boundary component of \mathcal{V} , then W is a properly embedded plane transverse to $\widetilde{\Lambda}^s$. In addition the leaf space of $\widetilde{\Lambda}^s \cap W$ is the reals.*

Proof. This result is reminiscent of Lemma 3.9. But here we do not know a priori what are the ideal points of intersections of W with leaves of $\widetilde{\Lambda}^s$, in particular that they follow the negative ideal points of intersections of some fixed unstable leaves with varying stable leaves. This makes this proof more involved.

Let E be a leaf intersecting L so that $\mathcal{V} \cap E$ is not all of E . Let ℓ be a boundary component of $\mathcal{V} \cap E$. Fix a transversal $\tau = \{c(t), -\epsilon < t < \epsilon\}$ to $\widetilde{\Lambda}^s$ with $c(0)$ in ℓ . Let E_t be the leaf of $\widetilde{\Lambda}^s$ containing $c(t)$. If necessary, shorten τ so that all leaves E_t intersect L . The geodesic ℓ in E has ideal points p, q in $S^1(E)$.

Case 1 – Suppose first that neither p nor q is the positive ideal point of the flow lines in E .

Then for any $|t|$ sufficiently small E_t is asymptotic to ℓ in both directions (ℓ is contained in $E_0 = E$), and $S^1(E_t)$ has corresponding ideal points p_t, q_t . Let ℓ_t

be the geodesic in E_t with ideal points p_t, q_t . We claim that ℓ_t is contained in the boundary of \mathcal{V} as well for $|t|$ sufficiently small. In particular we show that ℓ_t is contained in the same component of the boundary that contains ℓ .

There is a single ideal point in E which is the forward ideal point of all flow lines. Let I be the complementary component of $\{p, q\}$ in $S^1(E)$ which does not contain any ideal point of $\gamma(L) \cap E$ where γ is in \mathcal{P} . Let I_t be the open interval in $S^1(E_t)$ with ideal points p_t, q_t and I_t close to I in the local trivialization of circles at infinity. Suppose first that the positive ideal point of all flow lines in E is not in I .

Now for any $\gamma \in \mathcal{P}$ it follows that $\gamma(L) \cap E_t$ is contained in the component of $E_t - \ell_t$ on the same side that $\gamma(L) \cap E$ is relative to ℓ . The reason is as follows: if $\gamma(L) \cap E_t$ had an ideal point in I_t then E_t is asymptotic to E in that direction. Since $\gamma(L)$ is a wall, this can only happen if $\gamma(L) \cap E$ is asymptotic to $\gamma(L) \cap E_t$. In other words $\gamma(L) \cap E$ has an ideal point in I , contradiction. Hence $\mathcal{V} \cap E_t$ is contained in the corresponding component of $E_t - \ell_t$.

Finally we show that ℓ_t is in the closure of $\mathcal{V} \cap E_t$. Suppose first that there is γ in \mathcal{P} with say p being an ideal point of $\gamma(L) \cap E$ – this is forcibly a negative ideal point in E . Then $\gamma(L) \cap E_t$ also has ideal point p_t . Similarly for q_t . Otherwise there is a sequence $\alpha_i \in \mathcal{P}$ with $\alpha_i(L) \cap E$ having ideal points converging to p . Then $\alpha_i(L) \cap E_t$ also has ideal points converging to p_t .

In any case there is $\epsilon > 0$ so that for $|t| < \epsilon_0$, there are v_i converging to p_t in $E_t \cup S^1(E_t)$ with v_i in $\mathcal{V} \cap E_t$ and u_i converging to q_t with u_i in $\mathcal{V} \cap E_t$. The geodesic arc from v_i to u_i in E_t is contained in $\mathcal{V} \cap E_t$ and converges to ℓ_t with i . This shows that ℓ_t is contained in the closure of \mathcal{V} so it is contained in the boundary of \mathcal{V} .

These arguments deal with the possibility that the forward ideal point of E is not in I . If the forward ideal point is in I , then we consider the other component Y of $S^1(E) - \{p, q\}$ and let J be a small open neighborhood of $Y \cup \partial Y$. Then all points in Y are negative ideal points, a similar proof as above shows the same result that ℓ_t is in the boundary of $\mathcal{V} \cap E_t$. In addition in Case 1 notice that ℓ_t and ℓ are a bounded distance apart in \widetilde{M} . Notice also that for any $|t_0| < \epsilon_0$ and $t \rightarrow t_0$, then ℓ_t converges to ℓ_{t_0} and only to ℓ_{t_0} .

Final property in Case 1 –

We note the following: let α_t be the flow line in E_t whose negative ideal point is p_t . The p_t correspond to directions in E_t which are asymptotic to ℓ in the direction of p . Hence all α_t are in the same unstable leaf U . Likewise for q_t .

This finishes the analysis of Case 1.

Case 2 – Suppose that (say) p is the forward ideal point of flow lines in E .

This case is more complex than Case 1. We recall the topology in $A = \cup\{S^1(E_t), -\epsilon < t < \epsilon\}$ (these E_t are exactly those intersecting τ). Fix t . For each x in $S^1(E_t)$ there is a unique geodesic ray starting at $\tau \cap E_t$ with ideal point x . This produces a bijection between A and $\cup\{T^1\widetilde{\Lambda}^s|_\tau\}$. This last set has a natural topology as an annulus and this is the topology we put in A .

The ideal points in $S^1(E)$ of ℓ bound a unique interval I which is disjoint from all ideal points of $\gamma(L) \cap E$ for $\gamma \in \mathcal{P}$. We first prove a simple claim:

Claim 9.3. *For any x in I there is no sequence x_i of ideal points of $\gamma_i(L) \cap E_{t_i}$ with $t_i \rightarrow 0$, $\gamma_i \in \mathcal{P}$ and x_i converging to x .*

Proof. Notice that $\gamma_i(L)$ intersects E for all i . Suppose by way of contradiction that there is such a sequence x_i . Since x is in I it is a negative ideal point in $S^1(E)$

– because p is the positive ideal point of E . Then x has an open neighborhood in $S^1(E)$ where all points correspond to directions asymptotic with E_t for all $|t| < \epsilon_1$, and for a fixed $\epsilon_1 > 0$. Using the trivialization above this implies that $\gamma_i(L) \cap E$ has ideal points in I for i big enough. This is a contradiction. This proves the claim. \square

By the claim there is a unique complementary region of $\mathcal{V} \cap E_t$ with ideal boundary an interval in $S^1(E_t)$ which contains an interval close to the interval I in the trivialization above. Let ℓ_t be the boundary of this complementary region of $\mathcal{V} \cap E_t$ with ideal points p_t, q_t .

We first show that $p_t \rightarrow p$ and $q_t \rightarrow q$ as $t \rightarrow 0$. Suppose by way of contradiction that there are $p_{t_i} \rightarrow z \neq p$ and $t_i \rightarrow 0$. For simplicity assume $t_i > 0$ for all i . There is $w \in [p, z)$ which is an ideal point of $\gamma(L) \cap E$ for some $\gamma \in \mathcal{P}$, since ℓ is the boundary of the complementary region associated with I . In Lemma 3.9 it was proved that ideal points $\gamma(L) \cap F$ in $S^1(F)$ vary continuously with $F \in \tilde{\Lambda}^s$ along an interval of leaves. So the corresponding ideal points of $\gamma(L) \cap E_{t_i}$ as $i \rightarrow \infty$ show that p_{t_i} cannot converge to z .

Now we show that ℓ_t converges to ℓ and only to ℓ . Since the ideal points of ℓ_t converge to the ideal points of ℓ , then the local trivialization of A and continuous change of hyperbolic metrics show that ℓ_t converges to ℓ .

Finally we prove that ℓ_t converges only to ℓ . This is much trickier. Let x_i in ℓ_{t_i} converging to x , and so that $t_i \rightarrow 0$. If x is in E , then the argument of Lemma 3.9 implies that x is in ℓ . Suppose that x is in F different from E . In particular F is non separated from E . Since x_i converges to x in F then up to subsequence we may assume that ℓ_{t_i} converges to a geodesic η in F . One of the ideal points of η , call it z is a negative ideal point in F .

We now consider a transversal τ' to $\tilde{\Lambda}^s$ through x in F , and parametrize the leaves of $\tilde{\Lambda}^s$ intersecting τ' as $F_t, -\epsilon \leq t \leq \epsilon$, with $F_0 = F$. Reducing τ, τ' and reparametrizing if necessary, we may assume that $F_t = E_t$ if $0 < t < \epsilon$. Notice again that F is non separated from E . Then put in $B = \cup\{S^1(F_t), -\epsilon < t < \epsilon\}$ the topology coming from $\cup\{T^1\tilde{\Lambda}^s|_{\tau'}\}$. Since z is a negative ideal point of F the following happens: z has a neighborhood in $S^1(F)$ consisting only of negative ideal points. In addition z it has a neighborhood N in B consisting only of negative ideal points and satisfying: there is $\epsilon_0 > 0$ so that for F_t with $|t| < \epsilon_0$ if y is an ideal point in $S^1(F_t)$ with y in N and U is the unstable leaf so that $U \cap F_t$ has negative ideal point y , then U intersects F_0 also.

In the local parametrization given by B the p_{t_i} converge to z (notice that this is in B and not in A , this is very different from the topology in A , since E, F are non separated from each other). Then the following happens: fix one i big enough so that p_{t_i} is in N (again we are considering τ' and B here). Then since ℓ_{t_i} is a boundary component of the convex hull \mathcal{V} in E_{t_i} (which is equal to F_{t_i} for i big) it follows that there is $\gamma \in \mathcal{P}$ so that $\gamma(L) \cap E_{t_i}$ has an ideal point in N . In particular there is U unstable leaf so that this ideal point of $\gamma(L) \cap E_{t_i}$ is the negative ideal point of $U \cap E_{t_i}$.

By the defining property of N , it follows that U intersects F . By Lemma 9.1 it follows that $\gamma(L)$ intersects F also.

This is a contradiction: $\gamma(L)$ intersects F and also intersects E . But E, F are non separated by different. This is impossible. and hence $\gamma(L) \cap E_{t_i}$ has a ray r contained in N_{t_i} . Since this ray

This shows that the only limits of ℓ_t are in ℓ . This finishes Case 2.

In addition since ℓ_t only converges to ℓ in both cases, it follows that the leaf space of $\tilde{\Lambda}^s \cap W$ is Hausdorff, and hence it is the reals.

This completes the proof of Proposition 9.2. \square

We also need the following result.

Lemma 9.4. *Suppose that M is atoroidal. Let W be an arbitrary component of $\partial\mathcal{V}$. Then the isotropy group of W is at most infinite cyclic.*

Proof. The proof is entirely two dimensional. Let A be the isotropy group of W . Then W/A is a surface. Suppose by way of contradiction that A is not cyclic. What we will prove is that this implies that W/A is a torus or a Klein bottle. Since W is properly embedded, this implies that W/A is π_1 -injective, so there is a \mathbb{Z}^2 subgroup of $\pi_1(M)$ which is a contradiction.

The group A acts on the leaf space of the foliation $\mathcal{G} := \tilde{\Lambda}^s \cap W$, which is homeomorphic to the reals \mathbb{R} as proved in Proposition 9.2. By assumption, A is not cyclic. If it is abelian, then since W/A is a surface it follows that $A \cong \mathbb{Z}^2$ and we are done.

Parametrize the leaf space of \mathcal{G} as $\{\ell_t, t \in \mathbb{R}\}$. If A is not abelian, then it does not act freely on the leaf space of \mathcal{G} , and let ρ in A non trivial with a fixed leaf of \mathcal{G} . We assume ρ indivisible, and up to changing the parametrization, assume that $\rho(\ell_0) = \ell_0$. Using that A is not cyclic, let μ in A which is not in the subgroup generated by ρ .

Let $t_0 = \sup\{t \in \mathbb{R}, \rho(\ell_t) = \ell_t\}$, where t_0 can attain the value ∞ . We claim that t_0 is ∞ . Suppose not. Since the leaf space of \mathcal{G} is \mathbb{R} it follows that $\rho(\ell_{t_0}) = \ell_{t_0}$. Let $s > t_0$. Then up to taking an inverse of ρ , it follows that $\rho^n(\ell_s) = \ell_{s_n}$ with s_n converging to t_0 as $n \rightarrow \infty$. This implies that in $W/\langle \rho \rangle$ the projection of the curve ρ_s spirals towards a closed curve $\ell_{t_0}/\langle \rho \rangle$. In particular it follows also that in W/A the projection of ρ_s is a non closed curve.

Up to taking an inverse of μ , assume that $\mu(\ell_{t_0}) = \ell_s$ with $s > t_0$. Then since $\mu(\ell_{t_0})$ is a deck translate of a curve that projects to a closed curve in W/A it follows that it also projects to a closed curve in W/A . But since $s > t_0$, we just proved that $\mu(\ell_{t_0})$ does not project to a closed curve in W/A . This contradiction shows that $t_0 = \infty$.

Again up to taking an inverse of μ assume that $\mu(\ell_0) = \ell_v$ with $v > 0$. The quotient $W/\langle \rho \rangle$ is an annulus. Let $t_1 > v$ so that $\rho(\ell_{t_1}) = \ell_{t_1}$. The projection of $\{\ell_t, 0 \leq t \leq t_1\}$ to $W/\langle \rho \rangle$ is a compact subannulus B of $W/\langle \rho \rangle$. The projection of $\mu(\ell_0) = \ell_v$ to this compact subannulus B of $W/\langle \rho \rangle$ is a closed curve – we already used this argument above. Now $\mu(\ell_0)$ and ℓ_0 project in W/A to the same closed curve. It follows that the projection of the region in W between ℓ_0 and $\mu(\ell_0)$ to W/A is a closed surface, and hence W/A is a closed surface. Since W/A has a one dimensional foliation \mathcal{G}/A it follows that W/A is either a torus or a Klein bottle. This finishes the proof of Lemma 9.4. \square

Proposition 9.5. *Let W be a component of $\partial\mathcal{V}$. For any stable leaf E intersecting W and any ray r in $W \cap E$ there is a boundary component Z of $\partial\mathcal{V}$, intersecting E , with Z distinct from W and $Z \cap E$ asymptotic to the ray r . In addition the isotropy group of W is infinite cyclic.*

Proof. We start by proving the first assertion. The proof is by contradiction. We assume that W, E, r are as in the statement of the proposition, and fail the conclusion of the proposition. Hence r is not asymptotic to any other boundary component of $\mathcal{V} \cap E$.

Any ideal triangle in the hyperbolic plane has inradius $> a_1 > 0$. Since r is not asymptotic to any other ray $r' \subset \partial\mathcal{V} \cap E$, there are points p_i in r escaping the ray and points q_i in $\mathcal{V} \cap E$ so that the orthogonal geodesic to r in E at p_i intersects q_i at distance exactly a_0 and the segment between q_i and p_i (except for p_i) is contained in \mathcal{V} .

Up to subsequence and deck translations γ_i assume that $\gamma_i(p_i)$ converges to p_0 , and $\gamma_i(q_i)$ converges to q_0 . We claim that there is $j > 0$ fixed so that $\gamma_i(\mathcal{V}) = \gamma_j(\mathcal{V})$ for all $i > j$ and $\gamma_i(W) = \gamma_j(W)$. This is because we can assume that $\gamma_i(q_i)$ is very close to $\gamma_j(q_j)$ for all $i > j$ (j is fixed, and hence $\gamma_j(q_j), \gamma_j(\mathcal{V})$ are fixed). This implies that $\gamma_i(\mathcal{V}) = \gamma_j(\mathcal{V})$ for all $i > j$ because $\pi(q_0)$ is in $\pi(\mathcal{V})$: otherwise since it is accumulated by elements $\pi(q_i)$ which are in $\pi(\mathcal{V})$, it follows that q_0 is in $\pi(\partial\mathcal{V})$. But the projection of this boundary component of \mathcal{V} would intersect the disks in $\pi(\gamma_i(\mathcal{V}))$ with center at $\pi(q_i)$ with radius a_1 for i big, contradiction.

We change our starting point with $\gamma_j(\mathcal{V})$ instead of \mathcal{V} as follows. Let

$$\mathcal{U} = \gamma_j(\mathcal{V}), \quad T = \gamma_j(W), \quad b = \gamma_j(p_j), \quad \delta_i = \gamma_i \circ \gamma_j^{-1}, \quad \eta_0 = \gamma_j(W \cap E).$$

Since $d(p_i, p_j)$ converges to infinity with i , then up to subsequence it follows that the $\{\delta_i\}$ are pairwise distinct. The set T is a boundary component of $\partial\mathcal{U}$. This set \mathcal{U} is precisely invariant, since \mathcal{V} is. All δ_i preserve \mathcal{U} and preserve T .

All δ_i preserve T . By the previous Lemma the stabilizer subgroup of T is at most cyclic. Let α be a generator of this subgroup. We consider the foliation $\mathcal{F} := \widetilde{\Lambda}^s \cap T$. By Proposition 9.2, this foliation has leaf space the reals \mathbb{R} . We consider the action of α on this leaf space.

The points $\gamma_j(p_i)$ are in η_0 and escape in this ray of η . Their images under δ_i are $\gamma_i(p_i)$ which converges to p_0 (which is also in T). Since $\delta_i = \alpha^{n_i}$ with $|n_i| \rightarrow \infty$ as $i \rightarrow \infty$, it follows that $\alpha^{n_i}(\eta_0)$ converges to the leaf η of \mathcal{F} through p_0 . It follows that this leaf η of \mathcal{F} has to be fixed by α .

We now use the following intermediate cover of M : which is $M_1 := \widetilde{M} / \langle \alpha \rangle$. In M_1 the projection $T_1 = T / \langle \alpha \rangle$ is either an annulus or a Möbius strip and $\eta_1 = \eta / \langle \alpha \rangle$ is a closed curve in T_1 . The components of T_1 minus a neighborhood of η_1 are annuli – there is one such component if T_1 is a Möbius band and two components if T_1 is an annulus. Let A be one such component. Let $\mathcal{U}_1 = \mathcal{U} / \langle \alpha \rangle$. Suppose that there are points z_i in A escaping to infinity in T_1 so that the distance across \mathcal{U}_1 to any other boundary component of $\partial\mathcal{U}_1$ does not go to zero. Then an argument exactly as above produces a deck transformation β of \widetilde{M} preserving \mathcal{U} and T . Since the points are farther and farther from η (lifting to \widetilde{M}) it follows that β is not a power of α . Again this is impossible by the previous lemma.

It follows that for any sequence escaping in A then distance to the union of the other components of $\partial\mathcal{U}$ goes to zero. Consider one such sequence and lift to points y_i in T . Then the distance from y_i to the union of other boundary components of \mathcal{U} goes to zero. Since \mathcal{U} is the convex hull associated with the wall $\gamma_j(L)$, there must be a wall separating T from this other component of $\partial\mathcal{U}$. Hence there are v_i in deck translates K_i of L which are in \mathcal{U} and $d(y_i, v_i)$ converges to zero.

Up to a subsequence assume that $\pi(v_i)$ converges in M . Let β_i in $\pi_1(M)$ so that $\beta_i(v_i)$ converges to v_0 . Notice that K_i are deck translates of L , and so are $\beta_i(K_i)$. They are also walls. It follows that $\beta_i(K_i)$ converges to a wall G . By hypothesis we are under the New assumption as prescribed in the beginning of Section 7, hence there is a deck translate $\gamma(G)$ which intersects G transversely.

Since $\beta_i(K_i)$ converges to G there is i so that for any $n, m \geq i$ the following happens: $\beta_n(K_n)$ intersects $\gamma(\beta_m(K_m))$. Since all of these are translates of L , then if \mathcal{Y} is the convex hull associated with $\beta_i(K_i)$, it follows that all $\beta_n(K_n)$ and $\gamma(\beta_n(K_n))$ are contained in \mathcal{Y} if $n \geq i$. In particular \mathcal{Y} is the convex hull of all these deck translates of L .

The v_n are in K_n for $n \geq i$, the $\beta_n(v_n)$ are in \mathcal{Y} for $n \geq i$. It follows that v_0 is either in \mathcal{Y} or in $\partial\mathcal{Y}$. If v_0 is in \mathcal{Y} , then so are $\beta_n(y_n)$ for n big enough as \mathcal{Y} is open. This is impossible since $\beta_n(y_n)$ is in $\beta_n(T)$, $T \subset \partial\mathcal{U}$, and the sets \mathcal{U} and \mathcal{Y} are precisely invariant.

Suppose on the other hand that v_0 is in $\partial\mathcal{Y}$, and let Z be the boundary component of \mathcal{Y} containing v_0 . Then there is m so that for $n \geq m$, $\beta_n(y_n) \in Z$. Since $y_n \in T$ for any n it follows that $Z = \beta_m(T)$. Recall that $\alpha(T) = T$, so $\beta_m \alpha \beta_m^{-1}(Z) = Z$. In addition $\beta_n \beta_m^{-1}(Z) = Z$ for any $n \geq m$. Since the projection of y_n to $M_1 = M / \langle \alpha \rangle$ escapes compact sets in M_1 it follows that $\beta_n \beta_m^{-1}$ are not all in the group generated by $\beta_m \alpha \beta_m^{-1}$. This implies that the isotropy group of Z is not cyclic. This again is disallowed by Lemma 9.4.

This contradiction shows that the assumption in the beginning of the proof of this proposition was impossible. This proves the first assertion of the proposition.

For the second statement we do the following: the non empty intersection of \mathcal{V} with any E in $\tilde{\Lambda}^s$ contains an ideal triangle with two ideal points the ideal points of $T \cap E$. These triangles can be chosen to vary continuously with E . Then an argument as in the first part of the proof produces a non trivial deck transformation β preserving \mathcal{V} and T .

This finishes the proof of Proposition 9.5. \square

10. COMPLETION OF THE PROOF OF THE MAIN THEOREM

We now finish the proof of the main theorem.

Theorem 10.1. *Suppose L is a wall so that there is γ in $\pi_1(M)$ so that $\gamma(L)$ intersects L transversely. Then Φ is \mathbb{R} -covered.*

Proof. Let \mathcal{V} be the convex hull of L . There are two possibilities:

Case 1 – $\mathcal{V} = \tilde{M}$.

But $\tilde{\Lambda}^s$ restricted to \mathcal{V} is a foliation which has leaf space the reals. Since \mathcal{V} is \tilde{M} , the the leaf space of $\tilde{\Lambda}^s$ is \mathbb{R} , and Φ is an \mathbb{R} -covered Anosov flow.

Case 2 – \mathcal{V} is not all of \tilde{M} .

Up to a finite cover assume that M is orientable and all foliations are transversely orientable. For a sufficiently small ϵ consider the following set in $\pi(\mathcal{V})$: for any E stable leaf intersecting $\pi(\mathcal{V})$ consider the set Z of points in $E \cap \pi(\mathcal{V})$ which are ϵ away along $E \cap \pi(\mathcal{V})$ from a point in $\pi(\partial\mathcal{V})$. Then a proof exactly as in Proposition 6.7 shows that every component of Z is a two dimensional torus, and $\pi(\mathcal{V})$ is an open solid torus. In addition $\pi(\partial\mathcal{V})$ has finitely many boundary components, and so does $\partial\mathcal{V}$. It also implies that any component W of $\partial\mathcal{V}$ intersects exactly the same stable leaves that \mathcal{V} does. One can prove that any such W is in fact a wall, but we will not do that as we can prove the \mathbb{R} -covered property for Λ^s more directly using what was done before in this article.

The above implies that for any E leaf of $\tilde{\Lambda}^s$ intersecting \mathcal{V} , then $E \cap \mathcal{V}$ is a finite sided ideal polygon. Let L be a wall contained in \mathcal{V} . Then $L \cap E$ is a geodesic where each ray is asymptotic to two geodesics in $\partial\mathcal{V} \cap E$. In particular there are only finitely many such $\gamma(L)$ in \mathcal{V} . Any other $\gamma(L)$ cannot intersect \mathcal{V}

and hence does not intersect L . Let α be a generator of the stabilizer of \mathcal{V} . There is a smallest positive power α^i which fixes all $\gamma(L)$ contained in \mathcal{V} . Then

$$L \cap \cup\{\gamma(L) \subset \mathcal{V}, \gamma(L) \neq L\}$$

Is a finite collection of curves, all invariant under α^i . This implies that there is a half plane P in L bounded by a curve β invariant under α^i so that P does not intersect any other translate of L . Take points p_i in L farther and farther from β , so that $\pi(p_i)$ converges in M . Using appropriate deck translates δ_i of L it follows that the limit of $\delta_i(L)$ is a wall G whose $\pi_1(M)$ deck translates do not intersect each other transversely. But we are under the New assumption as in the beginning of Section 7 so this cannot happen (in other words, the existence of such G would imply Λ^s \mathbb{R} -covered by the proof of the first case of the Main Theorem).

This finishes the proof of the Main theorem. \square

11. EXAMPLES OF WALLS

In this section we describe some examples of walls. We assume throughout this section that the Anosov flow Φ has the standard form used in this article: the leaves of Λ^s have the hyperbolic metric, and flow lines in any such leaf are geodesics in their respective stable leaves.

Example 1 – \mathbb{R} -covered Anosov flows.

We first describe walls for general \mathbb{R} -covered Anosov flows and then specialize to atoroidal, Seifert and toroidal manifolds. We will assume that Φ is an \mathbb{R} -covered Anosov flow not orbitally equivalent to a suspension Anosov flow. These are called *skewed* Anosov flows [Fe1].

We provide more information. For proofs and much more detailed explanations and properties we refer to [Cal1, Cal4, Fe1, Th3]. For Φ a skewed Anosov flow the following happens: The foliation Λ^s is what is called *uniform* [Th3]: this means that any two leaves E, F are a finite Hausdorff distance from each other in \widetilde{M} , where the Hausdorff distance depends on the particular pair of leaves E, F . Let a_0 be the Hausdorff distance between E, F . There is a coarsely defined map:

$$\tau : \tau_{E,F} : E \rightarrow F, \quad \tau_{E,F}(x) = y, \quad \text{for some } y \in F, \quad \text{with } d_{\widetilde{M}}(y, x) \leq a_0 + 1.$$

This map is clearly not uniquely defined, but it is coarsely defined [Fe3] in the following sense: there is a continuous monotone function $f : [0, \infty) \rightarrow [0, \infty)$, so that if $y, z \in F$ satisfy $d_{\widetilde{M}}(y, z) \leq b$, then $d_F(y, z) < f(b)$. The map $\tau_{E,F}$ is a quasi-isometry with quasi-isometry constants which depend only on the Hausdorff distance a_0 between E, F and the function f evaluated at $2a_0$. Since $\tau_{E,F}$ is a quasi-isometry then it extends to a homeomorphism [Gr, Th1, Th2] still denoted by $\tau_{E,F} : E \cup S^1(E) \rightarrow F \cup S^1(F)$ [Th1, Th2, Gr].

We now describe walls for skewed Anosov flows. Recall that a wall G has the property that any two leaves of the foliation $\mathcal{F} := G \cap \widetilde{\Lambda}^s$ are a finite Hausdorff distance in \widetilde{M} from each other. Start with a leaf $E \in \widetilde{\Lambda}^s$ and an arbitrary geodesic g in E . For any F stable leaf the image $\tau_{E,F}(g)$ of g is a quasigeodesic in F and it is a bounded distance in F from a unique geodesic which is denoted by g_F . Let

$$L = \bigcup_{F \in \widetilde{\Lambda}^s} g_F.$$

It follows from [Fe1] that L is a properly embedded plane in \widetilde{M} . Given F in $\widetilde{\Lambda}^s$ and β a geodesic in F suppose it is a bounded Hausdorff distance in M from g . Then $d_{\widetilde{M}}(\beta, g_F)$ is finite and by the property of \mathbb{R} -covered foliations (the function f), then $d_F(\beta, g_F)$ is finite. Since F has the hyperbolic metric, one has that $\beta = g_F$. It follows that the only candidates for walls are the sets L described by the above formula.

We explain additional properties that establish that any such L is a wall. First we claim that there is a leaf F of $\widetilde{\Lambda}^s$ so that $L \cap F$ is a flow line of $\widetilde{\Phi}$. Fix F in $\widetilde{\Lambda}^s$. If one of the ideal points of $F \cap L$ in $S^1(F)$ is the positive ideal point of F we are done. Otherwise let x, y be the ideal points in $S^1(F)$ of $F \cap L$ and β, α the flow lines in F with negative ideal points in $S^1(F)$ which are x, y respectively. Let $U = \widetilde{\Lambda}^u(\beta), V = \widetilde{\Lambda}^u(\alpha)$. As long as U (or V) keeps intersecting stable leaves F' nearby then $U \cap F'$ (or $V \cap F'$) is asymptotic with $U \cap F$ (or $V \cap F$) in the negative direction, and this determines $F' \cap L$. At some point U and V stop intersecting stable leaves: this is because any unstable leaf in \widetilde{M} intersects only a bounded interval in the leaf space of $\widetilde{\Lambda}^s$ [Fe1]. Suppose that the unstable leaf U stops intersecting stable leaves before V . This means that the intersection of stable leaves with U escapes to infinity and the limit stable leaf then intersects L in a flow line, which is the intersection with V . This can be iterated on either side of the flow line intersection, producing infinitely many flow line intersections on either side.

Near a flow line intersection $L \cap F$ for some F in $\widetilde{\Lambda}^s$, one sees that intersections $L \cap F'$ have one ideal point corresponding to a direction asymptotic with $L \cap F$ and the other direction is expanding away from $L \cap F$. The set L intersects all leaves of $\widetilde{\Lambda}^s, \widetilde{\Lambda}^u$, which are both homeomorphic to \mathbb{R} . Finally using the structure of skewed Anosov flows [Fe1] it is easy to see that each L is associated with a bi-infinite chain of lozenges, which is in fact a string of lozenges. This implies that L is a wall.

In summary if one fixes a stable leaf E in $\widetilde{\Lambda}^s$, then the collection of all walls in \widetilde{M} is in a one to one correspondence with geodesics in E .

Example 2 – Φ is \mathbb{R} -covered and M atoroidal.

We now specialize to the case that M atoroidal or equivalently M hyperbolic. These are the walls L that are used to prove the Main Theorem. Here we will understand better what happens when $\pi(L)$ is embedded, or self intersects transversely. For simplicity assume that Λ^s is transversely oriented. This can be always achieved by taking a double cover.

Thurston proved in [Th3] (see also [Ca1, Fe1]) that, under the transverse orientability hypothesis and M atoroidal, there is a pseudo-Anosov flow φ which is transverse to Λ^s and regulating for it. *Regulating* means that every orbit of $\widetilde{\varphi}$ intersects every leaf of $\widetilde{\Lambda}^s$ and vice versa. The pseudo-Anosov flow is obtained by a collapsing operation applied to a pair of leafwise geodesic laminations $\mathcal{G}^s, \mathcal{G}^u$, the stable and unstable laminations transverse to Λ^s : each leaf Z of $\widetilde{\mathcal{G}}^s$ (or $\widetilde{\mathcal{G}}^u$) intersects each stable leaf E of $\widetilde{\Lambda}^s$ of the flow $\widetilde{\Phi}$ in a geodesic in E . Furthermore for any F, F' in $\widetilde{\Lambda}^s$ then $Z \cap F, Z \cap F'$ are a finite Hausdorff distance from each other in \widetilde{M} . In other words every leaf of $\widetilde{\mathcal{G}}^s$ or $\widetilde{\mathcal{G}}^u$ is a wall as described in Example 1.

In particular this describes a collection of walls L in \widetilde{M} so that $\pi(L)$ are embedded in M , so obviously no transverse self intersections in M . In addition for any leaf E of $\widetilde{\Lambda}^s$, the complementary regions of $E \cap \widetilde{\mathcal{G}}^s$ and $E \cap \widetilde{\mathcal{G}}^u$, $E \in \widetilde{\Lambda}^s$,

are finite sided ideal polygons in E . The laminations $\mathcal{G}^s, \mathcal{G}^u$ are transverse to each other and both are transverse to Λ^s . The flow φ is obtained by collapsing the complementary regions of $\mathcal{G}^s \cup \mathcal{G}^u$. The complementary regions of \mathcal{G}^s or \mathcal{G}^u are (open) solid tori in M (in this case the transverse orientability condition on Λ^s forces M to be orientable). This possibility for the walls was described and analyzed in the first case of the proof of the Main Theorem.

We stress that there are 2 very different flows in these examples: Φ is an Anosov flow, φ is strictly a pseudo-Anosov flow – there are p prong singular orbits of φ with $p \geq 3$.

We have described the walls L in \widetilde{M} so that L is a leaf of $\widetilde{\mathcal{G}}^s$ or $\widetilde{\mathcal{G}}^u$. There are two other types of walls in \widetilde{M} . The first type is as follows: let E be a leaf of $\widetilde{\Lambda}^s$ and let g be a geodesic which does not intersect $\widetilde{\mathcal{G}}^s \cap E$ transversely, but also g is not a leaf of $\widetilde{\mathcal{G}}^s \cap E$. Let L be the wall associated with g . Then g is in a complementary region of $E \cap \widetilde{\mathcal{G}}^s$, which we explained is a finite sided ideal polygon P . Hence g is a diagonal in P . There are finitely many complementary regions to \mathcal{G}^s in M and therefore finitely many possibilities for $\pi(L)$ as above. It could be that $\pi(L)$ has no transverse self intersections, hence its completion is a lamination. It contains a sublamination of \mathcal{G}^s , but \mathcal{G}^s is minimal, so $\pi(L)$ completes to $\pi(L) \cup \mathcal{G}^s$. The other option is that $\pi(L)$ self intersects transversely. Still the deck translates $\gamma(L)$ intersecting L transversely cannot intersect \mathcal{G}^s transversely, so $\gamma(L) \cap E$ is still contained in P . It follows that the convex hull \mathcal{V} of L intersected with E is contained in P : it could be P itself, in which case a boundary component of \mathcal{V} would be a leaf of $\widetilde{\mathcal{G}}^s$, yielding the lamination \mathcal{G}^s in M . Or it could be that $\mathcal{V} \cap E$ is a strict subset of P . The boundary components of $\mathcal{V} \cap E$ are either leaves of $\widetilde{\mathcal{G}}^s \cap E$ – leading to the production of \mathcal{G}^s , or they are other diagonals in P , but now produce walls without self intersections when projected to M and this is analyzed above as well. The same happens with the unstable lamination, $\widetilde{\mathcal{G}}^u$ instead of $\widetilde{\mathcal{G}}^s$.

The final possibility is that the geodesic g in E intersects both $\widetilde{\mathcal{G}}^s \cap E$ and $\widetilde{\mathcal{G}}^u \cap E$ transversely. This case is more involved and we analyze this now.

We will use the following: Given leaves E, F of $\widetilde{\Lambda}^s$ with F being $\widetilde{\varphi}$ flow forward from E , then the map $\tau_{E,F}$ is a bounded distance from the map which is flow along $\widetilde{\varphi}$ from E to F as follows: given x in E take the flow line of $\widetilde{\varphi}$ through x and let $\Delta_{E,F}(x)$ be the intersection with F . Then there is a constant a_1 (independent of x but dependent on the Hausdorff distance between E, F) so that $d_F(\tau_{E,F}(x), \Delta_{E,F}(x)) < a_1$.

Let $\mathcal{F}^s, \mathcal{F}^u$ be the stable and unstable foliations of φ . We stress again that \mathcal{F}^s is not to be confused with Λ^s , in fact \mathcal{F}^s is transverse to Λ^s . The pseudo-Anosov behavior of the flow φ implies that any curve transverse to the singular stable foliation \mathcal{F}^s flows forward (under φ) to curves closer and closer to the unstable foliation \mathcal{F}^u . In particular any geodesic g in a leaf E of $\widetilde{\Lambda}^s$ so that it is transverse to $\widetilde{\mathcal{G}}^s \cap E$ then flowing by φ moves them closer and closer to the unstable foliation (\mathcal{G}^u).

But we explained that the map $\tau_{E,F}$ is also a bounded distance from the flow along map along map $\Delta_{E,F}$. It follows that as F escapes in the leaf space of $\widetilde{\Lambda}^s$ in the positive direction then $\pi(F \cap L)$ is getting closer and closer to $\mathcal{G}^u \cap \pi(F)$. This shows that $\pi(L)$ limits to \mathcal{G}^u in the positive direction and to \mathcal{G}^s in the negative direction. Since $\mathcal{G}^u \cup \mathcal{G}^s$ completely fill M , it now follows that the convex hull \mathcal{V} associated with L is all of \widetilde{M} . This corresponds to the second case of the Main

theorem when $\mathcal{V} = \widetilde{M}$. In the second case we assume that for any wall L obtained in the limit process then $\pi(L)$ self intersects transversely. If instead one assume that this is true for some, but not necessarily all walls limiting walls L , then one can obtain the case $\mathcal{V} = \widetilde{M}$, as well as the case $\mathcal{V} \neq \widetilde{M}$, which is in fact what happens.

We specialize this further. Suppose that for some $E \in \widetilde{\Lambda}^s$ then $g = \pi(E \cap L)$ is a closed geodesic. This can only happen when $E \cap L$ is a flow line of $\widetilde{\Phi}$, which projects to a periodic orbit of Φ . It is proved in [Fe1] that g is transverse to both $\widetilde{\mathcal{G}}^s$ and $\widetilde{\mathcal{G}}^u$ so it falls in this case. Let ζ be the deck transformation associated with $\pi(g)$. Then $\zeta(L) = L$ and ζ preserves all corners of L , which then project to periodic orbits of Φ which are pairwise freely homotopic. Notice the similarity with a suspension pseudo-Anosov flow: if one starts with a closed curve in the surface then positive iterates will limit to the unstable lamination of the monodromy of the fibration, and negative iterates will limit to the stable lamination.

Example 3 – \mathbb{R} -covered Anosov flows in M Seifert.

In this case Barbot [Ba2] proved Φ is orbitally equivalent to a finite lift of a geodesic flow. Hence to simplify we assume that Φ is the geodesic flow on $M = T^1S$, where S is a closed hyperbolic surface. We also assume that S is orientable – this is equivalent to Λ^s being transversely orientable. First let η_* be a simple closed geodesic in S which lifts to 2 periodic orbits η and η' of Φ corresponding to different directions of η' in S . Then η, η' respectively lift to infinitely many pairs of periodic orbits η_{2i}, η_{2i+1} of $\widetilde{\Phi}$ in \widetilde{M} , $i \in \mathbb{Z}$. The η_j are corners of a bi-infinite string of lozenges and generate a wall L just as in example 1, the case of no transverse intersection. In this case L is left invariant by a \mathbb{Z}^2 subgroup of $\pi_1(M)$ generated by (say) η and a closed loop corresponding to the Seifert fiber of M .

The projection $\pi(L)$ has no transverse self intersections and it is a torus. This is a lamination in M . Notice that the boundary of a tubular neighborhood of the torus $\pi(L)$ is a torus in M , which in this case is incompressible. Recall the analysis of the proof of the Main theorem: in the case of M atoroidal this boundary of a neighborhood of the lamination was a torus, which had to be compressible.

Now instead of starting with a simple closed geodesic, let η' be a closed geodesic in S with self intersections, which are necessarily transverse. As in the case of η' simple we construct a wall L associated with η' . The isotropy group of L is a \mathbb{Z}^2 subgroup of $\pi_1(M)$. Let S_0 be the subsurface of S which is the fill of η' . Suppose first that $S_0 = S$, that is, η' fills S . Then the deck translates of L fill \widetilde{M} , that is, the convex hull \mathcal{V} of L is \widetilde{M} . If on the other hand S_0 is not M , let β be a boundary component of S_0 . Let L be a wall constructed from η' . The convex hull \mathcal{V} of L has a boundary component which is a wall W associated with β . The projection $\pi(W)$ is a π_1 injective torus in M .

These are the walls invariant under a \mathbb{Z}^2 group of deck translations. Every other wall is invariant under the cyclic group generated by the element associated with a Seifert fiber.

Example 4 – Φ which is \mathbb{R} -covered in M toroidal, but M not Seifert.

There are many examples in this class. We describe one class. This was analyzed in detail in [Fo-Ha]. Start with $M_0 = T^1S$, S hyperbolic surface, for simplicity assume S orientable. Let η_* be a closed geodesic in S . To make it more interesting we assume that η_* is not simple, and fills a subsurface S_1 of S . One

can make several examples here, again for definiteness assume that S_1 is a strict subsurface of S , that is S_1 is not just S cut along a collection of non separating closed geodesics. Let S_2 be the closure of $S - S_1$.

Let η be an orbit of the geodesic flow associated with η_* . Do an appropriate Fried-Dehn surgery on η to result in an Anosov flow Φ in a manifold M . One can do this so that the resulting flow is still Anosov and \mathbb{R} -covered [Go, Fr, Fe1]. The submanifold T^1S_1 of M_0 becomes an atoroidal submanifold M_1 of M after surgery [Fo-Ha]. The original orbit η of the geodesic flow becomes an orbit τ of Φ which is freely homotopic to the infinitely many distinct periodic orbits of Φ . Since Φ is \mathbb{R} -covered these free homotopies produce a wall L in \widetilde{M} . This wall has translates intersecting it transversely, as in Example 3. The projection $\pi(L)$ fills the submanifold M_1 of M . As opposed to Example 2, the projection is not a closed torus. Each boundary component of M_1 can be obtained as $\pi(W)$, where W is a wall which is a boundary component of the convex hull \mathcal{V} of L . As in Example 3, each such $\pi(W)$ is an embedded, incompressible torus in M .

One can do this for various orbits of the geodesic flow, filling pairwise disjoint subsurfaces of S .

Example 5 – Φ non \mathbb{R} -covered.

We describe one of many possible constructions. Start with the example described in Example 4, with M_1 obtained from $M_0 = T^1S$ by Fried Dehn surgery on the flow line η corresponding to a geodesic η_* of S filling the subsurface S_1 of S . Let S_2 be the closure of $S - S_1$, which we assume is a two dimensional surface (no single geodesic components). Let now β_0 be a flow line of the geodesic flow corresponding to a geodesic in S_2 which is not peripheral in S_2 . This flow line is unaffected by the Fried Dehn surgery becoming an orbit β_1 of the flow in M . Now do a derived from Anosov blow up of β_1 producing a flow with a repelling orbit β_2 in M_1 . Remove a solid torus neighborhood of β_2 to produce a manifold M_2 with boundary a torus and a semiflow transverse to ∂M_2 which is incoming for the flow. Glue a copy M'_2 with a reversed flow. Work of Beguin-Bonatti-Yu [BBY] shows how to do the gluing so that the resulting flow φ on the resulting manifold N is Anosov. The walls L, W constructed in Example 4 produce walls L', W' for φ . They are not exactly the same because the blow up of β_1 changes the stable and unstable foliations of the flows. In the same way as in Example 4), the projection $\pi(L')$ intersects itself transversely. It fills a submanifold of N with a boundary isotopic to $\pi(W)$ which is embedded.

There are many variations of this construction.

More generally one can relax the requirement that a wall intersects exactly an \mathbb{R} worth of stable and unstable leaves in \widetilde{M} . Then any non trivial homotopy from a periodic orbit to itself generates a bi-infinite chain of lozenges invariant under a \mathbb{Z}^2 subgroup of $\pi_1(M)$. These “generalized walls” may be useful in other contexts. One example of these generalized walls occurs in the Bonatti-Langevin [Bo-La] example. This has many free homotopies, generating infinitely many such generalized walls. One can have pairs of these walls sharing a corner without being the same wall. This shows that the requirement that M is atoroidal is in general necessary to obtain equality of walls when they share a corner. In the Bonatti-Langevin example one can make counterexamples that are in fact walls as defined in this article and not generalized walls.

12. MORE QUASIGEODESIC PSEUDO-ANOSOV FLOWS

In this section we will prove the following:

Theorem 12.1. *Let M be a hyperbolic 3-manifold admitting an Anosov flow Φ . Then up to perhaps a double cover, M admits a quasigeodesic pseudo-Anosov flow. In any case M admits a one dimensional foliation by quasigeodesics, with a dense leaf.*

Proof. Let Φ be an Anosov flow in M . If Φ is not \mathbb{R} -covered, then the Main Theorem shows that Φ is quasigeodesic and this proves the result.

We assume from now on that Φ is \mathbb{R} -covered. Then Φ is not quasigeodesic [Fe1]. Suppose first that the stable foliation Λ^s of Φ is transversely orientable. Then, as explained in the previous section, there is a pseudo-Anosov flow φ in M , transverse to Λ^s and regulating for Λ^s [Th3, Fe3, Cal1]. This flow is quasigeodesic [Th3]. This finishes the proof in this case.

Finally suppose that Φ is \mathbb{R} -covered, but Λ^s is not transversely orientable. As explained This is a non empty class: for example start with the geodesic flow on a non orientable, closed hyperbolic surface S . Let η_* be an orientation preserving geodesic that fills S and η an orbit of the geodesic flow that projects to η_* . Then high enough appropriate Fried Dehn surgery on η [Fr] yields a manifold M which is atoroidal [Fo-Ha] hence hyperbolic. If the surgery coefficient satisfy a positivity condition then the resulting Anosov flow is an \mathbb{R} -covered Anosov flow [Fe1]. Finally the resulting Anosov flow has Λ^s non transversely orientable.

So again assume Φ is \mathbb{R} -covered, but Λ^s not transversely orientable. Let M_2 be the double cover of M corresponding to the deck transformations which preserve transverse orientation in the universal cover. Let $\pi_2 : \widetilde{M} \rightarrow M_2$ the corresponding universal cover map. The flow Φ lifts to an Anosov flow Φ_2 in M_2 with a stable foliation Λ_2^s which is \mathbb{R} -covered and transversely orientable.

In M_2 there is a pseudo-Anosov flow φ which is transverse and regulating for Λ_2^s . This is a quasigeodesic flow. It does not project to a flow in M transverse to Λ^s since Λ^s is not transversely orientable. However the one dimensional foliation by flow lines of Φ_2 can be made to project to a foliation in M transverse to Λ^s . It is easier to do this using the leafwise geodesic laminations $\mathcal{G}^s, \mathcal{G}^u$ associated with φ and transverse to the foliation Λ_2^s .

Let γ be a deck transformation. We show that γ preserves the pair $\widetilde{\mathcal{G}}^s, \widetilde{\mathcal{G}}^u$ – even though not necessarily each of them individually. If γ is in $\pi_1(M_2)$ then by definition γ preserves $\widetilde{\mathcal{G}}^s$ and $\widetilde{\mathcal{G}}^u$.

Suppose then that γ is not in $\pi_1(M_2)$. Hence it reverses the transversal orientation to $\widetilde{\Lambda}_2^s$. Since $\pi_1(M_2)$ is normal in $\pi_1(M)$, then γ induces an isometry of M_2 (of order 2) and sends \mathcal{G}^s to another leafwise geodesic lamination.

Claim 12.2. $\gamma(\mathcal{G}^s) = \mathcal{G}^u$, and consequently $\gamma(\mathcal{G}^u) = \mathcal{G}^s$.

Proof. Parametrize $\widetilde{\Lambda}^s$ as $\{E_t, t \in \mathbb{R}\}$, so that the positive $\widetilde{\varphi}$ flow direction is with increasing t . Going up means increasing t .

Let L be a leaf of $\widetilde{\mathcal{G}}^s$, which is a wall. Then $\gamma(L)$ is also a wall. Therefore $\gamma(L) \cap E_t$ is a bounded distance from $\gamma(L) \cap E_0$ (the bound depends on t). We analysed this situation in Example 2 of the previous section: if $\gamma(L) \cap E_0$ is not in the intersection of $\widetilde{\mathcal{G}}^s$ with a stable leaf, then $\gamma(L) \cap E_t$ is getting closer and closer to the unstable lamination $\widetilde{\mathcal{G}}^u \cap E_t$ as t increases. Notice that $\gamma(L) \cap E_t$ cannot be in a complementary region of $\widetilde{\mathcal{G}}^s \cap E_t$, since then it would be an isolated leaf

of $\gamma(\tilde{\mathcal{G}}^s) \cap E_t$. Then $\pi_2(\gamma(L))$ limits in \mathcal{G}^u and so its closure contains \mathcal{G}^u . Since \mathcal{G}^s is minimal in this case then $\gamma(\mathcal{G}^s) = \mathcal{G}^u$.

Can $\gamma(L) \cap E_0$ be tangent to a leaf in $\tilde{\mathcal{G}}^s$? In that case, the same arguments imply that $\gamma(\tilde{\mathcal{G}}^s) = \tilde{\mathcal{G}}^s$. But this is impossible: going up (t increasing) then leaves of $\tilde{\mathcal{G}}^s$ expand away from each other. Applying γ reverses the orientation to $\tilde{\Lambda}^s$, so this means going down (t decreasing). So going down one gets transverse expansion. This would imply that both going up and down one gets expansion of leaves of $\tilde{\mathcal{G}}^s$ away from each other, which is impossible.

We conclude that $\gamma(\tilde{\mathcal{G}}^s) = \tilde{\mathcal{G}}^u$ and $\gamma(\tilde{\mathcal{G}}^u) = \tilde{\mathcal{G}}^s$. \square

In any case $\pi_1(M)$ preserves the pair of laminations $\tilde{\mathcal{G}}^u, \tilde{\mathcal{G}}^s$, hence preserves their intersection. It also preserves the set of complementary regions of $\tilde{\mathcal{G}}^s \cup \tilde{\mathcal{G}}^u$ in \tilde{M} . Hence when we collapse the complementary regions we obtain a one dimensional foliation transverse to $\tilde{\Lambda}^s$ and regulating for it. It projects to a one dimensional foliation in M which is transverse to Λ^s .

Finally all flows are pseudo-Anosov in M or M_2 which are atoroidal. Hence there is dense orbit. This projects to a dense leaf in the last case.

This finishes the proof of the Theorem. \square

13. CONTINUOUS EXTENSION OF ANOSOV FOLIATIONS

Theorem 13.1. *Let Φ be an Anosov flow in M^3 closed, hyperbolic. Then the stable and unstable foliations of Φ have the continuous extension property.*

Proof. Suppose first that Φ is \mathbb{R} -covered. Then both Λ^s and Λ^u are \mathbb{R} -covered. Then the result was proved in [Th3], see also Theorem G of [Fe6].

Suppose on the other hand that Φ is not \mathbb{R} -covered. It follows that Φ is a quasigeodesic Anosov flow by the Main Theorem. Then the continuous extension property was proved in Theorem 5.8 of [Fe1], see also Theorem 3.4 of [Fe4]. \square

14. GROUP INVARIANT PEANO CURVES AND CANNON-THURSTON MAPS

We prove the abundance of group invariant Peano curves for Anosov flows in hyperbolic 3-manifolds.

Theorem 14.1. *Let M^3 be a hyperbolic 3-manifold admitting an Anosov flow Φ . Then there is a group invariant Peano curve $\eta : \partial\mathcal{O} \rightarrow \mathbb{S}_\infty^2$ where $\partial\mathcal{O}$ is the flow ideal boundary of a quasigeodesic flow in either M or a double cover M_2 of M .*

Remark 14.2. The flow ideal boundary $\partial\mathcal{O}$ can also be thought of as the universal circle associated with the corresponding pseudo-Anosov flow.

Proof. The map η is associated with a quasigeodesic pseudo-Anosov flow. Given a pseudo-Anosov flow φ , the orbit space \mathcal{O} of $\tilde{\varphi}$ is homomorphic to the plane [Fe-Mo]. The stable and unstable foliations of φ descend to one dimensional foliations in \mathcal{O} . In [Fe6] we define a flow ideal boundary $\partial\mathcal{O}$ of \mathcal{O} . It is homeomorphic to a circle. We refer to the reader to [Fe6] for definitions, constructions, and details.

This can be done for any pseudo-Anosov flow in any manifold. When M is hyperbolic and φ has an upper bound on the cardinality of sets of pairwise freely homotopic periodic orbits, then in [Fe7] we produced a group invariant Peano curve roughly as follows: Identify \tilde{M} with $\mathcal{O} \times \mathbb{R}$ where \mathbb{R} corresponds to the flow direction. Reparametrize the flow direction to be $(-1, 1)$ so \tilde{M} is parametrized as $\mathcal{O} \times (-1, 1)$. Then extend this model to

$$\mathcal{D} = (\mathcal{O} \cup \partial\mathcal{O}) \times [-1, 1],$$

The fundamental group $\pi_1(M)$ naturally acts on \mathcal{D} . In [Fe5] we consider a quotient space of $\partial\mathcal{D}$ using the stable and unstable foliations of φ (thought of as one dimensional foliations in \mathcal{O}). Let this quotient be

$$\mathcal{R} = \partial\mathcal{D}/\sim,$$

where \sim is the equivalence relation in $\partial\mathcal{D}$. The equivalence relation is as follows: two points in $(\mathcal{O} \cup \partial\mathcal{O}) \times \{1\}$ are identified if the pair is contained in the union of a stable leaf in $\mathcal{O} \times \{1\}$ and its ideal points in $\partial\mathcal{O} \times \{1\}$. In the lower boundary $(\mathcal{O} \cup \partial\mathcal{O}) \times \{-1\}$ we use the unstable boundary instead. Finally each vertical segment $p \times [-1, 1]$ is collapsed to a point. In particular every point in \mathcal{D} is identified with a point in $\partial\mathcal{O} \times \{1\}$. In other words, there is an induced collapsing map

$$\eta : \partial\mathcal{O} \rightarrow \mathcal{R},$$

where we identify $\partial\mathcal{O}$ with $\partial\mathcal{O} \times \{1\}$.

There is an induced action of $\pi_1(M)$ on \mathcal{R} . The important fact is that under the boundedness condition on freely homotopic periodic orbits it is proved in [Fe7] that the action of $\pi_1(M)$ on \mathcal{R} is a uniform convergence group action. Super briefly: if a stable leaf A makes a perfect fit with an unstable leaf B , then the corresponding ideal points of the rays of A, B (seen in \mathcal{O}) are the same point in $\partial\mathcal{O}$. So if there are too many perfect fits there are too many identifications, which can lead to bad topological behavior in \mathcal{R} .

Using results of Bowditch [Bo] this implies that \mathcal{R} is $\pi_1(M)$ equivariantly homeomorphic to the sphere at infinity \mathbb{S}_∞^2 . In addition there is a quotient space $\widetilde{M} \cup \mathcal{R}$ of \mathcal{D} which is $\pi_1(M)$ equivariantly homeomorphic to the canonical compactification of \widetilde{M} into $\widetilde{M} \cup \mathbb{S}_\infty^2$. The map $\eta : \partial\mathcal{O} \rightarrow \mathcal{R} \cong \mathbb{S}_\infty^2$ is the group invariant Peano curve or Cannon-Thurston map associated with this situation.

Now we apply this to the situation we have at hand starting with an Anosov flow Φ in M^3 hyperbolic.

– 1) If Φ is not \mathbb{R} -covered, let $\varphi = \Phi$. Then φ is quasigeodesic and we apply the above construction to φ . This proves this case.

– 2) If Φ is \mathbb{R} -covered and its stable foliation is transversely orientable, let φ be a pseudo-Anosov flow transverse to and regulating for Λ^s . Then φ is quasigeodesic [Th3, Fe1, Cal1]. Apply the construction above to φ . Notice that the orbit space of $\widetilde{\Phi}$ is definitely completely different from the orbit space of $\widetilde{\varphi}$. We apply the construction to φ and not to Φ in this case.

– 3) Finally suppose that Φ is \mathbb{R} -covered, but Λ^s is not transversely orientable. As in the previous section let M_2 be the double cover which orients the lift Λ_2^s of Λ^s to M_2 . Let φ be a pseudo-Anosov flow transverse to Λ_2^s and regulating for Λ_2^s . Let \mathcal{O} be the orbit space of $\widetilde{\varphi}$. Then the construction above yields a Cannon-Thurston map

$$\eta : \partial\mathcal{O} \rightarrow \mathbb{S}_\infty^2.$$

What we know is that this map is $\pi_1(M_2)$ equivariant. Now consider the one dimensional foliation \mathcal{F} in M induced by the flow lines of φ in M_2 . This foliation has the same leaf space in $\widetilde{M} = \widetilde{M}_2$ as the orbit space of $\widetilde{\varphi}$, since φ is a double cover of \mathcal{F} . Let γ be a deck transformation of \widetilde{M} (an element of $\pi_1(M)$). Suppose

that γ is not in $\pi_1(M_2)$. We proved in the last section that $\gamma(\tilde{\mathcal{G}}^u) = \tilde{\mathcal{G}}^s$ and $\gamma(\tilde{\mathcal{G}}^s) = \tilde{\mathcal{G}}^u$. Hence γ also induces a homeomorphism of $\partial\mathcal{O}$. We explained that \mathcal{R} is obtained as a quotient of $\partial\mathcal{O}$ where one identifies different points which are ideal point of either a stable or an unstable leaf in \mathcal{O} . Since γ switches the stable and unstable foliations, the same identifications occur, so γ also induces a homeomorphism of $\mathcal{R} \cong \mathbb{S}_\infty^2$.

It is easy to see that this induces an action of $\pi_1(M)$ on \mathcal{R} and that η is $\pi_1(M)$ group equivariant, that is, a Cannon-Thurston map.

This finishes the proof of the theorem. □

15. FUTURE QUESTIONS

A) Obviously one immediate question raised by the results of this article is to decide what happens for general pseudo-Anosov flows in hyperbolic 3-manifolds. The best result would be to show that if there is a p -prong singular orbit (with $p \geq 3$, or equivalently it is the case of a “true” pseudo-Anosov flow, as opposed to a topological Anosov flow), then the flow is quasigeodesic. One obvious problem that needs to be solved is to find a good geometry for the leaves of (say) Λ^s , which in this case is a singular foliation. In this article we used Candel’s results to give a metric in M so that every leaf of Λ^s is a hyperbolic surface. Clearly this does not work in the general situation. An appropriate metric with appropriate properties needs to be found to analyze this problem.

B) Another very important problem is to decide when a given Anosov flow in M^3 hyperbolic is \mathbb{R} -covered or not. In the Introduction we described several examples which are \mathbb{R} -covered, and several which are not \mathbb{R} -covered, using the results of Bonatti and Iakovoglou [Bo-Ia]. It would be good to know more about when exactly the \mathbb{R} -covered condition holds.

C) One can study the quasigeodesic question for Anosov flows in toroidal manifolds. The methods of this article could be particularly useful to study quasigeodesicity in an atoroidal piece P . This corresponds to a finite volume hyperbolic manifold. Putting the boundary ∂P in good form with respect to the flow (union of Birkhoff tori) one can make sense of the stable or unstable foliation being \mathbb{R} -covered when restricted to P . We expect that the \mathbb{R} -covered case will not be quasigeodesic, this should not be too complicated. The non \mathbb{R} -covered case could be analyzed using the tools of this article, and hopefully show that the flow restricted to P is quasigeodesic. This has a fairly good chance to succeed. It is quite possible the same holds for pseudo-Anosov flows as well.

D) Bands and walls can easily be defined for more general Anosov flows. They could be useful to attack other problems involving the topological and geometric structure of Anosov flows.

E) Let \mathcal{F} be a Reebless foliation, By Novikov’s theorem [No] any leaf of $\tilde{\mathcal{F}}$ is a properly embedded plane in \tilde{M} . If M is also hyperbolic, then for $L \in \tilde{\mathcal{F}}$, its limit set is the set of accumulation points in the sphere at infinity \mathbb{S}_∞^2 . If \mathcal{F} is \mathbb{R} -covered (Anosov foliation or not), then the limit set of any $L \in \tilde{\mathcal{F}}$ is the whole \mathbb{S}_∞^2 [Fe1]. Suppose now that Φ is a non \mathbb{R} -covered Anosov flow in M^3 hyperbolic. Given $L \in \tilde{\Lambda}^s$ (or $\tilde{\Lambda}^u$) what is the limit set of L ? Could it be \mathbb{S}_∞^2 ? This is a good test case for the following question: suppose that \mathcal{F} is Reebless in M^3 hyperbolic. Is it true that there is $L \in \tilde{\mathcal{F}}$ with limit set of L the whole \mathbb{S}_∞^2 if and only if \mathcal{F} is \mathbb{R} -covered? The results of this article should be able to give light to this question in the case of Anosov foliations.

REFERENCES

- [An] D. V. Anosov, *Geodesic flows on closed Riemannian manifolds with negative curvature*, Proc. Steklov Inst. Math. **90** (1969).
- [Ba1] T. Barbot, *Caractérisation des flots d'Anosov pour les feuilletages faibles*, Erg. Th. Dyn. Sys. **15** (1995) 247-270.
- [Ba2] T. Barbot, *Flots d'Anosov sur les variétés graphées au sens de Waldhausen*, Ann. Inst. Fourier Grenoble **46** (1996) 1451-1517.
- [BFP] T. Barthelmé, S. Fenley and R. Potrie, *Collapsed Anosov flows and self orbit equivalences*, math.arxiv: 2008.06547, submitted.
- [BBY] F. Béguin, C. Bonatti and B. Yu, *Building Anosov flows on 3-manifolds*, Geom.Topol. **21** (2017) 1837-1930.
- [Bo-Ia] C. Bonatti and I. Iakovoglou, *Anosov flows on 3-manifolds: the surgeries and the foliations*, math.arXiv:2007.11518, Erg. Th. Dyn. Sys. published online, 27 April 2022, 60 pages.
- [Bo-La] C. Bonatti and R. Langevin, *Un exemple de flot d'Anosov transitif transverse à une tore et non conjugué à une suspension*, Erg.Th. Dyn. Sys. **14** (1994) 633-643.
- [Bow] B. Bowditch, *A topological characterization of hyperbolic groups*, Jour. Amer. Math. Soc. **11** (1998) 643-667.
- [Cal1] D. Calegari, *The geometry of \mathbb{R} -covered foliations*, Geometry and Topology **4** (2000) 457-515.
- [Cal2] D. Calegari, *Problems in foliations and laminations of 3-manifolds*, Proc. Symp. Pure Math. (2003).
- [Cal3] D. Calegari, *Universal circles for quasigeodesic flows*, Geom. Topol. **10** (2006) 2271-2298.
- [Cal4] D. Calegari, *Foliations and the geometry of 3-manifolds*, Oxford University Press, (2007).
- [Cand] A. Candel, *Uniformization of surface laminations*, Ann. Sci. École Norm. Sup. **26** (1993) 489-516.
- [Ca-Th] J. Cannon and W. Thurston, *Group invariant Peano curves*, Geom. Topol. **11** (2007) 1315-1355.
- [Fe1] S. Fenley, *Anosov flows in 3-manifolds*, Ann. of Math. **139** (1994) 79-115.
- [Fe2] S. Fenley, *Quasigeodesic Anosov flows and homotopic properties of flow lines*, Jour. Diff. Geom. **41** (1995) 479-514.
- [Fe3] S. Fenley, *The structure of branching in Anosov flows of 3-manifolds*, Comm. Math. Helv. **73** (1998) 259-297.
- [Fe4] S. Fenley, *Foliations with good geometry*, Jour. A.M.S. **12** (1999) 619-676.
- [Fe5] S. Fenley, *Geometry of foliations and flows I: Almost transverse pseudo-Anosov flows and asymptotic behavior of foliations*, Jour. Diff. Geom. **81** (2009) 1-89
- [Fe6] S. Fenley, *Ideal boundaries of pseudo-Anosov flows and uniform convergence groups with connections and applications to large scale geometry*, Geom. Topol. **16** (2012) 1-110.
- [Fe7] S. Fenley, *Quasigeodesic pseudo-Anosov flows in hyperbolic 3-manifolds and connections with large scale geometry*, Advances in Math. **303** (2016) 192-278.
- [Fe-Mo] S. Fenley and L. Mosher, *Quasigeodesic flows in hyperbolic 3-manifolds*, Topology **40** (2001) 503-537.
- [Fo-Ha] P. Foulon and B. Hasselblatt, *Contact Anosov flows in hyperbolic 3-manifolds*, Geom. Topol. **17** (2013) 1225-1252.
- [Fra1] S. Frankel, *Quasigeodesic flows and Möbius like groups*, Jour. Diff. Geom. **93** (2013) 401-429.
- [Fra2] S. Frankel, *Quasigeodesic flows and sphere-filling curves*, Geom. Topol. **19** (2015) 1249-1262.
- [Fra3] S. Frankel, *Coarse hyperbolicity and closed orbits for quasigeodesic flows*, Ann. Math. **188** (2018) 1-48.
- [Fr] D. Fried, *Transitive Anosov flows and pseudo-Anosov maps*, Topology **22** (1983) 299-303.
- [Ga] D. Gabai, *Problems in foliations and laminations*, Geometric topology, AMS Studies Adv. Math. 2.2 (1997).
- [Go] S. Goodman, *Dehn surgery on Anosov flows*, Geometric dynamics (Rio de Janeiro, 1981), Lecture Notes in Math. **1007** 300-307, Springer, 1983.
- [Gr] M. Gromov, *Hyperbolic groups*, in Essays in group theory, 75–263, Math. Sci. Res. Inst. Publ. **8** (1987) Springer, New York.
- [Ka-Ha] A. Katok and B. Hasselblatt, *Introduction to the modern theory of dynamical systems*, Cambridge University Press, 1995.
- [Mj] M. Mj, *Cannon-Thurston maps for surface groups*, Ann. of Math. **179** (2014) 1-80.

- [Mos1] L. Mosher, *Examples of quasigeodesic flows on hyperbolic 3-manifolds*, Proceedings of the Ohio State Research semester on Low-Dimensional topology, W. de Gruyter, 1992.
- [Mos2] L. Mosher, *Dynamical systems and the homology norm of a 3-manifold II*, Inven. Math. **107** (1992) 243-281.
- [No] S.P.Novikov, *Topology of foliations*, Trans. Moscow Math. Soc., **14** (1963) 268-305.
- [Pla] J. Plante, *Foliations with measure preserving holonomy*, Ann. Math. **102** (1975) 327-361.
- [Sha] M. Shannon, *Hyperbolic models for transitive topological Anosov flows in dimension three*, [math.arXiv:2108.12000](https://arxiv.org/abs/2108.12000).
- [Sul] D. Sullivan, *Cycles for the dynamical study of foliated manifolds and complex manifolds*, Inven. Math. **36** (1976) 225-255.
- [Th1] W. Thurston, *The geometry and topology of 3-manifolds*, Princeton University Lecture Notes, 1982.
- [Th2] W. Thurston, *Three dimensional manifolds, Kleinian groups, and hyperbolic geometry*, Bull. A.M.S. **6** (1982) 357-381.
- [Th3] W. Thurston, *Three manifolds, foliations and circles I* [arxiv.math.9712268](https://arxiv.org/abs/math/9712268).
- [Ze] A. Zeghib, *Sur les feuilletages géodésiques de variétés hyperboliques*, Inven. Math. **114** (1993) 193-206.

FLORIDA STATE UNIVERSITY, TALLAHASSEE, FL 32306, USA AND INSTITUTE FOR ADVANCED STUDY, PRINCETON, NJ 08540, USA

Email address: fenley@math.fsu.edu