

KNOT SURGERY FORMULAE FOR INSTANTON FLOER HOMOLOGY II: APPLICATIONS

ZHENKUN LI AND FAN YE

ABSTRACT. This is a companion paper to earlier work of the authors, which proved an integral surgery formula for framed instanton homology. First, we present an enhancement of the large surgery formula, a rational surgery formula for null-homologous knots in any 3-manifold, and a formula encoding a large portion of $I^\sharp(S_0^3(K))$. Second, we use the integral surgery formula to study the framed instanton homology of many 3-manifolds: Seifert fibered spaces with nonzero orbifold degrees, especially nontrivial circle bundles over any orientable surface, surgeries on a family of alternating knots and all twisted Whitehead doubles, and splicings with twist knots. Finally, we use the previous techniques and computations to study almost L-space knots, *i.e.*, the knots $K \subset S^3$ with $\dim I^\sharp(S_n^3(K)) = n + 2$ for some $n \in \mathbb{N}_+$. We show that an almost L-space knot of genus at least 2 is fibered and strongly quasi-positive, and a genus-one almost L-space knot must be either the figure eight or the mirror of the 5_2 knot in Rolfsen's knot table.

CONTENTS

1. Introduction	2
2. Preliminaries on surgery formulae	8
2.1. Conventions	8
2.2. Sutured instanton homology for knot complements	8
2.3. Integral surgery formulae	13
2.4. Truncation of the integral surgery formulae	14
2.5. Instanton tau invariant	17
3. A rational surgery formula	18
3.1. The connected sum with a core knot	18
3.2. The formula for null-homologous knots	22
4. The 0-surgery for knots in the 3-sphere	25
5. Surgeries on Borromean knots	28
5.1. The Borromean knot	28
5.2. The connected sums	31
5.3. Seifert fibered manifolds	36
6. Surgeries on some alternating knots	39
6.1. Knots with torsion order one	39
6.2. Commutativity of the first differentials	41
6.3. Classification of complexes	45
6.4. Induction using oriented skein relation	47
7. Twisted Whitehead doubles and splicings	53
8. Almost L-space knots	57
References	64

1. INTRODUCTION

Sutured instanton homology $SHI(M, \gamma)$ for a balanced sutured manifold (M, γ) was introduced by Kronheimer-Mrowka [KM11b] and it leads to many important instanton invariants of 3-manifolds and knots. Among them the framed instanton homology $I^\sharp(Y)$ for a 3-manifold Y and the instanton knot invariant $KHI(Y, K)$ for a knot $K \subset Y$ are the two most important ones. It has been known that the framed instanton homology is closely related to the $SU(2)$ -representations of the fundamental group $\pi_1(Y)$ and hence understanding its structural property and computing its dimension is an essential task in the study of instanton theory. However, the fact that instanton Floer homology is constructed based on a set of partial differential equation makes this task very difficult. Some previous computational results were obtained in [Sca15, LPCS20, BS19, BS21].

Motivated by the conjecture proposed by Kronheimer-Mrowka [KM10b] that framed instanton homology and the hat version of Heegaard Floer homology are isomorphic to each other, and the known structural properties in the Heegaard Floer theory established by Ozsváth-Szabó [OS04, OS08, OS11], the authors of the current paper have established many structural properties that relates the framed instanton homology to instanton knot homology:

- (1) In [LY21b, LY21a], we established a decomposition of $SHI(M, \gamma)$ along $H_1(M; \mathbb{Z})$, and showed that the enhanced Euler characteristic associated to this decomposition equals to the Euler characteristic of $SFH(M, \gamma)$ with respect to the spin^c decomposition.
- (2) In [LY21c], for a rationally null-homologous knot $K \subset Y$, we constructed two differentials d_+ and d_- on $KHI(Y, K)$ so that the homologies are isomorphic to $I^\sharp(Y)$. Using those differentials, we constructed some complexes called **bent complexes** whose homologies computing $I^\sharp(Y_n(K))$, where $Y_n(K)$ is obtained from Y by Dehn surgery along K with a large coefficient n .
- (3) In [LY22b], we established a formula based on the bent complexes that computes $I^\sharp(Y_m(K))$ for any nonzero integral m -surgery.

Many applications already have been found based on this work: the proof that $\pi_1(S^3 \setminus L)$ for almost all link L admits an irreducible $SU(2)$ -representation in [XZ21], the proof that $\pi_1(S^3_r(K))$ for any nontrivial knot admits an irreducible $SU(2)$ -representation in [BLSY21], a strong restriction on the Alexander polynomial $\Delta_K(t)$ for any instanton L-space knot K in [LY21c], and the computation of $I^\sharp(S^3_r(K))$ for any genus-one quasi-alternating knot K in [LY21c], *etc.*

In this paper, we present more applications of our previous work from (1) to (3), further demonstrating the power of these tools in dealing with the Dehn surgeries of knots: we upgrade the integral surgery formula proved in [LY22b] to a rational surgery formula; we study the 0-surgery for knots inside S^3 , which is a missing case in [LY22b]; we study almost L-space knots, which admit a surgery with next-to-minimal framed instanton homology, and we present the computations of many new families of the framed instanton homology of 3-manifolds, including most Seifert fibered 3-manifolds with non-zero orbifold degrees, the Dehn surgery along a large family of alternating knots and all twisted Whitehead doubles, and splittings of the complement of a twist knot with the complement of an arbitrary knot in S^3 . Below, we give an outline of the contents of individual sections, providing more details of these results.

Section 2. We review notations and results about surgery formulae in [LY21c, LY22b]. We truncate the integral surgery formula to make them simpler for further usage. As a byproduct, we weaken the assumption on the large coefficient in the large surgery formula. Especially, when K is null-homologous, the integer $2g(K) - 1$ is large enough to apply the large surgery formula, while in [LY21c] the minimal integer is $2g(K) + 1$.

Section 3. We establish a rational surgery formula for all null-homologous knots in instanton theory. The proof is similar to that in Heegaard Floer theory [OS11]. Suppose $K \subset Y$ is a null-homologous knot. The rational surgery along K can be interpreted as the integral surgery along a knot $K_{\#} \subset Y \# L(p, q)$. The knot $K_{\#}$ is obtained by the connected sum of K and a core knot in $L(p, q)$ (whose complement is a solid torus) for (p, q) chosen according to the surgery slope. We establish a connected sum formula for the differentials on bent complexes in such case and then apply the integral surgery formula to complete the proof.

Section 4. The statement of the integral surgery formula in [LY22b] excludes the case of 0-surgery, *i.e.* the filling slope is the boundary of a Seifert surface. However, for a knot $K \subset S^3$, we can still understand a large portion of $I^{\sharp}(S_0^3(K))$ by examining an extra grading: After performing the 0-surgery, the Seifert surface of K is capped off by the meridian disk of the filling solid torus, which becomes an essential closed surface in $S_0^3(K)$. From [BS19, Section 2.6], this surface induces a \mathbb{Z} -grading

$$(1.1) \quad I^{\sharp}(S_0^3(K)) \cong \bigoplus_{s=1-g(K)}^{g(K)-1} I^{\sharp}(S_0^3(K), s).$$

In this case, the integral surgery formula can be stated and proven grading-wise. As a result, we could understand $I^{\sharp}(S_0^3(K), s)$ for all s but 0.

The next three sections are about computations. To apply the integral surgery formula for a specific knot, there are two main tasks to solve:

- (1) To compute differentials d_{\pm} on $KHI(Y, K)$;
- (2) To find the isomorphism $H(KHI(Y, K), d_{+}) \cong H(KHI(Y, K), d_{-})$ in the statement of the surgery formula (*c.f.* Theorem 2.16).

In the following three sections we present many methods to deal with the above task (1) and (2).

Section 5. We deal with the borromean knot as in Figure 1 and the connected sums of a few copies of them. Any such knot K is inside a 3-manifold Y that is the connected sum of a few copies of $S^1 \times S^2$. For this special families of knot, we have

$$KHI(Y, K) \cong I^{\sharp}(Y)$$

so task (1) is trivial. Moreover, the $H_1(Y)$ -action in this case is essential: we have an identification

$$I^{\sharp}(Y) = \Lambda^* H_1(Y).$$

Hence we can regard all related instanton Floer homology groups as modules over the ring $\Lambda^* H_1(Y)$ and the task (2) can be done via the module structure.

It is worth mentioning that prior to the current paper, most computations of $I^{\sharp}(Y)$ are for rational homology sphere Y , while our computations for (connected sums of) Borromean knots, up to the author's knowledge, provide a first family of knots inside 3-manifolds with positive first Betti number for which the framed instanton homology of their Dehn surgeries can be computed systematically. It is well-known that the nonzero integral surgeries of connected sums of Borromean knots give nontrivial circle bundles over orientable surfaces. Hence we obtain the following.

Theorem 1.1. *For any $g > 1$, $m \neq 0$, suppose Y_m^g is the circle bundle over a surface of genus g with Euler number m . We have the following.*

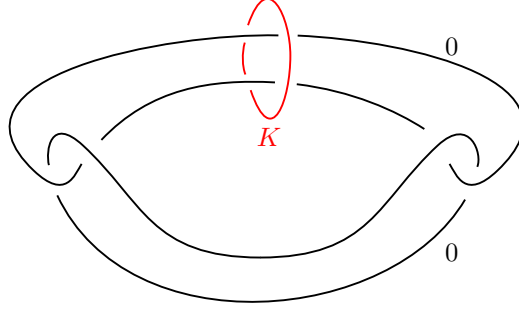

FIGURE 1. The Borromean knot K inside $S^1 \times S^2 \# S^1 \times S^2$. The two copies of $S^1 \times S^2$ come from the zero surgeries on the two (black) components of the Borromean link.

(1) If $|m| \geq 2g - 1$, then

$$\dim I^\sharp(Y_m^g) = 2^{2g} \cdot |m|.$$

(2) If $|m| = 2l$ with $l \leq g - 1$, then

$$\dim I^\sharp(Y_m^g) = 2^{2g} \cdot |m| + 4 \cdot \sum_{j=1}^{g-l-1} \sum_{i=0}^{j-1} \binom{2g}{i} + 2 \cdot \sum_{i=0}^{g-l-1} \binom{2g}{i}.$$

(3) If $|m| = 2l - 1$ with $l \leq g - 1$, then

$$\dim I^\sharp(Y_m^g) = 2^{2g} \cdot |m| + 4 \cdot \sum_{j=1}^{g-l} \sum_{i=0}^{j-1} \binom{2g}{i}$$

Remark 1.2. In [OS08, Theorem 5.5], Ozsváth-Szabó provided a formula for $HF_{red}^+(Y_m^g)$ by the integral surgery formula for HF^+ .

Furthermore, we can recover any Seifert fibered space with nonzero orbifold degree by a non-zero integral surgery along the connected sum of Borromean knots and suitable core knots in lens spaces. We also use the $\Lambda^* H_1(Y)$ -module structure to solve task (2). As a result, we prove the following theorem, which generalizes Alfieri-Baldwin-Dai-Sivek's result for Seifert fibered manifolds that are rational homology spheres [ABDS20, Corollary 1.3].

Theorem 1.3. *Let Y be a Seifert fibered space over a genus g orbifold with Seifert invariants $(m, r_1/v_1, \dots, r_n/v_n)$. Suppose the orbifold degree is*

$$\deg Y = m + \sum_{i=1}^n \frac{r_i}{v_i}.$$

If $\deg Y \neq 0$ and $\gcd(v_i, v_j) = 1$ for any $i \neq j \in \{1, \dots, n\}$, then

$$\dim_{\mathbb{C}} I^\sharp(Y) = \dim_{\mathbb{F}_2} \widehat{HF}(Y).$$

Remark 1.4. It is possible to compute $\dim_{\mathbb{C}} I^\sharp(Y)$ in Theorem 1.3 explicitly as in [OS11, Theorem 10.1]. We need the condition $\deg Y \neq 0$ because we do not have a zero-surgery formula for knots inside general manifolds and $\deg Y = 0$ corresponds to the zero-surgery on the connected sum. We need the condition $\gcd(v_i, v_j) = 1$ because we want the first homology of the complement of

the connected sum to be torsion-free, so that we can use the grading from the Seifert surface to capture all information in the spin^c decomposition of Heegaard Floer theory. This condition could be removed if we utilize the work in [LY21a] to obtain a further composition of our integral surgery formula.

Section 6. We also study more families of knots inside S^3 . Since now there are isomorphisms

$$H(KHI(S^3, K), d_+) \cong H(KHI(S^3, K), d_-) \cong I^\#(S^3) \cong \mathbb{C},$$

the choice of the isomorphism between them is only up to a scalar. Hence task (2) is trivial, and all we need is to deal with task (1).

It is well-known that alternating knots are thin in the Heegaard Floer theory [OS03]. From Petkova's classification of thin complexes [Pet13, Section 3.1], the knot Floer complex of an alternating knot are fully determined by its Alexander polynomial and the tau invariant (which is related to the signature for alternating knots). Since there is no known integral Maslov grading in instanton theory, we do not have a proper definition of thin knots in instanton setting.

Instead, we can consider knots whose two spectral sequences from $KHI(S^3, K)$ to $I^\#(S^3)$ collapse on the second pages, *i.e.* only differentials $d_{1,\pm}$ are nontrivial. We call such knots have **torsion order one** (*c.f.* Definition 6.4). For knots having torsion order one, we have similar classification of complexes involving d_\pm as the thin complexes, and hence the complexes are again fully determined by the Alexander polynomial and the tau invariant in instanton theory.

In order to prove that some families of knots have torsion order one, we make use of the oriented skein relation in instanton theory studied in [Lim10, KM10a]. Unlike the original setup, where we have an oriented smoothing of the crossing to derive a link in S^3 , we consider its knotification, or equivalently a knot inside $S^1 \times S^2$.

This idea of using oriented skein relation works for a large family of alternating knots. In particular, we can deal with the family of knots as shown in Figure 2. The signs of the crossings are unusual because the induction starts with the torus knots $T(2, 2n+1)$ (*i.e.* $a_i = 0$ for all i), whose crossings are all positive. We prove those knots have torsion order one and then we can compute the framed instanton homologies on their surgeries.

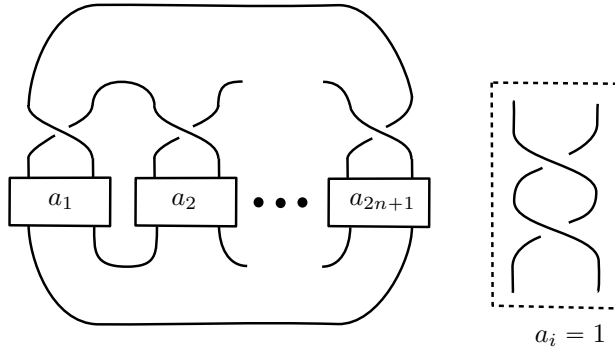

FIGURE 2. The knot $K(a_1, \dots, a_{2n+1})$.

Theorem 1.5. Suppose $K \subset S^3$ is a knot as shown in Figure 2 so that

$$a_i \geq 0 \text{ for all } i = 1, \dots, 2n+1, \text{ and}$$

$$\#\{i \mid a_i \geq 1\} \leq n + 1.$$

Then we have $g(K) = n$ and for any $r = p/q \in \mathbb{Q} \setminus \{0\}$ with $q \geq 1$, we have

$$\dim I^\sharp(S_r^3(K)) = \dim_{\mathbb{F}_2} \widehat{HF}(S_r^3(K)) = \frac{\|\Delta_K(t)\| - 2n - 3}{2} \cdot q + |p - q \cdot (2n - 1)|,$$

where $\|\cdot\|$ is the sum of absolute values of coefficients.

Remark 1.6. The one-dimensional argument that task (2) is trivial for knots inside S^3 can also be generalized to a knot K in any instanton L-space Y . If $H_1(Y \setminus N(K); \mathbb{Z})$ is torsion-free, then we may use the grading from the Seifert surface to decompose our integral surgery formula, so that the one-dimensional argument can be applied to each summand. If $H_1(Y \setminus N(K); \mathbb{Z})$ is not torsion-free, we could utilize the work in [LY21a] to obtain a decomposition, but that needs a further study between the interaction of the decomposition and the construction of the integral surgery formula (c.f. Remark 1.4).

Section 7. We also use the techniques involving oriented skein relation to study twisted Whitehead doubles.

Theorem 1.7. Suppose $K = D_t^+(J)$ is the t -twisted Whitehead double of J with positive clasp; see Figure 3. Suppose τ_I is the instanton tau invariant and $\Gamma_n \subset \partial(S^3 \setminus N(J))$ consist of two copies of curves with slope $-n$. Then we have the following.

$$(1) \ KHI(S^3, K, 1) \cong SHI(S^3 \setminus N(J), \Gamma_{-t}).$$

$$(2) \ \tau_I(K) = \begin{cases} 1 & t < 2 \cdot \tau_I(J) \\ 0 & t \geq 2 \cdot \tau_I(J) \end{cases}$$

$$(3) \ \dim I^\sharp(S_{\pm 1}^3(K)) = \begin{cases} 2 \cdot \dim SHI(S^3 \setminus N(J), \Gamma_{-t}) \mp 1 & t < 2 \cdot \tau_I(J) \\ 2 \cdot \dim SHI(S^3 \setminus N(J), \Gamma_{-t}) + 1 & t \geq 2 \cdot \tau_I(J) \end{cases}$$

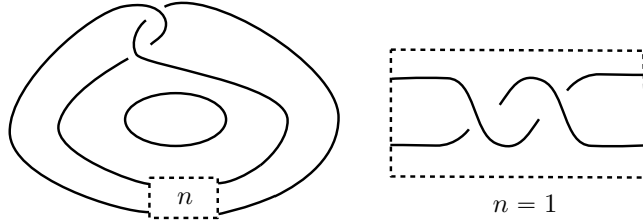

FIGURE 3. Whitehead double.

Remark 1.8. According to [BS21, Theorem 1.1], the data provided in Theorem 1.7 part (3) is enough to compute the framed instanton homology of all nonzero rational surgeries of the twisted Whitehead doubles with positive clasps. Also, note we have

$$\overline{D_m^-(K)} = D_{-m}^+(\bar{K}),$$

where \bar{K} is the mirror of K . So we also know all the information for twisted Whitehead doubles with negative clasps.

Theorem 1.7 can also be applied to study splittings with knot complements of twist knots. Note that twist knots K_n are the positively clasped n -twisted Whitehead doubles of the unknot.

Theorem 1.9. *Suppose K_n is the twist knot. Suppose $J \subset S^3$ is a non-trivial knot. Let Y be obtained by gluing the complement of K_n with the complement of J so that the gluing map sends the meridian of one knot to the longitude of the other and vice versa. Let $\Gamma_0 \subset \partial(S^3 \setminus N(J))$ consist of two Seifert longitudes. Then*

$$\dim I^\sharp(Y) = \begin{cases} 2 \cdot |n| \cdot \dim SHI(S^3 \setminus N(J), \Gamma_0) + 1 & \tau_I(J) \leq 0 \\ |n| \cdot (2 \cdot \dim SHI(S^3 \setminus N(J), \Gamma_0) - 1) + |1 + n| & \tau_I(J) > 0 \end{cases}$$

Remark 1.10. From [GLW19, Section 5.2], we have the following equality for $n \in \mathbb{Z}$ (c.f. Lemma 2.28)

$$\dim SHI(S^3 \setminus N(J), \Gamma_n) = \dim SHI(S^3 \setminus N(J), \Gamma_{-2\tau_I(K)}) + |n + 2\tau_I(K)|.$$

So for a knot $K \subset S^3$, as long as we know its τ_I and $\dim SHI(S^3 \setminus N(J), \Gamma_n)$ for any one $n \in \mathbb{Z}$, we obtain the dimensions for all $n \in \mathbb{Z}$. Furthermore, from Theorem 1.7 and Theorem 1.9, we obtain the framed instanton homology of Dehn surgeries along all of their twisted Whitehead doubles as well as the splicing with the complements of the twist knots. Here is the list of knots where all such data are known.

- Genus-one quasi-alternating knots (c.f. [LY21c, Section 6]).
- Instanton L-space knots (c.f. [LY21c, Section 5]).
- Knots described in Theorem 1.5 (c.f. Section 6).

Section 8. Finally, we study almost L-space knots in S^3 . A knot $K \subset S^3$ is called an **almost (instanton) L-space knot** if it is not an instanton L-space knot and there exists $n \in \mathbb{N}_+$ so that

$$(1.2) \quad \dim I^\sharp(S_n^3(K)) = n + 2.$$

Note that $n + 2$ is the second minimal value of the dimension since the Euler characteristic is n [Sca15, Corollary 1.4]. See [BS22a] for the results in Heegaard Floer theory.

Similar to the previous work on instanton L-space knots [LY21c], we can impose strong restrictions on almost L-space knots. Moreover, we can classify all genus-one almost L-space knots.

Theorem 1.11. *Suppose $K \subset S^3$ is an almost L-space knot. Then we have the following.*

- (1) *If $g(K) \geq 2$, then K is fibered, strongly quasi-positive, and $\tau_I(K) = g(K)$.*
- (2) *If $g(K) = 1$, then K is either the figure eight or the mirror of the 5_2 knot in Rolfsen's knot table (with signature -4 , denoted by $\bar{5}_2$).*

A direct corollary of Theorem 1.11 is the following.

Corollary 1.12. *Suppose $K \subset S^3$ is a knot. Suppose further that*

$$\dim I^\sharp(S_1^3(K)) = 3.$$

Then K is either the left-handed trefoil, the figure-eight, or the knot $\bar{5}_2$.

The proof for $g(K) \geq 2$ largely depends on our previous work in [LY21c, Section 5]. The classification of genus-one almost L-space knots are more complicated. We first proved that $KHI(S^3, K)$ is 1- or 2-dimensional in the top Alexander grading, for which we know a list of all possible knots. If the top grading is 1-dimensional, then the knot is fibered [KM10b, Corollary 7.19]. It is well-known that the trefoil and the figure eight are the only genus-one fibered knots. If the top

grading is 2-dimensional, recently Baldwin-Sivek [BS22b] classified all such knots in the Heegaard Floer setting. According to [LY22c], the same results applied to the instanton setting. This also leads to the following theorem, which is a complete classification of genus-one nearly fibered knot in terms of instanton knot homology.

Theorem 1.13. *Suppose $K \subset S^3$ is a genus-one knot with*

$$\dim KHI(S^3, K, 1) = 2.$$

Let J be the right-handed trefoil. Then we know the following.

(1) $K = 5_2$ or its mirror if and only if

$$\dim KHI(S^3, K) = 7.$$

(2) K is the knot $15n_{43522}, D_2^-(J)$ or their mirrors if and only if

$$\dim KHI(S^3, K, 1) = 9 \text{ and } \Delta_K(t) = 2t - 3 + 2t^{-1}.$$

(3) K is one of the pretzel knot $P(-3, 3, 2n + 1)$ for some $n \in \mathbb{Z}$, $D_2^+(J)$, or their mirrors if and only if

$$\dim KHI(S^3, K, 1) = 9 \text{ and } \Delta_K(t) = -2t + 5 - 2t^{-1}.$$

Remark 1.14. Prior to the computation in this paper, due to Baldwin-Sivek's work [BS22b], we know that if K is genus-one and $\dim KHI(S^3, K, 1) = 2$, then K must be one of the knots listed in Theorem 1.13. Furthermore, we have already known that $\dim KHI(S^3, K) = 7$ for $K = 5_2$ and $\dim KHI(S^3, K, 1) = 9$ for $K = P(-3, 3, 2n + 1)$ and $K = D_2^+(J)$. The last piece for the above complete classification is the computations for $D_2^-(J)$ and $15n_{43522}$. This is finished in Section 7 and Section 8, respectively, via studying their Dehn surgeries.

Acknowledgement. The authors thank John A. Baldwin and Steven Sivek for introducing us to almost L-space knots. The authors also thank Ciprian Manolescu, Thomas E. Mark, Tomasz Mrowka, and Jacob Rasmussen for helpful comments and valuable discussions.

2. PRELIMINARIES ON SURGERY FORMULAE

2.1. Conventions. If it is not mentioned, all manifolds are smooth, oriented, and connected. Homology groups and cohomology groups are with \mathbb{Z} coefficients. We write \mathbb{Z}_n for $\mathbb{Z}/n\mathbb{Z}$ and \mathbb{F}_2 for the field with two elements. If there is no subscript for \dim , then it means $\dim_{\mathbb{C}}$.

A knot $K \subset Y$ is called **null-homologous** if it represents the trivial homology class in $H_1(Y; \mathbb{Z})$, while it is called **rationally null-homologous** if it represents the trivial homology class in $H_1(Y; \mathbb{Q})$.

For any oriented 3-manifold M , we write $-M$ for the manifold obtained from M by reversing the orientation. For any surface S in M and any suture $\gamma \subset \partial M$, we write S and γ for the same surface and suture in $-M$, without reversing their orientations. For a knot K in a 3-manifold Y , we write $(-Y, K)$ for the induced knot in $-Y$ with induced orientation, called the **mirror knot** of K . The corresponding balanced sutured manifold is $(-Y \setminus N(K), -\gamma_K)$.

2.2. Sutured instanton homology for knot complements. For any **balanced sutured manifold** (M, γ) [Juh06, Definition 2.2], Kronheimer-Mrowka [KM10b, Section 7] constructed an isomorphism class of \mathbb{C} -vector spaces $SHI(M, \gamma)$. Later, Baldwin-Sivek [BS15, Section 9] dealt with the naturality issue and constructed (untwisted and twisted versions of) projectively transitive systems related to $SHI(M, \gamma)$. We will use the twisted version, which we write as $\underline{SHI}(M, \gamma)$ and call **sutured instanton homology**.

Moreover, there is a relative \mathbb{Z}_2 -grading on $\underline{\text{SHI}}(M, \gamma)$ obtained from the construction of sutured instanton homology, which we consider as a **homological grading** and use to take Euler characteristic.

Definition 2.1. Suppose K is a knot in a closed 3-manifold Y . Let $Y(1) := Y \setminus B^3$ and let δ be a simple closed curve on $\partial Y(1) \cong S^2$. Let $Y \setminus N(K)$ be the knot complement and let Γ_μ be two oppositely oriented meridians of K on $\partial(Y \setminus N(K)) \cong T^2$. Define

$$I^\sharp(Y) := \underline{\text{SHI}}(Y(1), \delta) \text{ and } \underline{\text{KHI}}(Y, K) := \underline{\text{SHI}}(Y \setminus N(K), \Gamma_\mu).$$

From now on, we will suppose $K \subset Y$ is a rationally null-homologous knot and fix some notations. Let μ be the meridian of K and pick a longitude λ (so that $\lambda \cdot \mu = 1$) to fix a framing of K . We will always assume $Y \setminus N(K)$ is irreducible, but many results still hold due to the following connected sum formula of sutured instanton homology [Li18a, Section 1.8]:

$$\underline{\text{SHI}}(Y' \# Y \setminus N(K), \gamma) \cong I^\sharp(Y') \otimes \underline{\text{SHI}}(Y \setminus N(K), \gamma).$$

Given coprime integers r and s , let $\Gamma_{r/s}$ be the suture on $\partial(Y \setminus N(K))$ consists of two oppositely oriented, simple closed curves of slope $-r/s$, with respect to the chosen framing (*i.e.* the homology of the curves are $\pm(-r\mu + s\lambda) \in H_1(\partial N(K))$). Pick S to be a minimal genus Seifert surface of K .

Convention. We will use p to denote the order of $[K] \in H_1(Y)$, *i.e.*, p is the minimal positive integer satisfying $p[K] = 0 \in H_1(Y)$. Let $q = \partial S \cdot \lambda$ and let $g = g(S)$ be the genus of S . When K is null-homologous, we always choose the Seifert framing $\lambda = \partial S$. In such case, we have $(p, q) = (1, 0)$.

Remark 2.2. The meanings of p and q follow from [LY22b], but are different from our previous papers [LY22a, LY21c]. Before, we used $\hat{\mu}$ and $\hat{\lambda}$ to denote the meridian of the knot K and the preferred framing. When ∂S is connected, it is the same as the homological longitude λ in previous papers. Hence p and q in this paper should be q and q_0 in previous papers.

For simplicity, we use the bold symbol of the suture to represent the sutured instanton homology of the balanced sutured manifold with the reversed orientation:

$$\mathbf{\Gamma}_{r/s} := \underline{\text{SHI}}(-(Y \setminus N(K)), -\Gamma_{r/s}).$$

When $(r, s) = (\pm 1, 0)$, we write $\Gamma_{r/s} = \Gamma_\mu$. When $s = \pm 1$, we write $\Gamma_n = \Gamma_{n/1} = \Gamma_{(-n)/(-1)}$. We also write $\mathbf{\Gamma}_\mu$ and $\mathbf{\Gamma}_n$ for the corresponding sutured instanton homologies.

Also, we write

$$\mathbf{Y}_{r/s} := I^\sharp(-Y_{-r/s}(K)),$$

and in particular

$$\mathbf{Y}_n := I^\sharp(-Y_{-n}(K)) \text{ and } \mathbf{Y} := I^\sharp(-Y).$$

We always assume that S has minimal intersections with $\Gamma_{r/s}$. By work of [Li19], the Seifert surface S induces either a \mathbb{Z} -grading or a $(\mathbb{Z} + \frac{1}{2})$ -grading on $\mathbf{\Gamma}_{r/s}$, depending on the parity of the intersection number $\partial S \cdot (s\lambda - r\mu)$. We write the graded part of $\mathbf{\Gamma}_{r/s}$ as

$$(\mathbf{\Gamma}_{r/s}, i) := \underline{\text{SHI}}(-(Y \setminus N(K)), -\Gamma_{r/s}, S, i)$$

with $i \in \mathbb{Z}$ or $i \in \mathbb{Z} + \frac{1}{2}$, depending on the parity of the intersection number.

For simplicity, we omit the definitions of bypass maps $\psi_{\pm, *}$ and surgery maps $F_n, G_n, H_n, A_{n-1}, B_{n-1}, C_n$ in [LY22b, Section 2.2] and only list their properties as follows. The proofs and references can be found in [LY22b, Section 2.2].

Lemma 2.3. *We have $(\Gamma_{r/s}, i) = 0$ when*

$$|i| > g + \frac{|rp - sq| - 1}{2}.$$

Lemma 2.4. *For any $n \in \mathbb{Z}$, there are two graded bypass exact triangles*

$$\begin{array}{ccc} (\Gamma_n, i + \frac{p}{2}) & \xrightarrow{\psi_{+,n+1}^n} & (\Gamma_{n+1}, i) \\ & \swarrow \psi_{+,n}^\mu & \searrow \psi_{+, \mu}^{n+1} \\ & (\Gamma_\mu, i - \frac{np-q}{2}) & \end{array}$$

$$\begin{array}{ccc} (\Gamma_n, i - \frac{p}{2}) & \xrightarrow{\psi_{-,n+1}^n} & (\Gamma_{n+1}, i) \\ & \swarrow \psi_{-,n}^\mu & \searrow \psi_{-, \mu}^{n+1} \\ & (\Gamma_\mu, i + \frac{np-q}{2}) & \end{array}$$

where the maps are homogeneous with respect to the homological \mathbb{Z}_2 -gradings.

Definition 2.5. The maps in Lemma 2.4 are called **bypass maps**. The ones with subscripts + and – are called **positive** and **negative bypass maps**, respectively. We will use \pm to denote one of the bypass maps. For any integer n and any positive integer k , define

$$\Psi_{\pm, n+k}^n := \psi_{\pm, n+k}^{n+k-1} \circ \dots \circ \psi_{\pm, n+1}^n : \Gamma_n \rightarrow \Gamma_{n+k}.$$

Lemma 2.6. *For any $n \in \mathbb{Z}$, we have the following commutative diagrams up to scalars.*

$$\begin{array}{ccc} \Gamma_n & \xrightarrow{\psi_{+,n+1}^n} & \Gamma_{n+1} \\ \downarrow \psi_{-,n+1}^n & & \downarrow \psi_{-,n+2}^{n+1} \\ \Gamma_{n+1} & \xrightarrow{\psi_{+,n+2}^{n+1}} & \Gamma_{n+2} \end{array} \quad \begin{array}{ccc} \Gamma_{n+2} & \xrightarrow{\psi_{+, \mu}^{n+2}} & \Gamma_\mu \\ \downarrow \psi_{-, \mu}^{n+2} & & \downarrow \psi_{+,n}^\mu \\ \Gamma_\mu & \xrightarrow{\psi_{-,n}^\mu} & \Gamma_n \end{array}$$

Lemma 2.7. *For any $n \in \mathbb{Z}$, we have the following commutative diagrams up to scalars*

$$\begin{array}{ccc} \Gamma_n & \xrightarrow{\psi_{+,n+1}^n} & \Gamma_{n+1} \\ & \swarrow \psi_{-,n}^\mu & \searrow \psi_{-,n+1}^\mu \\ & \Gamma_\mu & \end{array}$$

$$\begin{array}{ccc} \Gamma_n & \xrightarrow{\psi_{-,n+1}^n} & \Gamma_{n+1} \\ & \swarrow \psi_{+,n}^\mu & \searrow \psi_{+,n+1}^\mu \\ & \Gamma_\mu & \end{array}$$

$$\begin{array}{ccc} \Gamma_n & \xrightarrow{\psi_{+,n+1}^n} & \Gamma_{n+1} \\ & \swarrow \psi_{-, \mu}^n & \searrow \psi_{-, \mu}^{n+1} \\ & \Gamma_\mu & \end{array}$$

$$\begin{array}{ccc} \Gamma_n & \xrightarrow{\psi_{-,n+1}^n} & \Gamma_{n+1} \\ & \swarrow \psi_{+, \mu}^n & \searrow \psi_{+, \mu}^{n+1} \\ & \Gamma_\mu & \end{array}$$

Lemma 2.8. *For a knot $K \subset Y$ and $n \in \mathbb{Z}$, there are two graded bypass exact triangles*

$$\begin{array}{ccc}
 (\Gamma_{n-1}, i + \frac{np-q}{2}) & \xrightarrow{\psi_{+, \frac{2n-1}{2}}^{n-1}} & (\Gamma_{\frac{2n-1}{2}}, i) \\
 & \swarrow \psi_{+, n-1}^n & \searrow \psi_{+, n}^{\frac{2n-1}{2}} \\
 & (\Gamma_n, i - \frac{(n-1)p-q}{2}) &
 \end{array}$$

$$\begin{array}{ccc}
 (\Gamma_{n-1}, i - \frac{np-q}{2}) & \xrightarrow{\psi_{-, \frac{2n-1}{2}}^{n-1}} & (\Gamma_{\frac{2n-1}{2}}, i) \\
 & \swarrow \psi_{-, n-1}^n & \searrow \psi_{-, n}^{\frac{2n-1}{2}} \\
 & (\Gamma_n, i + \frac{(n-1)p-q}{2}) &
 \end{array}$$

Lemma 2.9. *For a knot $K \subset Y$ and $n \in \mathbb{Z}$, there are commutative diagrams up to scalars*

$$\begin{array}{ccc}
 \Gamma_\mu & \xrightarrow{\psi_{+, n-1}^\mu} & \Gamma_{n-1} \\
 \psi_{-, n-1}^\mu \downarrow & & \downarrow \psi_{+, \frac{2n-1}{2}}^{n-1} \\
 \Gamma_{n-1} & \xrightarrow{\psi_{-, \frac{2n-1}{2}}^{n-1}} & \Gamma_{\frac{2n-1}{2}}
 \end{array}$$

$$\begin{array}{ccc}
 \Gamma_{\frac{2n-1}{2}} & \xrightarrow{\psi_{+, n}^{\frac{2n-1}{2}}} & \Gamma_n \\
 \psi_{-, n}^{\frac{2n-1}{2}} \downarrow & & \downarrow \psi_{-, \mu}^n \\
 \Gamma_n & \xrightarrow{\psi_{+, \mu}^n} & \Gamma_\mu
 \end{array}$$

$$\begin{array}{ccc}
 \Gamma_\mu & \xrightarrow{\psi_{+, n-1}^\mu} & \Gamma_{n-1} \\
 \psi_{-, \mu}^n \swarrow & & \searrow \psi_{+, n-1}^n \\
 & \Gamma_n &
 \end{array}$$

$$\begin{array}{ccc}
 \Gamma_\mu & \xrightarrow{\psi_{-, n-1}^\mu} & \Gamma_{n-1} \\
 \psi_{+, \mu}^n \swarrow & & \searrow \psi_{-, n-1}^n \\
 & \Gamma_n &
 \end{array}$$

$$\begin{array}{ccc}
 \Gamma_{n-1} & \xrightarrow{\psi_{+, n-1}^{\frac{2n-1}{2}}} & \Gamma_{\frac{2n-1}{2}} \\
 \psi_{+, n}^{n-1} \swarrow & & \searrow \psi_{-, n}^{\frac{2n-1}{2}} \\
 & \Gamma_n &
 \end{array}$$

$$\begin{array}{ccc}
 \Gamma_{n-1} & \xrightarrow{\psi_{-, n-1}^{\frac{2n-1}{2}}} & \Gamma_{\frac{2n-1}{2}} \\
 \psi_{-, n}^{n-1} \swarrow & & \searrow \psi_{+, n}^{\frac{2n-1}{2}} \\
 & \Gamma_n &
 \end{array}$$

Lemma 2.10. *For any $n \in \mathbb{Z}$, we have the following exact triangles.*

$$\begin{array}{ccc}
 \Gamma_n & \xrightarrow{H_n} & \Gamma_{n+1} \\
 & \swarrow G_n & \searrow F_{n+1} \\
 & \mathbf{Y} &
 \end{array}$$

$$\begin{array}{ccc}
 \Gamma_\mu & \xrightarrow{A_{n-1}} & \Gamma_{n-1} \\
 & \swarrow C_n & \searrow B_{n-1} \\
 & \mathbf{Y}_n &
 \end{array}$$

Lemma 2.11. *For any $n \in \mathbb{Z}$, we have the following commutative diagrams up to scalars*

$$\begin{array}{cc}
\begin{array}{ccc}
\Gamma_n & \xrightarrow{\psi_{+,n+1}^n} & \Gamma_{n+1} \\
& \swarrow G_n & \searrow G_{n+1} \\
& \mathbf{Y} &
\end{array} &
\begin{array}{ccc}
\Gamma_n & \xrightarrow{\psi_{-,n+1}^n} & \Gamma_{n+1} \\
& \swarrow G_n & \searrow G_{n+1} \\
& \mathbf{Y} &
\end{array} \\
\begin{array}{ccc}
\Gamma_n & \xrightarrow{\psi_{+,n+1}^n} & \Gamma_{n+1} \\
& \searrow F_n & \swarrow F_{n+1} \\
& \mathbf{Y} &
\end{array} &
\begin{array}{ccc}
\Gamma_n & \xrightarrow{\psi_{-,n+1}^n} & \Gamma_{n+1} \\
& \searrow F_n & \swarrow F_{n+1} \\
& \mathbf{Y} &
\end{array}
\end{array}$$

Lemma 2.12 ([LY22a, Lemma 4.17, Proposition 4.26, Lemma 4.29 and Proposition 4.32]). *Let F_n and G_n be defined as in Lemma 2.10. Then for any large enough integer n , we have the following properties*

- (1) *The map G_{n-1} is zero and F_n is surjective. Moreover, for any grading*

$$g - \frac{np - q - 1}{2} \leq i_0 \leq \frac{np - q - 1}{2} - g - p + 1,$$

the restriction of the map

$$F_n : \bigoplus_{i=0}^{p-1} (\Gamma_n, i_0 + i) \rightarrow \mathbf{Y}$$

is an isomorphism.

- (2) *The map F_{-n+1} is zero and G_{-n} is injective. Moreover, for any grading*

$$g - \frac{np + q - 1}{2} \leq i_0 \leq \frac{np + q - 1}{2} - g - p + 1,$$

the map

$$\text{Proj} \circ G_{-n} : \mathbf{Y} \rightarrow \bigoplus_{i=0}^{p-1} (\Gamma_{-n}, i_0 + i),$$

is an isomorphism, where

$$\text{Proj} : \Gamma_{-n} \rightarrow \bigoplus_{i=0}^{p-1} (\Gamma_{-n}, i_0 + i)$$

is the projection.

Lemma 2.13. *For any $n \in \mathbb{Z}$, let the maps H_n and $\psi_{\pm, n+1}^n$ be defined as in Lemma 2.10 and Lemma 2.4 respectively. Then there exist $c_1, c_2 \in \mathbb{C} \setminus \{0\}$ so that*

$$H_n = c_1 \psi_{+, n+1}^n + c_2 \psi_{-, n+1}^n$$

Convention. Though maps between projectively transitive systems are only well-defined up to scalars in $\mathbb{C} \setminus \{0\}$, in [LY22b, Section 2.3], we introduced a way to fix the representatives of the systems and the scalars of maps between them. Hence we can consider sutured instanton homologies used in this paper as actual vector spaces and all commutative diagrams above hold without introducing scalars except the second commutative diagram in Lemma 2.6. Moreover, we can set the scalars $c_1 = 1$ and $c_2 = -1$ for any $n \in \mathbb{Z}$ in Lemma 2.13.

2.3. Integral surgery formulae. Suppose $K \subset Y$ is a rationally null-homologous knot with a Seifert surface S . Suppose (λ, μ) is the chosen framing for K and (p, q) defined as in Section 2.2. Then we state two versions of integral surgery formulae, one from the sutured theory and the other from the bent complex.

Theorem 2.14 ([LY22b, Theorem 3.1]). *Suppose m is a fixed integer such that $mp - q \neq 0$, i.e., the suture Γ_m is not parallel to ∂S . Then for any large enough integer k , there exists an exact triangle*

$$\begin{array}{ccc} \Gamma_{\frac{2m+2k-1}{2}} & \xrightarrow{\pi} & \Gamma_{m+2k-1} \\ & \searrow & \swarrow \\ & \mathbf{Y}_m & \end{array}$$

where $\pi = \pi_{m,k}^+ + \pi_{m,k}^-$ and

$$\pi_{m,k}^\pm = \Psi_{\pm, m+2k-1}^{m+k} \circ \psi_{\mp, m+k}^{\frac{2m+2k-1}{2}}$$

are compositions of bypass maps. Hence we have an isomorphism

$$\mathbf{Y}_m \cong H(\text{Cone}(\pi_{m,k}^+ + \pi_{m,k}^-)) \cong \ker \pi \oplus \text{coker } \pi.$$

In [LY21c, Section 3.4], for any rationally null-homologous knot $K \subset Y$, we constructed two spectral sequences $\{E_{r,+}, d_{r,+}\}_{r \geq 1}$ and $\{E_{r,-}, d_{r,-}\}_{r \geq 1}$ from Γ_μ to \mathbf{Y} , where the \mathbb{Z} -grading shift of $d_{r,\pm}$ is $\pm rp$. Sketchly, we obtain two spectral sequences from the following unrolled exact couples about bypass maps

$$(2.1) \quad \begin{array}{ccccccc} \cdots & \longleftarrow & \Gamma_{n+1} & \xleftarrow{\psi_{\pm, n+1}^n} & \Gamma_n & \xleftarrow{\psi_{\pm, n}^{n-1}} & \Gamma_{n-1} & \xleftarrow{\psi_{\pm, n-1}^{n-2}} & \Gamma_{n-2} & \longleftarrow & \cdots \\ & & \searrow & \nearrow & \searrow & \nearrow & \searrow & \nearrow & \searrow & \nearrow & \\ & & \Gamma_\mu & & \Gamma_\mu & & \Gamma_\mu & & \Gamma_\mu & & \end{array}$$

The spectral sequences are independent of the choice of n . Then we lift the spectral sequences to filtered chain complexes with differentials d_+ and d_- by fixing an inner product on Γ_μ . By construction we have

$$H(\Gamma_\mu, d_+) \cong H(\Gamma_\mu, d_-) \cong \mathbf{Y}.$$

Definition 2.15 ([LY21c, Construction 3.27 and Definition 5.12]). For any rationally null-homologous knot $K \subset Y$, let $B^\pm(K)$ be the complexes (Γ_μ, d_\pm) . For any integer s , define the **bent complex**

$$A(K, s) := \left(\bigoplus_{k \in \mathbb{Z}} (\Gamma_\mu, s + kp), d_s \right),$$

where for any element $x \in (\Gamma_\mu, s + kp)$,

$$d_s(x) = \begin{cases} d_+(x) & k > 0, \\ d_+(x) + d_-(x) & k = 0, \\ d_-(x) & k < 0. \end{cases}$$

Let $B^\pm(K, s)$ be copies of $B^\pm(K)$. Define

$$\pi^+(K, s) : A(K, s) \rightarrow B^+(K, s) \text{ and } \pi^-(K, s) : A(K, s) \rightarrow B^-(K, s)$$

by

$$\pi^+(K, s)(x) = \begin{cases} x & k \geq 0, \\ 0 & k < 0, \end{cases} \text{ and } \pi^-(K, s)(x) = \begin{cases} x & k \leq 0, \\ 0 & k > 0, \end{cases}$$

where $x \in (\mathbf{\Gamma}_\mu, s + kp)$. Define

$$\pi^\pm(K) : \bigoplus_{s \in \mathbb{Z}} A(K, s) \rightarrow \bigoplus_{s \in \mathbb{Z}} B^\pm(K, s)$$

by putting $\pi^\pm(K, s)$ together for all s . We also use the same notation for the induced map on homology. If K is fixed, we will omit it in $A(K, s)$, $B^\pm(K, s)$ and $\pi^\pm(K, s)$.

Theorem 2.16 ([LY22b, Theorem 3.18]). *Suppose m is a fixed integer such that $mp - q \neq 0$. Then there exists a grading preserving isomorphism*

$$\Xi_m : \bigoplus_{s \in \mathbb{Z}} H(B^+(s)) \xrightarrow{\cong} \bigoplus_{s \in \mathbb{Z}} H(B^-(s + mp - q))$$

so that

$$\mathbf{Y}_m \cong H \left(\text{Cone}(\pi^- + \Xi_m \circ \pi^+ : \bigoplus_{s \in \mathbb{Z}} H(A(s)) \rightarrow \bigoplus_{s \in \mathbb{Z}} H(B^-(s))) \right).$$

Remark 2.17. Theorem 2.14 is a little stronger than Theorem 2.16 when we consider the $\Lambda^* H_1(Y; \mathbb{C})$ -action on the sutured instanton homology. From Corollary 5.4, the action is trivial on $\mathbf{\Gamma}_\mu$ of the Borromean knot, and hence is trivial on the bent complex. But it is nontrivial on $\mathbf{\Gamma}_n$ by Lemma 5.3. In this paper, we will use both versions of surgery formulae.

2.4. Truncation of the integral surgery formulae. In this subsection, we will use the following algebraic lemma to truncate the integral surgery formula.

Lemma 2.18. *Suppose (C, d_C) is a chain complex and suppose $C = D \oplus E \oplus F$. For $A, B \in \{D, E, F\}$, we write $d_B^A : A \rightarrow B$ for the restriction of d_C . We write elements in C as column vectors. Suppose d_C has the form*

$$d_C = \begin{pmatrix} 0 & d_E^D & 0 \\ 0 & 0 & 0 \\ 0 & d_E^F & d_F^F \end{pmatrix}$$

where d_E^D is an isomorphism. Then we have an isomorphism

$$H(C, d_C) \cong H(F, d_F^F).$$

Proof. We have a short exact sequence

$$0 \rightarrow D \oplus E \rightarrow C \rightarrow F \rightarrow 0$$

which induces a long exact sequence. The assumption on d_C implies $H(D \oplus E) = 0$ and hence $H(C) \cong H(F)$. \square

We also need some structural lemmas for sutured instanton homologies.

Lemma 2.19. *Suppose $K \subset Y$ is a framed rationally null-homologous knot. Suppose $n \in \mathbb{Z}$ so that $(n - 1)p - q \geq 2g$, then we have the following.*

- (1) *When $|i| > \frac{np - q - 1}{2} + g$, we have $(\mathbf{\Gamma}_n, i) = 0$.*
- (2) *When $\frac{np - q - 1}{2} + g \geq i \geq g - \frac{np - q - 1}{2}$, we have an isomorphism*

$$\psi_{\mp, n+1}^n : (\mathbf{\Gamma}_n, \pm i) \xrightarrow{\cong} (\mathbf{\Gamma}_{n+1}, \pm i \pm \frac{p}{2}).$$

(3) When $\frac{np-q-1}{2} - g \geq i, j \geq g - \frac{np-q-1}{2}$ and $i - j = p$, we have an isomorphism

$$(\psi_{-,n+1}^n)^{-1} \circ \psi_{+,n+1}^n : (\mathbf{\Gamma}_n, i) \xrightarrow{\cong} (\mathbf{\Gamma}_n, j).$$

(4) When $g - \frac{np-q-1}{2} \leq i_0 \leq \frac{np-q-1}{2} - g - p + 1$, the restriction of the map

$$F_n : \bigoplus_{i=0}^{p-1} (\mathbf{\Gamma}_n, i_0 + i) \rightarrow \mathbf{Y}$$

is an isomorphism.

Proof. Part (1) follows directly from Lemma 2.3. Part (2) and (3) follows from Lemma 2.3 and Lemma 2.4. Part (4) follows from [LY22b, Lemma 2.19 part (1)]. \square

Lemma 2.20. *Suppose $K \subset Y$ is a framed rationally null-homologous knot. Suppose $n \in \mathbb{Z}$ so that $(n-1)p - q \geq 2g$. Then we have the following.*

(1) When $|i| > \frac{(2n-1)p-2q-1}{2} + g$, we have

$$(\mathbf{\Gamma}_{\frac{2n-1}{2}}, i) = 0.$$

(2) When $\frac{(2n-1)p-2q-1}{2} + g \geq i \geq g - \frac{p-1}{2}$, we have an isomorphism

$$\psi_{\pm, n}^{\frac{2n-1}{2}} : (\mathbf{\Gamma}_{\frac{2n-1}{2}}, \pm i) \xrightarrow{\cong} (\mathbf{\Gamma}_n, \pm i \mp \frac{(n-1)p+q}{2}).$$

(3) When $\frac{(2n-1)p-2q-1}{2} - g \geq i \geq g - \frac{(2n-1)p-2q-1}{2}$, we have an isomorphism

$$(\mathbf{\Gamma}_{\frac{2n-1}{2}}, i) \cong H(A(i)),$$

where $A(i)$ is the bent complex defined as in Definition 2.15.

Proof. Part (1) follows directly from Lemma 2.3. Part (2) follows from Lemma 2.8 and Lemma 2.19 part (1). Part (3) follows from [LY21c, Theorem 3.23]. \square

Lemma 2.21. *Suppose $K \subset Y$ is a framed rationally null-homologous knot. Suppose $\pi_{m,k}^{\pm}$ is defined as in Theorem 2.14. Let $\pi_{m,k}^{\pm, i}$ be the restriction of $\pi_{m,k}^{\pm}$ on $(\mathbf{\Gamma}_{\frac{2m+2k-1}{2}}, i)$. Then we have the following.*

(1) We have

$$\text{Im } \pi_{m,k}^{\pm, i} \subset (\mathbf{\Gamma}_{m+2k-1}, i \pm \frac{mp-q}{2}).$$

(2) When $i > \frac{p-1}{2} + g$, we have $\pi_{m,k}^{\pm, \pm i} = 0$.

(3) When $i \geq \frac{p-1}{2} + g$, the map $\pi_{m,k}^{\mp, \pm i}$ is an isomorphism.

Proof. Part (1) follows directly from grading shifts in Lemma 2.4 and Lemma 2.8. For the grading i in part (2), by Lemma 2.8 and Lemma 2.19, we have

$$\psi_{\mp, m+k}^{\frac{2m+2k-1}{2}} = 0$$

and hence $\pi_{m,k}^{\pm, \pm i} = 0$. Part (3) follows from Lemma 2.20 part (2) and Lemma 2.19 part (2). \square

Proposition 2.22. *Suppose $m \in \mathbb{Z}$ so that $mp - q \neq 0$. Then for any large enough integer k , we have the following.*

(1) If $(m-1)p - q + 2 < 2g$, then

$$\begin{aligned} \mathbf{Y}_m &\cong H\left(\text{Cone}(\pi' : \bigoplus_{|i| < \frac{p-1}{2} + g} (\mathbf{\Gamma}_{\frac{2m+2k-1}{2}}, i) \rightarrow \bigoplus_{|i| < \frac{(1-m)p+q-1}{2} + g} (\mathbf{\Gamma}_{m+2k-1}, i))\right), \\ &\cong H\left(\text{Cone}(\pi'' : \bigoplus_{|s| < \frac{p-1}{2} + g} H(A(s)) \rightarrow \bigoplus_{s = -\frac{p-1}{2} + 1 - mp + q - g}^{\frac{p-1}{2} + g - 1} H(B^-(s)))\right). \end{aligned}$$

(2) If $(m-1)p - q + 2 \geq 2g$, then

$$\mathbf{Y}_m \cong \bigoplus_{i = \frac{p-1}{2} - mp + q + g}^{\frac{p-1}{2} + g - 1} (\mathbf{\Gamma}_{\frac{2m+2k-1}{2}}, i) \cong \bigoplus_{s = \frac{p-1}{2} - mp + q + g}^{\frac{p-1}{2} + g - 1} H(A(s)).$$

Here π' and π'' are the restrictions of π and $\pi^- + \Xi_m \circ \pi^+$ as defined in Theorem 2.14 and Theorem 2.16.

Proof. This is a reduction of Theorem 2.14 and Theorem 2.16. We only prove the first isomorphism in each case. The proof of the second isomorphism follows directly by the reformulation of the integral surgery formula by bent complexes in [LY22b, Section 3.3].

From Lemma 2.21, the grading shift of $\pi_{m,k}^\pm$ is $\frac{mp-q}{2}$. When $i > \frac{p-1}{2} + g$, we have $\pi_{m,k}^{+,i} = 0$ and $\pi_{m,k}^{-,i}$ is isomorphism. Let C_1 be the total mapping cone in Theorem 2.14 and let

$$D_1 = \bigoplus_{i > \frac{p-1}{2} + g} (\mathbf{\Gamma}_{\frac{2m+2k-1}{2}}, i) \text{ and } E_1 = \bigoplus_{i > \frac{p-1}{2} - \frac{mp-q}{2} + g} (\mathbf{\Gamma}_{m+2k-1}, i).$$

Then π restricts to $\pi_{m,k}^-$ on D and induce an isomorphism of $D \cong E$. Then we apply Lemma 2.18 to remove $D_1 \oplus E_1$ from C_1 . Let C_2 be the quotient $C_1 / (D_1 \oplus E_1)$. Since $\pi_{m,k}^{-,i}$ is also an isomorphism for $i = \frac{p-1}{2} + g$, we can apply Lemma 2.18 again to remove

$$D_2 = (\mathbf{\Gamma}_{\frac{2m+2k-1}{2}}, \frac{p-1}{2} + g) \text{ and } E_2 = (\mathbf{\Gamma}_{\frac{2m+2k-1}{2}}, \frac{p-1}{2} - \frac{mp-q}{2} + g)$$

from C_2 . Let C_3 be the quotient $C_2 / (D_2 \oplus E_2)$. Note that the grading induced by the Seifert surface is either a \mathbb{Z} -grading or a $(\mathbb{Z} + \frac{1}{2})$ -grading. If

$$\frac{p-1}{2} - \frac{mp-q}{2} + g > \frac{1}{2},$$

then we can similarly apply Lemma 2.18 to

$$D_3 = \bigoplus_{i < -\frac{p-1}{2} - g} (\mathbf{\Gamma}_{\frac{2m+2k-1}{2}}, i) \text{ and } E_3 = \bigoplus_{i < -\frac{p-1}{2} + \frac{mp-q}{2} - g} (\mathbf{\Gamma}_{m+2k-1}, i)$$

and then also

$$D_4 = (\mathbf{\Gamma}_{\frac{2m+2k-1}{2}}, -\frac{p-1}{2} - g) \text{ and } E_4 = (\mathbf{\Gamma}_{\frac{2m+2k-1}{2}}, -\frac{p-1}{2} + \frac{mp-q}{2} - g).$$

We conclude that

$$H(C_1) \cong H\left(\text{Cone}(\pi' : \bigoplus_{|i| < \frac{p-1}{2} + g} (\mathbf{\Gamma}_{\frac{2m+2k-1}{2}}, i) \rightarrow \bigoplus_{|i| < \frac{(1-m)p+q-1}{2} + g} (\mathbf{\Gamma}_{m+2k-1}, i))\right).$$

If

$$\frac{p-1}{2} - \frac{mp-q}{2} + g \leq \frac{1}{2},$$

then we can apply Lemma 2.18 to

$$D'_3 = \bigoplus_{i < \frac{p-1}{2} - mp + q + g} (\Gamma_{\frac{2m+2k-1}{2}}, i) \text{ and } E'_3 = \bigoplus_{i < \frac{p-1}{2} - \frac{mp-q}{2} + g} (\Gamma_{m+2k-1}, i).$$

We conclude that

$$H(C_1) \cong \bigoplus_{i = \frac{p-1}{2} - mp + q + g}^{\frac{p-1}{2} + g - 1} (\Gamma_{\frac{2m+2k-1}{2}}, i)$$

□

If K is null-homologous, then $(p, q) = (1, 0)$. The inequality $(m-1)p - q + 2 \geq 2g$ reduces to $m \geq 2g - 1$. In such case, the result in Proposition 2.22 is indeed stronger than the large surgery formula in [LY21c, Theorem 1.22] because the assumption in that paper is $m \geq 2g + 1$. This difference is essential when g is small (e.g. $g = 1$).

Proposition 2.23. *Suppose $K \subset Y$ is a null-homologous knot bounding a Seifert surface of genus 1. Then for any $m \in \mathbb{N}_+$, we have*

$$\dim I^\sharp(Y_m(K)) = \dim I^\sharp(Y_1(K)) + (m-1) \cdot \dim I^\sharp(Y).$$

Proof. Since $g = 1$, we apply Proposition 2.22 part (2) to any $m > 0$. In particular, we have

$$\mathbf{Y}_1 \cong H(A(0)) \text{ and } \mathbf{Y}_m \cong \bigoplus_{s=-m+1}^0 H(A(s)).$$

By construction of $A(s)$ in Definition 2.15, we know

$$H(A(s)) \cong H(B^+(s)) \cong \mathbf{Y}$$

for any $s < 0$. Since $\dim I^\sharp(-Y) = \dim I^\sharp(Y)$ for any closed 3-manifold Y , we conclude the dimension equality. □

Remark 2.24. When Y is a rational homology sphere, this corollary follows directly from the adjunction inequality for the instanton cobordism map; see for example [BS19, Theorem 1.16]. However, for technical reasons such adjunction inequality relies on the assumption that the first Betti number of the cobordism vanishes. So when $b_1(Y) > 0$, the existing adjunction inequality does not apply.

2.5. Instanton tau invariant. We present some results from [GLW19] for knots inside S^3 .

Definition 2.25 ([Li19, Definition 5.4]). Suppose $K \subset Y$ is a rationally null-homologous knot. Let $\underline{\text{KHI}}^-(-Y, K)$ be the direct limit of

$$\cdots \rightarrow \Gamma_n \xrightarrow{\psi_{-,n+1}^n} \Gamma_{n+1} \xrightarrow{\psi_{-,n+2}^n} \Gamma_{n+2} \rightarrow \cdots.$$

Let U be the action on $\underline{\text{KHI}}^-(-Y, K)$ defined by $\{\psi_{+,n+1}^n\}_{n \in \mathbb{N}_+}$. It is well-defined due to the commutativity from Lemma 2.6.

Definition 2.26 ([Li19, Definition 5.7]). Suppose $K \subset S^3$ is a knot. We define

$$\tau_I(K) = \max\{i \mid \exists x \in \underline{\text{KHI}}^-(-S^3, K, i) \text{ s.t. } U^j \cdot x \neq 0 \text{ for any } j \geq 0\}.$$

We have the following basic properties for τ_I .

Lemma 2.27. *Suppose $K \subset S^3$ is a knot. Then we have the following.*

(1) ([GLW19, Proposition 3.17 and Corollary 5.3]) *For $n \in \mathbb{Z}$ large enough, we have*

$$\begin{aligned} \tau_I(K) &= \max\{i \mid \exists x \in (\Gamma_n, i) \text{ s.t. } F_n(x) \neq 0 \in I^\sharp(-S^3)\} - \frac{n-1}{2} \\ &= \min\{i \mid \exists x \in (\Gamma_n, i) \text{ s.t. } F_n(x) \neq 0 \in I^\sharp(-S^3)\} + \frac{n-1}{2}. \end{aligned}$$

(2) ([GLW19, Proposition 1.12 and Proposition 1.14]) *We have $\tau_I(K) = -\tau_I(\bar{K})$ where \bar{K} is the mirror of K .*

Lemma 2.28 ([GLW19, Section 5]). *Suppose $K \subset S^3$ is a knot. Then we have the following.*

(1) *For any $*$ $\in \mathbb{Q} \cup \{\mu\}$, we have $(\Gamma_*, i) \cong (\Gamma_*, -i)$.*

(2) *For any $n \in \mathbb{Z}$, we have*

$$\dim \Gamma_n = \dim \Gamma_{-2\tau_I(K)} + |n + 2\tau_I(K)|$$

3. A RATIONAL SURGERY FORMULA

Suppose K is a null-homologous knot in a 3-manifold Y . In this section, we will study the u/v -surgery on K . The integral surgery formula Theorem 2.16 is an analog of the Morse (integral) surgery formula for Heegaard Floer homology in [OS11, Section 6]. To generalize the formula to rational surgeries, we use the same strategy as in [OS11, Section 7]. For simplicity, we use similar notations as in Ozsváth-Szabó's work [OS11]. The symbols (p, q, r, a) in [OS11] are replaced by (u, v, r, m) since we define p and q in Section 2.2 (indeed $(p, q) = (1, 0)$ because K is null-homologous). Suppose

$$m = \lfloor \frac{u}{v} \rfloor$$

is the greatest integer smaller than or equal to u/v , and

$$\frac{u}{v} = m + \frac{r}{v}.$$

Let $O_{v/r}$ be the knot obtained by viewing one component of the Hopf link as a knot inside the lens space $L(v, -r)$ thought of as $-v/r$ surgery on the other component of the Hopf link, which is framed by the Seifert framing of the unknot in S^3 . Note that $O_{v/r}$ is a **core knot** of the lens space, *i.e.*, the complement is a solid torus. Since $Y_{u/v}(K)$ can be obtained by m -surgery on the connected sum

$$K \# O_{v/r} \subset Y \# L(v, -r),$$

it suffices to understand the bent complex associated to $K \# O_{v/r}$ in terms of the bent complex of K .

3.1. The connected sum with a core knot. Given two knots $K_i \subset Y_i$ for $i = 1, 2$, let $K' \subset Y'$ be the connected sum of K_1 and K_2 . Note that $Y' \setminus N(K')$ is obtained from gluing $Y_i \setminus N(K_i)$ by an annulus along the meridians of K_i for $i = 1, 2$. Conversely, the disjoint union of $Y_i \setminus N(K_i)$ is obtained from $Y' \setminus N(K')$ by a product annulus decomposition in the sense of [KM10b, Proposition 6.7]. The instanton version of that proposition implies

$$(3.1) \quad \underline{\text{KHI}}(Y', K') \cong \underline{\text{KHI}}(Y_1, K_1) \otimes \underline{\text{KHI}}(Y_2, K_2).$$

Moreover, if K_i are rationally null-homologous, in our previous work [LY21c, Proposition 5.15], we generalized the above isomorphism to a graded version with respect to gradings associated to Seifert surfaces. (Note the result in [LY21c, Proposition 5.15] states for knots inside rational homology spheres but the proof works for rationally null-homologous knots inside arbitrary 3-manifolds.) However, we need a stronger version of the connected sum formula which encodes the information

in bent complexes. Inspired by the formula in Heegaard Floer theory [OS04, Lemma 7.1], we have the following conjecture.

Conjecture 3.1. Suppose $K_i \subset Y_i$ for $i = 1, 2$ are rationally null-homologous knots. Then there exist chain homotopy equivalences

$$B^\pm(K_1 \# K_2) \simeq B^\pm(K_1) \otimes B^\pm(K_2),$$

where $B^\pm(K)$ is defined in Definition 2.15.

The proof of the above conjecture is an on-going project with Ghosh [GLY]. In this subsection, we only prove the special case where K_2 is a core knot in a lens space. First, we present some results for core knots.

Lemma 3.2 ([Li19, Proposition 4.10]). *Suppose K is a core knot in a lens space Y , then we have*

$$(\mathbf{\Gamma}_{r/s}, i) \cong \mathbb{C} \text{ for any } |i| \leq \frac{|rp - sq| - 1}{2}.$$

For other grading i , we have $(\mathbf{\Gamma}_{r/s}, i) = 0$.

Corollary 3.3. *Suppose K is a core knot in a lens space Y . Then the bypass exact triangles in Lemma 2.4 are always split, and there are two canonical isomorphisms induced by bypass maps between the direct sum of two spaces with smaller dimensions and the third space.*

Proof. From Lemma 3.2, we know dimensions of $\mathbf{\Gamma}_n, \mathbf{\Gamma}_{n+1}, \mathbf{\Gamma}_\mu$ are $|np - q|, |(n+1)p - q|, |p|$, respectively. Since the sum of two smaller integers equals to the third integer, we know the triangles always split. Since each nontrivial grading summands $\mathbf{\Gamma}_n, \mathbf{\Gamma}_{n+1}, \mathbf{\Gamma}_\mu$ are 1-dimensional, the restrictions of the bypass maps induce the canonical isomorphisms. \square

From Lemma 3.2, for a core knot $K \subset Y$, we have

$$\dim \underline{\text{KHI}}(-Y, K) = \dim I^\#(-Y) \text{ and } d_\pm = 0.$$

Then Conjecture 3.1 reduces to the following proposition.

Proposition 3.4. *Suppose $K_1 \subset Y_1$ is a rationally null-homologous knot and $K_2 \subset Y_2$ is a core knot in a lens space. Then there exist identifications*

$$B^\pm(K_1 \# K_2) = B^\pm(K_1) \otimes \underline{\text{KHI}}(-Y_2, K_2).$$

Convention. To distinguish sutures for different knot complements, we write $\mathbf{\Gamma}_{r/s}^\bullet, \psi_{\pm, n+1}^{n, \bullet}$, and F_n^\bullet with $\bullet \in \{1, 2, \#\}$ for the sutured instanton homology, bypass maps, and the cobordism maps in Lemma 2.10 associated to the knots K_1, K_2 and $K_1 \# K_2$.

To prove Theorem 3.4, we need the following lemma, which generalizes results in [GLW19, Section 3.2].

Lemma 3.5. *Suppose $K_i \subset Y_i$ for $i = 1, 2$ is a rationally null-homologous knot. Suppose n and k are large integers. Then there exist maps*

$$C_{\pm, n+k}^{n, k} : \mathbf{\Gamma}_n^1 \otimes \mathbf{\Gamma}_k^2 \rightarrow \mathbf{\Gamma}_{n+k}^\# \text{ and } C_{\pm, \mu}^{\mu, k} : \mathbf{\Gamma}_\mu^1 \otimes \mathbf{\Gamma}_k^2 \rightarrow \mathbf{\Gamma}_\mu^\#$$

so that we have the following commutative diagrams.

$$(3.2) \quad \begin{array}{ccccc} \Gamma_\mu^1 \otimes \Gamma_k^2 & \xrightarrow{\psi_{\pm, n}^{\mu, 1} \otimes \text{Id}} & \Gamma_n^1 \otimes \Gamma_k^2 & \xrightarrow{\psi_{\pm, \mu}^{n, 1} \otimes \text{Id}} & \Gamma_\mu^1 \otimes \Gamma_k^2 \\ C_{\pm, \mu}^{\mu, k} \downarrow & & C_{\pm, n+k}^{n, k} \downarrow & & C_{\pm, \mu}^{\mu, k} \downarrow \\ \Gamma_\mu^\# & \xrightarrow{\psi_{\pm, n+k}^{\mu, \#}} & \Gamma_{n+k}^\# & \xrightarrow{\psi_{\pm, \mu}^{n+k, \#}} & \Gamma_\mu^\# \end{array}$$

$$(3.3) \quad \begin{array}{ccccc} \Gamma_n^1 \otimes \Gamma_k^2 & \xrightarrow{\psi_{\pm, n+1}^{n, 1} \otimes \text{Id}} & \Gamma_{n+1}^1 \otimes \Gamma_k^2 & \xrightarrow{F_{n+1}^1 \otimes F_k^2} & I^\#(-Y_1) \otimes I^\#(-Y_2) \\ C_{\pm, m+n}^{n, k} \downarrow & & C_{\pm, n+k+1}^{n+1, k} \downarrow & & \downarrow = \\ \Gamma_{n+k}^\# & \xrightarrow{\psi_{\pm, n+k+1}^{n+k, \#}} & \Gamma_{n+k+1}^\# & \xrightarrow{F_{n+k+1}^\#} & I^\#(-Y_\#) \end{array}$$

$$(3.4) \quad \begin{array}{ccc} \Gamma_\mu^1 \otimes \Gamma_k^2 & \xrightarrow{\text{Id} \otimes \psi_{\pm, \mu}^{k, 2}} & \Gamma_\mu^1 \otimes \Gamma_\mu^2 \\ C_{\pm, \mu}^{\mu, k} \searrow & & \swarrow = \\ & \Gamma_\mu^\# & \end{array}$$

where the identification in (3.3) comes from the connected sum formula for $I^\#$ (c.f. [Li18a, Section 1.8]) and the identification in (3.4) comes from the sutured decomposition along the product annulus.

Proof. The proof is similar to the arguments in [GLW19, Section 4], especially the proof of [GLW19, Lemma 4.3] and the proof of [GLW19, Proposition 1.14]. Although the proofs in [GLW19] was only carried out for knots inside S^3 , the same argument essentially works for rationally null-homologous knots in general 3-manifolds. Here we only sketch the proofs as follows. We only prove for the case involving positive bypasses. The case for the negative bypasses is similar.

We attach a 1-handle h^1 to $(Y_1 \setminus N(K_1), \Gamma_n^1) \sqcup (Y_2 \setminus N(K_2), \Gamma_k^2)$ so that the two attaching points of the one handles are on the curve $(n\mu_1 - \lambda_1) \subset \Gamma_n^1$ and $(k\mu_2 - \lambda_2) \subset \Gamma_k^2$ respectively. (For negative bypasses, we attach the 1-handle to $(\lambda_1 - n\mu_1)$ and $(\lambda_2 - k\mu_2)$ accordingly. Note that the orientations of curves are different.) See Figure 4. Then we can attach a 2-handle h^2 along the curve α which goes through the 1-handle h^1 and intersects the suture obtained from attaching the 1-handle twice, as shown in Figure 4. Define

$$C_{+, m+k}^{n, k} = C_{h^2} \circ C_{h^1}.$$

Here C_{h^2} and C_{h^1} are the contact handle attaching maps as introduced by Baldwin-Sivek in [BS16a]. Pick the bypass arc β so that it intersects the curve $(\lambda_2 - k\mu_2) \subset \Gamma_n^1$ once and its two end points are on the curve $(n\mu_1 - \lambda_1) \subset \Gamma_n^1$. See Figure 4. We know this is a positive bypass (c.f. [Li19]). Attaching a bypass along β yields $(Y_1 \setminus N(K_1), \Gamma_\mu)$.

Let $h^{1'}$ and $h^{2'}$ be the corresponding 1-handle and 2-handle attached to $(Y_1 \setminus N(K_1), \Gamma_\mu) \sqcup (Y_2 \setminus N(K_2), \Gamma_k^2)$. Define

$$C_{+, \mu}^{\mu, k} = C_{h^{2'}} \circ C_{h^{1'}}.$$

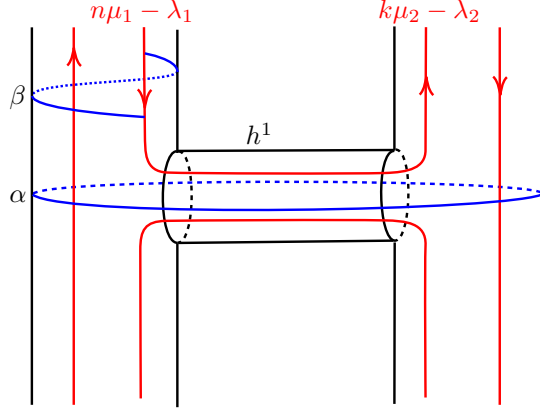

FIGURE 4. The 1-handle h^1 , the attaching curve α for the 2-handle h^2 , and the bypass arc β .

The commutative diagrams (3.2) and (3.3) are straightforward since the bypass arc and the contact handles are disjoint from each other. See also [GLW19, Diagram (4.4)] and proof of [GLW19, Proposition 1.14] for more detailed discussions. The proof of (3.4) is similar to that of [GLW19, Equation (4.6)]: let α' be the attaching curve of the 2-handle $h^{2'}$. We can isotope α' into a suitable position so that this contact 2-handle attachment correspond to the one in the construction of the bypass map as in [BS16a]. \square

Proof of Proposition 3.4. We only show the proof for d_+ . The proof for d_- is similar. To construct the differential d_+ , we need to use triangles about positive bypass maps in (2.1). Suppose m and n are large integers. Consider the following diagram.

(3.5)

$$\begin{array}{ccccccc}
 \cdots & \longleftarrow & \Gamma_{n+1}^1 \otimes \Gamma_k^2 & \xleftarrow{\psi_{+,n+1}^{n,1} \otimes \text{Id}} & \Gamma_n^1 \otimes \Gamma_k^2 & \xleftarrow{\psi_{+,n}^{n-1,1} \otimes \text{Id}} & \Gamma_{n-1}^1 \otimes \Gamma_k^2 & \longleftarrow \cdots \\
 & & \downarrow \psi_{+, \mu}^{n+1,1} \otimes \text{Id} & & \downarrow \psi_{+, \mu}^{n,1} \otimes \text{Id} & & \downarrow \psi_{+, \mu}^{\mu,1} \otimes \text{Id} & \\
 \cdots & & C_{+,n+k+1}^{n+1,k} & & \Gamma_{\mu}^1 \otimes \Gamma_k^2 & \xrightarrow{C_{+,n+k}^{n,k}} & \Gamma_{\mu}^1 \otimes \Gamma_k^2 & \xrightarrow{C_{+,n+k-1}^{n-1,k}} \cdots \\
 & & \downarrow \psi_{+, \mu}^{n+k+1, \#} & & \downarrow \psi_{+, \mu}^{n+k, \#} & & \downarrow \psi_{+, \mu}^{n+k-1, \#} & \\
 \cdots & \longleftarrow & \Gamma_{n+k+1}^{\#} & \xleftarrow{\psi_{+,n+k+1}^{n+k, \#}} & \Gamma_{n+k}^{\#} & \xleftarrow{\psi_{+,n+k}^{n+k-1, \#}} & \Gamma_{n+k-1}^{\#} & \longleftarrow \cdots \\
 & & \downarrow \psi_{+, \mu}^{n+k+1, \#} & & \downarrow \psi_{+, \mu}^{\mu, \#} & & \downarrow \psi_{+, \mu}^{n+k-1, \#} & \\
 \cdots & & \Gamma_{\mu}^{\#} & & \Gamma_{\mu}^{\#} & & \Gamma_{\mu}^{\#} & \cdots
 \end{array}$$

where the vertical maps from $\Gamma_{\mu}^1 \otimes \Gamma_k^2$ to $\Gamma_{\mu}^{\#}$ is $C_{+, \mu}^{\mu, k}$ in Lemma 3.5.

By (3.2) and (3.3) in Lemma 3.5, the squares in (3.5) involving vertical maps commute. Hence the vertical maps induce a morphism C_+ between unrolled exact couples. This induces a filtered chain map between $B^+(K_1) \otimes \Gamma_k^2$ to $B^+(K_1 \# K_2)$.

Since k is large, from Corollary 3.3, there is a canonical embedding of $\underline{\text{KHI}}(-Y_2, K_2) = \Gamma_\mu^2$ into Γ_k^2 via the inverse of $\psi_{+, \mu}^{k, 2}$. By precomposing this embedding, we obtain a filtered chain map between $B^+(K_1) \otimes \Gamma_\mu^2$ to $B^+(K_1 \# K_2)$. Then by (3.4), we know this filtered chain map is an identification on the first page. This implies that it induces an identification on each page and then the total filtered chain complex. \square

3.2. The formula for null-homologous knots. In this subsection, we combine Proposition 3.4 and the integral surgery formula to obtain rational surgery formulae for null-homologous knots. First, we do similar calculations as in [OS11, Lemma 7.2].

Lemma 3.6. *Suppose $K_1 \subset Y_1$ is a null-homologous knot and $K_2 = O_{v/r} \subset Y_2 = L(v, -r)$. Let $(Y_\#, K_\#)$ be the connected sum of K_1 and K_2 and suppose $K_\#$ is framed by the longitude of K_2 . Suppose $(\mu_\bullet, \lambda_\bullet)$ is the meridian and the longitude of K_\bullet for $\bullet \in \{1, 2, \#\}$. Then*

$$H_1(Y_\# \setminus N(K_\#)) \cong H_1(Y_1 \setminus N(K_1)).$$

Moreover, the order of $K_\#$ is v and the intersection number $\partial S_\# \cdot \lambda_\#$ is $-r$, where $S_\#$ is the Seifert surface of $K_\#$.

Proof. The knot K_1 is order 1 and $O_{v/r}$ is order v . Then

$$H_1(Y_1 \setminus N(K_1)) \cong H_1(Y_1) \oplus \mathbb{Z}\langle \mu_1 \rangle \text{ and } H_1(Y_2 \setminus N(K_2)) \cong \mathbb{Z}.$$

We write $g_1 = \mu_1$ and g_2 as the generator $H_1(Y_2 \setminus N(K_2))$. Then $\mu_2 = v \cdot g_2$ and $\lambda_2 = r \cdot g_2$. A calculation on the homology shows

$$\begin{aligned} (3.6) \quad H_1(Y_\# \setminus N(K_\#)) &\cong \left(H_1(Y_1 \setminus N(K_1)) \oplus H_1(Y_2 \setminus N(K_2)) \right) / (\mu_1, \mu_2) \\ &\cong \left(H_1(Y_1) \oplus \mathbb{Z}\langle g_1, g_2 \rangle \right) / (g_1 = v \cdot g_2) \\ &\cong H_1(Y_1) \oplus \mathbb{Z}\langle g_\# \rangle \\ &\cong H_1(Y_1 \setminus N(K_1)), \end{aligned}$$

where we write $g_\#$ as the generator. We also write pr as the projection to the summand generated by $g_\#$. Then

$$\text{pr}(\mu_\#) = v \cdot g_\# \text{ and } \text{pr}(\lambda_\#) = r \cdot g_\#.$$

Thus, the knot $K_\#$ is order v and $\partial S_\# \cdot \lambda_\# = -r$. \square

Corollary 3.7. *Let $K_\bullet \subset Y_\bullet$ for $\bullet \in \{1, 2, \#\}$ be defined in Lemma 3.6. Suppose $C_{\pm, m+k}^{n, k}$ and $C_{\pm, \mu}^{\mu, k}$ are defined in Lemma 3.5. Then we have explicit formulae of the grading shifts of the maps as follows.*

$$(3.7) \quad C_{\pm, m+k}^{n, k} \left(\left(\Gamma_n^1, i \pm \frac{n-1}{2} \right) \otimes \left(\Gamma_k^2, j \pm \frac{(k-1)v+r}{2} \right) \right) \subset \left(\Gamma_{n+k+1}^\#, iv + j \pm \frac{(n+k-1)v+r}{2} \right).$$

$$(3.8) \quad C_{\pm, \mu}^{\mu, k} \left(\left(\Gamma_\mu^1, i \right) \otimes \left(\Gamma_k^2, j \pm \frac{(k-1)v+r}{2} \right) \right) \subset \left(\Gamma_{n+k+1}^\#, iv + j \right).$$

Proof. First, we compute the grading shift of $C_{\pm, \mu}^{\mu, k}$. From the homology calculation in Lemma 3.6 and the graded version of (3.1) in [LY21c, Proposition 5.15], we have

$$(3.9) \quad (\Gamma_{\mu}^{\#}, s) \cong \bigoplus_{s_1 v + s_2 = s} (\Gamma_{\mu}^1, s_1) \otimes (\Gamma_{\mu}^2, s_2),$$

where we take the direct sum over $s_1 v + s_2 = s$ because $g_{\#} = v \cdot g_1 = g_2$ under the third isomorphism in (3.6). From Lemma 2.4, we know the grading shift of the map $\psi_{\pm, \mu}^{k, 2}$ is $\mp \frac{(k-1)v+r}{2}$. Then from (3.4), we know the grading shift of $C_{\pm, \mu}^{\mu, k}$ is described in (3.8).

Also from Lemma 2.4 and Lemma 3.6, we know the grading shifts of $\psi_{\pm, \mu}^{n, 1}$ and $\psi_{\pm, \mu}^{n+k, \#}$ are $\mp \frac{n-1}{2}$ and $\mp \frac{(n+k-1)v+r}{2}$, respectively. From (3.2) and (3.8), the expected grading shifts of $C_{\pm, m+k}^{n, k}$ is described in (3.7). Though in general $\psi_{\pm, \mu}^{n+k, \#}$ are not injective, we can still obtain (3.7) from the topological construction of $C_{\pm, m+k}^{n, k}$ in the proof of Lemma 3.5. The proof is similar to the proof of [GLW19, Lemma 4.3] and the only difference is that now the knot K_2 has order v so that a (rational) Seifert surface of the connected sum knot $K_1 \# K_2$ is obtained from one Seifert surface of K_2 and p copies of Seifert surfaces of K_1 by v many band sums. See Figure 5. \square

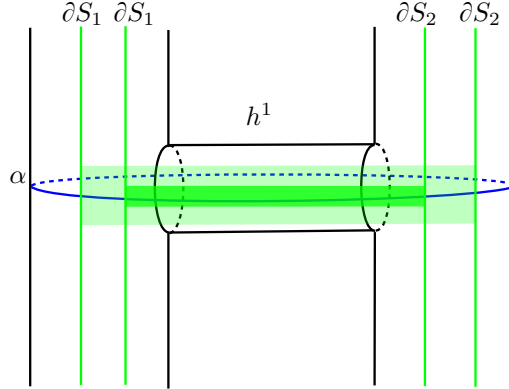

FIGURE 5. The band sum for the case $v = 2$. The two (green) shaded regions are the two bands.

Then we provide an identification of bent complexes.

Proposition 3.8. *Let $K_{\bullet} \subset Y_{\bullet}$ for $\bullet \in \{1, 2, \#\}$ be defined in Lemma 3.6. Then for any grading s , there is an identification*

$$A(K_{\#}, s) = A(K_1, s'),$$

where s' is the unique grading satisfying

$$|s - s'v| \leq \frac{v-1}{2}.$$

Moreover, we have the following commutative diagrams

$$\begin{array}{ccc} A(K_{\#}, s) & \xrightarrow{\pi^{\pm}(K_{\#}, s)} & B^{\pm}(K_{\#}, s) \\ \downarrow = & & \downarrow = \\ A(K_1, s') & \xrightarrow{\pi^{\pm}(K_1, s')} & B^{\pm}(K_1, s') \end{array}$$

Proof. From Lemma 3.2, we know (Γ_{μ}^2, s_2) is nontrivial only for $|s_2| \leq \frac{v-1}{2}$, for which the grading summand is 1-dimensional. Due to the homology result in Lemma 3.6, we can apply the graded version of (3.1) in (3.9) to show that

$$(\Gamma_{\mu}^{\#}, s) \cong \bigoplus_{s_1 v + s_2 = s} (\Gamma_{\mu}^1, s_1) \otimes (\Gamma_{\mu}^2, s_2) \cong (\Gamma_{\mu}^1, s').$$

Moreover, we have

$$\bigoplus_{k \geq 0} (\Gamma_{\mu}^{\#}, s + kv) \cong \bigoplus_{k \geq 0} (\Gamma_{\mu}^1, s' + k).$$

Note that two sides of the isomorphism are underlying spaces of subcomplexes of $B^+(K_{\#})$ and $B^+(K_1)$ since the orders of $K_{\#}$ and K_1 are v and 1 , respectively. From Proposition 3.4, the differentials d_+ on both sides are the same under the isomorphism. Similarly, we have

$$\bigoplus_{k \leq 0} (\Gamma_{\mu}^{\#}, s + kv) \cong \bigoplus_{k \leq 0} (\Gamma_{\mu}^1, s' + k),$$

and the differentials d_- on both sides are the same. Hence we conclude the identification about the bent complex (*c.f.* Definition 2.15). The commutative diagrams follow immediately. \square

Theorem 3.9. *Suppose $K \subset Y$ is a null-homologous knot. Suppose $u/v \in \mathbb{Q} \setminus \{0\}$. For any grading s , let s' and s'' be the unique gradings satisfying*

$$|s - s'v| \leq \frac{v-1}{2} \text{ and } |s + u - s''v| \leq \frac{v-1}{2}.$$

Then there exists a grading preserving isomorphism

$$\Xi_{u/v} : \bigoplus_{s \in \mathbb{Z}} H(B^+(s')) \xrightarrow{\cong} \bigoplus_{s \in \mathbb{Z}} H(B^-(s''))$$

so that

$$I^{\#}(-Y_{-u/v}(K)) \cong H\left(\text{Cone}(\pi^- + \Xi_{u/v} \circ \pi^+ : \bigoplus_{s \in \mathbb{Z}} H(A(s')) \rightarrow \bigoplus_{s \in \mathbb{Z}} H(B^-(s''))\right).$$

Proof. The statement is an analog of the rational surgery formula for \widehat{HF} in [OS11, Section 7.1], where π^- and $\Xi_{u/v} \circ \pi^+$ are analogs of \hat{v} and \hat{h} . Let $m = \lfloor u/v \rfloor$ and $u/v = m + r/v$. Following the strategy at the start of this section, set $K_1 = K$ and $K_2 = O_{v/r}$ to be a core knot in a lens space. Then $Y_{u/v}(K)$ is obtained by m -surgery on $K_{\#} = K_1 \# K_2$. From Theorem 2.16, we know there exists a grading preserving isomorphism

$$\Xi_m^{\#} : \bigoplus_{s \in \mathbb{Z}} H(B^+(K_{\#}, s)) \xrightarrow{\cong} \bigoplus_{s \in \mathbb{Z}} H(B^-(K_{\#}, s + mp - q))$$

so that

$$I^\sharp(-Y_{-u/v}(K)) \cong H\left(\text{Cone}(\pi^{-,\sharp} + \Xi_m^\# \circ \pi^{+,\sharp} : \bigoplus_{s \in \mathbb{Z}} H(A(K_\#, s)) \rightarrow \bigoplus_{s \in \mathbb{Z}} H(B^-(K_\#, s)))\right).$$

Note that $(p, q) = (v, -r)$ so $mp - q = u$.

From Proposition 3.8, we replace complexes of $K_\#$ by complexes of K_1 to obtain the rational surgery formula, where $\Xi_{u/v}$ is induced by $\Xi_m^\#$ under the identification. \square

Remark 3.10. The rational surgery formula for a rationally null-homologous knot is more complicated but still doable. In such case, the graded version of Künneth formula is not enough and we need a torsion spin^c -like decomposition for sutured instanton homology (*c.f.* [LY21a], Remark 1.4, and Remark 1.6).

4. THE 0-SURGERY FOR KNOTS IN THE 3-SPHERE

In this section, we deal with 0-surgery for knots inside S^3 . Recall we have

$$\begin{aligned} \pi_{m,k}^+ &= \Psi_{+,m+2k-1}^{m+k} \circ \psi_{-,m+k}^{\frac{2m+2k-1}{2}} : \mathbf{\Gamma}_{\frac{2m+2k-1}{2}} \rightarrow \mathbf{\Gamma}_{m+2k-1}, \\ \pi_{m,k}^- &= \Psi_{-,m+2k-1}^{m+k} \circ \psi_{+,m+k}^{\frac{2m+2k-1}{2}} : \mathbf{\Gamma}_{\frac{2m+2k-1}{2}} \rightarrow \mathbf{\Gamma}_{m+2k-1}, \end{aligned}$$

and $\pi_{m,k}^{\pm,i}$ be the restriction of $\pi_{m,k}^\pm$ on $(\mathbf{\Gamma}_{\frac{2m+2k-1}{2}}, i)$. For knots inside S^3 , we have a better description of the maps $\pi_{m,k}^{\pm,i}$ than in Lemma 2.21.

Lemma 4.1. *Suppose $K \subset S^3$ is a knot. Let $\tau = \tau_I(K)$ be defined in Definition 2.26. For any fixed integer m and large enough integer k , we have the following.*

- (1) *When $i > \tau$, $\pi_{m,k}^{+,i} = 0$. When $i < -\tau$, $\pi_{m,k}^{-,i} = 0$.*
- (2) *When $i < \tau$, $\pi_{m,k}^{+,i} \neq 0$. When $i > -\tau$, $\pi_{m,k}^{-,i} \neq 0$.*
- (3) *When $i \leq -g(K)$, $\pi_{m,k}^{+,i}$ is an isomorphism. When $i \geq g(K)$, $\pi_{m,k}^{-,i}$ is an isomorphism.*

Proof. For part (1), we only prove the statement regarding $\pi_{m,k}^+$. The statement regarding $\pi_{m,k}^-$ follows from the symmetry between K and $-K$, where $-K$ is the orientation reversal of K . Note when we switch the orientation of the knot, the tau invariant remains the same, π^\pm switches with each other, and the grading induced by the Seifert surface becomes the additive inverse. Let

$$\psi_{-,m+k}^{\frac{2m+2k-1}{2},i} = \psi_{-,m+k}^{\frac{2m+2k-1}{2}} \Big|_{(\mathbf{\Gamma}_{\frac{2m+2k-1}{2}}, i)}.$$

We know that

$$\pi_{m,k}^{+,i} = \Psi_{+,m+2k-1}^{m+k} \circ \psi_{-,m+k}^{\frac{2m+2k-1}{2},i}.$$

From Lemma 2.8 we know

$$\text{Im}(\psi_{-,m+k}^{\frac{2m+2k-1}{2},i}) \subset (\mathbf{\Gamma}_{m+k}, i + \frac{m+k-1}{2}).$$

When k is large enough so that $m+k$ is large, the map $\Psi_{+,m+2k-1}^{m+k}$ corresponds to the composition of $(k-1)$ many U -actions as in the construction of $\underline{\text{KHI}}^-$ in Definition 2.25. By the definition of τ in Definition 2.26, we immediately conclude that

$$\Psi_{+,m+2k-1}^{m+k} \Big|_{(\mathbf{\Gamma}_{m+k}, j)} = 0$$

whenever $j > \tau + \frac{m+k-1}{2}$. Hence as a result we have

$$\pi_{m,k}^{+,i} = 0$$

when $i > \tau$.

For part (2), again we only prove the statement involving $\pi_{m,k}^+$. By the definition of τ , and the correspondence between $\Psi_{+,m+2k-1}^{m+k}$ and U^{k-1} on $\underline{\text{KHI}}^-$, we know that when k is large enough, there exists

$$x \in (\Gamma_{m+k-\tau+i}, \tau + \frac{m+k-\tau+i-1}{2})$$

so that

$$\Psi_{+,m+2k-1}^{m+k-\tau+i}(x) \neq 0.$$

Take

$$y = \Psi_{+,m+k}^{m+k-\tau+i}(x) \in (\Gamma_{m+k}, i),$$

we know that

$$\Psi_{+,m+2k}^{m+k}(y) = \Psi_{+,m+2k-1}^{m+k-\tau+i}(x) \neq 0.$$

So it remains to show that $y \in \text{Im}(\psi_{-,m+k}^{\frac{2m+2k-1}{2},i})$. Indeed, from the construction of y we know that

$$\psi_{+,\mu}^{m+k}(y) = 0.$$

Then from Lemma 2.9, we know that

$$\psi_{-,m+k-1}^{m+k}(y) = \psi_{-,m+k}^{\mu} \circ \psi_{+,\mu}^{m+k}(y) = 0.$$

Hence by Lemma 2.8 we have

$$y \in \ker(\psi_{-,m+k-1}^{m+k}) = \text{Im}(\psi_{-,m+k}^{\frac{2m+2k-1}{2},i}).$$

Part (3) is a restatement of Lemma 2.21, part (3). \square

Next we study the 0-surgery for knots inside S^3 . The main obstruction to apply the proof of the integral surgery formula in [LY22b, Section 3.2] to the 0-surgery is that $\pi_{m,k}^+$ and $\pi_{m,k}^-$ have the same grading shift. Then

$$H(\text{Cone}(c_1\pi_{m,k}^+ + c_2\pi_{m,k}^-))$$

may depend on the scalars. If either map vanishes, then the homology is still independent of the scalars. However, this is not true in general. Fortunately, we can make use of the \mathbb{Z} -grading on $I^\sharp(S_0^3(K))$ in (1.1). Note that one of the restrictions of $\pi_{m,k}^\pm$ on a single grading vanishes.

Theorem 4.2 (0-surgery formula). *Suppose $K \subset S^3$ is a knot with $\tau_I(K) \leq 0$. Suppose $A(s), B^\pm(s)$ and $\pi^\pm(s) : A(s) \rightarrow B^\pm(s)$ are complexes and maps constructed in Definition 2.15. For any $s \in \mathbb{Z} \setminus \{0\}$, there exists an isomorphism*

$$\Xi_{0,s} : H(B^+(s)) \rightarrow H(B^-(s))$$

so that $I^\sharp(-S_0^3(K), s)$ is isomorphic to

$$H\left(\text{Cone}(\pi^-(s) + \Xi_{0,s} \circ \pi^+(s) : H(A(s)) \rightarrow H(B^-(s)))\right).$$

If $\tau_I(K) \neq 0$, then the same result also applies to $s = 0$.

Proof. From Lemma 2.10, we have a long exact sequence

$$\cdots \rightarrow \Gamma_\mu \xrightarrow{A_{-1}} \Gamma_{-1} \rightarrow I^\sharp(-S_0^3(K)) \rightarrow \Gamma_\mu \rightarrow \cdots$$

By the same reason in Lemma 2.13, we have

$$(4.1) \quad A_{-1} = c_1 \psi_{+,-1}^\mu + c_2 \psi_{-,-1}^\mu.$$

Following the construction of the gradings induced by Seifert surfaces, the maps in the long exact sequence are all grading preserving. We consider the following octahedral diagram that is used in [LY22b, Section 3.2].

$$(4.2) \quad \begin{array}{ccccc} & & \mathbf{Y}_m & \xrightarrow{\quad} & \Gamma_\mu \\ & \nearrow & \searrow \psi & \nearrow l' & \searrow \psi_{+,m-1}^\mu + \psi_{-,m-1}^\mu \\ & \Gamma_{m-1} & & \Gamma_{\frac{2m+2k-1}{2}} & \Gamma_{m-1} \\ & \nearrow (\Psi_{+,m-1+k}^{m-1}, \Psi_{-,m-1+k}^{m-1}) & & \nearrow h' & \searrow \phi \\ \psi_{+,m-1}^\mu + \psi_{-,m-1}^\mu & & \Gamma_{m-1+k} \oplus \Gamma_{m-1+k} & & \Gamma_{m-1} \\ & \nearrow (\psi_{-,m-1+k}^\mu, \psi_{+,m-1+k}^\mu) & & \searrow \Psi_{-,m-1+2k}^{m-1+k} - \Psi_{+,m-1+2k}^{m-1+k} & \nearrow l \\ \Gamma_\mu & & & & \Gamma_{m-1+2k} \end{array}$$

where

$$h' = \psi_{-, \frac{2m+2k-1}{2}}^{m+k-1} - \psi_{+, \frac{2m+2k-1}{2}}^{m+k-1}.$$

When $m = 0$, all maps are homogeneous, so we could consider the diagram grading-wise. Note that we may not know $c_1 = c_2 = 1$ in (4.1), but we can add scalars to other maps to make diagram still commute. Following the same strategy in [LY22b, Section 3.2], we obtain for any $s \in \mathbb{Z}$,

$$I^\sharp(-S_0^3(K), s) \cong H(\text{Cone}(c_3 \pi_{0,k}^{+,i} + c_4 \pi_{0,k}^{-,i}))$$

for some scalars c_3, c_4 .

When $\tau_I(K) \leq 0$, from Lemma 4.1, we know for any $i \in \mathbb{Z}$, either $\pi_{0,k}^{+,i}$ or $\pi_{0,k}^{-,i}$ vanishes, and hence $H(\text{Cone}(c_3 \pi_{0,k}^{+,i} + c_4 \pi_{0,k}^{-,i}))$ is independent of the scalars. Then we have

$$\begin{aligned} I^\sharp(-S_0^3(K), s) &\cong H(\text{Cone}(c_3 \pi_{0,k}^{+,i} + c_4 \pi_{0,k}^{-,i})) \\ &\cong H(\text{Cone}(\pi_{0,k}^{+,i} + \pi_{0,k}^{-,i})) \\ &\cong H(\text{Cone}(\pi^-(s) + \Xi_{0,s} \circ \pi^+(s))), \end{aligned}$$

where $\Xi_{0,s}$ is constructed similarly to Ξ_m for $m \neq 0$. \square

Remark 4.3. From Lemma 2.27 part (2), we may pass to the mirror knot to satisfy the assumption $\tau_I \leq 0$ in Theorem 4.2.

Baldwin-Sivek also studied framed instanton homology with twisted bundle for 0-surgery, which is denoted by $I^\sharp(S_0^3(K), \mu)$, where μ is the meridian of the knot. There is also a \mathbb{Z} -grading on this homology induced by the Seifert surface and we also have a long exact sequence

$$\cdots \rightarrow \Gamma_\mu \xrightarrow{c'_1 \psi_+ + c'_2 \psi_-} \Gamma_{-1} \rightarrow I^\sharp(-S_0^3(K), \mu) \rightarrow \Gamma_\mu \rightarrow \cdots$$

so that all maps are grading preserving (the coefficients c'_1 and c'_2 may be different from c_1 and c_2). Thus, we can use the similar octahedral diagram grading-wise to prove the result in Theorem 4.2 when replacing $I^\sharp(-S_0^3(K))$ by $I^\sharp(-S_0^3(K), \mu)$. As a result, we obtain the following corollary. We also write $I^\sharp(-S_0^3(K), \mu, i)$ for the grading summand of $I^\sharp(-S_0^3(K), \mu)$.

Corollary 4.4. *Suppose $K \subset S^3$ is a knot. For any $s \in \mathbb{Z} \setminus \{0\}$, we have*

$$I^\sharp(-S_0^3(K), s) \cong I^\sharp(-S_0^3(K), \mu, s).$$

5. SURGERIES ON BORROMEAN KNOTS

In this section, we study surgeries on the connected sums of Borromean knots.

5.1. The Borromean knot. First, we compute $\underline{\text{KHI}}$ of the Borromean knot. Let $T^3 = S_1^1 \times S_2^1 \times S_3^1$. Let Y be the result of a 0-surgery along $S_1^1 \subset T^3$ with respect to the surface framing induced by $T^2 = S_1^1 \times S_2^1$. Note $Y = \#^2(S^1 \times S^2)$. Let K be the core knot of the 0-surgery, which is another description of the Borromean knot according to [OS04, Section 9]. The knot K bounds a genus-one Seifert surface $S = S_2^1 \times S_3^1 \setminus N(S_1^1)$. Let $\mu \subset \partial(Y \setminus N(K))$ be the meridian and $\lambda = \partial S \subset \partial(Y \setminus N(K))$ be the longitude.

Lemma 5.1. *We have the following*

$$\underline{\text{KHI}}(Y, K, i) \cong \begin{cases} \mathbb{C} & |i| = 1 \\ \mathbb{C}^2 & i = 0 \\ 0 & \text{otherwise} \end{cases}$$

Proof. We first figure out $\underline{\text{KHI}}(Y, K) = \underline{\text{SHI}}(Y \setminus N(K), \Gamma_\mu)$. Using an annulus to form an auxiliary surface, we know from [KM10b, Lemma 5.2] that a closure of $(Y \setminus N(K), \Gamma_\mu)$ can be described as $S^1 \times \Sigma_2$ where Σ_2 is a closed surface of genus 2, obtained by gluing two once-punctured torus together. From the proof of [KM10b, Lemma 5.2], there are a pair of simple closed curve $\alpha, \beta \subset \Sigma_2$ so that $\alpha \cdot \beta = 1$, the torus $S^1 \times \alpha$ is the distinguishing surface of the closure, and β serves as the w_2 that specifies the bundle over $S^1 \times \Sigma_2$. By construction,

$$\underline{\text{SHI}}(Y \setminus N(K), \Gamma_\mu) \cong \text{Eig}(I^\beta(S^1 \times \Sigma_2), \mu(\text{pt}), 2),$$

where $\text{Eig}(I^\beta(S^1 \times \Sigma_2), \mu(\text{pt}), 2)$ means the generalized eigenspace of $\mu(\text{pt})$ on $I^\beta(S^1 \times \Sigma_2)$ with eigenvalue 2.

On the other hand, take $T^2 = \partial(Y \setminus N(K))$ and take the Seifert framing of K on T^2 . Let $M = [0, 1] \times T^2$ and let $\Gamma_{\mu, \mu}$ be the suture on ∂M which consists of two meridians on each boundary components of M . We can use an annulus to close up each boundary component of $(M, \Gamma_{\mu, \mu})$ separately. A construction similar to that of [KM10b, Lemma 5.2] implies that a closure of $(M, \Gamma_{\mu, \mu})$ can be described as $S^1 \times \Sigma_2$, and there are two pairs of curves $\alpha, \beta, \alpha', \beta'$ on Σ_2 so that $\alpha \cdot \beta = 1$, $\alpha' \cdot \beta' = 1$, the surface $S^1 \times (\alpha \cup \alpha')$ is the distinguishing surface of the closure, and $\beta \cup \beta'$ serves as the w_2 . Furthermore, the two pairs (α, β) and (α', β') come from closing up two boundary components of M , so they are disjoint from each other. We know the following

$$\underline{\text{SHI}}(M, \Gamma_{\mu, \mu}) \cong \text{Eig}(I^{\beta \cup \beta'}(S^1 \times \Sigma_2), \mu(\text{pt}), 2).$$

Since β and $\beta \cup \beta'$ both represent primitive homology classes on Σ_2 , there is an orientation preserving diffeomorphism $h : \Sigma_2 \rightarrow \Sigma_2$ so that $H([\beta]) = [\beta] + [\beta']$. As a result, the map h extends to a diffeomorphism between closures and we conclude

$$\underline{\text{SHI}}(Y \setminus N(K), \Gamma_\mu) \cong \underline{\text{SHI}}(M, \Gamma_{\mu, \mu}).$$

Observe that there is a sutured manifold decomposition

$$(M, \gamma) \overset{A}{\rightsquigarrow} (V, \gamma^6),$$

where $A = [0, 1] \times \mu \subset M$ is a product annulus and $V \cong S^1 \times D^2$ is a solid torus with γ^6 consists of six longitudes of V . From [Li19, Proposition 1.4] and [KM10b, Proposition 6.7] we know that

$$\underline{\text{SHI}}(Y \setminus N(K), \Gamma_\mu) \cong \underline{\text{SHI}}(M, \Gamma_{\mu, \mu}) \cong \mathbb{C}^4.$$

Now we compute the dimension of each graded part. Since $g(K) = 1$, we know $\underline{\text{KHI}}(Y, K, i) = 0$ for $|i| > 1$. For $|i| = 1$, since $K \subset Y$ is fibered (the complement is $S^1 \times (T^2 \setminus D^2)$), we have

$$\underline{\text{KHI}}(Y, K, 1) \cong \underline{\text{KHI}}(Y, K, -1) \cong \mathbb{C}.$$

As a result, we conclude that $\underline{\text{KHI}}(Y, K, 0) \cong \mathbb{C}^2$. \square

On connected sums of $S^1 \times S^2$, the circles $S^1 \times \{\text{pt}\}$ induces a nontrivial action on the framed instanton homology. In particular, we have the following lemma.

Lemma 5.2 ([Sca15, Section 7.8]). *Suppose \hat{Y} is the connected sum of copies of $S^1 \times S^2$. There is a canonical action of $\Lambda^* H_1(\hat{Y})$ on $I^\sharp(\hat{Y})$, making $I^\sharp(\hat{Y})$ a rank-one free module over $\Lambda^* H_1(\hat{Y})$.*

Since $Y = \#^2 S^1 \times S^2$, Lemma 5.2 implies

$$I^\sharp(Y) = \Lambda^* H_1(Y; \mathbb{C}) = \mathbb{C}[x_1, x_2] / (x_1 x_2 + x_2 x_1, x_1^2, x_2^2) = \mathbb{C}\langle 1, x_1, x_2, x_1 x_2 \rangle.$$

Note on Y we can pick two circles whose μ -actions correspond to the multiplication of x_1 and x_2 on $\mathbf{Y} = \Lambda^* H_1(-Y; \mathbb{C})$. We can pick these two circles away from the Borromean knot K . Since the μ -action of a circle commutes with all cobordism maps, all μ -actions of surfaces and points, we know that there is an action of $\Lambda^* H_1(-Y; \mathbb{C})$ on (Γ_*, i) for any $*$ $\in \mathbb{Q} \cup \{\mu\}$ and any grading i . This makes (Γ_*, i) a $\Lambda^* H_1(-Y; \mathbb{C})$ -module and all bypass maps and surgery maps are module morphisms. We have the following structure lemma.

Lemma 5.3. *Suppose $K \subset Y$ is the Borromean knot. Then for any integer $n \geq 2$, we have an identification*

$$\Gamma_n = \underline{\text{SHI}}(-Y \setminus N(K), -\Gamma_n, i) = \begin{cases} \mathbb{C}\langle x_1 x_2 \rangle & |i| = \frac{n+1}{2} \\ \mathbb{C}\langle x_1, x_2, x_1 x_2 \rangle & |i| = \frac{n-1}{2} \\ \Lambda^* H_1(Y; \mathbb{C}) & |i| < \frac{n-1}{2} \\ 0 & \text{otherwise} \end{cases}$$

Proof. The structure of Γ_n for large n is understood by Lemma 2.19 so it suffices to work out the structures of Γ_2 and Γ_3 . By Lemma 2.10 and Lemma 2.4, there are exact triangles

$$\begin{array}{ccc} \Gamma_2 & \xrightarrow{H_2} & \Gamma_3 \\ & \swarrow G_2 & \searrow F_3 \\ & \mathbf{Y} & \end{array} \qquad \begin{array}{ccc} \Gamma_2 & \xrightarrow{\psi_{\pm, 3}^2} & \Gamma_3 \\ & \swarrow \psi_{\pm, 2}^\mu & \searrow \psi_{\pm, \mu}^3 \\ & \Gamma_\mu & \end{array}$$

From Lemma 2.19 part (4), we know that F_3 is surjective so

$$\dim \Gamma_3 = \dim \Gamma_2 + \dim \mathbf{Y} = \dim \Gamma_2 + 4.$$

Since $\dim \Gamma_\mu = 4$, we know that the last two exact triangle split as well and in particular, the maps $\psi_{\pm,3}^2$ are both injective. From Lemma 2.19 part (4), we know that

$$(5.1) \quad (\Gamma_3, 0) \cong \mathbf{Y} = \Lambda^* H_1(-Y; \mathbb{C}).$$

Hence from Lemma 5.1, Lemma 2.19 part (2), and Lemma 2.4 we know that

$$\dim(\Gamma_3, \pm 1) = \dim(\Gamma_2, \pm \frac{1}{2}) = \dim(\Gamma_3, 0) - \dim(\Gamma_\mu, \mp 1) = 3.$$

Similarly,

$$\dim(\Gamma_3, \pm 2) = \dim(\Gamma_2, \pm \frac{3}{2}) = \dim(\Gamma_3, \pm 1) - \dim(\Gamma_\mu, 0) = 1.$$

Since the isomorphism in (5.1) is induced by a cobordism map, it is an isomorphism between modules. We have an injective module morphism

$$\psi_{+,3}^2(\Gamma_2, \frac{1}{2}) \rightarrow (\Gamma_3, 0).$$

We have the following claim.

Claim. There is a unique 3-dimensional submodule inside $\Lambda^* H_1(-Y; \mathbb{C})$.

Proof of Claim. Indeed, suppose $\mathcal{M} \subset \Lambda^* H_1(-Y; \mathbb{C})$ is a 3-dimensional submodule. Assume that $1 + a \in \mathcal{M}$, where a is spanned by x_1 , x_2 , and $x_1 x_2$. Then note $x_1 x_2 = x_1 x_2 (1 + a) \in \mathcal{M}$. Also $x_1(1 + a)$ is of the form $x_1 + c \cdot x_1 x_2$ for some $c \in \mathbb{C}$ so we know $x_1 \in \mathcal{M}$ and similarly $x_2 \in \mathcal{M}$. As a result $1 \in \mathcal{M}$ so \mathcal{M} must be all of $\Lambda^* H_1(-Y; \mathbb{C})$. Hence we conclude that \mathcal{M} does not have an element of the form $1 + a$ so the only possibility is that $\mathcal{M} = \mathbb{C}\langle x_1, x_2, x_1 x_2 \rangle$. \square

From the claim we know that

$$(\Gamma_3, 1) \cong (\Gamma_2, \frac{1}{2}) \cong \mathbb{C}\langle x_1, x_2, x_1 x_2 \rangle.$$

From the injectivity of the map $\psi_{+,3}^2 : (\Gamma_2, \frac{3}{2}) \rightarrow (\Gamma_3, 1)$ we can conclude similarly that

$$(\Gamma_3, 2) \cong (\Gamma_2, \frac{3}{2}) \cong \mathbb{C}\langle x_1 x_2 \rangle.$$

\square

Corollary 5.4. *Under the description of Lemma 5.3, the bypass maps between Γ_n and Γ_{n+1} for $n \geq 2$ are described as follows.*

- If $i \geq 0$, the map

$$\psi_{\pm, n+1}^n : (\Gamma_n, \pm i) \rightarrow (\Gamma_{n+1}, i \mp \frac{1}{2})$$

is the inclusion or the identity if the domain and range are the same.

- If $i \leq 0$, the map

$$\psi_{\pm, n+1}^n : (\Gamma_n, \pm i) \rightarrow (\Gamma_{n+1}, i \mp \frac{1}{2})$$

is the identity.

Moreover, the module structure on Γ_μ is trivial, i.e., the module multiplication of x_1 and x_2 are both zeros.

Proof. Note all the bypass maps are module morphisms. The description of the bypass maps is straightforward from the proof of Lemma 5.3. For the module structure of Γ_μ , we know that $(\Gamma_\mu, 1) \cong (\Gamma_\mu, -1) \cong \mathbb{C}$ so the structure must be zero. Also from Lemma 2.4 we know

$$(\Gamma_\mu, 0) \cong H\left(\text{Cone}(\mathbb{C}\langle x_1x_2 \rangle \hookrightarrow \mathbb{C}\langle x_1, x_2, x_1x_2 \rangle)\right)$$

so the module structure on $(\Gamma_\mu, 0)$ is also trivial. \square

Using the integral surgery formula Theorem 2.14 and the dual knot formula in [LY22b, Section 3.4], we can compute $I^\sharp(-Y_{-n}(K))$ and Γ_n for any $n \in \mathbb{Z}$ ($n \neq 0$ for I^\sharp). Since we will also deal with the connected sum of the Borromean knots, we omit the calculation here.

5.2. The connected sums. In this subsection, we compute the surgeries of g copies of connected sums of $K \subset Y$. According to [OS08, Section 5.2], these surgeries give rise to nontrivial circle bundles over Σ_g . Write

$$K^g = \#^g K \subset Y^g = \#^g Y = \#^{2g} S^1 \times S^2.$$

Note that the genus of K^g is exactly g . For the rest of this subsection, for $* \in \mathbb{Z} \cup \{\mu\}$, write Γ_* the suture on $Y^g \setminus N(K^g)$ and write Γ_* the corresponding sutured instanton homology. The connected sum formula (3.1) for instanton knot homology gives rise to the following.

Corollary 5.5. *We have the following*

$$\dim \underline{\text{KHI}}(Y^g, K^g, i) = \dim(\Gamma_\mu, i) = \binom{2g}{g+i}.$$

Moreover, the module structure of Γ_μ is trivial.

Note from Lemma 5.2 we know that

$$I^\sharp(-Y^g) = \Lambda^* H_1(-Y^g; \mathbb{C}) = \mathbb{C}\langle x_1, \dots, x_{2g} \rangle / (x_i x_j + x_j x_i).$$

For any $k \in [0, 2g] \cap \mathbb{Z}$ write

$$(5.2) \quad \mathcal{M}_{2g, k} = \text{Span}\{\Pi_{j=1}^l x_{i_j} \mid l \geq k, 1 \leq i_1 < \dots < i_l \leq 2g\}.$$

Note that

$$\mathcal{M}_{2g, 0} = \Lambda^* H_1(-Y^g; \mathbb{C}) \text{ and } \mathcal{M}_{2g, 2g} \cong \mathbb{C}.$$

It is straightforward to check that

$$\dim \mathcal{M}_{g, k} = \sum_{j=k}^{2g} \binom{2g}{k}.$$

Definition 5.6. Suppose \mathcal{M} is a module over $\Lambda^* H_1(-Y^g; \mathbb{C})$. We say \mathcal{M} is of **degree** $k > 0$ if any monomial of degree at least $k + 1$ annihilates \mathcal{M} and there exists a monomial of degree k acts nontrivially on \mathcal{M} . We say \mathcal{M} is of **degree** 0 if the module structure is trivial.

Lemma 5.7. *Suppose \mathcal{A} , \mathcal{B} , and \mathcal{C} are three modules over $\Lambda^* H_1(-Y^g; \mathbb{C})$ so that there is an exact triangle*

$$\begin{array}{ccc} \mathcal{A} & \xrightarrow{f} & \mathcal{B} \\ & \searrow h & \swarrow g \\ & & \mathcal{C} \end{array}$$

where the three maps f , g , and h are all module morphisms. Suppose further that \mathcal{A} is of degree k and \mathcal{C} is of degree 0, then the degree of \mathcal{B} is at most $k + 1$.

Proof. Suppose, on the contrary, that \mathcal{B} is of degree $k + 2$. Assume, without loss of generality, that there exists $b \in \mathcal{B}$ so that

$$\left(\prod_{j=1}^{k+2} x_j \right) \cdot b \neq 0.$$

Suppose that $g(x_{k+2} \cdot b) \neq 0$. Then $x_{k+2} \cdot g(b) = g(x_{k+2} \cdot b) \neq 0$ and this contradicts to the assumption that \mathcal{C} is of degree 0. As a result, there exists $a \in \mathcal{A}$ so that $f(a) = x_{k+2} \cdot b$. Then we have

$$f\left(\prod_{j=1}^{k+1} x_j \cdot a\right) = \left(\prod_{j=1}^{k+1} x_j\right) \cdot f(a) = \left(\prod_{j=1}^{k+2} x_j\right) \cdot b \neq 0.$$

As a result, we have

$$\left(\prod_{j=1}^{k+1} x_j \right) \cdot a \neq 0,$$

which contradicts the assumption that \mathcal{A} has degree at most k . \square

Lemma 5.8. *For any $g \geq 1$, and $n \geq 2g$, and any grading i , we have the following.*

$$(\mathbf{\Gamma}_n, i) \cong \begin{cases} \mathcal{M}_{2g, |i|+g-\frac{n-1}{2}} & |i| \geq \frac{n-1}{2} - g \\ \Lambda^* H_1(-Y^g; \mathbb{C}) & |i| \leq \frac{n-1}{2} - g \\ 0 & \text{otherwise} \end{cases}$$

Proof. Again we only deal with $\mathbf{\Gamma}_{2g}$ and $\mathbf{\Gamma}_{2g+1}$. We prove this lemma by three claims. Note from Lemma 2.19 part (4), we have

$$(\mathbf{\Gamma}_{2g+1}, 0) \cong I^\sharp(-Y^g) \cong \Lambda^* H_1(-Y^g; \mathbb{C}).$$

Also from Lemma 2.19 part (2) we know that $(\mathbf{\Gamma}_{2g}, i) \cong (\mathbf{\Gamma}_{2g+1}, i \pm \frac{1}{2})$ for $\pm i \geq 0$.

Claim 1. For $i > 0$, the degree of $(\mathbf{\Gamma}_{2g}, \pm i)$ is at most $\frac{4g-1}{2} - i$.

Proof of Claim 1. We only deal with $(\mathbf{\Gamma}_{2g}, i)$. The argument for $(\mathbf{\Gamma}_{2g}, -i)$ is similar. First from Lemma 2.19 part (2) we know that $(\mathbf{\Gamma}_{2g}, i) \cong (\mathbf{\Gamma}_{2g+1}, i \pm \frac{1}{2})$ then we know from Lemma 2.4 that there exists an exact triangle

$$\begin{array}{ccc} (\mathbf{\Gamma}_{2g}, i) & \xrightarrow{\quad\quad\quad} & (\mathbf{\Gamma}_{2g+1}, i - \frac{1}{2}) \cong (\mathbf{\Gamma}_{2g}, i - 1) \\ & \searrow & \swarrow \\ & & (\mathbf{\Gamma}_\mu, i - \frac{2g+1}{2}) \end{array}$$

Hence we can apply Lemma 5.7 to carry out an induction from the top grading of $\mathbf{\Gamma}_{2g}$ and the fact that $\mathbf{\Gamma}_\mu$ has degree 0. The starting point is the top grading $\frac{4g-1}{2}$ for which we have $(\mathbf{\Gamma}_{2g}, \frac{4g-1}{2}) \cong (\mathbf{\Gamma}_\mu, g) \cong \mathbb{C}$. So clearly it has degree 0. \square

Claim 2. For $i > 0$, we have the following.

$$\dim(\mathbf{\Gamma}_n, i) = \sum_{j=0}^{\frac{4g-1}{2}-i} \binom{2g}{j}.$$

Proof of Claim 2. From Lemma 2.19 part (4) we know that F_{2g+1} is surjective. As a result, we have

$$\dim \Gamma_{2g+1} - \dim \Gamma_{2g} = \dim \mathbf{Y}^g = 2^{2g} = \dim \Gamma_\mu.$$

Hence the exact triangles

$$\begin{array}{ccc} \Gamma_n & \xrightarrow{\psi_{\pm, 2g+1}^{2g}} & \Gamma_{n+1} \\ & \searrow & \swarrow \\ & \Gamma_\mu & \end{array}$$

both split, which means the map $\psi_{\pm, 2g+1}^{2g}$ is injective when restricting to the grading $\pm i$ for $i > 0$. As a result, we can obtain the claim by an induction and applying Corollary 5.5 and the fact

$$\dim(\Gamma_{2g}, \pm \frac{4g-1}{2}) = \dim(\Gamma_\mu, \pm g) = 1 = \binom{2g}{0}.$$

□

Claim 3. The module $\mathcal{M}_{2g,k}$ is the only submodule of $\Lambda^* H_1(-Y^g; \mathbb{C})$ that has degree at most $2g - k$ and has dimension

$$\sum_{j=k}^{2g} \binom{2g}{k}.$$

The proof of claim is straightforward. Note there is a sequence of injective maps

$$(\Gamma_{2g}, i) \hookrightarrow (\Gamma_{2g+1}, i - \frac{1}{2}) \cong (\Gamma_{2g}, i - 1) \cdots \hookrightarrow (\Gamma_{2g+1}, 0) \cong \Lambda^* H_1(-Y^g; \mathbb{C})$$

Hence the lemma follows from the above three claims. □

From the proof of the above lemma, we also know the following

Corollary 5.9. *For any $g \geq 1$, $n \geq 2g$, and grading i , we have the following.*

- If $i \geq 0$, the map

$$\psi_{\pm, n+1}^n : (\Gamma_n, \pm i) \rightarrow (\Gamma_{n+1}, i \mp \frac{1}{2})$$

is the inclusion or the identity if the domain and range are the same.

- If $i \leq 0$, the map

$$\psi_{\pm, n+1}^n : (\Gamma_n, \pm i) \rightarrow (\Gamma_{n+1}, i \mp \frac{1}{2})$$

is the identity.

Again, based on Lemma 5.8 and Corollary 5.9 and using the integral surgery formula and the dual knot formula in [LY22b, Section 3.4], we are able to compute Γ_n and $I^\sharp(-Y_{-n}(K))$ for any $n \in \mathbb{Z}$ ($n \neq 0$ for I^\sharp). Here we only present the computation for $I^\sharp(-Y_{-n}(K))$.

Proof of Theorem 1.1. The manifold Y_m^g is obtained from $Y^g = \#^{2g} S^1 \times S^2$ by m -surgery on the connected sum of the Borromean knot K^g . Note as the Borromean knot $K \subset \#^2 S^1 \times S^2$, we also know $Y_m^g(K^g)$ is diffeomorphic to $Y_{-m}^g(K^g)$. So it suffices to compute $Y_{-m}^g(K^g)$ for $m > 0$.

Since $\dim \Gamma_\mu = \dim \mathbf{Y}^g$, we know that all the differentials on the bent complexes are trivial. If $m \geq 2g - 1$, then the argument follows directly from the large surgery formula in Proposition 2.22.

For smaller m , we can also use the truncation of the integral surgery formula in Proposition 2.22 to make the computation easier. Suppose k is large enough. From Lemma 2.3, Lemma 2.8, and Lemma 5.8, we know that the following two exact triangles both split.

$$\begin{array}{ccc} \mathbf{\Gamma}_{m+k-1} & \xrightarrow{\quad\quad\quad} & \mathbf{\Gamma}_{\frac{2m+2k-1}{2}} \\ & \swarrow & \searrow \\ & \mathbf{\Gamma}_{m+k} & \end{array} \quad \begin{array}{c} \psi_{\pm, m+k}^{\frac{2m+2k-1}{2}} \end{array}$$

This implies that $\psi_{\pm, m+k}^{\frac{2m+2k-1}{2}}$ are both surjective. Since

$$\pi_{m,k}^{\pm} = \Psi_{\pm, m+2k-1}^{m+k} \circ \psi_{\mp, m+k}^{\frac{2m+2k-1}{2}},$$

we have

$$(5.3) \quad \text{Im } \pi_{m,k}^{\pm} = \text{Im } \Psi_{\pm, m+2k-1}^{m+k}.$$

Note when $|j| \leq m+g$ we know that

$$(\mathbf{\Gamma}_{\frac{2m+2k-1}{2}}, j) \cong \mathbb{C}^{2^{2g}} \cong (\mathbf{\Gamma}_{m+2k-1}, j).$$

The truncation of the integral surgery formula implies the following.

$$(5.4) \quad I^{\sharp}(-Y_{-m}(K)) \cong H\left(\text{Cone}(\pi_{m,k}^T : \sum_{j=1-g}^{g-1} (\mathbf{\Gamma}_{\frac{2m+2k-1}{2}}, j) \rightarrow \sum_{j=\frac{m}{2}+1-g}^{g-1-\frac{m}{2}} (\mathbf{\Gamma}_{m+2k-1}, j))\right)$$

where the map

$$\pi_{m,k}^T = \sum_{i=1-g}^{g-1-m} \pi_{m,k}^{+,i} + \sum_{i=1-g+m}^{g-1} \pi_{m,k}^{-,i}.$$

Now we compute the image of the map $\pi_{m,k}^T$. We discuss in two different cases.

Claim 1. If $m = 2l - 1$ where $1 \leq l \leq g - 1$, we have

$$\text{Im } \pi_{m,k}^T = \bigoplus_{j=1}^{g-l} (\mathcal{M}_{2g,j}^+ \oplus \mathcal{M}_{2g,j}^-),$$

where $\mathcal{M}_{2g,j}^{\pm} \cong \mathcal{M}_{2g,j}$ as defined in (5.2) and

$$\mathcal{M}_{2g,j}^{\pm} \subset (\mathbf{\Gamma}_{m+2k-1}, \pm(g-l + \frac{1}{2} - j)).$$

Proof of Claim 1. For any $\frac{m}{2} + 1 - g \leq j \leq g - 1 - \frac{m}{2}$, we have

$$\text{Im } \pi_{m,k}^T \cap (\mathbf{\Gamma}_{m+2k-1}, j) = \text{Im } \pi_{m,k}^{+,j-\frac{m}{2}} \cup \text{Im } \pi_{m,k}^{-,j+\frac{m}{2}}.$$

When $\pm j \leq 0$, we have

$$\begin{aligned} \text{Im } \pi_{m,k}^{\mp, j+\frac{m}{2}} &\subset \text{Im } \pi_{m,k}^{\pm, j-\frac{m}{2}} \\ (5.3) &= \Psi_{\pm, m+2k-1}^{n+k} \left((\mathbf{\Gamma}_{n+k}, j \pm \frac{k-1}{2}) \right) \\ &= \mathcal{M}_{-|j|+g-\frac{m}{2}}. \end{aligned}$$

As a result, we conclude that

$$\mathrm{Im} \pi_{m,k}^T \subset \bigoplus_{j=1}^{g-l} (\mathcal{M}_{2g,j}^+ \oplus \mathcal{M}_{2g,j}^-),$$

To show that this inclusion is the equality, assume that

$$b \in \bigoplus_{j=1}^{g-l} (\mathcal{M}_{2g,j}^+ \oplus \mathcal{M}_{2g,j}^-).$$

Without loss of generality, we can assume that $b \in \mathcal{M}_{g+\frac{m}{2}-j}^+ \subset (\mathbf{\Gamma}_{m+2k-1}, j)$ for some $j \geq 0$. We will prove that $b \in \mathrm{Im} \pi_{m,k}^T$. By the argument above, there exists

$$a_{j+\frac{m}{2}} \in (\mathbf{\Gamma}_{\frac{2m+2k-1}{2}}, j + \frac{m}{2})$$

so that

$$\pi_{m,k}^{-,j+\frac{m}{2}}(a_{j+\frac{m}{2}}) = b.$$

Note

$$\mathrm{Im} \pi_{m,k}^{+,j+\frac{m}{2}} \subset \mathrm{Im} \pi_{m,k}^{-,j+\frac{3m}{2}},$$

so we can pick

$$a_{j+\frac{3m}{2}} \in (\mathbf{\Gamma}_{\frac{2m+2k-1}{2}}, j + \frac{3m}{2})$$

so that

$$\pi_{m,k}^{-,j+\frac{3m}{2}}(a_{j+\frac{3m}{2}}) = -\pi_{m,k}^{+,j+\frac{m}{2}}(a_{j+\frac{m}{2}}).$$

We can repeat this argument inductively to obtain an element

$$a = a_{j+\frac{m}{2}} + a_{j+\frac{3m}{2}} + a_{j+\frac{5m}{2}} + \dots$$

so that

$$\pi_{m,k}^T(a) = b.$$

□

From Claim 1 and (5.4), we can compute the dimension of $I^\sharp(-Y_{-m}(K))$ as:

$$\begin{aligned} \dim I^\sharp(-Y_{-m}(K)) &= \sum_{j=1-g}^{g-1} \dim(\mathbf{\Gamma}_{\frac{2m+2k-1}{2}}, j) + \sum_{j=\frac{m}{2}+1-g}^{g-1-\frac{m}{2}} \dim(\mathbf{\Gamma}_{m+2k-1}, j) \\ &\quad - 2 \cdot \dim \mathrm{Im} \pi_{m,k}^T \\ &= 2^{2g} \cdot m + 4 \cdot \sum_{j=1}^{g-l} \sum_{i=0}^{j-1} \binom{2g}{i}. \end{aligned}$$

Claim 2. When $m = 2l$ for $1 \leq l \leq g-1$, we have

$$\mathrm{Im} \pi_{m,k}^T = \mathcal{M}_{2g,g-l} \oplus \bigoplus_{j=1}^{g-l-1} (\mathcal{M}_{2g,j}^+ \oplus \mathcal{M}_{2g,j}^-),$$

where $\mathcal{M}_{2g,j}^\pm \cong \mathcal{M}_{2g,j}$ as defined in (5.2),

$$\mathcal{M}_{2g,j}^\pm \subset (\mathbf{\Gamma}_{m+2k-1}, \pm(g-l + \frac{1}{2} - j)), \text{ and } \mathcal{M}_{2g,g-l} \subset (\mathbf{\Gamma}_{m+2k-1}, 0).$$

The proof of Claim 2 is similar to that of Claim 1. As a result we can compute

$$\dim I^\sharp(-Y_{-m}(K)) = 2^{2g} \cdot m + 4 \cdot \sum_{j=1}^{g-1} \sum_{i=0}^{j-1} \binom{2g}{i} + 2 \cdot \sum_{i=0}^{g-1} \binom{2g}{i}.$$

□

5.3. Seifert fibered manifolds. In this subsection, we use the generalized rational surgery in [OS11, Section 10.2] to obtain the Seifert fibered manifolds by surgeries and then compute the framed instanton homology.

Following the notations in Section 3 and Section 5.2, we denote the connected sum of g copies of the Boromean knot by $K^g \subset Y^g = \#^{2g} S^1 \times S_2$ and denote the core knot in $L(v, -r)$ by $O_{v/r}$. Let $K_\# \subset Y_\#$ be the connected sum of $K_0 := K^g$ and $K_1 := O_{v_1/r_1}, \dots, K_n := O_{v_n/r_n}$. Then from [OS11, Section 10.2], the m -surgery on $K_\#$ gives the Seifert fibered space over a genus g base orbifold with Seifert invariants $(m, r_1/v_1, \dots, r_n/v_n)$.

Similar to the calculation in Lemma 3.6, we have

$$H_1(Y_\# \setminus N(K_\#)) \cong \left(H_1(Y^g) \oplus \langle g_0, g_1, \dots, g_n \rangle \right) / (g_0 = v_i \cdot g_i \text{ for } i = 1, \dots, n)$$

where g_0 is the meridian of K^g , g_i is the generator of

$$H_1(L(v_i, -r_i) \setminus N(O_{v_i/r_i})) \cong \mathbb{Z},$$

and the meridian of O_{v_i/r_i} is $v_i \cdot g_i$. Suppose

$$(5.5) \quad \gcd(v_i, v_j) = 1 \text{ for } i \neq j \in \{1, \dots, n\}.$$

Let

$$v = \prod_{i=1}^n v_i \text{ and } v'_j = \frac{v}{v_j} = \prod_{i \neq j} v_i.$$

Suppose $g_i = v'_i \cdot g'_i$ for $i = 1, \dots, n$ and $g_0 = v \cdot g'_0$. Then we have

$$(5.6) \quad \begin{aligned} H_1(Y' \setminus N(K')) &\cong \left(H_1(Y^g) \oplus \mathbb{Z} \langle g'_0, g'_1, \dots, g'_n \rangle \right) / (g'_0 = g'_i \text{ for } i = 1, \dots, n) \\ &\cong H_1(Y^g) \oplus \mathbb{Z} \langle g'_0 \rangle. \end{aligned}$$

For $\bullet \in \{0, \dots, n, \#\}$, let $\Gamma_\mu^\bullet, \Gamma_n^\bullet, \psi_{\pm, n+1}^{n, \bullet}, \psi_{\pm, \mu}^{n, \bullet}, \psi_{\pm, n}^{\mu, \bullet}$, and F_n^\bullet denote the sutured instanton homologies, the bypass maps, the cobordism maps in Lemma 2.10 for K_\bullet . Similar to Proposition 3.8, we have the following identifications of bent complexes.

Proposition 5.10. *Suppose (5.5). For any grading s , there is an identification*

$$A(K_\#, s) = A(K_0, s_0) \text{ and } B^\pm(K_\#, s) = B^\pm(K_0, s_0),$$

where s_0 is the unique grading satisfying

$$(5.7) \quad s = s_0 v + \sum_{i=1}^n s_i v'_i \text{ and } |s_i| \leq \frac{v_i - 1}{2} \text{ for } i = 1, \dots, n.$$

Moreover, we have the following commutative diagrams

$$\begin{array}{ccc} A(K_{\#}, s) & \xrightarrow{\pi^{\pm}(K_{\#}, s)} & B^{\pm}(K_{\#}, s) \\ \downarrow = & & \downarrow = \\ A(K_0, s_0) & \xrightarrow{\pi^{\pm}(K_0, s_0)} & B^{\pm}(K_0, s_0) \end{array}$$

Proof. From Lemma 3.2, since K_i for $i = 1, \dots, n$ are core knots in lens spaces, we know (Γ_{μ}^i, s_i) is nontrivial only for $|s_i| \leq \frac{v_i-1}{2}$, for which the grading summand is 1-dimensional. We can apply the graded version of (3.1) in [LY21c, Proposition 5.15] to show that

$$(5.8) \quad (\Gamma_{\mu}^{\#}, s) \cong \bigoplus_{s_0 v + \sum_{i=1}^n s_i v'_i = s} \bigotimes_{i=0}^n (\Gamma_{\mu}^i, s_i),$$

where the direct sum is again from the homology calculation in (5.6).

For any fixed s , if there are integers (s_0, \dots, s_n) and (s'_0, \dots, s'_n) satisfying

$$s = s_0 v + \sum_{i=1}^n s_i v'_i = s'_0 v + \sum_{i=1}^n s'_i v'_i.$$

Then we have

$$(s_0 - s'_0)v + \sum_{i=1}^n (s_i - s'_i)v'_i = 0.$$

For any $j \in \{1, \dots, n\}$, we have v and v'_i are divisible by v_j for $i \neq j$ and v_j is not divisible by v_j . Hence we must have $s_j - s'_j$ is divisible by v_j . If

$$|s_j|, |s'_j| \leq \frac{v_i - 1}{2},$$

then we must have $s_j = s'_j$. As a conclusion, for fixed s , there is a unique s_0 satisfying (5.7). From (5.8), we have

$$(\Gamma_{\mu}^{\#}, s) \cong (\Gamma_{\mu}^0, s_0).$$

The remain of the proof is similar to that of Proposition 3.8. Indeed, there are no differentials for $K_{\#}$ and K_0 , so we do not need to identify differentials in bent complexes. \square

Even though we obtain the identification of the bent complexes as in Proposition 5.10, we still need to use the $\Lambda^* H_1(-Y^g; \mathbb{C})$ -action studied in previous two subsections to identify $B^{\pm}(K_{\#})$. Iterating the construction of $C_{\pm, n+k}^{n, k}$ in the proof of Lemma 3.5, we can construct maps

$$(5.9) \quad C_{\pm, k_0+k_1+\dots+k_n}^{k_0, k_1, \dots, k_n} : \Gamma_{k_0}^0 \otimes \Gamma_{k_1}^1 \otimes \dots \otimes \Gamma_{k_n}^n \rightarrow \Gamma_{k_0+k_1+\dots+k_n}^{\#}.$$

Moreover, we have the commutative diagram

(5.10)

$$\begin{array}{ccccc}
\Gamma_{k_0}^0 \otimes \Gamma_{k_1}^1 \otimes \cdots \otimes \Gamma_{k_n}^n & \xrightarrow{\psi_{\pm, k_0+1}^{k_0, 0} \otimes \text{Id}} & \Gamma_{k_0+1}^0 \otimes \Gamma_{k_1}^1 \otimes \cdots \otimes \Gamma_{k_n}^n & \xrightarrow{F_{k_0+1}^0 \otimes \cdots \otimes F_{k_n}^n} & \bigotimes_{i=0}^n I^\#(-Y_i) \\
\downarrow C_{\pm, k_0+k_1+\cdots+k_n}^{k_0, k_1, \dots, k_n} & & \downarrow C_{\pm, k_0+k_1+\cdots+k_n}^{k_0+1, k_1, \dots, k_n} & & \downarrow = \\
\Gamma_{k_0+k_1+\cdots+k_n}^\# & \xrightarrow{\psi_{\pm, k_0+1+k_1+\cdots+k_n}^{k_0+k_1+\cdots+k_n, \#}} & \Gamma_{k_0+1+k_1+\cdots+k_n}^\# & \xrightarrow{F_{k_0+1+k_1+\cdots+k_n}^\#} & I^\#(-Y_\#)
\end{array}$$

Since the construction of the map in (5.9) only involves the neighborhoods of the knots, the map commutes with the $\Lambda^* H_1(-Y^g; \mathbb{C})$ -action and we regard it as a map between the $\Lambda^* H_1(-Y^g; \mathbb{C})$ modules.

Similar to the computation in Corollary 3.7 (*c.f.* (5.8)), we have

$$\begin{aligned}
(5.11) \quad & C_{\pm, k_0+k_1+\cdots+k_n}^{k_0, k_1, \dots, k_n} \left((\Gamma_{k_0}^0, s_0 \pm \frac{k_0-1}{2}) \otimes \bigotimes_{i=1}^n (\Gamma_{k_i}^i, s_i \pm \frac{(k_i-1)v_i + r_i}{2}) \right) \\
& \subset (\Gamma_{k_0+k_1+\cdots+k_n}^\#, s_0 v + \sum_{i=1}^n s_i v'_i \pm \frac{(\sum_{i=0}^n k_i - 1)v + \sum_{i=1}^n v'_i r_i}{2}).
\end{aligned}$$

Note that the last sum $\sum_{i=1}^n v'_i r_i$ comes from the fact that the homology class of the longitude of $K_\#$ is the sum of the homology classes $r_i \cdot g_i$ of the longitudes of K_i for $i = 1, \dots, n$ under the isomorphism (5.6).

Proposition 5.11. *Suppose (5.5). For any large enough integer l and any grading i , the summand $(\Gamma_k^\#, i)$ is a module $\mathcal{M}_{g,l}$ over $\Lambda^* H_1(-Y^g; \mathbb{C})$ for some l , as constructed in (5.2). Moreover, the bypass maps*

$$\psi_{\pm, k+1}^{k, \#} : (\Gamma_k^\#, i) \rightarrow (\Gamma_{k+1}^\#, i \mp \frac{v}{2})$$

is either an inclusion of module or the identity.

Proof. From [LY22b, Proposition 3.15], if $s > g + \frac{p-1}{2} - kp$, then we have an isomorphism

$$H(B^+(\geq s)) \cong (\Gamma_k, s + \frac{(k-1)p - q}{2})$$

and if $s > -(g + \frac{p-1}{2} - kp)$, then we have an isomorphism

$$H(B^-(\leq s)) \cong (\Gamma_k, s - \frac{(k-1)p - q}{2}),$$

where $g = g(K_\#) = g(K_0)$, (p, q) are defined in Subsection 2.2, and $B^+(\geq s), B^-(\leq s)$ are subcomplexes of $B^\pm(s)$. Hence for k large enough, we can compute $(\Gamma_k^\#, i)$ by $B^\pm(K_\#)$ and Lemma 2.19. Note that $(p, q) = (v, -\sum_{i=1}^n v'_i r_i)$ for $K_\#$ and $(p, q) = (1, 0)$ for K_0 . We only show the computation for the large grading i and the positive bypass map as follows.

From the identification of B^\pm in Proposition 5.10, we know

$$(\Gamma_k^\#, s + \frac{(k-1)v + \sum_{i=1}^n v'_i r_i}{2}) \cong H(B^+(K_\#, \geq s)) \cong H(B^+(K_0, \geq s_0)) \cong (\Gamma_{k_0}^0, s_0 + \frac{k_0-1}{2}),$$

where $s = s_0 v + \sum_{i=1}^n s_i v'_i$ with $|s_i| \leq \frac{v_i - 1}{2}$ and s, s_0 satisfy the inequality $s, s_0 > g + \frac{p-1}{2} - kp$ for their corresponding (p, q) . Let $k = \sum_{i=0}^n k_i$. From Lemma 3.2, we know

$$(\mathbf{\Gamma}_{k_i}^i, s_i + \frac{(k_i - 1)v_i + r_i}{2}) \cong \mathbb{C}.$$

From (5.11), the map $C_{+, k_0+k_1+\dots+k_n}^{k_0, k_1, \dots, k_n}$ induces a map from $(\mathbf{\Gamma}_{k_0}^0, s_0 + \frac{k_0-1}{2})$ to $(\mathbf{\Gamma}_k^\#, s + \frac{(k-1)v + \sum_{i=1}^n v'_i r_i}{2})$. Since there are no differentials for K_0 and $K_\#$, the triangles involving $\psi_{+, k_0+1}^{k_0, 0}$ and $\psi_{+, k_0+1+k_1+\dots+k_n, \#}^{k_0+k_1+\dots+k_n, \#}$ split and these two maps are injective. From Lemma 2.19, after applying the bypass maps for sufficiently many times k' , the restrictions of maps $F_{k_0+k'}^0$ and $F_{k_0+k'+k_1+\dots+k_n}^\#$ are isomorphisms. Then the commutativity in (5.10) implies that

$$C_{+, k_0+k_1+\dots+k_n}^{k_0, k_1, \dots, k_n} : (\mathbf{\Gamma}_{k_0}^0, s_0 + \frac{k_0-1}{2}) \rightarrow (\mathbf{\Gamma}_k^\#, s + \frac{(k-1)v + \sum_{i=1}^n v'_i r_i}{2})$$

is an isomorphism. Thus, the proposition follows from the computation in Lemma 5.8, Corollary 5.9, and the commutativity in (5.10). \square

Proof of Theorem 1.3. Similar to the proof of Theorem 1.1 in the last subsection, we apply the integral surgery formula Theorem 2.14 and its truncation Proposition 2.22 to the connected sum $K_\#$ of Boromean knots and core knots in lens spaces. Since there are no differentials for $K_\#$, again $\psi_{\pm, m+k}^{\frac{2m+2k+1}{2}}$ are surjective and

$$\text{Im } \pi_{m,k}^\pm = \text{Im } \Psi_{\pm, m+2k-1}^{m+k}.$$

as in (5.3). Then the dimension of $\text{Im } \pi_{m,k}^T$ in the truncation can be computed from Proposition 5.11 and the two claims in the proof of Theorem 1.1.

In Heegaard Floer theory, we apply Ozsváth-Szabó's integral surgery formula for \widehat{HF} . There is an explicit identification between Heegaard Floer version of $B^\pm(K_0)$ in [OS11, Lemma 10.4] (the lemma is for the plus version, but setting $U = 0$ gives the identification for the hat version), which coincides the identification from the $\Lambda^* H_1(-Y_g; \mathbb{C})$ -module structure.

Since the integral surgery formulae in instanton and Heegaard Floer theories have the similar form and we already show that the complexes and the maps in the formulae coincide, the dimensions of $I^\#$ and \widehat{HF} for the surgery manifold are the same. Note that we have to use the dimension over \mathbb{F}_2 for \widehat{HF} since [OS11, Lemma 10.4] works over \mathbb{F}_2 . The computations by two claims in the proof of Theorem 1.1 are independent of the underlying field. \square

6. SURGERIES ON SOME ALTERNATING KNOTS

In this section, we use oriented skein relation and an inductive argument to study differentials for a special family of alternating knots in S^3 .

6.1. Knots with torsion order one. In this subsection, we introduce a condition on the differentials that is closely related to the thin complex in [Pet13, Definition 6]. Inspired by the U map in Definition 2.25, we have the following definition.

Definition 6.1. Suppose $K \subset Y$ is a rationally null-homologous knot of order p . For a large enough integer n , and a grading i , we define the map

$$(6.1) \quad U = (\psi_{-, n+1}^n)^{-1} \circ \psi_{+, n+1}^n : (\mathbf{\Gamma}_n, i) \rightarrow (\mathbf{\Gamma}_n, i - p).$$

Lemma 6.2. *The follow are some basic properties of the map U .*

- (1) The map U is well-defined for any $i \geq g - \frac{(n-1)p-q-1}{2}$.
(2) For any i so that U is defined, there exists an exact triangle

$$\begin{array}{ccc} (\mathbf{\Gamma}_n, i) & \xrightarrow{U} & (\mathbf{\Gamma}_n, i-p) \\ & \swarrow \psi_{+,n}^\mu & \searrow \psi_{+,\mu}^n \\ & (\mathbf{\Gamma}_\mu, i - \frac{(n-1)p-q}{2}) & \end{array}$$

- (3) We have $F_n \circ U = F_n$.

Proof. Part (1) follows from Lemma 2.19 part (2). Part (2) follows from Lemma 2.4 and Lemma 2.7. Part (3) follows from Lemma 2.11 and Lemma 2.12 Part (1). \square

From Lemma 6.2 part (1), the map U is well-defined on most of the gradings of $\mathbf{\Gamma}_n$. Since n is large, it is enough to focus on $i > 0$.

From diagram (2.1), the differentials d_\pm induce

$$(6.2) \quad d_{1,\pm} := \psi_{\pm,\mu}^n \circ \psi_{\pm,n}^\mu$$

on the first pages of spectral sequences. The definition is independent of the choice of n due to Lemma 2.7.

Lemma 6.3. *Suppose $K \subset Y$ is a rationally null-homologous knot. The following are equivalent.*

- (i) $\dim H(\mathbf{\Gamma}_\mu, d_{1,+}) = \dim I^\sharp(-Y)$.
- (ii) $\dim H(\mathbf{\Gamma}_\mu, d_{1,-}) = \dim I^\sharp(-Y)$.
- (iii) For large enough n and any element $x \in (\mathbf{\Gamma}_n, i)$ with $i > 0$, if there exists $k \in \mathbb{N}_+$ so that $U^k(x) = 0$, then $U(x) = 0$.
- (iv) For large enough n any grading $i > 0$, we have

$$U\left((\mathbf{\Gamma}_n, i) \cap \ker F_n\right) = 0.$$

Proof. If we reverse the orientation of the knot, then positive and negative bypasses in defining the differentials $d_{1,\pm}$ in Equation (6.2) exchange with each other. As a result, the two differentials $d_{1,+}$ and $d_{1,-}$ also switch with each other. Hence we conclude that (i) and (ii) are equivalent. The equivalence between (iii) and (iv) follows easily from Lemma 6.2 Part (3). To show that (i) and (iii) are equivalent, recall that in [LY21c] the construction of the differentials d_+ goes with a series of differentials $d_{k,+}$ defined as

$$d_{k,+} = \psi_{+,\mu}^n \circ (\Psi_{+,n+k}^n)^{-1} \circ \psi_{+,n}^\mu.$$

In [LY21c], we proved that $d_{k,+}$ is well-defined on $\ker d_{k-1,+} / \text{Im } d_{k-1,+}$ and

$$\ker d_{k,+} / \text{Im } d_{k,+} \cong I^\sharp(-Y)$$

for any large enough k . For simplicity, we suppose n is large enough. Since $\text{Im } \psi_{+,n}^\mu$ lies in the top few gradings of $\mathbf{\Gamma}_n$, by Definition 6.1 the map U is well-defined on related gradings. Also from Lemma 2.19 we know that $\psi_{-,n+1}^n$ is an isomorphism on such gradings, so we can rewrite $d_{k,+}$ as

$$d_{k,+} = \psi_{+,\mu}^n \circ U^{-k} \circ \psi_{+,n}^\mu.$$

Now statement (i) is equivalent to the fact that $d_{k,+} = 0$ for all $k \geq 2$ and it remains to show that this is equivalent to (iii).

If there exists $u \in \Gamma_\mu$ and $k \geq 2$ so that $d_{i,+}(u) = 0$ for all $i < k$ and $d_{k,+}(u) \neq 0$. Then by definition there exists $y \in \Gamma_n$ so that $\psi_{+,\mu}^n(y) \neq 0$ and $U^{k-1}(y) = \psi_{+,\mu}^\mu(x) \neq 0$. Since by Lemma 6.2

$$U^k(y) = U \circ \psi_{+,\mu}^\mu(x) = 0$$

we know that (iii) does not hold. Conversely, if there exists $x \in \Gamma_n$ so that $x \notin \text{Im } U$, $U^k(x) \neq 0$ and $U^{k+1}(x) = 0$ for some $k \geq 1$. We know that there exists $u \in \Gamma_\mu$ so that $\psi_{+,\mu}^\mu(u) = U^k(x)$ and hence

$$d_{k+1,+}(u) = \psi_{+,\mu}^n(x) \neq 0.$$

Hence we conclude that (i) and (iii) are equivalent. \square

Definition 6.4. A knot $K \subset Y$ has **torsion order one** if it satisfies any equivalent statement in Lemma 6.3.

6.2. Commutativity of the first differentials. In this subsection, we prove the commutativity of two first differentials, which will provide a strong restriction for knots with torsion order one.

Theorem 6.5. *For any rationally null-homologous $K \subset Y$, we have*

$$d_{1,-} \circ d_{1,+} \doteq d_{1,+} \circ d_{1,-},$$

where \doteq means the equation holds up to a scalar.

From [Li18b], there is a gluing map

$$G : \Gamma_\mu \otimes \underline{\text{SHI}}(-[0, 1] \times T^2, -\Gamma_\mu \cup -\Gamma_\mu) \rightarrow \Gamma_\mu.$$

Here we can identify $\{0\} \times T^2$ with $\partial(S^3 \setminus N(K))$ and then use the Seifert framing on $\partial(S^3 \setminus N(K))$ to be the framing on T^2 as well. Let ξ_{st} be the product contact structure on $[0, 1] \times T^2$, and

$$\theta(\xi_{st}) \in \underline{\text{SHI}}(-[0, 1] \times T^2, -\Gamma_\mu \cup -\Gamma_\mu)$$

be its contact element [BS16b]. Then we know from [Li18b, Theorem 1.1] that

$$(6.3) \quad G(- \otimes \theta(\xi_{st})) \doteq \text{Id} : \Gamma_\mu \rightarrow \Gamma_\mu.$$

We write $Y_{T^2} = [0, 1] \times T^2$ and take $n = 0$ in the definition of $d_{1,\pm}$ in (6.2) for simplicity. We can view the bypasses attached originally to $(S^3 \setminus N(K), \Gamma_\mu)$ to be attached to $(Y_{T^2}, \Gamma_\mu \cup \Gamma_\mu)$ on the $\{1\} \times T^2$ side instead, and they lead to new exact triangles

$$(6.4) \quad \begin{array}{ccc} \underline{\text{SHI}}(-Y_{T^2}, -\Gamma_\mu \cup -\Gamma_0) & \xrightarrow{\hat{\psi}_{\pm,1}^0} & \underline{\text{SHI}}(-Y_{T^2}, -\Gamma_\mu \cup -\Gamma_1) \\ & \swarrow \hat{\psi}_{\pm,0}^\mu & \nwarrow \hat{\psi}_{\pm,\mu}^1 \\ & \underline{\text{SHI}}(-Y_{T^2}, -\Gamma_\mu \cup -\Gamma_\mu) & \end{array}$$

Using these bypasses maps, we could construct the map $\hat{d}_\pm = \hat{\psi}_{\pm,\mu}^0 \circ \hat{\psi}_{\pm,0}^\mu$ just as the construction of the maps $d_{1,\pm}$. We have the following key proposition:

Proposition 6.6. *We have*

$$\hat{d}_+ \circ \hat{d}_-(\theta(\xi_{st})) \doteq \hat{d}_- \circ \hat{d}_+(\theta(\xi_{st})) \neq 0 \in \underline{\text{SHI}}(-[0, 1] \times T^2, -\Gamma_\mu \cup -\Gamma_\mu)$$

Proof of Theorem 6.5 using Proposition 6.6. From the functoriality of gluing maps in [Li18b, Theorem 1.1], we have two commutative diagrams

$$\begin{array}{ccc} \mathbf{\Gamma}_\mu \otimes \underline{\text{SHI}}(-Y_{T^2}, -\Gamma_\mu \cup -\Gamma_\mu) & \xrightarrow{\text{Id} \otimes (\hat{d}_+ \circ \hat{d}_-)} & \mathbf{\Gamma}_\mu \otimes \underline{\text{SHI}}(-Y_{T^2}, -\Gamma_\mu \cup -\Gamma_\mu) \\ \downarrow G & & \downarrow G \\ \mathbf{\Gamma}_\mu & \xrightarrow{d_{1,+} \circ d_{1,-}} & \mathbf{\Gamma}_\mu \end{array}$$

and

$$\begin{array}{ccc} \mathbf{\Gamma}_\mu \otimes \underline{\text{SHI}}(-Y_{T^2}, -\Gamma_\mu \cup -\Gamma_\mu) & \xrightarrow{\text{Id} \otimes (\hat{d}_- \circ \hat{d}_+)} & \mathbf{\Gamma}_\mu \otimes \underline{\text{SHI}}(-Y_{T^2}, -\Gamma_\mu \cup -\Gamma_\mu) \\ \downarrow G & & \downarrow G \\ \mathbf{\Gamma}_\mu & \xrightarrow{d_{1,-} \circ d_{1,+}} & \mathbf{\Gamma}_\mu \end{array}$$

From (6.3), we have $G(x \otimes \theta(\xi_{st})) \doteq x$. Hence, from the commutative diagrams and Proposition 6.6, we have

$$(6.5) \quad d_{1,+} \circ d_{1,-}(x) \doteq G(x \otimes \hat{d}_+ \circ \hat{d}_-(\theta(\xi_{st}))) \doteq G(x \otimes \hat{d}_- \circ \hat{d}_+(\theta(\xi_{st}))) = d_{1,-} \circ d_{1,+}(x). \quad \square$$

Then we prove Proposition 6.6. First note that \hat{d}_+ and \hat{d}_- are both constructed via bypasses, and contact elements are preserved by the gluing maps as in [Li18b, Theorem 1.1]. As a result, there are two contact structures ξ_{+-} and ξ_{-+} on $(Y_{T^2}, \Gamma_\mu \cup \Gamma_\mu)$, which are both obtained from ξ_{st} by attaching four bypasses according to $d_{1,+} \circ d_{1,-}$ and $d_{1,-} \circ d_{1,+}$, respectively, so that

$$\theta(\xi_{+-}) \doteq \hat{d}_+ \circ \hat{d}_-(\theta(\xi_{st})) \text{ and } \theta(\xi_{-+}) \doteq \hat{d}_- \circ \hat{d}_+(\theta(\xi_{st})).$$

Lemma 6.7. *The contact elements $\theta(\xi_{+-})$ and $\theta(\xi_{-+})$ are both nonzero.*

Proof. From (6.5) we know that for any knot $K \subset S^3$, we have

$$d_{1,+} \circ d_{1,-} \doteq G(- \otimes \theta(\xi_{+-})) \text{ and } d_{1,-} \circ d_{1,+} \doteq G(- \otimes \theta(\xi_{-+})).$$

We computed the differentials for the figure-eight knot in [LY21c, Section 6], for which we have $d_{1,+} \circ d_{1,-} \neq 0$ and $d_{1,-} \circ d_{1,+} \neq 0$. Thus the lemma follows. \square

Next, to better study the two contact elements, we construct a \mathbb{Z}^2 -grading on $\underline{\text{SHI}}(-Y_{T^2}, -\Gamma_\mu \cup -\Gamma_\mu)$ as follows. View $T^2 = S^1 \times S^1$. We call curves that isotopic to $S^1 \times \{\text{pt}\}$ and $\{\text{pt}\} \times S^1$ longitudes and meridians, respectively. Take a meridian m on T^2 , then we have an annulus $A_m = [0, 1] \times m \subset Y_{T^2}$. We can arrange A_m as a product annulus inside $(Y_{T^2}, \Gamma_\mu \cup \Gamma_\mu)$. The decomposition along A_m yields a solid torus with suture being six copies of the longitude. According to [GL19, Lemma 2.29], we have

$$\underline{\text{SHI}}(-Y_{T^2}, -\Gamma_\mu \cup -\Gamma_\mu) \cong \mathbb{C}^4.$$

As in [GL19, Theorem 2.28], the surface A_m induces a \mathbb{Z} -grading on $\underline{\text{SHI}}(-Y_{T^2}, -\Gamma_\mu \cup -\Gamma_\mu)$ so that all six dimensions are all supported at grading 0.

For a second surface, we pick a longitude l of T^2 and obtain a second annulus $A_l = [0, 1] \times l$. Note each component of ∂A_l intersects the suture Γ_μ twice, so as in [GL19, Theorem 2.28], A_l induces a \mathbb{Z} -grading on $\underline{\text{SHI}}(-Y_{T^2}, -\Gamma_\mu \cup -\Gamma_\mu)$ which is supported at three gradings $-1, 0, 1$. The

decomposition along A_l and $-A_l$ both yield a solid torus with sutures being two copies of the longitude. According to [GL19, Lemma 2.29], we have

$$\underline{\text{SHI}}(-Y_{T^2}, -\Gamma_\mu \cup -\Gamma_\mu, A_l, 1) \cong \underline{\text{SHI}}(-Y_{T^2}, -\Gamma_\mu \cup -\Gamma_\mu, A_l, -1) \cong \mathbb{C}.$$

As a result,

$$\underline{\text{SHI}}(-Y_{T^2}, -\Gamma_\mu \cup -\Gamma_\mu, A_l, 0) \cong \mathbb{C}^2.$$

From [GL19, Section 5.1], the surfaces A_m and A_l together induce a \mathbb{Z}^2 -grading.

Lemma 6.8. *Suppose (M, γ) is a balanced sutured manifold and $S \subset M$ be a properly surface. Let $\beta \subset \partial M$ be a bypass arc, and the bypass attachment along β changes the suture γ to γ' . Let*

$$\psi : \underline{\text{SHI}}(-M, -\gamma) \rightarrow \underline{\text{SHI}}(-M, -\gamma')$$

be the corresponding bypass map. Then ψ is homogeneous with respect to the grading induced by S on $\underline{\text{SHI}}(-M, -\gamma)$ and $\underline{\text{SHI}}(-M, -\gamma')$.

Proof. Since β is an arc, we can always perform stabilizations on S in the sense of [Li19, Definition 3.1] to make S disjoint from β . Then as in the proof of [Li19, Proposition 5.5], ψ is clearly homogeneous. \square

Lemma 6.9. *Suppose (M, γ) is a balanced sutured manifold and S_1 and S_2 are two admissible surfaces in the sense of [GL19, Definition 2.26] in (M, γ) . Let (i, j) denotes the \mathbb{Z}^2 -grading on $\underline{\text{SHI}}(M, \gamma)$ induced by the pair of surfaces (S_1, S_2) . Let*

$$i_0 = \frac{1}{4}|S_1 \cap \gamma| - \frac{1}{2}\chi(S_1), \text{ and } j_0 = \frac{1}{4}|S_2 \cap \gamma| - \frac{1}{2}\chi(S_2).$$

Suppose (M_1, γ_1) is obtained from (M, γ) by decomposing along S_1 , and $S'_2 \subset (M_1, \gamma_1)$ is obtained from S_2 by cutting along S_1 . Suppose (M_2, γ_2) is obtained from (M_1, γ_1) by decomposing along S'_2 . Then we have an isomorphism

$$\underline{\text{SHI}}(M, \gamma, (i_0, j_0)) \cong \underline{\text{SHI}}(M_2, \gamma_2).$$

Proof. By [GL19, Lemma 2.29], we have

$$\underline{\text{SHI}}(M, \gamma, S_1, i_0) \cong \underline{\text{SHI}}(M_1, \gamma_1).$$

Applying this fact again, we conclude that

$$\underline{\text{SHI}}(M, \gamma, (S_1, S_2), (i_0, j_0)) \cong \underline{\text{SHI}}(M_2, \gamma_2).$$

\square

Next, we want to study a graded version of exact triangle (6.4). First, we want to figure out the double grading on $\underline{\text{SHI}}(-Y_{T^2}, -\Gamma_\mu \cup -\Gamma_0)$ and $\underline{\text{SHI}}(-Y_{T^2}, -\Gamma_\mu \cup -\Gamma_1)$ induced by the pair of annuli (A_l, A_m) . For the sutured manifold $(-Y_{T^2}, -\Gamma_\mu \cup -\Gamma_0)$, A_l and A_m each intersects the suture at two points, so we perform a negative stabilization in the sense of [Li19, Definition 3.1] on each of them to obtain two surfaces A_l^- and A_m^- . Then the \mathbb{Z} -grading associated to A_l^- and A_m^- both support at grading 0 and 1.

Lemma 6.10. *We have*

$$\underline{\text{SHI}}(-Y_{T^2}, -\Gamma_\mu \cup -\Gamma_0) \cong \mathbb{C}^4$$

and the four generators are supported at bi-gradings $(0, 0)$, $(0, 1)$, $(1, 0)$, and $(1, 1)$.

Proof. This is a direct application of Lemma 6.9 by looking at the four pair of surfaces $(-A_l, -A_m)$, $-A_l, A_m$, $(A_l, -A_m)$, (A_l, A_m) . Note when dealing with $-A_l$ and $-A_m$, we need to use a positive stabilization instead, and use the grading shifting property in [GL19, Theorem 1.12] to relate the grading induced by A_l^\pm and A_m^\pm . \square

For the sutured manifold $(-Y_{T^2}, -\Gamma_\mu \cup -\Gamma_1)$, the annulus A_l intersects the suture four times, so it induces a \mathbb{Z} -grading where all non-vanishing gradings are $-1, 0, 1$. The annulus A_m intersects the suture twice, so we perform a negative stabilization as above and use A_m^- to construct a \mathbb{Z} -grading on $\underline{\text{SHI}}(-Y_{T^2}, -\Gamma_\mu \cup -\Gamma_1)$. The non-vanishing gradings are 0 and 1.

Lemma 6.11. *We have*

$$\underline{\text{SHI}}(-Y_{T^2}, -\Gamma_\mu \cup -\Gamma_1) \cong \mathbb{C}^4$$

and the four generators are supported at bi-gradings $(0, -1)$, $(0, 0)$, $(1, 0)$, and $(1, 1)$.

Proof. This is a direct application of Lemma 6.9 by looking at the four pair of surfaces $(-A_l, -A_m)$, $-A_l, A_m$, $(A_l, -A_m)$, (A_l, A_m) . Note when dealing with $-A_m$, we need to use a positive stabilization instead, and use the grading shifting property in [GL19, Theorem 1.12] to relate the grading induced by A_m^+ and A_m^- . \square

Proof of Proposition 6.6. By Lemma 6.8, there is a graded version of (6.4) as follows.

$$(6.6) \quad \begin{array}{ccc} \underline{\text{SHI}}(-Y_{T^2}, -\Gamma_\mu \cup -\Gamma_0, (i'_0, j'_0)) & \xrightarrow{\hat{\psi}_{+,1}^{0,(i'_0, j'_0)}} & \underline{\text{SHI}}(-Y_{T^2}, -\Gamma_\mu \cup -\Gamma_1, (i'_1, j'_1)) \\ \hat{\psi}_{+,0}^{\mu,(0,0)} \uparrow & & \swarrow \hat{\psi}_{+,\mu}^{1,(i'_1, j'_1)} \\ \underline{\text{SHI}}(-Y_{T^2}, -\Gamma_\mu \cup -\Gamma_\mu, (0, 0)) & & \end{array}$$

for some indices (i'_0, j'_0) and (i'_1, j'_1) . From above argument, we know that

$$\underline{\text{SHI}}(-Y_{T^2}, -\Gamma_\mu \cup -\Gamma_\mu, (0, 0)) \cong \mathbb{C}^2.$$

From Lemma 6.10, we know that

$$\dim \underline{\text{SHI}}(-Y_{T^2}, -\Gamma_\mu \cup -\Gamma_0, (i'_0, j'_0)) \leq 1.$$

From Lemma 6.11, we know that

$$\dim \underline{\text{SHI}}(-Y_{T^2}, -\Gamma_\mu \cup -\Gamma_1, (i'_1, j'_1)) \leq 1.$$

Since the three terms fit into an exact triangle as in (6.6), we must have

$$\dim \underline{\text{SHI}}(-Y_{T^2}, -\Gamma_\mu \cup -\Gamma_0, (i'_0, j'_0)) = 1$$

and the map $\hat{\psi}_{\pm,0}^{\mu,(0,0)}$ is surjective. Since we already have the nonvanishing result in Lemma 6.7, to show that

$$\theta(\xi_{+-}) \doteq \theta(\xi_{-+}),$$

it suffices to prove that

$$\hat{\psi}_{+,0}^\mu(\theta(\xi_{+-})) = \hat{\psi}_{+,0}^\mu(\theta(\xi_{-+})) = 0.$$

For the contact structure ξ_{-+} , the image $\hat{\psi}_{+,0}^\mu(\theta(\xi_{-+})) = 0$ because after attaching the last bypass to ξ_{-+} , the resulting contact structure admits a Giroux torsion so has vanishing contact element by

[LY21c, Section 4]. For the contact structure ξ_{+-} , note we have

$$\begin{aligned}\hat{\psi}_{+,0}^\mu(\theta(\xi_{-+})) &= \hat{\psi}_{+,0}^\mu \circ \hat{d}_+ \circ \hat{d}_-(\theta(\xi_{st})) \\ &= \hat{\psi}_{+,0}^\mu \circ (\hat{\psi}_{+,\mu}^1 \circ \hat{\psi}_{+,\mu}^\mu) \circ (\hat{\psi}_{-,\mu}^1 \circ \hat{\psi}_{-,\mu}^\mu)(\theta(\xi_{st})) \\ &= 0\end{aligned}$$

It is finally zero since $\hat{\psi}_{+,0}^\mu$ and $\hat{\psi}_{+,\mu}^1$ fit into an exact triangle. \square

6.3. Classification of complexes. Suppose $K \subset S^3$ is a knot of torsion order one (*c.f.* Definition 6.4). From Lemma 6.3, we know $d_\pm = d_{1,\pm}$, *i.e.* differentials on higher pages vanish. Then Theorem 6.5 imposes strong restrictions on the differentials. In this subsection, we prove a classification theorem for complexes of knots of torsion order one.

Lemma 6.12. *Suppose $K \subset S^3$ is a knot with torsion order one and*

$$\dim \Gamma_\mu = \|\Delta_K(t)\|,$$

where $\|\cdot\|$ is the sum of absolute values of coefficients. Write $d_\pm = d_{1,\pm}$ for simplicity. Then up to changing a basis, the pair $(\Gamma_\mu, d_+ + d_-)$ is the direct sum of the following three basic types of complexes, which are called squares for C and staircases for C_l .

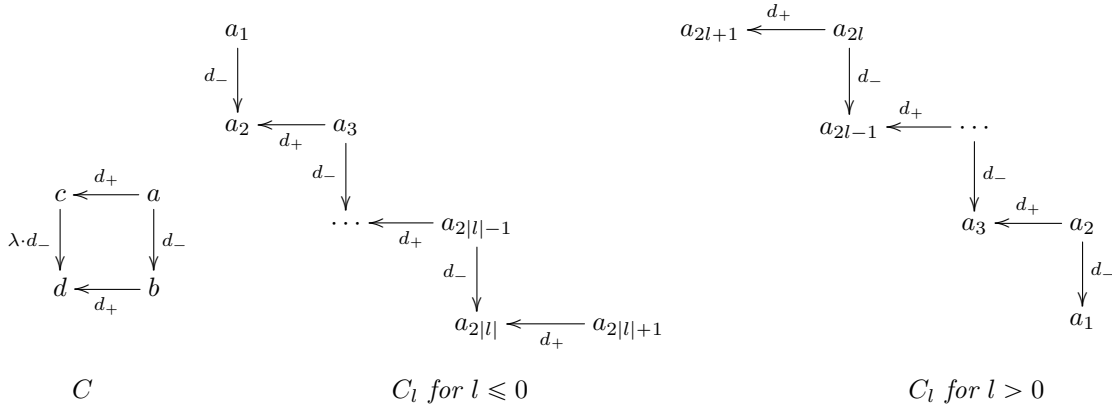

where λ is the scalar from Theorem 6.5 to make the diagram in C commute.

Proof. The proof is an adaption of the proof of [Pet13, Lemma 7] to our setup. Note that the proof in the reference studied spaces with coefficients \mathbb{F}_2 , while we deal with coefficients \mathbb{C} here. Theorem 6.5 shows that d_+ and d_- commute up to a scalar, so $(d_+ + d_-)^2$ is not necessarily zero if the scalar is not -1 . But we can still carry out the proof similarly.

We now treat $(\Gamma_\mu, d_+ + d_-)$ as a purely algebraic object and prove by induction on the dimension of Γ_μ . Fix a basis of (Γ_μ, i) for each grading i that is homogeneous with respect to the \mathbb{Z}_2 homological grading. For a basis element b , we say that there is an upward arrow from an element a to b if

$$d_+(a) = \lambda \cdot b + (\text{linear combination of other basis elements})$$

for some $\lambda \neq 0$. To be consistent with the complex in [Pet13, Lemma 7], we use leftward arrows to represent upward arrows. In particular, w and z arrows correspond to d_+ and d_- arrows, respectively. Note that if $b \in (\Gamma_\mu, i)$, then $a \in (\Gamma_\mu, i - 1)$ since $d_+ = d_{1,+}$ shift the Seifert grading by $+1$. We define downward arrows using d_- similarly.

We start with a basis element $b_1 \in (\Gamma_\mu, -g)$, where $g = g(K)$. Note that $-g$ is the minimal nontrivial grading of Γ_μ .

Case 1. There is a downward arrow from a to b for some $a \in (\Gamma_\mu, -g + 1)$, *i.e.*, we have

$$d_-(a) = \sum_{i=1}^n \lambda_i \cdot b_i$$

for some basis elements b_2, \dots, b_n (possibly $n = 1$). We change the basis by replacing $\{b_1, \dots, b_n\}$ with $\{b = \sum_{i=1}^n \lambda_i \cdot b_i, b_2, \dots, b_n\}$. Then $d_-(a) = b$. Since b lives in the minimal nontrivial grading, there is no downward arrow originating at b and no upward arrow pointing to b . If there are other basis element with downward arrow to b , add a to each of them with a proper coefficient, so that in the new basis only a has a downward arrow to b . If there is an upward arrow from b' to a for some $b' \in (\Gamma_\mu, -g)$, then $d_- \circ d_+(b')$ must have nonzero coefficient on b , which contradicts the fact that $d_+ \circ d_+(b') = 0$ and the commutivity from Theorem 6.5. Hence there is no upward arrow pointing to a .

Case 1.1. We have $d_+(b) \neq 0$. We will split off a C summand and hence the induction applies. Indeed, let $d = d_+(b) \neq 0$ and $c = d_+(a)$. From Theorem 6.5, we have

$$d_-(c) = d_- \circ d_+(a) \doteq d_+ \circ d_-(a) = d_+(b) = d \neq 0.$$

Then Case 1.1 in the proof of [Pet13, Lemma 7] applies verbatim and we can change the basis to make the following conditions hold:

- (1) c and d are basis elements;
- (2) b is the only basis element with an upward arrow to d ;
- (3) c is the only basis element with a downward arrow to d ;
- (4) a is the only basis element with an upward arrow c ;
- (5) a is the only basis element with a downward arrow to b .

Hence the span of a, b, c, d is a C summand.

Case 1.2. We have $d_+(b) = 0$. The grading of b guarantees that $b \notin \text{Im } d_+$ so

$$[b] \neq 0 \in H(\Gamma_\mu, d_+) \cong I^\sharp(-S^3) \cong \mathbb{C}.$$

As a result, there is no other generators of $H(\Gamma_\mu, d_+)$. In particular, $c = d_+(a) \neq 0$ since we have already argued that there is no upward arrow to a . Now $d_-(c) = d_+ \circ d_-(b) = 0$ by grading argument and $d_+(c) = 0$ since $d_+^2 = 0$. As in the proof of [Pet13, Lemma 7], we can change the basis so that c is a basis element and a is the only basis element with an upward arrow to c .

Case 1.2.1. There is no downward arrow to c . In this case we can split off the staircase spanned by a, b , and c .

Case 1.2.2. There is a downward arrow to c . As in the proof of [Pet13, Lemma 7], after a suitable change of basis, either we eliminate the arrow to c so that we can split off a staircase spanned by a, b , and c , or we can find d so that $d_-(d) = c$ and d is the only basis element with a downward arrow to c , and we can repeat the argument in Case 1.2 to further trace along the staircase.

Case 2. There is no downward arrow to b . We will split off a staircase. If $d_+(b) = 0$ we split off the single b . If $c = d_+(b) \neq 0$ we can change the basis to make c a basis element and b is the only basis element with an upward arrow to c . As above also know that $d_+(c) = 0$ and $d_-(c) = 0$. Note now $[b]$ is the unique generator of $H(\Gamma_\mu, d_-)$ so we know that there exists d with $d_-(d) = c$. As in the proof of [Pet13, Lemma 7] we can keep this argument to split off a staircase starting from b .

In any case we can split off either a square or a staircase hence the induction applies. \square

Corollary 6.13. *Suppose $K \subset S^3$ is a knot with torsion order one and*

$$\dim \mathbf{\Gamma}_\mu = \|\Delta_K(t)\|.$$

Then the structure of $(\mathbf{\Gamma}_\mu, d_+ + d_-)$ is determined by $\Delta_K(t)$ and $\tau_I(K)$.

Proof. The proof of [Pet13, Theorem 4] applies verbatim. In particular, there is a unique staircase C_l with $l = \tau_I(K)$, i.e.,

$$a_1 \in (\mathbf{\Gamma}_\mu, -\tau_I(K)) \text{ and } a_{2|l|+1} \in (\mathbf{\Gamma}_\mu, \tau_I(K)).$$

The remaining squares can then be fixed by $\Delta_K(t)$. \square

Corollary 6.14. *Suppose $K \subset S^3$ is a knot so that K has torsion order one and*

$$\dim \mathbf{\Gamma}_\mu = \|\Delta_K(t)\|.$$

Suppose further that $\tau_I(K) = \tau(K) = \tau$. Then for any $r = p/q \in \mathbb{Q} \setminus \{0\}$ with $q \geq 1$, we have

$$\dim I^\sharp(S_r^3(K)) = \dim_{\mathbb{F}_2} \widehat{HF}(S_r^3(K)) = \begin{cases} (\|\Delta_K(t)\| + 2|\tau| - 3) \cdot q/2 + |p - q \cdot (2|\tau| - 1)| & \tau > 0 \\ (\|\Delta_K(t)\| + 2|\tau| - 3) \cdot q/2 + |-p - q \cdot (2|\tau| - 1)| & \tau < 0 \\ (\|\Delta_K(t)\| - 1) \cdot q/2 + |p| & \tau = 0. \end{cases}$$

Proof. Since $\tau_I(K) = \tau(K)$, we know from Lemma 6.13 and [Pet13, Theorem 1.4] that the differentials in instanton and Heegaard Floer theory have exactly the same structure. Explicitly, there is one staircase C_τ and k squares for

$$k = \frac{\|\Delta_K(t)\| - 2|\tau| - 1}{4}.$$

Despite of the difference in coefficients, we can apply the large surgery formulae in [OS04] and [LY21c] to obtain

$$\dim I^\sharp(S_{\pm n}^3(K)) = \dim_{\mathbb{F}_2} \widehat{HF}(S_{\pm n}^3(K))$$

for any large enough n . Explicitly, we have the following.

- (1) A square C contributes two-dimensional subspaces for both $(\pm n)$ -surgeries
- (2) A staircase C_l with $l < 0$ contributes a n -dimensional subspace for $(-n)$ -surgery and a $(n+4|l|-2)$ -dimensional subspace for $+n$ -surgery.
- (3) A staircase C_0 contributes a n -dimensional subspace for both $(\pm n)$ -surgeries.
- (4) A staircase C_l with $l > 0$ contributes a $(n+4l-2)$ -dimensional subspace for $(-n)$ -surgery and a n -dimensional subspace for $+n$ -surgery.

Note that a figure-eight has one square and a staircase C_0 and the torus knot $T(2, 2l+1)$ has a staircase C_l and no square. Then the corollary follows from the dimension formulae in [BS21, Theorem 1.1] and [Han20, Proposition 15] for instanton and Heegaard Floer theory. \square

6.4. Induction using oriented skein relation. In this subsection, we study differentials for a family of knots $K(a_1, \dots, a_{2n+1})$, where a_1, \dots, a_{2n+1} are the numbers of full-twists as in Figure 6.

Proposition 6.15. *Suppose $K = K(a_1, \dots, a_{2n+1})$ with $a_i \geq 0$. Let*

$$k = \#\{i \mid a_i \geq 1\}.$$

If $k \leq n+1$, then we have the following.

- (1) $\tau_I(K) = g(K) = n$.
- (2) K has torsion order one (c.f. Definition 6.4).

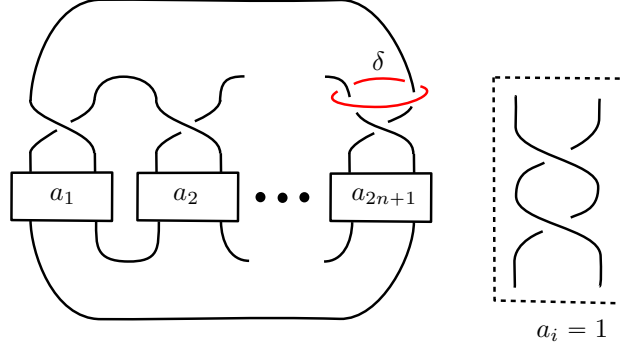
FIGURE 6. The knot $K(a_1, \dots, a_{2n+1})$.

Proof of Theorem 1.5. When $a_i > 0$ for all i we know that K is an alternating knot. It follows from [BS21, Corollary 1.8] and [GLW19, Theorem 1.2] that $\tau_I(K) = \tau(K)$ for all alternating knots. Moreover, by the spectral sequence in [KM11a], we know $\dim \Gamma_\mu = \|\Delta_K(t)\|$. Then Proposition 6.15 and Corollary 6.14 apply. \square

We start by some preparation lemmas. Suppose $K_+ \subset S^3$ is a knot and δ is a curve circling around a crossing of K_+ as in Figure 7. Write $K_- \subset S^3_{-1}(\delta) \cong S^3$ and $K_0 \subset S^3_0(\delta) \cong S^1 \times S^2$. We can discuss the tau invariant for the knot $K_0 \subset S^1 \times S^2$ once we fix an element in $I^\sharp(-S^1 \times S^2)$. For any $* \in \mathbb{Q} \cup \{\mu\}$, write

$$\Gamma_*^\pm = \underline{\text{SHI}}(-S^3 \setminus N(K_\pm), -\Gamma_*) \text{ and } \Gamma_*^0 = \underline{\text{SHI}}(-S^1 \times S^2 \setminus N(K_0), -\Gamma_*)$$

The bypass maps are written as $\psi_{\pm, n_2}^{\bullet, n_1}$ for $\bullet \in \{+, -, 0\}$. The maps F_n^\bullet, G_n^\bullet from surgeries along a meridian of K_+ are defined similarly. For simplicity, we will write d_1^\bullet for $d_{1,+}^\bullet$.

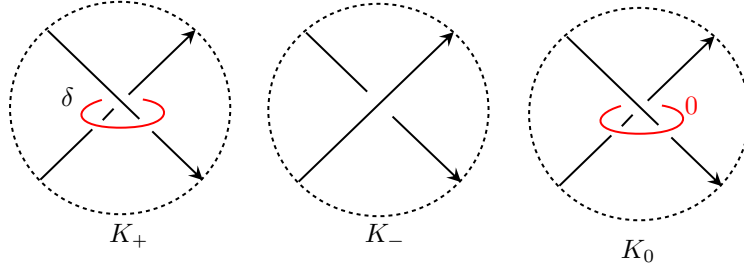
FIGURE 7. The knots K_+, K_- and K_0 .

Since $\dim I^\sharp(-S^1 \times S^2) = 2$, we have two effective tau-invariants for the knot K_0 . To specify choices, first note that there is a surgery exact triangle associated to δ :

$$(6.7) \quad \begin{array}{ccc} I^\sharp(-S^3) & \xrightarrow{H_\delta} & I^\sharp(-S^3) \\ & \swarrow G_\delta & \searrow F_\delta \\ & I^\sharp(-S^1 \times S^2) & \end{array}$$

Pick $\alpha_1 \neq 0 \in \text{Im } F_\delta$ then we can define

$$\tau_{\alpha_1}(K_0) = \max\{i \mid \exists x \in (\Gamma_n^0, i) \text{ s.t. } F_n^0(x) = \alpha_1\} - \frac{n-1}{2}.$$

Note $\text{Im } F_\delta$ is 1-dimensional, so it does matter what scalar to put on α_1 . We pick

$$\alpha_2 \in I^\sharp(-S^1 \times S^2) \setminus \text{Im } F_\delta$$

so that the value

$$\tau_{\alpha_2}(K_0) = \max\{i \mid \exists x \in (\Gamma_n^0, i) \text{ s.t. } F_n^0(x) = \alpha_2\} - \frac{n-1}{2}$$

takes the maximal value among all possible α_2 .

Lemma 6.16. *For the knots K_+ , K_- , and K_0 , suppose the following.*

- (i) $\dim \Gamma_\mu^+ = \dim \Gamma_\mu^- + \dim \Gamma_\mu^0$.
- (ii) $\tau_I(K_-) = \tau_{\alpha_2}(K_0) - 1$.
- (iii) *The knots K_- and K_0 both have torsion order one.*

Then K_+ has torsion order one.

Proof. The surgery triangle with respect to δ gives rise to an exact triangle

$$\begin{array}{ccc} \Gamma_\mu^- & \xrightarrow{H_{\delta,\mu}} & \Gamma_\mu^+ \\ & \swarrow G_{\delta,\mu} & \searrow F_{\delta,\mu} \\ & \Gamma_\mu^0 & \end{array}$$

Condition (i) implies that $G_{\delta,\mu} = 0$. Since the surgery maps associated to δ commutes with the differentials d_1^\bullet on Γ_μ^\bullet , we have a short exact sequence of chain complexes:

$$0 \rightarrow (\Gamma_\mu^-, d_1^-) \rightarrow (\Gamma_\mu^-, d_1^-) \rightarrow (\Gamma_\mu^-, d_1^-) \rightarrow 0.$$

The Zigzag lemma gives rise to an exact triangle

$$(6.8) \quad \begin{array}{ccc} H(\Gamma_\mu^-, d_1^-) & \xrightarrow{H_{\delta,\mu,*}} & H(\Gamma_\mu^+, d_1^+) \\ & \swarrow \partial_* & \searrow F_{\delta,\mu,*} \\ & H(\Gamma_\mu^0, d_1^0) & \end{array}$$

From condition (iii) we know that $H(\Gamma_\mu^-, d_1^-) \cong \mathbb{C}$ and $H(\Gamma_\mu^0, d_1^0) \cong \mathbb{C}^2$. So in order to prove the lemma, it is suffice to show that $\partial_* \neq 0$. To do this, let $\beta_2 = G_\delta(\alpha_2) \neq 0 \in I^\sharp(-S^3)$. Pick n large enough and $x^- \in (\Gamma_n^-, \tau_I(K_-))$ so that $F_n^-(x^-) = \beta$. Take $u^- = \psi_{+,+, \mu}^-, n(x^-)$. It is straightforward to check that $d_1^-(u^-) = 0$ and $u^- \notin \text{Im } d_1^-$. Then $H(\Gamma_\mu^-, d_1^-)$ is generated by $[u^-]$.

Pick $x_2^0 \in (\Gamma_n^0, \tau_{\alpha_2}(K^0))$ so that $F_n^0(x_2^0) = \alpha_2$. We have the following diagrams where the triangles are exact and parallelograms are commutative.

$$(6.9) \quad \begin{array}{ccccc} & & H_{\delta,n} & & \\ & & \longrightarrow & & \\ \Gamma_n^- & & & & \Gamma_n^+ \\ & \swarrow G_{\delta,n} & & \searrow F_{\delta,n} & \\ & & \Gamma_n^0 & & \\ & \swarrow \psi_{+,+, \mu}^{-,n} & & \searrow \psi_{+,+, \mu}^{+,n} & \\ \Gamma_\mu^- & & & & \Gamma_\mu^+ \\ & \swarrow G_{\delta,\mu} & & \searrow F_{\delta,\mu} & \\ & & \Gamma_\mu^0 & & \end{array} \quad \begin{array}{ccccc} & & H_{\delta,n} & & \\ & & \longrightarrow & & \\ \Gamma_n^- & & & & \Gamma_n^+ \\ & \swarrow G_{\delta,n} & & \searrow F_{\delta,n} & \\ & & \Gamma_n^0 & & \\ & \swarrow \psi_{+,+, \mu}^{-, \mu, n} & & \searrow \psi_{+,+, \mu}^{+, \mu, n} & \\ \Gamma_\mu^- & & & & \Gamma_\mu^+ \\ & \swarrow G_{\delta,\mu} & & \searrow F_{\delta,\mu} & \\ & & \Gamma_\mu^0 & & \end{array}$$

Claim. We have $G_{\delta,n}(x_2^0) = U(x^-)$.

Proof of Claim. Suppose not, i.e., $y = G_{\delta,n}(x_2^0) - Ux^- \neq 0$. Note

$$F_n^-(y) = F_n^- \circ G_{\delta,n}(x_2^0) - F_n^- \circ U(x^-) = G_\delta(\alpha) - G_\delta(\alpha) = 0.$$

Hence the fact that K^- has torsion order one implies that $y \notin \text{Im } U$. As a result,

$$v = \psi_{+, \mu}^-, n(y) = \psi_{+, \mu}^-, n \circ G_{\delta,n}(x_2^0) \neq 0.$$

From the commutativity we know

$$G_{\delta,\mu} \circ \psi_{+, \mu}^{0,n}(x_2^0) \neq 0$$

which contradicts the fact that $G_{\delta,\mu} = 0$ implied by Condition (i). \square

Now since $Ux^- = G_{\delta,n}(x_2^0)$, we know from the commutativity that

$$U \circ H_{\delta,n}(x^-) = H_{\delta,n} \circ U(x^-) = 0.$$

Then there exists $u^+ \in \Gamma_\mu^+$ so that $H_{\delta,n}(x^-) = \psi_{+, \mu}^+, n(u^+)$. Take $u^0 = F_{\delta,\mu}(u^+)$, we know from the commutativity that

$$\psi_{+, \mu}^{0,n}(u^0) = F_{\delta,n} \circ \psi_{+, \mu}^+, n(u^+) = 0.$$

As a result, $d_1^0(u^0) = 0$. Also, we know

$$\begin{aligned} d_1^+(u^+) &= \psi_{+, \mu}^+, n \circ \psi_{+, \mu}^+, \mu(u^+) \\ &= \psi_{+, \mu}^+, n \circ H_{\delta,n}(x^-) \\ &= H_{\delta,\mu} \circ \psi_{+, \mu}^-, n(x^-) \\ &= H_{\delta,\mu}(u^-). \end{aligned}$$

By the construction of ∂_* , we conclude that $\partial_*([u^0]) = [u^-]$ and we conclude the proof of the lemma. \square

Lemma 6.17. For the knots K_+ , K_- , and K_0 , suppose we have the following.

- (i) All three knots K_- , K_0 and K_+ have torsion order one.
- (ii) Either $\dim \Gamma_\mu^+ = \dim \Gamma_\mu^- + \dim \Gamma_\mu^0$, or $\dim \Gamma_\mu^0 = \dim \Gamma_\mu^- + \dim \Gamma_\mu^+$.

Then $\tau_{\alpha_1}(K_0) = \tau_I(K_+)$.

Proof. From Condition (ii) and the zigzag lemma there exist an exact triangle

$$(6.10) \quad \begin{array}{ccc} H(\Gamma_\mu^-, d_1^-) & \xrightarrow{\quad} & H(\Gamma_\mu^+, d_1^+) \\ & \swarrow & \searrow^{F_{\delta, \mu, *}} \\ & H(\Gamma_\mu^0, d_1^0) & \end{array}$$

Condition (i) implies that $H(\Gamma_\mu^+, d_1^+) \cong \mathbb{C}$ and $F_{\delta, \mu, *} \neq 0$. Take $\beta_1 \in I^\sharp(-S^3)$ so that $F_\delta(\beta_1) = \alpha_1$. Take $x^+ \in (\Gamma_n^+, \tau_I(K_+))$ so that $F_n^+(x^+) = \beta_1$. We know from the commutativity that

$$F_n^0 \circ F_{\delta, n}(\beta_1) = F_\delta \circ F_n^+(x^+) = \alpha_1.$$

Hence by the definition of τ we know $\tau_{\alpha_1}(K_0) \geq \tau_I(K_+)$. Suppose $\tau_{\alpha_1}(K_0) = \tau_I(K_+) + k$ for some $k > 0$. Now take $v^+ = \psi_{+, \mu}^{+, n}(x^+)$. We know that $d_1^+(v^+) = 0$ and $v^+ \notin \text{Im } d_1^+$. So $H(\Gamma_\mu^+, d_1^+) \cong \mathbb{C}$ is generated by $[v^+]$. Let $v^0 = F_{\delta, \mu}(v^+)$, we know that $F_{\delta, \mu, *}([v^+]) = [v^0]$.

Pick $x_1^0 \in (\Gamma_n^0, \tau_{\alpha_1}(K_0))$ so that $F_n^0(x_1^0) = \alpha_1$, then we know that

$$F_n^0 \left(F_{\delta, n}(x^+) - U^k(x_1^0) \right) = \alpha_1 - \alpha_1 = 0.$$

Since K_0 has torsion order one as in Condition (i), we know that

$$U \left(F_{\delta, n}(x^+) - U^k(x_1^0) \right) = 0.$$

As a result, there exists $w^+ \in \Gamma_\mu^0$ so that $F_{\delta, n}(x^+) - U^k(x_1^0) = \psi_{+, n}^{+, \mu}(w^0)$. As a result, we know that

$$\begin{aligned} v^0 &= F_{\delta, \mu}(v^+) \\ &= \psi_{+, \mu}^{0, n} \circ F_{\delta, n}(x^+) \\ &= \psi_{+, \mu}^{0, n} \left(F_{\delta, n}(x^+) - U^k(x_1^0) \right) \\ &= \psi_{+, \mu}^{0, n} \psi_{+, n}^{+, \mu}(w^0) \\ &= d_1^0(w^0). \end{aligned}$$

As a result, we know that $F_{\delta, \mu, *}([v^+]) = [v^0] = 0$, which contradicts the fact that $F_{\delta, \mu, *}$ fits into the exact triangle (6.10) and the fact that $F_{\delta, \mu, *} \neq 0$. \square

Lemma 6.18. *For the knots K_+ , K_- , and K_0 , suppose we have the following.*

- (i) *The knots K_- and K_+ both have torsion order one.*
- (ii) *We have $\dim \Gamma_\mu^0 = \dim \Gamma_\mu^- + \dim \Gamma_\mu^+$*

Then we have the following.

- (1) *K_0 has torsion order one.*
- (2) *We have $\tau_{\alpha_2}(K_0) = \tau_I(K_-)$.*

Proof. From Condition (ii) and the Zigzag lemma, we have an exact triangle

$$(6.11) \quad \begin{array}{ccc} H(\Gamma_\mu^-, d_1^-) & \longrightarrow & H(\Gamma_\mu^+, d_1^+) \\ & \swarrow G_{\delta, \mu, *}, \searrow F_{\delta, \mu, *} & \\ & H(\Gamma_\mu^0, d_1^0) & \end{array}$$

From Condition (i) we know $H(\Gamma_\mu^+, d_1^+) \cong H(\Gamma_\mu^+, d_1^+) \cong \mathbb{C}$ so $\dim H(\Gamma_\mu^0, d_1^0) \leq 2$. On the other hand, we know $\dim H(\Gamma_\mu^0, d_1^0) \geq \dim I^\sharp(-S^1 \times S^2) = 2$. As a result, we know $\dim H(\Gamma_\mu^0, d_1^0) = 2$ which implies that K_0 has torsion order one, $F_{\delta, \mu, *} \neq 0$, and $G_{\delta, \mu, *} \neq 0$.

Note all hypothesis of Lemma 6.17 are satisfied so the argument in the proof of that lemma applies. In particular, we know $\tau_{\alpha_1}(K_0) = \tau_I(K_+)$. We can pick $x^+ \in (\Gamma_n^+, \tau_I(K^+))$ so that $F_n^+(x^+) = \beta_1$, and take

$$x_1^0 = F_{\delta, n}(x^+), \quad v_1^0 = \psi_{+, \mu}^{0, n}(x_1^0), \quad \text{and } v^+ = \psi_{+, \mu}^{0, n}(x^+).$$

We know from the proof of Lemma 6.17 that $F_{\delta, \mu, *}([v^+]) = [v_1^0] \neq 0$.

Pick $x_2^0 \in (\Gamma_n^0, \tau_{\alpha_2}(K))$ so that $F_n^0(x_2^0) = \alpha_2$ and take $v_2^0 = \psi_{+, \mu}^{0, n}(x_2^0)$. It is straightforward to check that $d_1^0(v_2^0) = 0$ and $v_2^0 \notin \text{Im } d_1^0$.

Claim. The homology $H(\Gamma_\mu^0, d_1^0)$ is generated by $[v_1^0]$ and $[v_2^0]$.

Proof of Claim. When v_1^0 and v_2^0 have different gradings in Γ_μ^0 , the claim follows immediately from the fact that $\dim H(\Gamma_\mu^0, d_1^0) = 2$. When v_1^0 and v_2^0 have the same grading, which means x_1^0 and x_2^0 have the same grading in Γ_n^0 and hence $\tau_{\alpha_1}(K_0) = \tau_{\alpha_2}(K_0)$. In this case, suppose that there exists complex numbers c_1, c_2 , not both zero, and an element $w^0 \in \Gamma_\mu^0$ so that

$$c_1 \cdot v_1^0 + c_2 \cdot v_2^0 + d_1^0(w^0) = 0.$$

Take $y^0 = \psi_{+, \mu}^{0, \mu}(w^0)$, then the above equality is equivalent to

$$\psi_{+, \mu}^{0, n}(c_1 \cdot x_1^0 + c_2 \cdot x_2^0 + y^0) = 0,$$

which implies that there exists $z^0 \in (\Gamma_n^0, \tau_{\alpha_1}(K_0) + 1 = \tau_{\alpha_2}(K_0) + 1)$ so that

$$c_1 \cdot x_1^0 + c_2 \cdot x_2^0 + y^0 + Uz^0 = 0.$$

From the construction we know $Uy^0 = 0$ hence $F_n^0(y^0) = 0$. Since the grading of z^0 is strictly larger than both $\tau_{\alpha_1}(K_0)$ and $\tau_{\alpha_2}(K_0)$, the choice of α_1 and α_2 implies that $F_n^0(z) = 0$. As a result we have

$$c_1 \cdot \alpha_1 + c_2 \cdot \alpha_2 = F_n^0(c_1 \cdot x_1^0 + c_2 \cdot x_2^0 + y^0 + Uz^0) = 0.$$

Thus we must have $c_1 = c_2 = 0$ and hence $[v_1^0]$ and $[v_2^0]$ are linearly independent. \square

With the help of the above claim, the proof that $\tau_{\alpha_2}(K_0) = \tau_I(K_-)$ is similar to the proof of Lemma 6.17. \square

Proof of Proposition 6.15. We use induction on k to prove the following.

- (i) The knot K has genus $g(K) = n$.
- (ii) The coefficient of the term t^i in $\Delta_K(t)$ has sign $(-1)^{n-i}$.
- (iii) The knot has torsion order one.
- (iv) We have $\tau_I(K) = n$.

When $k = 0$, the knot is the torus knot $T(2, 2n + 1)$, so all the above four statements hold. Suppose we have proved the above four statements for k . Now we deal with the case $k + 1$. Without loss of generality, we can assume that $a_{2n+1} > 1$ while $a_{2n} = 1$. Write

$$K_l = K(a_1, a_2, a_3, \dots, a_{2n}, l).$$

We know $K = K_{a_{2n+1}}$. Note $K_{-1} = K(a_1, a_2, \dots, a_{2n-1})$ and $K_1 = K(a_1, \dots, a_{2n} = 1, 1)$, so inductive hypothesis applies to both K_{-1} and K_1 . Let δ be a curve circling around the crossing corresponding to a_{2n+1} as shown in Figure 6. Then we can take $K_+ = K_1$, $K_- = K_{-1}$ and there is a corresponding $K_0 \subset S^1 \times S^2$. From [KM10a] we know that

$$\chi_{gr}(\mathbf{\Gamma}_\mu^\pm) = -\Delta_{K_\pm}(t) \text{ and } \chi_{gr}(\mathbf{\Gamma}_\mu^+) - \chi_{gr}(\mathbf{\Gamma}_\mu^-) = \chi_{gr}(\mathbf{\Gamma}_\mu^0).$$

Also, since $K_{\pm 1}$ are both alternating knots, we know that

$$\dim \mathbf{\Gamma}_\mu^\pm = \|\chi_{gr}(\mathbf{\Gamma}_\mu^\pm)\|,$$

where $\|\cdot\|$ means the sum of the absolute values of coefficients. Statements (i) and (ii) applied to $K_{\pm 1}$ then implies that

$$\begin{aligned} \dim \mathbf{\Gamma}_\mu^0 &\geq \|\chi_{gr}(\mathbf{\Gamma}_\mu^0)\| \\ &= \|\chi_{gr}(\mathbf{\Gamma}_\mu^+) - \chi_{gr}(\mathbf{\Gamma}_\mu^-)\| \\ &= \|\chi_{gr}(\mathbf{\Gamma}_\mu^+)\| + \|\chi_{gr}(\mathbf{\Gamma}_\mu^-)\| \\ &= \dim \mathbf{\Gamma}_\mu^+ + \dim \mathbf{\Gamma}_\mu^- \end{aligned}$$

Then it follows from the exact triangle

$$\begin{array}{ccc} \mathbf{\Gamma}_\mu^- & \xrightarrow{H_{\delta, \mu}} & \mathbf{\Gamma}_\mu^+ \\ & \swarrow G_{\delta, \mu} & \searrow F_{\delta, \mu} \\ & \mathbf{\Gamma}_\mu^0 & \end{array}$$

that $\dim \mathbf{\Gamma}_\mu^0 = \dim \mathbf{\Gamma}_\mu^+ + \dim \mathbf{\Gamma}_\mu^-$. Then we can apply Lemma 6.17 and Lemma 6.18 to conclude that K_0 has torsion order one, and $\tau_{\alpha_1}(K_0) = \tau_{\alpha_2}(K_0) + 1 = g$.

Now for any odd $l > 0$, we can take $K_+ = K_l$, $K_- = K_{l-2}$, and take K_0 to be the same knot as the one for K_1 and K_{-1} . Hence we can apply Lemma 6.3 to inductively conclude all four statements.

In the statement of Proposition 6.15, we require that $k \leq n + 1$. This extra assumption is because our strategy is to cancel two crossings when $a_{2n} = 1$ and $a_{2n+1} = -1$. In particular, in the proof we need $a_{2n} = 1$ through out the induction so that we have enough information to start with to understand larger a_{2n+1} . This means at the very beginning we need at least half of a_i to be 1. \square

7. TWISTED WHITEHEAD DOUBLES AND SPLICINGS

The techniques in Section 6.4 can also be used to study twisted Whitehead doubles.

Definition 7.1. Suppose $\widehat{V} \subset S^3$ is an unknotted solid torus. Let $\widehat{K} \subset \widehat{V}$ be the knot as in Figure 8. Let $\widehat{\mu}$ be a non-separating curve on $\partial \widehat{V}$ bounding a disk in \widehat{V} and $\widehat{\lambda}$ be a non-separating curve on $\partial \widehat{V}$ bounding a disk in $S^3 \setminus \widehat{V}$. Let J be a knot in S^3 and V a tubular neighborhood of J . Let μ and λ be the meridian and Seifert longitude of J , respectively. Let

$$f : \widehat{V} \hookrightarrow S^3$$

be an embedding so that $f(\widehat{V}) = V$, $f(\widehat{\mu}) = \mu$ and $f(\widehat{\lambda}) = \lambda$. Let $K = f(\widehat{K})$. Then K is called the **positively clasped t -twist Whitehead double** of J , denoted by $D_t^+(J)$.

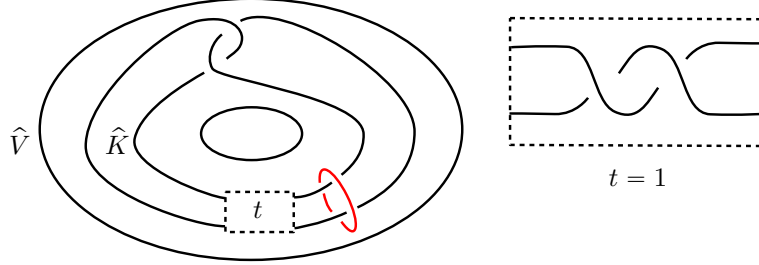

FIGURE 8. Whitehead double.

Remark 7.2. We can also study the negatively clasped Whitehead doubles. Note they are the mirror of positively clasped Whitehead doubles as in [Hed07].

Here are some basic properties of K .

Lemma 7.3 ([Hed07]). *Suppose K is the positively clasped t -twist Whitehead double of J . Then we have the following.*

- (1) *The genus of K is one.*
- (2) $\Delta_K(T) = -t \cdot T + (2t + 1) - t \cdot T^{-1}$.

Since the Whitehead doubles all have genus 1, there are only three nontrivial gradings of its KHI to study. Note the top and bottom gradings are isomorphic to each other. The following lemma describe the top (and hence the bottom) grading.

Lemma 7.4. *Suppose K is the positively clasped t -twist Whitehead double of J . Then*

$$\underline{\text{KHI}}(S^3, K, 1) \cong \underline{\text{SHI}}(S^3 \setminus N(J), \Gamma_{-t}).$$

Proof. A genus-one Seifert surface S of K can be drawn as in Figure 9 (Inside \widehat{V}). From the proof of [KM11b, Proposition 7.16], we know that there is an isomorphism

$$\underline{\text{KHI}}(S^3, K, 1) \cong \underline{\text{SHI}}(S^3 \setminus [-1, 1] \times S, \{0\} \times \partial S).$$

As shown in Figure 9, the sutured manifold $(S^3 \setminus [-1, 1] \times S, \{0\} \times \partial S)$ admits a product disk D and it is straightforward to check that there is a sutured manifold decomposition

$$(S^3 \setminus [-1, 1] \times S, \{0\} \times \partial S) \stackrel{D}{\rightsquigarrow} (S^3 \setminus N(J), \Gamma_{-t}).$$

Note we can fix the suture as Γ_{-t} by counting its intersections with μ and λ explicitly. Hence we conclude that

$$\begin{aligned} \underline{\text{KHI}}(S^3, K, 1) &\cong \underline{\text{SHI}}(S^3 \setminus [-1, 1] \times S, \{0\} \times \partial S) \\ &\cong \underline{\text{SHI}}(S^3 \setminus N(J), \Gamma_{-t}). \end{aligned}$$

□

Now we compute the tau invariants for the twisted Whitehead doubles.

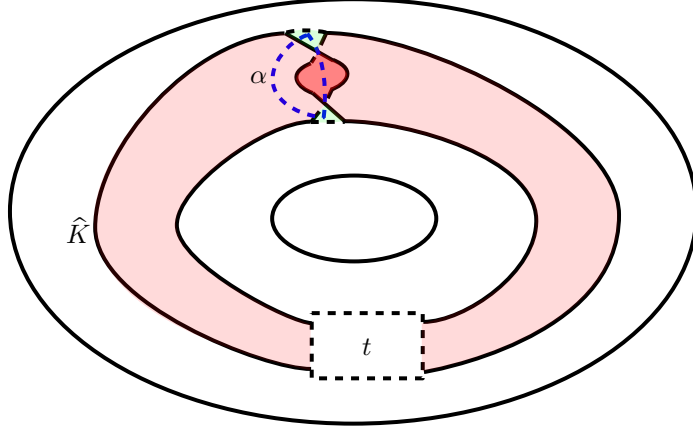

FIGURE 9. A genus-one Seifert surface S of \widehat{K} . Two sides of the Seifert surface are shaded in red and green. The blue curve α is curve on S bounding a disk in $\widehat{V} \setminus S$. This disk can be viewed as a product disk in the sutured manifold $(S^3 \setminus [-1, 1] \times S, \{0\} \times \partial S)$.

Lemma 7.5. *Suppose K is the positively clasped t -twist Whitehead double of J . Then*

$$\tau_I(K) = \begin{cases} 1 & t < 2 \cdot \tau_I(J) \\ 0 & t \geq 2 \cdot \tau_I(J) \end{cases}$$

Proof. Write $(K_t^+, \Gamma_n) = \underline{\text{SHI}}(-S^3(K_t^+), -\Gamma_n)$, and $(K_t^+, \Gamma_n, i) = \underline{\text{SHI}}(-S^3(K_t^+), -\Gamma_n, i)$. We take the surgery exact triangle along the curve δ . The maps in the surgery triangle associated to δ commutes with the 2-handle attachments along the meridian of the knots, so we have the following diagram, for which the triangles are exact and the parallelograms are commutative.

$$(7.1) \quad \begin{array}{ccccc} (D_{t+1}^+(J), \Gamma_n) & \xrightarrow{H_{\delta, n}} & (D_t^+(J), \Gamma_n) & & \\ \downarrow F_{t+1, n} & \swarrow G_{\delta, n} & \nwarrow F_{\delta, n} & & \downarrow F_{t, n} \\ & (K^+, \Gamma_n) & & & \\ \downarrow F_{t+1, n} & \swarrow G_{\delta} & \nwarrow F_{\delta} & & \downarrow F_{t, n} \\ I^{\#}(-S^3) & \xrightarrow{H_{\delta}} & I^{\#}(-S^3) & \xrightarrow{F_{\times, n}} & I^{\#}(-S^3) \\ & \swarrow G_{\delta} & \downarrow & \nwarrow F_{\delta} & \\ & & I^{\#}(-S^1 \times S^2) & & \end{array}$$

Note the above diagram works for any $n \in \mathbb{Z}$, but we fix a large enough $n \in \mathbb{Z}$. Here $K^+ \subset S^1 \times S^2$ is obtained from $D_t^+(J)$ by performing a 0-surgery along δ . Note $g(K^+) = 1$. Also, the knots $D_t^+(J)$ depends on the companion knot J , yet due to the 3-dimensional light bulb theorem we

know that K^+ is independent of the companion knot J . As a result, we can assume $J = U$ is the unknot to obtain information of J . When $J = U$, we know $D_0^+(U)$ is the unknot and $D_{-1}^+(U)$ is the right-handed trefoil. As a result, we know from Lemma 6.17 and Lemma 6.18 that

$$\tau_{\alpha_1}(K^+) = 1, \text{ and } \tau_{\alpha_2}(K^+) = 0.$$

Note we also know from [GLW19, Section 6] that

$$(D_0^+(U), \Gamma_n, 1) = 0 \text{ and } (D_{-1}^+(U), \Gamma_n, 1) \cong \mathbb{C}.$$

As a result, we know from the exactness that $(K^+, \Gamma_n, 1) \cong \mathbb{C}$. Also, from Lemma 2.28 part (2), we know

$$(7.2) \quad \dim(J, \Gamma_n) = \dim(J, \Gamma_{-2\tau_I(J)}) + |n + 2 \cdot \tau_I(J)|.$$

As a result, when $t < 2\tau_I(J)$, we know from Lemma 7.4 and Lemma 2.4 that

$$\dim(D_{t+1}^+(J), \Gamma_n, 1) = \dim(D_{t+1}^+(J), \Gamma_\mu, 1) = \dim(D_t^+(J), \Gamma_\mu, 1) - 1 = \dim(D_t^+(J), \Gamma_n, 1) - 1.$$

Hence $F_{\delta, n}$ restricted to $(D_t^+(J), \Gamma_n, 1)$ is nontrivial. Since $\tau_{\alpha_1}(K^+) = 1$ (*c.f.* Section 6.2) and F_δ is injective, we know that

$$F_{t, n}|_{(D_{t+1}^+(J), \Gamma_n, 1)} \neq 0$$

which implies that $\tau_I(D_{t+1}^+(J)) = 1$.

When $t \geq 2\tau_I(J)$, we know similarly that

$$\dim(D_{t+1}^+(J), \Gamma_n, 1) = \dim(D_t^+(J), \Gamma_n, 1) + 1,$$

so $F_{\delta, n}$ restricted to $(D_t^+(J), \Gamma_n, 1)$ is trivial and the injectivity of F_δ implies that

$$F_{t, n}|_{(D_{t+1}^+(J), \Gamma_n, 1)} = 0$$

which means $\tau_I(D_{t+1}^+(J)) < 1$. To further settle down the τ_I , we can look at the mirrors of such knots. Taking the mirror corresponding to reversing the orientation of the 3-manifold so we have a different diagram

$$(7.3) \quad \begin{array}{ccccc} \overline{(D_t^+(J), \Gamma_n)} & \xrightarrow{\overline{H}_{\delta, n}} & \overline{(D_{t+1}^+(J), \Gamma_n)} & & \\ \downarrow \overline{F}_{t, n} & \swarrow \overline{G}_{\delta, n} & \swarrow \overline{F}_{\delta, n} & & \downarrow \overline{F}_{t+1, n} \\ & (\overline{K}^+, \Gamma_n) & & & \\ & \downarrow \overline{F}_{\times, n} & & & \\ I^\sharp(-S^3) & \xrightarrow{H_\delta} & I^\sharp(-S^3) & & \\ & \swarrow G_\delta & \swarrow F_\delta & & \\ & I^\sharp(-S^1 \times S^2) & & & \end{array}$$

As above, we can use the case $J = U$ and $t = -1$ to compute that

$$\tau_{\alpha_1}(K^+) = 0, \text{ and } \tau_{\alpha_2}(K^+) = -1.$$

As a result we have $\overline{F}_{\times, n} \circ \overline{F}_{\delta, n}$ is trivial and the injectivity of \overline{F}_δ implies that

$$\overline{F}_{t, n}|_{\overline{(D_{t+1}^+(J), \Gamma_n, 1)}} = 0,$$

which means $\tau_I(\overline{D_{t+1}^+(J)}) < 1$ for any $t \in \mathbb{Z}$. In particular, for $t \geq 2 \cdot \tau_I(J)$, we must have $\tau_I(D_{t+1}^+(J)) = 0$. \square

Remark 7.6. Lemma 7.5 answers [BS21, Question 1.25] affirmatively.

Proof of Theorem 1.7. Part (1) and part (2) are Lemma 7.4 and Lemma 7.5. Part (3) follows from Lemma 7.3, Lemma 7.5, and Corollary 8.4. \square

Proof of Theorem 1.9. Let K be the positively clasped 0-twist Whitehead double of J . Let $L \subset \partial \widehat{V}$ be a meridian of \widehat{V} as in Figure 10. The knot $S_{-\frac{1}{n}}^3(K)$ can be viewed as the splicing of the complements of the knot $J \subset S^3$ and the knot $L \subset S_{-\frac{1}{n}}^3(\widehat{K})$. It is well-known that the two components of the Whitehead link can be swapped so $S_{-\frac{1}{n}}^3(\widehat{K})$ is still S^3 , while the knot $L \subset S_{-\frac{1}{n}}^3(\widehat{K})$ becomes the knot K_n . Theorem 1.7 part (3) applies to compute the (± 1) -surgeries of the knot K . Then we can apply [BS21, Theorem 1.1] after knowing (± 1) -surgeries. \square

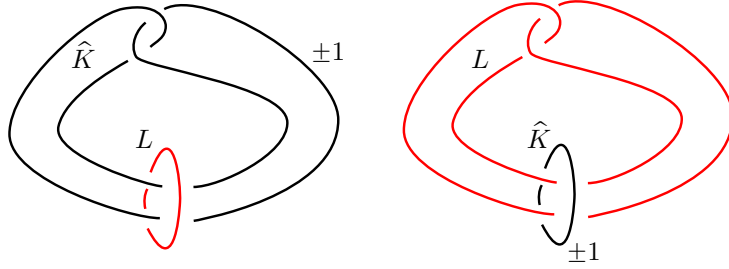

FIGURE 10. The two components of a Whitehead double link can be swapped.

8. ALMOST L-SPACE KNOTS

In this section, we study almost L -space knots; see (1.2) for the definition. We adopt the following notations from [LY21c, Definition 5.2]: Let $K \subset S^3$ be a knot (so that $(p, q) = (1, 0)$). Define

$$T_{n,i} = (\Gamma_n, i + \frac{n-1}{2}) \text{ and } B_{n,i} = (\Gamma_n, i - \frac{n-1}{2}).$$

By Lemma 2.19 part (2), we know that when $n \geq 2g(K) + 1$,

$$T_{n,i} \cong T_{n+1,i} \text{ and } B_{n,i} \cong B_{n+1,i}.$$

We can rewrite the bypass exact triangles in Lemma 2.8 using $T_{n,i}$ and $B_{n,i}$ as follows.

Lemma 8.1. *Adopting the notations as above, we have the following two bypass exact triangles:*

$$\begin{array}{ccc} (\Gamma_{\frac{2n-1}{2}}, i) & \xrightarrow{\psi_{+,n}^{\frac{2n-1}{2}}} & T_{n,i} \\ & \swarrow \psi_{+, \frac{2n-1}{2}}^{n-1} & \searrow \psi_{+,n-1}^n \\ & B_{n-1,i-1} & \end{array} \quad \begin{array}{ccc} (\Gamma_{\frac{2n-1}{2}}, i) & \xrightarrow{\psi_{-,n}^{\frac{2n-1}{2}}} & B_{n,i} \\ & \swarrow \psi_{-, \frac{2n-1}{2}}^{n-1} & \searrow \psi_{-,n-1}^n \\ & T_{n-1,i+1} & \end{array}$$

Furthermore, we have the following.

(1) ([LY22a, Theorem 1.12] or from the large surgery formula) When $n \geq 2g(K) + 1$, we have

$$I^\sharp(-S_{-n}^3(K)) \cong \bigoplus_{|i| \leq g(K)} (\mathbf{\Gamma}_{\frac{2n-1}{2}}, i) \oplus \mathbb{C}^{n-2g-1}.$$

(2) ([LY21c, Proposition 5.5]) We have

$$\psi_{+,n-2}^{n-1} \circ \psi_{-,n-1}^n = \psi_{-,n-2}^{n-1} \circ \psi_{+,n-1}^n = 0.$$

Theorem 8.2. Suppose $K \subset S^3$ is an almost L-space knot. Then we have the following.

(1) If $g(K) \geq 2$, then $\dim \underline{\text{KHI}}(S^3, K, i) \leq 1$ for any $i \in \mathbb{Z}$ such that $|i| > 1$. Furthermore, the knot K is fibered and strongly quasi-positive.

(2) If $g(K) = 1$, then either K is the figure-eight or $\tau_I(K) = 1$ and

$$\underline{\text{KHI}}(S^3, K, i) \cong \begin{cases} 0 & |i| > 1 \\ \mathbb{C}^2 & |i| = 1 \\ \mathbb{C} \text{ or } \mathbb{C}^3 & i = 0 \end{cases}$$

(3) If $g(K) = 2$, then

$$\underline{\text{KHI}}(S^3, K, i) \cong \begin{cases} 0 & |i| > 2 \\ \mathbb{C} & |i| = 2 \\ \mathbb{C} \text{ or } \mathbb{C}^2 & |i| = 1 \\ \mathbb{C} \text{ or } \mathbb{C}^3 & i = 0 \end{cases}$$

Proof. Suppose $n \in \mathbb{N}_+$ so that $\dim I^\sharp(S_n^3(K)) = n$. From [BS21, Section 2.2], we have the following exact triangle

$$\begin{array}{ccc} I^\sharp(S_n^3(K)) & \longrightarrow & I^\sharp(S_{n+1}^3(K)) \\ & \searrow & \swarrow \\ & I^\sharp(S^3) & \end{array}$$

From the fact that $I^\sharp(S^3) \cong \mathbb{C}$, we know either $\dim I^\sharp(S_{n+1}^3(K)) = n + 1$, which implies that K is an instanton L-space knot and hence a contradiction, or $\dim I^\sharp(S_{n+1}^3(K)) = n + 3$. Hence, by induction we can assume that $n \geq 2g + 1$. Suppose \bar{K} is the mirror of K . We have $I^\sharp(-S_{-n}^3(\bar{K})) \cong I^\sharp(S_n^3(K))$. From now on, all sutured instanton homologies are for the mirror knot. Applying Lemma 8.1, we know that

$$\bigoplus_{|i| \leq g} (\mathbf{\Gamma}_{\frac{2n-1}{2}}, i) \cong \mathbb{C}^{2g+3}.$$

From Lemma 2.28 part (1), we know that

$$(\mathbf{\Gamma}_{\frac{2n-1}{2}}, i) \cong (\mathbf{\Gamma}_{\frac{2n-1}{2}}, -i).$$

From [LY21b, Proposition 1.21], we know that

$$\chi(\dim(\mathbf{\Gamma}_{\frac{2n-1}{2}}, i)) = \chi(I^\sharp(-S^3)) = 1.$$

As a result, we conclude that

$$(\mathbf{\Gamma}_{\frac{2n-1}{2}}, i) \cong \mathbb{C} \text{ when } 0 < |i| \leq g \text{ and } (\mathbf{\Gamma}_{\frac{2n-1}{2}}, 0) \cong \mathbb{C}^3.$$

When $g(K) \geq 2$, the argument for fact that $\dim \underline{\text{KHI}}(-S^3, \bar{K}, i) \leq 1$ in the proof of [LY21c, Theorem 5.14] applies verbatim for $|i| > 1$. In particular, for $i = g$, we can apply [LY21c, Lemma 5.7] (with $m = g$) to conclude that (for the knot \bar{K}) $B_{n, g-1} = 0$. By Lemma 2.28 part (1), we know that

$$(\mathbf{\Gamma}_n, 1 - g + \frac{n-1}{2}) \cong (\mathbf{\Gamma}_n, g - 1 - \frac{n-1}{2}) = B_{n, g-1} = 0.$$

From [Li19, Section 5], we know that

$$\underline{\text{KHI}}(-S^3, \bar{K}, 1 - g) \cong (\mathbf{\Gamma}_n, 1 - g + \frac{n-1}{2}) = 0,$$

which, implies that $\tau_I(\bar{K}) = -g$ as in Definition 2.26. By Lemma 2.27, we know $\tau_I(K) = g$.

From [KM11b, Proposition 7.16] and [KM10a, Proposition 4.1], the fact that

$$\dim \underline{\text{KHI}}(-S^3, \bar{K}, g(K)) \leq 1$$

implies K is fibered. The fibration gives rise to a partial open book decomposition and hence a contact structure ξ on S^3 . Note K is strongly quasi-positive if and only if ξ is tight on S^3 . We can perturb K so that K is Legendrian in (S^3, ξ) and, furthermore, the knot complement $S^3 \setminus N(K)$ is obtained by removing a standard tight contact neighborhood of K from S^3 . Let ξ' be the restriction of ξ on $S^3 \setminus N(K)$. Hence $\partial(S^3 \setminus N(K))$ is convex with dividing set described by the suture Γ_m for some integer $m \in \mathbb{Z}$. We can perform suitable stabilizations to make $m \geq 2g(K) + 1$. In [BS16a], Baldwin-Sivek defined a contact invariant $\theta(\xi') \in \mathbf{\Gamma}_m$. By the proof of [BS22c, Theorem 1.17] and (the conclusion of) [BS22c, Theorem 1.18], we know that

$$\theta(\xi') \neq 0 \in (\mathbf{\Gamma}_m, g) \cong \mathbb{C}.$$

We can attach a contact 2-handle along the meridian of K to (S^3, Γ_m) so that the sutured manifold becomes $S^3(1)$, which is a 3-ball with a connected simple closed curve as the suture. After gluing, the contact structure ξ' on $(S^3 \setminus N(K), \Gamma_m)$ becomes the restriction of ξ on $S^3(1)$. So by [BS16a, Theorem 1.2], we have

$$F_m(\theta(\xi')) = \theta(\xi|_{S^3(1)}) \in \underline{\text{SHI}}(-S^3(1)) = I^\#(-S^3).$$

where F_m is the map associated to the contact 2-handle attachment. Note by [GLW19, Proposition 3.17] and the fact that $\tau_I(K) = g$, we know that

$$\theta(\xi|_{S^3(1)}) \neq 0$$

which implies that ξ is tight on S^3 by [BS16a, Theorem 1.3]. Hence we conclude that K is strongly quasi-positive.

To prove the arguments when $g(K) \leq 2$, we need to un-package the proof of [LY21c, Lemma 5.7 and Lemma 5.8]. First, assume $g(K) = 1$. From above discussions, we can pick $n \geq 6$ and have

$$(\mathbf{\Gamma}_{\frac{2n-1}{2}}, i) \cong (\mathbf{\Gamma}_{\frac{2n-3}{2}}, i) \cong (\mathbf{\Gamma}_{\frac{2n-5}{2}}, i) \cong \begin{cases} \mathbb{C} & |i| = 1 \\ \mathbb{C}^3 & i = 0. \end{cases}$$

From Lemma 2.4 and the definition of T_n , we know that

$$T_{n,1} = (\mathbf{\Gamma}_n, 1 + \frac{n-1}{2}) \cong \underline{\text{KHI}}(-S^3, \bar{K}, 1).$$

Assume $T_{n,1} \cong \underline{\text{KHI}}(-S^3, \bar{K}, 1) \cong \mathbb{C}^k$. Lemma 8.1 leads to the following diagram where the vertical and horizontal sequences are exact:

$$\begin{array}{ccccc}
& & (\mathbf{\Gamma}_{\frac{2n-1}{2}}, 1) \cong \mathbb{C} & & \\
& & \downarrow & & \\
& & T_{n,1} \cong \mathbb{C}^k & & \\
& & \downarrow \psi_{-,n-1}^{n,1} & & \\
(\mathbf{\Gamma}_{\frac{2n-3}{2}}, 0) \cong \mathbb{C}^3 & \xrightarrow{\psi_{+,n-1}^{2n-3,0}} & B_{n-1,0} & \xrightarrow{\psi_{+,n-2}^{n-1,0}} & T_{n-2,1} \cong \mathbb{C}^k
\end{array}$$

where the second superscript of the bypass map indicates the grading. Note since $(\mathbf{\Gamma}_{\frac{2n-1}{2}}, 1) \cong \mathbb{C}$, the map $\psi_{-,n-1}^{n,1}$ is either injective or surjective.

Genus 1, case 1 $\psi_{-,n-1}^{n,1}$ is surjective. Then by the exactness $B_{n-1,0} \cong \mathbb{C}^{k-1}$. From Lemma 8.1 part (3), we know that $\psi_{+,n-2}^{n-1,0} = 0$ so from the exactness we know that $3 = k - 1 + k$, which means $k = 2$. Thus, we know that $\underline{\text{KHI}}(-S^3, \bar{K}, \pm 1) \cong \mathbb{C}^k = \mathbb{C}^2$. Applying Lemma 2.4, we know that

$$\dim \underline{\text{KHI}}(-S^3, \bar{K}, 0) \leq \dim(\mathbf{\Gamma}_n, 1 + \frac{n-1}{2}) + \dim(\mathbf{\Gamma}_{n-1}, 0 + \frac{n-2}{2}).$$

From the definitions of $T_{n,i}$ and $B_{n,i}$ and Lemma 2.28, we know that

$$\dim(\mathbf{\Gamma}_n, 1 + \frac{n-1}{2}) = \dim T_{n,1} = k = 2, \text{ and}$$

$$\dim(\mathbf{\Gamma}_{n-1}, 0 + \frac{n-2}{2}) = \dim(\mathbf{\Gamma}_{n-1}, -\frac{n-2}{2}) = \dim B_{n-1,0} = k - 1 = 1.$$

Hence $\dim \underline{\text{KHI}}(-S^3, \bar{K}, 0) \leq 3$. From the Euler characteristic result in [KM10a, Theorem 1.1], we know that $\dim \underline{\text{KHI}}(-S^3, \bar{K}, 0)$ is odd, so it must be either 1 or 3.

It remains to show that $\tau_I(K) = 1$ for all such knots. By [Li19, Section 5], if $n \geq 3$ then

$$\underline{\text{KHI}}(-S^3, \bar{K}, 0) \cong (\mathbf{\Gamma}_n, 0 + \frac{n-1}{2}) \cong \mathbb{C}^{k-1}(\mathbf{\Gamma}_n, -1 + \frac{n-1}{2}) \cong \mathbb{C}.$$

Note the last isomorphism follows from Lemma 2.19. Also, there is an exact triangle by Lemma 6.2 part (2).

$$\begin{array}{ccc}
\underline{\text{KHI}}(-S^3, \bar{K}, 0) & \xrightarrow{U} & \underline{\text{KHI}}(-S^3, \bar{K}, -1) \\
& \swarrow & \searrow \\
& \underline{\text{KHI}}(-S^3, \bar{K}, -1) \cong \mathbb{C}^2 &
\end{array}$$

Hence we know

$$U|_{\underline{\text{KHI}}(-S^3, \bar{K}, 0)} = 0.$$

and hence by the definition of τ_I and Lemma 2.27 we know $\tau_I(K) = -\tau_I(\bar{K}) = 1$.

Genus 1, case 2 $\psi_{-,n-1}^{n,1}$ is injective. Then by the exactness $B_{n-1,0} \cong \mathbb{C}^{k+1}$. Lemma 8.1 implies another exact triangle

$$\begin{array}{ccccc}
 & & & & (\mathbf{\Gamma}_{\frac{2n-5}{2}}, 1) \cong \mathbb{C} \\
 & & & & \downarrow \\
 B_{n-1,0} \cong \mathbb{C}^{k+1} & \xrightarrow{\psi_{+,n-2}^{n-1,0}} & T_{n-2,1} \cong \mathbb{C}^k & \longrightarrow & (\mathbf{\Gamma}_{\frac{2n-3}{2}}, 0) \cong \mathbb{C}^3 \\
 & & & & \downarrow \psi_{-,n-3}^{n-2,1} \\
 & & & & B_{n-3,0} \cong \mathbb{C}^{k+1}
 \end{array}$$

The vertical exactness implies that $\psi_{-,n-3}^{n-2,1}$ is injective and hence from Lemma 8.1 part (3), we know that $\psi_{+,n-2}^{n-1,0}$ is zero. Hence from the horizontal exactness we know $k+1+k=3$, which means $k=1$.

From [KM10a, Proposition 4.1] we know K is fibered. It is well-known that there are only two genus-one fibered knots in S^3 , namely the trefoil and the figure-eight, among which the trefoil is an L-space knot. Hence K is the figure-eight.

Finally we study the case of $g(K) = 2$. First, as in the proof of part (1), since $\underline{\text{KHI}}(-S^3, \bar{K}, 2) \neq 0$, we can apply [LY21c, Lemma 5.7] directly with $m = 2$ and conclude that for $n \geq 9$, we have $\underline{\text{KHI}}(-S^3, \bar{K}, 2) \cong T_{n,2} \cong \mathbb{C}$ and $B_{n-1,1} = 0$. Note we have

$$(\mathbf{\Gamma}_{n+1}, -1 + \frac{n-1}{2}) \cong B_{n+1,1} \cong B_{n-1,1} = 0.$$

and hence from Lemma 2.4 and Lemma 2.28 we know

$$\underline{\text{KHI}}(-S^3, \bar{K}, -1) = (\mathbf{\Gamma}_\mu, -1) \cong (\mathbf{\Gamma}_n, 0 + \frac{n-1}{2}) \cong (\mathbf{\Gamma}_n, 0 - \frac{n-1}{2}) = B_{n,0} \cong B_{n-1,0}.$$

Then the argument above for genus-one almost L-space knots applies verbatim and we can conclude the following two cases:

Genus 2, case 1 $T_{n,1} \cong \mathbb{C}$ and $B_{n-1,0} \cong \mathbb{C}^2$.

Genus 2, case 2 $T_{n,1} \cong \mathbb{C}^2$ and $B_{n-1,0} \cong \mathbb{C}$. Note in both cases from Lemma 2.4 and Lemma 2.28 we know that

$$\begin{aligned}
 \dim \underline{\text{KHI}}(-S^3, \bar{K}, 0) &\leq \dim(\mathbf{\Gamma}_n, 1 + \frac{n-1}{2}) + \dim(\mathbf{\Gamma}_{n+1}, 0 + \frac{n}{2}) \\
 &= \dim T_{n,1} + \dim(\mathbf{\Gamma}_{n+1}, 0 - \frac{n}{2}) \\
 &= \dim T_{n,1} + \dim B_{n+1,0} \\
 &= \dim T_{n,1} + \dim B_{n-1,0} \\
 &= 3.
 \end{aligned}$$

Hence we conclude the proof of part (3). \square

Remark 8.3. For genus-two almost L-space knots, we know

$$\dim \underline{\text{KHI}}(S^3, K, 2) = 1 \text{ and } \dim \underline{\text{KHI}}(S^3, K, 1) = 1 \text{ or } 2.$$

Recent techniques developed in [BHS21, BLSY21] can show that $\dim \underline{\text{KHI}}(S^3, K, 2) = 1$ implies that $K = T_{2,\pm 5}$, while the case $\dim \underline{\text{KHI}}(S^3, K, 1) = 2$ is still open.

The techniques in proving the above lemma can also lead to the following.

Corollary 8.4. *Suppose K is a genus-one knot so that $I^\sharp(S_1^3(K)) = 2d + 1$, then either*

- (1) $\dim \underline{\text{KHI}}(S^3, K, 1) = d + 1$ and $\tau_I(K) = 1$, or
- (2) $\dim \underline{\text{KHI}}(S^3, K, 1) = d$ and $\tau_I(K) \leq 0$.

Proof. Note $g(K) = 1$ so by [BS21, Section 1.1 and Theorem 1.1], we know that $\dim I^\sharp(S_3^3(K)) = 2d + 3$. From Lemma 8.1 we know that if $n \geq 7$,

$$\dim \bigoplus_{-1 \leq i \leq 1} (\Gamma_{\frac{2n-1}{2}}, i) = 2d + 3.$$

Lemma 8.1 implies a triangle

$$\begin{array}{ccc} (\Gamma_{\frac{2n-1}{2}}, 1) & \xrightarrow{\quad\quad\quad} & (\Gamma_n, 2 + \frac{n-1}{2}) \\ & \searrow \quad \quad \quad \swarrow & \\ & (\Gamma_{n-1}, 1 - \frac{n-2}{2}) & \end{array}$$

From Lemma 2.19 with $Y = S^3$, we know that

$$(\Gamma_n, 2 + \frac{n-1}{2}) = 0 \text{ and } (\Gamma_{n-1}, 1 - \frac{n-2}{2}) \cong \mathbb{C}$$

so we conclude that

$$\dim(\Gamma_{\frac{2n-1}{2}}, 1) = \dim(\Gamma_{\frac{2n-1}{2}}, -1) = 1.$$

As a result, we have

$$\dim(\Gamma_{\frac{2n-1}{2}}, 0) = 2d + 1.$$

The argument in the proof of Theorem 8.2 for the case $g = 1$ applies. The original setup $\dim(\Gamma_{\frac{2n-1}{2}}, 0) \cong \mathbb{C}^3$ is the case $d = 1$. So as in that proof, we have two cases

Case 1. $\underline{\text{KHI}}(-S^3, \bar{K}, 1) \cong T_{n,1} \cong \mathbb{C}^{d+1}$, $B_{n-1,0} \cong \mathbb{C}^d$, and $\tau_I(K) = 1$.

Case 2. $\underline{\text{KHI}}(-S^3, \bar{K}, 1) \cong T_{n,1} \cong \mathbb{C}^d$, $B_{n-1,0} \cong \mathbb{C}^{d+1}$. As in the proof of Theorem 8.2, we know

$$\underline{\text{KHI}}(-S^3, \bar{K}, 0) \cong (\Gamma_{n-1}, 0 + \frac{n-1}{2}) \cong B_{n-1,0} \cong \mathbb{C}^{d+1}$$

and

$$\underline{\text{KHI}}(-S^3, \bar{K}, -1) \cong (\Gamma_{n-1}, -1 + \frac{n-1}{2}) \cong \mathbb{C}.$$

From the exact triangle in Lemma 6.2 part (2)

$$\begin{array}{ccc} \underline{\text{KHI}}(-S^3, \bar{K}, 0) \cong \mathbb{C}^{d+1} & \xrightarrow{\quad U \quad} & \underline{\text{KHI}}(-S^3, \bar{K}, -1) \cong \mathbb{C} \\ & \searrow \quad \quad \quad \swarrow & \\ & \underline{\text{KHI}}(-S^3, \bar{K}, -1) \cong \mathbb{C}^d & \end{array}$$

the map $U : \underline{\text{KHI}}(-S^3, \bar{K}, 0) \rightarrow \underline{\text{KHI}}(-S^3, \bar{K}, -1)$ is surjective and hence $\tau_I(\bar{K}) \geq 0$ which implies that $\tau_I(K) \leq 0$. \square

Corollary 8.5. *Suppose $K \subset S^3$ is a knot with $g(K) \geq 2$. Then*

$$\dim I^\sharp(S_1^3(K)) \geq 5.$$

Proof. Suppose the contrary, that $\dim I^\sharp(S_1^3(K)) \leq 3$. Then there are two cases: K is either an instanton L-space knot or an almost L-space knot. If K is an instanton L-space knot we can apply the main result in [LPCS20] (or [LY21c]) and conclude that $\dim I^\sharp(S_1^3(K)) \geq 5$ directly. If K is an almost L-space then from Theorem 8.2 and [GLW19, Theorem 1.2], we know that the invariant $\nu^\sharp(K)$ in [BS21] satisfies

$$\nu^\sharp(K) \geq 2\tau^\sharp(K) - 1 = 2\tau_I(K) - 1 = 2g(K) - 1 \geq 3.$$

Then from [BS21, Theorem 1.1] we know that $\dim I^\sharp(S_1^3(K)) \geq 5$. \square

Corollary 8.6. *Suppose $K = 15n_{43522}$, then we have $\tau_I(K) = 0$ and*

$$\underline{\text{KHI}}(S^3, K, i) \cong \begin{cases} 0 & |i| > 1 \\ \mathbb{C}^2 & |i| = 1 \\ \mathbb{C}^5 & |i| = 0 \end{cases}$$

Proof. From [BS22b], we know that $g(K) = 1$, $\Delta_K(t) = 2t - 3 + 2t^{-1}$, and $\dim_{\mathbb{Q}} \widehat{HFK}(S^3, K, 1) = 2$. From [LY22c, Corollary 1.4], we know that $\dim \underline{\text{KHI}}(S^3, K, 1) = 2$. From the Euler characteristic result in [KM10a, Theorem 1.1], we know that $\dim \underline{\text{KHI}}(S^3, K, 1)$ is either 3 or 5. If it is 3-dimensional, from [LY21c, Proposition 6.8], we know that either

$$\dim I^\sharp(S_1^3(K)) = 3 \text{ or } \dim I^\sharp(S_{-1}^3(K)) = 3.$$

However this contradicts Corollary 8.5 and the facts that

$$S_1^3(K) \cong \pm S_{-1}^3(9_{42}) \text{ and } S_{-1}^3(K) \cong \pm S_{-1}^3(8_{20})$$

as in the proof of [BS22b, Proposition A1]. As a result, we must have

$$\dim \underline{\text{KHI}}(S^3, K, 1) = 5.$$

\square

Proof of Theorem 1.13. We know from [LY22c, BS22b] that up to mirror K must be one in the following list:

$$5_2, D_2^\pm(J), 15n_{43522}, P(-3, 3, 2n+1).$$

Since $K = 5_2$ is an alternating knot it follows from [KM11a] that

$$\dim KHI(S^3, K) = \|\Delta_K(t)\| = 7.$$

For $K = D_2^+(J)$ or $P(-3, 3, 2n+1)$, we know that

$$\Delta_K(t) = -2t + 5 - 2t^{-1}.$$

From [KM10a, Theorem 1.1] we know that

$$\dim KHI(S^3, K, 0) \geq 5.$$

From the proof of [LY21c, Proposition 6.3], we know that

$$\dim KHI(S^3, K, 0) \leq 5.$$

As a result, we have

$$\dim KHI(S^3, K, 0) = 5.$$

For $K = D_2^-(J)$ or $15n_{43522}$, we know that

$$\Delta_K(t) = 2t - 3 + 2t^{-1}.$$

From the above argument we know that

$$\dim KHI(S^3, K, 0) = 3 \text{ or } 5.$$

If $\dim KHI(S^3, K, 0) = 3$ then [LY21c, Proposition 6.8] and Corollary 8.4 imply that

$$\tau_I(K) = \pm 1$$

which contradicts Corollary 8.6 and Lemma 7.5. \square

Proof of Theorem 1.11. Part (1) follows from Theorem 8.2. We prove part (2) as follows. From Theorem 8.2 part (2), when K is a genus-one almost L-space knot, we have either $\underline{KHI}(S^3, K, 1) \cong \mathbb{C}$ so that K is the figure eight, or $\underline{KHI}(S^3, K, 1) \cong \mathbb{C}^2$. In the latter case, we know from Theorem 1.13 that $K = \bar{5}_2$, is indeed an almost L-space knot again by [LY21c, Theorem 1.20]. \square

Proof of Corollary 1.12. If $\dim I^\sharp(S_1^3(K)) = 3$, we know that either K is an L-space knot or an almost L-space knot. From Corollary 8.5 we know that $g(K) = 1$. Then the corollary follows from Theorem 1.11 part (2). \square

REFERENCES

- [ABDS20] Antonio Alfieri, John A. Baldwin, Irving Dai, and Steven Sivek. Instanton Floer homology of almost-rational plumbings. *ArXiv: 2010.03800, v1*, 2020.
- [BHS21] John A. Baldwin, Ying Hu, and Steven Sivek. Khovanov homology and the cinquefoil. *ArXiv:2105.12102, v1*, 2021.
- [BLSY21] John A. Baldwin, Zhenkun Li, Steven Sivek, and Fan Ye. Small Dehn surgery and $SU(2)$. *ArXiv:2110.02874, v1*, 2021.
- [BS15] John A. Baldwin and Steven Sivek. Naturality in sutured monopole and instanton homology. *J. Differ. Geom.*, 100(3):395–480, 2015.
- [BS16a] John A. Baldwin and Steven Sivek. A contact invariant in sutured monopole homology. *Forum Math. Sigma*, 4:e12, 82, 2016.
- [BS16b] John A. Baldwin and Steven Sivek. Instanton Floer homology and contact structures. *Selecta Math. (N.S.)*, 22(2):939–978, 2016.
- [BS19] John A. Baldwin and Steven Sivek. Instanton and L-space surgeries. *ArXiv:1910.13374, v1*, 2019.
- [BS21] John A. Baldwin and Steven Sivek. Framed instanton homology and concordance. *J. Topol.*, 14(4):1113–1175, 2021.
- [BS22a] John A. Baldwin and Steven Sivek. Characterizing slopes for $\bar{5}_2$. *ArXiv:2209.09805, v1*, 2022.
- [BS22b] John A. Baldwin and Steven Sivek. Floer homology and non-fibered knot detection. *ArXiv:2208.03307, v1*, 2022.
- [BS22c] John A. Baldwin and Steven Sivek. Khovanov homology detects the trefoils. *Duke Math. J.*, 174(4):885–956, 2022.
- [GL19] Sudipta Ghosh and Zhenkun Li. Decomposing sutured monopole and instanton Floer homologies. *ArXiv:1910.10842, v2*, 2019.
- [GLW19] Sudipta Ghosh, Zhenkun Li, and C.-M. Michael Wong. Tau invariants in monopole and instanton theories. *ArXiv:1910.01758, v3*, 2019.
- [GLY] Sudipta Ghosh, Zhenkun Li, and Fan Ye. A connected sum formula for bent complexes in instanton theory. In preparation.

- [Han20] Jonathan Hanselman. Heegaard Floer homology and cosmetic surgeries in S^3 . *ArXiv:1906.06773*, v2, 2020.
- [Hed07] Matthew Hedden. Knot Floer homology of Whitehead doubles. *Geom. Topol.*, 11(4):2277–2338, 2007.
- [Juh06] András Juhász. Holomorphic discs and sutured manifolds. *Algebr. Geom. Topol.*, 6:1429–1457, 2006.
- [KM10a] Peter B. Kronheimer and Tomasz S. Mrowka. Instanton Floer homology and the Alexander polynomial. *Algebr. Geom. Topol.*, 10(3):1715–1738, 2010.
- [KM10b] Peter B. Kronheimer and Tomasz S. Mrowka. Knots, sutures, and excision. *J. Differ. Geom.*, 84(2):301–364, 2010.
- [KM11a] Peter B. Kronheimer and Tomasz S. Mrowka. Khovanov homology is an unknot-detector. *Publ. Math. Inst. Hautes Études Sci.*, 113:97–208, 2011.
- [KM11b] Peter B. Kronheimer and Tomasz S. Mrowka. Knot homology groups from instantons. *J. Topol.*, 4(4):835–918, 2011.
- [Li18a] Zhenkun Li. Contact structures, excisions, and sutured monopole Floer homology. *ArXiv:1811.11634*, 2018.
- [Li18b] Zhenkun Li. Gluing maps and cobordism maps for sutured monopole Floer homology. *ArXiv:1810.13071*, v3, 2018.
- [Li19] Zhenkun Li. Knot homologies in monopole and instanton theories via sutures. *ArXiv:1901.06679*, v6, 2019.
- [Lim10] Yuhan Lim. Instanton homology and the Alexander polynomial. *Proc. Amer. Math. Soc.*, 138(10):3759–3768, 2010.
- [LPCS20] Tye Lidman, Juanita Pinzón-Caicedo, and Christopher Scaduto. Framed instanton homology of surgeries on L-space knots. *ArXiv:2003.03329*, v1, 2020.
- [LY21a] Zhenkun Li and Fan Ye. An enhanced Euler characteristic of sutured instanton homology. *ArXiv:2107.10490*, v1, 2021.
- [LY21b] Zhenkun Li and Fan Ye. Instanton Floer homology, sutures, and Euler characteristics. *ArXiv:2011.09424*, v2, 2021.
- [LY21c] Zhenkun Li and Fan Ye. $SU(2)$ representations and a large surgery formula. *ArXiv:2107.11005*, v1, 2021.
- [LY22a] Zhenkun Li and Fan Ye. Instanton Floer homology, sutures, and Heegaard diagrams. *J. Topol.*, 15(1):39–107, 2022.
- [LY22b] Zhenkun Li and Fan Ye. Knot surgery formulae for instanton Floer homology I: the main theorem. *ArXiv:2206.10077*, v2, 2022.
- [LY22c] Zhenkun Li and Fan Ye. Seifert surface complements of nearly fibered knots. *ArXiv:2208.05382*, v1, 2022.
- [OS03] Peter S. Ozsváth and Zoltán Szabó. Heegaard Floer homology and alternating knots. *Geom. Topol.*, 7(1):225–254, 2003.
- [OS04] Peter S. Ozsváth and Zoltán Szabó. Holomorphic disks and knot invariants. *Adv. Math.*, 186(1):58–116, 2004.
- [OS08] Peter S. Ozsváth and Zoltán Szabó. Knot Floer homology and integer surgeries. *Algebr. Geom. Topol.*, 8(1):101–153, 2008.
- [OS11] Peter S. Ozsváth and Zoltán Szabó. Knot Floer homology and rational surgeries. *Algebr. Geom. Topol.*, 11(1):1–68, 2011.
- [Pet13] Ina Petkova. Cables of thin knots and bordered Heegaard Floer homology. *Quantum Topol.*, 4(4):377–409, 2013.

- [Sca15] Christopher Scaduto. Instantons and odd Khovanov homology. *J. Topol.*, 8(3):744–810, 2015.
- [XZ21] Yi Xie and Boyu Zhang. On meridian-traceless $SU(2)$ -representations of link groups. *arXiv:2104.04839, v2*, 2021.

DEPARTMENT OF MATHEMATICS, STANFORD UNIVERSITY
Email address: `zhenkun@stanford.edu`

DEPARTMENT OF MATHEMATICS, HARVARD UNIVERSITY
Email address: `fanye@math.harvard.edu`