

THE ARTIN COMPONENT AND SIMULTANEOUS RESOLUTION VIA RECONSTRUCTION ALGEBRAS OF TYPE A

BRIAN MAKONZI

ABSTRACT. This paper uses noncommutative resolutions of non-Gorenstein singularities to construct classical deformation spaces, by recovering the Artin component of the deformation space of a cyclic surface singularity using only the quiver of the corresponding reconstruction algebra. The relations of the reconstruction algebra are then deformed, and the deformed relations together with variation of the GIT quotient achieve the simultaneous resolution. This extends work of Brieskorn, Kronheimer, Grothendieck, Cassens–Slodowy and Crawley-Boevey–Holland into the setting of singularities \mathbb{C}^2/H with $H \leq \mathrm{GL}(2, \mathbb{C})$, and furthermore gives a prediction for what is true more generally.

1. INTRODUCTION

Noncommutative resolutions control many geometric processes, especially in dimension three and for Calabi–Yau (CY) geometry [V2][DW]. This paper restricts to dimension two, but considers the much more general setting of rational surface singularities. These need not be CY. In the case of cyclic quotients, it extracts from a noncommutative resolution, namely the reconstruction algebra, a classical invariant, called the Artin component. Furthermore, by introducing a deformed version of the reconstruction algebra, simultaneous resolution is achieved.

1.1. Motivation and Background. When $H \leq \mathrm{SL}(2, \mathbb{C})$, the quotient singularities \mathbb{C}^2/H are exactly the Kleinian singularities (equivalently, rational double points), and these all have embedding dimension $e=3$. Grothendieck and Brieskorn [B2] [B3] construct the deformation space for these singularities and relate it to the Weyl group W of the corresponding simple simply-connected complex Lie group. The versal deformation $D \rightarrow \mathfrak{h}_{\mathbb{C}}/W$ of a rational double point was constructed in [B3], and after base change via the action of the Weyl group as in the diagram below, the resulting space Art resolves simultaneously [B3].

$$\begin{array}{ccc} Art & \longrightarrow & D \\ \downarrow & & \downarrow \\ \mathfrak{h}_{\mathbb{C}} & \longrightarrow & \mathfrak{h}_{\mathbb{C}}/W \end{array}$$

Kronheimer [K] and Cassens–Slodowy [CS, §3] use the McKay quiver to construct the semiuniversal deformation of Kleinian singularities and their simultaneous resolutions, of type A_n , D_n , E_6 , E_7 and E_8 . This was later reinterpreted by Crawley-Boevey–Holland [CH] in terms of the deformed preprojective algebra.

The deformation theory of non-Gorenstein surface quotient singularities, namely those \mathbb{C}^2/H for small finite groups $H \leq \mathrm{GL}(2, \mathbb{C})$ that are not inside $\mathrm{SL}(2, \mathbb{C})$, is more complicated. Artin [A] constructed a particular component (the Artin component) which is irreducible and admits a simultaneous resolution, again after a finite base change by some appropriate Weyl group W .

$$\begin{array}{ccc} Art & \longrightarrow & D \\ \downarrow & & \downarrow \\ H_{\mathbb{C}}^1 & \longrightarrow & H_{\mathbb{C}}^1/W \end{array}$$

Riemenschneider [R1] computed the Artin component Art for cyclic quotient singularities, then later in [R4, §5] he used the McKay quiver and special representations as

described by Wunram [W2] to give an alternative description. The Artin component can be described as a factor of a polynomial ring $\mathbb{C}[z]$ with respect to some quasideterminantal relations $\text{QDet}(z)$, but Riemenschneider's method recovers this only after ignoring a very large number of variables. Simultaneous resolution is also not obtained using the McKay quiver perspective.

In this paper we use the reconstruction algebra of [W1], which is strictly smaller than the McKay quiver, to both construct the Artin component on the nose, and extract its simultaneous resolution.

1.2. Main Results. For any cyclic group $\frac{1}{r}(1, a)$, the quiver of the corresponding reconstruction algebra is recalled in §2.1, and will be written Q . With dimension vector $\delta = (1, \dots, 1)$, consider the co-ordinate ring of the representation variety $\mathbb{C}[\text{Rep}(\mathbb{C}Q, \delta)]$, which carries a natural action of $G := \prod_{q \in Q_0} \mathbb{C}^*$. As shown in §3.2, \mathcal{R}^G is generated by cycles. These generate a \mathbb{C} -algebra $\mathbb{C}[z]$, and they further satisfy quasideterminantal relations (recalled in §4.1) which we will denote $\text{QDet}(z)$. The following is our first main result.

Theorem 1.1 (4.29). *For any group $\frac{1}{r}(1, a)$, there is an isomorphism $\mathcal{R}^G \cong \frac{\mathbb{C}[z]}{\text{QDet}(z)}$.*

In particular \mathcal{R}^G , which is constructed using only the quiver of the reconstruction algebra, precisely gives the Artin component of $\frac{1}{r}(1, a)$. Since the reconstruction algebra exists for *any* rational surface singularity, this gives a prediction for what can be expected much more generally.

Simultaneous resolution is then achieved by introducing the deformed reconstruction algebra (see 5.1), which generalises the work of Crawley-Boevey–Holland [CH] on deformed preprojective algebras. In §5.3, we construct a map $\pi: \mathcal{R}^G \rightarrow \Delta$, where Δ is an affine space defined in (5.A). The following is our second main result, where ϑ is a *particular* choice of stability condition explained in §5.2.

Theorem 1.2 (5.12). *For any cyclic group $\frac{1}{r}(1, a)$, the diagram*

$$\begin{array}{ccc} \text{Rep}(\mathbb{C}Q, \delta) //_{\vartheta} \text{GL} & \xrightarrow{\quad} & \mathcal{R}^G \\ & \searrow \phi & \downarrow \pi \\ & & \Delta \end{array}$$

is a simultaneous resolution of singularities, in the sense that the morphism ϕ is smooth, and π is flat.

The smoothness of the fibres is achieved using moduli spaces of the deformed reconstruction algebra $A_{r,a,\lambda}$. These are introduced in §5.1, and may be of independent interest. As a final remark, we note in Remark 5.13 that in general the particular choice of ϑ in Theorem 5.12 is important, and cannot be generalised to arbitrary generic stability parameters.

This paper is organised as follows. Section 2 recalls the reconstruction algebra associated to any cyclic subgroup of $\text{GL}(2, \mathbb{C})$, and recalls quasideterminantal form. Section 3 proves that the invariant representation variety associated to the quiver of this reconstruction algebra is generated by certain cycles $z_{i,j}$. In Section 4 the Artin component is obtained. Section 5 introduces the deformed reconstruction algebra, and uses this to achieve simultaneous resolution.

Conventions. Throughout we work over the complex numbers \mathbb{C} . For quivers, ab denotes a followed by b .

Acknowledgements. The author would like to thank the GRAID program for sponsoring his PhD studies, and the ERC Consolidator Grant 101001227 (MMiMMa) for funding his visit to Glasgow. Furthermore, he would like to thank in a special way his supervisors Michael Wemyss and David Ssevviiri for their guidance and encouragement, and the Department of Mathematics, Makerere University and the School of Mathematics & Statistics, University of Glasgow for the hospitality and warm environment to pursue his studies.

2. PRELIMINARIES

This section recalls the reconstruction algebra of Type A , and introduces some combinatorics that will be used later.

2.1. The Reconstruction Algebra of Type A . Consider, for positive integers $\alpha_i \geq 2$, the following labelled Dynkin diagram of Type A_n

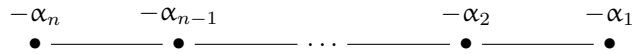

We call the vertex corresponding to α_i the i^{th} vertex. To this picture we associate the double quiver of the extended Dynkin quiver, with the extended vertex called the 0^{th} vertex:

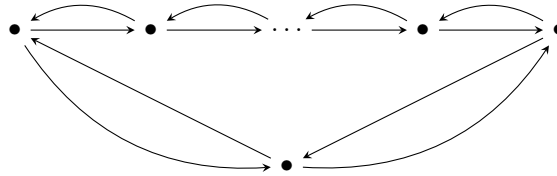

Denote this quiver Q' , and we remark that for $n = 1$ Q' is

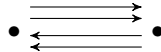

In the case that some $\alpha_i > 2$, add an additional $\alpha_i - 2$ arrows from the i^{th} vertex to the 0^{th} vertex. The resulting quiver is denoted Q , and we label its arrows as follows:

For $n = 1$, we write

- c_1, c_2 for the two arrows from 0 to 1 in Q' .
- a_1, a_2 for the two arrows from 1 to 0 in Q' .
- $k_1, \dots, k_{\alpha_1-2}$ for the extra arrows if $\alpha_1 > 2$.

For $n \geq 2$, we write the

- clockwise arrow in Q' from i to $i - 1$ as c_{ii-1} (and c_{0n})
- anticlockwise arrow in Q' from i to $i + 1$ as a_{ii+1} (and a_{n0})
- extra arrows as $k_1, \dots, k_{\sum(\alpha_i-2)}$, reading from right to left (see Examples below).

The notation a_{12} is read ‘anticlockwise from 1 to 2’. Below, we furthermore write A_{ij} for the composition of anticlockwise paths a from vertex i to j , and C_{ij} as the composition of clockwise paths. Note that by convention C_{ii} (resp. A_{ii}) is not an empty path at vertex i but rather the path from i to i round each of the clockwise (resp. anticlockwise) arrows precisely once. Lastly, for convenience write $c_{10} := k_0$ and $a_{n0} := k_{1+\sum(\alpha_i-2)}$.

Example 2.1. For $[\alpha_1, \alpha_2, \alpha_3] = [3, 2, 2]$, the labelled quiver Q is

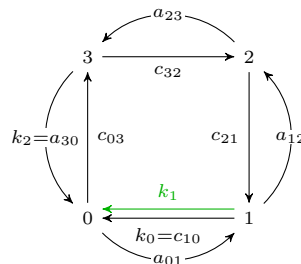

Example 2.2. For $[\alpha_1, \alpha_2, \alpha_3, \alpha_4, \alpha_5, \alpha_6, \alpha_7] = [2, 3, 2, 4, 3, 2, 2]$, the labelled quiver Q is

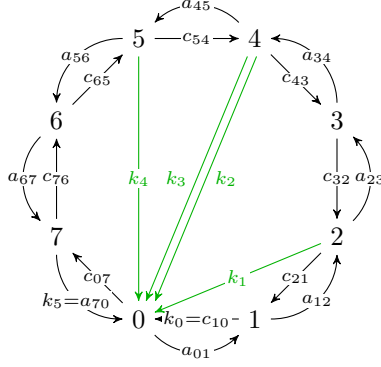

2.2. Cyclic Groups and Combinatorics. A reconstruction algebra can be associated to any cyclic subgroup of $\mathrm{GL}(2, \mathbb{C})$.

Definition 2.3. For $r, a \in \mathbb{N}$ with $(r, a) = 1$ and $r > a$, the group $\frac{1}{r}(1, a)$ is defined to be

$$\frac{1}{r}(1, a) := \left\langle \zeta := \begin{pmatrix} \varepsilon & 0 \\ 0 & \varepsilon^a \end{pmatrix} \right\rangle \leq \mathrm{GL}(2, \mathbb{C}),$$

where ε is a primitive r^{th} root of unity. The Hirzebruch–Jung continued fraction expansion of $\frac{r}{a}$ is then denoted

$$\frac{r}{a} = \alpha_1 - \frac{1}{\alpha_2 - \frac{1}{\alpha_3 - \frac{1}{\dots}}} := [\alpha_1, \dots, \alpha_n]$$

with each $\alpha_i \geq 2$. For $\frac{r}{r-a}$, the Hirzebruch–Jung expansion is written

$$\frac{r}{r-a} = \beta_1 - \frac{1}{\beta_2 - \frac{1}{\beta_3 - \frac{1}{\dots}}} := [\beta_1, \dots, \beta_m]. \quad (2.A)$$

Write e for the embedding dimension of the singularity $\mathbb{C}[x, y]^{\frac{1}{r}(1, a)}$. Then by [R2, §3] there is an equality $e = m + 2 = 3 + \sum(\alpha_i - 2)$.

To be consistent with [W1, 3.5], consider the \mathfrak{i} and \mathfrak{j} -series of (2.A), which is defined to be:

$$\begin{aligned} \mathfrak{i}_0 &= r & \mathfrak{i}_1 &= r - a & \mathfrak{i}_t &= \beta_{t-1}\mathfrak{i}_{t-1} - \mathfrak{i}_{t-2} & \text{for } 2 \leq t \leq m+1, \\ \mathfrak{j}_0 &= 0 & \mathfrak{j}_1 &= 1 & \mathfrak{j}_t &= \beta_{t-1}\mathfrak{j}_{t-1} - \mathfrak{j}_{t-2} & \text{for } 2 \leq t \leq m+1. \end{aligned} \quad (2.B)$$

It is well known that the collection $x^{\mathfrak{i}_t} y^{\mathfrak{j}_t}$ for all t such that $0 \leq t \leq m+1$ generate the invariant ring [R3, Satz1].

Definition 2.4 ([W1, §2]). The reconstruction algebra $A_{r, a}$ associated to the group $\frac{1}{r}(1, a)$ is the path algebra of the quiver Q in §2.1 associated to the Hirzebruch–Jung continued fraction expansion of $\frac{r}{a}$, subject to the relations given in Definition 5.1 with all λ s equal to zero.

For our purposes, we shall not require the relations until §5, and so we defer introducing them until then.

Example 2.5. Since $\frac{7}{3} = [3, 2, 2]$ the quiver of the reconstruction algebra $A_{7, 3}$ associated to the group $\frac{1}{7}(1, 3)$ is precisely the quiver in Example 2.1. The relations can be found in Example 5.3, after setting all λ s equal to zero.

Example 2.6. Since $\frac{165}{104} = [2, 3, 2, 4, 3, 2, 2]$ the quiver of the reconstruction algebra $A_{165, 104}$ associated to the group $\frac{1}{165}(1, 104)$ is precisely the quiver in Example 2.2. The relations can be found in Example 5.4, after setting all λ s equal to zero.

2.3. Quasideterminantal form. Consider a $2 \times n$ matrix

$$\begin{pmatrix} a_1 & a_2 & \dots & a_n \\ b_1 & b_2 & \dots & b_n \end{pmatrix}$$

together with $n-1$ further entries W_1, \dots, W_{n-1} . We then write these entries in the middle row, as follows.

$$X = \begin{pmatrix} a_1 & a_2 & \dots & a_n \\ W_1 & W_2 & \dots & W_{n-1} \\ b_1 & b_2 & \dots & b_n \end{pmatrix}$$

Following Riemenschneider [R4, §5], consider the 2×2 *quasiminors* of this $2 \times n$ *quasimatrix*, which for all, $i < j$ are defined to be

$$a_i \cdot b_j - b_i \left(\prod_{t=i}^{j-1} W_t \right) a_j.$$

Write $\text{QDet}(X)$ for the set of all 2×2 *quasiminors* of X .

Example 2.7. If

$$X = \begin{pmatrix} a_1 & a_2 & a_3 \\ W_1 & W_2 \\ b_1 & b_2 & b_3 \end{pmatrix},$$

then

$$\text{QDet}(X) = \{a_1 b_2 - b_1 W_1 a_2, a_1 b_3 - b_1 W_1 W_2 a_3, a_2 b_3 - b_2 W_2 a_3\}.$$

3. THE REPRESENTATION VARIETY

This section considers the invariant representation variety associated to the quiver of an reconstruction algebra of Type A , and finds its generators in terms of cycles.

3.1. Generalities. Consider the dimension vector $\delta = (1, \dots, 1)$ and the representation variety $\text{Rep}(\mathbb{C}Q, \delta)$, where Q is an arbitrary (finite) quiver. Here $\text{Rep}(\mathbb{C}Q, \delta)$ is just an affine space, and we write $\mathcal{R} := \mathbb{C}[\text{Rep}(\mathbb{C}Q, \delta)]$ for its co-ordinate ring, which we identify with the polynomial ring in the number of arrow variables. The co-ordinate ring carries a natural action of $G := \prod_{q \in Q_0} \mathbb{C}^*$ where Q_0 denotes the set of vertices of Q . The action is via conjugation, namely $\mu \in G = \mathbb{C}^* \times \dots \times \mathbb{C}^*$ acts on an arrow $p \in \mathcal{R}$ as $\mu \cdot p = \mu_{t(p)}^{-1} p \mu_{h(p)}$.

Below, we say that arrows p_1, \dots, p_n are *composable* if $h(p_i) = t(p_{i+1})$ for all $i = 1, \dots, n-1$.

Lemma 3.1. *If Q is an arbitrary (finite) quiver, then \mathcal{R}^G is generated by cycles in Q .*

Proof. Choose a monomial $p = p_1 \dots p_n \in \mathcal{R}$, where p_i 's are arrows. We claim that $\mu \cdot p = p$ for all $\mu \Leftrightarrow p$ is a cycle. First observe that $\mu \cdot p = (\mu_{t(p_1)} \dots \mu_{t(p_n)})^{-1} p (\mu_{h(p_1)} \dots \mu_{h(p_n)})$. (\Leftarrow) If p is a cycle, in particular it is composable. Thus for all $\mu \in G$,

$$\begin{aligned} \mu \cdot p &= \mu_{t(p_1)}^{-1} p_1 \mu_{h(p_1)} \mu_{t(p_2)}^{-1} p_2 \mu_{h(p_2)} \dots \mu_{t(p_n)}^{-1} p_n \mu_{h(p_n)} \\ &= \mu_{t(p_1)}^{-1} \mu_{h(p_n)} p_1 p_2 \dots p_n \\ &= \mu_{t(p_1)}^{-1} \mu_{h(p_n)} p \\ &= p. \end{aligned} \quad (\text{since } t(p_1) = h(p_n))$$

Hence $p \in \mathcal{R}^G$.

(\Rightarrow) Suppose that $p \in \mathcal{R}^G$ such that $\mu \cdot p = p$ for all μ . Then $\mu_{h(p_1)}$ must cancel some $\mu_{t(p_i)}^{-1}$ for some i , so $h(p_1) = t(p_i)$. Now consider $\mu_{h(p_i)}$. It must cancel $\mu_{t(p_j)}^{-1}$ for some j , so $h(p_i) = t(p_j)$. Continuing like this, we can assume $p = p_1 p_i p_j \dots p_m$ where $p_1 p_i p_j \dots p_m$ is composable. But then $\mu \cdot p = \mu_{t(p_1)}^{-1} \cdot p \cdot \mu_{h(p_m)}$ and so since $\mu \cdot p = p$, $t(p_1) = h(p_m)$, and p is a cycle. \square

3.2. Reconstruction Algebras. We now specialise to the case where Q is the quiver of the reconstruction algebra of §2.1. By Lemma 3.1, \mathcal{R}^G is generated by cycles and this subsection finds a finite generating set.

To set notation, for h such that $0 \leq h \leq 1 + \sum(\alpha_i - 2)$, write l_h for the number of the vertex associated to the tail of the arrow k_h . In Example 2.2 above, $l_2 = 4$, $l_3 = 4$ and $l_4 = 5$ are associated to the tail of the arrows k_2 , k_3 and k_4 respectively.

Consider

$$\begin{aligned} z_{0,0} &= C_{00} \\ \text{for } 1 \leq i \leq e-2 &\begin{cases} z_{i,0} = C_{0l_i} k_i \\ z_{i,j} = c_{l_i-(j-1), l_i-j} a_{l_i-j, l_i-(j-1)} & \forall 1 \leq j \leq l_i - l_{i-1} \\ z_{i, l_i - l_{i-1} + 1} = A_{0l_{i-1}} k_{i-1} \end{cases} \quad (3.A) \\ z_{e-1,0} &= A_{00} \end{aligned}$$

Proposition 3.2. For any group $\frac{1}{r}(1, a)$, \mathcal{R}^G is generated as a \mathbb{C} -algebra by the set

$$S = \{z_{0,0}, z_{i,j}, z_{e-1,0} \mid i \in [1, e-2], j \in [0, l_i - l_{i-1} + 1]\}.$$

Before proving the Proposition, we illustrate the set S in the two running examples.

Example 3.3. The quiver of the reconstruction algebra associated to $\frac{1}{7}(1, 3)$ is given in Example 2.1. The set S is

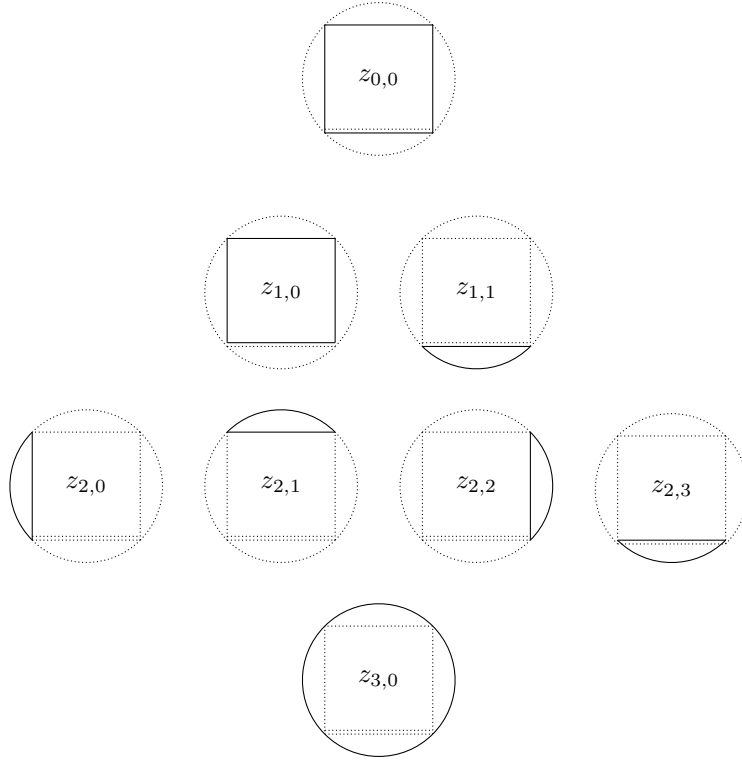

Example 3.4. The quiver of the reconstruction algebra associated to $\frac{1}{165}(1, 104)$ is given in Example 2.2. The set S is

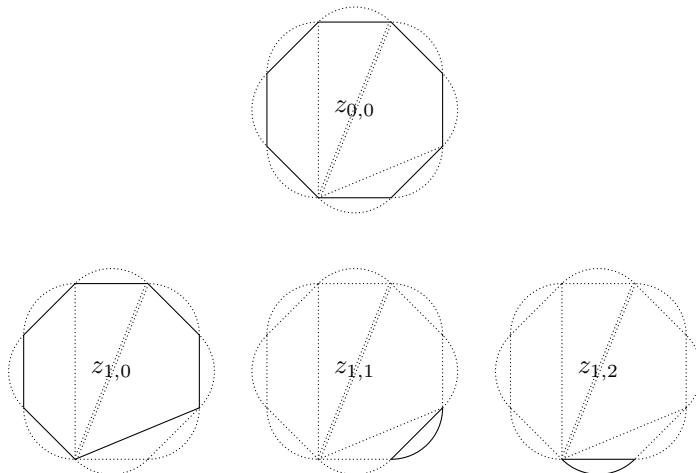

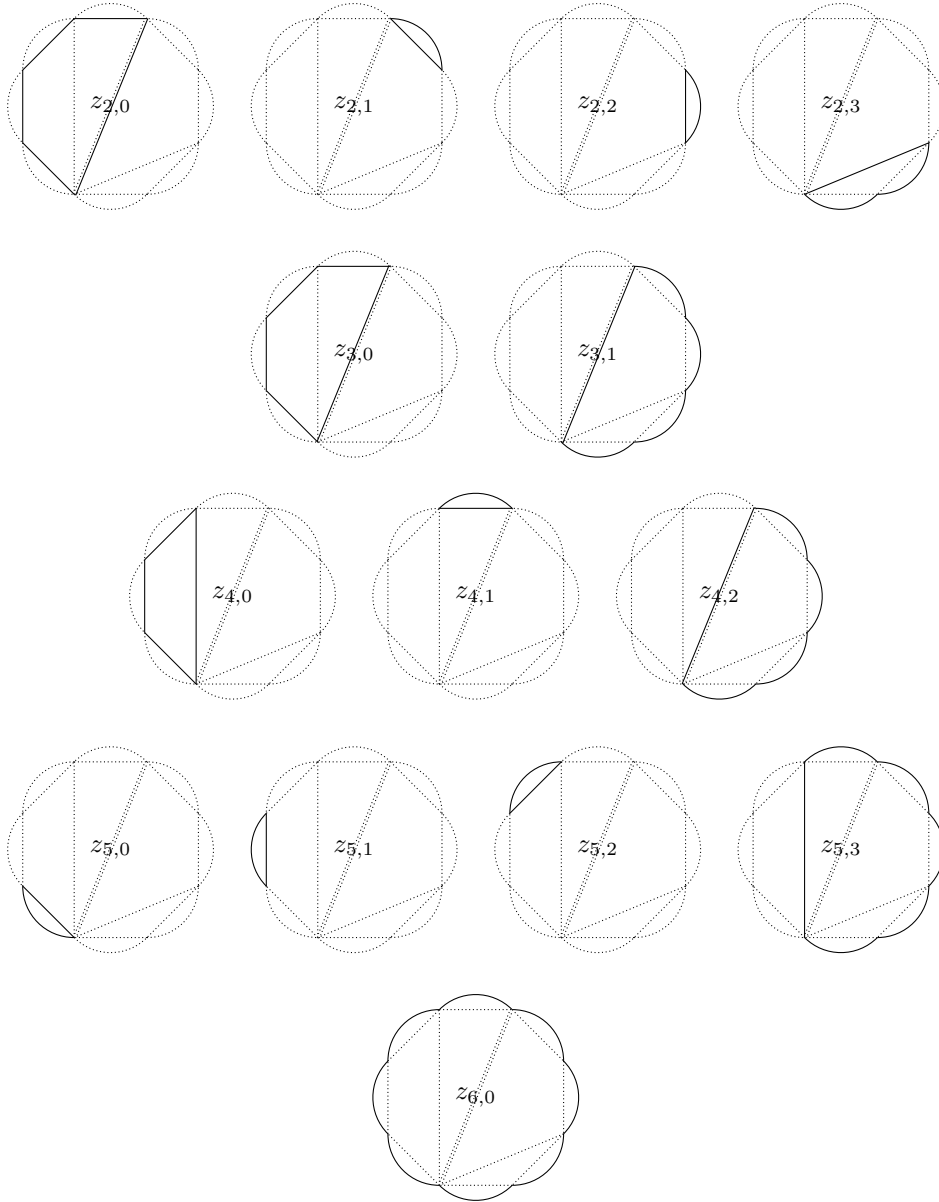

With the above notation set, the proof of Proposition 3.2 is a relatively simple induction. In what follows, for two paths $p, q \in \mathbb{C}Q$, we write $p \sim q$ if $p = q$ in $\mathcal{R} := \mathbb{C}[\text{Rep}(\mathbb{C}Q, \delta)]$ where $\delta = (1, \dots, 1)$.

Proof. By Lemma 3.1, \mathcal{R}^G is generated by cycles. Hence consider a cycle p , then the proof is complete if we show that p is generated by elements in S . We induct on the lengths of cycles, since all cycles of length two (the ac 's) are already in the generating set.

For any vertex v , consider a non trivial cycle p , then it must leave the vertex. According to the quiver, there are three options:

Case 1. The path p starts with a k arrow ($p = k_t p'$). Since p is a cycle then $p' : 0 \rightarrow v$, so we have the following subcases:

- (a) p' starts clockwise. If p' moves in the clockwise direction indefinitely to vertex v ($p' = C_{0v} p''$), then $p = k_t C_{0v} p'' \sim z p''$ and by induction $p \in \langle S \rangle$. Hence we can assume that, at some stage p' stops travelling clockwise before vertex v . At that stage, either we continue anticlockwise so

$$p = k_t C_{0w} a_{ww+1} p'' = k_t C_{0w+1} \underbrace{c_{w+1w} a_{ww+1}}_z p'' \sim z(\text{cycles of length smaller than } p),$$

or we continue via some k_j so

$$p = k_t C_{0w} k_j p'' = k_t \underbrace{C_{0w} k_j}_{z} p'' \sim z(\text{cycles of length smaller than } p).$$

In either case, by induction $p \in \langle S \rangle$.

- (b) p' starts anticlockwise. This subcase is similar to (a), interchanging the clockwise paths and the anticlockwise paths.

Case 2. The path p starts with a clockwise arrow, so $p = c_{vv-1} p'$. Since p is a cycle then $p' : v-1 \rightarrow v$. If p' continues clockwise indefinitely, then we can write $p = C_{vv} p'' \sim z_{0,0} p''$, and by induction we are done. Otherwise, at some stage p' stops travelling clockwise and we can write $p = C_{vw} p'$ for some $p' : w \rightarrow v$. According to the quiver, there are two options.

- (a) p' starts with an anticlockwise arrow ($p' = ap''$), so then

$$p = C_{vw} a_{ww+1} p'' = C_{vw+1} \underbrace{(c_{w+1w} a_{ww+1})}_{z} p'' \sim z(\text{cycles of length smaller than } p),$$

thus by induction, $p \in \langle S \rangle$.

- (b) p' starts with a k arrow ($p' = kp''$), and we repeat a similar procedure as in Case 1 applied to p' . By induction, $p \in \langle S \rangle$.

Case 3. The path p starts with an anticlockwise arrow. This is very similar to Case 2, after interchanging the clockwise and the anticlockwise arrows. \square

4. THE ARTIN COMPONENT

This section recovers the Artin component directly from the quiver of the reconstruction algebras, using the representation variety.

4.1. QDet and First Properties. By Riemenschneider duality (see e.g. [W1, 2.11]), for all t such that $1 \leq t \leq m$ there is an equality $\beta_t = l_t - l_{t-1} + 2$. Set

$$s_t = \begin{cases} \beta_t - 1 & \text{if } 1 \leq t \leq m \\ 0 & \text{if } t = m + 1, \end{cases}$$

Recalling the notation in §2.3, consider the description of the Artin component of $\frac{1}{r}(1, a)$ due to Riemenschneider [R4], which in its *quasideterminantal* form is as follows:

$$\begin{pmatrix} z_{0,0} & & & z_{1,0} & & & z_{2,0} & \cdots & & & z_{m,0} \\ & z_{1,s_1-1} \cdots \cdots z_{1,1} & & & z_{2,s_2-1} \cdots \cdots z_{2,1} & & & & & & z_{m,s_m-1} \cdots \cdots z_{m,1} \\ z_{1,s_1} & & & z_{2,s_2} & & & z_{3,s_3} & \cdots & & & z_{m+1,s_{m+1}} \end{pmatrix}.$$

As in §2.3, $\text{QDet}(z)$ is defined to be the set of all *quasiminors* of the above matrix.

Example 4.1. The Artin component of the group $\frac{1}{7}(1, 3)$ in Example 3.3 has quasideterminantal form

$$\begin{pmatrix} z_{0,0} & z_{1,0} & & z_{2,0} \\ & & z_{2,2} z_{2,1} & \\ z_{1,1} & z_{2,3} & & z_{3,0} \end{pmatrix},$$

thus $\text{QDet}(z)$ is the set

$$\{z_{0,0} z_{2,3} - z_{1,0} z_{1,1}, z_{0,0} z_{3,0} - z_{2,0} z_{2,1} z_{2,2} z_{1,1}, z_{1,0} z_{3,0} - z_{2,0} z_{2,1} z_{2,2} z_{2,3}\}.$$

Example 4.2. The Artin component of the group $\frac{1}{165}(1, 104)$ in Example 3.4 has quasideterminantal form

$$\begin{pmatrix} z_{0,0} & & & z_{1,0} & & & z_{2,0} & z_{3,0} & & & z_{4,0} & & & z_{5,0} \\ & & & & & & & & & & & & & & \\ & z_{1,1} & & & z_{2,2} z_{2,1} & & & & & & z_{4,1} & & z_{5,2} z_{5,1} & \\ z_{1,2} & & & z_{2,3} & & & z_{3,1} & z_{4,2} & & & z_{5,3} & & & z_{6,0} \end{pmatrix},$$

and in this case $\text{QDet}(z)$ consists of 15 relations.

For the group $\frac{1}{r}(1, a)$, recall from §3.2 that \mathcal{R}^G is constructed only from the quiver of the reconstruction algebra. Consider the polynomial ring $\mathbb{C}[z]$ which has as variables elements in the set S of Proposition 3.2. There is a natural homomorphism

$$\mathbb{C}[z] \xrightarrow{\varphi} \mathcal{R}^G,$$

defined by sending $z_{i,j}$ to the corresponding cycle in (3.A).

Proposition 4.3. *For any group $\frac{1}{r}(1, a)$, the homomorphism $\varphi: \mathbb{C}[z] \rightarrow \mathcal{R}^G$ is surjective, and $\text{QDet}(z)$ belongs to the kernel.*

Proof. Surjectivity follows from Proposition 3.2. We just need to show that the quasiminors are sent to zero. An arbitrary quasiminor is determined by

- First choosing $z_{i,0}$, $0 \leq i \leq m-1$.
- Then choosing z_{j,s_j} , $i+2 \leq j \leq m+1$.

With these choices,

$$\begin{aligned} \varphi(z_{i,0}z_{j,s_j}) &= C_{0l_i}k_i \cdot A_{0l_{i+1}}k_{i+1} \\ &= C_{0l_{i+1}}(c_{l_{i+1}l_{i+1}-1} \cdots c_{l_i+1l_i})k_i \cdot A_{0l_i}(a_{l_i l_i+1} \cdots a_{l_{i+1}-1l_{i+1}})k_{i+1} \\ &\quad \text{(since elements in } \mathbb{C}[z] \text{ commute)} \\ &= A_{0l_i}k_i \cdot (c_{l_{i+1}l_{i+1}-1}a_{l_{i+1}-1l_{i+1}} \cdots c_{l_i+1l_i}a_{l_i l_i+1}) \cdot C_{0l_{i+1}}k_{i+1} \\ &= A_{0l_i}k_i \left(\prod_{p=1}^{l_{i+1}-l_i} c_{l_{i+1}-(p-1)l_{i+1}-p}a_{l_{i+1}-pl_{i+1}-(p-1)} \right) C_{0l_{i+1}}k_{i+1} \\ &= \varphi \left(z_{i+1,s_{i+1}} \left(\prod_{k=i+1}^{j-1} z_{k,1} \cdots z_{k,s_k-1} \right) z_{j-1,0} \right) \\ &= \varphi \left(z_{i+1,s_{i+1}} \left(\prod_{k=i+1}^{j-1} z_{k,s_k-1} \cdots z_{k,1} \right) z_{j-1,0} \right). \end{aligned}$$

This shows that the quasiminor relation

$$z_{i,0}z_{j,s_j} = z_{i+1,s_{i+1}} \left(\prod_{k=i+1}^{j-1} z_{k,s_k-1} \cdots z_{k,1} \right) z_{j-1,0}$$

belongs to the kernel of φ , as required. \square

The remainder of this section will prove that $\text{QDet}(z)$ generates the kernel, but this involves significant work.

4.2. Toric ideals generalities. To compute the kernel of the homomorphism φ in Proposition 4.3, we will rely on its description as a toric ideal of $\mathbb{C}[z]$, as explained in [S, §4].

Let $\mathcal{A} = \{a_1, a_2, \dots, a_n\} \subset \mathbb{Z}^d \setminus \{0\}$, where each a_i is considered as a column vector, and consider the Laurent polynomial ring $k[t^{\pm 1}] := k[t_1, \dots, t_d, t_1^{-1}, \dots, t_d^{-1}]$. Set $A = [a_1 a_2 \dots a_n] \in \mathbb{Z}^{d \times n}$ to be the corresponding $d \times n$ matrix, and consider the map

$$\begin{aligned} k[x] &\rightarrow k[t^{\pm 1}] \\ x_i &\mapsto t^{a_i}. \end{aligned}$$

The toric ideal of \mathcal{A} , denoted by $I_{\mathcal{A}}$, is by definition the kernel. It is possible to compute this using an elimination method, however this is computationally hard in general. A more efficient algorithm to compute $I_{\mathcal{A}}$ is given in [S, Algorithm 12.3], and proceeds as follows:

- (1) Find any lattice spanning set L for $\ker(A)_{\mathbb{Z}}$.
- (2) Consider the ideal $I_L := (x^{u^+} - x^{u^-} \mid u \in L)$, and compute the saturation of I_L , $(I_L : (x_1 x_2 \dots x_n)^\infty)$ with respect to the indeterminates x_1, \dots, x_n . Then

$$(I_L : (x_1 \dots x_n)^\infty) = I_{\mathcal{A}}.$$

Part (2) is the most difficult step.

4.3. Step 1: Lattice Spanning Set. This section explains how to view the homomorphism $\varphi: \mathbb{C}[z] \rightarrow \mathcal{R}^G$ in the toric language of the previous section, then in Corollary 4.12 computes a lattice spanning set for the kernel.

Example 4.4. For the group $\frac{1}{3}(1, 1)$, the homomorphism $\varphi: \mathbb{C}[z] \rightarrow \mathcal{R}^G$ sends $z_{0,0} \mapsto c_1 a_1$, $z_{3,0} \mapsto c_2 k_1$, and

$$\begin{array}{ll} z_{1,0} \mapsto c_1 a_2 & z_{2,0} \mapsto c_1 k_1 \\ z_{1,1} \mapsto c_2 a_1 & z_{2,1} \mapsto c_2 a_2. \end{array}$$

Each of $z_{0,0}, z_{1,0}, z_{1,1}, z_{2,0}, z_{2,1}$, and $z_{3,0}$ gives rise to a column vector, where the entries in the column corresponding to $z_{i,j}$ record the exponents of the variables k_1, a_2, a_1, c_1 and c_2 that appear in the (monomial) image of $z_{i,j}$ under the map φ . Hence

$$M = \begin{array}{c} \begin{array}{cccccc} & z_{3,0} & z_{2,1} & z_{1,1} & z_{0,0} & z_{1,0} & z_{2,0} \end{array} \\ \begin{array}{l} k_1 \\ a_2 \\ a_1 \\ c_1 \\ c_2 \end{array} \begin{pmatrix} \boxed{1} & \boxed{0} & \boxed{0} & \boxed{0} & \boxed{0} & \boxed{0} & \boxed{1} \\ \boxed{0} & \boxed{1} & \boxed{0} & \boxed{0} & \boxed{1} & \boxed{0} & \boxed{0} \\ \boxed{0} & \boxed{0} & \boxed{1} & \boxed{1} & \boxed{0} & \boxed{0} & \boxed{0} \\ \boxed{0} & \boxed{0} & \boxed{0} & \boxed{1} & \boxed{1} & \boxed{1} & \boxed{1} \\ \boxed{1} & \boxed{1} & \boxed{1} & \boxed{0} & \boxed{0} & \boxed{0} & \boxed{0} \end{pmatrix} \end{array}.$$

The kernel of the map φ is by construction, the toric ideal of the matrix M .

Notation 4.5. In the case $\frac{1}{r}(1, 1)$, in a similar way to Example 4.4 each $z_{i,j}$ gets mapped under φ to a monomial in the arrows, and thus we can build a matrix M where the columns record the exponents. To do this requires us to fix an order on the columns and rows, which we do now. Consider the following diagram.

$$\begin{array}{ccccccc} z_{0,0} & \xrightarrow{z_{1,0}} & \cdots & \xrightarrow{z_{m-1,0}} & \xrightarrow{z_{m,0}} \\ z_{1,1} & \xrightarrow{z_{2,1}} & \cdots & \xrightarrow{z_{m,1}} & \xrightarrow{z_{m+1,0}} \end{array}$$

Following the arrow, we label the columns $1, \dots, 2r$ of the matrix M by

$$z_{m+1,0}, z_{m,1}, \dots, z_{1,1}, z_{0,0}, \dots, z_{m-1,0}, z_{m,0}.$$

and the rows of M by $k_\ell, \dots, k_1, a_2, a_1, c_1, c_2$. With this ordering,

$$M = \begin{array}{c} \begin{array}{c} \xleftrightarrow{2r} \\ \boxed{\text{Id}_r} \quad \boxed{\text{Id}_r^*} \\ \xleftrightarrow{2r} \end{array} \\ \begin{array}{cccc} 0 & 0 & 1 & 1 \\ 1 & 1 & 0 & 0 \end{array} \end{array}$$

where Id_r is the $r \times r$ identity matrix, and Id_r^* is the anti-diagonal identity matrix.

For the general case $\frac{1}{r}(1, a)$ with $a \neq 1$, there is also a matrix M whose entries are similarly the powers of the variables. To describe the matrix M requires us to set notation, which we do now.

Notation 4.6. Consider the following diagram.

$$\left(\begin{array}{ccccccc} \xrightarrow{2} & & \xrightarrow{4} & & & & \\ z_{0,0} & & z_{1,0} & & z_{2,0} & & z_{m-1,0} & & \xrightarrow{z_{m,0}} \\ & z_{1,s_1-1} \cdots z_{1,1} & & z_{2,s_2-1} \cdots z_{2,1} & & \cdots & & z_{m,s_m-1} \cdots z_{m,1} & \xrightarrow{z_{m,0}} \\ \xrightarrow{1} & z_{1,s_1} & & z_{2,s_2} & & z_{3,s_3} & & z_{m,s_m} & \xrightarrow{3} z_{m+1,s_{m+1}} \end{array} \right)$$

Following the above arrows as numbered, we label the columns $1, \dots, \ell + n + 1$ of M by

$$z_{m,s_m}, \dots, z_{1,s_1}, z_{1,s_1-1}, \dots, z_{1,1}, z_{2,s_2-1}, \dots, z_{2,1}, \dots, z_{m,s_m-1}, \dots, z_{m,1}, z_{m,0}$$

Then column $\ell + n + 2$ will be labelled $z_{0,0}$, column $\ell + n + 3$ labelled $z_{m+1,s_{m+1}}$, and columns $\ell + n + 4, \dots, 2\ell + n + 3$ will be labelled $z_{1,0}, \dots, z_{m-1,0}$.

We next specify the labelling of the rows of M . The first ℓ rows will be k_ℓ, \dots, k_1 , then the next rows labelled a_{01}, \dots, a_{n0} , then the next rows c_{0n}, \dots, c_{10} .

Example 4.7. For the group $\frac{1}{7}(1, 2)$, the homomorphism $\varphi: \mathbb{C}[z] \rightarrow \mathcal{R}^G$ sends $z_{0,0} \mapsto c_{02}c_{21}c_{10}$, $z_{4,0} \mapsto a_{01}a_{12}a_{20}$, and

$$\begin{array}{lll} z_{1,0} \mapsto c_{02}c_{21}k_1 & z_{2,0} \mapsto c_{02}c_{21}k_2 & z_{3,0} \mapsto c_{02}a_{20} \\ z_{1,1} \mapsto c_{10}a_{01} & z_{2,1} \mapsto a_{01}k_1 & z_{3,1} \mapsto c_{21}a_{12} \\ & & z_{3,2} \mapsto a_{01}k_2. \end{array}$$

The exponents of $z_{0,0}, z_{1,0}, z_{1,1}, z_{2,0}, z_{2,1}, z_{3,0}, z_{3,1}, z_{3,2}$ and $z_{4,0}$ lead to the column vectors with each entry of any corresponding column vector being the power of the variables $k_2, k_1, a_{01}, a_{12}, a_{20}, c_{02}, c_{21}$ and c_{10} respectively. Hence

$$M = \begin{array}{c} \begin{array}{cccccccc} & z_{3,2} & z_{2,1} & z_{1,1} & z_{3,1} & z_{3,0} & z_{0,0} & z_{4,0} & z_{1,0} & z_{2,0} \end{array} \\ \begin{array}{c} k_2 \\ k_1 \\ a_{01} \\ a_{12} \\ a_{20} \\ c_{02} \\ c_{21} \\ c_{10} \end{array} \left(\begin{array}{cccccccc} \boxed{1} & \boxed{0} & \boxed{0} & \boxed{0} & \boxed{0} & \boxed{0} & \boxed{0} & \boxed{0} & \boxed{0} & \boxed{1} \\ \boxed{0} & \boxed{1} & \boxed{0} & \boxed{0} & \boxed{0} & \boxed{0} & \boxed{0} & \boxed{0} & \boxed{1} & \boxed{0} \\ \boxed{1} & \boxed{1} & \boxed{1} & \boxed{0} & \boxed{0} & \boxed{0} & \boxed{0} & \boxed{1} & \boxed{0} & \boxed{0} \\ \boxed{0} & \boxed{0} & \boxed{0} & \boxed{1} & \boxed{0} & \boxed{0} & \boxed{0} & \boxed{1} & \boxed{0} & \boxed{0} \\ \boxed{0} & \boxed{0} & \boxed{0} & \boxed{0} & \boxed{1} & \boxed{0} & \boxed{1} & \boxed{0} & \boxed{1} & \boxed{1} \\ \boxed{0} & \boxed{0} & \boxed{0} & \boxed{1} & \boxed{0} & \boxed{0} & \boxed{1} & \boxed{0} & \boxed{1} & \boxed{1} \\ \boxed{0} & \boxed{0} & \boxed{1} & \boxed{0} & \boxed{0} & \boxed{0} & \boxed{1} & \boxed{0} & \boxed{0} & \boxed{0} \end{array} \right)$$

With the above ordering of the columns and rows, we now give a general block decomposition of M which explains the boxes in Example 4.7.

Lemma 4.8. *With the ordering on rows and columns as in Notation 4.6,*

$$M = \begin{array}{c} \begin{array}{ccc} \xrightarrow{\ell} & \xrightarrow{n+1} & \xrightarrow{\ell} \\ \begin{array}{|c|} \hline \boxed{\text{Id}_\ell} \\ \hline \end{array} & \begin{array}{|c|} \hline \boxed{0} \\ \hline \end{array} & \begin{array}{|c|} \hline \begin{array}{c} 00 \\ \vdots \\ 00 \end{array} \\ \hline \end{array} & \begin{array}{|c|} \hline \boxed{\text{Id}_\ell^*} \\ \hline \end{array} \end{array} \\ \begin{array}{c} \ell \\ \downarrow \\ \begin{array}{|c|} \hline \boxed{A} \\ \hline \end{array} & \begin{array}{|c|} \hline \boxed{\text{Id}_{n+1}} \\ \hline \end{array} & \begin{array}{|c|} \hline \begin{array}{c} 01 \\ \vdots \\ 01 \end{array} \\ \hline \end{array} & \begin{array}{|c|} \hline \boxed{0} \\ \hline \end{array} \\ \begin{array}{c} n+1 \\ \downarrow \\ \begin{array}{|c|} \hline \boxed{0} \\ \hline \end{array} & \begin{array}{|c|} \hline \boxed{\text{Id}_{n+1}^*} \\ \hline \end{array} & \begin{array}{|c|} \hline \begin{array}{c} 10 \\ \vdots \\ 10 \end{array} \\ \hline \end{array} & \begin{array}{|c|} \hline \boxed{B} \\ \hline \end{array} \end{array} \end{array}$$

Proof. In the z 's, the k 's only appear as illustrated below.

$$\begin{array}{ccccccc} z_{0,0} & & & & & & z_{m,0} \\ & z_{1,s_1-1} \dots z_{1,1} & \boxed{z_{1,0}} & z_{2,s_2-1} \dots z_{2,1} & \boxed{z_{2,0}} & \dots & \boxed{z_{m-1,0}} \\ & z_{1,s_1} & \boxed{z_{2,s_2}} & & \boxed{z_{3,s_3}} & & \boxed{z_{m,s_m}} \\ & & k_1 & & k_2 & & k_\ell \end{array} \quad z_{m+1,s_{m+1}}$$

Due to the ordering on rows and columns, the first ℓ rows of M are thus

$$\begin{array}{ccc} \xrightarrow{\ell} & \xrightarrow{n+1} & \xrightarrow{\ell} \\ \begin{array}{|c|} \hline \boxed{\text{Id}_\ell} \\ \hline \end{array} & \begin{array}{|c|} \hline \boxed{0} \\ \hline \end{array} & \begin{array}{|c|} \hline \begin{array}{c} 00 \\ \vdots \\ 00 \end{array} \\ \hline \end{array} & \begin{array}{|c|} \hline \boxed{\text{Id}_\ell^*} \\ \hline \end{array} \end{array}$$

where Id_ℓ is the $\ell \times \ell$ identity matrix, and Id_ℓ^* is the anti-diagonal identity matrix. Similarly, in the z 's, the a 's only appear in the following region.

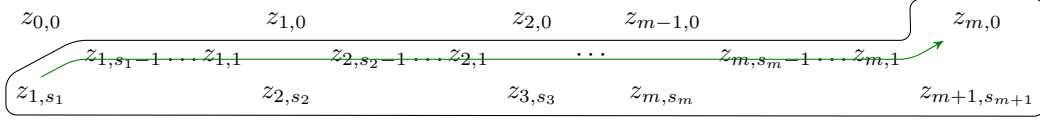

Furthermore, along the green arrow, out of all the a 's, the first z_{1,s_1} contains only a_{01} , the second entry $z_{1,1}$ contains only a_{12} , etc until the last entry $z_{m,0}$ on the green line, which contains only a_{n0} . It follows that the next $n + 1$ rows of M are

$$\begin{array}{c} \begin{array}{|c|c|c|} \hline \xrightarrow{\ell} & \xrightarrow{n+1} & \xrightarrow{\ell} \\ \hline \begin{array}{c} \uparrow \\ n+1 \\ \downarrow \end{array} & \begin{array}{c} \uparrow \\ n+1 \\ \downarrow \end{array} & \begin{array}{c} \uparrow \\ \ell \\ \downarrow \end{array} \\ \hline \begin{array}{|c|c|c|} \hline A & \text{Id}_{n+1} & 0 \\ \hline \end{array} \begin{array}{c} 0 \ 1 \\ \vdots \\ 0 \ 1 \end{array} \end{array} \end{array}$$

for some matrix A (see Remark 4.9 below).

Lastly, in a very similar way the only place the c 's exist in the z 's are in the following region

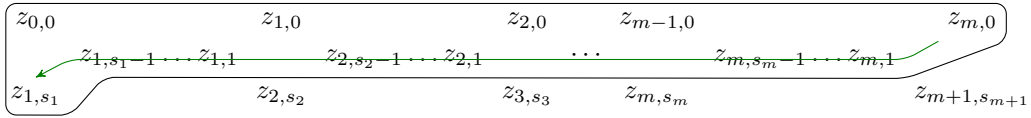

where again following the green line, among all the c 's, the first $z_{m,0}$ contains only c_{0n} , the second entry contains only c_{nn-1} , etc until the last entry z_{1,s_1} on the green line, which contains only c_{10} . It follows that the next $n + 1$ rows of M are

$$\begin{array}{c} \begin{array}{|c|c|c|} \hline \xrightarrow{\ell} & \xrightarrow{n+1} & \xrightarrow{\ell} \\ \hline \begin{array}{c} \uparrow \\ n+1 \\ \downarrow \end{array} & \begin{array}{c} \uparrow \\ n+1 \\ \downarrow \end{array} & \begin{array}{c} \uparrow \\ \ell \\ \downarrow \end{array} \\ \hline \begin{array}{|c|c|c|} \hline 0 & \text{Id}_{n+1}^* & B \\ \hline \end{array} \begin{array}{c} 1 \ 0 \\ \vdots \\ 1 \ 0 \end{array} \end{array} \end{array}$$

for some matrix B . The result follows. \square

Remark 4.9. Although not required, it is possible to explicitly describe both the matrices A and B . For A , there are $\beta_1 - 1, \beta_2 - 2, \beta_3 - 2, \dots, \beta_{m-1} - 2, \beta_m - 1$ rows each containing $\{1, 1, \dots, 1, 1, 1\}, \{1, 1, \dots, 1, 1, 0\}, \{1, 1, \dots, 1, 0, 0\}, \dots, \{0, 0, \dots, 0, 0, 0\}$ respectively.

For B , there are $\beta_m - 1, \beta_{m-1} - 2, \beta_{m-2} - 2, \dots, \beta_2 - 2, \beta_1 - 1$ rows, each containing $\{1, 1, \dots, 1, 1, 1\}, \{1, 1, \dots, 1, 1, 0\}, \{1, 1, \dots, 1, 0, 0\}, \dots, \{0, 0, \dots, 0, 0, 0\}$ respectively.

Now consider the $2 + \sum \beta_i = 2\ell + n + 3$ square matrix

$$Q = \begin{array}{|c|c|} \hline \xrightarrow{\ell+n+2} & \xrightarrow{\ell+1} \\ \hline \begin{array}{c} \uparrow \\ \ell+n+2 \\ \downarrow \end{array} & \begin{array}{c} \uparrow \\ \ell+1 \\ \downarrow \end{array} \\ \hline \begin{array}{|c|c|} \hline \text{Id}_{\ell+n+2} & K \\ \hline \end{array} \\ \hline \begin{array}{c} \uparrow \\ \ell+1 \\ \downarrow \end{array} & \begin{array}{c} \uparrow \\ \ell+1 \\ \downarrow \end{array} \\ \hline \begin{array}{|c|c|} \hline 0 & \\ \hline \end{array} \end{array} \begin{array}{c} 2\ell+n+3 \end{array}$$

where K is the $(2\ell + n + 3) \times (\ell + 1)$ matrix

$$K = \begin{array}{c} \begin{array}{c} \xrightarrow{\ell} \\ \begin{array}{c} 0 \\ \vdots \\ 0 \end{array} \\ \xrightarrow{\ell} \end{array} \begin{array}{c} \boxed{-\text{Id}_\ell^*} \\ \boxed{V} \\ \boxed{\text{Id}_\ell} \end{array} \begin{array}{c} \xrightarrow{\ell} \\ \xrightarrow{n+1} \\ \xrightarrow{\ell} \end{array} \end{array}$$

and the matrix V has $\beta_1 - 1$, $\beta_2 - 2$, $\beta_3 - 2, \dots, \beta_{m-1} - 2, \beta_m - 1$ rows, each containing $\{1, 1, \dots, 1, 1, 1\}$, $\{0, 1, \dots, 1, 1, 1\}$, $\{0, 0, 1, \dots, 1, 1\}, \dots, \{0, 0, \dots, 0, 0, 0\}$ respectively. The matrix K encodes the QDet relations starting from z_{00} , namely

$$\begin{aligned} z_{0,0}z_{m+1,s_{m+1}} &= z_{1,s_1} \cdot z_{1,s_1-1} \cdots z_{1,1} \cdot z_{2,s_2-1} \cdots z_{2,1} \cdots z_{m,s_m-1} \cdots z_{m,1} \cdot z_{m,0} \\ z_{0,0}z_{2,s_2} &= z_{1,s_1} \cdot z_{1,s_1-1} \cdots z_{1,1} \cdot z_{1,0} \\ z_{0,0}z_{3,s_3} &= z_{1,s_1} \cdot z_{1,s_1-1} \cdots z_{1,1} \cdot z_{2,s_2-1} \cdots z_{2,1} \cdot z_{2,0} \\ &\vdots \\ z_{0,0}z_{m,s_m} &= z_{1,s_1} \cdot z_{1,s_1-1} \cdots z_{1,1} \cdot z_{2,s_2-1} \cdots z_{2,1} \cdots z_{m-1,s_{m-1}-1} \cdots z_{m-1,1} \cdot z_{m-1,0}. \end{aligned}$$

Example 4.10. Continuing Example 4.7, here $\beta_1 = 2$ and $\beta_2 = 3$, so the associated matrix K is

$$K = \begin{pmatrix} 0 & 0 & -1 \\ 0 & -1 & 0 \\ -1 & 1 & 1 \\ -1 & 0 & 0 \\ -1 & 0 & 0 \\ 1 & -1 & -1 \\ 1 & 0 & 0 \\ 0 & 1 & 0 \\ 0 & 0 & 1 \end{pmatrix}.$$

Lemma 4.11. Q is invertible and further

$$MQ = \begin{array}{c} \begin{array}{c} \xrightarrow{\ell} \\ \xrightarrow{n+1} \\ \xrightarrow{n+1} \end{array} \begin{array}{c} \boxed{\text{Id}_\ell} \\ \boxed{A} \\ \boxed{0} \end{array} \begin{array}{c} \xrightarrow{n+1} \\ \xrightarrow{n+1} \\ \xrightarrow{n+1} \end{array} \begin{array}{c} \boxed{0} \\ \boxed{\text{Id}_{n+1}} \\ \boxed{\text{Id}_{n+1}^*} \end{array} \begin{array}{c} \xrightarrow{\ell} \\ \xrightarrow{\ell} \\ \xrightarrow{\ell} \end{array} \begin{array}{c} \boxed{0} \\ \boxed{0} \\ \boxed{0} \end{array} \end{array}$$

Proof. Q is invertible since any unitriangular matrix has determinant one. For the second statement, since $\text{QDet} \subseteq \text{Ker}_{\mathbb{Z}}$, it follows that $MK = 0$. This justifies the last $\ell + 1$

columns above. The first $\ell + n + 2$ columns are clear, since multiplying M on the right by the unit matrix $\text{Id}_{\ell+n+2}$ with zero underneath picks out the first $\ell + n + 2$ columns of M only. Thus the first $\ell + n + 2$ columns of M are the first $\ell + n + 2$ columns above. \square

Corollary 4.12. $\text{Ker}_{\mathbb{Z}}$ is generated by the columns of K .

Proof. By the form of MQ in Lemma 4.11, it is clear that it is possible to obtain Smith Normal Form from MQ using only row operations. This gives an invertible matrix R for which

$$RMQ = \begin{array}{c} \begin{array}{|c|} \hline \ell+n+2 \\ \hline \end{array} \begin{array}{|c|} \hline \ell+n+2 \\ \hline \end{array} \begin{array}{|c|} \hline \ell+1 \\ \hline \end{array} \\ \hline \begin{array}{|c|} \hline n \\ \hline \end{array} \begin{array}{|c|} \hline \ell+n+2 \\ \hline \end{array} \begin{array}{|c|} \hline \ell+1 \\ \hline \end{array} \\ \hline \end{array} \begin{array}{c} \text{Id}_{\ell+n+2} \\ 0 \\ 0 \end{array}$$

It follows from Smith Normal Form that $\text{Ker}_{\mathbb{Z}}$ is generated by the last $\ell + 1$ columns of Q , which are precisely the columns of K . \square

Remark 4.13. In the case $a = 1$, equivalently for the groups $\frac{1}{r}(1, 1)$, consider the matrix Q defined as

$$Q = \begin{array}{c} \begin{array}{|c|} \hline r \\ \hline \end{array} \begin{array}{|c|} \hline r \\ \hline \end{array} \begin{array}{|c|} \hline r-1 \\ \hline \end{array} \\ \hline \begin{array}{|c|} \hline r \\ \hline \end{array} \begin{array}{|c|} \hline r-1 \\ \hline \end{array} \\ \hline \end{array} \begin{array}{c} \text{Id}_r \\ 0 \\ \vdots \\ 0 \\ 0 \\ 0 \\ 0 \\ 0 \\ 0 \\ 0 \end{array} \begin{array}{c} 0 \\ 0 \\ \vdots \\ -1 \\ 1 \\ 0 \\ 0 \\ 0 \\ 0 \\ 0 \end{array} \begin{array}{c} K \\ \vdots \\ K \end{array} \quad \text{with } K = \begin{array}{c} \begin{array}{|c|} \hline r-1 \\ \hline \end{array} \begin{array}{|c|} \hline r-1 \\ \hline \end{array} \\ \hline \begin{array}{|c|} \hline r-1 \\ \hline \end{array} \\ \hline \end{array} \begin{array}{c} \text{Id}_{r-1}^* \\ \vdots \\ \text{Id}_{r-1} \end{array}$$

This gives Smith Normal Form, in a similar way to Lemma 4.11, with

$$MQ = \begin{array}{c} \begin{array}{|c|} \hline 2r \\ \hline \end{array} \begin{array}{|c|} \hline r+2 \\ \hline \end{array} \\ \hline \end{array} \begin{array}{c} \text{Id}_{r+1} \\ 0 \\ \vdots \\ 0 \end{array}$$

In particular, this shows that Corollary 4.12 also holds for $a = 1$.

Returning to the notation of §4.2, write L for a spanning set for the kernel of $\varphi_{\mathbb{Z}}$, which by Corollary 4.12 can be taken to be the columns of the above matrix K . As calibration, and again in the notation of §4.2, the associated I_L in Example 4.10 is

$$I_L = (z_{0,0}z_{4,0} - z_{1,1}z_{3,1}z_{3,0}, z_{0,0}z_{2,1} - z_{1,0}z_{1,1}, z_{0,0}z_{3,2} - z_{2,0}z_{1,1}).$$

Now we saturate the ideal I_L , in general.

4.4. Step 2: Saturation. According to [BSR, §1], I_L can be saturated by first introducing a new indeterminate t , then calculating a Gröbner basis of $H := I_L + (tx_1x_2 \dots x_n - 1)$, then afterwards eliminating the variable t . However, this approach makes the ideal inhomogeneous. Instead, following [BSR, §1], we introduce a *homogeneous* variable u whose degree is equal to the sum of the degrees of the variables x_1, \dots, x_n , and then calculate the Gröbner basis of the ideal $H := I_L + (x_1x_2 \dots x_n - u)$ using the graded reverse lexicographic order.

Most importantly, the two main benefits of this approach are:

- (a) If J is an ideal such that $I_L \subseteq J \subseteq I_M$, then instead of saturating I_L , we may saturate J , since $(I_L : (x_1 \dots x_n)^\infty) = I_M = (J : (x_1 \dots x_n)^\infty)$, see [BSR, §1].
- (b) Often we do not need to saturate ideals with respect to all the indeterminates, in our case we will find a much smaller subset.

Lemma 4.14. $I_L \subseteq \text{QDet}(\mathbf{z}) \subseteq I_M$.

Proof. Since I_L are some of the $\text{QDet}(\mathbf{z})$ relations starting with $z_{0,0}$ only, then $I_L \subseteq \text{QDet}(\mathbf{z})$. By Proposition 4.3, $\text{QDet}(\mathbf{z}) \subseteq I_M$. \square

We will therefore saturate $\text{QDet}(\mathbf{z})$ instead of I_L , writing this $(\text{QDet} : P^\infty)$, where P is the product of all the z_{ij} variables. The ideal $(\text{QDet} : P^\infty)$ will be obtained by calculating the DegRevLex-Gröbner basis of the ideal $H' = \text{QDet}(\mathbf{z}) + (P - u)$.

The set of the monomials N in $\mathbb{C}[\mathbf{z}]$ is a basis of $\mathbb{C}[\mathbf{z}]$, considered as a vector space over \mathbb{C} . So any nonzero polynomial $f \in \mathbb{C}[\mathbf{z}]$ is given as the linear combination $f = \sum_{m \in S} \mu_m m$ of monomials, where $S \subset N$, S is finite, and μ_m are all nonzero constants. Set $x^a := x_1^{a_1} \dots x_n^{a_n}$ and $x^b := x_1^{b_1} \dots x_n^{b_n}$ with $a = (a_1, \dots, a_n)$, $b = (b_1, \dots, b_n)$.

Definition 4.15. [MTFGJKP, §1] A term order \succ on S is a total order on the monomials of S such that

1. $x^a \succ x^b$ implies that $x^a x^c \succ x^b x^c$ for all $c \in \mathbb{N}^n$, and
2. $x^a \succ x^0 = 1$ for all $a \in \mathbb{N}^n \setminus \{0\}$.

There are various different term orders on S , with respect to a fixed ordering of the variables, such as $x_1 \succ x_2 \succ \dots \succ x_n$. In the *lexicographic (lex) order*, $x^a \succ x^b$ if and only if the first nonzero entry in the vector $a - b$ is positive.

Example 4.16. If $x \succ y \succ z$, then with respect to lexicographic order,

$$x^4 \succ x^2y^2 \succ x^2yz \succ xy^3.$$

Further, if the polynomial ring $\mathbb{C}[x_1, \dots, x_n]$ is graded, there are additional term orderings. Suppose $\mathbb{C}[x_1, \dots, x_n]$ is graded by (d_1, \dots, d_n) where $\deg(x_i) = d_i$. Set $|a| := \sum a_i d_i$ and $|b| := \sum b_i d_i$. In the *graded reverse lexicographic order*, $x^a \succ x^b$ if and only if either $|a| > |b|$, or $|a| = |b|$ and the last nonzero entry in the vector $a - b$ is negative.

Example 4.17. If $x \succ y \succ z \succ w$ and weight vector $(1, 1, 1, 1)$, with respect to the graded reverse lexicographic order

$$x^2y^2z^3w \succ x^2y^2z^2w^2 \succ xz^4 \succ x^3.$$

The total degree comes first and the lower power of w breaks the tie between the two monomials of degree 8.

When a monomial order \succ has been chosen, the leading monomial of $f = \sum_{m \in S} \mu_m m$ is the largest $m \in S$ with respect to \succ . The leading coefficient is the corresponding μ_m , and the leading term is $\mu_m m$.

Example 4.18. For the polynomial ring $\mathbb{C}[t, a, b_1, b_2, c_1, c_2, c_3, d]$ with the weighting vector $(13, 5, 4, 4, 3, 3, 3, 5)$, consider the polynomial $ac_3 - b_1b_2$. Since it is homogeneous, we look for the lower power of c_3 to break the tie, thus $b_1b_2 \succ ac_3$ and therefore $-b_1b_2$ is the leading term.

Recall that $\text{QDet}(\mathbf{z})$ consists of the quasiminors of the matrix

$$\begin{pmatrix} z_{0,0} & & z_{1,0} & & z_{2,0} & \cdots & & z_{m,0} \\ & z_{1,1} \cdots z_{1,s_1-1} & & z_{2,1} \cdots z_{2,s_2-1} & & & & \\ z_{1,s_1} & & z_{2,s_2} & & z_{3,s_3} & \cdots & z_{m,s_m-1} & z_{m+1,s_{m+1}} \end{pmatrix},$$

and we are aiming to compute a Gröbner basis of the ideal $(\text{QDet} : P^\infty)$, where P is the product of all the z_{ij} variables. The next Lemma allows to replace the full product P with a smaller product.

Lemma 4.19. $(\text{QDet} : P^\infty) = (\text{QDet} : E^\infty)$ where $E = z_{0,0}z_{2,s_2}z_{3,s_3} \cdots z_{m+1,s_{m+1}}$.

Proof. Since E contains only some of the variables $z_{i,j}$, and P contains them all, write $P = EG$. The claim is that $(\text{QDet} : (EG)^\infty) = (\text{QDet} : E^\infty)$. But this follows from [BSR, 2.6(1)] provided we can show that G is invertible in the localisation

$$(\mathbb{C}[\mathbf{z}]/\text{QDet})_E = \mathbb{C}[\mathbf{z}]_E/\text{QDet}_E. \quad (4.A)$$

By definition G contains all the $z_{i,j}$ which are not in E . Now for the quasiminors in $\text{QDet}(\mathbf{z})$, if we invert E we invert all variables $z_{0,0}, z_{2,s_2}, z_{3,s_3}, \dots, z_{m+1,s_{m+1}}$ in E , this implies that all variables in the left hand side monomials of the quasiminor relations starting from $z_{0,0}$, namely

$$\begin{aligned} z_{0,0}z_{2,s_2} &= z_{1,s_1} \cdot z_{1,s_1-1} \cdots z_{1,1} \cdot z_{1,0} \\ z_{0,0}z_{3,s_3} &= z_{1,s_1} \cdot z_{1,s_1-1} \cdots z_{1,1} \cdot z_{2,s_2-1} \cdots z_{2,1} \cdot z_{2,0} \\ &\vdots \\ z_{0,0}z_{m,s_m} &= z_{1,s_1} \cdot z_{1,s_1-1} \cdots z_{1,1} \cdot z_{2,s_2-1} \cdots z_{2,1} \cdots z_{m-1,s_{m-1}-1} \cdots z_{m-1,1} \cdot z_{m-1,0} \\ z_{0,0}z_{m+1,s_{m+1}} &= z_{1,s_1} \cdot z_{1,s_1-1} \cdots z_{1,1} \cdot z_{2,s_2-1} \cdots z_{2,1} \cdots z_{m,s_m-1} \cdots z_{m,1} \cdot z_{m,0} \end{aligned}$$

are invertible modulo $\text{QDet}(\mathbf{z})$. But this implies that all the variables in the right hand side monomials become invertible in (4.A). But the monomials in the right hand side contain all variables, hence G is invertible in (4.A), as required. \square

Example 4.20. For the group $\frac{1}{7}(1, 2)$, $\text{QDet}(\mathbf{z})$ consists of the quasiminors of the matrix

$$\begin{pmatrix} z_{0,0} & z_{1,0} & z_{2,0} & & z_{3,0} \\ & & & z_{3,1} & \\ z_{1,1} & z_{2,1} & z_{3,2} & & z_{4,0} \end{pmatrix}.$$

We saturate $\text{QDet}(\mathbf{z})$ with respect to $E = z_{0,0}z_{2,1}z_{3,2}z_{4,0}$, which is only the coloured z 's.

The kernel of φ , which is the toric ideal I_M , is thus obtained from the saturation $(\text{QDet} : P^\infty) = (\text{QDet} : E^\infty)$ of Lemma 4.19, which in turn will be obtained by eliminating u in the Gröbner basis of the ideal $H = \text{QDet} + (E - u)$.

Definition 4.21. Let $f, g \in \mathbb{C}[\mathbf{z}]$ be nonzero polynomials.

- (1) Write $\text{LM}(f)$, $\text{LM}(g)$ for the leading monomial of f and g respectively, and $\text{LT}(f)$, $\text{LT}(g)$ for the leading terms (i.e. with coefficients). Define $\gamma = \text{LCM}(f, g)$ to be the least common multiple of the monomials $\text{LM}(f)$ and $\text{LM}(g)$.
- (2) The S -polynomial of f and g is the combination

$$S(f, g) = \left(\frac{\gamma}{\text{LT}(f)} \right) f - \left(\frac{\gamma}{\text{LT}(g)} \right) g.$$

Recall that $H = \text{QDet} + (E - u)$ is generated by the quasiminors f_{ij} , together with $f := E - u$. We next grade the polynomial ring $\mathbb{C}[u, \mathbf{z}]$. Recalling the \mathfrak{i} and \mathfrak{j} series in (2.B), for any i such that $0 \leq i \leq m+1$, we declare

$$\deg(z_{i,j}) := \mathfrak{i}_i + \mathfrak{j}_i,$$

which does not depend on j . The variable u is graded so that the equation $E - u$ is homogeneous, thus

$$\deg(u) := \mathfrak{i}_0 + \mathfrak{j}_0 + \sum_{t=2}^{m+1} (\mathfrak{i}_t + \mathfrak{j}_t).$$

Example 4.22. Consider $\frac{1}{7}(1, 2)$, and $f_{12} := z_{0,0}z_{2,1} - z_{1,0}z_{1,1}$, $f_{34} := z_{2,0}z_{4,0} - z_{3,0}z_{3,1}z_{3,2}$. We calculate $S(f_{12}, f_{34})$ with respect to DegRevLex order, to calibrate the reader. The degree of both terms in f_{12} is twelve, so the leading term is thus $-z_{1,0}z_{1,1}$, since the last nonzero entry in

$$(0, 1, 1, 0, 0, 0, 0, 0, 0) - (1, 0, 0, 1, 0, 0, 0, 0, 0)$$

is negative. Similarly, the leading term of f_{34} is $-z_{3,0}z_{3,1}z_{3,2}$, since the degree of both terms in f_{34} is twelve, and the last nonzero entry in

$$(0, 0, 0, 0, 0, 1, 1, 1, 0) - (0, 0, 0, 1, 0, 0, 0, 0, 1)$$

is negative. Thus $S(f_{12}, f_{34})$ equals

$$\begin{aligned} & \frac{z_{1,0}z_{1,1}z_{3,0}z_{3,1}z_{3,2}}{-z_{1,0}z_{1,1}}f_{12} - \frac{z_{1,0}z_{1,1}z_{3,0}z_{3,1}z_{3,2}}{-z_{3,0}z_{3,1}z_{3,2}}f_{34} \\ &= -z_{3,0}z_{3,1}z_{3,2}(z_{0,0}z_{2,1} - z_{1,0}z_{1,1}) + z_{1,0}z_{1,1}(z_{2,0}z_{4,0} - z_{3,0}z_{3,1}z_{3,2}) \\ &= -z_{3,0}z_{3,1}z_{3,2}z_{0,0}z_{2,1} + z_{1,0}z_{1,1}z_{2,0}z_{4,0}. \end{aligned}$$

To ease notation in the following Proposition, as in §2.3 write

$$\begin{pmatrix} z_{0,0} & & z_{1,0} & & z_{2,0} & \cdots & & z_{m,0} \\ z_{1,1} \cdots z_{1,s_1-1} & & z_{2,1} \cdots z_{2,s_2-1} & & & & z_{m,1} \cdots z_{m,s_m-1} & \\ z_{1,s_1} & & z_{2,s_2} & & z_{3,s_3} & \cdots & & z_{m+1,s_{m+1}} \end{pmatrix}$$

as

$$\begin{pmatrix} a_1 & a_2 & \cdots & a_{m+1} \\ W_1 & W_2 & & W_m \\ b_1 & b_2 & \cdots & b_{m+1} \end{pmatrix}.$$

Further, for any $i < j$ set $\mathbf{m}_{[i,j]} := \prod_{t=i}^j W_t$, where as above $W_t = z_{t,1} \cdots z_{t,s_t-1}$.

Proposition 4.23. *With respect to the DegRevLex order on $\mathbb{C}[u, \mathbf{z}]$,*

$$S(f_{ij}, f_{k\ell}) = \begin{cases} -b_k \mathbf{m}_{[k,\ell-1]} a_\ell a_i b_j + b_i \mathbf{m}_{[i,j-1]} a_j a_k b_\ell & \text{if } i < j < k < \ell, \\ -b_k \mathbf{m}_{[j,\ell-1]} a_\ell a_i b_j + b_i \mathbf{m}_{[i,k-1]} a_k b_\ell a_j & \text{if } i < k \leq j < \ell, \\ -\mathbf{m}_{[j,\ell-1]} a_\ell a_k b_j + a_j a_k b_\ell & \text{if } i = k < j < \ell, \\ b_i \mathbf{m}_{[i,k-1]} a_k b_\ell - b_k a_i b_\ell & \text{if } i < k < j = \ell, \\ b_i \mathbf{m}_{[i,k-1]} \mathbf{m}_{[\ell,j-1]} a_j a_k b_\ell - b_k a_\ell a_i b_j & \text{if } i < k < \ell < j. \end{cases}$$

Furthermore, for any i, j

$$S(f_{ij}, f) = -u a_i b_j + b_i \mathbf{m}_{[i,j-1]} a_j E.$$

Proof. In the case $i < j < k < \ell$, the S -polynomial $S(f_{ij}, f_{k\ell})$ equals

$$\begin{aligned} & \frac{b_i \mathbf{m}_{[i,j-1]} a_j \cdot b_k \mathbf{m}_{[k,\ell-1]} a_\ell}{-b_i \mathbf{m}_{[i,j-1]} a_j} f_{ij} - \frac{b_i \mathbf{m}_{[i,j-1]} a_j \cdot b_k \mathbf{m}_{[k,\ell-1]} a_\ell}{-b_k \mathbf{m}_{[k,\ell-1]} a_\ell} f_{k\ell} \\ &= -b_k \mathbf{m}_{[k,\ell-1]} a_\ell f_{ij} + b_i \mathbf{m}_{[i,j-1]} a_j f_{k\ell} \\ &= -b_k \mathbf{m}_{[k,\ell-1]} a_\ell (a_i b_j - b_i \mathbf{m}_{[i,j-\ell]} a_j) + b_i \mathbf{m}_{[i,j-1]} a_j (a_k b_\ell - b_k \mathbf{m}_{[k,\ell-1]} a_\ell) \\ &= -b_k \mathbf{m}_{[k,\ell-1]} a_\ell a_i b_j + b_i \mathbf{m}_{[i,j-1]} a_j a_k b_\ell. \end{aligned}$$

All other cases are similar. For the final claim, the S -polynomial $S(f_{ij}, f)$ equals

$$\begin{aligned} & \frac{u b_i \mathbf{m}_{[i,j-1]} a_j}{-b_i \mathbf{m}_{[i,j-1]} a_j} f_{ij} - \frac{u b_i \mathbf{m}_{[i,j-1]} a_j}{-u} f \\ &= -u f_{ij} + b_i \mathbf{m}_{[i,j-1]} a_j f \\ &= -u (a_i b_j - b_i \mathbf{m}_{[i,j-1]} a_j) + b_i \mathbf{m}_{[i,j-1]} a_j (E - u) \\ &= -u a_i b_j + b_i \mathbf{m}_{[i,j-1]} a_j E. \end{aligned} \quad \square$$

Definition 4.24. *A polynomial f is reducible by g to r , written $f \xrightarrow{g} r$, if $\text{LM}(g)$ divides some monomial m in f and*

$$r = f - \frac{\mu_m m}{\text{LT}(g)} \cdot g.$$

We say this is lead reducible if $\text{LM}(g) \mid \text{LM}(f)$, and

$$r = f - \frac{\text{LT}(f)}{\text{LT}(g)} \cdot g.$$

Definition 4.25. A polynomial f is reducible or lead reducible by a set $G = \{g_1, \dots, g_s\}$, denoted by $f \xrightarrow{G} r$, if

$$f = f_1 \xrightarrow{g_{i_1}} f_2 \xrightarrow{g_{i_2}} \dots \xrightarrow{g_{i_m}} f_m = r,$$

and if r cannot be reduced any further, then we call r the normal form or remainder of f modulo G .

For multivariate polynomials, the remainder is not unique and this leads us to the Gröbner basis theory. We will compute the Gröbner basis of $H = \text{QDet} + (E - u)$ using Buchberger's algorithm. Write \mathcal{S} for the set of generators of QDet given by all the quasiminors f_{ij} , together with $f = E - u$.

Example 4.26. For the group $\frac{1}{7}(1, 2)$, with matrix

$$\begin{pmatrix} z_{0,0} & z_{1,0} & z_{2,0} & z_{3,0} \\ & z_{1,1} & z_{2,1} & z_{3,1} \\ & & z_{2,2} & z_{3,2} \\ & & & z_{4,0} \end{pmatrix},$$

the ideal $H = \text{QDet} + (E - u)$ is generated by

$$\begin{aligned} f_{12} &:= z_{0,0}z_{2,1} - z_{1,1}z_{1,0} & f_{24} &:= z_{1,0}z_{4,0} - z_{2,1}z_{3,1}z_{3,0} \\ f_{13} &:= z_{0,0}z_{3,2} - z_{1,1}z_{2,0} & f_{34} &:= z_{2,0}z_{4,0} - z_{3,2}z_{3,1}z_{3,0} \\ f_{14} &:= z_{0,0}z_{4,0} - z_{1,1}z_{3,1}z_{3,0} & f &:= z_{0,0}z_{2,1}z_{3,2}z_{4,0} - u, \\ f_{23} &:= z_{1,0}z_{3,2} - z_{2,1}z_{2,0} \end{aligned}$$

and so $\mathcal{S} = \{f_{12}, f_{13}, f_{14}, f_{23}, f_{24}, f_{34}, f\}$.

Corollary 4.27. The S -polynomials in Proposition 4.23 are reduced to zero by the set \mathcal{S} .

Proof. In the case $i < j < k < \ell$, by 4.23 $S(f_{ij}, f_{k\ell}) = -b_k \mathbf{m}_{[k, \ell-1]} a_\ell a_i b_j + b_i \mathbf{m}_{[i, j-1]} a_j a_k b_\ell$, which has leading term $-b_k \mathbf{m}_{[k, \ell-1]} a_\ell a_i b_j$. This leading term is divisible by $\text{LT}(f_{k\ell})$ so

$$S(f_{ij}, f_{k\ell}) \xrightarrow{f_{k\ell}} S(f_{ij}, f_{k\ell}) - (a_i b_j) f_{k\ell} = b_i \mathbf{m}_{[i, j-1]} a_j a_k b_\ell - a_i b_j a_k b_\ell.$$

The leading term of the right hand side is $b_i \mathbf{m}_{[i, j-1]} a_j a_k b_\ell$, which is divisible by $\text{LT}(f_{ij})$, and thus

$$S(f_{ij}, f_{k\ell}) \xrightarrow{f_{k\ell}} b_i \mathbf{m}_{[i, j-1]} a_j a_k b_\ell - a_i b_j a_k b_\ell \xrightarrow{f_{ij}} 0.$$

The next four cases in Proposition 4.23 are very similar, and are summarised by

$$\begin{aligned} S(f_{ij}, f_{k\ell}) &\xrightarrow{f_{j\ell}} b_i \mathbf{m}_{[i, k-1]} a_j a_k b_\ell - a_j b_\ell a_i b_k \xrightarrow{f_{ik}} 0 && \text{if } i < k \leq j < \ell \\ S(f_{ij}, f_{k\ell}) &\xrightarrow{f_{j\ell}} 0 && \text{if } i = k < j < \ell \\ S(f_{ij}, f_{k\ell}) &\xrightarrow{f_{ik}} 0 && \text{if } i < k < j = \ell \\ S(f_{ij}, f_{k\ell}) &\xrightarrow{f_{ik}} -a_\ell b_j a_i b_k + a_i b_k b_\ell \mathbf{m}_{[\ell, j-1]} a_j \xrightarrow{f_{\ell j}} 0 && \text{if } i < k < \ell < j. \end{aligned}$$

Furthermore, the final case $S(f_{ij}, f) = -u a_i b_j + b_i \mathbf{m}_{[i, j-1]} a_j E$ has leading term $-u a_i b_j$. This is divisible by $\text{LT}(f)$, and so

$$S(f_{ij}, f) \xrightarrow{f} S(f_{ij}, f) - (a_i b_j) f = b_i \mathbf{m}_{[i, j-1]} a_j E - a_i b_j E.$$

The leading term of the right hand side is $b_i \mathbf{m}_{[i, j-1]} a_j E$, which is divisible by $\text{LT}(f_{ij})$, and thus

$$S(f_{ij}, f) \xrightarrow{f} b_i \mathbf{m}_{[i, j-1]} a_j E - a_i b_j E \xrightarrow{f_{ij}} 0. \quad \square$$

Corollary 4.28. \mathcal{S} is a Gröbner basis for $\text{QDet} + (E - u)$.

Proof. Since by Corollary 4.27 all the S -polynomials between elements of \mathcal{S} reduce to 0 modulo \mathcal{S} , this follows as an immediate consequence of Buchberger's criterion [B1, §2]. \square

4.5. Recovering the Artin component. For any group $\frac{1}{r}(1, a)$, the quiver of the reconstruction algebra is denoted Q . Recall from §3 that $\delta = (1, \dots, 1)$, and further $\mathcal{R} := \mathbb{C}[\text{Rep}(\mathbb{C}Q, \delta)]$ carries a natural action of $G := \prod_{q \in Q_0} \mathbb{C}^*$. The following shows that \mathcal{R}^G , which is constructed using only the quiver of the reconstruction algebra, is precisely the Artin component of $\frac{1}{r}(1, a)$.

Theorem 4.29. *For any group $\frac{1}{r}(1, a)$, there is an isomorphism $\mathcal{R}^G \cong \frac{\mathbb{C}[z]}{\text{QDet}(z)}$.*

Proof. By Proposition 4.3 there is a surjective homomorphism $\mathbb{C}[z] \xrightarrow{\varphi} \mathcal{R}^G$. By [S, §4], the kernel of φ is a toric ideal I_M of $\mathbb{C}[z]$. By Corollary 4.12, the columns of K are a spanning set L for the kernel $\varphi_{\mathbb{Z}}$ so $I_M = (I_L : P^\infty)$. By Corollary 4.14, $(I_L : P^\infty) = (\text{QDet} : P^\infty)$, and further $(\text{QDet} : P^\infty) = (\text{QDet} : E^\infty)$ by Lemma 4.19. As explained above Definition 4.21, the toric ideal I_M is thus obtained from eliminating u from a Gröbner basis of $\text{QDet} + (E - u)$, and thus by Corollary 4.28 by eliminating u from \mathcal{S} . Therefore, $I_M = (\text{QDet} : E^\infty) = \mathcal{S} \cap \mathbb{C}[z] = \text{QDet}(z)$. \square

5. SIMULTANEOUS RESOLUTION

In this section, the deformed reconstruction algebra is introduced, and is used to achieve simultaneous resolution.

5.1. The Deformed Reconstruction Algebra. In what follows, write l_φ for the number of the vertex associated to the tail of the arrow k_φ , and set $d_\varphi = l_\varphi - l_{\varphi-1}$. Recall that by convention $k_0 = c_{10}$ and $k_{e-2} = a_{n0}$.

Definition 5.1. *Given $r, a \in \mathbb{N}$ with $r > a > 1$ such that $(r, a) = 1$, and scalars $\boldsymbol{\lambda} \in \mathbb{C}^{\oplus \beta_1} \oplus \dots \oplus \mathbb{C}^{\oplus \beta_{e-2}}$, write $\boldsymbol{\lambda} = (\boldsymbol{\lambda}_1, \boldsymbol{\lambda}_2, \dots, \boldsymbol{\lambda}_{e-2})$ with $\boldsymbol{\lambda}_i = (\lambda_{i\beta_i-1}, \dots, \lambda_{i1}, \lambda_{i0})$. Then the deformed reconstruction algebra $A_{r,a,\boldsymbol{\lambda}}$ is defined to be the path algebra of the quiver Q associated to the Hirzebruch–Jung continued fraction expansion of $\frac{r}{a}$, subject to the following relations (which below, we refer to as the step i relations) for all i such that $1 \leq i \leq e - 2$.*

If $d_i = 0$, then

$$\begin{aligned} k_i C_{0l_i} - k_{i-1} A_{0l_{i-1}} &= \lambda_{i,1} \\ A_{0l_{i-1}} k_{i-1} - C_{0l_i} k_i &= \lambda_{i,0}. \end{aligned}$$

If $d_i > 0$, then

$$\begin{aligned} k_i C_{0l_i} - c_{l_i l_{i-1}} a_{l_i-1 l_i} &= \lambda_{i, \beta_i-1} \\ a_{l_i-1 l_i} c_{l_i l_{i-1}} - c_{l_i-1 l_i-2} a_{l_i-2 l_{i-1}} &= \lambda_{i, \beta_i-2} \\ &\vdots \\ a_{l_{i-1} l_{i-1}+1} c_{l_{i-1}+1 l_{i-1}} - k_{i-1} A_{0l_{i-1}} &= \lambda_{i,1} \\ A_{0l_{i-1}} k_{i-1} - C_{0l_i} k_i &= \lambda_{i,0}. \end{aligned}$$

To simplify, write

$$\Delta := \{ \boldsymbol{\lambda} \in \mathbb{C}^{\oplus \beta_1} \oplus \dots \oplus \mathbb{C}^{\oplus \beta_{e-2}} \mid \sum_{j=0}^{\beta_i-1} \lambda_{i,j} = 0, \forall i = 1, \dots, e-2 \}. \quad (5.A)$$

Below we will be most interested in the case where the parameters $\boldsymbol{\lambda}$ in Definition 5.1 belongs to Δ . This will correspond to the case $\boldsymbol{\lambda} \cdot \delta = 0$ in [CH], equivalently to the case $t = 0$ in symplectic reflection algebras [EG].

Remark 5.2. Let $r > 1$, and $a = 1$, and consider scalars $\boldsymbol{\lambda} \in (\mathbb{C}^{\oplus 2})^{\oplus e-2}$. Then the deformed reconstruction algebra $A_{r,1,\boldsymbol{\lambda}}$ is defined to be the path algebra of the quiver Q for $n = 1$, $\alpha_1 = r$ in §2.1, subject to the following relations

$$\begin{aligned} a_2 c_1 - a_1 c_2 = \lambda_{1,1} \quad \text{and} \quad c_1 a_2 - c_2 a_1 = \lambda_{1,0} \\ k_1 c_1 - a_2 c_2 = \lambda_{2,1} \quad \text{and} \quad c_1 k_1 - c_2 a_2 = \lambda_{2,0} \\ k_{i-1} c_1 - k_{i-2} c_2 = \lambda_{i,1} \quad \text{and} \quad c_1 k_{i-1} - c_2 k_{i-2} = \lambda_{i,0} \quad \forall 3 \leq i \leq e-2. \end{aligned}$$

Example 5.3. In the case $\lambda \in \Delta$, the reconstruction algebra of Type $A_{7,3,\lambda}$ associated to $[3, 2, 2]$ is the path algebra of the quiver in Example 2.1 subject to the relations

$$\begin{aligned} k_1 C_{01} &= c_{10} a_{01} + \lambda_{11} & a_{30} c_{03} &= c_{32} a_{23} + \lambda_{23} \\ C_{01} k_1 &= a_{01} c_{10} - \lambda_{11} & a_{23} c_{32} &= c_{21} a_{12} + \lambda_{22} \\ & & a_{12} c_{21} &= k_1 a_{01} + \lambda_{21} \\ & & a_{01} k_1 &= c_{03} a_{30} - \sum_{j=1}^3 \lambda_{2,j}. \end{aligned}$$

Example 5.4. In the case $\lambda \in \Delta$, the reconstruction algebra of Type $A_{165,107,\lambda}$ associated to $[2, 3, 2, 4, 3, 2, 2]$ is the path algebra of the quiver in Example 2.2 subject to the relations

$$\begin{aligned} k_1 C_{02} &= c_{21} a_{12} + \lambda_{12} & k_3 C_{04} &= k_2 A_{04} + \lambda_{31} & a_{70} c_{07} &= c_{76} a_{67} + \lambda_{53} \\ a_{12} c_{21} &= c_{10} a_{01} + \lambda_{11} & A_{04} k_2 &= C_{04} k_3 - \lambda_{31} & a_{67} c_{76} &= c_{65} a_{56} + \lambda_{52} \\ a_{01} c_{10} &= C_{02} k_1 - \sum_{j=1}^2 \lambda_{1,j} & & & a_{56} c_{65} &= k_4 A_{05} + \lambda_{51} \\ & & k_4 C_{05} &= c_{54} a_{45} + \lambda_{42} & A_{05} k_4 &= c_{07} a_{70} - \sum_{j=1}^3 \lambda_{5,j}. \\ k_2 C_{04} &= c_{43} a_{34} + \lambda_{23} & a_{45} c_{54} &= k_3 A_{04} + \lambda_{41} & & \\ a_{34} c_{43} &= c_{32} a_{23} + \lambda_{22} & A_{04} k_3 &= C_{05} k_4 - \sum_{j=1}^2 \lambda_{4,j} & & \\ a_{23} c_{32} &= k_1 A_{02} + \lambda_{21} & & & & \\ A_{02} k_1 &= C_{04} k_2 - \sum_{j=1}^3 \lambda_{2,j} & & & & \end{aligned}$$

5.2. Moduli of Deformed Reconstruction Algebras. With respect to the ordering of the vertices as in Section 2, fix for the rest of this paper the dimension vector $\delta = (1, 1, \dots, 1)$, and fix the generic King stability condition $\vartheta = (-n, 1, \dots, 1)$. Recall that

$$\text{Rep}(A_{r,a,\lambda}, \delta) //_{\vartheta} \text{GL} := \text{Proj} \left(\bigoplus_{n \geq 0} \mathbb{C}[\text{Rep}(A_{r,a,\lambda}, \delta)]^{G, \vartheta^n} \right).$$

Remark 5.5. If $\lambda \notin \Delta$, then $\text{Rep}(A_{r,a,\lambda}, \delta) = \emptyset$. Indeed, given $\lambda \notin \Delta$, some $\sum_{j=0}^{\beta_i-1} \lambda_{i,j} \neq 0$. Now if $M \in \text{Rep}(A_{r,a,\lambda}, \delta)$, then its linear maps between vertices are scalars, which have to satisfy the relations for $A_{r,a,\lambda}$. Now scalars commute, and thus summing the step i relations gives $\sum_{j=0}^{\beta_i-1} \lambda_{i,j} = 0$, which is a contradiction. This is why below we always assume that $\lambda \in \Delta$.

Definition 5.6. Let $\lambda \in \Delta$, and $a > 1$. For $0 \leq t \leq n$, define the open set W_t in $\text{Rep}(A_{r,a,\lambda}, \delta) //_{\vartheta} \text{GL}$ as follows: W_0 is defined by the condition $C_{01} \neq 0$, W_n by the condition $A_{0n} \neq 0$, and for $1 \leq t \leq n-1$, W_t is defined by the conditions $C_{0t+1} \neq 0$ and $A_{0t} \neq 0$. In the degenerate case when $a = 1$, define the open set W_1 by the condition $a_1 \neq 0$, and W_2 by the condition $a_2 \neq 0$.

As in [W1, 4.3], $\{W_t \mid 0 \leq t \leq n\}$ forms an open cover of $\text{Rep}(A_{r,a,\lambda}, \delta) //_{\vartheta} \text{GL}$.

Proposition 5.7. For any $A_{r,a,\lambda}$ with $a > 1$ and $\lambda \in \Delta$, the following statements hold

- (1) Each representation in W_0 is determined by $(c_{10}, a_{01}) \in \mathbb{C}^2$.
- (2) Each representation in W_t is determined by $(c_{t+1t}, a_{tt+1}) \in \mathbb{C}^2$.
- (3) Each representation in W_n is determined by $(c_{0n}, a_{n0}) \in \mathbb{C}^2$.

Thus every open set W_t in the cover is just affine space \mathbb{A}^2 .

Proof. (1) As in [W1, 4.3], we can set $c_{0n} = c_{nn-1} = \dots = c_{21} = 1$. First, consider the Step 1 relations.

If $d_1 = 0$, then the relations become

$$\begin{aligned} k_1 - c_{10} a_{01} &= \lambda_{1,1} \\ a_{01} c_{10} - k_1 &= -\lambda_{1,1}. \end{aligned}$$

Since a_{01}, c_{10}, k_1 are scalars, the bottom follows from the top and k_1 is in terms of (c_{10}, a_{01}) with no further relations between c_{10} and a_{01} . If $d_1 > 0$, then

$$\begin{aligned} k_1 - a_{l_1-1l_1} &= \lambda_{1,\beta_1-1} \\ a_{l_1-1l_1} - a_{l_1-2l_1-1} &= \lambda_{1,\beta_1-2} \\ &\vdots \\ a_{12} - c_{10}a_{01} &= \lambda_{1,1} \\ a_{10}c_{10} - k_1 &= - \sum_{j=1}^{\beta_1-1} \lambda_{1,j}. \end{aligned}$$

The last relation follows by summing the other relations. It is furthermore clear that k_1 and all the anticlockwise arrows between vertex 1 and l_1 are determined by (c_{10}, a_{01}) .

By induction, we can assume that all the anticlockwise arrows between vertex 0 and l_i are determined by (c_{10}, a_{01}) , as are k_1, \dots, k_i and furthermore the Step $1, \dots, i$ relations hold with no further relations between c_{10} and a_{01} .

We next establish the induction step, by considering the Step $i+1$ relations. If $d_{i+1} = 0$ then the Step $i+1$ relations become

$$\begin{aligned} k_{i+1} - k_i A_{0l_i} &= \lambda_{i+1,1} \\ A_{0l_i} k_i - k_{i+1} &= -\lambda_{i+1,1}. \end{aligned}$$

The bottom comes from the top and k_{i+1} is in terms of A_{0l_i} and k_i , which by induction are determined by (c_{10}, a_{01}) . If $d_{i+1} > 0$, then

$$\begin{aligned} k_{i+1} - a_{l_{i+1}-1l_{i+1}} &= \lambda_{i+1,\beta_{i+1}-1} \\ a_{l_{i+1}-1l_{i+1}} - a_{l_{i+1}-2l_{i+1}-1} &= \lambda_{i+1,\beta_{i+1}-2} \\ &\vdots \\ a_{l_i,l_{i+1}} - k_i A_{0l_i} &= \lambda_{i+1,1} \\ A_{0l_i} k_i - k_{i+1} &= - \sum_{j=1}^{\beta_{i+1}-1} \lambda_{i+1,j}. \end{aligned}$$

The last relation follows by summing the other relations. It is furthermore clear that k_{i+1} and all the anticlockwise arrows between vertex l_i and l_{i+1} are determined by (c_{10}, a_{01}) . Thus by induction, all arrows are determined by $(c_{10}, a_{01}) \in \mathbb{C}^2$.

(2) As in [W1, 4.3], we can set $c_{0n} = \dots = c_{t+2t+1} = 1 = a_{01} = \dots = a_{t-1t}$ and show that all the arrows are determined by (c_{t+1t}, a_{tt+1}) . Let $s-1 := \max\{j \mid l_j \leq t\}$, and $s := \min\{j \mid l_j \geq t+1\}$. We start with the anticlockwise direction from vertex l_s to vertex 0, and then clockwise from vertex l_{s-1} to vertex 0 in the diagram below.

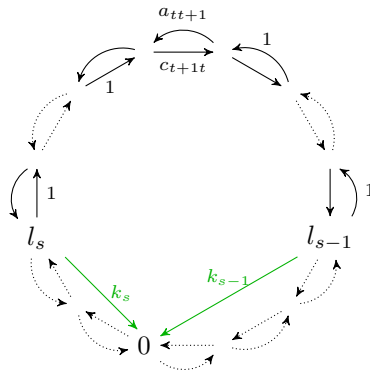

First consider the Step s relations. We claim that k_{s-1} , k_s and all the arrows in between l_{s-1} and l_s are determined by (c_{t+1t}, a_{tt+1}) . Since $d_s > 0$, the relations become

$$\begin{aligned}
k_s - a_{l_s-1l_s} &= \lambda_{s,\beta_s-1} \\
a_{l_s-1l_s} - a_{l_s-2l_s-1} &= \lambda_{s,\beta_s-2} \\
&\vdots \\
a_{t+1t+2} - c_{t+1t}a_{tt+1} &= \lambda_{s,(t+1)-l_{s-1}+1} \\
a_{tt+1}c_{t+1t} - c_{tt-1} &= \lambda_{s,(t+1)-l_{s-1}} \\
&\vdots \\
c_{l_{s-1}+2l_{s-1}+1} - c_{l_{s-1}+1l_{s-1}} &= \lambda_{s,2} \\
c_{l_{s-1}+1l_{s-1}} - k_{s-1} &= \lambda_{s,1} \\
k_{s-1} - k_s &= - \sum_{j=1}^{\beta_s-1} \lambda_{s,j}.
\end{aligned}$$

The last relation follows by summing the other relations. It is furthermore clear that k_s , k_{s-1} with all the anticlockwise and clockwise arrows between vertex l_s and l_{s-1} are determined by (c_{t+1t}, a_{tt+1}) , and there are no additional relations between c_{t+1t} and a_{tt+1} .

Anticlockwise. Hence by induction, we can assume that all the anticlockwise arrows between vertex l_s and l_p are determined by (c_{t+1t}, a_{tt+1}) , as are k_s, \dots, k_p and furthermore the Step s, \dots, p relations hold with no further relations between c_{t+1t} and a_{tt+1} .

We next establish the induction step, by considering the Step $p+1$ relations. If $d_{p+1} = 0$, then the relations become

$$\begin{aligned}
k_{p+1} - k_p A_{0l_p} &= \lambda_{p+1,1} \\
A_{0l_p} k_p - k_{p+1} &= -\lambda_{p+1,1}.
\end{aligned}$$

and therefore k_{p+1} can be determined by (c_{t+1t}, a_{tt+1}) . If $d_{p+1} > 0$, then

$$\begin{aligned}
k_{p+1} - a_{l_{p+1}-1l_{p+1}} &= \lambda_{p+1,\beta_{p+1}-1} \\
a_{l_{p+1}-1l_{p+1}} - a_{l_{p+1}-2l_{p+1}-1} &= \lambda_{p+1,\beta_{p+1}-2} \\
&\vdots \\
a_{l_p l_{p+1}} - k_p A_{0l_p} &= \lambda_{p+1,1} \\
A_{0l_p} k_p - k_{p+1} &= - \sum_{j=1}^{\beta_{p+1}-1} \lambda_{p+1,j}.
\end{aligned}$$

The last relation follows by summing the other relations. It is furthermore clear that k_{p+1} and all the anticlockwise arrows between vertex l_p and l_{p+1} are determined by (c_{t+1t}, a_{tt+1}) , and there are no additional relations between c_{t+1t} and a_{tt+1} .

Clockwise. Similar to the above, we can assume by induction that all the clockwise arrows between vertex l_{s-1} and l_{q-1} are again determined by (c_{t+1t}, a_{tt+1}) , as are k_{s-1}, \dots, k_{q-1} and furthermore the Step q, \dots, s relations hold with no further relations between c_{t+1t} and a_{tt+1} .

We then establish the induction step, by considering the Step $q-1$ relations. If $d_{q-1} = 0$, then the relations become

$$\begin{aligned}
k_{q-1} C_{0l_{q-1}} - k_{q-2} &= \lambda_{q-1,1} \\
k_{q-2} - C_{0l_{q-1}} k_{q-1} &= -\lambda_{q-1,1}.
\end{aligned}$$

and therefore k_{q-2} can be determined by (c_{t+1t}, a_{tt+1}) . If $d_{q-1} > 0$, then

$$\begin{aligned} k_{q-1}C_{0l_{q-1}} - c_{l_{q-1}l_{q-1}-1} &= \lambda_{q-1, \beta_{q-1}-1} \\ c_{l_{q-1}l_{q-1}-1} - c_{l_{q-1}-1l_{q-1}-2} &= \lambda_{q-1, \beta_{q-1}-2} \\ &\vdots \\ c_{l_{q-2}+1l_{q-2}} - k_{q-2} &= \lambda_{q-1, 1} \\ k_{q-2} - C_{0l_{q-1}}k_{q-1} &= - \sum_{j=1}^{\beta_{q-1}-1} \lambda_{q-1, j}. \end{aligned}$$

The last relation follows by summing the other relations. It is furthermore clear that k_{q-2} and all the clockwise arrows between vertex l_{q-1} and l_{q-2} are determined by (c_{t+1t}, a_{tt+1}) .

(3) The proof for W_n is very similar to W_0 but instead starts at the Step $e-2$ relations and work backwards to the Step 1 relations. Thus by induction, all arrows are determined by $(c_{t+1t}, a_{tt+1}) \in \mathbb{C}^2$. \square

Remark 5.8. In the degenerate case when $a = 1$, a similar proof of Proposition 5.7 shows that each representation in W_1 is determined by $(c_1, a_2) \in \mathbb{C}^2$, whilst each representation in W_2 is determined by $(c_1, a_1) \in \mathbb{C}^2$. Again, even in the degenerate case $a = 1$, each open set W_i in the open cover is just affine space \mathbb{A}^2 .

Corollary 5.9. For any $A_{r,a,\lambda}$, for the fixed $\vartheta = (-n, 1, \dots, 1)$,

$$\text{Rep}(A_{r,a,\lambda}, \delta) //_{\vartheta} \text{GL} \rightarrow \text{Rep}(A_{r,a,\lambda}, \delta) // \text{GL}$$

is a resolution of singularities.

Proof. The morphism is projective birational by construction, and the fact that the variety $\text{Rep}(A_{r,a,\lambda}, \delta) //_{\vartheta} \text{GL}$ is regular follows from Proposition 5.7, since each chart W_t in the open cover is regular. \square

5.3. Simultaneous Resolution. Write $(\alpha_{0,0}, \alpha_{1,0}, \dots, \alpha_{1,\beta_1-1}, \dots, \alpha_{e-1,0})$ for the point in $\text{Spec} \left(\frac{\mathbb{C}[z]}{\text{QDet}(z)} \right)$ corresponding to the maximal ideal $(z_{0,0} - \alpha_{0,0}, \dots, z_{e-1,0} - \alpha_{e-1,0})$. Let Q be the quiver of the reconstruction algebra, and consider the map

$$\pi: \text{Rep}(\mathbb{C}Q, \delta) // \text{GL} = \frac{\mathbb{C}[z]}{\text{QDet}(z)} \rightarrow \Delta,$$

defined by taking

$$\begin{array}{c} (\alpha_{0,0}, \alpha_{1,0}, \dots, \alpha_{1,\beta_1-1}, \dots, \alpha_{e-1,0}) \\ \downarrow \\ (\alpha_{i,0} - \alpha_{i,1}, \alpha_{i,1} - \alpha_{i,2}, \dots, \alpha_{i,\beta_i-1} - \alpha_{i,0})_{i=1}^{e-2}. \end{array}$$

Example 5.10. For the group $\frac{1}{7}(1, 3)$ as in Example 2.1 and 3.3, the morphism

$$\text{Rep}(\mathbb{C}Q, \delta) // \text{GL} \rightarrow \Delta$$

is given by

$$\begin{array}{c} (\alpha_{0,0}, \alpha_{1,0}, \alpha_{1,1}, \alpha_{2,0}, \alpha_{2,1}, \alpha_{2,2}, \alpha_{2,3}, \alpha_{3,0}) \\ \downarrow \\ ((\alpha_{1,0} - \alpha_{1,1}, \alpha_{1,1} - \alpha_{1,0}), (\alpha_{2,0} - \alpha_{2,1}, \alpha_{2,1} - \alpha_{2,2}, \alpha_{2,2} - \alpha_{2,3}, \alpha_{2,3} - \alpha_{2,0})). \end{array}$$

The fibre above $((\lambda_{1,1}, \lambda_{1,0}), (\lambda_{2,3}, \lambda_{2,2}, \lambda_{2,1}, \lambda_{2,0})) \in \Delta$ is the zero locus of

$$\begin{aligned} z_{1,0} - z_{1,1} &= \lambda_{1,1} & z_{2,0} - z_{2,1} &= \lambda_{23} \\ z_{1,1} - z_{1,0} &= \lambda_{1,0} = -\lambda_{1,1} & z_{2,1} - z_{2,2} &= \lambda_{22} \\ & & z_{2,2} - z_{2,3} &= \lambda_{21} \\ & & z_{2,3} - z_{2,0} &= \lambda_{20} = -\lambda_{21} - \lambda_{22} - \lambda_{23}, \end{aligned}$$

which is $\text{Rep}(A_{7,3,\lambda}, \delta) // \text{GL}$.

Remark 5.11. The fibre above a point $\lambda \in \Delta$ is precisely $\text{Rep}(A_{r,a,\lambda}, \delta) // \text{GL}$. Indeed, the fibre above $\lambda \in \Delta$ is the zero locus of

$$\begin{aligned} z_{i,0} - z_{i,1} &= \lambda_{i,\beta_i-1} \\ z_{i,1} - z_{i,2} &= \lambda_{i,\beta_i-2} \\ &\vdots \\ z_{i,\beta_i-1} - z_{i,0} &= -\sum_{j=1}^{\beta_i-1} \lambda_{i,j} \end{aligned}$$

for all i such that $1 \leq i \leq e-2$. By (3.A) and Definition 5.1, this equals $\text{Rep}(A_{r,a,\lambda}, \delta) // \text{GL}$.

Theorem 5.12. *The diagram*

$$\begin{array}{ccc} \text{Rep}(\mathbb{C}Q, \delta) //_{\vartheta} \text{GL} & \longrightarrow & \text{Rep}(\mathbb{C}Q, \delta) // \text{GL} \\ & \searrow \phi & \downarrow \pi \\ & & \Delta \end{array}$$

is a simultaneous resolution of singularities in the sense that the morphism ϕ is smooth, and π is flat.

Proof. Write ϕ for the composition

$$Y = \text{Rep}(\mathbb{C}Q, \delta) //_{\vartheta} \text{GL} \rightarrow \text{Rep}(\mathbb{C}Q, \delta) // \text{GL} \rightarrow \Delta.$$

We first claim that ϕ is flat. Since (1) Δ is regular, (2) Y is regular (so Cohen-Macaulay) since $\mathbb{C}Q$ is free, so the analogue of the open charts W_t in Definition 5.6 are clearly all affine spaces, (3) \mathbb{C} is algebraically closed so ϕ takes closed points of Y to closed points of Δ , and (4) for every closed point $\lambda \in \Delta$, for the same reason as in Remark 5.11 the fibre $\phi^{-1}(\lambda)$ is $\text{Rep}(A_{r,a,\lambda}, \delta) //_{\vartheta} \text{GL}$ which is always two-dimensional by Proposition 5.7, it follows from [M, Corollary to 23.1] that ϕ is flat.

Now as in [L, 3.35] to show that ϕ is smooth, we just require smoothness (equivalently regularity, as we are working over \mathbb{C}) at closed points of fibres above closed points $\lambda \in \Delta$. But as above $\phi^{-1}(\lambda)$ is $\text{Rep}(A_{r,a,\lambda}, \delta) //_{\vartheta} \text{GL}$, which is regular at all closed points by Proposition 5.7. Thus ϕ is a smooth morphism, as required.

Finally, the above can be adapted to show that π is flat. We have that $\pi^{-1}(\lambda) = \text{Rep}(A_{r,a,\lambda}, \delta) // \text{GL}$, which is always two-dimensional as a consequence of the resolution of its singularities computed in Proposition 5.7. Thus we can still appeal to [M, Corollary to 23.1]. \square

Remark 5.13. The choice of $\vartheta = (-n, 1, \dots, 1)$ is important. For Kleinian singularities, it is possible to use any generic stability [CS]. In the more general setting here, other stability parameters do not give simultaneous resolution on the nose, as the following Example demonstrates.

Example 5.14. Consider the group $\frac{1}{3}(1, 1)$, with the generic stability condition $\vartheta_2 = (1, -1)$ and the dimension vector $(1, 1)$. Then $\text{Rep}(A_{r,a,0}, \delta) //_{\vartheta_2} \text{GL}$ is covered by three affine charts, namely $U_0 = (a_1 \neq 0)$, $U_1 = (a_2 \neq 0)$, and $U_2 = (k_1 \neq 0)$. If we consider the first chart U_0 , we can base change such that $a_1 = 1$, which gives

$$\begin{array}{ccc} & \xrightarrow{c_1} & \\ & \xrightarrow{c_2} & \\ \mathbb{C} & \xrightarrow{1} & \mathbb{C} \\ & \xleftarrow{a_2} & \\ & \xleftarrow{k_1} & \end{array}$$

subject to relations

$$\begin{aligned} c_1 a_2 &= c_2 & a_2 c_1 &= c_2 \\ c_1 k_1 &= c_2 a_2 & k_1 c_1 &= a_2 c_2. \end{aligned}$$

This chart is parameterised by the variables c_1 , a_2 , k_1 , subject to the relation $c_1 k_1 = c_1 a_2^2$, i.e. $c_1(k_1 - a_2^2) = 0$, which is singular. Thus the fibre $\text{Rep}(\mathbb{C}Q, \delta) //_{\mathfrak{S}_2} \text{GL}$ above the origin of the corresponding ϕ is singular, and so is not a simultaneous resolution.

REFERENCES

- [A] M. Artin, *Algebraic construction of Brieskorn's resolutions*, J. Algebra **29** (1974), 330–348. [1](#)
- [B1] B. Buchberger, *A theoretical basis for the reduction of polynomials to canonical forms*, ACM SIGSAM Bull **10** (1976), no. 3, 19–29. [18](#)
- [B2] E. Brieskorn, *Die Auflösung der rationalen Singularitäten holomorpher Abbildungen. (German)*, Math. Ann. **178** (1968), 255–270. [1](#)
- [B3] E. Brieskorn, *Singular elements of semi-simple algebraic groups*, Actes du Congrès International des Mathématiciens (Nice, 1970), Tome 2, (1971), 279–284. [1](#)
- [BSR] A. M. Bigatti, R. Scala, L. Robbiano, *Computing toric ideals*, J. Symbolic Comput. **27** (1999), no. 4, 351–365. [15](#), [16](#)
- [CH] W. Crawley-Boevey, M. P. Holland *Noncommutative deformations of Kleinian singularities*, Duke Math. J. **92** (1998), no. 3, 605–635. [1](#), [2](#), [19](#)
- [CS] H. Cassens, P. Slodowy, *On Kleinian singularities and quivers*, Progr. Math. **162** (1998), no. 4, 263–288. [1](#), [24](#)
- [DW] W. Donovan, M. Wemyss, *Noncommutative deformations and flops*, Duke Math. J. **165** (2016), no. 8, 1397–1474. [1](#)
- [EG] P. Etingof, V. Ginzburg, *Symplectic reflection algebras, Calogero-Moser space, and deformed Harish-Chandra homomorphism*, Invent. Math. **147** (2002), no. 2, 243–348. [19](#)
- [K] P. B. Kronheimer, *The construction of ALE spaces as hyper-Kähler quotients*, J. Differential Geom. **29** (1989), no. 3, 665–683. [1](#)
- [L] Q. Liu, *Algebraic geometry and arithmetic curves*, Oxford Graduate Texts in Mathematics, Oxford University Press, Oxford, (2002), no. 6, xvi+576 pp. ISBN: 0-19-850284-2. [24](#)
- [M] H. Matsumura, *Commutative ring theory. Translated from the Japanese by M. Reid. Second edition*, Cambridge Studies in Advanced Mathematics, Cambridge University Press, Cambridge, (1989), no. 8, xiv+320 pp. ISBN: 0-521-36764-6 13-01. [24](#)
- [MTFGJKP] D. Maclagan, R. R. Thomas, S. Faridi, L. Gold, A. V. Jayanthan, A. Khetan, T. Puthenpura, *Computational algebra and combinatorics of toric ideals*, Commutative algebra and combinatorics, Part I: vi+106 pp. Ramanujan Math. Soc. Lect. Notes Ser. Ramanujan Math. Soc. Mysore, **4** (2007). [15](#)
- [R1] O. Riemenschneider, *Deformations of rational singularities and their resolutions*, Rice Univ. Stud. **59** (1973), no. 1, 119–130. [1](#)
- [R2] O. Riemenschneider, *Deformationen von Quotientensingularitäten (nach zyklischen Gruppen). (German)*, Math. Ann. **209** (1974), no. 3, 211–248. [4](#)
- [R3] O. Riemenschneider, *Die Invarianten der endlichen Untergruppen von $\text{GL}(2, \mathbb{C})$* , Math. Z. **153** (1977), no. 1, 37–50. [4](#)
- [R4] O. Riemenschneider, *Cyclic quotients surface singularities: constructing the Artin Component via the McKay-Quiver*, Singularities and complex analytic geometry (Japanese) (Kyoto, 1997). Surikaiseikikenkyusho Kokyuroku, (1998), no. 1033, 163–171. [1](#), [5](#), [8](#)
- [S] B. Sturmfels, *Grobner bases and convex polytopes*, University Lecture Series, 8. American Mathematical Society, Providence, RI, xii+162 pp. ISBN: 0-8218-0487-1, 13P10 (14M25 52B20). [9](#), [19](#)
- [V2] M. Van den Bergh, *Non-commutative crepant resolutions*, The legacy of Niels Henrik Abel, Springer, Berlin, (2004), 749–770. [1](#)
- [W1] M. Wemyss, *Reconstruction Algebras of Type A*, Trans. Amer. Math. Soc. **363** (2011), no. 6, 3101–3132. [2](#), [4](#), [8](#), [20](#), [21](#)
- [W2] J. Wunram, *Reflexive modules on quotient surface singularities*, Math. Ann. **279** (1988), no. 4, 583–598. [2](#)

BRIAN MAKONZI, DEPARTMENT OF MATHEMATICS, MAKERERE UNIVERSITY, P.O BOX 7260 KAMPALA, UGANDA & THE MATHEMATICS AND STATISTICS BUILDING, UNIVERSITY OF GLASGOW, UNIVERSITY PLACE, GLASGOW, G12 8QQ, UK

Email address: mckonzi@gmail.com, 2579843M@student.gla.ac.uk