

THE GRASSMANNIAN OF 3-PLANES IN \mathbb{C}^8 IS SCHÖN

DANIEL COREY AND DANTE LUBER

ABSTRACT. We prove that the open subvariety $\text{Gr}_0(3, 8)$ of the Grassmannian $\text{Gr}(3, 8)$ determined by the nonvanishing of all Plücker coordinates is schön, i.e., all of its initial degenerations are smooth. Furthermore, we find an initial degeneration that has two connected components, and show that the remaining initial degenerations, up to symmetry, are irreducible. As an application, we prove that the Chow quotient of $\text{Gr}(3, 8)$ by the diagonal torus of $\text{PGL}(8)$ is the log canonical compactification of the moduli space of 8 lines in \mathbb{P}^2 , resolving a conjecture of Hacking, Keel, and Tevelev. Along the way we develop various techniques to study finite inverse limits of schemes.

MSC 2020: 14T90 (primary), 05E14, 14C05, 52B40 (secondary)

Keywords: Chow quotient, Grassmannian, matroid, tight span

1. INTRODUCTION

A closed subvariety of an algebraic torus is *schön* if all of its initial degenerations—flat degenerations arising via Gröbner theory—are smooth. This notion was introduced by Tevelev in his influential paper [37], and admits this characterization by Helm and Katz [15]. Schön subvarieties of tori satisfy many desirable properties. Their tropical compactifications are schön compactifications, in particular they are normal and have toroidal singularities. Notions from birational geometry, like log minimality and ampleness of the log canonical divisor, admit tropical characterizations for schön subvarieties and their schön compactifications, respectively [13]. Some notable examples include nondegenerate hypersurfaces [39, 40] (whose study predates the notion of schönness), complements of hyperplane arrangements, open del Pezzo surfaces, and moduli spaces of marked del Pezzo surfaces [13].

Consider the Grassmannian $\text{Gr}(r, n)$ of r -planes in \mathbb{K}^n , where \mathbb{K} is an algebraically closed field, and let $\text{Gr}_0(r, n)$ be the open locus of $\text{Gr}(r, n)$ defined by the nonvanishing of all Plücker coordinates. Its tropicalization $\text{TGr}_0(r, n)$ parameterizes all tropical linear spaces realizable over a valued field extension of \mathbb{K} [28, Theorem 4.3.17], so $\text{TGr}_0(r, n)$, and therefore the initial degenerations of $\text{Gr}_0(r, n)$, depend on the characteristic of \mathbb{K} . For this reason, we assume that $\mathbb{K} = \mathbb{C}$ throughout. The Grassmannian $\text{Gr}_0(r, n)$ is known to be schön when $(r, n) = (2, n)$ [37], $(3, 6)$ [26] and $(3, 7)$ [6].

Theorem 1.1. *The Grassmannian $\text{Gr}_0(3, 8)$ is schön.*

Remark 1.2. The initial degenerations of Grassmannian $\text{Gr}_0(3, 8)$ are isomorphic, up to a torus factor, to those of the moduli space $X(3, 8)$ parameterizing isomorphism classes of 8 hyperplanes in \mathbb{P}^2 lying in general position. See Formula 7.1. In particular, $\text{Gr}_0(3, 8)$ is schön if and only if $X(3, 8)$ is schön. In [33], Schock develops a theory of quasilinear varieties. Schock proves that a quasilinear variety X is schön and the strata of any schön

compactification of X are irreducible. Schock also proposes a proof that $X(3, 8)$ is quasilinear, and hence schön, but this argument contains a critical gap. By Theorem 1.3, $X(3, 8)$ has an initial degeneration that is disconnected, and hence $X(3, 8)$ is not quasilinear.

The tropical Grassmannian $\text{TGr}_0(r, n)$ lies in a larger space $\text{Dr}(r, n)$ called the *Dressian*, which parameterizes *all* tropical linear spaces [17, 34]. Initially studied by Lafforgue [24], to a $w \in \text{Dr}(r, n)$ is associated a finite inverse limit $\text{Gr}(w)$ of thin Schubert cells parameterized by the induced matroidal subdivision of the hypersimplex. When $w \in \text{TGr}_0(r, n)$, we may also form the w -initial degeneration $\text{in}_w \text{Gr}_0(r, n)$. We use in an essential way the main theorem of [6], which asserts that, for any $w \in \text{TGr}_0(r, n)$, there is a closed immersion

$$\text{in}_w \text{Gr}_0(r, n) \hookrightarrow \text{Gr}(w).$$

We deduce Theorem 1.1 from a stronger result, that when $(r, n) = (3, 8)$, the above maps are isomorphisms, and the limits $\text{Gr}(w)$ are smooth. Thus, while the statement of this theorem is geometric, the proof relies on techniques from matroid theory, commutative algebra (computing the coordinate rings of thin Schubert cells and morphisms between them) and polyhedral complexes (regular subdivisions of the hypersimplex and their tight-spans). Given the connection between initial degenerations of $\text{Gr}_0(r, n)$ and thin Schubert cells (the collection of which satisfies Murphy's Law by Mnëv universality), it is expected that $\text{Gr}_0(r, n)$ is not, in general, schön, although this remains an open problem.

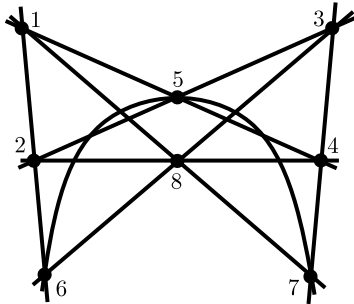

FIGURE 1.1. The matroid Q_{sp}

Next, we study the connectedness properties of the initial degenerations of $\text{Gr}_0(3, 8)$. Interestingly, they are not all connected. Let Q_{sp} be the rank-3 matroid from Figure 1.1, i.e., each 3-element set not connected by a (possibly curved) line is a basis. This is the unique (up to the action of the symmetric group \mathfrak{S}_8) sparse-paving rank-3 matroid on [8] with 8 nonbases (the maximum possible). We show in §4.2 that Q_{sp} is not realizable over \mathbb{R} , but over $\mathbb{Q}(\sqrt{-3})$. Denote by C_{sp} the cone of $\text{TGr}_0(3, 8)$ containing the corank vector of Q_{sp} in its relative interior.

Theorem 1.3. *For any w in the relative interior of a cone in the \mathfrak{S}_8 -orbit of C_{sp} , the initial degeneration $\text{in}_w \text{Gr}_0(3, 8)$ has 2 connected components.*

Up to \mathfrak{S}_8 -symmetry, this is the only non-connected initial degeneration of $\text{Gr}_0(3, 8)$.

Theorem 1.4. *If $w \in \text{TGr}_0(3, 8)$ is not in the relative interior of a cone in the \mathfrak{S}_8 -orbit of C_{sp} , then $\text{in}_w \text{Gr}_0(3, 8)$ is irreducible.*

We apply these results to study the Chow quotient compactification of $X(r, n)$, the moduli space of projective equivalence classes of n marked hyperplanes of \mathbb{P}^{r-1} in linear general position. The diagonal torus of $\mathrm{GL}(n)$ acts on \mathbb{C}^n by scaling coordinates, and this induces an action of the diagonal torus $H \subset \mathrm{PGL}(n)$ on $\mathrm{Gr}(r, n)$. This action is free on $\mathrm{Gr}_0(r, n)$, and $X(r, n)$ is identified with the quotient $\mathrm{Gr}_0(r, n)/H$ by the Gelfand-MacPherson correspondence [11]. The space $X(2, n)$ is also known as $M_{0,n}$, the moduli space of smooth rational n -marked curves.

A natural candidate to compactify $X(r, n)$ is given by the Chow quotient $\mathrm{Gr}(r, n)//H$, studied by Kapranov [19], where he demonstrates that the Grothendieck-Knudsen moduli space of genus 0, stable, n -marked curves $\overline{M}_{0,n}$ is isomorphic to $\mathrm{Gr}(2, n)//H$. This is also the log-canonical compactification of $M_{0,n}$ [22]. Keel and Tevelev show that $\mathrm{Gr}(r, n)//H$ is usually not log canonical, failing already for $(r, n) = (3, 9)$ [23]. With Hacking, they conjecture [*loc. cit.*, Conjecture 1.6] that it is log canonical when $(r, n) = (2, n), (3, 6), (3, 7)$, and $(3, 8)$. The conjecture is known in the first 4 cases, by Keel and McKernan (mentioned above), Luxton [26], and the first author [6], respectively. Using Theorems 1.1, 1.3 and 1.4, and a result of Schock [33, Proposition 7.9], we prove the $(3, 8)$ case.

Theorem 1.5. *The Chow quotient $\mathrm{Gr}(3, 8)//H$ is the log canonical compactification of $X(3, 8)$.*

Here is an outline of the paper. In §2, we review the relationship between initial degenerations of $\mathrm{Gr}_0(r, n)$ and finite inverse limits of thin Schubert cells induced by a matroidal subdivision of the hypersimplex. We consider the general setup of diagrams of schemes in §3, and develop various strategies to determine when their inverse limits are smooth and irreducible. While not all morphisms between thin Schubert cells of $\mathrm{Gr}(3, 8)$ are smooth and dominant, we develop general criteria in §4 to detect when they are smooth and dominant with connected fibers. The disconnected initial degeneration of Theorem 1.3 is studied in §5. Theorems 1.1 and 1.4 are proved in §6. We use the techniques from §§3-4 to prove that each inverse limit $\mathrm{Gr}(w)$ smooth of dimension 15 and, excluding the case from Theorem 1.3, irreducible. For any individual w , once one has the regular subdivision, one may carry out this verification by hand, as we illustrate in several examples throughout that section. As there are 57 344 cases to consider, we must use software. Finally, we discuss the Chow quotient in §7 and prove Theorem 1.5.

Code. Throughout §6, we use `polymake.jl` [9, 18] and OSCAR [8, 30], both of which run using `julia` [3]. The code can be found at the following github repository:

<https://github.com/dcorey2814/Gr38Schoen>

Acknowledgements. We thank Benjamin Schröter for sharing the data of the tropicalization of $\mathrm{Gr}_0(3, 8)$ with us. We also thank Michael Joswig, Lars Kastner, Benjamin Lorenz, Sam Payne, and Antony Della Vecchia for helpful conversations. DC is supported by the SFB-TRR project “Symbolic Tools in Mathematics and their Application” (project-ID 286237555), and DL is supported by “Facets of Complexity” (GRK 2434, project-ID 385256563).

2. INVERSE LIMITS OF THIN SCHUBERT CELLS

2.1. Matroidal subdivisions. We assume that the reader is familiar with matroids; a good general reference is [31]. While there are many ways of characterizing matroids, the

definition via *bases* is most relevant. A matroid of rank r on $[n]$, called an (r, n) -*matroid*, is a nonempty subset Q of $\binom{[n]}{r}$ that satisfies the basis-exchange axiom.

Let $N = \mathbb{Z}^n / \langle \mathbf{1} \rangle$ and $M = \text{Hom}(N, \mathbb{Z})$. We use the standard abbreviations $M_A = M \otimes_{\mathbb{Z}} A$ and $N_A = N \otimes_{\mathbb{Z}} A$ where A is a \mathbb{Z} -module. Denote by $\epsilon_1, \dots, \epsilon_n \in N$ the images of the standard basis vectors under the projection $\mathbb{Z}^n \rightarrow N$, and $\epsilon_\lambda = \epsilon_{i_1} + \dots + \epsilon_{i_r}$ whenever $\lambda = \{i_1, \dots, i_r\} \in \binom{[n]}{r}$. Denote by ϵ_i^* and ϵ_λ^* in M the duals of ϵ_i and ϵ_λ , respectively.

Given $Q \subset \binom{[n]}{r}$, set

$$\Delta(Q) = \text{conv}\{\epsilon_\lambda^* : \lambda \in Q\} \subset M_{\mathbb{R}}$$

When Q is a matroid, $\Delta(Q)$ is the *matroid polytope* of Q . An important special case is the *uniform matroid* $Q = \binom{[n]}{r}$, and its polytope $\Delta(Q)$ is the (r, n) -*hypersimplex* which we denote $\Delta(r, n)$.

Let $N(Q) = \mathbb{Z}^Q / \langle \mathbf{1} \rangle$ and $M(Q) = \text{Hom}(N(Q), \mathbb{Z})$. Denote by $\{\epsilon_\lambda : \lambda \in Q\}$ the images of the standard basis vectors under $\mathbb{Z}^Q \rightarrow N(Q)$. For $w \in N(Q)_{\mathbb{R}} := N(Q) \otimes_{\mathbb{Z}} \mathbb{R}$, denote by $\mathcal{Q}(w)$ the *regular subdivision* of $\Delta(Q)$ induced by w ; this is the polyhedral complex obtained by lifting, for each $\lambda \in Q$, the vertex ϵ_λ^* of $\Delta(Q)$ to height w_λ in $M_{\mathbb{R}} \times \mathbb{R}$, then projecting the lower faces of this lifted polytope back down to $M_{\mathbb{R}}$. See [7, Chapter 2] for a precise treatment.

If Q is a matroid, then the subdivision $\mathcal{Q}(w)$ is *matroidal* if each cell in $\mathcal{Q}(w)$ is a matroid polytope. The *Dressian* of Q [17] is the set

$$\text{Dr}(Q) = \{w \in N(Q)_{\mathbb{R}} : \mathcal{Q}(w) \text{ is matroidal}\}.$$

This is the support of a polyhedral fan in $N(Q)$.

2.2. Tropicalization. Consider a pair of finite-rank lattices M, N with a perfect pairing

$$(u, v) \rightarrow \langle u, v \rangle$$

Let $T = \text{Spec}(\mathbb{C}[M])$ be the torus whose character and cocharacter lattices are M and N , respectively. Denote by $x^u \in \mathbb{C}[M]$ the monomial corresponding to $u \in M$. Suppose $X \subset T$ is a closed subvariety defined by a prime ideal $I \subset \mathbb{C}[M]$. Given $w \in N_{\mathbb{R}}$, the *w-initial form* of $f \in \mathbb{C}[M]$ is

$$\text{in}_w f = \sum_{\substack{\langle u, w \rangle \\ \text{is minimal}}} c_u x^u \quad \text{where} \quad f = \sum_u c_u x^u$$

The *w-initial ideal* of I is $\text{in}_w I = \langle \text{in}_w f : f \in I \rangle$. The *tropicalization* of X is

$$\text{Trop}(X) = \{w \in N_{\mathbb{R}} : \text{in}_w I \neq \langle 1 \rangle\}.$$

This set is the support of a rational polyhedral fan in $N_{\mathbb{R}}$. Given $w \in \text{Trop}(X)$, the *w-initial degeneration* of X , denoted $\text{in}_w X$, is the subscheme of T defined by the ideal $\text{in}_w I$.

2.3. The Grassmannian. As a set, the Grassmannian $\text{Gr}(r, n)$ consists of all r -dimensional linear subspaces of \mathbb{C}^n . It may be realized as a projective variety by the Plücker embedding:

$$\text{Gr}(r, n) \hookrightarrow \mathbb{P}(\wedge^r \mathbb{C}^n) \cong \mathbb{P}^{\binom{n}{r}-1} \quad F \mapsto \wedge^r F = [\zeta_\lambda(F) : \lambda \in \binom{[n]}{r}]$$

The homogeneous coordinates $\zeta_\lambda(F)$ are called the *Plücker coordinates* of F . Concretely, if $F \subset \mathbb{C}^n$ is the row span of the full-rank $(r \times n)$ -matrix A , then $\zeta_\lambda(F)$ is the determinant of the $(r \times r)$ -submatrix of A whose columns are indexed by λ .

Given a matroid $Q \subset \binom{[n]}{r}$, its *thin Schubert cell* is the scheme-theoretic intersection

$$\mathrm{Gr}(Q) = \mathrm{Gr}(r, n) \cap T(Q)$$

where $T(Q) = \mathbb{G}_m^Q / \mathbb{G}_m$ is the locally-closed coordinate stratum of $\mathbb{P}^{\binom{n}{r}-1}$ whose nonzero coordinates are exactly those belonging to Q . Of particular interest is the thin Schubert cell of the uniform matroid $Q = \binom{[n]}{r}$, which we denote by $\mathrm{Gr}_0(r, n)$; this is the open locus of $\mathrm{Gr}(r, n)$ determined by the nonvanishing of all Plücker coordinates. Throughout, we use the abbreviations

$$\mathrm{TGr}(Q) = \mathrm{Trop}(\mathrm{Gr}(Q)) \quad \text{and} \quad \mathrm{TGr}_0(r, n) = \mathrm{Trop}(\mathrm{Gr}_0(r, n))$$

The set $\mathrm{TGr}(Q) \subset N(Q)_{\mathbb{R}}$ is preserved under translation by the $(n-1)$ -dimensional linear subspace $L_{\mathbb{R}}$, where $L \subset N(Q)$ is the subgroup

$$(2.1) \quad L = \left\langle \sum_{i \in \lambda \in Q} e_\lambda, \sum_{i \notin \lambda \in Q} e_\lambda : i \in [n] \right\rangle.$$

We have an inclusion $\mathrm{TGr}(Q) \subset \mathrm{Dr}(Q)$ by [34, Proposition 2.2] in the uniform matroid case and [28, Lemma 4.4.6] in general. Of particular importance is that $\mathcal{Q}(w)$ is *matroidal* for any $w \in \mathrm{TGr}(Q)$.

Denote by $\mathcal{G}(r, n)$ the Gröbner fan structure of $\mathrm{TGr}_0(r, n)$ and $\mathcal{S}_{\mathrm{mat}}(r, n)$ the secondary fan structure on $\mathrm{Dr}(r, n)$. By [37, Theorem 5.4], $\mathcal{G}(r, n)$ is a subfan of a refinement of $\mathcal{S}_{\mathrm{mat}}(r, n)$. For $(r, n) = (2, n)$, $(3, 6)$ [35], $(3, 7)$ [17], or $(3, 8)$ [2], there is a subfan $\mathcal{S}_{\mathrm{trop}}(r, n)$ of $\mathcal{S}_{\mathrm{mat}}(r, n)$ whose support is $\mathrm{TGr}_0(r, n)$.

The *face order* on the set of (r, n) -matroids is defined by $P \leq Q$ whenever $\Delta(P)$ is a face of $\Delta(Q)$. For each pair $P \leq Q$, the coordinate projection $T(Q) \rightarrow T(P)$ induces a morphism $\varphi_{Q,P} : \mathrm{Gr}(Q) \rightarrow \mathrm{Gr}(P)$ [24, Proposition I.6]. Given $w \in \mathrm{TGr}(Q)$, the regular subdivision $\mathcal{Q}(w)$ of $\Delta(Q)$ is matroidal in the sense of §2.1. The assignment

$$P \mapsto \mathrm{Gr}(P) \quad P' \leq P \mapsto \varphi_{P,P'} : \mathrm{Gr}(P) \rightarrow \mathrm{Gr}(P')$$

defines a diagram of type $\mathcal{Q}(w)$ in the category of affine \mathbb{C} -schemes, and therefore we may form its inverse limit:

$$\mathrm{Gr}(w) := \varprojlim_{\mathcal{Q}(w)} \mathrm{Gr}.$$

The following theorem [6, Theorem 1.1] is fundamental to the proofs of the main theorems in this paper.

Theorem 2.1. *For any $w \in \mathrm{TGr}_0(r, n)$, there is a closed immersion*

$$\mathrm{in}_w \mathrm{Gr}_0(r, n) \hookrightarrow \mathrm{Gr}(w).$$

We thus obtain the following.

Corollary 2.2. *Suppose $w \in \mathrm{TGr}_0(r, n)$. If $\mathrm{Gr}(w)$ is smooth and irreducible of dimension $r(n-r)$, then $\mathrm{in}_w \mathrm{Gr}_0(r, n)$ is also smooth and irreducible.*

Proof. Being a limit of a flat degeneration of $\text{Gr}_0(r, n)$, the initial degeneration $\text{in}_w \text{Gr}_0(r, n)$ is an affine scheme of dimension $r(n - r)$. The inverse limit $\text{Gr}(w)$ also an affine scheme, so if it is smooth, irreducible, and has the same dimension as $\text{in}_w \text{Gr}(r, n)$, then the closed immersion from Theorem 2.1 is an isomorphism [6, Proposition A.8]. \square

In the course of proving Theorems 1.1, 1.3, and 1.4, we show that the closed immersion in Theorem 2.1 is an isomorphism for each $w \in \text{TGr}_0(3, 8)$. This provides a conceptual explanation of [2, Theorem 4.8], which states that two vectors $w_1, w_2 \in \text{TGr}_0(3, 8)$ lie in the same cone of $\mathcal{S}_{\text{trop}}(3, 8)$ if and only if $\text{in}_{w_1} \text{Gr}_0(3, 8) = \text{in}_{w_2} \text{Gr}_0(3, 8)$. In contrast, the cones in the Gröbner fan parameterize the various initial ideals of the homogeneous Plücker ideal.

2.4. Limits over graphs and tight spans. Computing the inverse limit $\text{Gr}(w)$ seems like an unmanageable task given the size of the full face poset of $\mathcal{Q}(w)$. It turns out that the codimension 0 and 1 cells that meet the relative interior of $\Delta(Q)$ are sufficient to compute this limit. For added flexibility, we describe a collection of subposets of $\mathcal{Q}(w)$ that carry enough information to determine the inverse limit $\text{Gr}(w)$.

Let $\mathcal{Q}(w)$ be a regular subdivision of a lattice polytope $\Delta(Q) \subset M_{\mathbb{R}}$ induced by the lifting function $w \in N(Q)$. The *dual graph* of $\mathcal{Q}(w)$, denoted by $\Gamma(w)$, is the graph that has a vertex v_P for each codimension-0 face $P \in \mathcal{Q}(w)$, and the vertices $v_P, v_{P'}$ are connected by an edge if and only if P and P' meet along a common codimension-1 face.

The *tight span* of $\mathcal{Q}(w)$, denoted $\text{TS}(w)$, is the polyhedral complex that has a cell of dimension $\dim \Delta(Q) - k$ for each k -dimensional cell of $\mathcal{Q}(w)$ meeting the relative interior of $\Delta(Q)$, and with face identifications opposite those of $\mathcal{Q}(w)$. See [16] for a precise treatment. The dual graph is exactly the 1-skeleton of the tight-span. Given any polyhedral complex Σ with $\Gamma(w) \subset \Sigma \subset \text{TS}(w)$, we may view Σ^{op} as a subposets of $\mathcal{Q}(w)$, and hence we may form the limits of thin Schubert cells over this diagram. We denote such a limit by $\varprojlim_{\Sigma} \text{Gr}$.

Proposition 2.3. *Given any polyhedral complex Σ with $\Gamma(w) \subset \Sigma \subset \text{TS}(w)$, the natural morphisms*

$$\text{Gr}(w) \xrightarrow{\Phi} \varprojlim_{\Sigma} \text{Gr} \xrightarrow{\Psi} \varprojlim_{\Gamma(w)} \text{Gr}$$

are isomorphisms.

Proof. The composition $\Psi \circ \Phi$ is an isomorphism by a result of Cueto [6, Proposition C.12]; denote by $\Theta : \varprojlim_{\Gamma(w)} \text{Gr} \rightarrow \text{Gr}(w)$ its inverse. One readily verifies that $\Phi \circ \Theta$ is the inverse to Ψ . \square

3. TOOLS TO STUDY FINITE INVERSE LIMITS OF SCHEMES

We gather in this section a number of techniques that will allow us to study inverse limits of diagrams of schemes coming from contractible polyhedral complexes, e.g., tight-spans of matroidal subdivisions of the hypersimplex. More precisely, we want techniques to prove that a finite inverse limit is smooth and irreducible just by understanding the spaces and maps in the inverse limit system. With these techniques in hand, we avoid the necessity to directly compute the inverse limit.

The key facts underlying most arguments in this section are contained in the following proposition. Recall that a *SDC-morphism* of \mathbb{C} -schemes is a morphism of schemes $\varphi : X \rightarrow Y$ that is smooth, dominant, and its nonempty fibers are connected.

Proposition 3.1. *Suppose we have morphisms of equidimensional \mathbb{C} -schemes $X \rightarrow W$ and $Y \rightarrow W$.*

- (1) *If Y is smooth and irreducible, and $X \rightarrow W$ is an SDC-morphism, then $X \times_W Y$, if nonempty, is smooth and irreducible.*
- (2) *If Y is smooth with k -connected components, and $X \rightarrow W$ is smooth and surjective with connected fibers, then $X \times_W Y$ is smooth with k connected components.*

In either case, the dimension of $X \times_W Y$ is

$$\dim X \times_W Y = \dim X + \dim Y - \dim W.$$

Proof. Part (1) is [6, Proposition A.2], so consider (2). Smoothness, surjectivity, and connectivity of fibers are all preserved by base change, so $X \times_W Y \rightarrow Y$ has these properties. The fiber product $X \times_W Y$ is a smooth \mathbb{C} -scheme as $X \times_W Y \rightarrow \text{Spec } \mathbb{C}$ is the composition of two smooth morphisms. By [36, Tag 0378], the morphism $X \times_W Y \rightarrow Y$ induces a bijection between the connected components of these spaces, and hence $X \times_W Y$ has k connected components. The dimension formula is standard, see, e.g., [14, §III.9] \square

Throughout this section, let Σ be a finite connected polyhedral complex, and Γ its 1-skeleton. We regard Σ as a quiver induced by its face order. Thus, we have an arrow $C' \rightarrow C$ whenever C' is a *facet* of C in Σ . A *diagram* of type Σ in $\mathbb{C}\text{-sch}$, the category of \mathbb{C} -schemes, is simply a functor $Z : \Sigma \rightarrow \mathbb{C}\text{-sch}$. As finite inverse limits exist in the category $\mathbb{C}\text{-sch}$ (indeed, it is enough to have fiber products and a terminal object, see [1, Proposition 5.21]), we may form the inverse limit $\varprojlim_{\Sigma} Z$.

Proposition 3.2. *Suppose $Z : \Gamma \rightarrow \mathbb{C}\text{-sch}$ is a diagram over a tree Γ , and that $Z(v)$ is smooth and irreducible for all $v \in V(\Gamma)$. Furthermore, suppose that $Z(v \rightarrow e)$ is an SDC-morphism for all $v \in V(\Gamma)$ and $e \in E(\Gamma)$ adjacent to v , except for possibly one vertex v_0 . Then $\varprojlim_{\Gamma} Z$ is smooth and irreducible of dimension*

$$(3.1) \quad \dim \varprojlim_{\Gamma} Z = - \sum_{e \in E(\Gamma)} \dim Z(e) + \sum_{v \in V(\Gamma)} \dim Z(v)$$

Proof. We proceed by induction on the number of edges. The proposition is trivial if Γ has no edges, so assume that Γ has n edges and that the proposition is true for graphs with fewer than n edges. Suppose $v \neq v_0$ is connected to v_0 by the edge e . Then $Z(v) \times_{Z(e)} Z(v_0)$ is smooth and irreducible by Proposition 3.1. Let Z' be the diagram on Γ/e where $Z'(v) = Z(v) \times_{Z(e)} Z(v_0)$ at the contracted vertex, and $Z' = Z$ otherwise. By [6, Proposition A.5] we have that $\varprojlim_{\Gamma} Z \cong \varprojlim_{\Gamma/e} Z'$. As Z' is a diagram on a graph with fewer edges and satisfies the hypotheses of the proposition, the limit $\varprojlim_{\Gamma/e} Z'$ is smooth and irreducible by the inductive hypothesis. \square

3.1. Removing leaves. A *leaf* of Σ is a vertex v of Σ that is a leaf vertex of Γ . A *leaf-pair* is a pair (v, e) such that v is a leaf and e is its adjacent edge. Let $\Sigma_{\perp} \subset \Sigma$ be the subcomplex obtained by removing all leaf-pairs from Σ .

Proposition 3.3. *If $\varprojlim_{\Sigma_L} Z$ is smooth and irreducible and $Z(v \rightarrow e)$ is an SDC-morphism for each leaf pair (v, e) then $\varprojlim_{\Sigma} Z$ is smooth and irreducible of dimension*

$$(3.2) \quad \dim \varprojlim_{\Gamma} Z = \dim \varprojlim_{\Sigma_L} Z - \sum_{\substack{e \text{ leaf} \\ \text{edge}}} \dim Z(e) + \sum_{\substack{v \text{ leaf} \\ \text{vertex}}} \dim Z(v)$$

Proof. Let Γ' be the star-shaped graph obtained by contracting Σ_L to a point. Let Z' be the diagram on Γ' defined by Z on all leaf-pairs, and $\varprojlim_{\Sigma_L} Z$ on the newly-formed vertex. Set

$$Y_{\text{Leaf}} = \prod_{\substack{v \text{ leaf} \\ \text{vertex}}} Z(v) \quad Y'_{\text{Leaf}} = \prod_{\substack{e \text{ leaf} \\ \text{edge}}} Z(e)$$

and note that $Y_{\text{Leaf}} \rightarrow Y'_{\text{Leaf}}$ is an SDC-morphism since each $Z(v \rightarrow e)$ is an SDC-morphism. By [6, Proposition A.5] and Proposition 2.3, we have

$$\varprojlim_{\Sigma} Z \cong \varprojlim_{\Gamma'} Z'$$

The proposition now follows from Proposition 3.2. \square

Observe that $\Sigma_L \subset \Sigma$ may still have leaves. The process of iteratively removing leaf-pairs must terminate, and the result is the subcomplex $\Sigma_{\text{Br}} \subset \Sigma$, which is nonempty provided Σ is not a tree. A maximal connected subgraph of $\Sigma \setminus \Sigma_{\text{Br}}$ is called a *branch* of Σ . Any vertex in a branch is called a *branch vertex* and any edge contained in a branch, or connecting a branch to the rest of Σ , is called a *branch edge*. The following proposition follows from Proposition 3.3 and induction.

Proposition 3.4. *If $\varprojlim_{\Sigma_{\text{Br}}} Z$ is smooth and irreducible and $Z(v \rightarrow e)$ is an SDC-morphism for each pair (v, e) of a branch vertex v and adjacent edge e , then $\varprojlim_{\Sigma} Z$ is smooth and irreducible of dimension*

$$(3.3) \quad \dim \varprojlim_{\Gamma} Z = \dim \varprojlim_{\Sigma_{\text{Br}}} Z - \sum_{\substack{e \text{ branch} \\ \text{edge}}} \dim Z(e) + \sum_{\substack{v \text{ branch} \\ \text{vertex}}} \dim Z(v).$$

3.2. Removing fins. Suppose F is a closed 2-dimensional cell of Σ with k vertices ($k \geq 3$). We say that F is a *fin* if its intersection with $\overline{\Sigma \setminus F}$ is a path of edge-length ℓ with $1 \leq \ell \leq k - 2$; this path is called the *connecting path* of F . See Figure 3.1 for an illustration. Denote by $V(F)$ the vertices of F and $E(F)$ its edges. A vertex $v \in V(F)$, resp. an edge $e \in E(F)$, is *exposed* if $v \notin \overline{\Sigma \setminus F}$, resp. $e \not\subset \overline{\Sigma \setminus F}$. Denote by

$$\mathcal{E}_{\text{vert}}(F) = \{v \in V(F) : v \text{ is exposed}\} \quad \mathcal{E}_{\text{edge}}(F) = \{e \in E(F) : e \text{ is exposed}\}$$

Order the vertices of F cyclically v_1, \dots, v_k so that the first $k - \ell - 1$ are the exposed vertices. Let $e_{i,i+1}$ be the edge between v_i and v_{i+1} (where the indices are taken modulo k). Denote by $Z_{\mathcal{E}}(F)$ the fiber product

$$(3.4) \quad Z_{\mathcal{E}}(F) = Z(v_1) \times_{Z(e_{1,2})} Z(v_2) \times_{Z(e_{2,3})} \cdots \times_{Z(e_{k-\ell-2,k-\ell-1})} Z(v_{k-\ell-1})$$

and let $\varphi_F : Z_{\mathcal{E}}(F) \rightarrow Z(e_{1,k}) \times_{Z(F)} Z(e_{k-\ell-1,k-\ell})$ be the morphism induced by $Z(v_1 \rightarrow e_{1,k})$ and $Z(v_{k-\ell-1} \rightarrow e_{k-\ell-1,k-\ell})$.

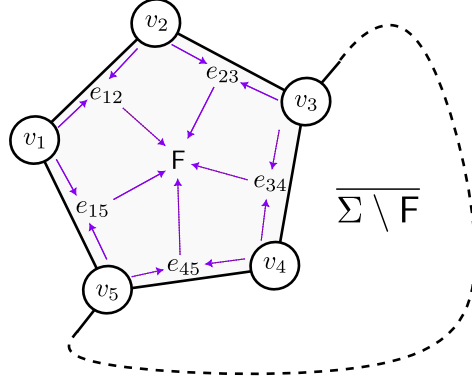

FIGURE 3.1. A fin and the corresponding quiver. The vertices v_1, v_2 and edges e_{15}, e_{12}, e_{23} are exposed

Proposition 3.5. *Suppose $Z : \Sigma \rightarrow \mathbb{C}$ -sch is a diagram, F is a fin of Σ , and $\Sigma' = \overline{\Sigma \setminus F}$. Then we have a pullback diagram*

$$\begin{array}{ccc} \varprojlim_{\Sigma} Z & \longrightarrow & Z_{\mathcal{E}}(F) \\ \downarrow & & \downarrow \varphi_F \\ \varprojlim_{\Sigma'} Z & \longrightarrow & Z(e_{1,k}) \times_{Z(F)} Z(e_{k-\ell-1,k-\ell}) \end{array}$$

The proof amounts to showing that $\varprojlim_{\Sigma} Z$ satisfies the universal property of fiber products. It is similar to [6, Proposition A.5], so we omit the proof.

Given a collection of fins \mathfrak{F} , let $\Sigma(\mathfrak{F}) \subset \Sigma$ be the subcomplex obtained by removing, for each $F \in \mathfrak{F}$, the relatively open cell F° and the exposed vertices and edges of F .

Proposition 3.6. *If $\varprojlim_{\Sigma(\mathfrak{F})} Z$ is smooth and irreducible and φ_F is an SDC-morphism for each $F \in \mathfrak{F}$, then $\varprojlim_{\Sigma} Z$ is smooth and irreducible of dimension*

$$(3.5) \quad \dim \varprojlim_{\Sigma} Z = \dim \varprojlim_{\Sigma(\mathfrak{F})} Z + \sum_{F \in \mathfrak{F}} \left(\dim Z(F) - \sum_{e \in \mathcal{E}_{\text{edge}}(F)} \dim Z(e) + \sum_{v \in \mathcal{E}_{\text{vert}}(F)} \dim Z(v) \right)$$

Proof. This follows from Propositions 3.1 and 3.5 applied to each fin $F \in \mathfrak{F}$. \square

4. COMPUTATIONS ON THIN SCHUBERT CELLS

By the Mnëv universality theorem (see [24, 25]), the collection of schemes $\text{Gr}(Q)$, as Q runs through the \mathbb{C} -realizable $(3, n)$ -matroids, satisfies Murphy's law in the sense of Vakil [38]. Nevertheless, for small values of n , many such $\text{Gr}(Q)$ are smooth and irreducible; in fact $\text{Gr}(Q)$ is smooth and irreducible for all $(3, n)$ -matroid with $n \leq 7$ [6, Proposition 4.2]. In this section, we show that $\text{Gr}(Q)$ are smooth for all \mathbb{C} -realizable $(3, 8)$ -matroids, but there is one $\text{Gr}(Q)$ that has 2 connected components.

4.1. Affine coordinates for thin Schubert cells. We recall the affine coordinate ring construction of $\text{Gr}(Q)$, following [6, Construction 2.2]. Given any $r \times n$ (for $r \leq n$) matrix A , denote by $\text{col}_i(A)$ the i -th column of A . With $\lambda = \{i_1 < \dots < i_s\}$ define the $r \times s$ submatrix $A_\lambda = [\text{col}_{i_1} A, \dots, \text{col}_{i_s} A]$.

Define B to be the polynomial ring

$$B = \mathbb{C}[x_{ij} : i \in [r], j \in [n-r]]$$

Given $\mu = \{j_1 < \dots < j_r\} \in \binom{[n]}{r}$, let $A^{(\mu)}$ be the B -valued matrix such that $(A^{(\mu)})_\mu$ is the $r \times r$ identity matrix, and $(A^{(\mu)})_{[n] \setminus \mu}$ is the $r \times (n-r)$ matrix $[x_{ij}]$. Of particular importance is the case $\mu = [r]$, where we write $A := A^{(\mu)}$, which is

$$(4.1) \quad A = \begin{bmatrix} 1 & 0 & \cdots & 0 & x_{11} & x_{12} & \cdots & x_{1,n-r} \\ 0 & 1 & \cdots & 0 & x_{21} & x_{22} & \cdots & x_{2,n-r} \\ \cdots & \cdots & \cdots & \cdots & \cdots & \cdots & \cdots & \cdots \\ 0 & 0 & \cdots & 1 & x_{r1} & x_{r2} & \cdots & x_{r,n-r} \end{bmatrix}$$

Let Q be an (r, n) -matroid, μ a basis of Q , and $a_\mu : [n-r] \rightarrow [n] \setminus \mu$ the unique order-preserving bijection. When $\mu = [r]$, this function is $a_\mu(j) = r + j$. Let

$$B_Q^\mu = \mathbb{C}[x_{ij} : \mu \Delta \{i, a_\mu(j)\} \in Q]$$

where Δ denotes the symmetric difference, and define the quotient ring map

$$\pi_Q : B \rightarrow B / \langle x_{ij} : \mu \Delta \{i, a_\mu(j)\} \in \binom{[n]}{r} \setminus Q \rangle \cong B_Q^\mu.$$

Define the ideal I_Q^μ and multiplicative semigroup S_Q^μ by

$$(4.2) \quad I_Q^\mu = \langle \pi_Q(\det A_\lambda^{(\mu)}) : \lambda \in \binom{[n]}{r} \setminus Q \rangle \quad S_Q^\mu = \langle \pi_Q(\det A_\lambda^{(\mu)}) : \lambda \in Q \rangle_{\text{semigrp}}.$$

The affine coordinate ring of $\text{Gr}(Q)$ is isomorphic to

$$R_Q^\mu := (S_Q^\mu)^{-1} B_Q^\mu / I_Q^\mu.$$

To simplify notation, when $\mu = [r]$, we write $B_Q = B_Q^\mu$, $I_Q = I_Q^\mu$, $S_Q = S_Q^\mu$, and $R_Q = R_Q^\mu$.

Given (r, n) -matroids P, Q with $P \leq Q$ in the face order (see §2.3) and μ a basis of P (and therefore a basis of Q), the morphism $\varphi_{Q,P} : \text{Gr}(Q) \rightarrow \text{Gr}(P)$ is defined by the ring map [6, Proposition 3.2]

$$(4.3) \quad (\varphi_{Q,P})^\# : R_P^\mu \rightarrow R_Q^\mu \quad x_{ij} \rightarrow x_{ij}.$$

Remark 4.1. There is a further simplification one can make to compute the coordinate ring of $\text{Gr}(Q)$. We describe this in the case when Q is *connected*. Recall from the introduction that the diagonal torus $H \subset \text{PGL}(n)$ acts on $\text{Gr}(r, n)$. For any \mathbb{C} -realizable (r, n) -matroid, this restricts to an action $H \curvearrowright \text{Gr}(Q)$. Since Q is connected, this action is free. Let $X(Q) := \text{Gr}(Q)/H$. As $\text{Gr}(Q)$ is affine, we have $\text{Gr}(Q) \cong X(Q) \times H$.

Suppose λ is a $(r+1)$ -element subset of $[n]$ such that each r -element subset of λ is a basis; such a λ exists since Q is connected. Applying a suitable permutation, we may assume that $\lambda = \{1, \dots, r+1\}$. Let A' be the matrix obtained from the matrix A in Formula (4.1) by turning the $(r+1)$ -st column into the column $[1, \dots, 1]^T$. Consider the polynomial ring

$$B' = \mathbb{C}[x_{12}, \dots, x_{r2}] \otimes_{\mathbb{C}} \cdots \otimes_{\mathbb{C}} \mathbb{C}[x_{1,n-r}, \dots, x_{r,n-r}]$$

with the $\mathbb{Z}_{\geq 0}^{n-r-1}$ -grading induced by the $n-r-1$ tensor-components. Define \bar{I}_Q and \bar{S}_Q in a way analogous to Formula (4.2), with A' and B' in place of A and B , respectively. Then $X(Q)$ is the locally-closed subscheme of the multiprojective space $(\mathbb{P}^r)^{n-r-1}$ cut

out by the multihomogeneous ideal \bar{I}_Q and localized at \bar{S}_Q . See [4] for scheme-theoretic treatments of multiprojective schemes. For each $2 \leq j \leq n - r$, there is an $i \in [r]$ such that $[r]\Delta\{i, r + j\}$ is a basis of Q , and so we may set $x_{ij} = 1$. Dehomogenizing in this way produces the affine coordinate ring of $X(Q)$.

4.2. The (3,8) case. Let Q_{sp} be the matroid from Figure 1.1, i.e., it is the (3,8)-matroid whose bases are the elements of $\binom{[8]}{3}$ other than

$$(4.4) \quad 126, 145, 178, 235, 248, 347, 368, 567.$$

Proposition 4.2. *The thin Schubert cell $\text{Gr}(Q_{\text{sp}})$ is a smooth affine scheme with two connected components of dimension 7.*

Proof. As $X(Q_{\text{sp}}) \cong \text{Gr}(Q_{\text{sp}}) \times H$ and $\dim H = 7$, it suffices to show that $X(Q_{\text{sp}})$ consists of two reduced points. Any $r \times n$ matrix representing Q_{sp} is in the $(\text{GL}(r) \times H)$ -orbit of

$$(4.5) \quad A' = \begin{bmatrix} 1 & 0 & 0 & 1 & 0 & 1 & 1 & 1 \\ 0 & 1 & 0 & 1 & 1 & a & 1 & a \\ 0 & 0 & 1 & 1 & 1 & 0 & 1 - a & 1 \end{bmatrix}$$

where a is one of the 2 solutions of $x^2 - x + 1 = 0$. This amounts to the fact that the affine coordinate ring of $X(Q)$ is isomorphic to

$$\mathbb{C}[a]/\langle a^2 - a + 1 \rangle \cong \mathbb{C} \times \mathbb{C}.$$

which may be verified using Remark 4.1. □

Proposition 4.3. *If Q is a \mathbb{C} -realizable (3,8)-matroid other than Q_{sp} , then $\text{Gr}(Q)$ is smooth and irreducible.*

Proof. The (3,8)-matroids have been enumerated by [29]. Up to \mathfrak{S}_8 -symmetry, there are 325 such matroids, 68 of which are simple. Of the simple matroids, all but the ones isomorphic to Q_{sp} have the following property: there exists an $i \in [8]$ that is contained in 2 or fewer rank-2 cyclic flats. In fact, every element of $[8]$ is contained in exactly 3 rank-2 cyclic flats of Q_{sp} . Thus the proposition follows from [6, 4.1-2]. □

4.3. Maps between thin Schubert cells. Given a connected (r, n) -matroid Q and $P \leq Q$ (i.e., $\Delta(P)$ is a face of $\Delta(Q)$), we say that P is *internal* if $\Delta(P)$ is contained in the interior of $\Delta(r, n)$. If $P \leq Q$ are $(3, n)$ -matroids for $n \leq 6$, or if $P \leq Q$ are $(3, 7)$ -matroids such that Q is connected and P is internal, then $\text{Gr}(Q) \rightarrow \text{Gr}(P)$ is an SDC-morphism [6, Propositions 5.4, 5.5]. In general, the morphisms $\varphi_{Q,P} : \text{Gr}(Q) \rightarrow \text{Gr}(P)$ are not expected to be smooth or dominant when $P \leq Q$, and we see this when $n = 8$.

One such example is depicted in Figure 4.1. In the matroid on the left, the points labeled 1, 2, 3, 4 all lie on a \mathbb{P}^1 , and the cross-ratio $(1, 3; 2, 4)$ equals -1 , see [10, §5.2]. However, there is no such constraint for the matroid on the right. So the morphism $\varphi_{Q,P}$ is not dominant, nor is it smooth (as it is not open). Nevertheless, enough of the morphisms between (3,8)-matroid strata are smooth and dominant with connected fibers to allow us to prove Theorem 1.1. We record some observations to simplify our analysis in the following 2 sections.

Let Q be a loopless (r, n) -matroid whose rank-1 flats are η_1, \dots, η_k . Choose $a_1 \in \eta_1, a_2 \in \eta_2, \dots, a_k \in \eta_k$ and set $S = \{a_1, \dots, a_k\}$. Then $Q|S$ is a simple matroid, and is called a *simplification* of Q . Such a set S is called a *simplifying set* of Q . Given a vector $v \in N_{\mathbb{R}}$, denote

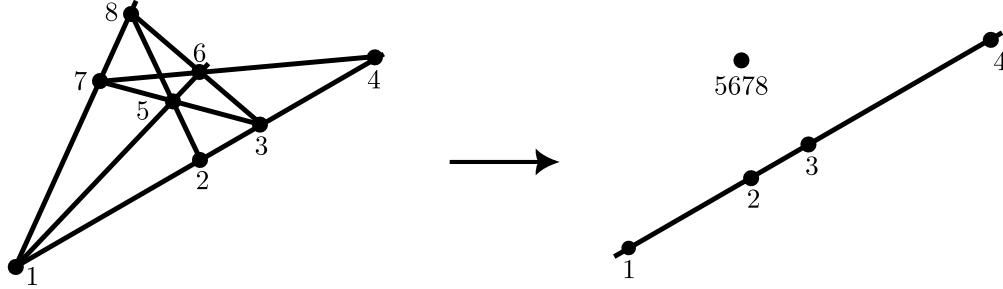

FIGURE 4.1. An example of a non-smooth, non-dominant morphism of thin Schubert cells

by $\text{face}_v Q$ the matroid

$$\text{face}_v Q = \{ \zeta \in Q : \langle e_{\zeta}^*, v \rangle \leq \langle e_{\zeta'}^*, v \rangle \text{ for all } \zeta' \in Q \};$$

this is the matroid of the face of $\Delta(Q) \subset M_{\mathbb{R}}$ normal to $v \in N_{\mathbb{R}}$. Now suppose Q is connected. A subset $\lambda \subset [n]$ is a *nondegenerate subset* of Q if $Q|\lambda$ and Q/λ are connected. Recall from [12, § 2.5] that $\text{face}_{-\epsilon_\lambda} Q \cong Q|\lambda \times Q/\lambda$ and $\lambda \mapsto \Delta(\text{face}_{-\epsilon_\lambda} Q)$ defines a bijection between the nondegenerate subsets of Q and the facets of $\Delta(Q)$.

Now suppose Q has rank 3. A subset $\lambda \subset [n]$ is a *line* if λ is a rank-2 flat and $\lambda \cap S$ is a cyclic flat of $Q|S$; equivalently, λ is a rank-2 flat such that $|\lambda \cap S| \geq 3$. If Q is simple, then a line is simply a rank-2 cyclic flat, but in general being a line is a slightly stronger condition than being a rank-2 cyclic flat.

Proposition 4.4. *Suppose Q is a connected $(3, n)$ -matroid with 2 or fewer lines. Then $\text{Gr}(Q)$ is smooth and irreducible, and $\varphi_{Q,P} : \text{Gr}(Q) \rightarrow \text{Gr}(P)$ is an SDC-morphism for any internal $P \leq Q$.*

The analog of the second part for matroids Q with 3 or more lines is false by [6, Example 8.4].

Proof. That $\text{Gr}(Q)$ is smooth and irreducible follows from [6, 4.1-2]. Suppose $P \leq Q$ is internal. Given a simplifying set S of Q , we have that $P|S \leq Q|S$ and $\text{Gr}(Q) \rightarrow \text{Gr}(P)$ is an SDC-morphism provided $\text{Gr}(Q|S) \rightarrow \text{Gr}(P|S)$ is an SDC-morphism [6, Lemma C.5] (Appendix by Cueto). However, $P|S \leq Q|S$ may no longer be internal. Therefore, it suffices to prove that $\varphi_{Q,P}$ is an SDC-morphism if Q is simple with fewer than 2 lines, and $P \leq Q$ such that $\Delta(P)$ is a (not necessarily internal) facet of $\Delta(Q)$.

By [6, Proposition 5.1], $P = \text{face}_{-\epsilon_\lambda} Q$ where $|\lambda| \in \{1, n-1\}$ or λ is a line. If λ is a line or $|\lambda| = n-1$, then $\varphi_{Q,P}$ is an SDC-morphism by [6, 4.1.5.3-4]. We are left to consider the case $|\lambda| = 1$, say $\lambda = \{a\}$. Suppose Q has 2 lines λ_1, λ_2 , which meet at a point.

Case 1: $a \in \lambda_2 \setminus \lambda_1$. Say $a = 3$, $\lambda_1 = \{1, 2, 4, \dots, k+3\}$ and $\lambda_2 = \{1, 3, k+4, \dots, \ell+3\}$. Then $\text{Gr}(Q) \rightarrow \text{Gr}(P)$ is an SDC-morphism because

$$R_Q \cong S_Q^{-1} R_P[x_{3,k+1}^\pm, \dots, x_{3n}^\pm].$$

Case 2: $a \in \lambda_1 \cap \lambda_2$. We may assume λ_1 and λ_2 are as in the previous case, and that $a = 1$. Then $\text{Gr}(Q) \rightarrow \text{Gr}(P)$ is an SDC-morphism because

$$R_Q = S_Q^{-1} R_P[x_{11}^\pm, \dots, x_{1n}^\pm]$$

Case 3: $a \notin \lambda_1 \cup \lambda_2$. Suppose $a = 1$, $\lambda_1 = \{2, 3, \dots, k+3\}$, $\lambda_2 = \{3, k+4, \dots, \ell+3\}$.

$$R_Q = S_Q^{-1} R_P[x_{1,k+1}^\pm, \dots, x_{1n}^\pm] / \langle x_{1c}x_{2\ell} - x_{2c}x_{1\ell} : k < c < \ell \rangle$$

As $x_{1c} \equiv x_{2c}x_{1\ell}/x_{2\ell}$ for $k < c < \ell$ in R_Q , we see that $R_Q \cong S_Q^{-1} R_P[x_{1,\ell}^\pm, \dots, x_{1n}^\pm]$, and so $\text{Gr}(Q) \rightarrow \text{Gr}(P)$ is an SDC-morphism.

Now suppose $\lambda_1 \cap \lambda_2 = \emptyset$.

Case 1: $a \in \lambda_1$. Say $a = 3$, $\lambda_1 = \{3, 4, \dots, k+3\}$ and $\lambda_2 = \{1, 2, k+4, \dots, \ell+3\}$. Then

$$R_Q = S_Q^{-1} R_P[x_{3,k+1}^\pm, \dots, x_{3n}^\pm]$$

Case 2: $a \notin \lambda_1 \cup \lambda_2$. Say $a = 3$, $\lambda_1 = \{1, 4, \dots, k+3\}$ and $\lambda_2 = \{2, k+4, \dots, \ell+3\}$. Then $\text{Gr}(Q) \rightarrow \text{Gr}(P)$ is an SDC-morphism since

$$\begin{aligned} R_Q &= S_Q^{-1} R_P[x_{3,1}^\pm, \dots, x_{3n}^\pm] / \left\langle \begin{array}{l} x_{2c}x_{3k} - x_{3c}x_{2k} \quad 1 \leq c < k \\ x_{1c}x_{3\ell} - x_{3c}x_{1\ell} \quad k < c < \ell \end{array} \right\rangle \\ &\cong S_Q^{-1} R_P[x_{31}^\pm, x_{3k}^\pm, x_{3\ell}^\pm, x_{3,\ell+1}^\pm, \dots, x_{3n}^\pm] \end{aligned}$$

The cases where Q has 0 or 1 lines are handled in a similar fashion (and in fact, are easier). \square

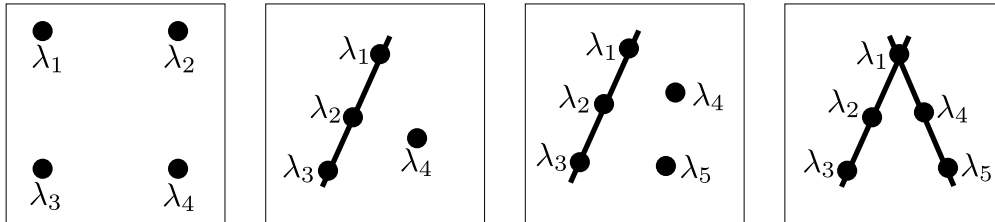

FIGURE 4.2. The matroids U, U', V, W

For many examples in this paper, we must isolate a few types of matroids. Given a partition of $[n]$ into $\lambda_1, \lambda_2, \lambda_3, \lambda_4$, let $U(\lambda_1, \lambda_2, \lambda_3, \lambda_4)$ be the matroid on the left in Figure 4.2; i.e., this is the unique matroid whose rank-1 flats are the λ_i 's and whose simplification is the uniform $(3, 4)$ -matroid. Define in a similar fashion $U'(\lambda_1, \lambda_2, \lambda_3; \lambda_4)$, $V(\lambda_1, \lambda_2, \lambda_3; \lambda_4, \lambda_5)$ and $W(\lambda_1; \lambda_2, \lambda_3; \lambda_4, \lambda_5)$ the remaining matroids in Figure 4.2. When clear from the context, we simply write U, U', V, W for these matroids. We record the following computation.

Proposition 4.5. *The thin Schubert cells of the matroids U, U', V , and W are smooth and irreducible. Their dimensions are*

$$\begin{aligned} \dim \text{Gr}(U) &= |\lambda_1| + |\lambda_2| + |\lambda_3| + |\lambda_4| - 1 & \dim \text{Gr}(U') &= |\lambda_1| + |\lambda_2| + |\lambda_3| + |\lambda_4| - 2 \\ \dim \text{Gr}(V) &= |\lambda_1| + |\lambda_2| + |\lambda_3| + |\lambda_4| + |\lambda_5| & \dim \text{Gr}(W) &= |\lambda_1| + |\lambda_2| + |\lambda_3| + |\lambda_4| + |\lambda_5| - 1 \end{aligned}$$

Furthermore, for any pair $Q' \leq Q$ with $Q \cong U, V, W$, the map $\varphi_{Q,Q'}$ is an SDC-morphism.

Proof. The statements on smoothness and irreducibility of the thin Schubert cells, and that the maps are SDC-morphisms, follow from Proposition 4.4. To compute their dimensions, we can apply [6, Lemmas C.2, C.5] (Appendix by Cueto) to reduce to the simple-matroid case. For example, consider the matroid $Q = W(1; 2, 4; 3, 5)$. The ring R_Q is

$$R_Q = \mathbb{C}[x_{11}^\pm, x_{21}^\pm, x_{21}^\pm, x_{23}^\pm]$$

and therefore $\dim \text{Gr}(Q) = 4$. The remaining cases may be handled in a similar fashion. \square

4.4. B-maximality. Given an (r, n) -matroid Q and a basis $\mu \in Q$, define

$$(4.6) \quad d(Q, \mu) = |\{\lambda \in Q : |\lambda \Delta \mu| = 2\}|$$

Observe that $d(Q, \mu)$ is the Krull dimension of B_Q^μ , and so $d(Q, \mu) \geq \dim \text{Gr}(Q)$. Intuitively, a smaller $d(Q, \mu)$ produces a simpler ideal I_Q^μ . We say that Q is (B, μ) -maximal if $\dim \text{Gr}(Q) = d(Q, \mu)$, and Q is B -maximal if there is a $\mu \in Q$ such that Q is (B, μ) -maximal.

Proposition 4.6. *Suppose Q is a (B, μ) -maximal matroid for some $\mu \in Q$.*

- (1) *The thin Schubert cell $\text{Gr}(Q)$ is an open subscheme of $(\mathbb{G}_m)^{d(Q, \mu)}$, and therefore smooth and irreducible.*
- (2) *If $P \leq Q$, then P is an open subscheme of $(\mathbb{G}_m)^{d(P, \mu)}$, and $\varphi_{Q, P} : \text{Gr}(Q) \rightarrow \text{Gr}(P)$ is an SDC-morphism.*

Proof. Without loss of generality, assume that $\mu = [r]$, in particular P and Q have $[r]$ as a basis. The equality $\dim \text{Gr}(Q) = d(Q, \mu)$ implies that $I_Q = \langle 0 \rangle$; this proves (1).

Given the nature of the map $(\varphi_{Q, P})^\# : R_Q \rightarrow R_P$ as described by Formula 4.3 we also have that $I_P = \langle 0 \rangle$. With $a = d(P, \mu)$ and $b = d(Q, \mu)$, we have that $\text{Gr}(P)$ and $\text{Gr}(Q)$ are open subschemes of \mathbb{G}_m^a and \mathbb{G}_m^b , respectively. The morphism $\varphi_{Q, P} : \text{Gr}(Q) \rightarrow \text{Gr}(P)$ is induced by a coordinate projection $\mathbb{G}_m^a \rightarrow \mathbb{G}_m^b$, and therefore it is an SDC-morphism. This completes the proof of (2). \square

Suppose $w \in N(Q)$ such that $\mathcal{Q}(w)$ is matroidal, $\Sigma \subset \text{TS}(w)$ a connected subcomplex (in most applications, Σ is the subcomplex Σ_\perp obtained by removing all leaf vertices and edges from $\text{TS}(w)$), and F is a fin of Σ . Assume that the vertices and edges of F are labeled as in §3.2, and let $Q_i, Q_{i,i+1}, Q_F$ be the matroids corresponding to the vertex v_i , edge $e_{i,i+1}$, and fin F , respectively. Denote by $\text{Gr}_\mathcal{E}(F)$ the fiber product from Formula (3.4) applied to $Z = \text{Gr}$. The morphisms $\text{Gr}(Q_1) \rightarrow \text{Gr}(Q_{1,k})$ and $\text{Gr}(Q_k) \rightarrow \text{Gr}(Q_{k-\ell, k-\ell+1})$ induce a morphism

$$\varphi_F : \text{Gr}_\mathcal{E}(F) \rightarrow \text{Gr}(Q_{1,k}) \times_{\text{Gr}(Q_F)} \text{Gr}(Q_{k-\ell, k-\ell+1}).$$

We say that the fin F is B -maximal if there is a $\mu \in Q_F$ such that $d(Q_i, \mu) = \dim \text{Gr}(Q_i)$ for $i = 1, \dots, k - \ell$.

Proposition 4.7. *If F is B -maximal, then φ_F is an SDC-morphism.*

Proof. Without loss of generality, assume that $\mu = [r]$; in particular each $Q_i, Q_{i,i+1}$, and Q_F has $[r]$ as a basis. By Proposition 4.6, we have that

$$\text{Gr}(Q_i) \subset (\mathbb{G}_m)^{d(Q_i, \mu)} \quad \text{Gr}(Q_{i,i+1}) \subset (\mathbb{G}_m)^{d(Q_{i,i+1}, \mu)} \quad \text{Gr}(Q_F) \subset (\mathbb{G}_m)^{d(Q_F, \mu)}$$

as open subschemes, and the morphisms

$$\text{Gr}(Q_i) \rightarrow \text{Gr}(Q_{i,i+1}) \quad \text{Gr}(Q_{1,k}) \rightarrow \text{Gr}(Q_F) \quad \text{Gr}(Q_{k-\ell, k-\ell+1}) \rightarrow \text{Gr}(Q_F)$$

are induced by coordinate projections of tori. This implies that the schemes $\text{Gr}_\mathcal{E}(F)$ and $\text{Gr}(Q_{1,k}) \times_{\text{Gr}(Q_F)} \text{Gr}(Q_{k-\ell, k-\ell+1})$ may be realized as open subschemes of tori, and the morphism φ_F is induced a coordinate projection of tori. Therefore, φ_F is an SDC-morphism. \square

5. A REDUCIBLE INITIAL DEGENERATION

Recall from the introduction and §4.2 that Q_{sp} is the $(3, 8)$ -matroid with nonbases as in (4.4). Let w_{sp} be the co-rank vector of this matroid. The cone of $\mathcal{S}_{\text{trop}}(3, 8)$, the secondary fan structure of $\text{TGr}_0(3, 8)$ described in 2.3, containing w_{sp} in its relative interior is

$$\mathcal{C}_{\text{sp}} = \mathbb{R}_{\geq 0} \langle e_{126}, e_{145}, e_{178}, e_{235}, e_{248}, e_{347}, e_{368}, e_{567} \rangle + L_{\mathbb{R}}.$$

The tight-span $\text{TS}(w_{\text{sp}})$ is a star-shaped tree. The matroid of the center node is Q_{sp} . There are 8 leaves, one corresponding to each nonbasis of Q_{sp} . The matroids of the leaf vertices and adjacent edges are

$$Q(ijk) = U(i, j, k, [8] \setminus ijk), \quad \text{and} \quad Q'(ijk) = U'(i, j, k; [8] \setminus ijk),$$

respectively, where U and U' are the left 2 matroids in Figure 4.2, and ijk run through the nonbases of Q_{sp} .

Proposition 5.1. *Let \mathcal{C} be any cone of $\mathcal{S}_{\text{trop}}(3, 8)$ in the \mathfrak{S}_8 -orbit of \mathcal{C}_{sp} , and w in the relative interior of \mathcal{C} . The inverse limit $\text{Gr}(w)$ is smooth, 15-dimensional, and has 2 connected components.*

Proof. It suffices to consider only $w = w_{\text{sp}}$. With

$$Y_{\text{Leaf}} = \prod_{ijk} Q(ijk) \quad \text{and} \quad Y'_{\text{Leaf}} = \prod_{ijk} Q'(ijk).$$

we have

$$\text{Gr}(w) \cong \text{Gr}(Q_{\text{sp}}) \times_{Y'_{\text{Leaf}}} Y_{\text{Leaf}}$$

As the morphism $Y_{\text{Leaf}} \rightarrow Y'_{\text{Leaf}}$ is smooth and surjective with connected fibers, its pull-back $\varphi : \text{Gr}(w) \rightarrow \text{Gr}(Q_{\text{sp}})$ is also smooth and surjective with connected fibers. The thin Schubert cell $\text{Gr}(Q_{\text{sp}})$ is smooth and 7-dimensional with 2 connected components by Proposition 4.2. Therefore, $\text{Gr}(w)$ is smooth and 15-dimensional with 2 connected components by Proposition 3.1. \square

We prove Theorem 1.3 in the following form.

Theorem 5.2. *Let \mathcal{C} be any cone of $\mathcal{S}_{\text{trop}}(3, 8)$ in the \mathfrak{S}_8 -orbit of \mathcal{C}_{sp} , and w in the relative interior of \mathcal{C} . The initial degeneration $\text{in}_w \text{Gr}_0(3, 8)$ is smooth and has two connected components.*

Proof. It suffices to consider the case $w = w_{\text{sp}}$. Being the limit of a flat degeneration of $\text{Gr}_0(3, 8)$, the initial degeneration $\text{in}_w \text{Gr}_0(3, 8)$ is 15-dimensional. As $\text{in}_w \text{Gr}_0(3, 8)$ is a smooth and 15-dimensional affine scheme with 2 connected components, the closed immersion from Theorem 2.1 is an isomorphism if its image meets the two components of $\text{Gr}(w)$. Denote by $\psi : \text{in}_w \text{Gr}_0(3, 8) \rightarrow X(Q_{\text{sp}})$ the composition

$$\text{in}_w \text{Gr}_0(3, 8) \xrightarrow{\varphi_w} \text{Gr}(w) \rightarrow \text{Gr}(Q_{\text{sp}}) \rightarrow X(Q_{\text{sp}})$$

where the middle morphism is φ from the proof of Proposition 5.1 and the right morphism is the quotient by the diagonal torus $H \subset \text{PGL}(8)$; both morphisms are surjective with connected fibers. Consider the $\mathbb{C}(t)$ -valued matrix

$$A_t = \begin{bmatrix} 1 & 0 & 0 & 1 & t & 1+4t & 1-t & 1-t^2 \\ 0 & 1 & 0 & 1+t & 1+t & a+t & 1-2t & a-t \\ 0 & 0 & 1 & 1+2t & 1+3t & 2t & 1-a+t & 1+t^2 \end{bmatrix}$$

where $a \in \mathbb{C}$ is a solution of $x^2 - x + 1 = 0$. Denote by $\vec{p}(A_t)$ the vector of homogeneous Plücker coordinates of A_t . The tropicalization (i.e., coordinatewise valuation with respect to the t -adic valuation on $\mathbb{C}(t)$) of $\vec{p}(A_t)$ is w , so its exploded tropicalization $\vec{x}(A_t) = \mathfrak{Trop}(\vec{p}(A_t))$ (in the sense of [32]) lies in $\text{in}_w \text{Gr}_0(3, 8)$. By [6, Remark 3.6] the morphism ψ takes $\vec{x}(A_t)$ to $\vec{p}(A)$, where A is the matrix from Formula (4.5). Switching between the two solutions a of $x^2 - x + 1 = 0$, this shows that ψ is surjective. As the composition $\text{Gr}(w) \rightarrow X(\mathbb{Q}_{\text{sp}})$ is continuous and surjective and φ_w is continuous, the image of φ_w meets the two connected components of $\text{Gr}(w)$, as required. \square

6. PROOFS OF THEOREM 1.1 AND 1.4

In this section we prove Theorems 1.1 and 1.4. We do so by showing that, except for w contained in the relative interior of a cone in the \mathfrak{S}_8 -orbit of \mathcal{C}_{sp} , the inverse limits $\text{Gr}(w)$ of $(3, 8)$ -matroid strata are smooth and irreducible of dimension 15, and therefore so are $\text{in}_w \text{Gr}_0(3, 8)$ by Corollary 2.2. We begin by describing how to compute the coordinate ring of an inverse limit of thin Schubert cells using the affine coordinates from §4.1.

6.1. Coordinate rings for finite inverse limits of thin Schubert cells. First, consider the more general setup. Let $\Delta \subset M_{\mathbb{R}}$ be any lattice polytope with vertex-set Q . For $w \in N(Q)_{\mathbb{R}}$, let $\mathcal{Q}(w)$ be the corresponding regular subdivision of Δ , and $\text{TS}(w)$ its tight-span. Given a cell C of $\text{TS}(w)$, denote by Δ_C the corresponding cell of $\mathcal{Q}(w)$. Let $\Sigma \subset \text{TS}(w)$ be a connected subcomplex, and $\Delta \subset \mathcal{Q}(w)$ its dual (i.e., the union of cells Δ_C for $C \subset \Sigma$). We say that Σ is *vertex-intersecting* if

$$\bigcap_{v \in V(\Sigma)} \Delta_v \neq \emptyset$$

and Σ is *vertex-connecting* for each vertex x of Δ , the subcomplex of Σ formed by the cells C with $x \in \Delta_C$ is connected.

Proposition 6.1. *Suppose (v, e) is a leaf pair of Σ , and Σ' is the subcomplex obtained by removing v and e . If Σ is vertex-connecting then Σ' is vertex-connecting.*

Proof. This follows from the fact that there is a hyperplane in $M_{\mathbb{R}}$ that separates Δ_v from the rest of Δ along Δ_e . \square

Proposition 6.2. *Suppose F is a fin of Σ whose connecting path has length 1, and Σ' is the subcomplex obtained by removing F° and all of its exposed vertices and edges. If Σ is vertex-connecting then Σ' is vertex-connecting.*

Proof. Suppose C and C' are two cells of Σ' such that $x \in \Delta_C \cap \Delta_{C'}$. As Σ is vertex-connecting, there is a sequence $C_* = (C_1, C_2, \dots, C_{k-1}, C_k)$ of *distinct* cells in Σ such that

- $C = C_1$ and $C' = C_k$,
- C_i is a face of C_{i+1} (or vice versa), and
- $x \in \Delta_{C_i}$ for each $i = 1, \dots, k$.

If C_* passes through F , then $x \in \Delta_F$ and therefore $x \in \Delta_e$ where e is the connecting edge. So one may modify C_* so that it misses F , as well as its exposed vertices and edges. If C_* does not pass through F but does pass through an exposed vertex or edge, then it must pass through all exposed vertices and edges, as well as the vertices of the connecting edge e . This implies again that $x \in \Delta_e$, so we may modify C_* to be a path entirely in Σ' . \square

Now suppose Q is a matroid, $w \in \text{Dr}(Q)$, and $\Sigma \subset \text{TS}(w)$ is a connected subcomplex. Given a cell C of Σ , let Q_C be its corresponding matroid. Suppose Σ is vertex-intersecting; this means that there is a basis common to the Q_v for $v \in V(\Sigma)$. For simplicity, assume that the common basis is $[r]$. Define

$$B_\Sigma = \mathbb{C}[x_{ij} : [r] \Delta \{i, r + j\} \in Q_v \text{ for some } v \in V(\Sigma)]$$

Next, define the ideal and multiplicative semigroup

$$I_\Sigma = \sum_{v \in V(\Sigma)} I_{Q_v} \cdot B_\Sigma \quad \text{and} \quad S_\Sigma = \langle S_{Q_v} : v \in V(\Sigma) \rangle_{\text{semigrp}}$$

note that we may view each S_{Q_v} as a subset of B_Σ under the inclusion $B_{Q_v} \subset B_\Sigma$. Finally, set

$$(6.1) \quad R_\Sigma = (S_\Sigma)^{-1} B_\Sigma / I_\Sigma$$

Proposition 6.3. *If Σ is vertex-intersecting and vertex-connecting, then the coordinate ring of the inverse limit $\varprojlim_\Sigma \text{Gr}$ is isomorphic to R_Σ .*

Proof. The proof is similar to that of [5, Proposition 6.5], so we only provide a sketch. The coordinate ring of $\varprojlim_\Sigma \text{Gr}$ is $\varinjlim_\Sigma R_Q$ (indeed, Spec is right-adjoint to the global-sections functor, and hence takes direct limits to inverse limits). For each cell C of Σ , the inclusion $B_{Q_C} \subset B_\Sigma$ induces a ring morphism $R_{Q_C} \rightarrow R_\Sigma$. By the universal property, these induce a ring map $\Phi : \varinjlim_\Sigma R_Q \rightarrow R_\Sigma$. Now let us define the inverse $\Psi : R_\Sigma \rightarrow \varinjlim_\Sigma R_Q$. Suppose $x_{ij} \in B_\Sigma$, and C is a cell such that $x_{ij} \in B_{Q_C}$. Set $\Psi(x_{ij}) = \alpha_C(x_{ij})$ where $\alpha_C : R_{Q_C} \rightarrow \varinjlim_\Sigma R_Q$ is the structure map. Suppose x_{ij} also lies in $B_{Q_{C'}}$; as Σ is vertex-connecting, we may reduce to the case where C' is a face of C . Then $\alpha_{C'}(x_{ij}) = (\varphi_{Q_C, Q_{C'}})^\# \circ \alpha_C(x_{ij})$, and so $\Psi : B_\Sigma \rightarrow \varinjlim_\Sigma R_Q$ is well-defined. All that is left is to show that Ψ passes to the localization and quotient R_Σ , which is a verification we leave to the reader. \square

6.2. Combinatorial classification of diagrams. The secondary fan structure of the tropical Grassmannian $\text{TGr}_0(3, 8)$ is computed in [2]. It has a 7-dimensional lineality space, and its f -vector is

$$f(\text{TGr}_0(3, 8)) = (f_7, \dots, f_{15}) \equiv (1, 12, 155, 1149, 5013, 12736, 18798, 14714, 4766) \pmod{\mathfrak{S}_8}.$$

A *combinatorial type* is a \mathfrak{S}_8 -orbit of a cone in $\mathcal{S}_{\text{trop}}(3, 8)$, and we typically record a combinatorial type by a vector w in the relative interior of a cone in an \mathfrak{S}_8 -orbit. There are 57 344 combinatorial types of $\mathcal{S}_{\text{trop}}(3, 8)$. Consider the following conditions (see §3.1 for the definitions of Σ_L and Σ_{Br}):

- (1) The tight-span $\text{TS}(w)$ is vertex-intersecting.
- (2) The dual graph $\Gamma(w)$ is a tree.
- (3) The subcomplex Σ_L of $\text{TS}(w)$ is vertex-intersecting.
- (4) The subcomplex Σ_{Br} of $\text{TS}(w)$ is vertex-intersecting.
- (5) The subcomplex of Σ_L obtained by removing all fins of Σ_L whose connecting path (see §2.4) has length 1 is vertex-intersecting.
- (6) The subcomplex of Σ_L obtained by removing all fins of Σ_L (of any connecting path length) is a tree.

While these conditions are not mutually exclusive, we can still use this to separate all the subdivisions into 6 sets: set G_j consists of those subdivisions that satisfy condition (j) but not (i) for $i < j$.

6.3. **Case G_1 .** There are 13 641 subdivisions belonging to the set G_1 .

Proposition 6.4. *If $w \in G_1$, then $\text{Gr}(w)$ is smooth and irreducible of dimension 15.*

This is a direct consequence of the following proposition.

Proposition 6.5. *Suppose $w \in \text{TGr}_0(r, n)$ and $\text{TS}(w)$ is basis-intersecting. Then $\text{Gr}(w)$ is isomorphic to an open subvariety of $\mathbb{A}^{r(n-r)}$. In particular, $\text{in}_w \text{Gr}_0(r, n)$ and $\text{Gr}(w)$ are smooth and irreducible of dimension $r(n-r)$.*

Proof. The tight-span $\text{TS}(w)$ is basis-connecting by [6, Proposition C.11] (Appendix by Cueto). By Proposition 6.3, we have that $\text{Gr}(w)$ is a locally-closed subscheme of $\mathbb{A}^{r(n-r)}$, in particular $\dim \text{Gr}(w) \leq r(n-r)$. By Theorem 2.1, we have that $\dim \text{Gr}(w) \geq r(n-r)$ as the dimension of $\text{in}_w \text{Gr}_0(r, n)$ is $r(n-r)$. Therefore, $\dim \text{Gr}(w) = r(n-r)$, and so it is isomorphic to an open subvariety of $\mathbb{A}^{r(n-r)}$. The last statement in the proposition follows from Corollary 2.2. \square

6.4. **Case G_2 .** There are 215 subdivisions belonging to the set G_2 .

Proposition 6.6. *Suppose $\Gamma \subset \Gamma(w)$ is a tree, and Q_v is B -maximal for all $v \in V(\Gamma)$ except (possibly) one, say Q_{v_0} . If $\text{Gr}(Q_{v_0})$ is smooth and irreducible, then so is $\varprojlim_{\Gamma} \text{Gr}$.*

Proof. The diagram $\text{Gr} : \Gamma \rightarrow \mathbb{C}\text{-sch}$ satisfies the hypotheses of Proposition 3.2 by Proposition 4.6, and so the limit $\varprojlim_{\Gamma} \text{Gr}$ is smooth and irreducible. \square

Proposition 6.7. *If w represents a combinatorial type in G_2 other than C_{sp} , then $\text{Gr}(w)$ is smooth and irreducible of dimension 15.*

Proof. There are 210 combinatorial types w so that $\Gamma = \Gamma(w)$ satisfies the hypothesis of Proposition 6.6, and so $\text{Gr}(w)$ is smooth and irreducible in these cases. For the 4 remaining cases, all Q_v have 2 or more parallel elements for all but at most one $v \in V(\Gamma)$. These diagrams satisfy the conditions of Proposition 3.2 by [6, Proposition 5.4] and [loc. cit. Lemma C.5] (Appendix by Cueto). Finally, we compute the dimensions of each limit $\text{Gr}(w)$ using Formula 3.1, and verify that each dimension is 15. \square

Example 6.8. Here we use an explicit example as a demonstration of Proposition 6.6. Let $w \in \text{TGr}_0(3, 8)$ be

$$w = e_{126} + e_{234} + e_{237} + 2e_{238} + e_{247} + e_{248} + e_{278} + e_{347} + e_{348} + e_{378} + 2e_{478} + e_{568}$$

The tight-span $\text{TS}(w)$ of the subdivision $\mathcal{Q}(w)$ is the tree given in Figure 6.1.

The matroids Q_2 and Q_3 are illustrated in the middle of Figure 6.1. The remaining Q_i are

$$Q_1 = U(34578, 1, 2, 6), \quad Q_4 = U(14567, 2, 3, 8), \quad Q_5 = U(12347, 5, 6, 8), \quad Q_6 = U(12356, 4, 7, 8).$$

Denote by $Q_{i,j}$ the matroid of the edge between the vertices corresponding to Q_i and Q_j . The matroid $Q_{2,3}$ is illustrated by the right picture in Figure 6.1, and the remaining

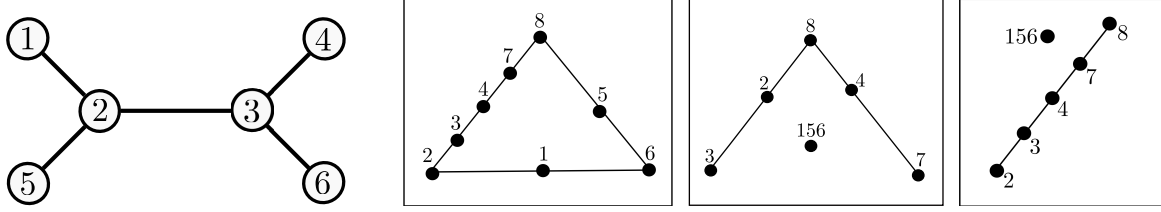

FIGURE 6.1. Dual graph of $Q(w)$ and the matroids corresponding to Q_2 , Q_3 and $Q_{2,3}$

matroids $Q_{i,j}$ for $(i,j) \neq (2,3)$ are isomorphic to $U'(a,b,c; [8] \setminus abc)$. The dimensions of the thin Schubert cells $\text{Gr}(Q_i)$ and $\text{Gr}(Q_{i,j})$ are

$$\dim \text{Gr}(Q_i) = \begin{cases} 7 & \text{if } i \in \{1,4,5,6\} \\ 10 & \text{if } i = 2 \\ 9 & \text{if } i = 3 \end{cases} \quad \dim \text{Gr}(Q_{i,j}) = \begin{cases} 6 & \text{if } (i,j) \in \{(1,2), (2,5), (3,4), (3,6)\} \\ 8 & \text{if } (i,j) = (2,3) \end{cases}$$

With $\mu_1 = \{2,6,8\}$ and $\mu_2 = \{1,4,7\}$, the matroids Q_1, Q_2, Q_4, Q_5 are (B, μ_1) -maximal and Q_6 is (B, μ_2) -maximal, but Q_3 is not B -maximal. As Q_3 is not isomorphic to Q_{sp} , we see that $\text{Gr}(Q_3)$ is smooth and irreducible. Therefore, $\text{Gr}(w)$ is smooth and irreducible of dimension 15 by Proposition 3.2, and so $\text{in}_w \text{Gr}_0(3,8)$ is smooth and irreducible by Corollary 2.2.

6.5. **Case G_3 .** There are 28 227 subdivisions belonging to the set G_3 . Given such a combinatorial type w , let $\Sigma = \text{TS}(w)$, and $\Sigma_{\text{L}} \subset \Sigma$ the subcomplex obtained by removing all leaf-vertices of Σ together with their adjacent edges. Set

$$(6.2) \quad Y_{\text{Leaf}} = \prod_{\substack{v \text{ leaf} \\ \text{vertex}}} \text{Gr}(Q_v) \quad Y'_{\text{Leaf}} = \prod_{\substack{e \text{ leaf} \\ \text{edge}}} \text{Gr}(Q_e)$$

Then

$$(6.3) \quad \text{Gr}(w) \cong \varprojlim_{\Sigma} \text{Gr} \cong \varprojlim_{\Sigma_{\text{L}}} \text{Gr} \times_{Y'_{\text{Leaf}}} Y_{\text{Leaf}}.$$

Proposition 6.9. *If $\varprojlim_{\Sigma_{\text{L}}} \text{Gr}$ is smooth and irreducible, then $\text{Gr}(w)$ is smooth and irreducible of dimension*

$$(6.4) \quad \dim \text{Gr}(w) = \dim \varprojlim_{\Sigma_{\text{L}}} \text{Gr} - \sum_{\substack{e \text{ leaf} \\ \text{edge}}} \dim \text{Gr}(Q_e) + \sum_{\substack{v \text{ leaf} \\ \text{vertex}}} \dim \text{Gr}(Q_v)$$

Proof. For each leaf-pair (v,e) , the morphism $\text{Gr}(Q_v) \rightarrow \text{Gr}(Q_e)$ is smooth and dominant with connected fibers by Proposition 4.4, and therefore $Y_{\text{Leaf}} \rightarrow Y'_{\text{Leaf}}$ also an SDC-morphism. The proposition now follows from Proposition 3.2. \square

Proposition 6.10. *For any combinatorial type w , the subcomplex Σ_{L} is vertex-connecting.*

Proof. The complex $\text{TS}(w)$ is vertex-connecting by [6, Lemma C.11] (Appendix by Cueto). Now apply Proposition 6.1. \square

By Propositions 6.3 and 6.10, the coordinate ring of $\varprojlim_{\Sigma_{\text{L}}} R_Q$ is isomorphic to $R_{\Sigma_{\text{L}}}$. Thus, we need some techniques for determining when a ring of the form R_{Σ} is a regular (i.e., its

local rings are regular) integral domain. We work in the following more general context. Let $M = \mathbb{Z}^b$ with standard basis $\epsilon_1^*, \dots, \epsilon_b^*$, let $x_i \in \mathbb{C}[M]$ be the variable corresponding to ϵ_i^* . More generally, let $x^u \in \mathbb{C}[M]$ be the monomial corresponding to $u \in M$. Let $B = \mathbb{C}[x_1, \dots, x_b]$. Given $f \in B$, let $u(f)$ be

$$u(f) = \sum_{c_u \neq 0} u \quad \text{where} \quad f = \sum_u c_u x^u.$$

Let $S \subset B$ a finitely generated multiplicative semigroup whose saturation contains the variables x_1, \dots, x_b , and $I \subset B$ an ideal generated by distinct nonzero elements f_1, \dots, f_a ; assume that $a \leq b$ ($a = 0$ if $I = \langle 0 \rangle$). Set $R = S^{-1}B/I$. Let $A(f_1, \dots, f_a)$ be the $a \times b$ matrix with rows $u(f_1), \dots, u(f_a)$.

Lemma 6.11. *If, after a permutation of the rows, the matrix $A(f_1, \dots, f_a)$ has an upper-triangular $(a \times a)$ -submatrix whose diagonal entries equal 1, then $S^{-1}B/I$ is a regular integral domain of Krull dimension $b - a$.*

Proof. We proceed by induction on a . If $a = 0$, then $I = \langle 0 \rangle$, and the conclusion is clear. Now suppose that the lemma is true for values strictly less than a . After permuting the rows and columns (equivalently, permuting the f_i 's and x_j 's), we may assume that the first a columns form an upper triangular matrix whose diagonal entries equal 1. This means that

$$f_1 = g \cdot x_1 - h \quad \text{where} \quad g = c \prod_{i>1} x_i^{u_i}, \quad \text{and} \quad h \in \mathbb{C}[x_2, \dots, x_b]$$

Here, c is a nonzero constant and the u_i are nonnegative. Therefore, the assignment $x_1 \mapsto h/g$, and $x_i \mapsto x_i$ for $i > 1$ defines a ring isomorphism

$$R \rightarrow \bar{S}^{-1}\mathbb{C}[x_2, \dots, x_b]/\langle f_2, \dots, f_b \rangle$$

where \bar{S} is the image of S under the above substitution. The lemma now follows from the inductive hypothesis. \square

Lemma 6.11 suffices to determine that R_{Σ_L} is a regular integral domain for most cases in G_3 . For the remaining, we use the following Algorithm. Given $f \in B$, denote by $\deg_k(f)$ the degree of x_k in f , i.e., the highest power of x_k appearing in f . If $\deg_k(f) = 1$, then denote by $\text{coef}(f; x_k)$ the coefficient of x_k in f . We say that f is *reduced* if f has no unit other than elements of \mathbb{C}^* as a factor. Because B is a unique factorization domain, if $f \in S^{-1}B$ is not a unit, then there is a unique expression (up to a factor lying in \mathbb{C}^*) $f = g \cdot \bar{f}$ such that $g \in S$ and \bar{f} lie in B and has no unit (other than an element of \mathbb{C}^*) as a factor.

Algorithm 6.12.

Input: The polynomial ring $B = \mathbb{C}[x_1, \dots, x_b]$, $S \subset B$ a multiplicative semigroup containing all monomials, and $\mathcal{F} \subset B$ a finite set of reduced generators of $I \subset S^{-1}B$. Set $R = S^{-1}B/I$.

Output: A new presentation of R , say $R \cong \bar{S}^{-1}\bar{B}/\bar{I}$, and a finite set $\bar{\mathcal{F}} \subset \bar{B}$ of reduced generators of $\bar{I} \subset \bar{S}^{-1}\bar{B}$ such that

- \bar{B} is a polynomial ring on a subset of the x_1, \dots, x_b
- for each $x_k \in \bar{B}$ and $f \in \bar{\mathcal{F}}$, we have $\deg_k f \neq 1$ or $\deg_k f = 1$ but $\text{coef}(f; x_k) \notin \bar{S}$.

In particular, if $\bar{I} = \langle 0 \rangle$, then R is a regular integral domain.

Find $f \in \mathcal{F}$ and $x_k \in B$ such that $\deg_k f = 1$ and $\text{coef}(f; x_k) \in S$. This means that

$$f = g \cdot x_k - h$$

for some $g \in S$ and $h \in B$ such that $\deg_k g = 0$ and $\deg_k h = 0$. Then perform the substitution $x_k \mapsto h/g$ followed by a reduction for all elements of \mathcal{F} , and just the substitution for the elements of S ; this produces new sets $\bar{\mathcal{F}}$ and \bar{S} . Set $\bar{B} = \mathbb{C}[x_j : j \neq k]$. Now repeat this procedure with $\mathcal{F} \leftarrow \bar{\mathcal{F}}, S \leftarrow \bar{S}$ and $B \leftarrow \bar{B}$.

Once no such pair (f, x_k) exists, this function returns \mathcal{F} and the presentation $R = S^{-1}B/I$.

Proposition 6.13. *If $w \in G_5$, then $\text{Gr}(w)$ is smooth and irreducible of dimension 15.*

Proof. For 26 187 combinatorial types $w \in G_3$, there is a presentation of the ideal I_{Σ_L} that satisfies the conditions of Lemma 6.11. So $\varprojlim_{\Sigma_L} \text{Gr}$ is smooth and irreducible. For the remaining 2040 combinatorial types, we apply Algorithm 6.12. In each case, this function returns a presentation of R_{Σ_L} whose ideal is $\langle 0 \rangle$, whence R_{Σ_L} , and therefore R_{Σ} , is a regular integral domain. In either case, we get that $\text{Gr}(w)$ is smooth and irreducible by Proposition 6.9.

Finally, we compute the dimensions of each $\text{Gr}(w)$ using Formula (6.4), verify that each dimension is 15. \square

6.6. Case G_4 . There are 483 combinatorial types belonging to the set G_4 .

Proposition 6.14. *If $w \in G_4$, then $\text{Gr}(w)$ is smooth and irreducible of dimension 15.*

Proof. For any $w \in G_4$, it happens to be the case that any branch of $\text{TS}(w)$ is a path, and so each of its vertices has 2 or fewer neighbors. For such a vertex v , its dual polytope Δ_v has 2 or fewer internal facets. Thus, each such $\text{Gr}(Q_v)$ is smooth and irreducible and the maps from $\text{Gr}(Q_v)$ corresponding to the edges adjacent to v are SDC-morphisms by Proposition 4.4. By Proposition 3.4, to show that $\text{Gr}(w)$ is smooth and irreducible, it suffices to show that $\varprojlim_{\Sigma_{\text{Br}}} \text{Gr}$ is smooth and irreducible. For 15 combinatorial types, there is a presentation of the ideal $I_{\Sigma_{\text{Br}}}$ that satisfies the conditions of Lemma 6.11. For the remaining 468 combinatorial types, we apply Algorithm 6.12, which always returns the ideal $\langle 0 \rangle$. In either case, we see that $R_{\Sigma_{\text{Br}}}$ is a regular integral domain, as required. Finally, we verify that the dimensions of the $\text{Gr}(w)$ are all 15 using the formula

$$\dim \text{Gr}(w) = \dim \varprojlim_{\Sigma_{\text{Br}}} \text{Gr} - \sum_{\substack{e \text{ branch} \\ \text{edge}}} \dim \text{Gr}(Q_e) + \sum_{\substack{v \text{ branch} \\ \text{vertex}}} \dim \text{Gr}(Q_v)$$

which follows from Formula 3.3. \square

6.7. Case G_5 . There are 14 389 combinatorial types belonging to the set G_5 . Similar to the case G_3 , given a combinatorial type w , let $\Sigma = \text{TS}(w)$ and $\Sigma_L \subset \Sigma$ the subcomplex obtained by removing all leaf-vertices of Σ together with their adjacent edges. Let Y_{Leaf} and Y'_{Leaf} be the schemes in Formula 6.2. Formula 6.3 holds, but now $\varprojlim_{\Sigma_L} \text{Gr}$ cannot be evaluated using a presentation provided by Proposition 6.3 since Σ_L is not vertex-intersecting.

Recall that a fin F is B -maximal if there is a $\mu \in \mathbb{Q}_F$ such that Q is B -maximal for all $Q \in \mathcal{E}_{\text{vert}}(F)$. Given a collection of fins \mathfrak{F} of Σ_L , let $\Sigma_L(\mathfrak{F}) \subset \Sigma_L$ be the subcomplex obtained by removing the fins $F \in \mathfrak{F}$.

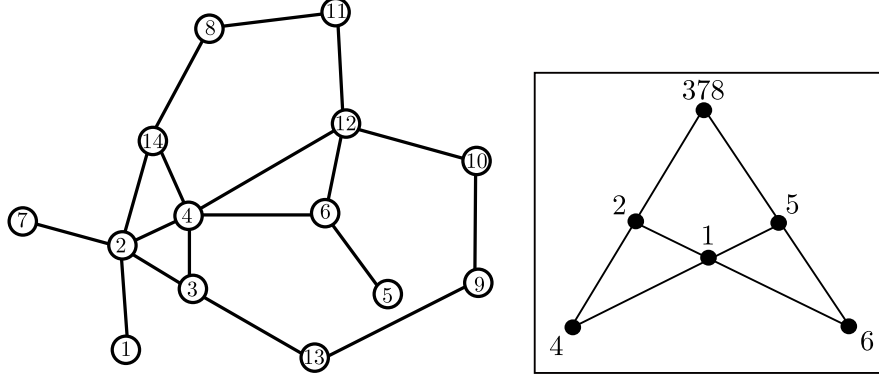
FIGURE 6.2. Dual graph of $Q(w)$ and the matroid corresponding to Q_2

Proposition 6.15. *If $\varprojlim_{\Sigma_L(\mathfrak{F})} \text{Gr}$ is smooth and irreducible and each fin $F \in \mathfrak{F}$ is B -maximal, then $\text{Gr}(w)$ is smooth and irreducible of dimension*

$$(6.5) \quad \begin{aligned} \dim \text{Gr}(w) &= \dim \varprojlim_{\Sigma_L(\mathfrak{F})} \text{Gr} - \sum_{\substack{e \text{ leaf} \\ \text{edge}}} \dim \text{Gr}(Q_e) + \sum_{\substack{v \text{ leaf} \\ \text{vertex}}} \dim \text{Gr}(Q_v) \\ &+ \sum_{F \in \mathfrak{F}} \left(\dim \text{Gr}(Q_F) - \sum_{e \in \mathcal{E}_{\text{edge}}(F)} \dim \text{Gr}(Q_e) + \sum_{v \in \mathcal{E}_{\text{vert}}(F)} \dim \text{Gr}(Q_v) \right) \end{aligned}$$

Proof. By Propositions 3.5 and 4.7, we have that $\varprojlim_{\Sigma_L} \text{Gr}$ is smooth and irreducible of dimension

$$\dim \varprojlim_{\Sigma_L} \text{Gr} = \dim \varprojlim_{\Sigma_L(\mathfrak{F})} \text{Gr} + \sum_{F \in \mathfrak{F}} \left(\dim \text{Gr}(Q_F) - \sum_{e \in \mathcal{E}_{\text{edge}}(F)} \dim \text{Gr}(Q_e) + \sum_{v \in \mathcal{E}_{\text{vert}}(F)} \dim \text{Gr}(Q_v) \right)$$

Now apply Propositions 6.9. □

Proposition 6.16. *If $w \in G_5$, then $\text{Gr}(w)$ is smooth and irreducible of dimension 15.*

Proof. Fix $w \in G_5$, $\Sigma = \text{TS}(w)$, and $\Sigma_L \subset \Sigma$ the subcomplex obtained by removing all leaf vertices and edges. Let \mathfrak{F} be the set of fins of Σ_L that have connecting path length 1. We verify that each $F \in \mathfrak{F}$ is B -maximal. In this case, the set $\Sigma_L(\mathfrak{F})$ is vertex-connecting by Proposition 6.2 and vertex-intersecting by hypothesis, and therefore we may compute the coordinate ring of $\varprojlim_{\Sigma_L(\mathfrak{F})} \text{Gr}$ using Proposition 6.3. We verify that these rings are smooth integral domains as in the proof of Proposition 6.13. Finally, we verify that $\dim \text{Gr}(w) = 15$ using Formula (6.5). The proposition now follows from Corollary 2.2. □

Example 6.17. Let

$$\begin{aligned} w = & e_{124} + e_{125} + 2e_{126} + 3e_{137} + 2e_{138} + 2e_{145} + e_{146} + e_{156} + 2e_{178} + e_{234} + e_{245} + e_{246} + \\ & 2e_{247} + 2e_{248} + e_{256} + 3e_{278} + e_{356} + 2e_{378} + e_{456} + 3e_{478} + 2e_{567} + 2e_{568} + 2e_{578} + 2e_{678}. \end{aligned}$$

The tight span $\text{TS}(w)$ of $Q(w)$ is given in 6.2. We also see the matroid corresponding to the node v_2 of $\text{TS}(w)$ that did not appear in Figure 4.2.

The matroids Q_i corresponding to the vertices v_i of $\Gamma(w)$ are

$$\begin{aligned} Q_1 &= U(34578, 1, 2, 6) & Q_3 &= W(78; 3, 156; 2, 4) & Q_4 &= W(1; 24, 56; 3, 78) \\ Q_5 &= U(24568, 1, 3, 7) & Q_6 &= W(7; 8, 2456; 3, 1) & Q_7 &= U(23678, 1, 4, 5) \\ Q_8 &= U(1234, 78, 5, 6) & Q_9 &= W(1356; 7, 8; 2, 4) & Q_{10} &= U(1356, 24, 7, 8) \\ Q_{11} &= W(1234; 7, 8; 5, 6) & Q_{12} &= W(24; 7, 8; 13, 56) & Q_{13} &= U(1356, 78, 2, 4) \\ Q_{14} &= W(78; 3, 124; 5, 6) \end{aligned}$$

When v_i and v_j share an edge, the matroid of the edge is denoted by $Q_{i,j}$; in each case, $Q_{i,j}$ is isomorphic to a matroid of the form U' . Then Proposition 4.5, and direct computation for the $i = 2$ case, tells us the dimensions of the thin Schubert cells corresponding to the vertices and edges of $\text{TS}(w)$ are given by

$$\dim \text{Gr}(Q_i) = 7 \text{ for } 1 \leq i \leq 14 \quad \dim \text{Gr}(Q_{i,j}) = 6 \text{ for } (v_i, v_j) \in E(\Gamma(w))$$

Moreover, one can check that $\dim \text{Gr}(Q_F) = 5$ for the unique fin $F = \langle v_4, v_6, v_{12} \rangle$ of $\text{TS}(w)$. Finally, we compute $R_{\Sigma_L(\mathfrak{F})}$, to obtain the dimension of $\varprojlim_{\Sigma(\mathfrak{F})}$. We compute

$$B_{\Sigma_L(\mathfrak{F})} = \mathbb{C}[x_{11}, x_{12}, x_{13}, x_{14}, x_{15}, x_{21}, x_{22}, x_{23}, x_{24}, x_{25}, x_{32}, x_{33}, x_{34}, x_{35}]$$

the ideal is

$$I_{\Sigma_L(\mathfrak{F})} = \langle x_{12}x_{23} - x_{11}x_{22}, x_{12}x_{33}x_{24} + x_{22}x_{13}x_{34}, x_{11}x_{33}x_{24} + x_{21}x_{13}x_{34} \rangle,$$

and $S_{\Sigma_L(\mathfrak{F})}$ is the semigroup of all monomials of $B_{\Sigma_L(\mathfrak{F})}$. One can check that the condition of Lemma 6.11 does not hold. Thus we apply Algorithm 6.12. That is, we obtain

$$x_{12} \equiv \frac{x_{11}x_{22}}{x_{21}} \quad \text{and} \quad x_{34} \equiv -\frac{x_{11}x_{33}x_{24}}{x_{21}x_{13}} \pmod{I_{\Sigma_L(\mathfrak{F})}}.$$

Observe that with these substitutions, we have $f_3 = 0$, and that the coordinate ring of $\varprojlim_{\Sigma(\mathfrak{F})} \text{Gr}$ reduces to $\mathbb{C}[x_{11}^\pm, x_{13}^\pm, x_{14}^\pm, x_{15}^\pm, x_{21}^\pm, x_{22}^\pm, x_{23}^\pm, x_{24}^\pm, x_{25}^\pm, x_{32}^\pm, x_{33}^\pm, x_{35}^\pm]$. So we have that $\varprojlim_{\Sigma(\mathfrak{F})} \text{Gr}$ is smooth, irreducible and of dimension 12.

We also have the fin F is B -maximal, in the sense that Q_6 is (B, μ) -maximal where $\mu = \{1, 2, 7\} \in Q_F$. By Proposition 6.15 $\text{Gr}(w)$ is smooth and irreducible. One may use Formula (6.5) to verify that $\dim \text{Gr}(w) = 15$. Hence, by Corollary 2.2, $\text{in}_w \text{Gr}_0(3, 8)$ is smooth and irreducible.

6.8. Case G_6 . There are 389 combinatorial types in G_6 . For each combinatorial type $w \in G_6$, the dual graph $\Gamma(w)$ has a star-tree subgraph T with 4 leaves; the matroid C of the center node is isomorphic to $U(12, 34, 56, 78)$, and the matroids L_1, L_2, L_3, L_4 of the 4 leaves are isomorphic to either $V(12, 34, 56; 7, 8)$ or $W(12; 34, 56; 7, 8)$. The set G_6 splits further into 5 groups H_0, H_1, H_2, H_3, H_4 where $w \in H_k$ if

$$|\{m : L_m \cong V(12, 34, 56; 7, 8)\}| = k.$$

The sizes of the H_k 's are

$$|H_0| = 233 \quad |H_1| = 127 \quad |H_2| = 25 \quad |H_3| = 3 \quad |H_4| = 1$$

Proposition 6.18. *If $w \in H_k$, then the limit $\varprojlim_T \text{Gr}$ is smooth and irreducible of dimension $11 + k$.*

Proof. The matroid C_m corresponding to the edge between C and L_m is isomorphic to $U'(12, 34, 56; 78)$, see Figure 4.2. By Proposition 4.5, the thin Schubert cells $\text{Gr}(C)$, $\text{Gr}(C_m)$, $\text{Gr}(L_m)$ are smooth, irreducible, and their dimensions are $\dim \text{Gr}(C) = 7$, $\dim \text{Gr}(C_m) = 6$ and

$$\dim \text{Gr}(L_m) = 8 \text{ if } L_m \cong V(12, 34, 56; 7, 8); \quad \dim \text{Gr}(L_m) = 7 \text{ if } L_m \cong W(12; 34, 56; 7, 8)$$

Furthermore, the morphisms $\text{Gr}(L_m) \rightarrow \text{Gr}(C_m)$ are smooth and dominant with connected fibers by Proposition 4.5. The proposition now follows from Proposition 3.2. \square

Proposition 6.19. *If $w \in G_6$, then $\text{Gr}(w)$ is smooth and irreducible of dimension 15.*

Proof. Suppose $w \in H_k$, and let $\Sigma = \text{TS}(w)$. As usual, let $\Sigma_{\downarrow} \subset \Sigma$ be the subcomplex obtained by removing all leaf vertices and edges from Σ . By a direct verification, Σ_{\downarrow} consists of the tree T , and 6 fins, each of which has contact-length 2. In fact, there is a fin attached to T at each pair of edges. We verify that each fin is B -maximal. Thus $\text{Gr}(w)$ is smooth and irreducible by Propositions 3.6 and 4.7. Finally, we verify that $\dim \text{Gr}(w) = 15$ using Formula (6.5). The proposition now follows from Corollary 2.2. \square

Example 6.20. The vector

$$\begin{aligned} w = & 2e_{123} + 2e_{124} + 2e_{134} + 2e_{135} + 2e_{136} + 4e_{137} + 3e_{138} + e_{156} + e_{178} + 2e_{234} + e_{245} \\ & + e_{246} + e_{247} + e_{248} + e_{256} + e_{278} + e_{356} + e_{378} + e_{456} + e_{478} + 2e_{567} + 2e_{568} + 2e_{578} + 2e_{678} \end{aligned}$$

represents a combinatorial type in H_0 , the tight span $\text{TS}(w)$ is shown in Figure 6.3, together with the matroids corresponding to the nodes of $\text{TS}(w)$. The tree T consists of the vertices $v_2, v_7, v_9, v_{10}, v_{15}$, and $\varprojlim_T \text{Gr}$ is smooth and irreducible of dimension 11 by Proposition 6.18. The subcomplex $\Sigma_{\downarrow} \subset \text{TS}(w)$ obtained by removing all leaves is obtained by removing the vertex v_3 and its adjacent edge. The fins of Σ_{\downarrow} are:

$$\begin{aligned} F_1 &= \langle v_2, v_4, v_9, v_{15} \rangle & F_2 &= \langle v_2, v_7, v_8, v_9 \rangle & F_3 &= \langle v_6, v_7, v_9, v_{10} \rangle \\ F_4 &= \langle v_9, v_{10}, v_{11}, v_{15} \rangle & F_5 &= \langle v_1, v_2, v_5, v_9, v_{10} \rangle & F_6 &= \langle v_7, v_9, v_{12}, v_{13}, v_{14}, v_{15} \rangle. \end{aligned}$$

With $\mu_1 = \{1, 5, 7\}$ and $\mu_2 = \{1, 2, 5\}$, the fins F_1, F_4, F_6 are (B, μ_1) -maximal, and the fins F_2, F_3, F_5 are (B, μ_2) -maximal. Therefore, $\text{Gr}(w)$ is smooth and irreducible by Propositions 3.6 and 4.7. Using this and Proposition 4.5, one may verify that $\dim \text{Gr}(w) = 15$, and therefore $\text{in}_w \text{Gr}_0(3, 8)$ is smooth and irreducible by Corollary 2.2.

6.9. Completion of the proofs. The following is a compilation of Propositions 5.1, 6.4, 6.7, 6.13, 6.14, 6.16, 6.19, and Corollary 2.2.

Theorem 6.21. *Suppose $w \in \text{TGr}_0(3, 8)$.*

- (1) *The inverse limit $\text{Gr}(w)$ is smooth of dimension 15.*
- (2) *If w is contained in the relative interior of any cone in the \mathfrak{S}_8 -orbit of C_{sp} , then $\text{Gr}(w)$ has 2 connected components. Otherwise, $\text{Gr}(w)$ is irreducible.*
- (3) *The closed immersion $\text{in}_w \text{Gr}_0(3, 8) \hookrightarrow \text{Gr}(w)$ is an isomorphism.*

Proofs of Theorems 1.1 and 1.4. These follow from Theorem 6.21. \square

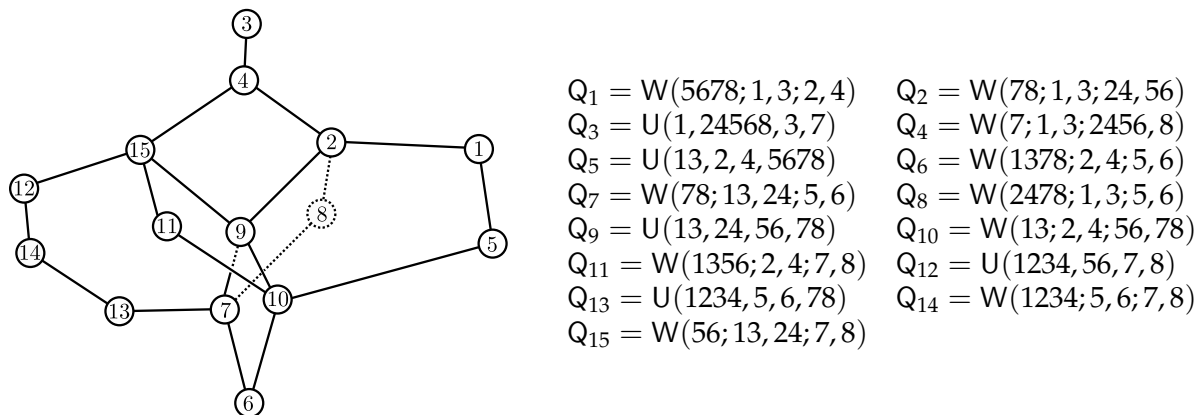

FIGURE 6.3. Left: the tight span $TS(w)$; right: the matroids corresponding to the nodes of $TS(w)$

7. THE CHOW QUOTIENT $Gr(3, 8) // H$

Recall from the introduction that the diagonal torus of $GL(n)$ acts on \mathbb{C}^n by scaling the coordinates, and this induces an action of the diagonal torus $H \subset PGL(n)$ on $Gr(r, n)$. This restricts to a free action on $Gr_0(r, n)$, and under the Gelfand-MacPherson correspondence, the quotient $X(r, n) := Gr_0(r, n)/H$ coincides with the moduli space of projective-equivalence classes of r hyperplanes in \mathbb{P}^{n-1} in linear general position.

Throughout this section, let $Q = \binom{[n]}{r}$ be the uniform (r, n) -matroid. Let $L \subset N(Q)$ be the saturated subgroup from Formula (2.1), and $T_L \subset T(Q)$ its corresponding torus. Then $T_L \cong H$ and the action of T_L on $\mathbb{P}(\wedge^r \mathbb{C}^n)$ through $T(Q)$ restricts to the action of H on $Gr(r, n)$. Thus, we have an inclusion of Chow quotients

$$Gr(r, n) // H \hookrightarrow \mathbb{P}(\wedge^r \mathbb{C}^n) // H.$$

By [20], the normalization of the Chow quotient $\mathbb{P}(\wedge^r \mathbb{C}^n) // H$ is the toric variety of the pointed fan $\mathcal{S}(r, n)/L_{\mathbb{R}}$, where $\mathcal{S}(r, n)$ is the secondary fan of $\Delta(r, n)$.

Recall that $\mathcal{S}_{\text{trop}}(3, 8)$ is the subfan of $\mathcal{S}(3, 8)$ whose support is $TGr_0(3, 8)$. As $\text{Trop } X(3, 8)$ is $TGr_0(3, 8)/L_{\mathbb{R}}$, the closure of $X(3, 8)$ in the toric variety $X(\mathcal{S}_{\text{trop}}(3, 8)/L_{\mathbb{R}})$ coincides with its closure in $\mathbb{P}(\wedge^r \mathbb{C}^n) // H$ by [37, Proposition 2.3], and we denote this by $\overline{X}(3, 8)$. This space has the same normalization as $Gr(3, 8) // H$. By Theorem 1.1 and the fact that $\text{in}_{\bar{w}} Gr_0(r, n) \cong \text{in}_{\bar{w}} X(r, n) \times H$ (where \bar{w} is the image of w under the quotient $N(Q)_{\mathbb{R}} \rightarrow (N(Q)/L)_{\mathbb{R}}$), we conclude that $X(3, 8)$ is schön, and hence $\overline{X}(3, 8)$ is a schön compactification of $X(3, 8)$ [27, Theorem 1.5]. In particular, $\overline{X}(3, 8)$ is normal and the boundary $B := \overline{X}(3, 8) \setminus X(3, 8)$ is a divisor.

Theorem 7.1. *The log-canonical divisor $K_{\overline{X}} + B$ of $\overline{X} = \overline{X}(3, 8)$ is ample. In particular, $\overline{X}(3, 8)$ is the log-canonical compactification of $X(3, 8)$.*

Proof. By [13, Theorem 9.1], it suffices to show that each irreducible stratum is log minimal. As $\overline{X}(3, 8)$ is a schön compactification, its strata are also schön by Formula (7.1) and [28, Corollary 4.2.10]. By [13, Theorem 3.1], a schön very affine variety $X \subset T$ is log minimal if and only if it is not preserved under translation by a subtorus of T . This last property holds if and only if $\text{Trop}(X) \subset N_{\mathbb{R}}$ is not preserved under translation by a rational subspace of $N_{\mathbb{R}}$ [21, Lemma 5.2].

Given a cone \mathcal{C} of $\mathcal{S}_{\text{trop}}(3, 8)/L_{\mathbb{R}}$, denote by $X_{\mathcal{C}}$ the intersection of $\overline{X}(3, 8)$ with the torus orbit of $X(\mathcal{S}_{\text{trop}}(3, 8)/L_{\mathbb{R}})$ corresponding to \mathcal{C} . By [15, Lemma 3.6], there is an isomorphism

$$(7.1) \quad \text{in}_w X(3, 8) \cong X_{\mathcal{C}} \times (\mathbb{G}_m)^{\dim \mathcal{C}}$$

where w is any point in the relative interior of \mathcal{C} . The fan $\mathcal{S}_{\text{trop}}(3, 8)/L_{\mathbb{R}}$ is convexly disjoint by [33, Proposition 7.9]. This proves that the strata $X_{\mathcal{C}}$ of $\overline{X}(3, 8)$ which are irreducible, i.e., for cones \mathcal{C} not in the \mathfrak{S}_8 -orbit of \mathcal{C}_{sp} by Theorem 1.4, are log minimal. But the strata $X_{\mathcal{C}}$ for \mathcal{C} in the \mathfrak{S}_8 -orbit of \mathcal{C}_{sp} each consists of two disjoint points, which are individually log minimal, as required. \square

REFERENCES

- [1] S. Awodey. *Category theory*, volume 52 of *Oxford Logic Guides*. Oxford University Press, Oxford, second edition, 2010.
- [2] D. Bendle, J. Boehm, Y. Ren, and B. Schröter. Parallel computation of tropical varieties, their positive part, and tropical Grassmannians, 2020. arXiv:2003.13752.
- [3] J. Bezanson, A. Edelman, S. Karpinski, and V. B. Shah. Julia: A fresh approach to numerical computing. *SIAM Review*, 59(1):65–98, 2017.
- [4] H. Brenner and S. Schröer. Ample families, multihomogeneous spectra, and algebraization of formal schemes. *Pacific J. Math.*, 208(2):209–230, 2003.
- [5] D. Corey. Initial degenerations of spinor varieties. Preprint, arXiv:2104.03442.
- [6] D. Corey. Initial degenerations of Grassmannians. *Sel. Math. New Ser.*, 27(57), 2021.
- [7] J. A. De Loera, J. Rambau, and F. Santos. *Triangulations*, volume 25 of *Algorithms and Computation in Mathematics*. Springer-Verlag, Berlin, 2010. Structures for algorithms and applications.
- [8] C. Eder, W. Decker, C. Fieker, M. Horn, and M. Joswig, editors. *The OSCAR book*. 2024.
- [9] E. Gawrilow and M. Joswig. *polymake: a Framework for Analyzing Convex Polytopes*, pages 43–73. Birkhäuser Basel, Basel, 2000.
- [10] I. Gelfand, M. Goresky, R. MacPherson, and V. Serganova. Combinatorial geometries, convex polyhedra, and Schubert cells. *Adv. in Math.*, 63(3):301–316, 1987.
- [11] I. M. Gelfand and R. D. MacPherson. Geometry in Grassmannians and a generalization of the dilogarithm. *Adv. in Math.*, 44(3):279–312, 1982.
- [12] I. M. Gelfand and V. V. Serganova. Combinatorial geometries and the strata of a torus on homogeneous compact manifolds. *Uspekhi Mat. Nauk*, 42(2(254)):107–134, 287, 1987.
- [13] P. Hacking, S. Keel, and J. Tevelev. Stable pair, tropical, and log canonical compactifications of moduli spaces of del Pezzo surfaces. *Invent. Math.*, 178(1):173–227, 2009.
- [14] R. Hartshorne. *Algebraic Geometry*. Springer, 1977.
- [15] D. Helm and E. Katz. Monodromy filtrations and the topology of tropical varieties. *Canad. J. Math.*, 64(4):845–868, 2012.
- [16] S. Herrmann. On the facets of the secondary polytope. *J. Combin. Theory Ser. A*, 118(2):425–447, 2011.
- [17] S. Herrmann, A. Jensen, M. Joswig, and B. Sturmfels. How to draw tropical planes. *The Electronic Journal of Combinatorics*, 16(2), 2009.
- [18] M. Kaluba, B. Lorenz, and S. Timme. Polymake.jl: A new interface to polymake. In A. M. Bigatti, J. Crette, J. H. Davenport, M. Joswig, and T. de Wolff, editors, *Mathematical Software – ICMS 2020*, pages 377–385, Cham, 2020. Springer International Publishing.
- [19] M. Kapranov. Chow quotients of Grassmannians. I. In *I. M. Gelfand Seminar*, volume 16 of *Adv. Soviet Math.*, pages 29–110. Amer. Math. Soc., Providence, RI, 1993.
- [20] M. M. Kapranov, B. Sturmfels, and A. V. Zelevinsky. Quotients of toric varieties. *Math. Ann.*, 290(4):643–655, 1991.
- [21] E. Katz and S. Payne. Realization spaces for tropical fans. In *Combinatorial aspects of commutative algebra and algebraic geometry*, volume 6 of *Abel Symp.*, pages 73–88. Springer, Berlin, 2011.
- [22] S. Keel and J. McKernan. Contractible extremal rays on $\overline{M}_{0,n}$. In *Handbook of moduli. Vol. II*, volume 25 of *Adv. Lect. Math. (ALM)*, pages 115–130. Int. Press, Somerville, MA, 2013.

- [23] S. Keel and J. Tevelev. Geometry of Chow quotients of Grassmannians. *Duke Math. J.*, 134(2):259–311, 2006.
- [24] L. Lafforgue. *Chirurgie des grassmanniennes*, volume 19 of *CRM Monograph Series*. American Mathematical Society, Providence, RI, 2003.
- [25] S. H. Lee and R. Vakil. Mnëv-Sturmfels universality for schemes. In *A celebration of algebraic geometry*, volume 18 of *Clay Math. Proc.*, pages 457–468. Amer. Math. Soc., Providence, RI, 2013.
- [26] M. Luxton. *The log canonical compactification of the moduli space of six lines in \mathbb{P}^2* . ProQuest LLC, Ann Arbor, MI, 2008. Thesis (Ph.D.)–The University of Texas at Austin.
- [27] M. Luxton and Z. Qu. Some results on tropical compactifications. *Trans. Amer. Math. Soc.*, 363(9):4853–4876, 2011.
- [28] D. Maclagan and B. Sturmfels. *Introduction to Tropical Geometry*, volume 161 of *Graduate Studies in Mathematics*. American Mathematical Society, Providence, RI, 2015.
- [29] Y. Matsumoto, S. Moriyama, H. Imai, and D. Bremner. Matroid enumeration for incidence geometry. *Discrete Comput. Geom.*, 47(1):17–43, 2012.
- [30] Oscar – open source computer algebra research system, version 0.8.3-dev, 2022.
- [31] J. Oxley. *Matroid theory*. Oxford Science Publications. The Clarendon Press, Oxford University Press, New York, 1992.
- [32] S. Payne. Fibers of tropicalization. *Math. Z.*, 262(2):301–311, 2009.
- [33] N. Schock. Quasilinear tropical compactifications, 2021. arXiv:2112.02062.
- [34] D. Speyer. Tropical linear spaces. *SIAM J. Discrete Math.*, 22(4):1527–1558, 2008.
- [35] D. Speyer and B. Sturmfels. The tropical Grassmannian. *Adv. Geom.*, 4:389–411, 2004.
- [36] T. Stacks project authors. The stacks project. <https://stacks.math.columbia.edu>, 2022.
- [37] J. Tevelev. Compactifications of subvarieties of tori. *Amer. J. Math.*, 129(4):1087–1104, 2007.
- [38] R. Vakil. Murphy’s law in algebraic geometry: badly-behaved deformation spaces. *Invent. Math.*, 164(3):569–590, 2006.
- [39] A. N. Varčenko. Newton polyhedra and estimates of oscillatory integrals. *Funkcional. Anal. i Priložen.*, 10(3):13–38, 1976.
- [40] A. N. Varčenko. Zeta-function of monodromy and Newton’s diagram. *Invent. Math.*, 37(3):253–262, 1976.