

New Superbridge Index Calculations from Non-Minimal Realizations

Clayton Shonkwiler

Department of Mathematics, Colorado State University, Fort Collins, CO

Abstract

Previous work [22] used polygonal realizations of knots to reduce the problem of computing the superbridge number of a realization to a linear programming problem, leading to new sharp upper bounds on the superbridge index of a number of knots. The present work extends this technique to polygonal realizations with an odd number of edges and determines the exact superbridge index of many new knots, including the majority of the 9-crossing knots for which it was previously unknown and, for the first time, several 12-crossing knots. Interestingly, at least half of these superbridge-minimizing polygonal realizations do not minimize the stick number of the knot; these seem to be the first such examples. [Appendix A](#) gives a complete summary of what is currently known about superbridge indices of prime knots through 10 crossings and [Appendix B](#) gives all knots through 16 crossings for which the superbridge index is known.

1 Introduction

Given a tamely embedded closed curve γ in \mathbb{R}^3 , its *superbridge number* $\text{sb}(\gamma)$ is the maximum number of local maxima of any projection of γ to a line. For a knot type K , its *superbridge index* $\text{sb}[K]$ is the minimum superbridge number of any realization of K . This knot invariant was first defined by Kuiper [13], and was the first example of a so-called *superinvariant* [1, 3].

Although Kuiper determined it for all torus knots, the superbridge index is generally quite hard to compute; for example, prior to this work it was known for only 49 of the 249 nontrivial knots in the Rolfsen table. The goal here is to determine the superbridge index of a number of knots, including 15 of the 27 9-crossing knots for which it was previously unknown and, for the first time, for some 12-crossing knots.

Theorem 1. *The knots $9_3, 9_4, 9_6, 9_9, 9_{11}, 9_{13}, 9_{17}, 9_{18}, 9_{22}, 9_{23}, 9_{25}, 9_{27}, 9_{30}, 9_{31}$, and 9_{36} have superbridge index equal to 4, and the knots $11n_{72}, 11n_{77}, 12n_{60}, 12n_{66}, 12n_{219}, 12n_{225}$, and $12n_{553}$ have superbridge index equal to 5.*

For each knot, the strategy is to find a (polygonal) realization of the knot with superbridge number equal to a known lower bound; the realizations of 9_{25} and $12n_{66}$ are shown in [Figure 1](#), and visualizations and coordinates for all knots mentioned in the theorem are given in [Appendix C](#). These realizations were found by generating very large ensembles of polygonal knots in tight confinement using the approach described in [9] and implemented in `stick-knot-gen` [8]. Overall, I generated more than 1 trillion random 9-, 10-, 11-, 12-, and 13-gons in the search for these examples. Interestingly, at least half of these superbridge-minimizing examples do not minimize the stick number of the knot. For example, the polygonal realization of 9_{25} shown in [Figure 1](#) has 11 edges, but there are polygonal realizations of 9_{25} with only 10 edges [9].

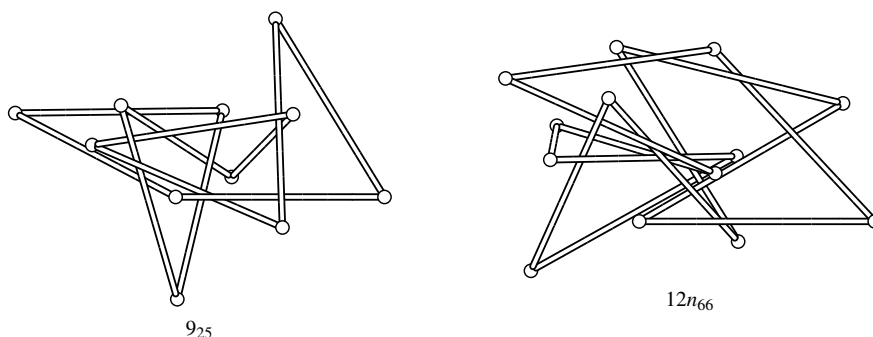

Figure 1: Superbridge-minimizing realizations of 9_{25} and $12n_{66}$. Both are shown in orthographic perspective, viewed from the direction of the positive z -axis relative to the vertex coordinates given in [Appendix C](#).

Aside from the computational challenge of generating such large ensembles and determining knot types, the main difficulty is to identify potential examples and to rigorously compute their superbridge numbers. Different knots in the statement of the theorem require different arguments, so the proof will proceed in the following three sections, each of which groups together knots requiring the same argument, sorted in order of increasing complexity. Specifically, [Theorem 1](#) is a direct consequence of [Corollary 5](#), [Proposition 8](#), and [Proposition 11](#).

For reference, [Appendix A](#) gives complete, up-to-date information about the superbridge index of all knots from the Rolfsen table, and [Appendix B](#) lists all prime knots through 16 crossings for which the exact superbridge index is known. This information, along with the coordinate data from [Appendix C](#), is also available from the `stick-knot-gen` project [8].

2 Stick number bounds

The easiest way to get an upper bound on superbridge index is using Jin’s bound relating superbridge index to stick number. Recall that the *stick number* $\text{stick}[K]$ of a knot K is the minimum number of edges needed for any polygonal realization of the knot.

Theorem 2 (Jin [12]). *For any knot K , $\text{sb}[K] \leq \frac{1}{2} \text{stick}[K]$.*

Both $11n_{72}$ and $12n_{553}$ have stick number no bigger than 11.

Proposition 3. $\text{stick}[11n_{72}], \text{stick}[12n_{553}] \leq 11$.

Proof. 11-stick realizations of both knots are shown in [Figure 2](#). The coordinates of these realizations are given in [Appendix C](#). \square

It is then an immediate consequence of [Theorem 2](#) that these knots both have superbridge index ≤ 5 . On the other hand, a useful lower bound on superbridge index comes from the bridge index $\text{b}[K]$.

Theorem 4 (Kuiper [13]). *For any nontrivial knot K , $\text{b}[K] < \text{sb}[K]$.*

Since $11n_{72}$ and $12n_{553}$ are both 4-bridge knots [5, 14, 16], this completely determines the superbridge index of both knots.

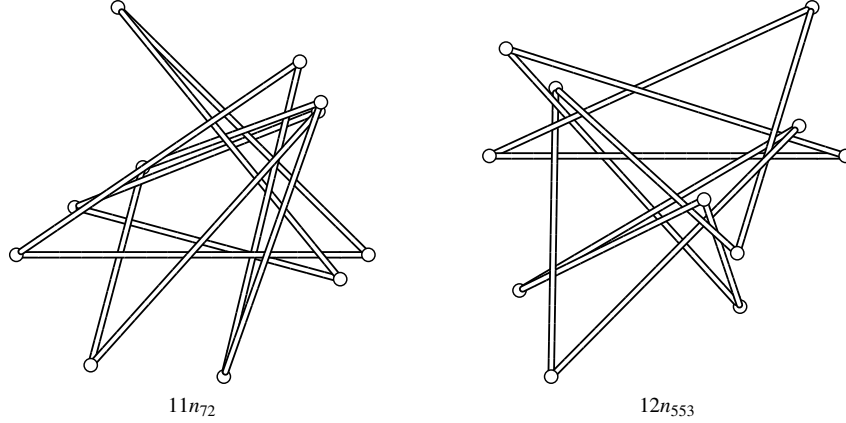

Figure 2: 11-stick realizations of $11n_{72}$ and $12n_{553}$. Both are shown in orthographic perspective, viewed from the direction of the positive z -axis relative to the vertex coordinates given in [Appendix C](#).

Corollary 5. $\text{sb}[11n_{72}] = \text{sb}[12n_{553}] = 5$.

3 Linear programming bounds

The proof of Jin's bound $\text{sb}[K] \leq \frac{1}{2} \text{stick}[K]$ ([Theorem 2](#)) is straightforward: the projection of any polygonal closed curve to a line cannot have more critical points than there are vertices along the original curve. In other words, the superbridge number of any n -edge polygonal realization of a knot is no more than $\frac{n}{2}$. This is more significant than it might first appear, since it is generally quite challenging to give any useful upper bound on the superbridge number of a closed curve. After all, if the projection of a closed curve γ in to a line has k local maxima, this shows that $\text{sb}(\gamma) \geq k$: the inequality goes the wrong way! So it is a special situation to have an easily computed certificate (in this case, the count of edges) that a particular realization of a knot has superbridge number $\leq m$ for some concrete m .

The problem is that Jin's bound can be arbitrarily bad: while there are only finitely many knots K with $\text{stick}[K] \leq n$ for any n [[6](#), [17](#)], there are infinitely many knots with superbridge index equal to 4 (including all $(2, p)$ -torus knots [[13](#)]). So it is frequently necessary to find some other way of certifying an upper bound on the superbridge number of a realization.

In a previous paper [[22](#)], I developed a new approach based on linear programming, as follows. Suppose a polygonal closed curve has edge vectors $\vec{e}_1, \dots, \vec{e}_n$. Then for any $\vec{v} \in \mathbb{R}^3$, the number of local maxima of the projection of the curve to the line spanned by \vec{v} is the number of times that $\vec{v} \cdot \vec{e}_i$ changes from positive to negative (computed cyclically, so that $\vec{v} \cdot \vec{e}_n > 0$ and $\vec{v} \cdot \vec{e}_1 < 0$ contributes 1 to the count). Jin's bound implies that $\text{sb}(\vec{e}_1, \dots, \vec{e}_n) \leq \frac{n}{2}$, with equality if and only if n is even and there is some line onto which every vertex projects to a local minimum or a local maximum; i.e., $\vec{v} \cdot \vec{e}_1, \dots, \vec{v} \cdot \vec{e}_n$ alternates signs. Since \vec{v} can be replaced by $-\vec{v}$, it is no restriction to assume that the alternating sign pattern is $+, -, \dots, +, -$.

Equivalently, if

$$E := [\vec{e}_1 \mid -\vec{e}_2 \mid \dots \mid \vec{e}_{2k-1} \mid -\vec{e}_{2k}], \quad (1)$$

then $\text{sb}(\vec{e}_1, \dots, \vec{e}_{2k}) < k$ if and only if there is no $\vec{v} \in \mathbb{R}^3$ so that $\vec{v}^T E$ has all positive entries. In other words,

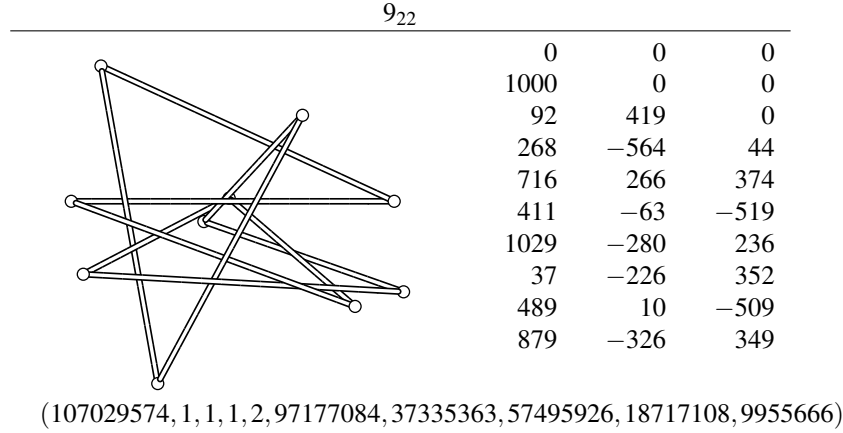

Figure 3: A 10-stick 9_{22} with superbridge number 4. The three columns to the right of the image give the coordinates of the vertices, and the vector below is the \vec{u} solving (2). The knot is shown in orthographic perspective, viewed from the direction of the positive z -axis.

infeasibility of a system of linear inequalities provides a stronger upper bound on the superbridge number of a polygonal realization of a knot than that coming from Jin's bound.

This is helpful, because classical theorems of the alternative [7, 23] control feasibility of such systems. For example:

Theorem 6 (Gordan [10]). *If A is a $k \times \ell$ matrix, then exactly one of the following is true:*

- (i) *There is $\vec{v} \in \mathbb{R}^k$ so that $\vec{v}^T A$ has all positive entries.*
- (ii) *There is a nonzero vector $\vec{u} \in \mathbb{R}^\ell$ with nonnegative entries so that $A\vec{u} = \vec{0}$.*

This yields the desired bound on superbridge numbers.

Corollary 7 (Shonkwiler [22]). *Suppose $\vec{e}_1, \dots, \vec{e}_{2k}$ are the edges of a closed polygonal curve in \mathbb{R}^3 . Then $\text{sb}(\vec{e}_1, \dots, \vec{e}_{2k}) < k$ if and only if there exists a nonzero vector $\vec{u} \in \mathbb{R}^n$ with nonnegative entries so that*

$$E\vec{u} = \vec{0}, \tag{2}$$

with the matrix E defined as in (1).

The vector \vec{u} provides a certificate that the superbridge number of the polygonal realization is strictly less than half the number of vertices. This approach is enough to determine the superbridge indices of four more knots in the statement of Theorem 1.

Proposition 8. $\text{sb}[9_{22}] = 4$ and $\text{sb}[11n_{77}] = \text{sb}[12n_{60}] = \text{sb}[12n_{219}] = 5$.

Proof. By [Theorem 9](#), stated below, $\text{sb}[9_{22}] \geq 4$. On the other hand, [Figure 3](#) gives a 10-stick realization of 9_{22} which has superbridge number ≤ 4 . To verify this with [Corollary 7](#), it suffices to find a nonzero vector $\vec{u} \in \mathbb{R}^{10}$ with nonnegative entries so that

$$\begin{bmatrix} 1000 & 908 & 176 & -448 & -305 & -618 & -992 & -452 & 390 & 879 \\ 0 & -419 & -983 & -830 & -329 & 217 & 54 & -236 & -336 & -326 \\ 0 & 0 & 44 & -330 & -893 & -755 & 116 & 861 & 858 & 349 \end{bmatrix} \vec{u} = \vec{0}.$$

It is easy to check that

$$\vec{u} = (107029574, 1, 1, 1, 2, 97177084, 37335363, 57495926, 18717108, 9955666)$$

is such a vector, so this completes the proof that $\text{sb}[9_{22}] = 4$.

A similar argument shows that the knots $11n_{77}$, $12n_{60}$, and $12n_{219}$ have superbridge index ≤ 5 : 12-stick realizations of these knots together with vectors \vec{u} solving (2) are given in [Appendix C](#). The certificate vectors \vec{u} were found using *Mathematica's* `FindInstance` function.

Since $11n_{77}$, $12n_{60}$, and $12n_{219}$ are all 4-bridge knots [[5](#), [14](#), [16](#)], [Theorem 4](#) implies that each of these knots has superbridge index ≥ 5 , completing the proof that their superbridge indices are exactly 5. \square

Each of the polygonal realizations used in the above proof was originally generated with coordinates given as double-precision floating point numbers. However, these coordinates were all rounded to three significant digits and converted to integers (while verifying this did not change the knot type) to make it easier to verify the existence of exact solutions to (2).

The lower bound on $\text{sb}[9_{22}]$ comes from Jeon and Jin's characterization of the possible 3-superbridge knots.

Theorem 9 (Jeon–Jin [[11](#)]). *Every knot except 3_1 and 4_1 and possibly 5_2 , 6_1 , 6_2 , 6_3 , 7_2 , 7_3 , 7_4 , 8_4 , and 8_9 has superbridge index ≥ 4 .*

This statement is slightly different than the one given in Jeon and Jin's paper, which included 8_7 among the possible 3-superbridge knots; see [[22](#)] for the proof that $\text{sb}[8_7] = 4$.

4 An extension to odd numbers of edges

Between [Proposition 8](#) and [[22](#)], [Corollary 7](#) has now been used to determine the superbridge indices of 21 8- and 9-crossing knots, but as stated it is limited to polygonal realizations of knots with an even number of edges. The goal now is to extend this approach to polygonal knots with an odd number of edges.

Suppose $\vec{e}_1, \dots, \vec{e}_{2k+1}$ are the edge vectors of some closed polygonal curve in \mathbb{R}^3 . By [Theorem 2](#), $\text{sb}(\vec{e}_1, \dots, \vec{e}_{2k+1}) \leq k$. If this is actually an equality, then there must be some vector $\vec{v} \in \mathbb{R}^3$ so that the projection of the polygon to the line containing \vec{v} has exactly k local maxima, meaning that the list $\vec{v} \cdot \vec{e}_1, \dots, \vec{v} \cdot \vec{e}_{2k+1}$ switches from positive to negative k times (when considered cyclically). After possibly replacing \vec{v} with $-\vec{v}$, the sign pattern can be assumed to be some cyclic permutation of

$$+, +, -, +, -, \dots, +, -.$$

Let $(s_1, \dots, s_{2k+1}) = (0, 0, 1, 0, 1, \dots, 0, 1)$ and, for each $j \in \{1, \dots, 2k+1\}$, define the matrix

$$E_j := [(-1)^{s_1+j} \vec{e}_1 \mid (-1)^{s_2+j} \vec{e}_2 \mid \dots \mid (-1)^{s_{2k+1}+j} \vec{e}_{2k+1}],$$

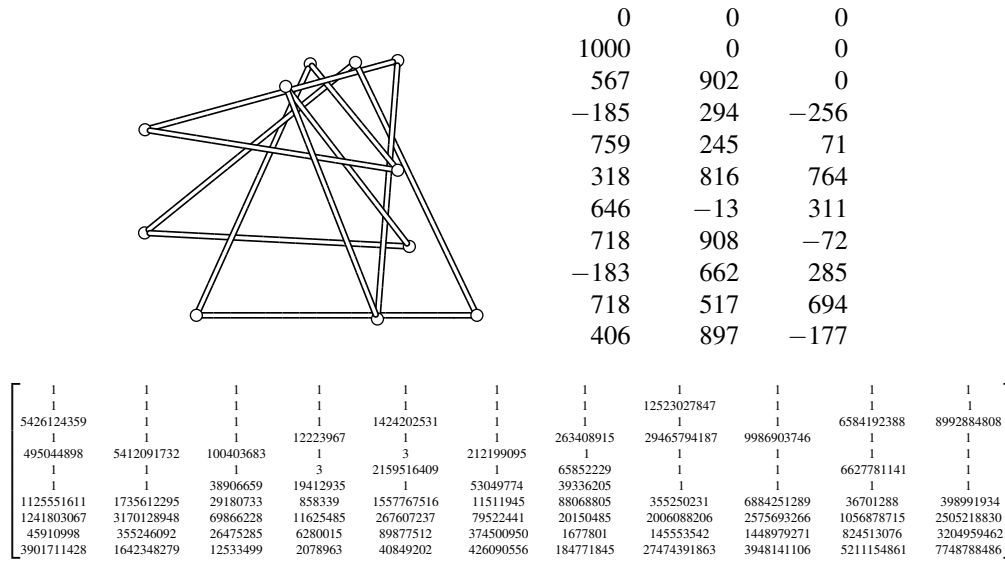

Figure 4: Visualization of an 11-stick realization of 9₃₆ with superbridge number 4. The three columns to the right of the image give the coordinates of the vertices, and the matrix below is the U whose columns are the \vec{u}_j satisfying (3). The knot is shown in orthographic perspective, viewed from the direction of the positive z -axis.

where the subscripts are computed cyclically (i.e., $s_{2k+2} = s_1$, $s_{2k+3} = s_2$, etc.).

Then $\text{sb}(\vec{e}_1, \dots, \vec{e}_{2k+1}) = k$ if and only if there exist $\vec{v} \in \mathbb{R}^3$ and $j \in \{1, \dots, 2k+1\}$ so that $\vec{v}^T E_j$ has all positive entries. Contrapositively, none of the linear systems $\vec{v}^T E_j > 0$ have solutions if and only if $\text{sb}(\vec{e}_1, \dots, \vec{e}_{2k+1}) < k$. Stated in this way, the following corollary of Theorem 6 gives new bounds on the superbridge indices of polygonal curves with an odd number of edges.

Corollary 10. *Suppose $\vec{e}_1, \dots, \vec{e}_{2k+1}$ are the edge vectors of a closed polygonal curve in \mathbb{R}^3 . Then the curve has superbridge number $< k$ if and only if there exist nonzero vectors $\vec{u}_1, \dots, \vec{u}_{2k+1} \in \mathbb{R}^{2k+1}$ with nonnegative entries solving the matrix equations*

$$E_j \vec{u}_j = \vec{0} \tag{3}$$

for all $j = 1, \dots, 2k+1$. If $U = [\vec{u}_1 | \dots | \vec{u}_{2k+1}]$, the $(2k+1) \times (2k+1)$ matrix U serves as a computable certificate of the superbridge number bound.

Corollary 10 can now be used to determine the superbridge indices of the rest of the knots in Theorem 1.

Proposition 11. *The knots 9₃, 9₄, 9₆, 9₉, 9₁₁, 9₁₃, 9₁₇, 9₁₈, 9₂₃, 9₂₅, 9₂₇, 9₃₀, 9₃₁, and 9₃₆ have superbridge index equal to 4, and $\text{sb}[12n_{66}] = \text{sb}[12n_{225}] = 5$.*

Proof. Each of these knots has superbridge index ≥ 4 by Theorem 9, so for the 9-crossing knots it suffices to find 11-stick realizations and certificate matrices U showing they have superbridge number ≤ 4 , as in

Corollary 10. $12n_{66}$ and $12n_{225}$ are both 4-bridge knots [5, 14], so their superbridge indices are ≥ 5 and it suffices to find 13-stick realizations with corresponding U .

These realizations and certificate matrices are given in [Appendix C](#). The entry for 9_{36} is reproduced in [Figure 4](#). In each case, a visualization of the knot is shown next to the coordinates of the vertices, and the matrix U is given below. \square

5 Conclusion

One virtue of [Corollary 10](#) is that it provides examples of superbridge-minimizing polygonal knots which do not minimize stick number. Specifically, all of the 9-crossing knots mentioned in [Proposition 11](#) except 9_6 , 9_{23} , and 9_{36} are known to have stick number ≤ 10 [9, 19, 21], but to my knowledge there are no 10-stick realizations of these knots with superbridge number 4. For example, in the course of this project I generated 1147 random 10-stick realizations of 9_{27} (out of more than 170 billion random 10-gons), none of which seem to have superbridge number equal to 4. This suggests the very plausible but still intriguing possibility that there may exist knots for which the stick number and superbridge index cannot be achieved by the same realization.

Conjecture 12. There exists a knot type K for which no polygonal realization achieves both $\text{stick}[K]$ and $\text{sb}[K]$.

The algorithm used to generate large ensembles of random polygons for this project produces *equilateral* polygons—that is, closed polygonal curves for which all edges are the same length. While I don’t know of any evidence either way, it is conceivable that minimizing superbridge number is easier with heterogeneous edgelengths, so it might be worthwhile to perform similar investigations with non-equilateral random polygons.

Acknowledgments

Thanks, as ever, to Allison Moore and Chuck Livingston for maintaining KnotInfo [14] and to Jason Cantarella and Tom Eddy for technical support. This work was partially supported by grants from the Simons Foundation (#354225 and #709150).

A Stick Number and Superbridge Index Bounds

Bounds on the superbridge index for prime knots through 10 crossings are given below, including references for where these results were proved. If an exact value is not known, the possible values, as determined by known upper and lower bounds, are given in the form of an interval; e.g., the entry $[3, 4]$ for 5_2 means that $3 \leq \text{sb}[5_2] \leq 4$.

The lower bounds on superbridge index number always comes from either Kuiper’s result $\text{b}[K] < \text{sb}[K]$ for nontrivial knots [13] ([Theorem 4](#)) or Jeon and Jin’s characterization of possible 3-superbridge knots [11] ([Theorem 9](#)), so these references are not explicitly given.

When the upper bound comes from Jin’s bound $\text{sb}[K] \leq \frac{1}{2} \text{stick}[K]$ ([Theorem 2](#)), Jin’s paper [12] is cited along with the current best upper bound on stick number for the knot.

K	$sb[K]$
0 ₁	1
3 ₁	3 [13]
4 ₁	3 [12, 18]
5 ₁	4 [13]
5 ₂	[3, 4] [12]
6 ₁	[3, 4] [12, 15, 17]
6 ₂	[3, 4] [12, 15, 17]
6 ₃	[3, 4] [12, 15, 17]
7 ₁	4 [13]
7 ₂	[3, 4] [12, 15]
7 ₃	[3, 4] [12, 15]
7 ₄	[3, 4] [12, 15]
7 ₅	4 [12, 15]
7 ₆	4 [12, 15]
7 ₇	4 [12, 15]
8 ₁	4 [22]
8 ₂	4 [22]
8 ₃	4 [22]
8 ₄	[3, 4] [22]
8 ₅	4 [22]
8 ₆	4 [22]
8 ₇	4 [22]
8 ₈	4 [22]
8 ₉	[3, 4] [22]
8 ₁₀	4 [22]
8 ₁₁	4 [22]
8 ₁₂	4 [22]
8 ₁₃	4 [22]
8 ₁₄	4 [22]
8 ₁₅	4 [22]
8 ₁₆	4 [12, 19]
8 ₁₇	4 [12, 19]
8 ₁₈	4 [6, 12, 19]
8 ₁₉	4 [13]
8 ₂₀	4 [12, 15, 17]
8 ₂₁	4 [12, 15]
9 ₁	4 [13]
9 ₂	[4, 5] [9, 12]
9 ₃	4 Thm. 1
9 ₄	4 Thm. 1
9 ₅	[4, 5] [12, 19]
9 ₆	4 Thm. 1
9 ₇	4 [22]

K	$sb[K]$
9 ₈	[4, 5] [12, 19]
9 ₉	4 Thm. 1
9 ₁₀	[4, 5] [12, 19]
9 ₁₁	4 Thm. 1
9 ₁₂	[4, 5] [12, 19]
9 ₁₃	4 Thm. 1
9 ₁₄	[4, 5] [12, 19]
9 ₁₅	[4, 5] [9, 12]
9 ₁₆	4 [22]
9 ₁₇	4 Thm. 1
9 ₁₈	4 Thm. 1
9 ₁₉	[4, 5] [12, 19]
9 ₂₀	4 [22]
9 ₂₁	[4, 5] [9, 12]
9 ₂₂	4 Thm. 1
9 ₂₃	4 Thm. 1
9 ₂₄	[4, 5] [12, 19]
9 ₂₅	4 Thm. 1
9 ₂₆	4 [22]
9 ₂₇	4 Thm. 1
9 ₂₈	4 [22]
9 ₂₉	4 [12, 20]
9 ₃₀	4 Thm. 1
9 ₃₁	4 Thm. 1
9 ₃₂	4 [22]
9 ₃₃	4 [22]
9 ₃₄	4 [12, 19]
9 ₃₅	4 [9, 12]
9 ₃₆	4 Thm. 1
9 ₃₇	[4, 5] [12, 19]
9 ₃₈	[4, 5] [12, 19]
9 ₃₉	4 [9, 12]
9 ₄₀	4 [12]
9 ₄₁	4 [12]
9 ₄₂	4 [12]
9 ₄₃	4 [9, 12]
9 ₄₄	4 [12, 19]
9 ₄₅	4 [9, 12]
9 ₄₆	4 [12]
9 ₄₇	4 [12, 19]
9 ₄₈	4 [9, 12]
9 ₄₉	4 [12, 19]
10 ₁	[4, 5] [12, 19]

K	$sb[K]$
10 ₂	[4, 5] [12, 19]
10 ₃	[4, 5] [9, 12]
10 ₄	[4, 5] [12, 19]
10 ₅	[4, 5] [12, 19]
10 ₆	[4, 5] [9, 12]
10 ₇	[4, 5] [9, 12]
10 ₈	[4, 5] [9, 12]
10 ₉	[4, 5] [12, 19]
10 ₁₀	[4, 5] [9, 12]
10 ₁₁	[4, 5] [12, 19]
10 ₁₂	[4, 5] [12, 19]
10 ₁₃	[4, 5] [12, 19]
10 ₁₄	[4, 5] [12, 19]
10 ₁₅	[4, 5] [9, 12]
10 ₁₆	[4, 5] [9, 12]
10 ₁₇	[4, 5] [9, 12]
10 ₁₈	[4, 5] [12, 21]
10 ₁₉	[4, 5] [12, 19]
10 ₂₀	[4, 5] [9, 12]
10 ₂₁	[4, 5] [9, 12]
10 ₂₂	[4, 5] [9, 12]
10 ₂₃	[4, 5] [9, 12]
10 ₂₄	[4, 5] [9, 12]
10 ₂₅	[4, 5] [12, 19]
10 ₂₆	[4, 5] [9, 12]
10 ₂₇	[4, 5] [12, 19]
10 ₂₈	[4, 5] [9, 12]
10 ₂₉	[4, 5] [12, 19]
10 ₃₀	[4, 5] [9, 12]
10 ₃₁	[4, 5] [9, 12]
10 ₃₂	[4, 5] [12, 19]
10 ₃₃	[4, 5] [12, 19]
10 ₃₄	[4, 5] [9, 12]
10 ₃₅	[4, 5] [9, 12]
10 ₃₆	[4, 5] [12, 19]
10 ₃₇	[4, 5] [2]
10 ₃₈	[4, 5] [9, 12]
10 ₃₉	[4, 5] [9, 12]
10 ₄₀	[4, 5] [12, 19]
10 ₄₁	[4, 5] [12, 19]
10 ₄₂	[4, 5] [12, 19]
10 ₄₃	[4, 5] [9, 12]
10 ₄₄	[4, 5] [9, 12]

K	$sb[K]$		K	$sb[K]$		K	$sb[K]$	
10 ₄₅	[4, 5]	[12, 19]	10 ₈₈	[4, 5]	[12, 19]	10 ₁₃₁	[4, 5]	[9, 12]
10 ₄₆	[4, 5]	[9, 12]	10 ₈₉	[4, 5]	[12, 19]	10 ₁₃₂	[4, 5]	[12, 19]
10 ₄₇	[4, 5]	[9, 12]	10 ₉₀	[4, 5]	[9, 12]	10 ₁₃₃	[4, 5]	[9, 12]
10 ₄₈	[4, 5]	[12, 19]	10 ₉₁	[4, 5]	[9, 12]	10 ₁₃₄	[4, 5]	[12, 19]
10 ₄₉	[4, 5]	[12, 19]	10 ₉₂	[4, 5]	[12, 19]	10 ₁₃₅	[4, 5]	[12, 19]
10 ₅₀	[4, 5]	[9, 12]	10 ₉₃	[4, 5]	[12, 21]	10 ₁₃₆	[4, 5]	[12, 19]
10 ₅₁	[4, 5]	[9, 12]	10 ₉₄	[4, 5]	[9, 12]	10 ₁₃₇	[4, 5]	[9, 12]
10 ₅₂	[4, 5]	[12, 19]	10 ₉₅	[4, 5]	[9, 12]	10 ₁₃₈	[4, 5]	[9, 12]
10 ₅₃	[4, 5]	[9, 12]	10 ₉₆	[4, 5]	[12, 19]	10 ₁₃₉	[4, 5]	[12, 19]
10 ₅₄	[4, 5]	[9, 12]	10 ₉₇	[4, 5]	[9, 12]	10 ₁₄₀	[4, 5]	[12, 19]
10 ₅₅	[4, 5]	[9, 12]	10 ₉₈	[4, 5]	[12, 19]	10 ₁₄₁	[4, 5]	[12, 19]
10 ₅₆	[4, 5]	[9, 12]	10 ₉₉	[4, 5]	[12, 19]	10 ₁₄₂	[4, 5]	[9, 12]
10 ₅₇	[4, 5]	[9, 12]	10 ₁₀₀	[4, 5]	[12, 21]	10 ₁₄₃	[4, 5]	[9, 12]
10 ₅₈	[4, 5]	[12, 21]	10 ₁₀₁	[4, 5]	[9, 12]	10 ₁₄₄	[4, 5]	[12, 19]
10 ₅₉	[4, 5]	[12, 19]	10 ₁₀₂	[4, 5]	[12, 19]	10 ₁₄₅	[4, 5]	[12, 19]
10 ₆₀	[4, 5]	[12, 19]	10 ₁₀₃	[4, 5]	[9, 12]	10 ₁₄₆	[4, 5]	[12, 19]
10 ₆₁	[4, 5]	[12, 19]	10 ₁₀₄	[4, 5]	[12, 19]	10 ₁₄₇	[4, 5]	[12, 20]
10 ₆₂	[4, 5]	[9, 12]	10 ₁₀₅	[4, 5]	[9, 12]	10 ₁₄₈	[4, 5]	[9, 12]
10 ₆₃	[4, 5]	[12, 19]	10 ₁₀₆	[4, 5]	[9, 12]	10 ₁₄₉	[4, 5]	[9, 12]
10 ₆₄	[4, 5]	[9, 12]	10 ₁₀₇	[4, 5]	[12, 20]	10 ₁₅₀	[4, 5]	[12, 19]
10 ₆₅	[4, 5]	[9, 12]	10 ₁₀₈	[4, 5]	[12, 19]	10 ₁₅₁	[4, 5]	[12, 19]
10 ₆₆	[4, 5]	[12, 21]	10 ₁₀₉	[4, 5]	[12, 19]	10 ₁₅₂	[4, 5]	[12, 21]
10 ₆₇	[4, 5]	[12, 19]	10 ₁₁₀	[4, 5]	[9, 12]	10 ₁₅₃	[4, 5]	[9, 12]
10 ₆₈	[4, 5]	[12, 21]	10 ₁₁₁	[4, 5]	[9, 12]	10 ₁₅₄	[4, 5]	[12, 19]
10 ₆₉	[4, 5]	[12, 19]	10 ₁₁₂	[4, 5]	[9, 12]	10 ₁₅₅	[4, 5]	[12, 19]
10 ₇₀	[4, 5]	[9, 12]	10 ₁₁₃	[4, 5]	[12, 19]	10 ₁₅₆	[4, 5]	[12, 19]
10 ₇₁	[4, 5]	[9, 12]	10 ₁₁₄	[4, 5]	[12, 19]	10 ₁₅₇	[4, 5]	[12, 19]
10 ₇₂	[4, 5]	[9, 12]	10 ₁₁₅	[4, 5]	[9, 12]	10 ₁₅₈	[4, 5]	[12, 19]
10 ₇₃	[4, 5]	[9, 12]	10 ₁₁₆	[4, 5]	[12, 19]	10 ₁₅₉	[4, 5]	[12, 19]
10 ₇₄	[4, 5]	[9, 12]	10 ₁₁₇	[4, 5]	[9, 12]	10 ₁₆₀	[4, 5]	[12, 19]
10 ₇₅	[4, 5]	[9, 12]	10 ₁₁₈	[4, 5]	[9, 12]	10 ₁₆₁	[4, 5]	[12, 19]
10 ₇₆	[4, 5]	[22]	10 ₁₁₉	[4, 5]	[12, 20]	10 ₁₆₂	[4, 5]	[12, 19]
10 ₇₇	[4, 5]	[9, 12]	10 ₁₂₀	[4, 5]	[12, 19]	10 ₁₆₃	[4, 5]	[12, 19]
10 ₇₈	[4, 5]	[9, 12]	10 ₁₂₁	[4, 5]	[12, 19]	10 ₁₆₄	[4, 5]	[9, 12]
10 ₇₉	[4, 5]	[12, 20]	10 ₁₂₂	[4, 5]	[12, 19]	10 ₁₆₅	[4, 5]	[12, 19]
10 ₈₀	[4, 5]	[12, 21]	10 ₁₂₃	[4, 5]	[12, 19]			
10 ₈₁	[4, 5]	[12, 19]	10 ₁₂₄	5	[13]			
10 ₈₂	[4, 5]	[12, 21]	10 ₁₂₅	[4, 5]	[12, 19]			
10 ₈₃	[4, 5]	[9, 12]	10 ₁₂₆	[4, 5]	[9, 12]			
10 ₈₄	[4, 5]	[12, 21]	10 ₁₂₇	[4, 5]	[12, 19]			
10 ₈₅	[4, 5]	[9, 12]	10 ₁₂₈	[4, 5]	[12, 19]			
10 ₈₆	[4, 5]	[12, 19]	10 ₁₂₉	[4, 5]	[12, 19]			
10 ₈₇	[4, 5]	[12, 19]	10 ₁₃₀	[4, 5]	[12, 19]			

B Exact Values of Superbridge Index

The prime knots through 16 crossings for which the exact value of superbridge index is known.

K	sb[K]	K	sb[K]	K	sb[K]
0_1	1	9_{22}	4 Thm. 1	$12n_{225}$	5 Thm. 1
3_1	3 [13]	9_{23}	4 Thm. 1	$12n_{553}$	5 Thm. 1
4_1	3 [12, 18]	9_{25}	4 Thm. 1	$13a_{4878}$	4 [13]
5_1	4 [13]	9_{26}	4 [22]	$13n_{226}$	5 [22]
7_1	4 [13]	9_{27}	4 Thm. 1	$13n_{285}$	5 [4, 12]
7_5	4 [12, 15]	9_{28}	4 [22]	$13n_{293}$	5 [4, 12]
7_6	4 [12, 15]	9_{29}	4 [12, 20]	$13n_{328}$	5 [22]
7_7	4 [12, 15]	9_{30}	4 Thm. 1	$13n_{342}$	5 [22]
8_1	4 [22]	9_{31}	4 Thm. 1	$13n_{343}$	5 [22]
8_2	4 [22]	9_{32}	4 [22]	$13n_{350}$	5 [22]
8_3	4 [22]	9_{33}	4 [22]	$13n_{512}$	5 [22]
8_5	4 [22]	9_{34}	4 [12, 19]	$13n_{587}$	5 [4, 12]
8_6	4 [22]	9_{35}	4 [9, 12]	$13n_{592}$	5 [4, 12]
8_7	4 [22]	9_{36}	4 Thm. 1	$13n_{607}$	5 [4, 12]
8_8	4 [22]	9_{39}	4 [9, 12]	$13n_{611}$	5 [4, 12]
8_{10}	4 [22]	9_{40}	4 [12]	$13n_{835}$	5 [4, 12]
8_{11}	4 [22]	9_{41}	4 [12]	$13n_{973}$	5 [22]
8_{12}	4 [22]	9_{42}	4 [12]	$13n_{1177}$	5 [4, 12]
8_{13}	4 [22]	9_{43}	4 [9, 12]	$13n_{1192}$	5 [4, 12]
8_{14}	4 [22]	9_{44}	4 [12, 19]	$13n_{2641}$	5 [22]
8_{15}	4 [22]	9_{45}	4 [9, 12]	$13n_{5018}$	5 [22]
8_{16}	4 [12, 19]	9_{46}	4 [12]	$14n_{1753}$	5 [22]
8_{17}	4 [12, 19]	9_{47}	4 [12, 19]	$14n_{21881}$	6 [13]
8_{18}	4 [6, 12, 19]	9_{48}	4 [9, 12]	$15a_{85263}$	4 [13]
8_{19}	4 [13]	9_{49}	4 [12, 19]	$15n_{41126}$	5 [4, 12]
8_{20}	4 [12, 15, 17]	10_{124}	5 [13]	$15n_{41127}$	5 [4, 12]
8_{21}	4 [12, 15]	$11a_{367}$	4 [13]	$15n_{41185}$	5 [13]
9_1	4 [13]	$11n_{71}$	5 [9, 12]	$16n_{783154}$	6 [13]
9_3	4 Thm. 1	$11n_{72}$	5 Thm. 1		
9_4	4 Thm. 1	$11n_{73}$	5 [9, 12]		
9_6	4 Thm. 1	$11n_{74}$	5 [9, 12]		
9_7	4 [22]	$11n_{75}$	5 [9, 12]		
9_9	4 Thm. 1	$11n_{76}$	5 [9, 12]		
9_{11}	4 Thm. 1	$11n_{77}$	5 Thm. 1		
9_{13}	4 Thm. 1	$11n_{78}$	5 [9, 12]		
9_{16}	4 [22]	$11n_{81}$	5 [9, 12]		
9_{17}	4 Thm. 1	$12n_{60}$	5 Thm. 1		
9_{18}	4 Thm. 1	$12n_{66}$	5 Thm. 1		
9_{20}	4 [22]	$12n_{219}$	5 Thm. 1		

C Knot Images and Coordinates

This section gives visualizations and coordinates of each of the knot realizations used in the proof of [Theorem 1](#). The knot coordinates are shown in the three columns to the right of the image and normalized so that the first vertex is at the origin, the second is on the positive x -axis, and the third is in the xy -plane with positive y -coordinate. Each knot is shown in orthographic perspective from the direction of the positive z -axis.

For $11n_{72}$ and $12n_{553}$ the coordinates, in conjunction with [Theorem 2](#), are enough to certify the desired upper bound on superbridge index. For the remaining knots, the additional certificate is given below the visualization and coordinates: the vector \vec{u} satisfying (2) for 9_{22} , $11n_{77}$, $12n_{60}$, and $12n_{219}$ and the matrix U from [Corollary 10](#) for the remaining knots.

The original floating-point coordinates can be downloaded from the `stick-knot-gen` project [8].

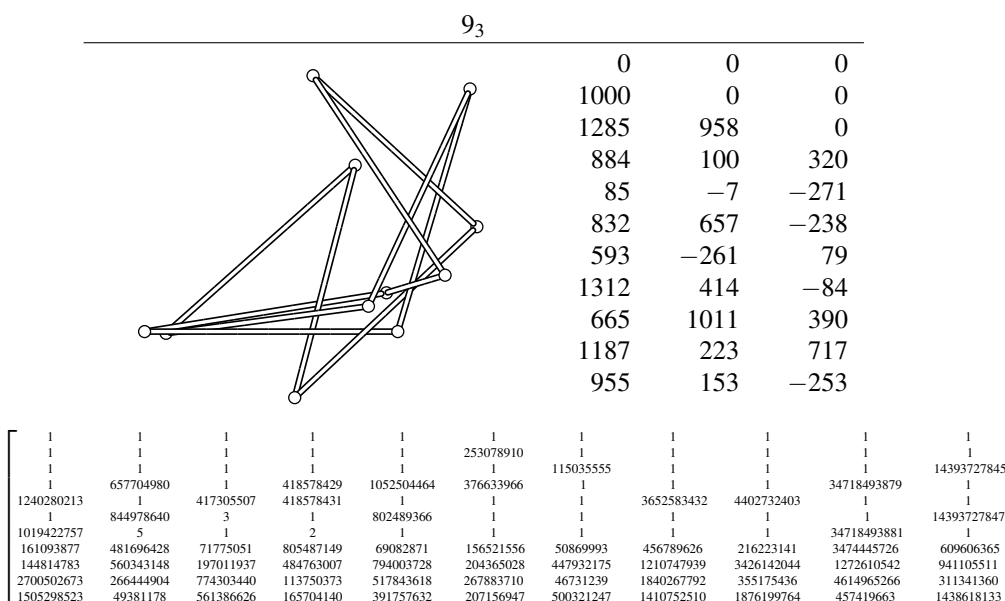

9₄

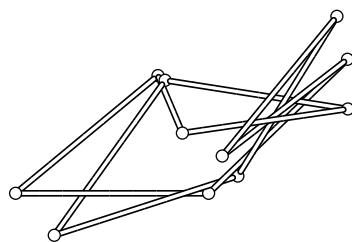

0	0	0
1000	0	0
1720	694	0
1071	193	572
1665	917	221
1151	89	-6
200	-217	33
775	585	-127
1722	437	157
864	312	657
738	610	-289

1	1	1	1	1	1	1	1	1	1	1
1	1	253120999	1	1	1	1	1	1	1	1
1	1	1	1	1	1	152586239	1	1	1	1
1	5387428758	1	1	186051641	1	681384698	1	1	1	1
1	1	1	3	122188121	644758944	1	1	2552652001	1101905682	785500291
412108083	2	1	1	1	1	1	2668475769	1	1	1
1236324265	1	3	28	1	6	528066389	1	1	2038333860	3
15266551	29960368	43047363	7815782	23258145	126807779	46420557	3298398784	655245447	2004553	284780083
207562100	628952294	72634796	19842987	280413639	330174727	24566174	578118108	826423938	1204464626	404153149
737253847	3360035438	396646951	20285775	39377003	41058410	2079635	4867082435	1168804072	161286807	458754813
1464876148	1809746556	78702405	33058272	151532393	185390157	178604983	83268244	1940788369	48127479	1304057157

9₆

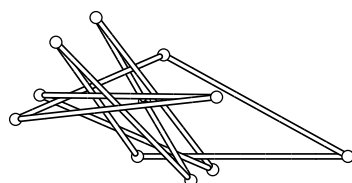

0	0	0
1000	0	0
124	483	0
-580	176	641
376	282	916
-464	291	373
358	-63	-74
-197	660	337
33	261	-551
254	-114	350
-388	543	745

1	1	1	1	1	1	1	1	1	1	1
1	2	1	1	1	1	1	1	1	1112864263	1
2	1	1	1	1	1	1	1	3181145830	1	470098718
1	1	7986790093	1	40446313	1643510504	1	1	1	1	1
1	39162228	1	372465081	20223159	1	233983495	2105861	651976511	1059612083	1
73359287	1	1568714775	186232543	3	1	1	4	2475981364	1	1
32	4	4777752436	3	20223159	1	1	41	1	1	3010168756
24566297	6861048	3862337760	26373238	29977143	772016210	17589227	301023	55104480	16402257	48618876
15491901	17967203	254074348	345511823	13809478	241875406	100606357	1322904	387810364	149231759	24708006
61967286	15123722	171720159	354007729	85119263	82477621	239747297	1371603	254464657	113217341	3471836470
1296156	29089834	107131205	127673557	79207922	2310398106	116606225	1116670	163161428	126899665	265822441

9₉

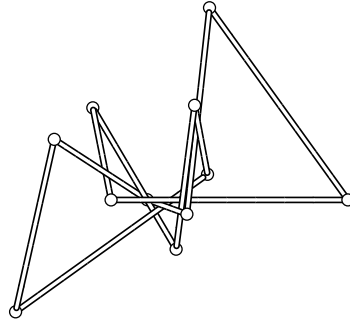

0	0	0
1000	0	0
416	812	0
320	-60	481
153	1	-503
-240	256	380
-403	-473	-285
407	108	-362
353	400	593
275	-208	-197
-77	389	-918

1	1	1	1	1	1	1	1	1	1	1
1	1	1	1	82369555	1	1	12088042132	1	1	1
1	1	1	1	1	1	3617893533	1	1	340470995	1
1280139731	1	485167232	1	1	1599254287	1	1	1	1	1
1	1222246805	338959822	822774430	608229085	1	1	12683277116	486696118	1	4520617633
409077221	5	1	1	3	553545366	3853126796	1	1	3617552792	1
1361329507	6	6	3	1	1	1	1	461787743	2	1
20527753	33291101	127503941	21005683	131493692	232628177	94136669	8530638316	242586007	1626629105	283930053
212668915	76372687	150120702	184229591	113543439	1549831641	2197335797	918626786	29157611	1546137017	600743077
69812503	1482688423	380624447	464206875	633063141	178026749	827882903	103156074	1646260070	1947670452	7136269271
19596715	813474909	507309528	887474901	277868413	964005665	325728759	607309893	976258733	74657653	9140757391

9₁₁

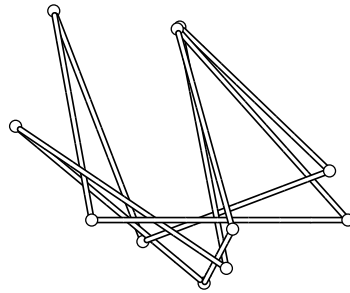

0	0	0
1000	0	0
334	746	0
550	-35	586
439	-246	-386
-297	366	-97
526	-189	26
344	753	-256
928	192	330
200	-84	-297
-148	816	-558

1	1	1	1	1	2368626755	1	1	1	1	1
1	69986829	1	1	4608568067	1	1	1	1	30821056	1
4046685	1	1	1	1	1	1	1	1	1	1
1	3	22114216320	1	1	1	22158061198	1	4153582949	91844549	36384960
1348895	1	1	1	8168076137	2427291954	1	870518840	1	4	1
1348894	126304379	1	673126343	1	1	1	1	5	1	12128320
9969755	6	22675411749	6	1	1	1	5	1	4	7
1141419	14318880	120033110	15770539	736969202	3205461	6055513833	59164979	4170058139	50712235	8554037
6779899	4032158	3968770841	170567743	2030820005	287273843	1413115939	793788443	220881720	47396577	11998081
2511319	1585876	11636038	568931205	63028077	1055081825	363272221	371630189	394308011	17691094	90872208
4828667	93092152	428239011	162250729	1450076601	816658061	21682732901	316274757	1285917521	2503251	80746560

9₁₃

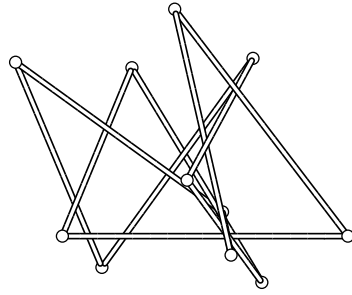

0	0	0
1000	0	0
393	795	0
591	-66	468
561	85	-520
-164	609	-74
138	-110	-700
668	623	-271
437	196	603
699	-162	-293
244	590	-770

1	1	1	1	1	1	1	1	1	1	1	1
1	1	1	1	1	1	1	1	12432112632	1	1	1
1	1	1	1	1	1	1	1	11339684105	1	1	1
1	706806593	36668881	1	1	1	427052599	1798226748	1	1	475777410	1
1267349485	1	1	3356421	1775635611	1	1	1	1	11554699858	1	610536151
1	176701650	62185086	9	1	120609105	2745527355	23509882335	1	1	321874077	610536163
3	353403299	9	36	1	5	1	1	1	5972539667	10	1
1374953025	12777575	19154908	140941	346309809	102880774	14908368	1114940086	368176352	160006563	48285653	48285653
214545333	29260734	1175349	1049985	734912703	320436874	121551897	4360197896	56937195	246871547	925523685	925523685
436700012	247137186	66812691	1046909	776204205	66632749	3387707526	736947444	12676105547	184758886	729412089	729412089
31438527	541200748	53926501	3539751	591593527	304718771	1876484687	132896953	3072164699	112270009	170069412	170069412

9₁₇

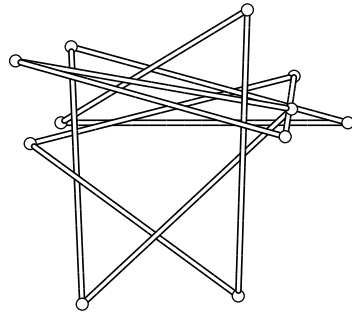

0	0	0
1000	0	0
36	265	0
74	-632	440
804	48	367
-158	216	584
782	-49	802
812	162	-175
-107	-73	140
618	-603	579
650	393	650

1	1	1	1	1	1	1	1	1	1	1	1
1	1	1	1	1	1	1	1	1	1	1	1
1	1600292453	1	1	1	1	190601031	314115327	1	745450626	1	1
51244071966	1	1	1	1262924033	1	1	1	3567406692	1	1	1
1	1	811883609	3321330367	1	1	1	1	1	1610556123	1	5768161968
1	1441937750	811883609	1	745359468	1	891553050	1	1	1	5588584361	1
1	315170260	1	1	1	15	3	1	1	1	1	3
711452253	146509029	163808559	201344147	273695364	16478531	51636951	146789537	193794429	2345490291	5226457968	5226457968
1384779802	32324113	80290392	300782365	373632247	44653888	382761166	1525858575	166933119	2461084575	992448746	992448746
17436879675	1014438289	1191360764	3717284015	653712347	76576878	236870855	395113987	877438948	4189549685	1727525214	1727525214
60159279090	1064293944	13186358	2432067637	655203665	259387067	105123646	2180349855	1620622984	209162485	125557548	125557548

9₁₈

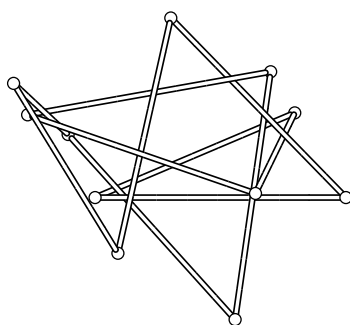

0	0	0
1000	0	0
302	716	0
91	-222	275
-325	455	882
-107	252	-73
558	-487	37
700	502	-23
-269	330	155
640	16	432
796	338	-502

1	1	1	1	1	1	16211286553	1	1	1	1
1	1	30858329	1	1	1	17762217687	1	1	1	1
1	22104539	1	1	1	1	10564969919	1	1	1	728113801
61602923	1	3	1	1	1	1	4024773748	1	74746193045	1
1	22104541	30858331	1	1847148644	1	18892284751	1	1407454648	1	1
54940417	22104541	1	65619096	1	26653970182	1	3832319588	1	1	767409110
11	7	32032131	1	2	5	1	1	1	1	2
11886819	9003228	2839002	2533975	20027306	34502019	1091913663	612386914	304767771	64925682383	282768402
4938585	35780277	2637184	43395440	594214287	221675851	1678374435	4616767263	782809619	3131251157	98095475
108011816	5519263	34323508	46929909	647951814	123826879	5912390181	370257372	897854611	867145469	116125756
54711719	8635998	13161085	79707595	2047261420	74052513	506551563	342704830	529743222	17497321982	400632308

9₂₂

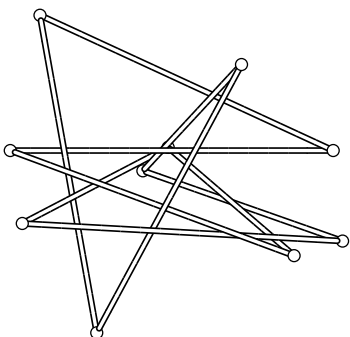

0	0	0
1000	0	0
92	419	0
268	-564	44
716	266	374
411	-63	-519
1029	-280	236
37	-226	352
489	10	-509
879	-326	349

(107029574, 1, 1, 1, 2, 97177084, 37335363, 57495926, 18717108, 9955666)

9₂₃

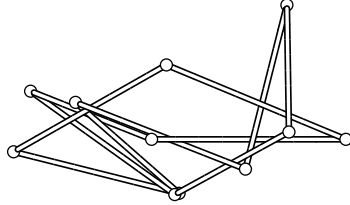

0	0	0
1000	0	0
76	383	0
-710	-64	-426
142	-278	-904
-392	190	-200
483	-153	142
696	691	-349
707	38	408
119	-284	-335
-623	248	-742

1	1	1	1	1	1	1	1	1	1	1
113810777	1	1	1	1	1	1	1	1	1	1
1	1	1	594336189	1	8479535543	1	1	30537981917	7776518141	935753973
1	680343456	231960500	1	107828905	1	5139395402	3019840035	1	1	1
1	1	1	896909239	3	1	1	1	15503757477	7501640367	1
119318597	1	234314796	3	107828904	1	1	1	1	1	2
56853036	29567870	124609038	520536059	152277890	2475787461	42803476	27988073	17838739567	248815653	808601845
146069592	433981826	185544858	91242750	6361840	1542757382	680307370	3759013427	1788832557	1483710229	23545428
25221171	1524919025	44185944	62867966	261897966	38201819	4843137239	2250238379	954919009	5402548506	1666174239
7612446	1177159995	28713449	121524435	111634545	10940129573	2356326855	3131764905	391982953	53376286	668217606

9₂₅

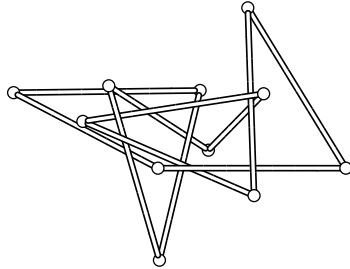

0	0	0
1000	0	0
478	853	0
512	-146	26
-400	249	-92
562	396	138
268	96	-769
-261	438	7
8	-490	-251
224	413	-622
-768	402	-499

1	1	1	1	1	1	1	1	1	1	1
10023997184	1	1	1	1	1	1	1	1	1	1
1	1	1	1	1	1	1	1	1	1	1
1	1	1	1	1	1	1	1	1	1	1
1	1	1	1	1	1	1	1	1	1	1
1	125487117	120699260	268087279	1265219757	28666842360	1365051630	1	1	1144406098	1688445154
1	1	1	1	1	1	1	1	1	1	1
6028182429	1	120699263	3	1426407667	1	1	1	1	6	4
4895581470	567322658	102400928	798486118	22035705	194397770	61350220	1120439309	49352735	110472066	1165703994
6760551	74959938	77412490	66008727	26293220	1361890526	123659494	1299711247	2134873307	820466962	582352931
2399354	643239294	303040821	37886430	140201278	31985620272	1413701530	218763732	690714185	131619140	277914126
214770399	108509612	327975748	851232408	74901645	12181335938	1128149711	1693438564	4800658539	11448665	189208084

9₂₇

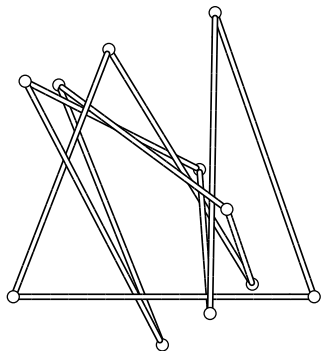

0	0	0
1000	0	0
671	944	0
654	-56	8
619	423	-870
39	716	-109
495	-160	-264
151	704	-632
710	291	87
794	42	-877
318	822	-473

1	1	262889684	1	1	1	1	1	1	1	1	1
1	7847390078	1	1	1	1	1	1	1	1	230952377	1
1	1	1	1	1	1	1	1	873199948	1	1	1
1	31158284984	1	1	1	1	1	1	1	344675452	1	1
83053482	1	1	1	5055431027	13805102457	1	1280024865	1388695196	1413239576	1	15640888756
1	1	4	404554605	1	1	1	1	2777393120	1	1	1
81	4	575819163	5	1	1	1	1568405053	1	1	4	1
21769815	29208119282	1068327	73472469	54731667	12281625511	162551761	373062650	291347024	26899937	271603617	1
35919104	170269626	22441872	384026748	2106979657	224617079	23862425	1356736353	800809090	29063382	2532544202	1
47831262	129202033	783370605	42382366	1213807343	8531371491	1291553665	1812626691	675753926	158354530	13607358180	1
34156617	649855006	163560582	186536581	4106403181	1664690609	629983557	209503010	751141194	447257698	7967627966	1

9₃₀

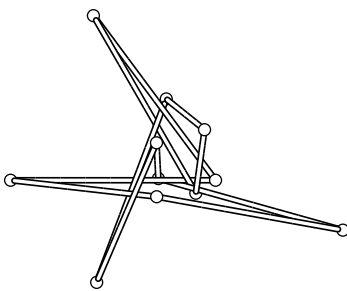

0	0	0
1000	0	0
404	803	0
904	-63	2
946	247	952
759	397	-19
420	-498	270
712	183	942
721	8	-43
1621	-243	312
713	-80	697

1	1	1	1	1	1	1	1	1	1	1	1
12437473	1	1	1	1	1	1	577487407	1	1	1	1
1	1	1	1	1	1	260639873	1	1	1	1	1207138066
1	1	1	3310686559	1	421434401	1	1	6368992901	1	1	1
3	1406257395	24702488	1	8178655003	1	1	1	1	1	703355439	1
1	1	1	3735581387	1	380751573	282519864	670519498	1	25064316807	1	1
77477129	1	49404989	3	7389135180	7	2	1	1	4	1	1
8161120	744540803	7732102	2850370473	32838207	51224612	5804151	60698763	1914312628	43894377	1692119784	1
47463080	944557761	31229795	534698731	303461273	86414122	3214384	421910632	2643878907	825827562	30561789	1
87465935	1090002507	46067476	224985073	3350742742	86138733	234567480	191288209	843984412	34590412498	10989181	1
6400283	1135573793	39123181	1918292057	34826475	11693541	35597081	173958066	5788098369	29129657180	224365433	1

9₃₁

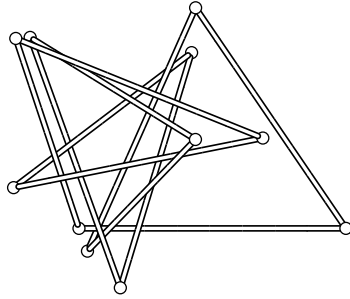

0	0	0
1000	0	0
437	826	0
32	-85	-69
436	333	744
-183	715	58
155	-223	135
422	658	-255
-245	153	292
689	338	598
-237	712	662

1	1	1	1	1	1	1	1	1	1	1	1
491876281	1	1	1	1	1	1	1	3354528574	1	1	1
1	1	1	1	1	1	1	1	2525361769	158087629	46864636843	1
1	25510362	1	1	1	1	1	11242255527	1	1	1	1
454261886	1	1	5284164485	1	1813691147	2885517387	1	6821899449	1	1	1
1	25510364	59543495	1	5803156562	925296372	1	1	1	1	1	1
8	127551842	89315266	2442529200	2468012324	1	1	1	1	9	1	1
258214242	12180665	10277724	5054439091	288241295	49962721	134140596	7144416519	666443081	11291115	36313021745	1
48857123	33735396	35752426	857072468	102767719	458418730	1543535133	1470609912	3230572056	56332267	2577828447	1
10527292	168498480	127077814	61184503	6816702585	1391694775	2754689006	999523140	742278861	70868761	374408352	1
63841640	38539193	82612705	5192781	2488892900	1690661440	3538544765	9879562560	106931688	211428838	33734183487	1

9₃₆

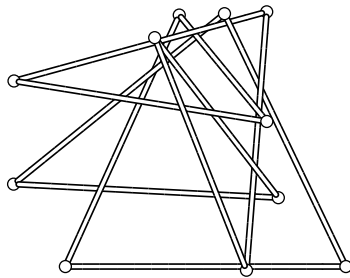

0	0	0
1000	0	0
567	902	0
-185	294	-256
759	245	71
318	816	764
646	-13	311
718	908	-72
-183	662	285
718	517	694
406	897	-177

1	1	1	1	1	1	1	1	1	1	1	1
5426124359	1	1	1	1	1424202551	1	12523027847	1	6584192388	8992884808	1
1	1	1	12223967	1	1	263408915	29465794187	9986903746	1	1	1
495044898	5412091732	100403683	1	3	212199095	1	1	1	1	1	1
1	1	1	3	2159516409	1	65852229	1	1	6627781141	1	1
1	1	38906659	19412935	1	53049774	39336205	1	1	1	1	1
1125551611	1735612295	29180733	858339	1557767516	11511945	88068805	355250231	6884251289	36701288	398991934	1
1241803067	3170128948	69866228	11625485	267607237	79522441	20150485	2006088206	2575693266	1056878715	2505218830	1
45910998	355246092	26475285	6280015	89877512	374500950	1677801	145553542	1448979271	824513076	3204959462	1
3901711428	1642348279	12533499	2078963	40849202	426090556	184771845	27474391863	3948141106	5211154861	7748788486	1

$11n_{72}$			
	0	0	0
	1000	0	0
	289	703	0
	920	-69	74
	166	135	-550
	858	408	118
	211	-313	368
	359	248	-446
	865	433	396
	589	-346	-167
805	549	225	

$11n_{77}$			
	0	0	0
	1000	0	0
	908	996	0
	378	238	382
	109	253	-581
	567	293	307
	14	898	880
	586	442	198
	398	-356	770
	384	622	561
532	-115	-98	
529	661	533	

(1, 1, 4360454070, 1, 1, 1, 4129928398, 1, 3083050732, 480679674, 2231790712, 131796380)

$12n_{60}$			
	0	0	0
	1000	0	0
	273	687	0
	377	-308	-27
	710	581	289
	-232	901	190
	186	282	-475
	465	785	343
	788	-95	-7
	144	462	-532
485	-164	169	
662	565	-492	

(1, 1, 1, 251677634, 1, 1, 221757579, 5, 29397800, 2012040, 102253303, 35434657)

$12n_{66}$

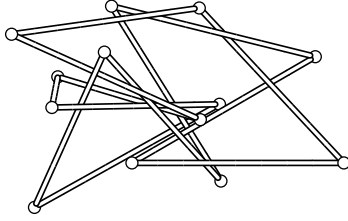

0	0	0
1000	0	0
318	731	0
-568	607	448
323	204	238
-350	406	-474
-378	262	515
413	277	-97
-460	-210	-129
-130	523	466
420	-86	-106
-96	740	124
865	501	-13

1	1	1	1	1	1	1	1	1	1	1	1	1	1	1	1	1059699457
1	1	1	1	1	1	1	1	1	1	1	1	1	1	1	1	1
1	1	1	1	1	1	1	1	1	1	1	1	1	1	1	1	1
1	1	1	1	1	1	1	1	1	1	1	1	1	1	1	1	1
1	1	70743408	11295467	118856988	1	1	1	1	1	1	1	1	1	1	1	1
1367392	26039894	950806273	1	1	1314590355	1	1	5140073610	1	1	1	1	1	1	1	1
1	1	4	1	1	1	1581888017	1	1	1	2526630451	1	1	1	1	1996669148	232048990
1	2	1	1	1	1664395333	1	2917208982	6703631479	1	1	1773528185	1	1	1	1	1
2	1	1	18	213805076	1	1453122638	7367098343	1	1	574251305	1	1	1	1	1	2
22	67668619	10	12092360	1	1	1	1	1	1	1	1	1	1	1	1	2
543662	755483	946422359	6992	45253597	358554124	38580721	707787260	14859163	105984642	155554867	554679128	8970836	1	1	1	1
8453350	20702372	56711902	98579	127573372	212625391	1042794420	2338921294	3018257581	1941994036	1435576911	1438067031	725385343	1	1	1	1
5322026	10050811	13967658	1505123	72512945	2319156951	517848979	678503703	4892804723	169858433	2031348577	444888144	426467670	1	1	1	1
12969476	63055476	1262659	741133	1571326	1789635077	2070400100	39285759	2181390421	1436032321	3297066674	1478778192	69197486	1	1	1	1

$12n_{219}$

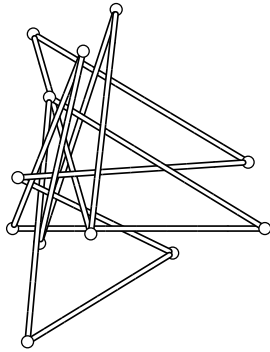

0	0	0
1000	0	0
146	521	0
59	-449	229
635	-97	-510
21	202	221
934	263	-183
82	771	-314
310	-21	252
411	868	-194
107	-58	29
280	703	654

(1, 1, 4642857341, 1, 1, 1, 369809977, 1, 3334333618, 657101686, 872056242, 112908399)

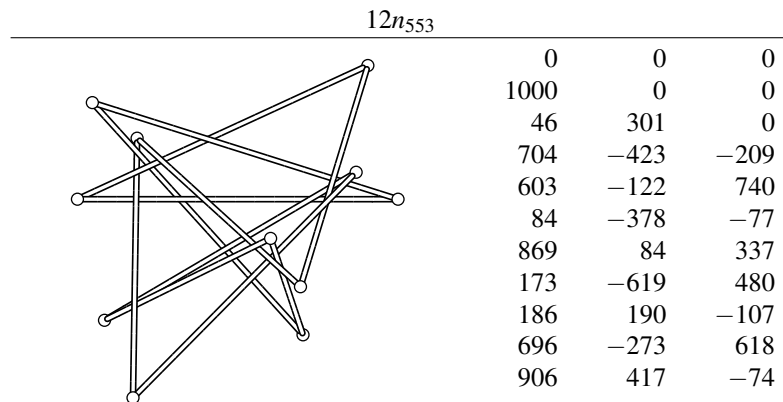
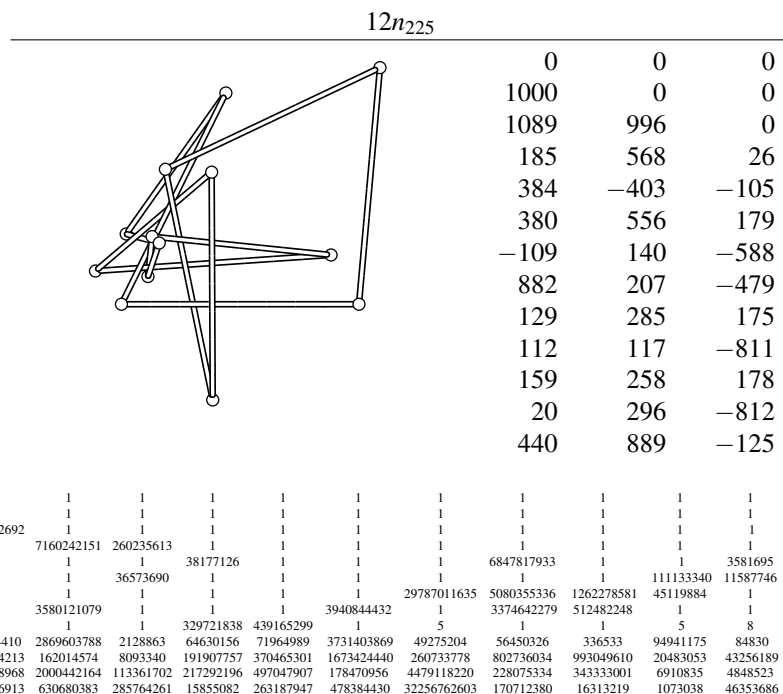

References

- [1] Colin Adams. A brief introduction to knot theory from the physical point of view. In Dorothy Buck and Erica Flapan, editors, *Applications of Knot Theory*, volume 66 of *Proceedings of Symposia in Applied Mathematics*, pages 1–20. American Mathematical Society, Providence, RI, 2009. ↑1
- [2] Colin Adams, Nikhil Agarwal, Rachel Allen, Tirsan Khandhawit, Alex Simons, Rebecca Winarski, and Mary Wootters. Superbridge and bridge indices for knots. *Journal of Knot Theory and Its Ramifications*, 30(2):2150009, 2021. ↑8

- [3] Colin Adams, Jonathan Othmer, Andrea Stier, Carmen Lefever, Sang Pahk, and James Tripp. An introduction to the supercrossing index of knots and the crossing map. *Journal of Knot Theory and Its Ramifications*, 11(3):445–459, 2002. [↑1](#)
- [4] Ryan Blair, Thomas D. Eddy, Nathaniel Morrison, and Clayton Shonkwiler. Knots with exactly 10 sticks. *Journal of Knot Theory and Its Ramifications*, 29(3):2050011, 2020. [↑10](#)
- [5] Ryan Blair, Alexandra Kjachukova, Roman Velazquez, and Paul Villanueva. Wirtinger systems of generators of knot groups. *Communications in Analysis and Geometry*, 28(2):243–262, 2020. [↑2](#), [↑5](#), [↑7](#)
- [6] Jorge Alberto Calvo. Geometric knot spaces and polygonal isotopy. *Journal of Knot Theory and Its Ramifications*, 10(2):245–267, 2001. [↑3](#), [↑8](#), [↑10](#)
- [7] George B. Dantzig and Mukund N. Thapa. *Linear Programming 2: Theory and Extensions*. Springer Series in Operations Research. Springer-Verlag, New York, 2003. [↑4](#)
- [8] Thomas D. Eddy. stick-knot-gen, efficiently generate and classify random stick knots in confinement. <https://github.com/thomaseddy/stick-knot-gen>. [↑1](#), [↑2](#), [↑11](#)
- [9] Thomas D. Eddy and Clayton Shonkwiler. New stick number bounds from random sampling of confined polygons. *Experimental Mathematics*, 2021. DOI:10.1080/10586458.2021.1926000. [↑1](#), [↑7](#), [↑8](#), [↑9](#), [↑10](#)
- [10] Paul Gordan. Über die Auflösung linearer Gleichungen mit reellen Coefficienten. *Mathematische Annalen*, 6(1):23–28, 1873. [↑4](#)
- [11] Choon Bae Jeon and Gyo Taek Jin. A computation of superbridge index of knots. *Journal of Knot Theory and Its Ramifications*, 11(3):461–473, 2002. [↑5](#), [↑7](#)
- [12] Gyo Taek Jin. Polygon indices and superbridge indices of torus knots and links. *Journal of Knot Theory and Its Ramifications*, 6(2):281–289, 1997. [↑2](#), [↑7](#), [↑8](#), [↑9](#), [↑10](#)
- [13] Nicolaas H. Kuiper. A new knot invariant. *Mathematische Annalen*, 278(1–4):193–209, 1987. [↑1](#), [↑2](#), [↑3](#), [↑7](#), [↑8](#), [↑9](#), [↑10](#)
- [14] Charles Livingston and Allison H. Moore. KnotInfo: Table of Knot Invariants. <https://knotinfo.math.indiana.edu>. [↑2](#), [↑5](#), [↑7](#)
- [15] Monica Meissen. Edge number results for piecewise-linear knots. In Vaughan F. R. Jones, Joanna Kania-Bartoszyńska, Józef H. Przytycki, Paweł Traczyk, and Vladimir G. Turaev, editors, *Knot Theory: Papers from the Mini-Semester Held in Warsaw, July 13–August 17, 1995*, volume 42 of *Banach Center Publications*, pages 235–242. Polish Academy of Sciences, Institute of Mathematics, Warsaw, Poland, 1998. [↑8](#), [↑10](#)
- [16] Chad Musick. Minimal bridge projections for 11-crossing prime knots. Preprint, [arXiv:1208.4233](https://arxiv.org/abs/1208.4233) [[math.GT](#)], 2012. [↑2](#), [↑5](#)
- [17] Seiya Negami. Ramsey theorems for knots, links and spatial graphs. *Transactions of the American Mathematical Society*, 324(2):527–541, 1991. [↑3](#), [↑8](#), [↑10](#)

- [18] Richard Randell. An elementary invariant of knots. *Journal of Knot Theory and Its Ramifications*, 3(3):279–286, 1994. [↑8](#), [↑10](#)
- [19] Eric J. Rawdon and Robert G. Scharein. Upper bounds for equilateral stick numbers. In Jorge Alberto Calvo, Kenneth C. Millett, and Eric J. Rawdon, editors, *Physical Knots: Knotting, Linking, and Folding Geometric Objects in \mathbb{R}^3* , volume 304 of *Contemporary Mathematics*, pages 55–75. American Mathematical Society, Providence, RI, 2002. [↑7](#), [↑8](#), [↑9](#), [↑10](#)
- [20] Robert G. Scharein. *Interactive Topological Drawing*. PhD thesis, University of British Columbia, 1998. [↑8](#), [↑9](#), [↑10](#)
- [21] Clayton Shonkwiler. All prime knots through 10 crossing have superbridge index ≤ 5 . *Journal of Knot Theory and Its Ramifications*. doi: 10.1142/S0218216522500237. [↑7](#), [↑8](#), [↑9](#)
- [22] Clayton Shonkwiler. New computations of the superbridge index. *Journal of Knot Theory and Its Ramifications*, 29(14):2050096, 2020. [↑1](#), [↑3](#), [↑4](#), [↑5](#), [↑8](#), [↑9](#), [↑10](#)
- [23] Albert W. Tucker. Dual systems of homogeneous linear relations. In Harold W. Kuhn and Albert W. Tucker, editors, *Linear Inequalities and Related Systems*, volume 38 of *Annals of Mathematics Studies*, pages 3–18. Princeton University Press, 1956. [↑4](#)