

2-distance, injective, and exact square list-coloring of planar graphs with maximum degree 4

Hoang La^{*1} and Kenny Štorgel^{†2}

¹LIRMM, Université de Montpellier, CNRS, Montpellier, France

²Faculty of Information Studies in Novo mesto, Slovenia

May 18, 2022

Abstract

In the past various distance based colorings on planar graphs were introduced. We turn our focus to three of them, namely 2-distance coloring, injective coloring, and exact square coloring. A 2-distance coloring is a proper coloring of the vertices in which no two vertices at distance 2 receive the same color, an injective coloring is a coloring of the vertices in which no two vertices with a common neighbor receive the same color, and an exact square coloring is a coloring of the vertices in which no two vertices at distance exactly 2 receive the same color. We prove that planar graphs with maximum degree $\Delta = 4$ and girth at least 4 are 2-distance list $(\Delta + 7)$ -colorable and injectively list $(\Delta + 5)$ -colorable. Additionally, we prove that planar graphs with $\Delta = 4$ are injectively list $(\Delta + 7)$ -colorable and exact square list $(\Delta + 6)$ -colorable.

1 Introduction

A *2-distance coloring* of a graph G is a proper coloring of the vertices of G such that no pair of vertices at distance at most 2 receive the same color. The *2-distance chromatic number* of a graph G , denoted by $\chi^2(G)$, is the smallest integer k such that there exists a 2-distance coloring of G with k colors. An *injective coloring* of a graph G is a coloring of the vertices of G in which every pair of vertices with a common neighbor receive distinct colors. The *injective chromatic number*, denoted by $\chi^i(G)$, is the smallest integer k such that there exists an injective coloring of G with k colors. An *exact square coloring* of a graph G is a coloring of the vertices of G in which every pair of vertices at distance exactly 2 receive distinct colors. The *exact square chromatic number*, denoted by $\chi^{\#2}(G)$, is the smallest integer k such that there exists an exact square coloring of G with k colors. Given a list assignment L of G , a 2-distance (injective, exact square) coloring ϕ of G is called a *2-distance (injective, exact square) list-coloring* if $\phi(v) \in L(v)$ for every $v \in V(G)$. A graph G is *2-distance (injective, exact square) k -choosable* if G admits a 2-distance list-coloring for any list assignment L with $|L(v)| \geq k$ for each $v \in V(G)$. The *2-distance (injective, exact square) choosability number* of G , denoted by $\chi_\ell^2(G)$ ($\chi_\ell^i(G)$, $\chi_\ell^{\#2}(G)$), is the smallest integer k such that G is 2-distance (injective, exact square) k -choosable.

Unlike the 2-distance coloring, both the injective coloring and the exact square coloring are not necessarily proper, i.e., adjacent vertices can receive the same color, provided that they satisfy certain conditions. For instance, in the exact square coloring two vertices can be colored with the same color if they are adjacent, and in the injective coloring two vertices can be colored with the same color if they are adjacent and do not share a common neighbor. See Figure 1 for a comparison of these colorings.

*xuan-hoang.la@lirmm.fr

†kennystorgel.research@gmail.com

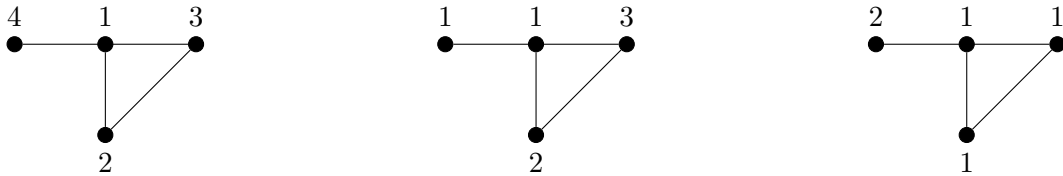

(i) A 2-distance coloring. (ii) An injective coloring. (iii) An exact square coloring.

Figure 1: A 2-distance coloring, injective coloring, and exact square coloring of the same graph.

It is therefore easy to observe that every 2-distance coloring is an injective coloring and every injective coloring is an exact square coloring. Thus, for every graph G we have the following chain of inequalities:

$$\chi^{\#2}(G) \leq \chi^i(G) \leq \chi^2(G).$$

Moreover, $\chi^{\#2}(G) = \chi^i(G)$ in the case of triangle-free graphs, i.e., graphs in which no pair of adjacent vertices share a common neighbor.

The notion of distance based colorings was first introduced in 1969 by Kramer and Kramer [29, 30] when they introduced the notion of a p -distance coloring. In this type of coloring, we require that vertices at distance at most p receive distinct colors. When $p = 1$ we obtain the familiar proper coloring. Thus, a p -distance coloring is a generalization of the classical proper coloring. Throughout the years, p -distance colorings, in particular the case when $p = 2$, became a focus for many researchers, see [2, 26, 27, 42]. Only in recent years, several results were investigated with regards to the 2-distance coloring of planar graphs, see [4, 13, 20]. For more of the recent results see also [31, 32, 33]. It is easy to observe that for every graph G , where $\Delta(G)$ (or simply Δ when G is clear from the context) is the maximum degree of G , $\Delta(G) + 1 \leq \chi^2(G) \leq \Delta^2(G) + 1$. Moreover, the upper bound, which follows from a greedy algorithm, is known to be tight for the family of Moore graphs (see, e.g., [34]). A famous conjecture of Wegner from 1977 [43] states that for planar graphs $\chi^2(G)$ is linear in terms of Δ .

Conjecture 1 (Wegner [43]). *Let G be a planar graph with maximum degree Δ . Then,*

$$\chi^2(G) \leq \begin{cases} 7, & \text{if } \Delta \leq 3, \\ \Delta + 5, & \text{if } 4 \leq \Delta \leq 7, \\ \lfloor \frac{3}{2}\Delta \rfloor + 1, & \text{if } \Delta \geq 8. \end{cases}$$

If true, then these upper bounds are tight, as there exist graphs that attain them (see [43]). In 2018, the case when $\Delta \leq 3$ was proved independently by Thomassen [42] and by Hartke *et al.* [25]. Additionally, for $\Delta \geq 8$, Havet *et al.* [27] proved that the bound is $\frac{3}{2}\Delta(1 + o(1))$. Moreover, Conjecture 1 is known to be true for some subfamilies of planar graphs (e.g., K_4 -minor free graphs [36]).

In [34], La and Montassier presented a summary of the latest known results regarding the 2-distance coloring of planar graphs for different girth values, where *girth* of a graph G , denoted by $g(G)$, is defined as the length of the shortest cycle. An additional more recent result is due to Bousquet *et al.* [4]. They improved a general result, in the case of the 2-distance coloring, stating that $2\Delta + 7$ colors are sufficient for all planar graphs with maximum degree between 6 and 31. Additionally, in [3], the same authors proved that 12 colors are sufficient when $\Delta = 4$, the case that we are particularly interested in.

The injective coloring was first introduced in 2002 by Hahn, Kratochvíl, Širáň, and Sotteau [23]. The authors proved that for every graph G , $\Delta \leq \chi^i(G) \leq \Delta^2 - \Delta + 1$. They also characterized the regular graphs which achieve the lower bound, and the graphs which attain the upper bound. In 2005, Doyon, Hahn, and Raspaud [19]¹ presented the first results on injective colorings of planar graphs and later

¹The manuscript was presented in 2005 and the paper appeared in journal in 2010.

Chen *et al.* [12] proved that for every K_4 -minor free graph G , $\chi^i(G) \leq \lceil \frac{3}{2}\Delta \rceil$. In the same paper they also posed the first conjecture which was proven to be incorrect by Lužar and Škrekovski [37] who provided an infinite family of planar graphs with small maximum degree (between 4 and 7), or of even maximum degree, for which the original conjecture is false. Although, the original conjecture was supported by several results proving that in the case of planar graphs with girth at least 5, $\Delta + C$ colors are sufficient, where C is a small constant (see, e.g., [1, 7, 16, 17, 38]). Moreover, Lužar and Škrekovski [37] proposed a new Wegner type conjecture.

Conjecture 2 (Lužar and Škrekovski [37]). *Let G be a planar graph with maximum degree Δ . Then,*

$$\chi^i(G) \leq \begin{cases} 5, & \text{if } \Delta \leq 3, \\ \Delta + 5, & \text{if } 4 \leq \Delta \leq 7, \\ \lceil \frac{3}{2}\Delta \rceil + 1, & \text{if } \Delta \geq 8. \end{cases}$$

Note that since injective coloring is a relaxation of the 2-distance coloring, proving Wegner’s conjecture would prove Conjecture 2, except in the case of subcubic graphs, i.e., the class of graphs with maximum degree 3. Brimkov *et al.* [6] proved that 5 colors suffice for subcubic planar graphs with girth at least 6, but in general that case is still open. If true, then the conjectured upper bound for subcubic graphs is also tight (see, e.g., [37]). For the sake of completeness we present a table summarizing the latest known results regarding the injective chromatic number of planar graphs for different girth values. A somewhat different table was presented in 2017 by Brimkov *et al.* [6].

χ^i g_0	Δ	$\Delta + 1$	$\Delta + 2$	$\Delta + 3$	$\Delta + 4$	$\Delta + 5$	$\Delta + 6$	$\Delta + 7$
3	—	— [12]	$\Delta \geq 4$ [37]	$\Delta \geq 4$ [37] $\Delta = 3$ [12]	$\Delta \geq 4$ [37]	$\Delta \geq 10$ [37]	$\Delta \geq 12$ [37]	$\Delta \geq 14$ [37] $\Delta = 4$
4	—	$\Delta \geq 4$ [38]	$\Delta \geq 6$ [38]	$\Delta \geq 8$ [38] $\Delta = 3$ [12]	$\Delta \geq 10$ [38]	$\Delta \geq 12$ [38] $\Delta = 4$	$\Delta \geq 14$ [38]	$\Delta \geq 16$ [38]
5	—			$\Delta = 3$ [12] $\Delta \geq 35$ [18]	$\Delta \geq 11$ [8]	$\Delta = 4$ $\Delta \geq 11$ [8]	$\Delta \geq 3$ [18]	
6	— [38]	$\Delta \geq 17$ [17]	$\Delta = 3$ [6] $\Delta \geq 8$ [10]	$\Delta \geq 3$ [17]				
7	$\Delta \geq 16$ [1]	$\Delta \geq 7$ [9]	$\Delta = 3$ [38] $\Delta \geq 4$ [16]					
8	$\Delta \geq 10$ [1]	$\Delta \geq 5$ [10]						
9	$\Delta \geq 9$ [11]	$\Delta \geq 4$ [15]						
10	$\Delta \geq 6$ [1] $\Delta = 3$ [38]	$\Delta \geq 3$ [38]						
11								
12	$\Delta \geq 5$ [1]							
13	$\Delta \geq 4$ [15]							
19	$\Delta \geq 3$ [38]							

Table 1: Summary of the latest results with a coefficient 1 before Δ in the upper bound of χ^i for different girth values while for the crossed out cases there exist counterexamples.

Table 1 reads as follows. For example, the result from line “7” and column “ Δ ” states that every planar graph G of girth at least 7 and maximum degree $\Delta(G) \geq 16$ satisfies $\chi^i(G) \leq \Delta(G)$. In the first column (“ Δ ”), the first four crossed out cases follow from the graph in Figure 2. In this same column, row “10” with a crossed out value of $\Delta = 3$ corresponds to a construction of a planar graph G with $\Delta(G) = 3$, girth 10, and $\chi^i(G) \geq \Delta + 1$ [38]. Similar results in the same vein in columns “ $\Delta + 1$ ” to “ $\Delta + 4$ ” in row “3” are presented in [12] and [37]. There exists a planar graph G with girth 3 and $\chi^i(G) \geq \lceil \frac{3}{2}\Delta \rceil + 1$ for all $\Delta \geq 8$ [37], which justifies the remaining crossed out cases in row “3”. Similarly, there also exists a planar graph G with girth 4 and $\chi^i(G) \geq \frac{3}{2}\Delta$ for all $\Delta \geq 3$ [38], which justifies the crossed out cases in row “4”. Every highlighted result without a reference in Table 1 is a part of our contribution in this paper. Note that the highlighted result in row “5” follows from the result in row “4”,

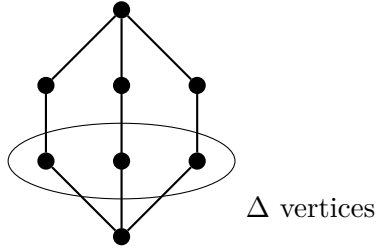

Figure 2: A graph with girth 6 and $\chi^i \geq \Delta + 1$ (drawn for $\Delta = 3$) [38].

Finally, the study of the exact distance p -powers of graphs was started by Simić [41] and exact p -distance colorings have first been studied for graphs of bounded expansion [39], see also [28]. This parameter received an increasing attention in the last decade, see [5, 21, 28, 40]. In [21], Foucaud *et al.* began the first systematic study of the exact square coloring (i.e., exact 2-distance coloring) with respect to the maximum degree. In their paper, they considered the exact square coloring for some specific classes of subcubic graphs. Both in the case of subcubic K_4 -minor free graphs and subcubic planar bipartite graphs, they prove that 4 colors suffice in any exact square coloring. Moreover, they provide examples attaining this bound. Furthermore, they prove that Conjecture 2 holds for fullerene graphs, i.e., cubic planar graphs in which every face has size 5 or 6. Since for every graph G with girth at least 4 we have equality between $\chi^{\#2}(G)$ and $\chi^i(G)$, all the results in Table 1, except for the row corresponding to girth at least 3, hold also for the exact square coloring.

In this paper we present some results regarding the 2-distance, injective, and exact square coloring of planar graphs of small girth (3 or 4), thus filling some gaps from the literature. We focus on graphs which have maximum degree 4, also known in the literature as *subquartic graphs*.

With respect to the 2-distance coloring, we consider planar graphs with maximum degree 4 and girth at least 4 to get the following result for 2-distance choosability number.

Theorem 3. *If G is a planar graph with $g(G) \geq 4$ and $\Delta(G) = 4$, then $\chi_\ell^2(G) \leq \Delta(G) + 7$.*

In the case of the injective coloring, we prove that the same bound as in Theorem 3 also holds, but without any restrictions on the girth.

Theorem 4. *If G is a planar graph with $\Delta(G) = 4$, then $\chi_\ell^i(G) \leq \Delta(G) + 7$.*

Furthermore, in the case when girth is at least 4, we improve the bound implied by Theorem 3 to $\Delta + 5$ colors.

Theorem 5. *If G is a planar graph with $g(G) \geq 4$ and $\Delta(G) = 4$, then $\chi_\ell^i(G) \leq \Delta(G) + 5$.*

Finally, in the case of the exact square coloring, we improve the bound implied by Theorem 4 to $\Delta + 6$ colors.

Theorem 6. *If G is a planar graph with $\Delta(G) = 4$, then $\chi_\ell^{\#2}(G) \leq \Delta(G) + 6$.*

The structure of the paper is organized as follows. In Section 2, we present notations and auxiliary results. The proofs of Theorems 3 to 6 are then provided in Sections 3 to 6. We conclude the paper with some additional remarks in Section 7.

2 Preliminaries

We denote by $F(G)$ the set of faces of a planar graph G . Given two vertices u and v of a graph G , and a set $S \subseteq V(G)$, we denote by $d_G(u, v)$ the distance between u and v in G , and define the distance between the vertex v and the set S as $d_G(v, S) := \min\{d_G(v, w) \mid w \in S\}$. For a vertex v of G , we define the *neighborhood*, *2-distance neighborhood*, and *exact 2-distance neighborhood* respectively as follows:

- $N_G(v) := \{w \in V(G) \mid d_G(v, w) = 1\}$,
- $N_G^*(v) := \{w \in V(G) \mid 1 \leq d_G(v, w) \leq 2\}$,
- $N_G^{\#2}(v) := \{w \in V(G) \mid d_G(v, w) = 2\}$.

Additionally, we define the *2-distance degree* and the *exact 2-distance degree* respectively as follows:

- $d_G^*(v) := |N_G^*(v)|$,
- $d_G^{\#2}(v) := |N_G^{\#2}(v)|$.

Furthermore, we define by d -vertex (d^+ -vertex, d^- -vertex) a vertex of degree d (at least d , at most d) and by d -face (d^+ -face, d^- -face) a face of size d (at least d , at most d). For $S \subseteq V(G) \cup E(G)$, we denote by $G - S$ the graph obtained from G by removing the elements from S . Similarly, we denote by $G + S$ the graph obtained from G by adding the elements from S .

We will drop the subscript in the notations when the graph is clear from the context. Also for conciseness, from now on, when we say “to color” a vertex, it means to color such a vertex under the constraint of the current 2-distance, injective, or exact square list-coloring. We also say that a vertex u “sees” a vertex v if u and v are at distance at most 2 from each other (resp. share a neighbor, or are at distance exactly 2 from each other) for the 2-distance (resp. injective, or exact square) list-coloring. We abuse this vocabulary to say that u “sees a color” c when u sees a vertex colored c .

As a drawing convention for the rest of the figures, black vertices have a fixed degree, all of their edges are drawn, and white vertices may have a higher degree than what is drawn. We often show the reducibility of a configuration by extending a certain precoloring. We denote by $L(u)$ the list of remaining colors for an uncolored vertex u . We will also indicate the lower bound on the size of $|L(u)|$ next to the relevant vertices on the figures.

A useful tool in proving coloring results is also Hall’s Theorem, which guarantees distinct colors for a set of vertices.

Theorem 7 (Hall [24]). *A bipartite graph with partition sets A and B admits a matching that covers every vertex of A if and only if for every set $S \subseteq A$ the number of vertices of B with a neighbor in S is at least $|S|$.*

If we consider A to be the set of vertices and B to be the set of colors, then we get the following result for list coloring.

Corollary 8 (Hall). *Let L be a list-assignment on a set of vertices V , for every subset $S \subseteq V$ of size k , if $|\bigcup_{u \in S} L(u)| \geq k$, then V is L -list-colorable where every vertex has a distinct color.*

The proof of each theorem will be structured as follows. First we will consider a counterexample G minimizing the number of vertices plus the number of edges. Such counterexamples are always connected, otherwise a component of G would be a smaller counterexample. Thus, the minimum degree is always at least 1. After studying the structural properties of G , we will proceed with a discharging procedure where we always assign the initial charge $\mu(u) = d(u) - 4$ to each vertex $u \in V(G)$, and $\mu(f) = d(f) - 4$ to each face $f \in F(G)$. By Euler’s formula, we must have

$$\sum_{u \in V(G)} (d(u) - 4) + \sum_{f \in F(G)} (d(f) - 4) < 0. \quad (1)$$

Finally, to prove that G does not exist, we will redistribute the charges while preserving the total sum and prove that the final charge of each vertex and face is non-negative, which will be a contradiction to Equation (1).

3 2-distance list-coloring of triangle-free planar graphs

In this section, we provide the proof of Theorem 3. Let G be a minimal counterexample to Theorem 3, namely G has maximum degree 4, girth at least 4, and $\chi_\ell^2(G) \geq 12$.

3.1 Structural properties of G

We start by proving that G cannot be too sparse. More precisely, we have a lower bound on the minimum degree of G .

Lemma 9. *The minimum degree of G is at least 3.*

Proof. If G contains a 1-vertex v , then we can simply remove v and color the resulting graph (with 11 colors), which is possible by minimality of G . Then, we add v back and extend the coloring (at most 4 constraints and 11 colors).

If G contains a vertex u of degree 2 with neighbors v and w (see Figure 3), then let $H = G - \{u\}$. We color $H + \{vw\}$ (resp. H) by minimality if $d_H(v, w) \geq 3$ (resp. $d_H(v, w) \leq 2$). Observe that in both cases, the girth (at least 4) and maximum degree (4) of the resulting graph are preserved. We extend such coloring to G by coloring u which sees only at most 8 different colors. \square

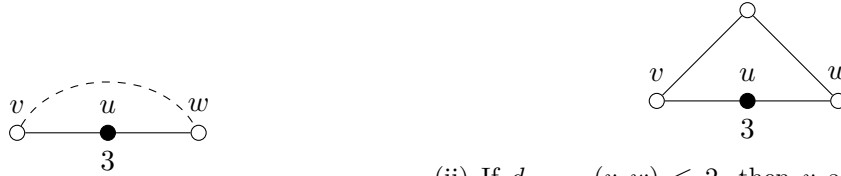

- (i) If $d_{G-\{u\}}(v, w) \geq 3$, then we add the dashed edge. (ii) If $d_{G-\{u\}}(v, w) \leq 2$, then v and w already have different colors in a coloring of $G - \{u\}$.

Figure 3: Reducible configurations in Lemma 9.

Along the same line, we prove that objects will a smaller neighborhood cannot be close together. Otherwise, G would be colorable.

Lemma 10. *Graph G does not contain the following configurations:*

- (i) A 3-vertex incident to two 4-cycles.
- (ii) A 3-vertex incident to a 4-cycle and adjacent to a 3-vertex.
- (iii) A 3-vertex adjacent with two 3-vertices.

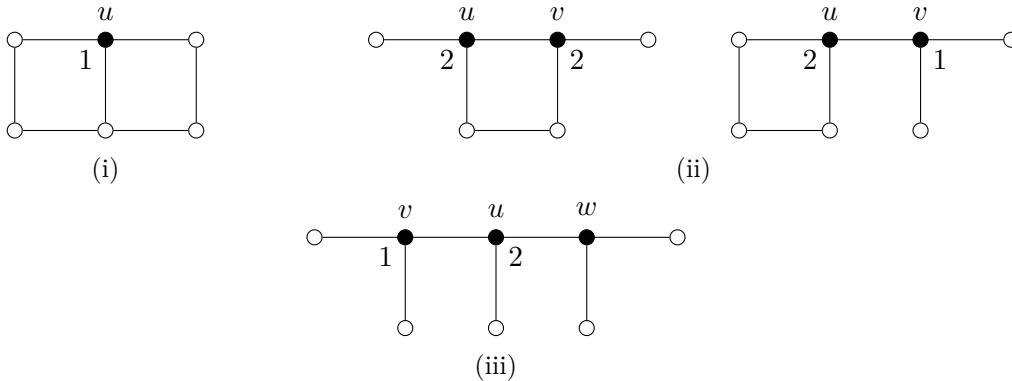

Figure 4: Reducible configurations in Lemma 10.

Proof. We reduce each configuration separately (see Figure 4) by precoloring a subgraph of G and extending the coloring to G .

- (i) Let u be a 3-vertex incident to two 4-cycles. Let e be the incident edge to u that is also incident to both cycles. Color $G - \{e\}$ by minimality and uncolor u . Observe that $d_G^*(u) \leq 10$ so u has at least one available color.
- (ii) Let u and v be two adjacent 3-vertices and suppose that u is incident to a 4-cycle. Color $G - \{uv\}$ and uncolor u and v . Observe that v has at least one and u has at least two available colors.
- (iii) Let u be a 3-vertex with two 3-neighbors v and w . Color $G - \{uv\}$ and uncolor u and v . Observe that v has at least one and u has at least two available colors.

This concludes the proof. \square

In a 2-distance coloring, 5-faces play an important role as they are right at the limit of being “big” enough objects that are not directly colorable, but “small” enough that a planar graph can contain only those. Thus, we turn our attention to configurations surrounding 5-faces.

Lemma 11. *Let $f = v_1v_2v_3v_4v_5$ be a 5-face in G such that $d(v_1) = d(v_3) = d(v_5) = 3$, and v_2v_3 is incident to a 4-face. Let $f' = v'_1v'_2v'_3v'_4v'_5$ be another 5-face in G such that $d(v'_2) = d(v'_3) = d(v'_5) = 3$. Then, $v'_4 \neq v_4$ or $v'_5 \neq v_5$.*

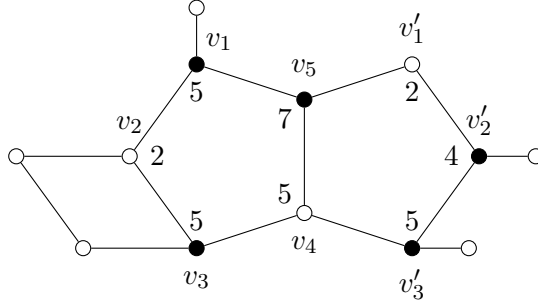

Figure 5: Reducible configuration in Lemma 11.

Proof. Suppose by contradiction that $v'_4 = v_4$ and $v'_5 = v_5$ (see Figure 5). First, observe that the vertices of $H = G[\{v_1, v_2, v_3, v_4, v_5, v'_1, v'_2, v'_3\}]$ are all distinct since $g(G) \geq 4$ and due to Lemma 10(ii). Color $G - \{v_4, v_5\}$ by minimality and uncolor the other vertices of f and f' . Observe that the remaining list of colors for these vertices have size: $|L(v_1)| \geq 5$, $|L(v_2)| \geq 2$, $|L(v_3)| \geq 5$, $|L(v_4)| \geq 5$, $|L(v_5)| \geq 7$, $|L(v'_1)| \geq 2$, $|L(v'_2)| \geq 4$, and $|L(v'_3)| \geq 5$. Note that if for any pair of vertices (u, v) in $V(H)$, if $d_G(u, v) \leq 2$ while $d_H(u, v) \geq 3$, then both u and v have at least one more remaining color.

We claim that $L(v_1) \cap L(v'_3) = \emptyset$ or $L(v_3) \cap L(v'_2) = \emptyset$. Suppose by contradiction that $L(v_1) \cap L(v'_3) \neq \emptyset$ and $L(v_3) \cap L(v'_2) \neq \emptyset$.

If $d_G(v_1, v'_3) \geq 3$. Then, we can color v_1 and v'_3 with the same color c , then we finish by coloring $v'_1, v_2, v'_2, v_3, v_4$, and v_5 in this order. This is a contradiction so $d_G(v_1, v'_3) \leq 2$. If $d_G(v_1, v'_3) = 1$, then v_1, v'_3, v_4 , and v_5 form the configuration from Lemma 10(ii). So, $d_G(v_1, v'_3) = 2$.

If $d_G(v_3, v'_2) \geq 3$. Then, we can color v_3 and v'_2 with the same color c , then we finish by coloring $v'_1, v_2, v_1, v'_3, v_4$, and v_5 in this order. This is a contradiction so $d_G(v_3, v'_2) \leq 2$. If $d_G(v_3, v'_2) = 1$, then v'_2, v'_3, v_3 , and v_4 form the configuration from Lemma 10(ii). So, $d_G(v_3, v'_2) = 2$.

As a result, by planarity, v_1, v_3, v'_2 , and v'_3 must have a common neighbor u . However, $uv'_2v'_3$ is a triangle while $g(G) \geq 4$.

Consequently, we have $|L(v_1) \cup L(v'_3)| \geq 10$ or $|L(v'_2) \cup L(v_3)| \geq 9$. Moreover, note that $|L(v_1) \cup L(v'_3)| \geq 6$ and $|L(v_3) \cup L(v'_2)| \geq 6$. Indeed, these inequalities hold when $d_G(v_1, v'_3) \leq 2$ (resp. $d_G(v_3, v'_2) \leq 2$) as $|L(v_1)| \geq 6$ (resp. $|L(v_3)| \geq 6$). And when $d_G(v_1, v'_3) \geq 3$ (resp. $d_G(v_3, v'_2) \geq 3$), we also the same inequalities, otherwise $L(v_1)$ and $L(v'_3)$ (resp. $L(v_3)$ and $L(v'_2)$) will have a common color, in which case G is colorable as seen previously.

Finally, G is L -list-colorable by Corollary 8 as $|\bigcup_{u \in S} L(u)| \geq k$ for every subset S of size k in $V(H)$. \square

Lemma 12. *Let $f = v_1v_2v_3v_4v_5$ be a 5-face in G such that $d(v_1) = d(v_3) = d(v_5) = 3$, and v_2v_3 is incident to a 4-face. Let $f' = v'_1v'_2v'_3v'_4v'_5$ be another 5-face in G such that $d(v'_1) = d(v'_3) = d(v'_5) = 3$, and $v'_2v'_3$ is incident to a 4-face. Then, $v'_1 \neq v_1$ or $v'_5 \neq v_5$.*

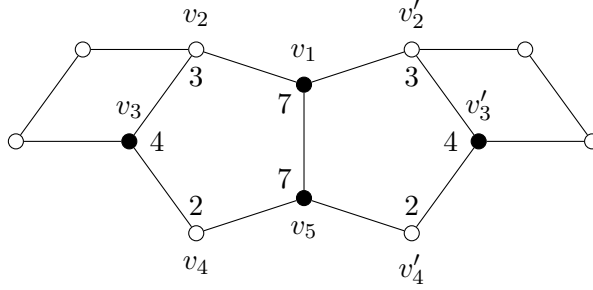

Figure 6: Reducible configuration in Lemma 12.

Proof. Suppose by contradiction that $v'_1 = v_1$ and $v'_5 = v_5$ (see Figure 6). First, observe that the vertices of $H = G[\{v_1, v_2, v_3, v_4, v_5, v'_2, v'_3, v'_4\}]$ are all distinct since $g(G) \geq 4$ and due to Lemma 10(ii). Color $G - \{v_1, v_5\}$ by minimality and uncolor the other vertices of f and f' . Observe that the remaining list of colors for these vertices have size: $|L(v_1)| \geq 7$, $|L(v_2)| \geq 3$, $|L(v_3)| \geq 4$, $|L(v_4)| \geq 2$, $|L(v_5)| \geq 7$, $|L(v'_2)| \geq 3$, $|L(v'_3)| \geq 4$, and $|L(v'_4)| \geq 2$. Note that if for any pair of vertices (u, v) in $V(H)$, if $d_G(u, v) \leq 2$ while $d_H(u, v) \geq 3$, then both u and v have at least one more remaining color. We start with the following claims:

- $L(v_4) \cap L(v'_2) = \emptyset$ or $L(v'_4) \cap L(v_2) = \emptyset$.

Suppose by contradiction that $L(v_4) \cap L(v'_2) \neq \emptyset$ and $L(v'_4) \cap L(v_2) \neq \emptyset$. Suppose w.l.o.g. that $d_G(v_4, v'_2) \geq 3$. Then, we can color v_4 and v'_2 with the same color c , then we finish by coloring v'_4 , v_2 , v_3 , v'_3 , v_1 , and v_5 in this order. This is a contradiction so $d_G(v_4, v'_2) \leq 2$ and $d_G(v'_4, v_2) \leq 2$. If $d_G(v_4, v'_2) = 1$, then v_1, v'_2, v_4 , and v_5 form the configuration from Lemma 10(ii). By symmetry, we get $d_G(v_4, v'_2) = d_G(v'_4, v_2) = 2$. As a result, by planarity, v_2, v'_2, v_4 , and v'_4 must have a common neighbor u . However, v_1, v_2, u , and v'_2 form the configuration from Lemma 10(ii).

As a consequence, we have $|L(v_4) \cup L(v'_2)| \geq 5$ or $|L(v'_4) \cup L(v_2)| \geq 5$.

- $L(v_4) \cap L(v'_3) = \emptyset$ or $L(v'_4) \cap L(v_3) = \emptyset$.

Suppose by contradiction that $L(v_4) \cap L(v'_3) \neq \emptyset$ and $L(v'_4) \cap L(v_3) \neq \emptyset$. Suppose w.l.o.g. that $d_G(v_4, v'_3) \geq 3$. Then, we can color v_4 and v'_3 with the same color c , then we finish by coloring v'_4 , v'_2 , v_2 , v_3 , v_1 , and v_5 in this order. This is a contradiction so $d_G(v_4, v'_3) \leq 2$ and $d_G(v'_4, v_3) \leq 2$. If $d_G(v_4, v'_3) = 1$, then v_4, v_5, v'_4 , and v'_3 form the configuration from Lemma 10(ii). By symmetry, we get $d_G(v_4, v'_3) = d_G(v'_4, v_3) = 2$. As a result, by planarity, v_3, v'_3, v_4 , and v'_4 must have a common neighbor u . However, v_3v_4u is a triangle.

As a consequence, we have $|L(v_4) \cup L(v'_3)| \geq 5$ or $|L(v'_4) \cup L(v_3)| \geq 5$.

- $|L(v_2) \cup L(v_3) \cup L(v'_2) \cup L(v'_3)| \geq 8$.

Suppose by contradiction that $|L(v_2) \cup L(v_3) \cup L(v'_2) \cup L(v'_3)| \leq 7$. Since $|L(v_3)| \geq 4$ and $|L(v'_3)| \geq 4$, we get $L(v_3) \cap L(v'_3) \neq \emptyset$. Suppose that $d_G(v_3, v'_3) \geq 3$. Then, we can color v_3 and v'_3 with the same color c . Since $L(v_4) \cap L(v'_3) = \emptyset$ or $L(v'_4) \cap L(v_3) = \emptyset$, w.l.o.g. we can color v_4 then v'_4 . Since $L(v_4) \cap L(v'_2) = \emptyset$ or $L(v'_4) \cap L(v_2) = \emptyset$, w.l.o.g. we can color v_2 then v'_2 . Finish by coloring v_1 and v_5 . So, $d_G(v_3, v'_3) \leq 2$.

If $d_G(v_3, v'_3) = 1$, then let $w \notin \{v_2, v_4\}$ be the last neighbor of v_3 , and we know that $v'_3 \in \{w, v_2, v_4\}$. We cannot have $v'_3 = v_2$ since $v_1v_2v'_2$ is a triangle. By symmetry, $v'_3 \neq v_4$. Finally, if $v'_3 = w$, then v_3 and v'_3 are adjacent 3-vertices lying on the same 4-cycle, which is impossible by Lemma 10(ii).

So, we have $d(v_3, v'_3) = 2$. In this case, observe that $|L(v_3)| \geq 5$ and $|L(v'_3)| \geq 5$. Recall that $|L(v_2) \cup L(v_3) \cup L(v'_2) \cup L(v'_3)| \leq 7$. As a result, $L(v_3) \cap L(v'_2) \neq \emptyset$ since $|L(v_3)| \geq 5$ and $|L(v'_2)| \geq 3$. The same holds for $L(v'_3)$ and $L(v_2)$. Suppose that $d_G(v_3, v'_2) \geq 3$, then we can color v_3 and v'_2 with the same color c . Since $L(v_3) \cap L(v'_4) = \emptyset$ or $L(v_4) \cap L(v'_2) = \emptyset$, w.l.o.g. we can color v_4 then v'_4 . Finish by coloring v_2, v'_3, v_1 and v_5 . So, $d_G(v_3, v'_2) \leq 2$. By symmetry, the same holds for $d_G(v'_3, v_2)$. By Lemma 10, $d_G(v_3, v'_2) > 1$. So, we get $d_G(v_3, v'_2) = d_G(v'_3, v_2) = 2$. As a result, by planarity, v_2, v'_2, v_3 , and v'_3 must have a common neighbor u . However, uv_2v_3 is a triangle.

Due to the above claims, G is L -list-colorable by Corollary 8. \square

3.2 Discharging procedure

To prove that at least one of reducible configurations in G is unavoidable in a planar graph, we apply the following rules in the discharging procedure:

R0 Every 5^+ -face f gives $\frac{1}{3}$ to each incident 3-vertex that is not incident to a 4-face.

R1 Every 5^+ -face f gives $\frac{1}{2}$ to each incident 3-vertex that is incident to a 4-face.

R2 Let $f' = u_1u_2u_3u_4u_5$ be a 5-face where $d(u_1) = d(u_3) = d(u_4) = 3$, u_1u_2 is incident to a 4-face and let f be incident to u_4u_5 . If f is a 5^+ -face, then f gives $\frac{1}{6}$ to f' .

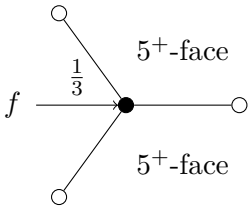

Figure 7: **R0**.

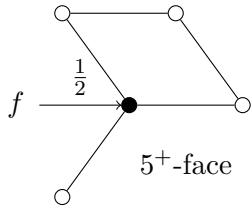

Figure 8: **R1**.

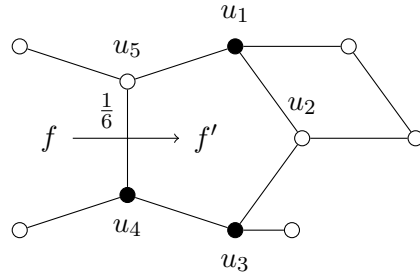

Figure 9: **R2**.

We are now ready to prove Theorem 3 using discharging procedure together with the structural properties of G proven in Section 3.1 and the discharging rules stated above.

Proof of Theorem 3. Let G be a minimal counterexample to the theorem. Let $\mu(u)$ be the initial charge assignment for the vertices and faces of G with the charge $\mu(u) = d(u) - 4$ for each vertex $u \in V(G)$, and $\mu(f) = d(f) - 4$ for each face $f \in F(G)$. By Equation (1), we have that the total sum of the charges is negative.

Let μ^* be the charge assignment after the discharging procedure. In what follows, we prove that:

$$\forall x \in V(G) \cup F(G), \mu^*(x) \geq 0.$$

First, we prove that the final charge on each vertex is non-negative. Let u be a vertex in $V(G)$. Recall that $\Delta(G) = 4$ and $\mu(u) = d(u) - 4$. By Lemma 9, vertex u has degree at least 3, thus we consider the following two cases.

Case 1: $d(u) = 4$

By **R0-R2**, u does not give any charge. So,

$$\mu^*(u) = \mu(u) = d(u) - 4 = 0.$$

Case 2: $d(u) = 3$

Recall that $\mu(u) = d(u) - 4 = -1$ and we have the following cases:

- If u is not incident to any 4-face, then it receives $\frac{1}{3}$ from each of the three incident 5^+ -faces (since $g(G) \geq 4$) by **R0**. So,

$$\mu^*(u) = -1 + 3 \cdot \frac{1}{3} = 0.$$

- If u is incident to a 4-face, then it has exactly one incident 4-face due to Lemma 10(i). Therefore, u is incident to two 5^+ -faces and receives $\frac{1}{2}$ from each by **R1**. So,

$$\mu^*(u) = -1 + 2 \cdot \frac{1}{2} = 0.$$

Secondly, we prove that the final charge on each face is non-negative. Let f be a face in $F(G)$ and let $i_0, i_1,$ and i_2 be respectively the number of times f gives charge by **R0**, **R1**, and **R2**. Recall that $\mu(f) = d(f) - 4$. Moreover, $d(f) \geq 4$ since $g(G) \geq 4$, thus we consider the following three cases.

Case 1: $d(f) \geq 6$

By Lemma 10(iii), there are at most $\frac{2}{3}d(f)$ 3-vertices incident to f . As a result, we get $i_0 + i_1 \leq \frac{2}{3}d(f)$. Moreover, **R2** can only be applied whenever **R0** is applied since u_4 (from the statement of **R2**) is a 3-vertex that is not incident to a 4-face by Lemma 10(ii). Additionally, by Lemma 12, for each application of **R0**, **R2** is applied at most once. In other words, $i_2 \leq i_0$. Finally,

$$\begin{aligned} \mu^*(f) &\geq \mu(f) - \frac{1}{3}i_0 - \frac{1}{2}i_1 - \frac{1}{6}i_2 \\ &\geq \mu(f) - \frac{1}{3}i_0 - \frac{1}{2}i_1 - \frac{1}{6}i_0 \\ &\geq \mu(f) - \frac{1}{2}(i_0 + i_1) \\ &\geq \mu(f) - \frac{1}{3}d(f) \\ &\geq \frac{2}{3}d(f) - 4 \\ &\geq 0 \end{aligned}$$

since $d(f) \geq 6$.

Case 2: $d(f) = 5$

Recall that $\mu(f) = d(f) - 4 = 1$. Observe that we have the following inequalities:

- $i_0 + i_1 \leq 3$ and $i_2 \leq i_0$ (as in the previous case).
- $i_1 \leq 2$. Indeed, by Lemma 10(ii), the 3-vertex in **R1** must be adjacent to only 4-vertices. As a result, if we have equality, then f is incident to exactly two 3-vertices.
- $i_2 \leq 2$. Indeed, by Lemma 10(iii), the neighbors of u_4 (as in the statement of **R2**) that are incident to f must be 4-vertices. As a result, if we have equality, then f is incident to exactly two 3-vertices.

Recall that f gives $\frac{1}{3}i_0 + \frac{1}{2}i_1 + \frac{1}{6}i_2$ by **R0**, **R1**, and **R2**.

If $i_0 \leq 1, i_1 \leq 1,$ and $i_2 \leq 1,$ then

$$\mu^*(f) \geq 1 - \frac{1}{3} - \frac{1}{2} - \frac{1}{6} = 0.$$

If $i_2 \geq 2,$ then $i_2 = 2$ since $i_2 \leq 2$ and f is incident to exactly two 3-vertices. Thus, $i_0 + i_1 \leq 2$. Moreover, since $i_2 \leq i_0,$ we also have $i_0 = 2$ and $i_1 = 0$. So,

$$\mu^*(f) \geq 1 - 2 \cdot \frac{1}{3} - 2 \cdot \frac{1}{6} = 0.$$

If $i_1 \geq 2$, then $i_1 = 2$ since $i_1 \leq 2$ and f is incident to exactly two 3-vertices. Thus, $i_0 + i_1 \leq 2$. Therefore, $i_0 = 0$. Moreover, since $i_2 \leq i_0$, we also have $i_2 = 0$. So,

$$\mu^*(f) \geq 1 - 2 \cdot \frac{1}{2} = 0.$$

If $i_0 \geq 3$, then $i_0 = 3$ and $i_1 = 0$ since $i_0 + i_1 \leq 3$. Let $f = v_1v_2v_3v_4v_5$. W.l.o.g. we have $d(v_1) = d(v_2) = d(v_4) = 3$ and $d(v_3) = d(v_5) = 4$. Observe that f cannot give charge through v_5v_1 , v_1v_2 , or v_2v_3 by **R2** due to Lemma 10(i). If it gives through v_4v_5 , then we have Lemma 11, which is a contradiction. The same holds for v_4v_3 by symmetry. As a result, $i_2 = 0$. So,

$$\mu^*(f) \geq 1 - 3 \cdot \frac{1}{3} = 0.$$

If $i_0 = 2$, then we have the following two cases since $i_0 + i_1 \leq 3$.

- If $i_1 = 0$, then we already know that $i_2 \leq i_0 \leq 2$. So,

$$\mu^*(f) \geq 1 - 2 \cdot \frac{1}{3} - 2 \cdot \frac{1}{6} = 0.$$

- If $i_1 = 1$, then let $f = u_1u_2u_3u_4u_5$. W.l.o.g. we have $d(u_1) = d(u_3) = d(u_4) = 3$ and $d(u_2) = d(u_5) = 4$. For $1 \leq i \leq 5$, let $f_i \neq f$ be the face incident to $u_iu_{i+1(\text{mod } 5)}$. Observe that neither u_3 nor u_4 can be incident to a 4-face due to Lemma 10(ii) so f_2, f_3 , and f_4 must be 5⁺-faces. Moreover, we can assume w.l.o.g. that f_1 is a 4-face. In such a case, f receives $\frac{1}{6}$ from f_4 by **R2**. Additionally, f cannot give charge by **R2** to neither f_1 nor f_5 due to Lemma 10(ii). Furthermore, f cannot give to f_2, f_3 , nor f_4 by **R2** due to Lemma 10(iii). As a result, $i_2 = 0$. So,

$$\mu^*(f) \geq 1 + \frac{1}{6} - 2 \cdot \frac{1}{3} - \frac{1}{2} = 0.$$

It follows that after the discharging procedure 5-faces have non-negative charge.

Case 3: $d(f) = 4$

Recall that $\mu(f) = d(f) - 4 = 0$. Since f does not give any charge, we have

$$\mu^*(f) = \mu(f) = 0.$$

To conclude the proof, after the discharging procedure, which preserved the total sum, we end up with a non-negative total sum, a contradiction to Equation (1). \square

4 Injective list-coloring of planar graphs

In this section, we provide the proof to Theorem 4. Let G be a minimal counterexample to Theorem 4 with the fewest number of vertices plus edges. More precisely, G has maximum degree 4 and $\chi_\ell^i(G) \geq 12$.

4.1 Structural properties of G

We follow the same ideas as in the previous proof, starting by bounding the minimum degree of G and proving that “smaller” objects are far away from each other. Recall that for injective coloring, two vertices see each other only when they share a neighbor.

Lemma 13. *The minimum degree of G is at least 3.*

Proof. Let u be a 2⁻-vertex in G . If u is a 1-vertex, then we color $G - \{u\}$, and we extend the coloring to u by using one of the at least 8 remaining colors. On the other hand, if u is a 2-vertex and v one of its neighbors (see Figure 10), then we color $G - \{u\}$ and uncolor v . Observe that u has at least five and v has at least one available color. Thus, we first color v and then u to complete the coloring. \square

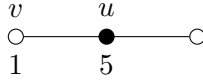

Figure 10: Reducible configuration in Lemma 13.

Lemma 14. *Graph G does not contain the following configurations:*

- (i) *Two adjacent 3-vertices.*
- (ii) *A 3-vertex incident to a 4^- -cycle.*
- (iii) *A 3-vertex at distance 1 from two adjacent 3-cycles.*
- (iv) *A 4-vertex incident to two adjacent 3-cycles and another 4^- -cycle.*

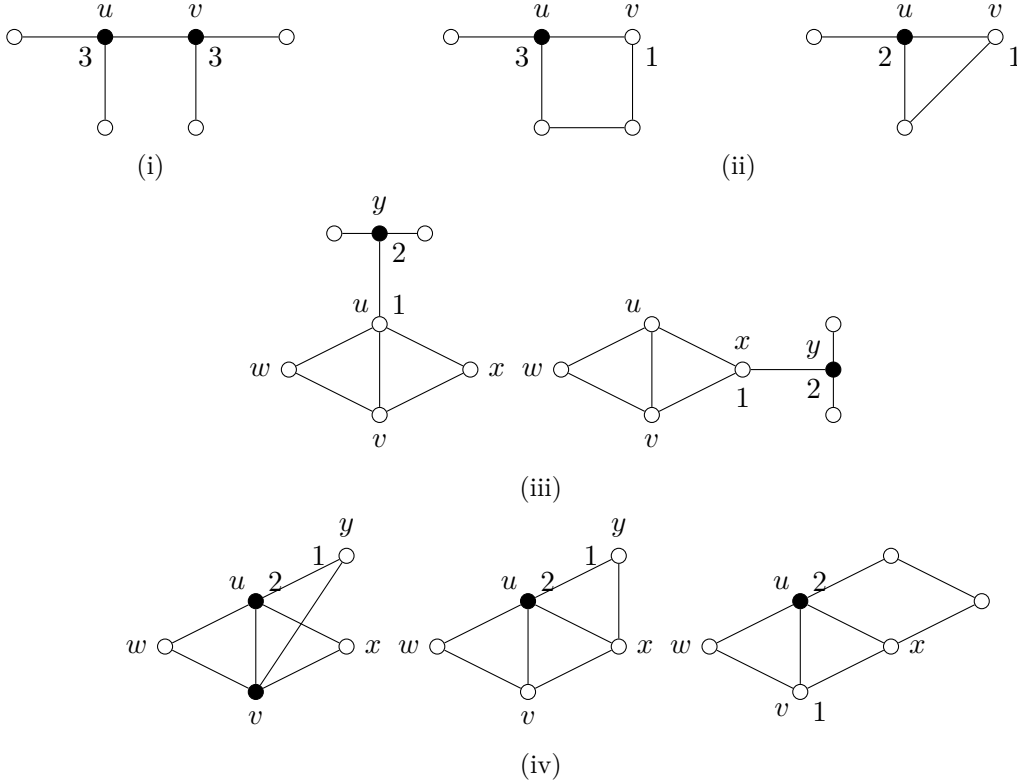

Figure 11: Reducible configurations in Lemma 14.

Proof. We give a proof for each configuration separately (see Figure 11).

- (i) Suppose by contradiction that there exist two adjacent 3-vertices u and v . Color $G - \{uv\}$ by minimality and uncolor the vertices u and v . Observe that each of them can see at most 8 colors. Thus, u and v are colorable.
- (ii) Suppose by contradiction that there exists a 3-vertex u that is incident to a 4^- -cycle C . Let v be a vertex incident to C and adjacent with u . Color $G - \{uv\}$ by minimality and uncolor the vertices u and v . Observe that $|L(u)| \geq 2$ and $|L(v)| \geq 1$. Thus, u and v are colorable.
- (iii) Let uvw and uvx be 3-cycles where $x \neq w$. First, suppose by contradiction that there exists a 3-vertex y that is at distance 1 from $G[\{u, v, w, x\}]$. If y is adjacent to u , color $G - \{uy\}$ by minimality and uncolor the vertices u and y . Observe that $|L(u)| \geq 1$ and $|L(y)| \geq 2$. Thus, u and y are colorable. Now, suppose that y is adjacent to x instead. In this case, color $G - \{xy\}$ by minimality and uncolor the vertices x and y . Observe that $|L(x)| \geq 1$ and $|L(y)| \geq 2$. Thus, x and y are colorable.

- (iv) Let u be a 4-vertex that is incident to two adjacent 3-cycles uvw and uvx where $x \neq w$. First, suppose by contradiction that u is incident to another 3-cycle. If there exists y such that $y \notin \{x, w\}$ and uvy is a 3-cycle, then color $G - \{uy\}$ by minimality and uncolor the vertices u and y . Observe that $|L(u)| \geq 2$ and $|L(y)| \geq 1$. Thus, u and y are colorable. If uxy is a 3-cycle with $y \notin \{v, w\}$, then the same exact arguments also hold in this case. Now, suppose that u is incident to a 4-cycle. Color $G - \{uv\}$ by minimality and uncolor the vertices u and v . Observe that $|L(u)| \geq 2$ and $|L(v)| \geq 1$. Thus, u and v are colorable.

This concludes the proof. \square

Lemma 15. *A 3-cycle in G is not adjacent with a 4-cycle.*

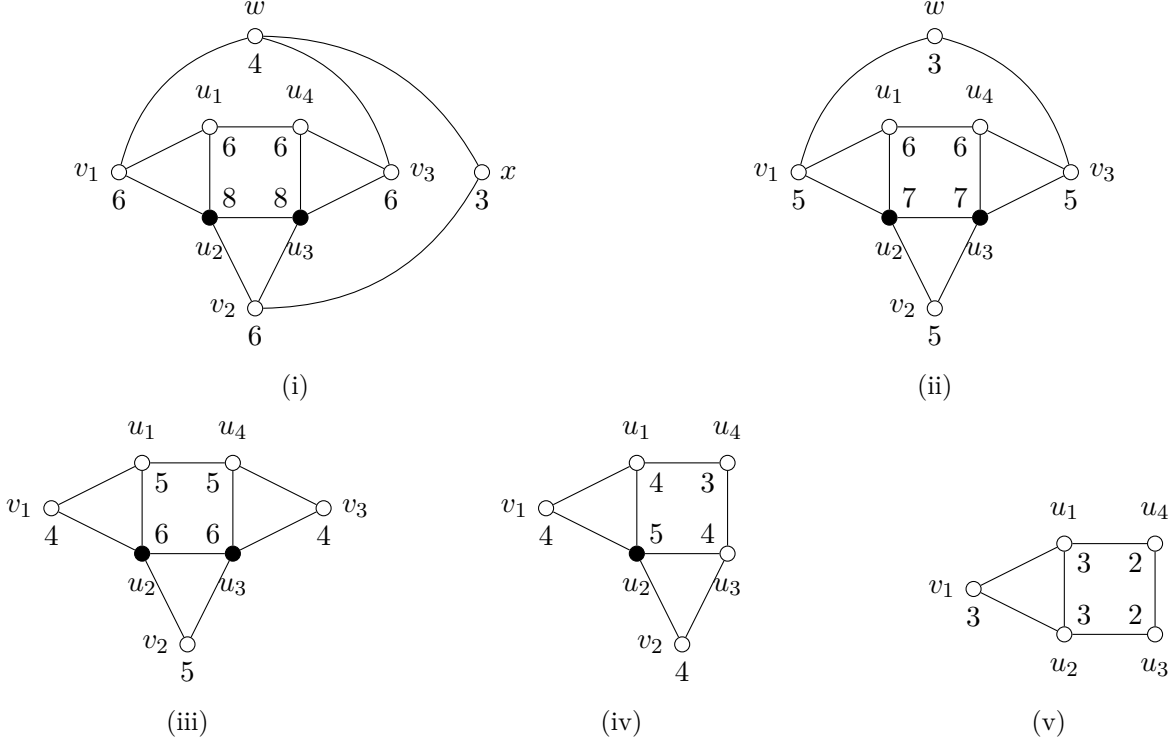

Figure 12: Reducible configurations in the proof of Lemma 15.

Proof. To prove Lemma 15, we will start by proving that the configurations in Figure 12 are reducible and observe that Lemma 15 corresponds to Figure 12(v). First, observe that the vertices in $S = \{u_1, u_2, u_3, u_4, v_1, v_2, v_3, w, x\}$ are pairwise distinct due to Lemma 14(iv).

- (i) Suppose first that G contains a configuration shown in Figure 12(i). Color $G - \{u_2, u_3\}$ and uncolor the remaining vertices in S . The remaining list of colors for the non-colored vertices have size: $|L(u_1)| \geq 6$, $|L(u_2)| \geq 8$, $|L(u_3)| \geq 8$, $|L(u_4)| \geq 6$, $|L(v_1)| \geq 6$, $|L(v_2)| \geq 6$, $|L(v_3)| \geq 6$, $|L(w)| \geq 4$, and $|L(x)| \geq 3$. Observe that u_1 cannot be adjacent to w as u_1, u_2, u_3, u_4, v_1 , and w would form the configuration in Lemma 14(iv). The same holds for u_4 and w . Moreover, v_1 and v_3 cannot both be adjacent to x as v_3, u_3, v_2, x, v_1 , and w would form the configuration in Lemma 14(iv). Due to the previous observations and due to planarity, either u_1 or u_4 do not share a common neighbor with x , say u_1 does not. In this case, we show that $L(u_1) \cap L(x) = \emptyset$. Otherwise, we can color u_1 and x with the same color and finish the coloring by coloring $w, v_1, v_2, v_3, u_4, u_2$, and u_3 , in this order. Consequently, $|L(u_1) \cup L(x)| \geq 9$. But then, G is L -list-colorable by Corollary 8.
- (ii) Suppose first that G contains a configuration shown in Figure 12(ii). Color $G - \{u_2, u_3\}$ and uncolor the other vertices. The remaining list of colors for these vertices have size: $|L(u_1)| \geq 6$, $|L(u_2)| \geq 7$, $|L(u_3)| \geq 7$, $|L(u_4)| \geq 6$, $|L(v_1)| \geq 5$, $|L(v_2)| \geq 5$, $|L(v_3)| \geq 5$, and $|L(w)| \geq 3$. Due to (i), v_2 and w cannot share a neighbor. We claim that $L(v_2) \cap L(w) = \emptyset$. Otherwise, we can

color v_2 and w with the same color and finish the coloring in this order: v_1, v_3, u_1, u_4, u_2 , and u_3 . Consequently, $|L(v_2) \cup L(w)| \geq 8$. By Corollary 8, this configuration is reducible.

- (iii) Suppose first that G contains a configuration shown in Figure 12(iii). Color $G - \{u_2, u_3\}$ and uncolor the other vertices. The remaining list of colors for these vertices have size: $|L(u_1)| \geq 5$, $|L(u_2)| \geq 6$, $|L(u_3)| \geq 6$, $|L(u_4)| \geq 5$, $|L(v_1)| \geq 4$, $|L(v_2)| \geq 5$, and $|L(v_3)| \geq 4$. Due to (ii), v_1 and v_3 cannot share a neighbor. We claim that $L(v_1) \cap L(v_3) = \emptyset$. Otherwise, we can color v_1 and v_3 with the same color and finish the coloring in this order: u_1, u_4, v_2, u_2 , and u_3 . Consequently, $|L(v_1) \cup L(v_3)| \geq 8$. By Corollary 8, this configuration is reducible.
- (iv) Suppose first that G contains a configuration shown in Figure 12(iv). Color $G - \{u_2, u_3\}$ and uncolor the other vertices. The remaining list of colors for these vertices have size: $|L(u_1)| \geq 4$, $|L(u_2)| \geq 5$, $|L(u_3)| \geq 4$, $|L(u_4)| \geq 3$, $|L(v_1)| \geq 4$, and $|L(v_2)| \geq 4$. Due to (iii), u_3 and u_4 cannot share a neighbor. We claim that $L(u_3) \cap L(u_4) = \emptyset$. Otherwise, we can color u_3 and u_4 with the same color and finish the coloring in this order: v_1, v_2, u_1 and u_2 . Consequently, $|L(u_3) \cup L(u_4)| \geq 7$. By Corollary 8, this configuration is reducible.
- (v) Finally, suppose first that G contains a configuration shown in Figure 12(v). Color $G - \{u_2, u_3\}$ and uncolor the other vertices. The remaining list of colors for these vertices have size: $|L(u_1)| \geq 2$, $|L(u_2)| \geq 3$, $|L(u_3)| \geq 3$, $|L(u_4)| \geq 2$, and $|L(v_2)| \geq 3$. Due to (iv), u_1 and u_2 cannot share a neighbor. The same holds for u_3 and u_4 . We claim that $L(u_1) \cap L(u_2) = \emptyset$. Otherwise, we can color u_1 and u_2 with the same color and finish the coloring in this order: u_4, v_2 , and u_3 . Consequently, $|L(u_1) \cup L(u_2)| \geq 5$. By symmetry, the same holds for $L(u_3)$ and $L(u_4)$. Thus, a 3-cycle adjacent to a 4-cycle in G is reducible by Corollary 8.

This concludes the proof. \square

We now look at adjacent 3-cycles.

Lemma 16. *If uvw and uvx are two adjacent 3-cycles in G with $x \neq w$, then x is not incident to another 3-cycle xyz with $y, z \notin \{u, v, w\}$.*

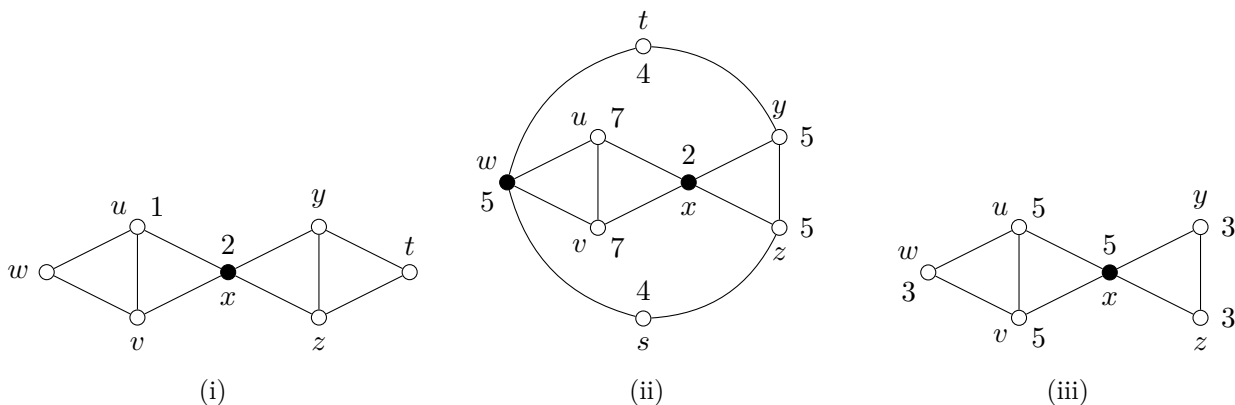

Figure 13: Reducible configurations in the proof of Lemma 16.

Proof. To prove Lemma 16, we will start by proving that the configurations in Figure 13 are reducible and observe that Lemma 16 corresponds to Figure 13(iii). First, observe that the vertices in $\{t, u, v, w, x, y, z\}$ are pairwise distinct due to Lemma 14(iv).

- (i) Color $G - \{ux\}$ and uncolor u and x . Observe that $|L(u)| \geq 1$ and $|L(x)| \geq 2$. Thus, u and x are colorable.
- (ii) First, observe that s is distinct from all other vertices due to (i) and Lemma 14(iv). Moreover, v cannot be adjacent to s due to Lemma 14(iv). The same holds for u and s . Also, s cannot be adjacent to t since z, y, t, s , and x would form the configuration in Lemma 15. Now, color $G - \{x\}$ and uncolor the other vertices. The remaining list of colors for these vertices have

size: $|L(u)| \geq 7$, $|L(v)| \geq 7$, $|L(w)| \geq 5$, $|L(x)| \geq 7$, $|L(y)| \geq 5$, $|L(z)| \geq 5$, $|L(s)| \geq 4$, and $|L(t)| \geq 4$. Due to the previous observations, w and s cannot share a neighbor. We claim that $L(w) \cap L(s) = \emptyset$. Otherwise, we can color w and s with the same color and finish the coloring in this order: t, y, z, u, v , and x . Consequently, $|L(w) \cup L(s)| \geq 9$. By Corollary 8, this configuration is reducible.

- (iii) Color $G - \{x\}$ and uncolor the other vertices. The remaining list of colors for these vertices have size: $|L(u)| \geq 5$, $|L(v)| \geq 5$, $|L(w)| \geq 3$, $|L(x)| \geq 5$, $|L(y)| \geq 3$, and $|L(z)| \geq 3$. Due to (ii), either w and y , or w and z cannot share a neighbor, say w and y . We claim that $L(w) \cap L(y) = \emptyset$. Otherwise, we can color w and y with the same color and finish the coloring in this order: z, u, v , and x . Consequently, $|L(w) \cup L(y)| \geq 6$. By Corollary 8, this configuration is reducible.

This concludes the proof. \square

Similar to 2-distance coloring, the constraint at distance 2 in an injective coloring also naturally pushes us to look at configurations around 5-faces.

Lemma 17. *Let $f = u_1u_2u_3u_4u_5$ be a 5-face in G and let $u_4u_5v_4$ and u_5v_4w be two distinct 3-faces. Then, f is adjacent to at most one other 3-face.*

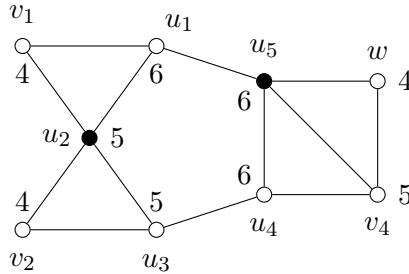

Figure 14: Reducible configuration in Lemma 17.

Proof. Suppose by contradiction that f is adjacent to at least two other 3-faces. In such a case, the only possible configuration must be the one in Figure 14 due to Lemma 14(iv) and Lemma 16. First, observe that the vertices in $S = \{u_1, u_2, u_3, u_4, u_5, v_1, v_2, v_4, w\}$ are pairwise distinct due to Lemma 14(ii, iv), Lemma 15, and Lemma 16. Color $G - \{u_1, u_2, u_3, u_4, u_5\}$ and uncolor $\{v_1, v_2, v_4, w\}$. The remaining list of colors for these vertices have size: $|L(u_1)| \geq 6$, $|L(u_2)| \geq 5$, $|L(u_3)| \geq 5$, $|L(u_4)| \geq 6$, $|L(u_5)| \geq 6$, $|L(v_1)| \geq 4$, $|L(v_2)| \geq 4$, $|L(v_4)| \geq 5$, and $|L(w)| \geq 4$.

Observe that v_4 cannot be adjacent to v_2 nor v_1 due to Lemma 15. Thus, u_2 and v_4 cannot share a neighbor. If $L(u_2) \cap L(v_4) \neq \emptyset$, then we color u_2 and v_4 with the same color. Now, we color w, v_1 , and v_2 . Observe that each of the remaining list of colors for u_1, u_3, u_4 , and u_5 has size at least 2 as they each see at most 4 different colors and if u_3 sees w then $|L(u_3)| \geq 6$. Moreover, u_1 (resp. u_3) cannot see u_5 (resp. u_4) by Lemma 14(iv) (resp. Lemma 16). Since each of the remaining four vertices sees exactly two others, we can finish the coloring by the 2-choosability of even cycles. Thus, we must have $L(u_2) \cap L(v_4) = \emptyset$.

We distinguish the following cases.

Case 1: v_1 shares a neighbor with u_4

Let u be their common neighbor. We get $u \neq v_4$ (resp. u_3) by Lemma 15 (resp. Lemma 14(iv)). We also have $u \neq u_5$ since vertices of S are all distinct. As a result, v_2 cannot share a neighbor with u_5 by planarity. Moreover, if w sees u_3 , then their common neighbor must be u by planarity. However, w, v_4, u_4, u , and u_5 form the configuration in Lemma 15. Thus, w cannot share a neighbor with u_3 .

- If $L(u_3) \cap L(w) \neq \emptyset$, color u_3 and w with the same color c . Let $L'(x)$ be the remaining list of colors for $x \in S \setminus \{u_3, w\}$.

- If $L'(u_5) \cap L'(v_2) \neq \emptyset$, then color u_5 and v_2 with the same color c' and complete the coloring by Corollary 8 as $L(u_2) \cap L(v_4) = \emptyset$ (as proven above).
- If $L'(u_5) \cap L'(v_2) = \emptyset$, then we complete the coloring of $S \setminus \{u_3, w\}$ by Corollary 8, which is possible since $|L'(u_2) \cup L'(v_4)| \geq 8$ and $|L'(u_5) \cup L'(v_2)| \geq 8$.
- If $L(u_3) \cap L(w) = \emptyset$, then $|L(u_3) \cup L(w)| \geq 9$.
 - If $L(u_5) \cap L(v_2) \neq \emptyset$, then color u_5 and v_2 with the same color c and complete the coloring by Corollary 8 as $L(u_2) \cap L(v_4) = \emptyset$ and $L(u_3) \cap L(w) = \emptyset$.
 - If $L(u_5) \cap L(v_2) = \emptyset$, then we complete the coloring of S by Corollary 8, which is possible since $|L(u_5) \cup L(v_2)| \geq 10$, $|L(u_3) \cup L(w)| \geq 9$, and $|L(u_2) \cup L(v_4)| \geq 10$.

Case 2: v_2 shares a neighbor with u_5 .

Let u be their common neighbor. We get $u \neq u_1$ (resp. u_4, v_4) by Lemma 14(iv) (resp. Lemma 16, Lemma 15). So, $u = w$. Observe that in this case, $|L(u_1)| \geq 6$, $|L(u_2)| \geq 6$, $|L(u_3)| \geq 6$, $|L(u_4)| \geq 6$, $|L(u_5)| \geq 7$, $|L(v_1)| \geq 4$, $|L(v_2)| \geq 6$, $|L(v_4)| \geq 6$, and $|L(w)| \geq 6$.

- If $L(u_4) \cap L(v_1) \neq \emptyset$, then color u_4 and v_1 with the same color c and complete the coloring by Corollary 8 as $L(u_2) \cap L(v_4) = \emptyset$.
- If $L(u_4) \cap L(v_1) = \emptyset$, then we complete the coloring of S by Corollary 8, which is possible since $|L(u_4) \cup L(v_1)| \geq 10$ and $|L(u_2) \cup L(v_4)| \geq 12$.

Case 3: v_1 does not share a neighbor with u_4 and v_2 does not share a neighbor with u_5 .

- If $L(u_4) \cap L(v_1) \neq \emptyset$, then color u_4 and v_1 with the same color c . Let $L'(x)$ be the remaining list of colors for $x \in S \setminus \{u_4, v_1\}$.
 - If $L'(u_5) \cap L'(v_2) \neq \emptyset$, then color u_5 and v_2 with the same color c' and complete the coloring by Corollary 8 as $L(u_2) \cap L(v_4) = \emptyset$.
 - If $L'(u_5) \cap L'(v_2) = \emptyset$, then we complete the coloring by Corollary 8, which is possible since $|L'(u_2) \cup L'(v_4)| \geq 8$ and $|L'(u_5) \cup L'(v_2)| \geq 8$.
- If $L(u_4) \cap L(v_1) = \emptyset$, then we complete the coloring of S by Corollary 8, which is possible since $|L(u_4) \cup L(v_1)| \geq 10$ and $|L(u_2) \cup L(v_4)| \geq 12$.
 - If $L(u_5) \cap L(v_2) \neq \emptyset$, then color u_5 and v_2 with the same color c and complete the coloring by Corollary 8 as $L(u_2) \cap L(v_4) = \emptyset$ and $L(u_4) \cap L(v_1) = \emptyset$.
 - If $L(u_5) \cap L(v_2) = \emptyset$, then we complete the coloring by Corollary 8, which is possible since $|L(u_2) \cup L(v_4)| \geq 10$, $|L(u_4) \cup L(v_1)| \geq 10$, and $|L(u_5) \cup L(v_2)| \geq 10$.

This concludes the proof. □

Lemma 18. *A 5-face in G is not incident to a 3-vertex and adjacent with three 3-faces.*

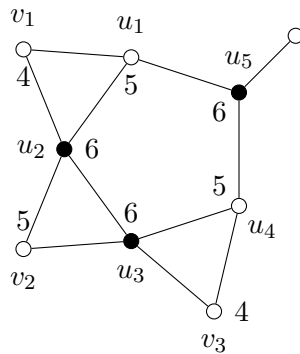

Figure 15: Reducible configuration in Lemma 18.

Proof. Suppose to the contrary that such a configuration exists in G . In which case, it must be the one in Figure 15 due to Lemma 14(ii). First, observe that the vertices in $S = \{u_1, u_2, u_3, u_4, u_5, v_1, v_2, v_3\}$ are pairwise distinct due to Lemma 14(iv) and Lemma 16. Color $G - \{u_1, u_2, u_3, u_4, u_5\}$ and uncolor $\{v_1, v_2, v_3\}$. The remaining list of colors for these vertices have size: $|L(u_1)| \geq 5$, $|L(u_2)| \geq 6$, $|L(u_3)| \geq 6$, $|L(u_4)| \geq 5$, $|L(u_5)| \geq 6$, $|L(v_1)| \geq 4$, $|L(v_2)| \geq 5$, and $|L(v_3)| \geq 4$. Observe that u_1 and u_5 cannot share a neighbor due to Lemma 14(ii). The same holds for u_4 and u_5 .

Moreover, we claim that either v_1 and u_4 , or v_3 and u_1 do not share a neighbor. Indeed, say v_1 and u_4 share a neighbor w , and v_3 and u_1 share a neighbor w' . Note that w is distinct from u_1 by Lemma 14(ii), from u_2 and u_3 since vertices of S are pairwise distinct, from v_2 by Lemma 14(iv), and from v_3 by Lemma 15. By symmetry and planarity, $w = w'$. However, this is impossible since w, u_1, u_5, u_4 , and v_1 form the configuration in Lemma 15.

Now, we can assume w.l.o.g. that v_1 and u_4 do not share a neighbor. In the following cases, we argue that G is always colorable.

- If $L(v_1) \cap L(u_4) \neq \emptyset$, then color v_1 and u_4 with the same color c . Now, let $L'(x)$ be the remaining list of colors for $x \in S \setminus \{v_1, u_4\}$.
 - If $L'(u_1) \cap L'(u_5) \neq \emptyset$, then color u_1 and u_5 with the same color (recall that they do not share a common neighbor) and finish by coloring v_2, v_3, u_2 , and u_3 in this order.
 - If $L'(u_1) \cap L'(u_5) = \emptyset$, then $|L'(u_1) \cup L'(u_5)| \geq 9$. In this case, we conclude by coloring $S \setminus \{v_1, u_4\}$ due to Corollary 8.
- If $L(v_1) \cap L(u_4) = \emptyset$, then $|L(v_1) \cup L(u_4)| \geq 9$. Now, we distinguish the two following cases.
 - If $L(u_1) \cap L(u_5) \neq \emptyset$, then color u_1 and u_5 with the same color c . Now, let $L'(x)$ be the remaining list of colors for $x \in S \setminus \{u_1, u_5\}$. Since $|L(v_1) \cup L(u_4)| \geq 9$, we have $|L'(v_1) \cup L'(u_4)| \geq 7$. Thus, we conclude by coloring $S \setminus \{u_1, u_5\}$ due to Corollary 8.
 - If $L(u_1) \cap L(u_5) = \emptyset$, then $|L(u_1) \cup L(u_5)| \geq 11$. Since we also have $|L(v_1) \cup L(u_4)| \geq 9$, we can conclude by coloring S due to Corollary 8.

This concludes the proof. □

Lemma 19. *A 5-face in G is not adjacent with five 3-faces.*

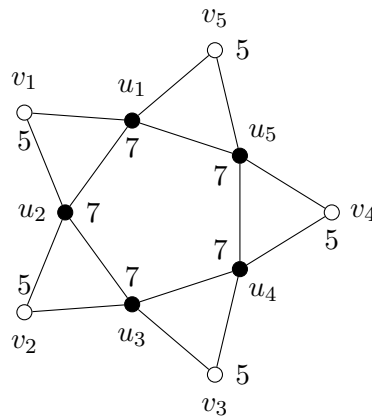

Figure 16: Reducible configuration in Lemma 19.

Proof. Suppose by contradiction that there exists a 5-face $f = u_1u_2u_3u_4u_5$ that is adjacent to five 3-faces like in Figure 16. First, observe that the vertices in $S = \{u_1, u_2, u_3, u_4, u_5, v_1, v_2, v_3, v_4, v_5\}$ are pairwise distinct due to Lemma 14(iv) and Lemma 16. Color $G - \{u_1, u_2, u_3, u_4, u_5\}$ and uncolor $\{v_1, v_2, v_3, v_4, v_5\}$. The remaining list of colors for these vertices have size: $|L(u_1)| \geq 7$, $|L(u_2)| \geq 7$, $|L(u_3)| \geq 7$, $|L(u_4)| \geq 7$, $|L(u_5)| \geq 7$, $|L(v_1)| \geq 5$, $|L(v_2)| \geq 5$, $|L(v_3)| \geq 5$, $|L(v_4)| \geq 5$, and

$|L(v_5)| \geq 5$. Observe that, for $1 \leq i \leq 5$, v_i and $v_{i+2(\bmod 5)}$ cannot be adjacent due to Lemma 15. By symmetry, the same holds for v_i and $v_{i+3(\bmod 5)}$. As a result, v_i and $u_{i+3(\bmod 5)}$ cannot share a neighbor for $1 \leq i \leq 5$. We have the following cases.

- If there exists $1 \leq i \leq 5$ such that $L(v_i) \cap L(u_{i+3(\bmod 5)}) \neq \emptyset$, say $i = 1$, then color v_1 and u_4 with the same color c . Now, let $L'(x)$ be the remaining list of colors for $x \in S \setminus \{v_1, u_4\}$.
 - If there exists $2 \leq i \leq 5$ such that $L'(v_i) \cap L'(u_{i+3(\bmod 5)}) \neq \emptyset$, say $i = 2$, then color v_2 and u_5 with the same color c' and let $L''(x)$ be the remaining list of colors for $x \in S \setminus \{v_1, v_2, u_4, u_5\}$.
 - * If $L''(v_3) \cap L''(u_1) \neq \emptyset$, then color v_3 and u_1 with the same color c'' and finish by coloring v_4, v_5, u_2 , and u_3 .
 - * If $L''(v_3) \cap L''(u_1) = \emptyset$, then $|L''(v_3) \cup L''(u_1)| \geq 8$. We complete the coloring of $S \setminus \{v_1, v_2, u_4, u_5\}$ by Corollary 8.
 - If, for every $2 \leq i \leq 5$, $L'(v_i) \cap L'(u_{i+3(\bmod 5)}) = \emptyset$, then $|L'(v_i) \cup L'(u_{i+3(\bmod 5)})| \geq 10$. In such a case, we can conclude by coloring $S \setminus \{v_1, u_4\}$ due to Corollary 8.
- If, for every $1 \leq i \leq 5$, $L(v_i) \cap L(u_{i+3(\bmod 5)}) = \emptyset$, then $|L(v_i) \cup L(u_{i+3(\bmod 5)})| \geq 12$. In such a case, we can conclude by coloring S due to Corollary 8.

It follows that a 5-face in G is adjacent with at most four 3-faces, thus concluding the proof. \square

For conciseness, we introduce a useful definition when considering 5-faces.

Bad faces: We call a 5-face *bad* if it is adjacent to four 3-faces (see Figure 17).

Observe that bad 5-faces are adjacent to exactly four 3-faces due to Lemma 19.

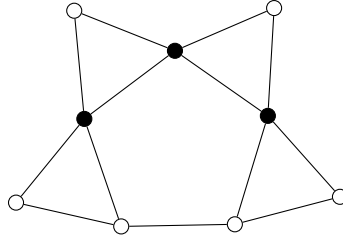

Figure 17: A bad 5-face.

We now turn our attention to bad 5-faces.

Lemma 20. *A bad 5-face in G is not adjacent with a 4-face.*

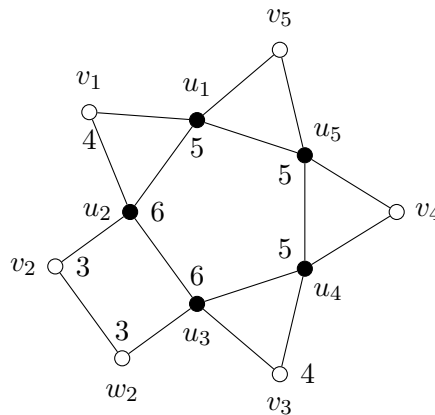

Figure 18: Reducible configuration in Lemma 20.

Proof. Suppose by contradiction that there exists a 5-face $f = u_1u_2u_3u_4u_5$ that is adjacent to four 3-faces and one 4-face like in Figure 18. First, observe that the vertices in $\{u_1, u_2, u_3, u_4, u_5, v_1, v_2, w_2, v_3, v_4, v_5\}$ are pairwise distinct due to Lemma 14(iv), Lemma 15, and Lemma 16. Color $G - \{u_1, u_2, u_3, u_4\}$ and uncolor $\{u_5, v_1, v_2, w_2, v_3\}$. Let $S = \{u_1, u_2, u_3, u_4, u_5, v_1, v_2, w_2, v_3\}$. The remaining list of colors for these vertices have size: $|L(u_1)| \geq 5$, $|L(u_2)| \geq 6$, $|L(u_3)| \geq 6$, $|L(u_4)| \geq 5$, $|L(u_5)| \geq 5$, $|L(v_1)| \geq 4$, $|L(v_2)| \geq 3$, $|L(w_2)| \geq 3$, and $|L(v_3)| \geq 4$.

Observe that v_1 and v_3 (resp. v_4) cannot be adjacent due to Lemma 15. The same holds for v_3 and v_5 . As a result, v_1 and u_4 (resp. v_3 and u_1) cannot share a neighbor.

Similarly, v_2 (resp. w_2) cannot be adjacent to v_5 (resp. v_4) by Lemma 15. As a result, if v_2 (resp. w_2) share a neighbor with u_5 , then v_2 must be adjacent to v_4 (resp. v_5). By planarity and by symmetry, we can assume w.l.o.g. that u_5 cannot share a neighbor with v_2 .

We distinguish the following cases.

- If $L(v_1) \cap L(u_4) \neq \emptyset$, then color v_1 and u_4 with the same color c . Now, let $L'(x)$ be the remaining list of colors for $x \in S \setminus \{v_1, u_4\}$.
 - If $L'(v_3) \cap L'(u_1) \neq \emptyset$, then color v_3 and u_1 with the same color c' . Due to Lemma 15, v_2 and w_2 (resp. u_2 and v_2 , u_3 and w_2) cannot share a neighbor. So, we can finish by coloring v_2, w_2, u_5, u_2 and u_3 .
 - If $L'(v_3) \cap L'(u_1) = \emptyset$, then $|L'(v_3) \cup L'(u_1)| \geq 7$.
 - * If $L'(v_2) \cap L'(u_5) \neq \emptyset$, then color v_2 and u_5 with the same color c' and finish by coloring w_2, v_3, u_1, u_2 and u_3 .
 - * If $L'(v_2) \cap L'(u_5) = \emptyset$, then $|L'(v_2) \cup L'(u_5)| \geq 6$. We complete the coloring of $S \setminus \{v_1, u_4\}$ by Corollary 8.
- If $L(v_1) \cap L(u_4) = \emptyset$, then by symmetry, $L(v_3) \cap L(u_1) = \emptyset$ due to the previous case. Thus, we have $|L(v_1) \cup L(u_4)| \geq 9$ and $|L(v_3) \cup L(u_1)| \geq 9$.
 - If $L(v_2) \cap L(u_5) \neq \emptyset$, then color v_2 and u_5 with the same color c . Let $L'(x)$ be the remaining list of colors for $x \in S \setminus \{v_2, u_5\}$. Since $|L(v_1) \cup L(u_4)| \geq 9$ and $|L(v_3) \cup L(u_1)| \geq 9$, we have $|L(v_1) \cup L(u_4)| \geq 7$ and $|L(v_3) \cup L(u_1)| \geq 7$. Thus, we can the coloring of $S \setminus \{v_2, u_5\}$ by Corollary 8.
 - If $L(v_2) \cap L(u_5) = \emptyset$, then $|L(v_2) \cup L(u_5)| \geq 8$. We can color S by Corollary 8.

This concludes the proof. □

Lemma 21. *A bad 5-face in G is not adjacent with a 5-face.*

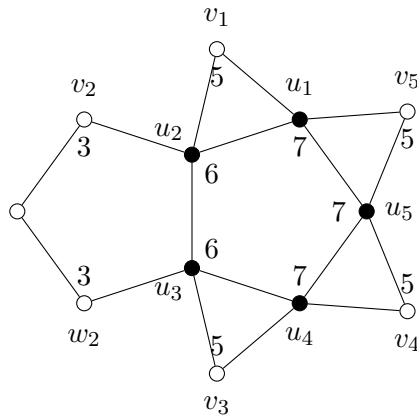

Figure 19: Reducible configuration in Lemma 21.

Proof. Suppose by contradiction that there exists a bad 5-face $f = u_1u_2u_3u_4u_5$ that is adjacent to a 5-face as shown in Figure 19. First, observe that the vertices in $S = \{u_1, u_2, u_3, u_4, u_5, v_1, v_2, w_2, v_3, v_4, v_5\}$ are pairwise distinct due to Lemma 14(iv), Lemma 15, and Lemma 16. Color $G - \{u_1, u_2, u_3, u_4, u_5\}$ and uncolor $\{v_1, v_2, w_2, v_3, v_4, v_5\}$. The remaining list of colors for these vertices have size: $|L(u_1)| \geq 7$, $|L(u_2)| \geq 6$, $|L(u_3)| \geq 6$, $|L(u_4)| \geq 7$, $|L(u_5)| \geq 7$, $|L(v_1)| \geq 5$, $|L(v_2)| \geq 3$, $|L(w_2)| \geq 3$, $|L(v_3)| \geq 5$, $|L(v_4)| \geq 5$, and $|L(v_5)| \geq 5$. Observe that the following pairs of vertices cannot share a neighbor:

- (u_1, v_3) and (u_4, v_1) . Otherwise, by symmetry, say v_3 sees u_1 , then it would need to be adjacent to v_1 or v_5 , which is impossible due to Lemma 15.
- (u_2, v_2) and (u_3, w_2) due to Lemma 16.
- (u_2, u_3) since they neighbors are distinct vertices.

We distinguish the following cases:

Case 1: $L(u_2) \cap L(v_2) \neq \emptyset$.

Color u_2 and v_2 with the same color c . Now, let $L'(x)$ be the remaining list of colors for $x \in S \setminus \{u_2, v_2\}$.

- If $L'(w_2) \cap L'(u_3) \neq \emptyset$, then color w_2 and u_3 with the same color c' . Let $L''(x)$ be the remaining list of colors for $x \in S \setminus \{u_2, u_3, v_2, w_2\}$. We have the following: $|L''(u_1)| \geq 5$, $|L''(u_4)| \geq 5$, $|L''(u_5)| \geq 5$, $|L''(v_1)| \geq 3$, and $|L''(v_3)| \geq 3$. Observe that $|L''(v_4)| \geq 4$ because if v_4 sees the color c , then v_4 sees either v_2 or u_2 , in which case we had $|L(v_4)| \geq 6$. The same holds for v_5 and c' .
 - If $L''(v_1) \cap L''(u_4) \neq \emptyset$ or $L''(v_3) \cap L''(u_1) \neq \emptyset$, say it holds for $L''(v_1)$ and $L''(u_4)$, then we color v_1 and u_4 with the same color c'' and finish by coloring v_3, v_4, v_5, u_5 , and u_1 .
 - If $L''(v_1) \cap L''(u_4) = \emptyset$ and $L''(v_3) \cap L''(u_1) = \emptyset$, then we complete the coloring by Corollary 8.
- If $L'(w_2) \cap L'(u_3) = \emptyset$, then we have following cases.
 - If $L'(v_1) \cap L'(u_4) \neq \emptyset$, then we color v_1 and u_4 with the same color c' . Let $L''(x)$ be the remaining list of colors for $x \in S \setminus \{u_2, u_4, v_2, v_1\}$. We have the following: $|L''(u_1)| \geq 5$, $|L''(u_3)| \geq 4$, $|L''(u_5)| \geq 5$, $|L''(v_3)| \geq 3$, $|L''(v_5)| \geq 3$, and $|L''(w_2)| \geq 1$. Similar to the previous case, even if v_4 sees c , we get $|L''(v_4)| \geq 4$. Moreover, we have $|L''(u_3) \cup L''(w_2)| = |L''(u_3)| + |L''(w_2)| \geq 7$ since $L''(u_3) \cap L''(w_2) = \emptyset$.
 - * If $|L''(w_2)| = 1$, then $|L''(u_3)| \geq 6$. Thus, we can coloring the remaining vertices in this order: $w_2, v_3, v_5, v_4, u_1, u_5$, and u_3 .
 - * If $|L''(w_2)| \geq 2$, then we can always color w_2 last. Now, we either complete the coloring by Corollary 8, or $L''(u_1) \cap L''(v_3) \neq \emptyset$, in which case, we color u_1 and v_3 with the same color and finish by coloring v_5, v_4, u_3, u_5 , and w_2 in this order.
 - If $L'(v_3) \cap L'(u_1) \neq \emptyset$, then we color v_3 and u_1 with the same color c' . Let $L''(x)$ be the remaining list of colors for $x \in S \setminus \{u_1, u_2, v_2, v_3\}$. We have the following: $|L''(u_3)| \geq 4$, $|L''(u_4)| \geq 5$, $|L''(u_5)| \geq 5$, $|L''(v_1)| \geq 3$, $|L''(v_4)| \geq 4$, $|L''(v_5)| \geq 3$, and $|L''(w_2)| \geq 1$. Moreover, we have $|L''(u_3) \cup L''(w_2)| = |L''(u_3)| + |L''(w_2)| \geq 7$ since $L''(u_3) \cap L''(w_2) = \emptyset$.
 - * If $|L''(w_2)| = 1$, then $|L''(u_3)| \geq 6$. Thus, we can coloring the remaining vertices in this order: $w_2, v_1, v_5, v_4, u_4, u_5$, and u_3 .
 - * If $|L''(w_2)| \geq 2$, then we can always color w_2 last. Now, we either complete the coloring by Corollary 8, or $L''(u_4) \cap L''(v_1) \neq \emptyset$, in which case, we color u_4 and v_1 with the same color and finish by coloring v_5, v_4, u_3, u_5 , and w_2 in this order.
 - If $L'(v_1) \cap L'(u_4) = \emptyset$ and $L'(v_3) \cap L'(u_1) = \emptyset$, then we have $|L'(v_1) \cup L'(u_4)| \geq 10$, $|L'(v_3) \cup L'(u_1)| \geq 10$, and $|L'(w_2) \cup L'(u_3)| \geq 8$. Thus, we can conclude by Corollary 8.

Case 2: $L(u_2) \cap L(v_2) = \emptyset$.

By symmetry, we also have $L(w_2) \cap L(u_3) = \emptyset$ or we would be back in **Case 1**.

- If $L(v_1) \cap L(u_4) \neq \emptyset$, then we color v_1 and u_4 with the same color c . Now, color v_2, w_2, v_3 , and v_4 in this order. Note that v_5 has at least one color left, otherwise $|L(v_5)| = 5$ and it would need to see every colored vertex in S , in which case $|L(v_5)| \geq 6$. So, we can also color v_5 . Let $L'(x)$ be the remaining list of colors for $x \in \{u_1, u_2, u_3, u_5\}$. By the same arguments along with the fact that $L(v_2) \cap L(u_2) = \emptyset$ and $L(w_2) \cap L(u_3) = \emptyset$, we must have $|L'(u_1)| \geq 3$, $|L'(u_2)| \geq 2$, $|L'(u_3)| \geq 2$, and $|L'(u_5)| \geq 3$. Observe that u_2 does not share a neighbor with u_3 . Thus, we can either complete the coloring by Corollary 8, or by coloring u_2 and u_3 with the same color and finish with u_1 and u_5 .
- If $L(v_1) \cap L(u_4) = \emptyset$, then by symmetry, we also have $L(v_3) \cap L(u_1) = \emptyset$ or we would be back to the previous case. In this case, we start by coloring v_2 and w_2 . Let $L'(x)$ be the remaining list of colors for $x \in S \setminus \{v_2, w_2\}$.
 - If $L'(u_2) \cap L'(u_3) \neq \emptyset$, then we color u_2 and u_3 with the same color c' . Let $L''(x)$ be the remaining list of colors for $x \in S \setminus \{u_2, u_3, v_2, w_2\}$. Observe that, by similar arguments as above, recounting the colors for $L''(x)$ gives us $|L''(u_1)| \geq 5$, $|L''(u_4)| \geq 5$, $|L''(u_5)| \geq 6$, $|L''(v_1)| \geq 3$, $|L''(v_3)| \geq 3$, $|L''(v_4)| \geq 4$, and $|L''(v_5)| \geq 4$. We can conclude by Corollary 8 since $|L''(v_1) \cup L''(u_4)| \geq 8$ and $|L''(v_3) \cup L''(u_1)| \geq 8$ as $L(v_1) \cap L(u_4) = \emptyset$ and $L(v_3) \cap L(u_1) = \emptyset$.
 - If $L'(u_2) \cap L'(u_3) = \emptyset$, then we have $|L'(u_2) \cup L'(u_3)| \geq 10$, $|L'(v_1) \cup L'(u_4)| \geq 10$, and $|L'(v_3) \cup L'(u_1)| \geq 10$ as $L(v_1) \cap L(u_4) = \emptyset$ and $L(v_3) \cap L(u_1) = \emptyset$. We complete the coloring by Corollary 8.

This concludes the proof. □

4.2 Discharging

Knowing the reducible structures in G , we apply the following rules in the discharging procedure to get a contradiction with Equation (1):

R0 Every 5^+ -face f gives $\frac{1}{3}$ to each incident 3-vertex.

R1 Every 5^+ -face f gives $\frac{1}{3}$ to each adjacent 3-face that is not adjacent with any 3-faces.

R2 Every 5^+ -face f gives $\frac{1}{2}$ to each adjacent 3-face that is adjacent with another 3-face.

R3 Every 6^+ -face f gives $\frac{1}{3}$ to each adjacent bad 5-face.

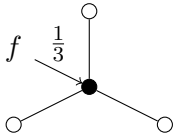

Figure 20: **R0**.

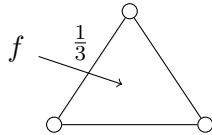

Figure 21: **R1**.

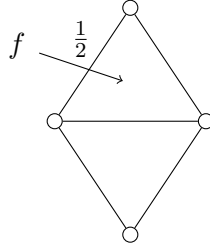

Figure 22: **R2**.

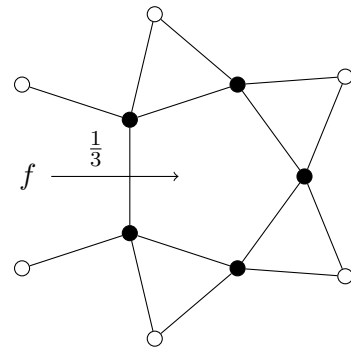

Figure 23: **R3**.

Now we prove Theorem 4 using both discharging procedure and structural properties of G proven in Section 4.1 and the discharging rules stated above.

Proof of Theorem 4. Let G be a minimal counterexample to the theorem and let $\mu(u)$ be the initial charge assignment for the vertices and faces of G with the charge $\mu(u) = d(u) - 4$ for each vertex

$u \in V(G)$, and $\mu(f) = d(f) - 4$ for each face $f \in F(G)$. By Equation (1), we have that the total sum of the charges is negative.

Let μ^* be the assigned charges after the discharging procedure. In what follows, we will prove that:

$$\forall x \in V(G) \cup F(G), \mu^*(x) \geq 0.$$

We first prove that the final charge on each vertex is non-negative. Let u be a vertex in $V(G)$. Note that u has degree at least 3 by Lemma 13. Recall also that $\Delta(G) = 4$ and $\mu(u) = d(u) - 4$, thus we now consider the following two cases.

Case 1: $d(u) = 4$

Then, u does not give any charge. So,

$$\mu^*(u) = \mu(u) = d(u) - 4 = 0.$$

Case 2: $d(u) = 3$

Then, $\mu(u) = d(u) - 4 = -1$. By Lemma 14(ii), u is incident to only 5^+ -faces. Thus, u receives three times $\frac{1}{3}$ by **R0**. So,

$$\mu^*(u) = -1 + 3 \cdot \frac{1}{3} = 0.$$

Secondly, we prove that the final charge on each face is also non-negative. Let f be a face in $F(G)$ and recall that $\mu(f) = d(f) - 4$. We distinguish the following cases.

Case 1: $d(f) \geq 6$

We claim that f never gives more than $\frac{1}{3}d(f)$ by **R0-R3**. Indeed, we argue that f sends at most $\frac{1}{3}$ per incident edge. Observe that we can also view **R0** and **R2** as f giving charge along an incident edge as shown in Figure 24. Consider an edge uv incident to f , if f gives $\frac{1}{6}$ along uv by **R0**, then it cannot give additional charge along uv by any other rule since a 3-vertex cannot be incident to a 3-cycle by Lemma 14(ii), and it cannot be at distance 1 from two adjacent 3-cycles by Lemma 14(iii). If f gives $\frac{1}{3}$ along uv by **R1**, then it cannot give along uv by **R2** due to Lemma 14(iv), nor by **R3** by definition. If f gives (at most $\frac{1}{3}$) along uv by **R2**, then it cannot also give along uv by **R3** due to Lemma 16. To conclude, we have

$$\mu^*(u) \geq \mu(u) - \frac{1}{3}d(f) = d(f) - 4 - \frac{1}{3}d(f) = \frac{2}{3}d(f) - 4 \geq 0$$

since $d(f) \geq 6$.

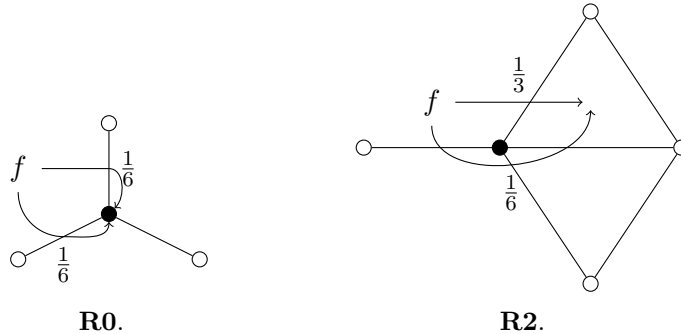

Figure 24: A 6^+ -face f sending charges through incident edges.

Case 2: $d(f) = 5$

Recall that $\mu(f) = d(f) - 4 = 1$. Let i_0 , i_1 , and i_2 be respectively the number of times f gives charge by **R0**, **R1**, and **R2**. Note that **R3** does not apply to 5-faces. Observe now that we have the following inequalities:

- $i_1 \leq 4$ by Lemma 19.
- $i_0 + i_2 \leq 2$ by Lemma 14 and lemma 16.
- If $i_0 \geq 1$, then $i_0 + i_1 \leq 3$ by Lemma 14(i, ii) and Lemma 18.

Recall that f gives $\frac{1}{3}i_0 + \frac{1}{3}i_1 + \frac{1}{2}i_2$ by **R0**, **R1**, and **R2**.

If $i_2 = 2$, then $i_0 = 0$ since $i_0 + i_2 \leq 2$. We have $i_1 = 0$ due to Lemma 14(iv) and Lemma 16. Thus,

$$\mu^*(f) \geq 1 - 2 \cdot \frac{1}{2} = 0.$$

If $i_2 = 1$, then we have the two following cases since $i_0 + i_2 \leq 2$:

- If $i_0 = 1$, then $i_1 = 0$ due to Lemma 14(ii, iii, iv) and Lemma 16. Thus,

$$\mu^*(f) \geq 1 - \frac{1}{3} - \frac{1}{2} = \frac{1}{6}.$$

- If $i_0 = 0$, then $i_1 \leq 1$ due to Lemma 17. Thus,

$$\mu^*(f) \geq 1 - \frac{1}{3} - \frac{1}{2} = \frac{1}{6}.$$

If $i_2 = 0$, then we distinguish two cases:

- If $i_0 \geq 1$, then recall $i_0 + i_1 \leq 3$. Thus,

$$\mu^*(f) \geq 1 - 3 \cdot \frac{1}{3} = 0.$$

- If $i_0 = 0$ and $i_1 \leq 3$, then

$$\mu^*(f) \geq 1 - 3 \cdot \frac{1}{3} = 0.$$

- If $i_0 = 0$ and $i_1 = 4$ (recall $i_1 \leq 4$), then f is adjacent to a 6^+ -face due to Lemma 20 and Lemma 21. So f receives $\frac{1}{3}$ by **R3**. Thus,

$$\mu^*(f) \geq 1 - 4 \cdot \frac{1}{3} + \frac{1}{3} = 0.$$

Thus, we have that after the discharging procedure 5-faces have non-negative charge.

Case 3: $d(f) = 4$

Since 4-faces do not give any charge, we have

$$\mu^*(f) = \mu(f) = d(f) - 4 = 0.$$

Case 4: $d(f) = 3$

Recall that $\mu(f) = d(f) - 4 = -1$. If f is adjacent only with 5^+ -faces, then f receives three times $\frac{1}{3}$ by **R1**. So,

$$\mu^*(f) \geq -1 + 3 \cdot \frac{1}{3} = 0.$$

On the other hand, if f is adjacent to a 4^- -face, then by Lemma 15 and Lemma 14(iv) f is adjacent with exactly one 3-face. In such a case, it receives $\frac{1}{2}$ from each of the two adjacent 5^+ -faces by **R2**. So,

$$\mu^*(f) \geq -1 + 2 \cdot \frac{1}{2} = 0.$$

Finally, it follows that after the discharging procedure the charge of every vertex and every face is non-negative and thus the final total sum is non-negative, a contradiction to Equation (1). \square

5 Injective list-coloring of triangle-free planar graphs

Let G be a minimal counterexample to Theorem 5. More precisely, G has maximum degree 4, girth at least 4, and $\chi_\ell^i(G) \geq 10$.

5.1 Structural properties of G

Observe that since $g(G) \geq 4$, whenever two vertices are adjacent, they do not see each other (they do not share a common neighbor). Otherwise, G would contain a 3-cycle. As a result, an injective coloring of G is also an exact square coloring as only vertices at distance exactly 2 see each other.

Lemma 22. *The minimum degree of G is at least 2.*

Proof. If G contains a 1-vertex v , then we can simply remove v and color the resulting graph, which is possible by minimality of G . Then, we add v back and extend the coloring, since v shares a neighbor with at most 3 other vertices and we have 9 colors in total. \square

Unlike the previous cases, we do not have enough colors to reduce a 2-vertex directly. However, the presence of such a “small” vertex guarantees that its neighbors must have a larger neighborhood.

Lemma 23. *If a 4-vertex u in G is adjacent to a 2-vertex, then $d^{\#2}(u) \geq 9$.*

Proof. Suppose by contradiction that u is a 4-vertex that is adjacent to a 2-vertex v and $d^{\#2}(u) \leq 8$. Then, color $G - \{v\}$ by minimality and uncolor u . Vertex u sees as many colors as $d^{\#2}(u) \leq 8$, so u is colorable. Finish by coloring v which sees only $d^{\#2}(v) \leq 6$ colors. \square

Lemma 24. *Graph G cannot contain the following configurations:*

- (i) Two adjacent 3^- -vertices.
- (ii) A 4-vertex adjacent to two 2-vertices.
- (iii) A 4-vertex adjacent to a 2-vertex and two 3-vertices.
- (iv) A 2-vertex incident to a 4-cycle.
- (v) A 3-vertex incident to two 4-cycles.
- (vi) A 4-vertex u adjacent to a 2-vertex and a 3-vertex v , and uv is incident to a 4-cycle.

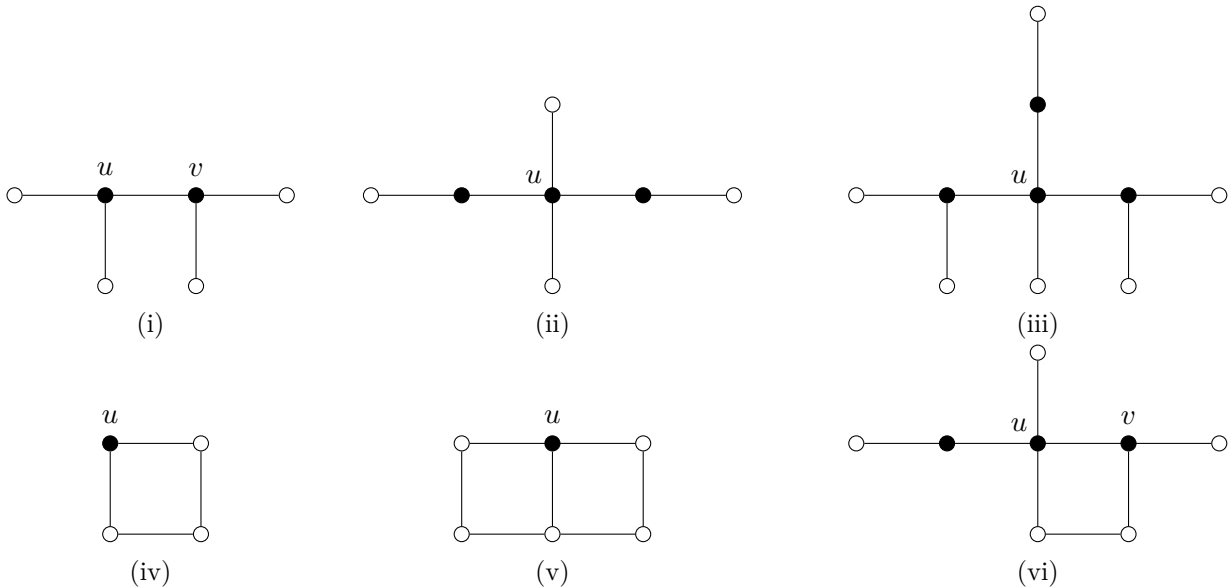

Figure 25: Reducible configurations in Lemma 24.

Proof. We separate the proof into four parts based on the configurations.

- (i) Suppose by contradiction that there exist two adjacent 3^- -vertices u and v . Color $G - \{uv\}$ by minimality. Uncolor u and v . Observe that $d^{\#2}(u) \leq 8$. The same holds for v . Thus, u and v are colorable.
- (iv) Suppose by contradiction that there exists a 2-vertex u incident to a 4-cycle. Color $G - \{u\}$ by minimality. Observe that the two neighbors of u will also have different colors in G since they are at distance 2 in $G - \{u\}$. Thus, we only need to color u which sees only $d^{\#2}(u) \leq 5$ colors.
- (v) Suppose by contradiction that there exists a 3-vertex u incident to two 4-cycles. Let e be the edge incident to u that is incident to both cycles. Color $G - \{e\}$ by minimality and uncolor u . Observe that every pair of neighbors of u are still at distance 2 in $G - \{e\}$. Thus, we only need to color u which sees only $d^{\#2}(u) \leq 7$ colors.
- (ii), (iii), and (vi) Observe that the 4-vertex u with the 2-neighbor in these configurations always verifies $d^{\#2}(u) \leq 8$, which is impossible due to Lemma 23.

Thus, if G contains any of the above configurations, then $\chi_\ell^i(G) \leq 9$, a contradiction. \square

Before continuing with proving some more structural results, we first give some additional useful definitions and observations.

Good and bad faces: We call a 5-face *bad* if it is incident to a 2-vertex and a 3-vertex. Additionally, we call a 5^+ -face *good*, if it is not a bad 5-face.

The following observation is a direct consequence of Lemma 24(i).

Observation 25. *A 2-vertex and a 3-vertex on a bad 5-face f in G must be at distance 2 and they are the only 3^- -vertices on f .*

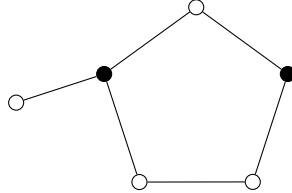

Figure 26: A bad face.

To further help us with the proofs, we now divide 3^- -vertices into three different types.

Small, medium, and large 3^- -vertices: We call a 3^- -vertex *small*, if it is either a 2-vertex or a 3-vertex incident to a bad 5-face and a 4-face. A 3-vertex is called *medium*, if it is incident to either a bad 5-face or a 4-face. Finally, a 3-vertex is called *large*, if it is neither medium nor small.

Due to Lemma 24(vi) we have the following observation.

Observation 26. *A 4-face in G , adjacent with a bad 5-face f and incident to a small 3-vertex v , is not incident to the common neighbor of a vertex v and the 2-vertex on f .*

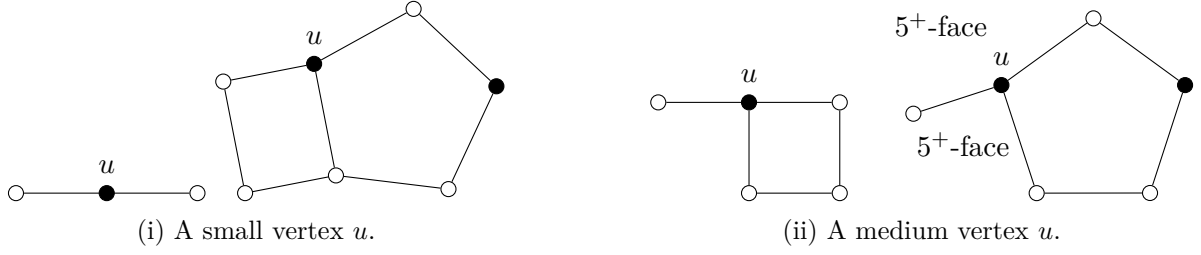

Figure 27: Small and medium 3^- -vertices.

We are now ready to prove some structural properties regarding bad 5-faces.

Lemma 27. *Let $f = v_1v_2v_3v_4v_5$ be a bad 5-face in G where v_1 is the 3-vertex and v_3 is the 2-vertex. Let $f' = v'_1v'_2v'_3v'_4v'_5 \neq f$ be another 5-face incident to $v_1 = v'_1$. Then, we have the following:*

- If f' is incident to v_1v_2 , then f' does not contain any other 3^- -vertices (distinct from v_1).
- If f' is incident to v_1v_5 , then f' does not contain any other small vertices (distinct from v_1).

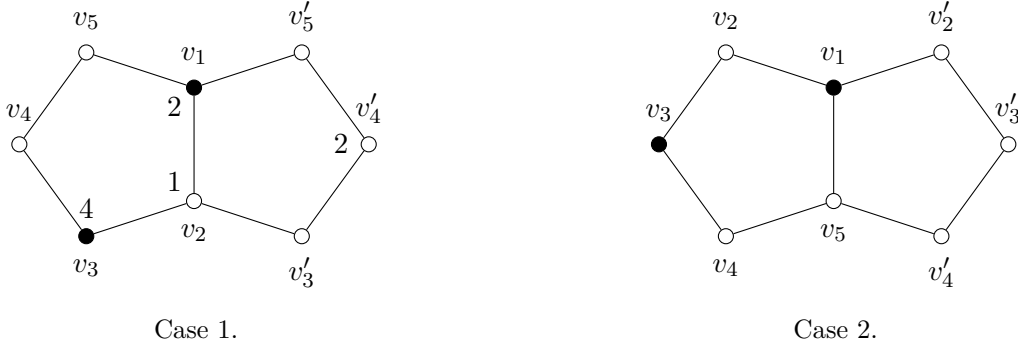

Figure 28: Reducible configurations from Lemma 27.

Proof. We assume w.l.o.g. that $v'_1 = v_1$. Since $g(G) \geq 4$, every vertex of f and f' (except for the two common vertices that is v_1 and one of its neighbor) is distinct.

Suppose by contradiction that f' contains (another) small vertex different from v_1 .

Case 1: If f' is incident to v_1v_2 , say $v'_2 = v_2$. First, observe that $d(v'_3) = 4$ due to Lemma 24(iii) and $d(v'_5) = 4$ due to Lemma 24(i). Thus, v'_4 must be a 3^- -vertex. Color $G - \{v_3\}$ and uncolor v_1, v_2 , and v'_4 . Observe that $|L(v_1)| \geq 2$, $|L(v_2)| \geq 1$, $|L(v_3)| \geq 4$, $|L(v'_4)| \geq 2$. Therefore, we can color v_2, v'_4, v_1 , and v_3 in this order.

Case 2: If f' is incident to v_1v_5 , say $v'_5 = v_5$. By Lemma 24(i), v'_2 cannot be a small vertex, and at most one of v'_3 and v'_4 can be. Thus, we have the following two cases:

- If v'_4 is a 3^- -vertex, then color $G - \{v_3\}$ and uncolor v_1, v_4 , and v'_4 . Observe that $|L(v_1)| \geq 3$, $|L(v_4)| \geq 1$, $|L(v_3)| \geq 4$, $|L(v'_4)| \geq 2$. Therefore, we can color v_4, v'_4, v_1 , and v_3 in this order.
- If v'_3 is a 3^- -vertex, then recall that v'_3 is a small vertex.
 - If v'_3 is a small 3-vertex, then it is incident to a bad 5-face $f'' \neq f'$ (since f' is a good face) and a 4-face. If f'' is incident to $v'_2v'_3$, then the 4-face must be incident to $v'_3v'_4$. By Lemma 24(iii, vi), f'' cannot be incident to a 2-vertex, which is a contradiction. Thus, f'' must be incident to $v'_3v'_4$. By Lemma 24(vi), the 2-vertex incident to f'' must be adjacent to v'_4 . However, in this case, we can use the same proof as in **Case 1** from the point of view of v'_3, f'' , and f' instead.

- If v'_3 is a 2-vertex, then we color $G - \{v_3\}$ and uncolor every vertex on f and f' . Observe that the remaining list of colors for these vertices have size: $|L(v_1)| \geq 5$, $|L(v_2)| \geq 3$, $|L(v_3)| \geq 5$, $|L(v_4)| \geq 2$, $|L(v_5)| \geq 2$, $|L(v'_2)| \geq 3$, $|L(v'_3)| \geq 5$, and $|L(v'_4)| \geq 2$. Moreover, if we can color v_2, v_4, v_5, v'_2 , and v'_4 , then we can always finish by coloring v_1, v'_3 , and v_3 in this order.

If $L(v_4)$ and $L(v_5)$ have a common color c , then we color them with c and color v'_4, v_2 , and v'_2 in this order. The same holds for $L(v'_4)$ and $L(v_5)$. As a result, $|L(v_4) \cup L(v_5)| \geq 4$ and $|L(v'_4) \cup L(v_5)| \geq 4$.

If $L(v_4)$ and $L(v'_2)$ have a common color c , then we proceed as follows. Suppose v_4 and v'_2 do not see each other, then we color them with c . Recall that $L(v'_4) \cap L(v_5) = \emptyset$. So, we can color v'_4, v_2 , and v_5 in this order. The same holds for $L(v'_4)$ and $L(v_2)$. As a result, if $L(v_4)$ and $L(v'_2)$ share a color, then v_4 must see v'_2 . The same holds for v'_4 and v_2 . By planarity, v_2, v_4, v'_2 , and v'_4 must share a common neighbor u . However, this is impossible since v_3 would be a 2-vertex incident to the 4-cycle $v_2v_3v_4u$ contradicting Lemma 24(iv). Finally, we must have $|L(v_4) \cup L(v'_2)| \geq 5$ or $|L(v'_4) \cup L(v_2)| \geq 5$.

Finally, we have $|L(v_4) \cup L(v_5)| \geq 4$, $|L(v'_4) \cup L(v_5)| \geq 4$, and at least one of the following two inequalities: $|L(v_4) \cup L(v'_2)| \geq 5$ or $|L(v'_4) \cup L(v_2)| \geq 5$. Therefore, we can always color v_2, v_4, v_5, v'_2 , and v'_4 by Corollary 8.

Thus, we can conclude that $\chi_\ell^i(G) \leq 9$, a contradiction. \square

Finally, we show that small vertices cannot be close to each other from the perspective of a face of size at least 6.

Definition 28 (Facial-distance). *Let $f = u_1u_2 \dots u_{d(f)}$ be a face in $F(G)$, and let u_i and u_j be vertices incident to f . The facial-distance on f between u_i and u_j is their distance on the cycle $u_1u_2 \dots u_{d(f)}$ (which is $\min(i - j \pmod{d(f)}, j - i \pmod{d(f)})$).*

Lemma 29. *Two small vertices incident to a same 6^+ -face f in G are at facial-distance at least 3 on f .*

Proof. By Lemma 24(i), small vertices cannot be adjacent. By Lemma 24(ii), two 2-vertices must be at distance at least 3. We only need to check if a small 3-vertex and a 2-vertex, or two small 3-vertices can be at facial-distance 2 on f . Let $f = v_1v_2v_3v_4 \dots$ is a 6^+ -face.

Suppose that v_1 is a 2-vertex and v_3 a small 3-vertex. Observe that v_2v_3 cannot be incident to a 4-face by Lemma 24(vi), so v_3v_4 must be incident to a 4-face and v_2v_3 is incident to a bad 5-face (different from f since f is a 6^+ -face). However, due to Lemma 24(ii, vi), the bad 5-face incident to v_2v_3 cannot be incident to a 2-vertex, which is a contradiction.

Now, suppose that v_1 and v_3 are small 3-vertices. They must both be incident to some 4-faces and bad 5-faces. If v_3v_4 is incident to a 4-face, then v_2v_3 must be incident to a bad 5-face. However, by Lemma 24(i, iii, vi), this 5-face cannot be incident to any 2-vertex. As a result, v_2v_3 must be incident to a 4-face. By symmetry, v_1v_2 is also incident to a 4-face. Additionally, v_3v_4 must be incident to a bad 5-face. By Lemma 24(vi), the 2-vertex u on this bad 5-face must be adjacent to v_4 . Now, color $G - \{u\}$ and uncolor v_4 and v_2 . Observe that $|L(v_4)| \geq 1$, $|L(v_2)| \geq 2$, and $|L(u)| \geq 3$. Thus, we can finish by coloring v_4, v_2 , and v_3 in this order. \square

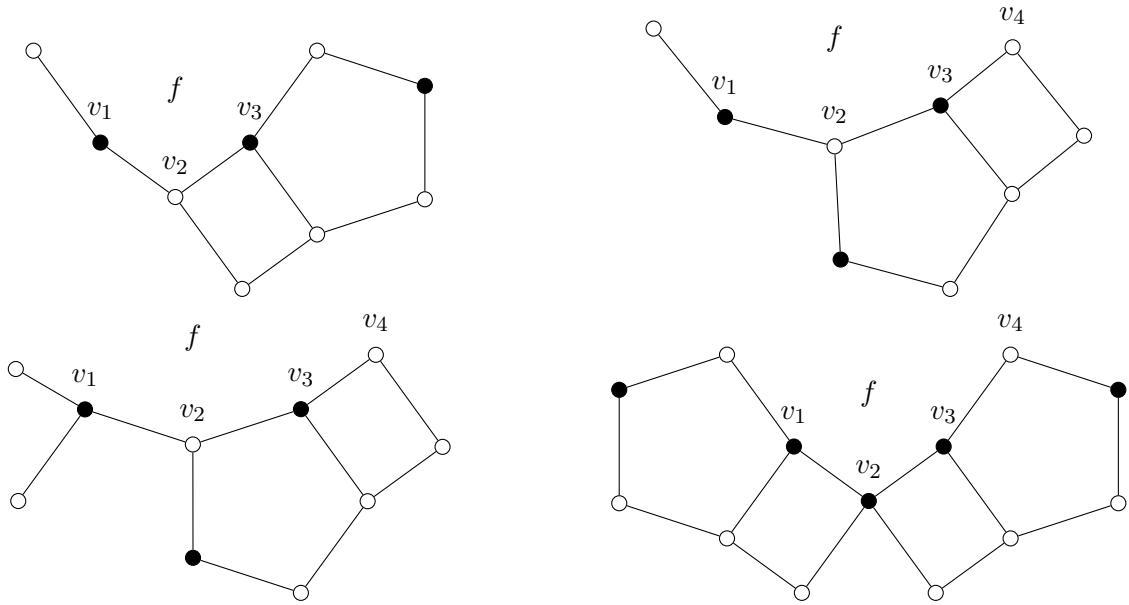

Figure 29: Reducible configurations in Lemma 29.

5.2 Discharging procedure

To get a contradiction with Equation (1) we apply the following rules in the discharging procedure:

R0 Every 5^+ -face f gives 1 to each 2-vertex.

R1 Every good 5^+ -face f gives 1 to each small 3-vertex.

R2 Every good 5^+ -face f gives $\frac{1}{2}$ to each medium 3-vertex.

R3 Every 5^+ -face f gives $\frac{1}{3}$ to each large 3-vertex.

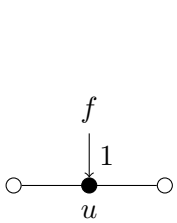

Figure 30: **R0.**

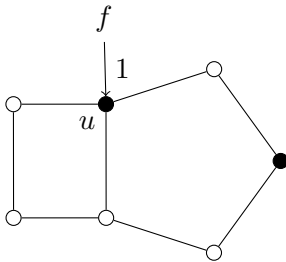

Figure 31: **R1.**

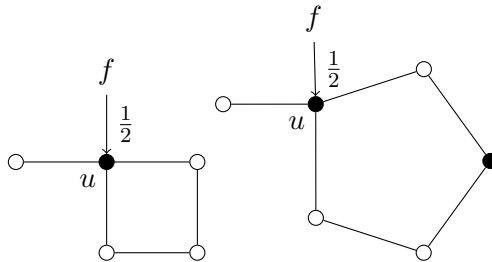

Figure 32: **R2.**

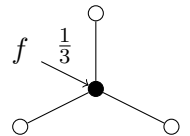

Figure 33: **R3.**

Now we can proceed by proving Theorem 5 using the discharging procedure together with the structural properties of G proven in Section 5.1 and the discharging rules stated above.

Proof of Theorem 5. Let G be a minimal counterexample to the theorem and let $\mu(u)$ be the initial charge assignment for the vertices and faces of G with the charge $\mu(u) = d(u) - 4$ for each vertex $u \in V(G)$, and $\mu(f) = d(f) - 4$ for each face $f \in F(G)$. By Equation (1), we have that the total sum of the charges is negative.

Let μ^* be the assigned charges after the discharging procedure. In what follows, we will prove that:

$$\forall x \in V(G) \cup F(G), \mu^*(x) \geq 0.$$

Let u be a vertex in $V(G)$. Vertex u has degree at least 2 by Lemma 22. Recall that $\Delta(G) = 4$ and $\mu(u) = d(u) - 4$.

Case 1: If $d(u) = 4$, then u does not give any charge. So,

$$\mu^*(u) = \mu(u) = d(u) - 4 = 0.$$

Case 2: If $d(u) = 3$, then $\mu(u) = d(u) - 4 = -1$ and we have the following cases:

- If u is a small 3-vertex, then u is incident to one good 5^+ -face due to Lemma 24(v) and Lemma 27. By **R1**, we have

$$\mu^*(u) \geq -1 + 1 = 0.$$

- If u is a medium 3-vertex, then it is incident to two good 5^+ -faces due to Lemma 24(v) and Lemma 27. By **R2**, we have

$$\mu^*(u) \geq -1 + 2 \cdot \frac{1}{2} = 0.$$

- If u is a large 3-vertex, then by definition, u is incident to only 5^+ -face. Thus, by **R3**, we have

$$\mu^*(u) \geq -1 + 3 \cdot \frac{1}{3} = 0.$$

Case 3: If $d(u) = 2$, then u has to be incident to only 5^+ -faces due to Lemma 24(iv). By **R0**, we have

$$\mu^*(u) \geq d(u) - 4 + 2 \cdot 1 = 0.$$

Let f be a face in $F(G)$. Recall that $\mu(f) = d(f) - 4$ and $d(f) \geq 4$ since $g(G) \geq 4$. Let i_0, i_1, i_2 , and i_3 be respectively the number of times f gives charge by **R0**, **R1**, **R2**, and **R3**. We distinguish the following cases.

Case 1: $d(f) \geq 7$

Let u and v be two small vertices on f . By Lemma 29, u and v must be at facial-distance at least 3 on f . As a result, the neighbors of u and v on f are distinct. Moreover, due to Lemma 24(i), those neighbors are 4-vertices. Thus, we also have $i_2 + i_3 \leq d(f) - 3(i_0 + i_1)$. Due to Lemma 24(i), we also have $i_2 + i_3 \leq \frac{1}{2}d(f)$. Consequently, $i_2 + i_3 \leq \min(d(f) - 3(i_0 + i_1), \frac{1}{2}d(f))$.

We claim that f gives at most $\frac{5}{12}d(f)$ charge away. Indeed, recall that f gives $i_0 + i_1 + \frac{1}{2}i_2 + \frac{1}{3}i_3$ by **R0**, **R1**, **R2**, and **R3**. By the above inequalities,

- if $d(f) - 3(i_0 + i_1) \leq \frac{1}{2}d(f)$, then $i_0 + i_1 \geq \frac{1}{6}d(f)$. Moreover, we get

$$\begin{aligned} i_0 + i_1 + \frac{1}{2}i_2 + \frac{1}{3}i_3 &\leq i_0 + i_1 + \frac{1}{2}(i_2 + i_3) \\ &\leq i_0 + i_1 + \frac{1}{2}(d(f) - 3(i_0 + i_1)) \\ &\geq \frac{1}{2}(d(f) - (i_0 + i_1)) \\ &\geq \frac{1}{2}(d(f) - \frac{1}{6}d(f)) \\ &\geq \frac{5}{12}d(f) \end{aligned}$$

- if $d(f) - 3(i_0 + i_1) > \frac{1}{2}d(f)$, then $i_0 + i_1 < \frac{1}{6}d(f)$. Moreover, we get

$$\begin{aligned} i_0 + i_1 + \frac{1}{2}i_2 + \frac{1}{3}i_3 &\leq i_0 + i_1 + \frac{1}{2}(i_2 + i_3) \\ &\leq \frac{1}{6}d(f) + \frac{1}{2} \cdot \frac{1}{2}d(f) \\ &\geq \frac{5}{12}d(f) \end{aligned}$$

To conclude, we have

$$\mu^*(f) \geq d(f) - 4 - \frac{5}{12}d(f) \geq \frac{7}{12}d(f) - 4 \geq 0$$

since $d(f) \geq 7$.

Case 2: $d(f) = 6$

Similar to the previous case, two small vertices cannot be at facial-distance 2 on f by Lemma 29. As a result, we get $i_0 + i_1 \leq 2$. Moreover, by Lemma 24(i), two 3^- -vertices cannot be adjacent, so we get $i_0 + i_1 + i_2 + i_3 \leq 3 \Leftrightarrow i_2 + i_3 \leq 3 - (i_0 + i_1)$. Now, we distinguish the following cases.

- If $i_0 + i_1 = 2$, then observe that, since small vertices cannot share neighbors on f and that their neighbors are all 4-vertices, we have exactly two 3^- -vertices on f . In other words, $i_2 + i_3 = 0$. Recall that $\mu(f) = d(f) - 4 = 2$ and that f gives $i_0 + i_1 + \frac{1}{2}i_2 + \frac{1}{3}i_3$ by **R0**, **R1**, **R2**, and **R3**. Thus,

$$\mu^*(f) \geq 2 - (i_0 + i_1 + \frac{1}{2}i_2 + \frac{1}{3}i_3) = 2 - 2 + 0 = 0.$$

- If $i_0 + i_1 \leq 1$, then we get

$$\mu^*(f) \geq 2 - (i_0 + i_1 + \frac{1}{2}i_2 + \frac{1}{3}i_3) \geq 2 - (i_0 + i_1 + \frac{1}{2}(3 - (i_0 + i_1))) \geq \frac{1}{2} - \frac{1}{2}(i_0 + i_1) \geq 0.$$

Case 3: $d(f) = 5$

Recall that $\mu(f) = d(f) - 4 = 1$. Observe that we have the following inequalities.

- $i_0 + i_1 + i_2 + i_3 \leq 2$ since there are no adjacent 3^- -vertices by Lemma 24(i).
- $i_0 \leq 1$ due to Lemma 24(ii).
- $i_1 \leq 1$ due to Lemma 27.

Recall that f gives $i_0 + i_1 + \frac{1}{2}i_2 + \frac{1}{3}i_3$.

- If $i_0 = 1$, then either f is incident to a 3-vertex, in which case, it is a bad 5-face and **R1**, **R2**, **R3** do not apply (by definition of a bad face), or it is not incident to any 3-vertex. In both cases, $i_1 + i_2 + i_3 = 0$. So,

$$\mu^*(f) \geq 1 - (i_0 + i_1 + \frac{1}{2}i_2 + \frac{1}{3}i_3) \geq 1 - (1 + 0) = 0.$$

- If $i_0 = 0$ and $i_1 = 1$, then f cannot be incident to any other (than the small 3-vertex) 3^- -vertices due to Lemma 27. As a result, $i_2 + i_3 = 0$. So,

$$\mu^*(f) \geq 1 - (i_0 + i_1 + \frac{1}{2}i_2 + \frac{1}{3}i_3) \geq 1 - (1 + 0) = 0.$$

- If $i_0 = i_1 = 0$, then

$$\mu^*(f) \geq 1 - (i_0 + i_1 + \frac{1}{2}i_2 + \frac{1}{3}i_3) \geq 1 - (0 + \frac{1}{2} \cdot 2) = 0.$$

Case 4: $d(f) = 4$

Recall that $\mu(f) = d(f) - 4 = 0$. Since f does not give any charge, we have

$$\mu^*(f) = \mu(f) = 0.$$

We started with a negative total charge, but after the discharging procedure, which preserved the total sum, we end up with a non-negative total sum, a contradiction with Equation (1). In other words, there exist no counter-examples to Theorem 5. \square

6 Exact square list-coloring of planar graphs

Let G be a minimal counterexample to Theorem 6. More precisely, G has maximum degree 4 and $\chi_\ell^{\#2}(G) \geq 11$.

6.1 Structural properties of G

Unlike injective coloring where vertices incident to the same triangle need different colors, in exact square coloring, two vertices see each if and only if the distance between them is exactly 2.

Lemma 30. *The minimum degree of G is at least 2.*

Proof. Suppose that v is a 1-vertex in G . We now color $G - \{v\}$ by minimality and then we can color v , since v sees at most three vertices and we have 10 colors. \square

Similarly as in the previous section, a 2-vertex is not reducible by itself, but it provides a nice counting argument to prove that “smaller” objects must be further away.

Lemma 31. *If a 4^- -vertex u is adjacent with a 3^- -vertex v , then $d^{\#2}(u) \geq 10$. Moreover, if v is a 2-vertex, then every vertex in $N^{\#2}(u)$ is a 4-vertex.*

Proof. Suppose to the contrary and let u be a 4^- -vertex with $d^{\#2}(u) < 10$ adjacent with a 3^- -vertex v . Note that if $d(u) \leq 3$, then the condition $d^{\#2}(u) < 10$ is always satisfied. Thus, we have $d^{\#2}(v) < 10$. Now we color $G - \{uv\}$ by minimality and uncolor the vertices u and v . Next, observe that since $d^{\#2}(u) < 10$ and $d^{\#2}(v) < 10$, we have that $|L(u)| \geq 1$ and $|L(v)| \geq 1$. We can thus finish the coloring by first coloring u and then v . Assume now that v is a 2-vertex. From above we have that u must be a 4-vertex adjacent with three other 4-vertices. Thus, we have that $d^{\#2}(u) = 10$. Suppose that there exists a 3^- -vertex $w \in N^{\#2}(u)$. In that case we color $G - uv$ by minimality and uncolor the vertices u , v , and w . Since $w \in N^{\#2}(u)$, $d(v) = 2$, and $d(w) \leq 3$, we have that the remaining list of colors for these vertices have size: $|L(u)| \geq 1$, $|L(v)| \geq 4$, and $|L(w)| \geq 2$. We can then finish by coloring u , w , and v in this order. \square

As a consequence of Lemma 31, we obtain the configurations in Lemma 32 directly.

Lemma 32. *Graph G cannot contain the following configurations:*

- (i) *Two adjacent 3^- -vertices.*
- (ii) *A 4-vertex adjacent with a 2-vertex and a 3^- -vertex.*
- (iii) *A 4-vertex adjacent with three 3-vertices.*
- (iv) *A 3^- -vertex incident to a 3-cycle.*
- (v) *A 3^- -vertex at distance 1 from a 3-cycle.*
- (vi) *A 2-vertex incident to a 4-cycle.*
- (vii) *A 3-vertex incident to two adjacent 4-cycles.*

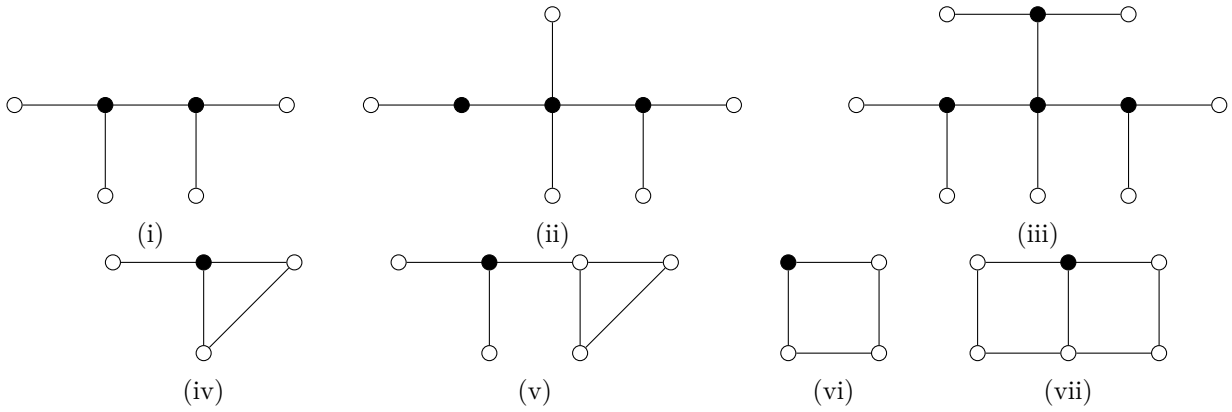

Figure 34: Reducible configurations in Lemma 32.

We finish the study of G structural properties by looking at small cycles.

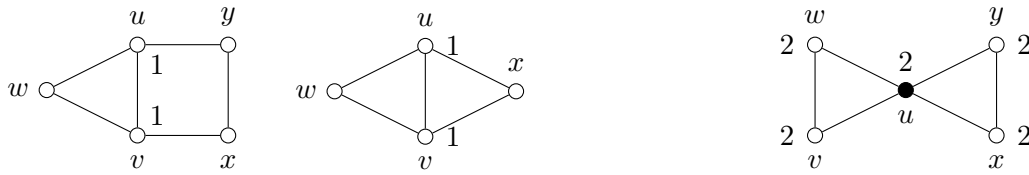

Figure 35: Reducible configurations in Lemma 33. Figure 36: Reducible configuration in Lemma 34.

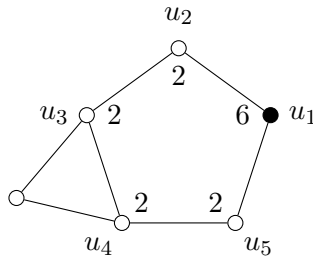

Figure 37: Reducible configuration in Lemma 35.

Lemma 33. *A 3-cycle in G is not adjacent with a 4^- -cycle.*

Proof. Suppose to the contrary and let $C = uvw$ be a 3-cycle in G . Let $C' = uvxy$ be a 4^- -cycle in G . Note that possibly $x = y$, in which case C' is a 3-cycle. We now color $G - uv$ by minimality and uncolor the vertices u and v . Observe that whether $x = y$, or $x \neq y$, we have that $|L(u)| \geq 1$ and $|L(v)| \geq 1$. Therefore, we can finish the coloring by first coloring u and then v . \square

Lemma 34. *A 3-cycle in G is not incident to another 3-cycle.*

Proof. Suppose to the contrary and let $C = uvw$ be a 3-cycle in G . Let $C' = uxy$ be another 3-cycle in G . Note that possibly the vertices v, w, x , and y are all distinct, otherwise we are done by Lemma 33. We now color $G - u$ by minimality and uncolor the vertices v, w, x , and y . Observe that the remaining list of colors for vertices u, v, w, x , and y have size: $|L(u)| \geq 2$, $|L(v)| \geq 2$, $|L(w)| \geq 2$, $|L(x)| \geq 2$, and $|L(y)| \geq 2$. Since each of the vertices v, w, x , and y sees at most two others, we can color these vertices by the 2-choosability of even cycles and finally coloring u with one of the two remaining colors. \square

Lemma 35. *A 5-cycle in G incident to a 2-vertex is not adjacent to a 3-cycle.*

Proof. Suppose to the contrary and let $C = u_1u_2u_3u_4u_5$ be a 5-cycle with $d(u_1) = 2$. Due to Lemma 32(iv, v) we have that the adjacent 3-cycle must be incident with the edge u_3u_4 . We now color

$G - u_3u_4$ by minimality and uncolor all the vertices of C . Note that the remaining list of colors for these vertices have size: $|L(u_1)| \geq 6$, $|L(u_2)| \geq 2$, $|L(u_3)| \geq 2$, $|L(u_4)| \geq 2$, and $|L(u_5)| \geq 2$. Observe that u_2 does not see u_3 , u_3 does not see u_4 and u_4 does not see u_5 . Thus, we can color the vertices u_2 , u_3 , u_4 , and u_5 by the 2-choosability of paths and finally coloring u_1 with one of the four remaining colors. \square

6.2 Discharging procedure

To get a contradiction with Equation (1) we apply the following rules in the discharging procedure:

R0 Every 5^+ -face f gives 1 to each incident 2-vertex.

R1 Every 5^+ -face f gives $\frac{1}{3}$ to each incident 3-vertex that is not incident to a 4-face.

R2 Every 5^+ -face f gives $\frac{1}{2}$ to each incident 3-vertex that is incident to a 4-face.

R3 Every 5^+ -face f gives $\frac{1}{3}$ to each adjacent 3-face.

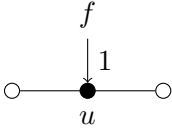

Figure 38: **R0**.

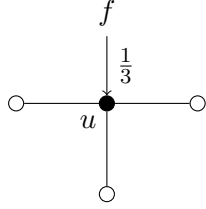

Figure 39: **R1**.

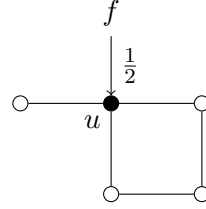

Figure 40: **R2**.

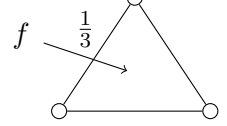

Figure 41: **R3**.

Now we can proceed by proving Theorem 6 using the discharging procedure together with the structural properties of G proven in Section 6.1 and the discharging rules stated above.

Proof of Theorem 6. Let G be a minimal counterexample to the theorem and let $\mu(u)$ be the initial charge assignment for the vertices and faces of G with the charge $\mu(u) = d(u) - 4$ for each vertex $u \in V(G)$, and $\mu(f) = d(f) - 4$ for each face $f \in F(G)$. By Equation (1), we have that the total sum of the charges is negative.

Let μ^* be the assigned charges after the discharging procedure. In what follows, we will prove that:

$$\forall x \in V(G) \cup F(G), \mu^*(x) \geq 0.$$

Let u be a vertex in $V(G)$. Vertex u has degree at least 2 by Lemma 30. Recall that $\Delta(G) = 4$ and $\mu(u) = d(u) - 4$.

Case 1: If $d(u) = 4$, then u does not give any charge. So,

$$\mu^*(u) = \mu(u) = d(u) - 4 = 0.$$

Case 2: If $d(u) = 3$, then $\mu(u) = d(u) - 4 = -1$ and due to Lemma 32(iv, vii) we have the following two cases:

- If u is not incident to any 4-face, then it receives $\frac{1}{3}$ from each of the three incident 5^+ -faces by **R1**. So,

$$\mu^*(u) = -1 + 3 \cdot \frac{1}{3} = 0.$$

- If u is incident to a 4-face, then it has exactly one incident 4-face and two incident 5^+ -faces due to Lemma 32(vii). Therefore, u receives $\frac{1}{2}$ from each incident 5^+ -face by **R2**. So,

$$\mu^*(u) = -1 + 2 \cdot \frac{1}{2} = 0.$$

Case 3: If $d(u) = 2$, then $\mu(u) = d(u) - 4 = -2$ and due to Lemma 32(iv, vi) u is incident with two 5^+ -faces. Thus, u receives 1 from each incident face by **R0**. So,

$$\mu^*(u) = -2 + 2 \cdot 1 = 0.$$

Let f be a face in $F(G)$. Recall that $\mu(f) = d(f) - 4$. Let i_0, i_1, i_2 , and i_3 be respectively the number of times f gives charge by **R0**, **R1**, **R2**, and **R3**. We distinguish the following cases.

Case 1: $d(f) \geq 6$

We claim that f never gives more than $\frac{1}{3}d(f)$ by **R0-R3**. Indeed, we argue that f sends at most $\frac{1}{3}$ per incident edge. Observe that we can also view **R0**, **R1**, and **R2** as f giving charge along incident edges of f as shown in Figure 42. Consider now an edge uv incident to f . If f gives $\frac{1}{4}$ by **R0**, then it cannot give any additional charge along uv since a 2-vertex is at distance at least 2 from any 3-face by Lemma 32(iv) and is also at distance at least 4 from any other 3^- -vertex by Lemma 31. If f gives either $\frac{1}{6}$ (respectively $\frac{1}{4}$) along uv by **R1** (respectively **R2**), then f cannot give any additional charge along uv . Indeed, as argued above, f cannot give charge along uv by **R0** and also f cannot give additional charge along uv by **R1-R3** due to Lemma 32(i, iv, v). Finally, if f gives $\frac{1}{3}$ along uv by **R3**, then, due to Lemma 32(iv, v) and Lemma 33, f cannot give any additional charge along uv . To conclude, we have

$$\mu^*(u) \geq \mu(u) - \frac{1}{3}d(f) = d(f) - 4 - \frac{1}{3}d(f) = \frac{2}{3}d(f) - 4 \geq 0$$

since $d(f) \geq 6$.

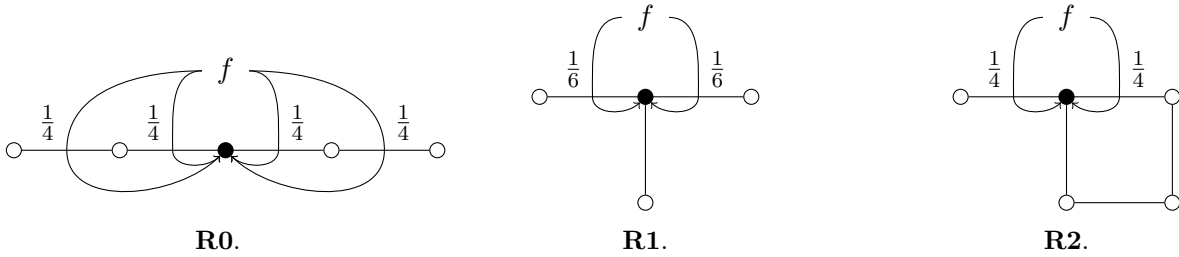

Figure 42

Case 2: $d(f) = 5$

Recall that $\mu(f) = d(f) - 4 = 1$. Observe that we have the following inequalities regarding the values i_0, i_1, i_2 , and i_3 :

- $i_0 \leq 1$, due to Lemma 32(i, ii).
- $i_1 + i_2 + i_3 \leq 2$. Indeed, by Lemma 32(i) we have that f is incident to at most two 3-vertices. Moreover, by Lemma 34 we have that f is adjacent with at most two 3-faces. Next, if f is incident to exactly one 3-vertex, then by Lemma 32(iv, v) we have that f is adjacent with at most one 3-face. Finally, if f is incident to exactly two 3-vertices, then again by Lemma 32(iv, v) we have that f is not adjacent to any 3-faces.

Recall that f gives $i_0 + \frac{1}{3}i_1 + \frac{1}{2}i_2 + \frac{1}{3}i_3$ by **R0**, **R1**, **R2**, and **R3**.

If $i_0 = 1$, then, by Lemma 32(i, ii, iv, v) and Lemma 35, we have that $i_1 + i_2 + i_3 = 0$. So,

$$\mu^*(f) \geq 1 - 1 = 0.$$

If $i_0 = 0$, then since $i_1 + i_2 + i_3 \leq 2$,

$$\begin{aligned}\mu^*(f) &\geq \mu(f) - \frac{1}{3}i_1 - \frac{1}{2}i_2 - \frac{1}{3}i_3 \\ &\geq 1 - \frac{1}{2}(i_1 + i_2 + i_3) \\ &\geq 1 - 2 \cdot \frac{1}{2} = 0.\end{aligned}$$

Case 3: $d(f) = 4$

Recall that $\mu(f) = d(f) - 4 = 0$. Since f does not give any charge, we have

$$\mu^*(f) = \mu(f) = 0.$$

Case 4: $d(f) = 3$

Recall that $\mu(f) = d(f) - 4 = -1$. Due to Lemma 33 we have that f receives $\frac{1}{3}$ from each adjacent face by **R3**. So,

$$\mu^*(f) = -1 + 3 \cdot \frac{1}{3} = 0.$$

To conclude, we started with a charge assignment with a negative total sum, but after the discharging procedure, which preserved that sum, we end up with a non-negative one, which is a contradiction. In other words, there exists no counter-example to Theorem 6. \square

7 Conclusion

Almost all results in 2-distance (and also injective) coloring of planar graphs (of high girth) are proved using the discharging method. Many of these proofs use planarity only to bound the number of edges with respect to the number of vertices in any induced subgraph, which can also be achieved by bounding the maximum average degree. The *maximum average degree*, denoted by $\text{mad}(G)$, is taken as the maximum over all subgraphs H of G of average degree of H . Note that for planar graphs of girth g we have the inequality $\text{mad}(G) < \frac{2g}{g-2}$. This allows one to easily translate the condition on maximum average degree to the condition on girth in the case of planar graphs. Thus, we can ask if our results can be extended to non-planar graphs G which have maximum average degree $\text{mad}(G) < \frac{2 \cdot 4}{4-2} = 4$.

To answer this question we need to look at finite projective planes. For a prime power q , a projective plane $PG(2, q)$, of order q , consists of $q^2 + q + 1$ points and $q^2 + q + 1$ lines such that any two points belong to exactly one line and any two lines intersect in exactly one point. Moreover, each point belongs to exactly $q + 1$ lines and each line contains exactly $q + 1$ points. Let $IG(q)$ be the incidence graph of a projective plane $PG(2, q)$ (i.e., a bipartite graph whose vertices are the points and lines of $PG(2, q)$ and an edge $uv \in E(IG(q))$ if and only if a line u contains a point v). In [23], Hahn *et al.* proved the following result.

Theorem 36 (Hahn *et al.* [23]). *Let G be a connected graph of maximum degree $\Delta \geq 3$. Then, $\chi^i(G) = \Delta^2 - \Delta + 1$ if and only if there exists a projective plane of order $q = \Delta - 1$ and G is isomorphic to $IG(q)$.*

A similar result, but for the exact square coloring was shown by Foucaud *et al.* in [22].

Theorem 37 (Foucaud *et al.* [22]). *Let G be a connected graph of maximum degree $\Delta \geq 3$. Then, $\chi^{\#2}(G) = \Delta^2 - \Delta + 1$ if and only if there exists a projective plane of order $q = \Delta - 1$ and G is isomorphic to $IG(q)$.*

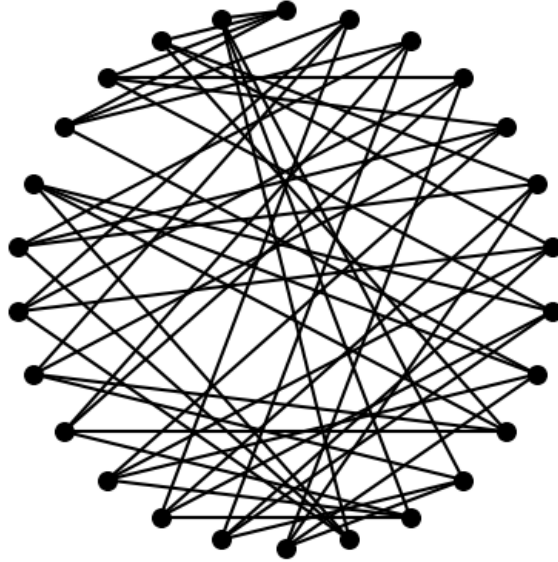

Figure 43: A 4-regular bipartite graph $IG(3)$.

None of our results on injective and exact square coloring can be extended to non-planar graphs G with maximum average degree $\text{mad}(G) < 4$ even in their non-list version. Indeed, note that for the graph $G = IG(3)$ as seen in Figure 43 we have $\chi^i(G) = \chi^{\#2}(G) = 13$ by Theorems 36 and 37. Moreover, removing any vertex from G yields a graph G' with $\text{mad}(G') < 4$ and $\chi^i(G') = \chi^{\#2}(G') = 12$, which still proves that our results are “optimal” in the sense that planarity is needed not only for sparseness. It is easy to see that $\chi_\ell^{\#2}(G) \leq \chi_\ell^i(G) \leq 12$ for every graph G with $\Delta(G) = 4$ and $\text{mad}(G) < 4$ and this bound is tight for the graph G' as explained above.

Theorem 38. *For every graph G with $\Delta(G) = 4$ and $\text{mad}(G) < 4$, $\chi_\ell^i(G) \leq 12$.*

Indeed, if a counter-example G to Theorem 38 exists, then it would have minimum degree 4 (the proof is similar to Lemma 13), which is a contradiction since G would be a 4-regular graph but $\text{mad}(G) < 4$.

For 2-distance coloring, our result is also not extendable to graphs with $\text{mad}(G) < 4$ due to the graph in Figure 44 for which $\chi^2(G) = 13$. In 2016, Cranston and Rabern [14] showed the following result.

Theorem 39 (Cranston and Rabern [14]). *If G is a connected graph with maximum degree $\Delta \geq 3$ and G is not the Peterson graph, the Hoffman-Singleton graph, or a Moore graph with $\Delta = 57$, then $\chi_\ell^2(G) \leq \Delta^2 - 1$.*

Thus, when $\Delta(G) = 4$, we immediately get that $\chi_\ell^2(G) \leq 15$. We believe that the following conjecture is true.

Conjecture 40. *For every graph G with $\Delta(G) = 4$ and $\text{mad}(G) < 4$, $\chi^2(G) \leq 13$.*

We are also interested in planar graphs with girth 4. Due to constructions in [35] and [43] we have some lower bounds for the 2-distance coloring of planar graphs with girth 4. We believe these lower bounds to be tight and thus we conjecture the following.

Conjecture 41. *For every planar graph G with girth at least 4 and maximum degree Δ , $\chi^2(G) \leq \Delta + 3$ for $3 \leq \Delta \leq 5$ and $\chi^2(G) \leq \lfloor \frac{3}{2}\Delta \rfloor$ for $\Delta \geq 6$.*

Similarly, due to constructions in [38], we conjecture the following for injective and exact square coloring which is the same in the case of planar graphs with girth 4.

Conjecture 42. *For every planar graph G with girth at least 4 and maximum degree Δ , $\chi^i(G) \leq 4$ for $\Delta = 3$, $\chi^i(G) = \chi^{\#2}(G) \leq \Delta + 2$ for $4 \leq \Delta \leq 5$ and $\chi^i(G) = \chi^{\#2}(G) \leq \lfloor \frac{3}{2}\Delta \rfloor$ for $\Delta \geq 6$.*

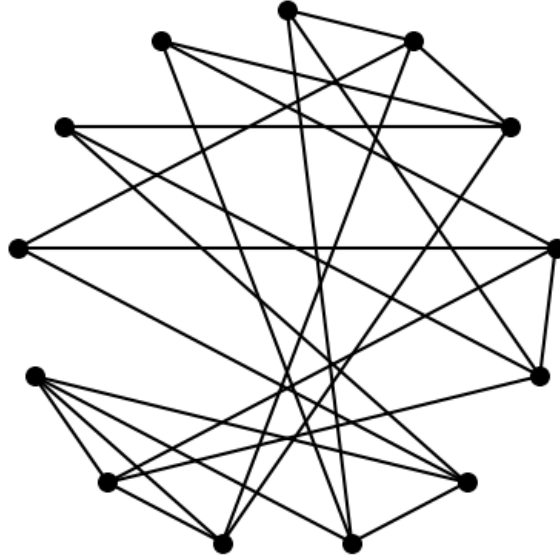

Figure 44: A graph G on 13 vertices with $\Delta(G) = 4$, $\text{mad}(G) < 4$, and diameter 2.

Finally, unlike in the injective coloring, in the exact square coloring we are only concerned by conflicts between vertices at distance exactly 2, hence the presence of triangles does not create any conflicts. Thus, we believe that a similar conjecture holds for exact square coloring.

Conjecture 43. *For every planar graph G with maximum degree Δ , $\chi^{\#2}(G) = \lfloor \frac{3}{2}\Delta \rfloor$.*

Acknowledgements

Both authors were supported by the research grant PHC PROTEUS 2020, project EColoGra N° 44236RL. The first author was also supported by the INS2I project ACDG. The second author acknowledges support by the Young Researchers Grant of the Slovenian Research Agency and the partial support by the program P1-0383 and the project J1-3002.

References

- [1] O. V. Borodin and A. O. Ivanova. List injective colorings of planar graphs. *Discrete Mathematics*, 311:154–165, 2011.
- [2] O. V. Borodin and A. O. Ivanova. List 2-facial 5-colorability of plane graphs with girth at least 12. *Discrete Mathematics*, 312:306–314, 2012.
- [3] N. Bousquet, L. de Meyer, Q. Deschamps, and T. Pierron. Square coloring planar graphs with automatic discharging. arXiv:2204.05791, 2022.
- [4] N. Bousquet, Q. Deschamps, L. de Meyer, and T. Pierron. Improved square coloring of planar graphs. arXiv:2112.12512, 2021.
- [5] N. Bousquet, L. Esperet, A. Harutyunyan, and R. de Joannis de Verclos. Exact distance colouring in trees. *Combinatorics, Probability and Computing*, 28(2):177–186, 2019.
- [6] B. Brimkov, J. Edmond, R. Lazar, B. Lidický, K. Messerschmidt, and S. Walker. Injective choosability of subcubic planar graphs with girth 6. *Discrete Mathematics*, 340:2538–2549, 2017.
- [7] Y. Bu, D. Chen, A. Raspaud, and W. Wang. Injective coloring of planar graphs. *Discrete Applied Mathematics*, 157:663–672, 2009.

- [8] Y. Bu and C. Huang. List injective coloring of a class of planar graphs without short cycles. *Discrete Mathematics, Algorithms and Applications*, 10, 2018.
- [9] Y. Bu and K. Lu. Injective coloring of planar graphs with girth 7. *Discrete Mathematics, Algorithms and Applications*, 4, 2012.
- [10] Y. Bu and K. Lu. List injective coloring of planar graphs with girth 5, 6, 8. *Discrete Applied Mathematics*, 161:1367–1377, 2013.
- [11] Y. Bu, K. Lu, and S. Yang. Two smaller upper bounds of list injective chromatic number. *Journal of Combinatorial Optimization*, 29:373–388, 2015.
- [12] M. Chen, G. Hahn, A. Raspaud, and W. Wang. Some results on the injective chromatic number of graphs. *Journal of Combinatorial Optimization*, 24:299–318, 2012.
- [13] M. Chen, L. Miao, and S. Zhou. 2-distance coloring of planar graphs with maximum degree 5. *Discrete Mathematics*, 345(4):112766, 2022.
- [14] D. Cranston and L. Rabern. Painting squares in $\Delta^2 - 1$ shades. *The Electronic Journal of Combinatorics*, 23(2):2–50, 2016.
- [15] D. W. Cranston, S. J. Kim, and G. Yu. Injective colorings of sparse graphs. *Discrete Mathematics*, 310:2965–2973, 2010.
- [16] D. W. Cranston, S. J. Kim, and G. Yu. Injective colorings of graphs with low average degree. *Algorithmica*, 60:553–568, 2011.
- [17] W. Dong and W. Lin. Injective coloring of planar graphs with girth 6. *Discrete Mathematics*, 313:1302–1311, 2013.
- [18] W. Dong and W. Lin. Injective coloring of plane graphs with girth 5. *Discrete Mathematics*, 315-316:120–127, 2014.
- [19] A. Doyon, G. Hahn, and A. Raspaud. Some bounds on the injective chromatic number of graphs. *Discrete Mathematics*, 310:585–590, 2010.
- [20] T. Feder, P. Hell, and C. Subi. Distance-two colourings of barnette graphs. *European Journal of Combinatorics*, 91:103210, 2021.
- [21] F. Foucaud, H. Hocquard, S. Mishra, N. Narayanan, R. Naserasr, É. Sopena, and P. Valicov. Exact square coloring of subcubic planar graphs. *Discrete Applied Mathematics*, 293:74–89, 2021.
- [22] F. Foucaud, S. Mishra, N. Narayanan, R. Naserasr, and P. Valicov. Cliques in exact distance powers of graphs of given maximum degree. *Procedia Computer Science*, 195:427–436, 2021. Proceedings of the XI Latin and American Algorithms, Graphs and Optimization Symposium.
- [23] G. Hahn, J. Kratochvíl, J. Širáň, and D. Sotteau. On the injective chromatic number of graphs. *Discrete Mathematics*, 256:179–192, 2002.
- [24] P. Hall. On Representatives of Subsets. *Journal of the London Mathematical Society*, s1–10(1):26–30, 1935.
- [25] S. G. Hartke, S. Jahanbekam, and B. Thomas. The chromatic number of the square of subcubic planar graphs. arXiv:1604.06504, 2018.
- [26] F. Havet. Choosability of the square of planar subcubic graphs with large girth. *Discrete Mathematics*, 309:3353–3563, 2009.
- [27] F. Havet, J. van den Heuvel, C. McDiarmid, and B. Reed. List colouring squares of planar graphs. arXiv:0807.3233, 2017.
- [28] J. van den Heuvel, H. A. Kierstead, and D. A. Quiroz. Chromatic numbers of exact distance graphs. *Journal of Combinatorial Theory, Series B*, 134:143–163, 2018.

- [29] F. Kramer and H. Kramer. Ein Färbungsproblem der Knotenpunkte eines Graphen bezüglich der Distanz p . *Revue Roumaine de Mathématiques Pures et Appliquées*, 14(2):1031–1038, 1969.
- [30] F. Kramer and H. Kramer. Un problème de coloration des sommets d'un graphe. *Comptes Rendus Mathématique Académie des Sciences, Paris*, 268:46–48, 1969.
- [31] H. La. 2-distance list $(\Delta + 3)$ -coloring of sparse graphs. arXiv:2105.01684, 2021.
- [32] H. La and M. Montassier. 2-distance 4-coloring of planar subcubic graphs with girth at least 21. arXiv:2106.03587, 2021.
- [33] H. La and M. Montassier. 2-distance $(\Delta + 1)$ -coloring of sparse graphs using the potential method. arXiv:2103.11687, 2021.
- [34] H. La and M. Montassier. 2-distance $(\Delta + 2)$ -coloring of sparse graphs. arXiv:2109.11927, 2021.
- [35] H. La and M. Montassier. 2-distance list $(\Delta + 2)$ -coloring of planar graphs with girth at least 10. arXiv:2109.14499, 2021.
- [36] K.-W. Lih, W.-F. Wang, and X. Zhu. Coloring the square of a K_4 -minor free graph. *Discrete Mathematics*, 269(1):303 – 309, 2003.
- [37] B. Lužar and R. Škrekovski. Counterexamples to a conjecture on injective colorings. *Ars Mathematica Contemporanea*, 8:291–295, 2015.
- [38] B. Lužar, R. Škrekovski, and M. Tancer. Injective colorings of planar graphs with few colors. *Discrete Mathematics*, 309:5636–5649, 2009.
- [39] J. Nešetřil and P. O. de Mendez. *Sparsity — Graphs, Structures, and Algorithms*, volume 28. Springer-Verlag, Berlin, Heidelberg, 2012.
- [40] D. A. Quiroz. Colouring exact distance graphs of chordal graphs. *Discrete Mathematics*, 343(5):111769, 2020.
- [41] S. K. Simić. Graph equations for line graphs and n -distance graphs. *Publications de l'Institut de Mathématiques de Beograd*, 33(47):203–216, 1983.
- [42] C. Thomassen. The square of a planar cubic graph is 7-colorable. *Journal of Combinatorial Theory, Series B*, 128:192–218, 2018.
- [43] G. Wegner. Graphs with given diameter and a coloring problem. *Technical report, University of Dortmund*, 1977.