

INVARIANCE OF KNOT LATTICE HOMOLOGY AND HOMOTOPY

SEPPO NIEMI-COLVIN

ABSTRACT. Links of singularity and generalized algebraic links are ways of constructing three-manifolds and smooth links inside them from potentially singular complex algebraic surfaces and complex curves inside them. We prove that knot lattice homology is an invariant of the smooth knot type of a generalized algebraic knot in a rational homology sphere. In that case, knot lattice homology can be realized as the cellular homology of a doubly-filtered homotopy type, which is itself invariant. Along the way, we show that the topological link type of a generalized algebraic link determines the topology of the minimal plumbing resolution for the nested singularity type used to create it.

CONTENTS

1. Introduction	1
1.1. Avenues for Future Work	4
Acknowledgements	5
2. Links of Singularity and Generalized Algebraic Links	5
2.1. Types of Links of Singularity and Their Resolutions	5
2.2. Checking Blow-Ups Suffice	14
3. Construction and Context for Knot Lattice Homology	17
3.1. Motivations for the Equivalence Type	17
3.2. A Cubical Construction of Lattice Homology	21
3.3. Knot Lattice Homology: A Second Filtration	27
4. Contraction Maps	33
4.1. Contractions: Definition and Existence	33
4.2. Creating Topological Homotopies	41
4.3. Constructing Tuned Contractions	47
5. The (Chain) Homotopy Equivalences	50
5.1. General Strategy	50
5.2. Blow-Up of Edges Between Weighted Vertices	55
References	58

1. INTRODUCTION

One of the first questions a topologist usually asks of a calculation is if it is invariant, especially if it relies on a presentation of the underlying topological structure, such as a three-manifold or knot. While there are ways to create invariants out of

Date: April 2022.

non-invariant calculations, such as minimizing over all presentations, knowing that a calculation is invariant provides hope that the calculations are getting at genuine topological information about the structure, instead of simply being artifacts of the presentation.

We focus on the class of three-manifolds that are links of normal complex surface singularities and a class of knots that generalizes algebraic knots to this setting. The calculations of concern for this article are knot lattice homology, which is built off of the foundations of lattice homology, and knot lattice homotopy which realizes knot lattice homology as the cellular homology of a doubly-filtered homotopy type. We also include some maps as a part of the package we would like preserved, based on the context of Heegaard Floer homology and knot Floer homology. The desired invariance is summarized in the following theorems:

Theorem 1.1. *Let (Y, K) be a generalized algebraic knot in a rational homology sphere with a Spin^c structure \mathfrak{t} . The chain homotopy equivalence type of*

$$(\text{CFK}(G_{v_0}, \mathfrak{t}), J_{v_0}, J)$$

depends only on (Y, K) and \mathfrak{t} and not the particular graph with unweighted vertex G_{v_0} used to represent it.

Theorem 1.2. *Let (Y, K) be a generalized algebraic knot in a rational homology sphere with a Spin^c structure \mathfrak{t} . The doubly filtered homotopy type of*

$$(\text{CFK}^{\natural}(G_{v_0}, \mathfrak{t}), J_{v_0}^{\natural}, J^{\natural})$$

depends only on (Y, K) and \mathfrak{t} and not the particular graph with unweighted vertex G_{v_0} used to represent it.

A paper claiming the first result without the maps J_{v_0} and J has appeared independently on the arXiv in a paper by Matthew Jackson [10] (see Remark 4.9).

Despite being able to recover the algebraic invariant from the homotopy theoretic one, this paper tackles both the algebraic invariants and the homotopy invariants for several reasons. First, while geometric intuition aids in the discussion, dealing with the algebraic invariants first without worry for continuity then using these maps as a guide for constructing the continuous homotopies is easier. Second, this assuages potential worries that the homotopy theoretic argument only provides a quasi-isomorphism of chain complexes rather than a chain homotopy equivalence due to the knot lattice complex being associated to cellular rather than singular homology. Third, the chain homotopies provided may be useful when working with the algebraic invariant, and having them presented separately rather than buried as induced by specific continuous maps may be useful. We will use the \natural symbol to signify that we are dealing with the topological realization of an algebraic invariant.

András Némethi defined lattice homology for links of normal complex surface singularities [16] based on attempts by Némethi, Ozsváth, and Szabó to compute Heegaard Floer homology when the three-manifold bounds a negative definite tree-like plumbing of spheres [15, 23]. Lattice homology was conjectured to be the same as Heegaard Floer homology for rational homology spheres [16], and after it was shown to coincide in some particular cases [15, 21], Ian Zemke proved their equivalence for rational homology spheres [27]. The lattice homology of rational homology spheres also shares some formal properties with Heegaard Floer homology such as: an exact triangle ([24] for Heegaard Floer homology, [8, 17] for lattice homology) and the existence of an involutive structure ([9] for Heegaard Floer

homology, [4] for lattice homology). Lattice homology was particularly useful for the creation of an algorithm for computing the Heegaard Floer homology of a Brieskorn sphere $\Sigma(p, q, r)$ purely in terms of p, q , and r [3].

Ozsváth, Stipsicz, and Szabó developed knot lattice homology as a way to make use of the surgery formula from knot Floer homology in the lattice homology setting [21]. This construction parallels a lot of the structures in knot Floer homology, particularly in that it can be viewed as the addition of a filtration to the lattice complex for the ambient three-manifold. Ozsváth, Stipsicz, and Szabó showed that when the ambient three-manifold is a lattice homology L-space, knot lattice homology and knot Floer homology agree [22]. Alfieri used the Alexander filtration from knot lattice homology to deform lattice homology, and showed that this deformation corresponded to the analogous deformation of Heegaard Floer homology for graphs with at most one bad vertex (i.e. a vertex whose degree is greater than the negative of its weight) [1]. Alfieri used this to provide a method for computing the epsilon invariant [1]. Due to Zemke's proof that lattice homology agrees with Heegaard Floer homology for rational homology spheres and the surgery formula connecting knot lattice homology and lattice homology [27], we would hope that knot Floer homology and knot lattice homology agree in general. In particular, we would then need knot lattice homology to be an invariant for the knot, as is the content of Theorem 1.1.

Furthermore, finding homotopy-theoretic versions of Floer-theoretic invariants is an active area of research, including work by Kronheimer, Manolescu, and Sarkar for Seiberg-Witten Floer theory [13, 11] and knot Floer homology [14]. Theorem 1.2 fits in with this wider research program. The work of Manolescu and Sarkar [14] in on creating a homotopy theoretic version of knot Floer homology expresses the action of UV in knot Floer homology differently than we do for knot lattice homology, so the two theories are not at this point immediately comparable.

Section 2 covers the relevant singularity theory with an eye towards low-dimensional topology. In particular Subsection 2.1 goes over links of singularity in various contexts, culminating in introducing generalized algebraic links, which combine aspects of links of normal complex surface singularities and algebraic links in S^3 . In each of these contexts, we define what the link of a singularity means, as well as how to produce a plumbing diagram by resolving the singularity in question. We introduce the moves of blow-ups and blow-downs needed to get between plumbing resolutions of the same singularity, and that there is a unique minimal resolution with respect to these moves in each context. This builds up to Subsection 2.2, where we show that we only need to check invariance under blow-ups and blow-downs of the graph representing the generalized algebraic knot. This leads to the following theorem of potentially independent interest, a variation of which was independently proved by Jackson in [10].

Theorem 1.3. *The link type of a generalized algebraic link (Y, L) determines the topology of the minimal plumbing resolution for the singularity $(S, C, \{p_1, \dots, p_n\})$ used to create it.*

In Section 3, we cover the constructions for lattice homology (in Subsection 3.2) and knot lattice homology (in Subsection 3.3). Lattice homology provides a cube decomposition of Euclidean space with a height function on it, and we use this cube decomposition to construct our chain complex over $\mathbb{Z}[U]$ as well as a filtered topological space. Knot lattice homology adds a second height function to the chain

complex and a second filtration to the topological space. Both lattice homology and knot lattice homology come equipped with involutive maps, respectively denoted as J and J_{v_0} , which can be realized as continuous maps.

However, before introducing either lattice homology or knot lattice homology, we review the relevant Floer theory in Subsection 3.1 that contextualizes the construction of knot lattice homology and the involutive maps J_{v_0} and J . The most important pieces of information from this section are the definitions of a complete knot package for a knot (Y, K) and a complete homotopy package for a knot (Y, K) , which respectively define the equivalence types for knot lattice homology and knot lattice homotopy in this setting.

In order to prove invariance, we explore in Section 4 a generalization of a construction found in the arXiv version of [21] which provides a way to collapse the knot lattice complex akin to collapsing Euclidean space to a codimension-one subspace. These chain maps are called contractions and are by design chain homotopic to the identity. In Subsection 4.1, we capture the essential features of this construction with added flexibility to ensure that there will always exist contractions not only for lattice homology but for knot lattice homology as well. We also do not require the vertex we are contracting with respect to be “good”, i.e. have degree less than or equal to the negative of the weight. Next, Subsection 4.2 provides a way to realize any contraction as a continuous map on the knot lattice space. These provide explicit examples of the homotopy mentioned by Némethi in the proof of invariance for lattice cohomology [12]. Subsection 4.3 then provides tools to pin down what form these contractions can take given more information about the graph used to represent the knot.

In Section 5, we construct the specific chain homotopy equivalences and chain homotopies needed to show invariance under blow-ups and blow-downs for knot lattice homology as well as the corresponding continuous maps for knot lattice homotopy. Subsection 5.1 lays out the general strategy, which rests primarily on using the existence of contractions on the knot lattice space to handle most of the dependence on the specific knot. We then run through the specific example of blowing up the unweighted vertex to illustrate how this strategy unfolds in a case that was already known on the chain level. The subsection ends discussing how this also allows us to lift the proof of a case given by Ozsváth, Stipsicz, and Szabó to more cases [21]. Subsection 5.2 then provides details regarding the specific case of blowing up an edge connecting weighted vertices and finishes the proofs of Theorems 1.1 and 1.2.

1.1. Avenues for Future Work. While a lack of an invariance proof has not prevented researchers such as Ozsváth, Szabó, Stipsicz, and Alfieri from working with knot lattice homology [22, 1], a proof of invariance provides justification for further work. For example, Zemke’s proof that lattice homology and Heegaard Floer homology are quasi-isomorphic provides further reason to suspect that knot lattice homology computes knot Floer homology [27], and as an invariant knot lattice homology is more likely to agree with knot Floer homology for knots in rational homology spheres. One avenue to prove such a result would be to construct an iterable surgery formula that produces the complex for the dual knot along with the flip map and show that this formula holds for both knot lattice homology and knot Floer homology.

Furthermore, even if other proofs of the equivalence of knot lattice homology and knot Floer homology are possible, such a formula would be useful in computations. Since lattice homology provided a useful tool in finding algorithms for computing the Heegaard Floer homology of Brieskorn spheres [3], one may suspect that knot lattice homology could provide a useful tool for the computation of knot Floer homology and related invariants for the regular and singular fibers of Brieskorn spheres. There may be benefits to performing these calculations in homotopy theoretic terms.

Finally, Némethi defined lattice cohomology in the context of general links of normal complex surface singularities not just rational homology spheres and framed the behavior of lattice homology in the terms of singularity theory [16]. Extending the proof of knot lattice homology's invariance to this larger setting and connecting it with the properties of nested singularities would be interesting.

ACKNOWLEDGEMENTS

I would like to acknowledge András Stipsicz for his correspondence including verifying that knot lattice homology was not yet known to be invariant when I started. Furthermore, I would like to thank Barbara Fantechi and Twitter user @d_m_d_m_d_d for helping me understand what it means for a complex variety to be normal. I would also like to thank Irving Dai and Antonio Alfieri for useful conversations at the Nearly Carbon Neutral Geometric Topology Conference. Finally, I would like to thank my advisor Adam Levine for lots of advice during the editing process. The author was partially supported by NSF grant DMS-1806437.

2. LINKS OF SINGULARITY AND GENERALIZED ALGEBRAIC LINKS

Singularity theory provides important context for the construction of knot lattice homology, in particular, by providing the necessary scope where it is defined, i.e. generalized algebraic knots in rational homology spheres, and the needed presentation of said knots in order to calculate knot lattice homology, i.e. resolutions of nested singularities. Furthermore Subsection 2.2 provides a proof of Theorem 1.3, which is needed to show invariance. Since a number of people approaching knot lattice homology may be doing so from a low-dimensional topology rather than singularity theory background, we will not be assuming much familiarity with algebraic geometry. The theory of singularities can be expressed in either algebraic or analytic terms; the author leans towards algebraic terms out of personal preference.

2.1. Types of Links of Singularity and Their Resolutions. Before defining a link of a singularity in any of the relevant contexts, we will need the following definition.

Definition 2.1. Given a topological space X and a subspace Y , we have that a *regular neighborhood* N of Y is a closed neighborhood of Y in X so that there exists a map $\pi : \partial N \rightarrow X$ where N is homeomorphic to the mapping cylinder of π .

Regular neighborhoods generalize the idea of tubular neighborhoods to the singular setting, and in the case where X is a point, we have that regular neighborhoods are cone-like.

Generalized algebraic knots combine aspects of both links of normal complex surface singularities and algebraic links, and thus we will first cover the relevant ideas in those contexts. In each context, we will cover what the relevant link of

singularity is and what is required of a resolution of a singularity. Relevant to the context of how a generalized algebraic knot is presented for knot lattice homology, we cover how to represent said resolutions using plumbing graphs. In preparation for the proof of invariance, we discuss what moves are allowed on said plumbing graphs and that minimal plumbing resolutions exist in each context.

2.1.1. Links of Normal Complex Surface Singularities. A complex affine variety V is *normal* at a point p if the ring of functions localized at p is integrally closed in its ring of fractions, and such a variety V is *normal* if it is normal at every point. If the complex variety V is normal, it is known that V will be regular and thus smooth off of a subset of complex codimension two [5, p. 255]. Thus for normal complex surfaces V , all singularities of V are isolated. We also get as a result that for all Zariski open sets U and points $p \in U$ any regular function f on $U - \{p\}$ can be extended to all of U [5, p. 255]. Here a *regular function* is a function to \mathbb{C} that can be defined locally as a rational function.

Definition 2.2. Given a complex variety V , viewed as an algebraic subset of \mathbb{C}^n equipped with the euclidean topology, which has an isolated singularity at p , we define its *link* as the boundary of a regular neighborhood around p in V . A *link of multiple singularities* p_1, \dots, p_n is the boundary of a regular neighborhood of a path connecting p_1, \dots, p_n and passing through no other singular points.

A common way to form the link is using a particular embedding of V into affine space and taking the intersection of V with a small enough sphere $S_\epsilon(p)$ around p . Here we care about links of normal complex surface singularities, and the links of these singularities are oriented 3-manifolds. Figure 1b shows a dimensionally reduced picture of a link of a normal complex surface singularity. If V is normal, then the link around any of its points must be connected. This is easier to see in the analytic setting where weakly holomorphic functions on $U - p$ extending to U is taken as the definition of normality [12]; if the link were disconnected one could use different constant terms on each component of $U - p$ to get a non-extendable holomorphic function.

The motivation for the definition of a link of multiple singularities is that if a sphere instead contains multiple isolated singularities p_1, \dots, p_n , and no other topology, then the result is the connected sum of the links of individual p_i . Viewing the sphere as the boundary of a cone-like neighborhood, expanding those neighborhoods until they merge gives the cobordism connecting the disjoint union and the connected sum. Extending the cores of the 1-handles connecting the individual neighborhoods to the singularities provides the path used in constructing the regular neighborhood. This argument also gives why the precise path between the points does not matter; a different choice of path would result in handle slides for the 1-handles and connected sum being applied in a potentially different order. If one would prefer, one can have the link of multiple singularities be the disjoint union of the links of the individual singularities, but it is traditional in low-dimensional topology to restrict to connected manifolds with the operation of choice being connect sum. Furthermore, lattice homology is defined in the context of connect sums of links of singularity, so we chose a definition that includes those in its scope.

Definition 2.3. A *resolution of a singularity* (V, p) is a map $\pi : \tilde{V} \rightarrow V$ which is an isomorphism from $\tilde{V} - \pi^{-1}\{p\}$ to $V - \{p\}$ and where \tilde{V} is a smooth complex affine variety. A *resolution of multiple singularities* $(V, \{p_1, \dots, p_n\})$ is defined similarly

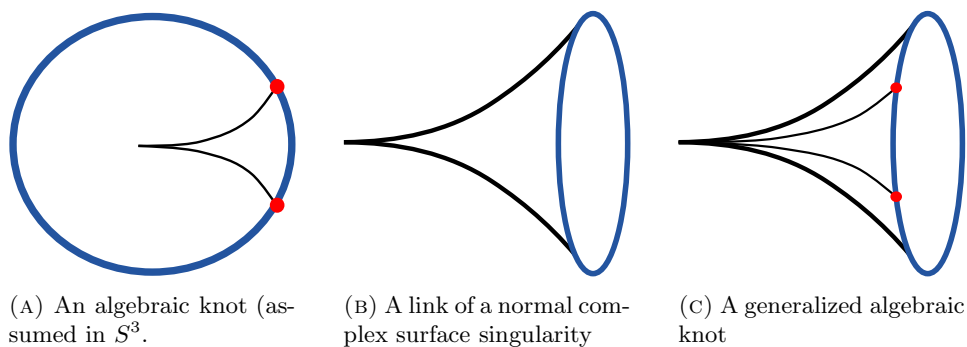

FIGURE 1. Dimensionally reduced figures for an algebraic knot, a link of a normal complex surface singularity, and a generalized algebraic knot.

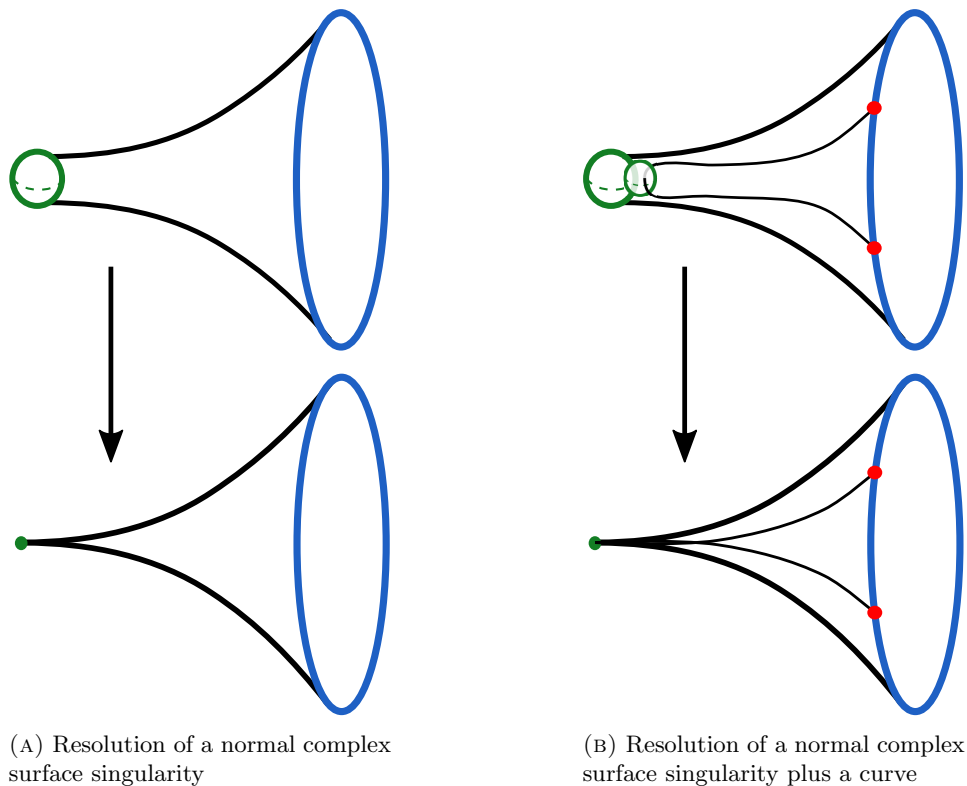

FIGURE 2. A resolution in the three manifold context and for a curve inside it. The extra sphere in Subfigure 2b signifies that further blow-ups may be needed to resolve the curve. Furthermore, the curve pierces the sphere to emphasize that it should be transverse to the sphere, and in fact locally represented as a fiber of the plumbing.

except the map π must only be an isomorphism from $\tilde{V} - \pi^{-1}(\{p_1, \dots, p_n\})$ to $V - \{p_1, \dots, p_n\}$. For each p_i we have that $\pi^{-1}(\{p_i\})$ is an *exceptional fiber* of the resolution

Figure 2a depicts the resolution of a singularity. Any normal surface singularity can be resolved, and in particular an algorithm is given in [12]. Since the process of resolving a singularity does not change its link, we can use the homeomorphism type of the link to understand the singularity type better while still working with a resolution. Furthermore, a surface singularity can be resolved in a way so that the pullback the regular neighborhood of p forms a plumbing.

Definition 2.4. A *plumbing of two disk bundles over surfaces* is the manifold achieved by gluing trivialized neighborhoods of points in such a way so that the base of one becomes identified with the fiber of the other. In particular, the neighborhoods over which one is trivializing the disk bundles must be homeomorphic to disks themselves. A general *plumbing of (disk bundles over) surfaces* is a four-manifold constructed from set of disk bundles over surfaces with the plumbing operation done some number of times between them. The *base surfaces of the plumbing* are the images of the zero sections of the disk bundles used to make the plumbing.

Plumbings can be represented by undirected graphs, where each vertex represents a disk bundle over the surface and edges represent the plumbing operation. Each vertex is decorated with weights specifying the Euler number of the disk bundle and the genus of the base surface with the genus in brackets, though if the base surface is a sphere the genus information is omitted. The base surfaces for the plumbing provide a basis for the second homology of the plumbing. Furthermore the intersection form of a plumbing can be read off of the plumbing graph, where one of the base surfaces S_i has self intersection equal to the Euler number e_i of the corresponding disk bundle, and two different base surfaces S_i and S_j have intersection equal to the number of edges between them.

In the general theory of plumbings, it is possible to allow nonorientable bases (so long as the total space of the disk bundle is oriented) and plumbing operations that swap orientation on both the base and fiber while gluing, resulting in negative intersections of the base surfaces; we will not be considering such plumbings in this article, except briefly in Subsection 2.2. In addition to the above restrictions, a plumbing that comes from a singularity will have negative definite intersection form [7]. Conversely, any plumbing which is negative definite represents the resolution of some singularity [7]. The graphs representing resolutions of links of normal complex surface singularities can potentially have cycles or higher genus bases; however, the link is a rational homology sphere if and only if the plumbing graph is a forest of spheres.

Definition 2.5. Given a point q of a smooth complex surface V so that in local coordinates (x, y) we have that q is the origin, then *the blow-up of V at q* is the complex surface V_q where the chart around q is replaced with

$$\{((x, y), [s : t]) \in \mathbb{C}^2 \times \mathbb{C}\mathbb{P}^1 : xt = ys\}.$$

The projection $\pi : V_q \rightarrow V$ induced by locally projecting onto \mathbb{C}^2 is called the *canonical projection*. The curve $\pi^{-1}(q)$ is called *the exceptional sphere*. The complex surface V is *the blow-down* of V_q at the exceptional sphere.

One can define a blow-up when V is singular at q as well, and this is a part of the process of constructing resolutions, though we will not be needing it in this paper. Algebraically, blowing up a point q replaces q with the set of lines through that point, and assuming that we were already at a resolution, the space of lines is represented by a copy of $\mathbb{C}\mathbb{P}^1$, which will have a normal bundle of Euler number -1 . Smoothly this operation produces a connect sum with $\overline{\mathbb{C}\mathbb{P}^2}$. Given the presence of an embedded sphere with normal bundle of Euler number -1 in V , we can blow down that sphere, i.e. there exists a smooth complex surface \tilde{V} which is the blow-down of V , a process which can be achieved holomorphically [2].

Blowing up a plumbing resolution will give another plumbing resolution with a new vertex e that has weight -1 , representing the exceptional sphere. To understand how blow-ups affect the graph, we will need the idea of the proper and total transform of a curve under a resolution.

Definition 2.6. Given a resolution $\pi : \tilde{V} \rightarrow V$ of a complex surface V at a point q and a complex curve C inside V , the *total transform* of C inside the resolution is $\pi^{-1}(C)$, while the *proper transform* of C inside the resolution is the closure of $\pi^{-1}(C - \{q\})$.

In particular, blowing up provides a resolution of our plumbing, and the base surfaces for this new plumbing resolution will be precisely the proper transforms of the base surfaces of our original plumbing.

The effect of a blow-up on a plumbing graph depends on which point q was blown up. If $q \notin \pi^{-1}(\{p_1, p_2, \dots, p_n\})$, then the blow-up would be represented by the disjoint union of the previous graph with the vertex e . This is called a *generic blow-up*. If q is on a single one of the base surfaces v in $\pi^{-1}(\{p_1, p_2, \dots, p_n\})$, we say that we are *blowing up a vertex*. In the resulting graph, e has an edge with v and the weight of v is lowered by 1. Finally q could potentially be at the intersection of two base surfaces v_1 and v_2 , in which case we say that we are *blowing up an edge*. In that case, we connect e to both v_1 and v_2 then delete the old edge connecting them. The weights on both v_1 and v_2 lower by 1. Figure 3 covers the case of blowing up a resolution of a nested singularity, but Figures 3b, 3c, 3e provide examples for the blow-ups discussed here.

We can consider any blow-up to be a generic blow-up that has potentially been moved to a non-generic point. In the case of a generic blow-up the intersection of the plumbing has changed by taking the direct sum with $[-1]$, and the second homology of the base surfaces include into the summand coming from the original plumbing. In moving the blown-up point to to be non-generic, the homology class of the total transforms are preserved, so using the proper transforms requires a change of basis that affects the Euler numbers.

Not only will there exist a resolution of a given singularity, there will be an unique minimal such plumbing resolution. To achieve this, we know that there would be an unique minimal resolution of the singularity $\pi : \tilde{V} \rightarrow V$ which cannot be blown down further [12], but the exceptional fiber will be a union of Riemannian surfaces, which may contain problematic points such as singularities, triple intersections, and non-transverse intersections. However, any problematic point is a plane curve singularity which can be resolved by a series of blow-ups in a minimal way [12]. (Plane curve singularities are discussed more in Subsubsection 2.1.2.) Because resolving a point of the exceptional fiber produces another resolution, after resolving each of these, we can achieve the desired minimal plumbing resolution. Any resolution can

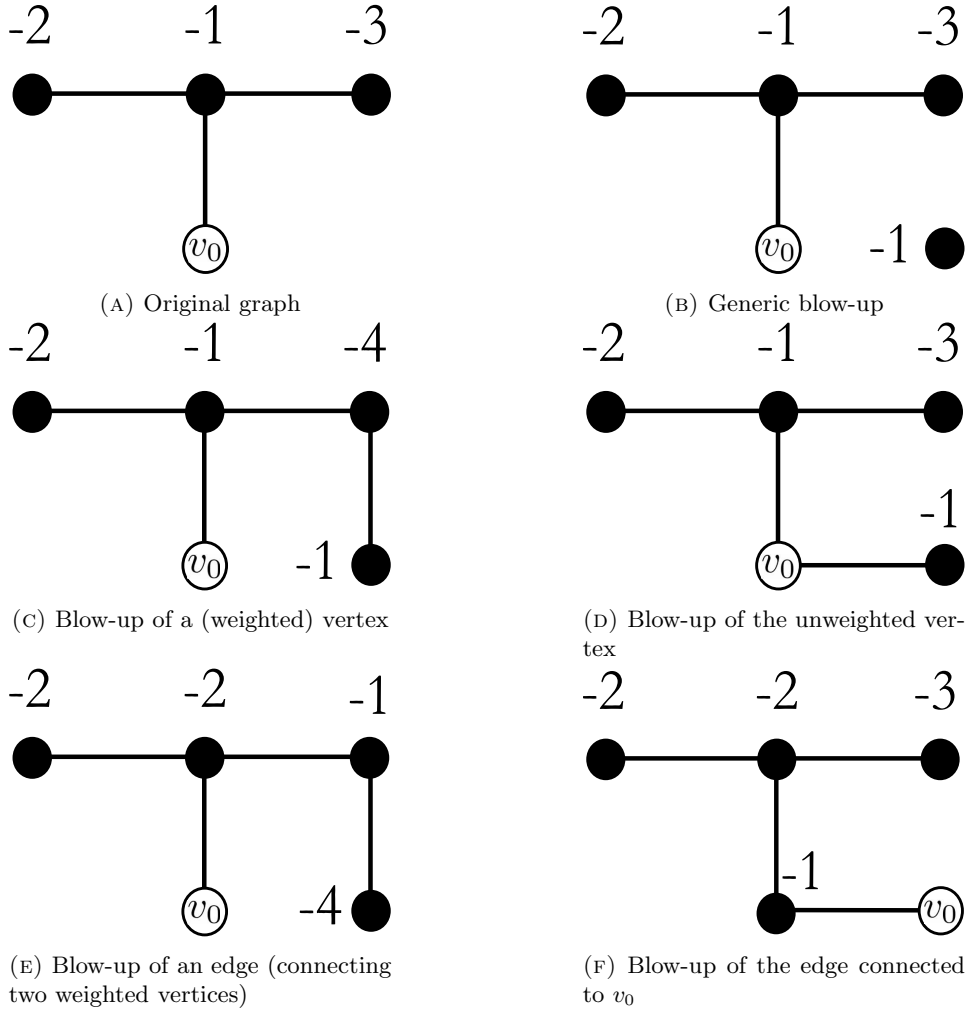

FIGURE 3. An example of a graph depicting a generalized algebraic knot 3a, along with the various blow-up moves that can be done to said graph that occur away from the curve defining the knot (3b,3c,3e) and those that affect the curve defining the knot (3d and 3f).

be reduced to the minimal resolution via a sequence of blow-downs, and the same can be said of the minimal plumbing resolution [12].

This argument highlights that it is possible to get between any two resolutions of the same singularity through blow-ups and blow-downs. Furthermore, the homeomorphism type of the link of singularity determines the topology of the minimal plumbing resolution [18]. One way this unfolds in practice is that if given two negative definite plumbings with the same boundary, it is possible to get between them using blow-ups and blow-downs.

Example 2.7. A key class examples to keep in mind are the Brieskorn spheres $\Sigma(p, q, r)$, which are links of singularity for varieties defined by $f(x, y, z) = x^p + y^q + z^r = 0$ where p, q, r are pairwise coprime. These are known to be integral homology spheres. There is an algorithm in terms of p, q , and r for writing a Brieskorn sphere as the boundary of a negative-definite plumbing [19].

2.1.2. Algebraic Links.

Definition 2.8. An *algebraic link* L in S^3 is the link of some plane curve singularities $(C, \{p_1, \dots, p_n\})$, where C is a curve in \mathbb{C}^2 . Consider a path γ passing through $\{p_1, \dots, p_n\}$ and no other singular points of C . In defining our link of singularity, we take a regular neighborhood N of a path γ connecting $\{p_1, \dots, p_n\}$ where $N \cap C$ must be a regular neighborhood of $\gamma \cap C$. The link of singularity is the embedding of $L := \partial N \cap C$ inside $\partial N \cong S^3$. An *algebraic knot* is an algebraic link that only has one component.

Algebraic links are both links in terms of links of singularity and in terms of the links in knot theory. Similar to other links of singularity, one often defines algebraic links by intersecting C with a small sphere around a singular point, which makes the identification of ∂N with S^3 even clearer. Figure 1a gives a dimensionally reduced picture of what an algebraic knot should look like in contrast to a link of a normal complex surface singularity.

The path γ in the definition affects the result insofar as that γ traveling between two singularities p_i and p_j of C could lie entirely on C or it could leave and come back to C . In the first case we would get the connect sum of the knots achieved around each separate point, and in the second case we would get the disjoint union of the algebraic links around the p_i , plus potentially some unknots. Expanding the collection of singular points so that the path γ can only exit and return to C once between consecutive singular points handles these extraneous unknots. Therefore, if one cares primarily about algebraic knots one may assume that the path γ lies entirely in C before exiting once to points $\{p_k, p_{k+1}, \dots, p_n\}$ not on our curve. If one cares primarily about prime knots, then one may assume that the algebraic link is the link of singularity of a single point.

Definition 2.9. A resolution $\tilde{V} \rightarrow \mathbb{C}^2$ of a plane curve singularity $(C, \{p_1, \dots, p_n\})$ is a resolution of $(\mathbb{C}^2, \{p_1, \dots, p_n\})$, so that the irreducible components of the total transform of C are all smooth and have intersections algebraically modeled on $xy = 0$ in \mathbb{C}^2 .

As alluded to in the discussion of minimal plumbing resolutions, plane curve singularities can be resolved using a sequence of blow-ups, and they will have unique minimal resolutions, which cannot be blown further without losing the conditions smoothness or the local model of the intersections [12].

Resolutions of plane curve singularities are always plumbing resolutions and thus can be expressed in terms of plumbing graphs for S^3 with unweighted vertices representing the components of the proper transform of C . Because of the local model required for the irreducible components of the total transform of C , we have that the proper transform of C must consist of fibers of the disk bundles used in the plumbing. The algebraic link will be a knot if and only if there is a single unweighted vertex. In terms of the graphs, connect sums are constructed as the disjoint union of plumbing graphs merged at the unweighted vertex; a disjoint union would be

represented with unweighted vertices on separate components of the graph. Note that the graphs of Figure 3 represent an algebraic knot, the trefoil, which is defined by the plane curve $f(x, y) = x^2 + y^3 = 0$ with singularity at 0.

Furthermore, viewing a resolution of points in \mathbb{C}^2 as a plumbing of disk bundles over spheres and taking a collection of the fibers will represent some algebraic link. Projecting the fibers from the resolution to \mathbb{C}^2 will give a potentially singular plane curve, and we can choose our path γ to give connect sums or disjoint unions as appropriate.

All the blow-ups and blow-downs that can be done to the plumbings graphs representing resolutions of normal complex surface singularities can be done to the plumbing resolutions for algebraic links (See Figure 3); however, we also have moves that come from blowing up a point on the proper transform of C . One option is if this point is away from the exceptional fiber, which is called *blowing up the unweighted vertex* (see Figure 3d). Another option is if the blown up point is an intersection between the proper transform of C and an exceptional fiber, which results in *blowing up an edge incident to the unweighted vertex* (see Figure 3f). Both act similarly to their counterparts with weighted vertices, but we do not have to adjust the non-existent weighting on the unweighted vertex. Blowing up the unweighted vertex has the same effect as taking the connect sum with an unknot.

Example 2.10. Algebraic links are a particularly restricted class of links, which are well understood in terms of torus knots and links. For $p, q \geq 0$, the (p, q) torus link $T_{p,q}$ is the link of the singularity defined by $f(x, y) = x^p + y^q = 0$. If p and q are coprime $T_{p,q}$ is a torus knot. It is so called because its link lives entirely on a standardly embedded torus in S^3 , and in particular there exists a $z_0 \in (0, 1)$ such that $T_{p,q}$ lives on

$$\{x, y \in \mathbb{C}^2 : |x|^2 = z_0, |y|^2 = 1 - z_0\}.$$

While only positive (p, q) appear as algebraic links, one can get negative p or q in general, as the torus link $T_{p,q}$ is also defined as an embedded representative of $p\lambda + q\mu$ where λ represents the longitude of the torus and μ represents the meridian.

The torus knot $T_{p,q}$ can also be viewed as a subset of the solid torus J in S^3 , where one only requires $|x| \leq z_0$. Given another knot K , one can map J to a tubular neighborhood of K such that the preferred longitude of J maps to the longitude of K , i.e. a null homologous curve in $S^3 - K$. We can then consider the image of $T_{p,q}$ under this map as a new knot in S^3 , called *the (p, q) -cable of K* , denoted $K_{p,q}$. Note that while $T_{p,q}$ and $T_{q,p}$ are isotopic as knots in S^3 , when viewed in the solid torus they are distinct. An iterated torus link is a knot achieved through successive cabling starting from an unknot. An iterated torus link $T_{(p_1, q_1), (p_2, q_2), \dots, (p_n, q_n)}$ is algebraic if $q_{i+1} > p_i p_{i+1} q_i$ for all i , and all algebraic links made from a single singularity are iterated torus links [6].

2.1.3. Generalized Algebraic Links. Links of normal complex surface singularities depend on a normal complex surface singularity, whereas algebraic links depend on a singular plane curve but have a smooth ambient space. For generalized algebraic links we will be combining these notions and will thus need the following concept

Definition 2.11. Let S be a normal two-dimensional complex variety S and $C \subseteq S$ a complex curve inside S . Let $\{p_1, p_2, \dots, p_n\}$ be a collection of potential singularities in S , which may or may not also be on C . We say that $(S, C, \{p_1, p_2, \dots, p_n\})$ is a *collection of nested singularities* or if $n = 1$ a *nested singularity*.

Here we have both a complex surface and a curve, and both are allowed to be singular. Figure 1c provides a visualization of a nested singularity and its link next to figures depicting algebraic links and a link of a normal complex surface singularity. We are now in a position to formally define a generalized algebraic link as follows:

Definition 2.12. Let $(S, C, \{p_1, p_2, \dots, p_n\})$ be a collection of nested singularities, and let γ be a path connecting the p_i that does not pass through any singularity not in the list. Take a regular neighborhood N of γ so that $C \cap N$ is a regular neighborhood of $C \cap \gamma$. Then $L = \partial N \cap C$ is a *generalized algebraic link* inside the link of singularity $Y = \partial N$. A *generalized algebraic knot* is a generalized algebraic link so that $\partial N \cap C$ has only one component.

As with algebraic links, the path γ exiting C would indicate taking a disjoint union of generalized algebraic links while γ remaining in C creates a connected sum of algebraic links. If one cares only about algebraic knots one may assume γ lies entirely in C and if one cares only about prime algebraic knots one may assume that one is taking the link of singularity of a single point. The primary motivation for including multiple potential singular points and the path γ was to include connect sums in the definition as that is the appropriate scope for knot lattice homology.

Remark 2.13. Eisenbud and Neumann use this framing (for a single point of singularity) as a part of a general definition of an algebraic link towards the end of the book [6]. We are choosing the term generalized algebraic link to avoid confusion because algebraic links are often assumed to be in S^3 . Furthermore, while Eisenbud and Neumann do not allow for connect sums, their definition is set up to account for links with multiplicity, where the corresponding algebraic curve C is not presumed to be reduced [6].

Definition 2.14. A *resolution of a nested singularity* $(S, C, \{p_1, p_2, \dots, p_n\})$ is a map $\pi : \tilde{S} \rightarrow S$ that is a resolution of S at $\{p_1, \dots, p_n\}$ and it is a resolution of C , i.e. the total transform of C in \tilde{S} has all smooth components with intersections locally modeled in algebraic charts on $xy = 0$.

See Figure 2b for a representation of a resolution of a normal surface singularity. This subfigure has an extra sphere in contrast to Figure 2a to highlight that additional blow-ups may be needed after resolving the surface in order to completely resolve the curve. One can see the proper transform of the curve pierce the extra sphere transversely to highlight that the proper transform would be a fiber of the plumbing resolution.

As with normal complex surface singularities, minimal plumbing resolutions exist and are unique. The same argument for existence and uniqueness carries through from the link of a normal complex surface singularity case, except one considers all irreducible components of the total transform of C and not just the irreducible components of the exceptional fibers in identifying problem points.

Theorem 24.1 of Eisenbud and Neumann establishes the equivalence of resolutions of nested singularities with collections of fibers in negative definite plumblings whose bases have positive intersections [6]. As before, we can then represent this using unweighted vertices attached to a plumbing graph. The main difference from the algebraic link case is that our resolutions and plumbing graphs do not need to be for \mathbb{C}^2 but can be for potentially singular normal complex surfaces S , allowing us

to have generalized algebraic links in links of normal complex surface singularities other than S^3 . The blow-ups and blow-downs mentioned in earlier sections and illustrated in Figure 3 can still be done in this setting.

2.2. Checking Blow-Ups Suffice. This section will focus on showing that the link type (Y, L) of a generalized algebraic link determines the topology of the minimal plumbing resolution of the nested singularity type used to create it. In particular, we show that any two plumbing representations of the same generalized algebraic link are equivalent up to a series of blow-ups and blow-downs, which can be done in the algebraic/analytic setting. This fact may potentially be known to experts, but we could not find a proof in the literature prior to its independent proof by Jackson [10]. The equivalence of link types we are considering is up to homeomorphism of the three-manifold which takes one link to the other. However, while we are showing that knowledge of the algebraic/analytic setting suffices to get between any two representations of the same link type, we will have to use knowledge regarding a broader class of three-manifolds and links to do so.

Definition 2.15. A *graph manifold* is a three-manifold which is the boundary of a plumbing of surfaces (orientable or not), with positive or negative intersections between the base surfaces, and any intersection form. The surfaces may even have boundary, where the three-manifold is the fiber boundary instead of the boundary of the full four-manifold.

A *graph link* is a link encoded as a graph manifold with boundary, where boundary components are equipped with isotopy classes of simply connected closed curves. The corresponding link is achieved by gluing solid tori to the manifold so that the meridians of the solid tori are sent to the isotopy classes in question, and then using the cores of the solid tori for the link.

Graph links can be represented as unweighted vertices in plumbing graphs, where the meridional data is assumed to come from the boundary of the base surfaces. They are often given a different decoration to distinguish them from other vertices with boundary components that do not have meridional data. Here unweighted vertices that are meant to represent links do not have genus or a number of boundary components listed. They also are given names with a subscript of 0.

In [18], Neumann defined a series of moves R1-R8 that can be done in the class of graph manifolds. In these diagrams, genus information is encoded in brackets with negative numbers representing non-orientable surfaces with those numbers of crosscaps, and if the surface has boundary, the number of boundary components is included as a second number inside the brackets. Furthermore [18] defines a *normal form* of a graph, satisfying 6 conditions, N1-N6, such that the homeomorphism type of a graph three-manifold determines a graph in normal form. Since the definitions are long and not central to this paper outside of this subsection, we will not reproduce them here.

In order to show a set of moves go between any two graph representations of the same three-manifold, Neumann describes a strategy of determining a graph representation for that type to which one can reduce any representation given using only those moves [18]. Then one shows that that form is determined by the corresponding normal form for the three-manifold. This strategy was implemented to show that the homeomorphism type of a link of singularity determined the singularity type. Neumann also stated (with proof omitted) that this strategy worked to show

that any two representations of the same graph link could be related via moves R1-R7.

Here we will be considering a minimal plumbing representation Δ for our generalized algebraic link, which as mentioned in the previous section exists and is unique for the singularity type. Note that a plumbing resolution will be minimal if and only if it has no -1 weighted vertices of degree 2 or less, counting edges to the unweighted vertex in this count. Let Γ represent the normal form for the graph with boundary (and no meridional data).

Proposition 2.16. *One can get from Δ to Γ by*

- (1) *Collapsing the path from the unweighted vertex to the first vertex v , which either has degree greater than 2 or is not represented by a sphere. This leaves v as an unweighted vertex representing a surface with boundary and no meridional data.*

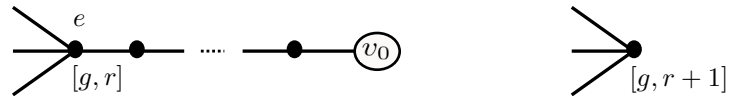

- (2) *If a component of Δ looks like*

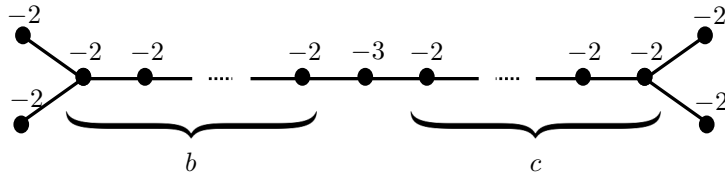

where $b \geq 0$ and $c \geq 1$, then the corresponding component of Γ looks like

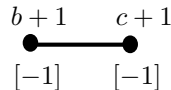

- (3) *Any components of Δ that look like*

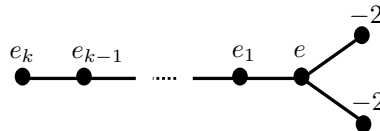

with $k > 1$ and $e_i \leq 2$ for all i , appear as is in Γ

- (4) *For all remaining components, substitute portions of the graph that look like the figures on the left with the portions on the right.*

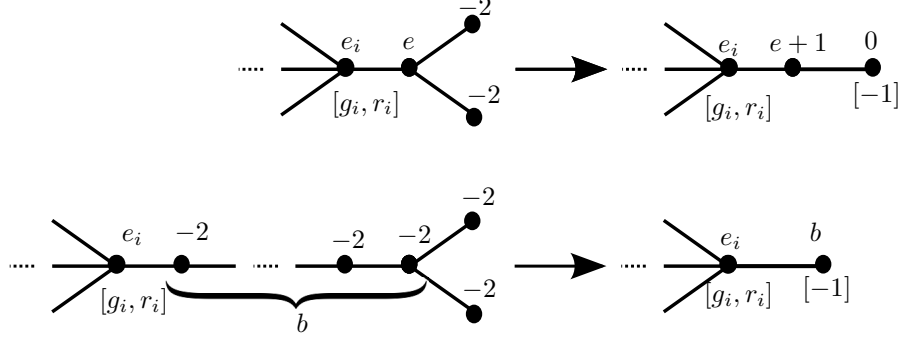

Substitutions 2-4 are the substitutions in Theorem 8.2 of [18].

Furthermore graph Δ can be recovered from Γ .

Proof. Collapsing the path from an unweighted vertex v_0 to the first vertex v either not represented by a sphere or of degree greater than or equal to 3 can be achieved by a sequence of R8 moves, and the sequence of moves needed for the rest of the reductions is covered by [18]. What needs to be shown is that after these moves, the resulting graph, which we will call Γ' is in normal form.

To check N1, note that no more R8 moves can be applied, and remaining substitutions prevent there from being any R2 moves on Γ' that violate N1. Furthermore, we started with no zero framed spheres, and the moves do not produce any 0 framed spheres of degree greater than or equal to 2. Thus there are no R3-R6 moves available on Γ' . Finally none of the starting components of R7 moves could be produced by the moves described above, nor are any of them negative definite. Thus there will be no R7 moves on Γ' . We assumed that there were no R1 moves available, and the moves provided do not produce any -1 or +1 framed vertices, and thus here will be no R1 moves available on Γ' . Hence, Γ' satisfies N1.

Any chains, paths of vertices representing spheres of degree 1 or 2, produced in this process have weight less than or equal to -2 , and the same can be said for all chains of Δ . Thus, Γ' satisfies N2.

The substitutions (2) and (4) above prevent any portion of Γ' from violating N3. Any 0 framed disk bundle over an $\mathbb{R}P^2$ would be produced by (4) and does not violate N4. No components violating N5 are produced because the declaration of (3) specifically prevents it. Lemma 8.1 of [18] prevents one of the forbidden components of N6 from appearing. Thus, having established that Γ' is in normal form, we can conclude that $\Gamma' = \Gamma$.

To show that Δ can be recovered from Γ , we need to show these steps are reversible. For (2) and (4) this is clear: substitute the figure on the left for the figure on the right instead of right for left, and for (3), we do nothing. What remains to be checked is if we can recover a single negative definite minimal Δ from the information of meridians on the boundary components of Γ . This works out similarly to the case of finding the preferred star shaped plumbing for a Seifert fibered space, as described in [19]. The only place in [19] where Neumann and Raymond used the whole Seifert graph instead of trying to expand a given singular fiber into a chain was to check that using the unique chain with weights less than or

equal to -2 produced a negative definite four-manifold. In our case, once we have produced such a unique Δ we know that it is negative definite by assumption. \square

The proposition above with Neumann's result that the homeomorphism type determines the normal form Γ [18] gives us a proof of Theorem 1.3.

3. CONSTRUCTION AND CONTEXT FOR KNOT LATTICE HOMOLOGY

3.1. Motivations for the Equivalence Type. The Floer theories of Heegaard Floer homology and knot Floer homology will not be needed in the main body of this paper, but they provides an important context for lattice homology and knot lattice homology, including what properties we expect lattice homology and knot lattice homology to have. Furthermore, understanding the Floer theories helps us understand what aspects of lattice homology and/or knot lattice homology we would want to keep track of during the proof of invariance. This section culminates in providing the structure we expect knot lattice homology and knot lattice homology to have, including what it would mean for these structures to be equivalent to each other (see Definition 3.1 and subsequent discussion). Because Heegaard Floer homology and knot Floer homology have technical definitions, we will not be providing them here, but instead focus on the properties said theories are known to satisfy. We will generally be assuming that X is a four-manifold with boundary Y .

Heegaard Floer homology is a functor from the 3-dimensional Spin^c cobordism category to the category of graded $\mathbb{Z}[U]$ -modules, where U has grading -2 . The grading here is called the Maslov grading. The 3-dimensional Spin^c cobordism category has objects closed oriented 3-manifolds Y equipped with Spin^c structures \mathfrak{t} , and the morphisms have the form $(W, \mathfrak{s}): (Y_1, \mathfrak{t}_1) \rightarrow (Y_2, \mathfrak{t}_2)$ where W is an oriented cobordism from Y_1 to Y_2 and \mathfrak{s} is a Spin^c structure on W that restricts appropriately on the ends. The Heegaard Floer module (often referred to as the minus version to distinguish it from other coefficient choices) associated to (Y, \mathfrak{t}) is denoted $HF^-(Y, \mathfrak{t})$ and the morphism associated to (W, \mathfrak{s}) is $F_{W, \mathfrak{s}}^-$.

The exact definition of a Spin^c structure will not be needed here, but for a manifold M , $\text{Spin}^c(M)$ is affinely modeled on $H^2(M; \mathbb{Z})$ and there exists a natural map $c_1: \text{Spin}^c(M) \rightarrow H^2(M; \mathbb{Z})$. In particular for $\mathfrak{s} \in \text{Spin}^c(X)$, if $\mathfrak{s}|_Y = \mathfrak{t}$ then $c_1(\mathfrak{s})$ maps to $c_1(\mathfrak{t})$. There also exists an involution $\mathfrak{s} \rightarrow \bar{\mathfrak{s}}$ called conjugation, and $c_1(\bar{\mathfrak{s}}) = -c_1(\mathfrak{s})$.

In the context of lattice homology, it can be useful to think of Spin^c structures on Y in terms orbits of characteristic cohomology classes of X . In the case where X is a plumbing of surfaces the first homology of X is isomorphic to the free part of Y , and as such, $H^2(X; \mathbb{Z}) \cong H_2(X; \mathbb{Z})^*$. An element $K \in H^2(X; \mathbb{Z})$ is characteristic if $K([S]) \equiv [S] \cdot [S] \pmod{2}$ for all homology classes $[S]$. It suffices to check that $K(v_i) \equiv e_i \pmod{2}$ for all vertices v_i of G . This is equivalent to K reducing mod 2 to the second Steifel-Whitney class $w_2(X)$. Denote the set of characteristic cohomology classes on X by $\text{Char}(G)$. For many four-manifolds including plumbings, the map $c_1: \text{Spin}^c(X) \rightarrow \text{Char}(G)$ is a bijection. In this context, $[S] \in H_2(X; \mathbb{Z})$ can act on $K \in \text{Char}(G)$ by $K + [S] := K + 2\text{PD}[S]$. The orbits of this action on $\text{Char}(G)$ correspond to the torsion elements of $\text{Spin}^c(Y)$, and we will denote the orbit of $\text{Char}(G)$ corresponding to an element $\mathfrak{t} \in \text{Spin}^c(Y)$ by $\text{Char}(G, \mathfrak{t})$.

Some important formal features of Heegaard Floer homology that appear in lattice homology are as follows. If $c_1(\mathfrak{t})$ is torsion, then $HF(Y, \mathfrak{t})$ has an absolute \mathbb{Q} -grading which is a relative \mathbb{Z} -grading, and if $c_1(\mathfrak{t})$ is 0 then the absolute grading on $HF^-(Y, \mathfrak{t})$ also lies in \mathbb{Z} . When taken with $\mathbb{Z}[U, U^{-1}]$ coefficients, the homology is called $HF^\infty(Y, \mathfrak{t})$ and for rational homology spheres is always isomorphic to $\mathbb{Z}[U, U^{-1}]$. Thus for rational homology spheres, $HF^-(Y, \mathfrak{t})$ as a finitely presented $\mathbb{Z}[U]$ -module has exactly one $\mathbb{Z}[U]$ summand. Even when $HF^-(Y, \mathfrak{t})$ does not have an absolute \mathbb{Z} grading, in the rational homology sphere case it has a $\mathbb{Z}/2\mathbb{Z}$ grading where the $\mathbb{Z}[U]$ summand is considered even. Connect sums of three-manifolds produce tensor products on the chain level. There exists an canonical ι up to chain homotopy on $\bigoplus_{\mathfrak{t} \in \text{Spin}^c(Y)} HF^-(Y, \mathfrak{t})$ that maps $HF^-(Y, \mathfrak{t})$ to $HF^-(Y, \bar{\mathfrak{t}})$ where ι^2 is chain homotopic to the identity [9]. A rational homology sphere Y is an L-space if $HF^-(Y, \mathfrak{t})$ has no U torsion for any Spin^c structure \mathfrak{t} .

Knot Floer homology is an invariant for knots that builds off of Heegaard Floer homology, and it is the Floer theoretic counterpart to knot lattice homology. However, before getting into details, one must decide on how one will package the information of knot Floer homology, and there are two different conventions: as an Alexander filtration on $CF^\infty(Y, \mathfrak{t})$ and as a complex of $\mathbb{Z}[U, V]$ modules. The discussion in [21] defines knot lattice homology in a way that mirrors the former, by constructing an Alexander filtration directly on $\mathbb{C}F^\infty(Y, \mathfrak{t})$. I view my construction of knot lattice as informed by the $\mathbb{Z}[U, V]$ module perspective, and in Subsection 3.3 I provide a way of calculating the Maslov grading corresponding to V , which I confirm provides the same result as calculating the Alexander grading directly. As such, I will present the $\mathbb{Z}[U, V]$ perspective here.

Let Y be a three-manifold, K a rationally null homologous knot in Y and \mathfrak{t} a Spin^c structure on Y . The knot Floer complex $CFK_{\mathbb{Z}[U, V]}(Y, K, \mathfrak{t})$ is an invariant of the knot up to chain homotopy equivalence of $\mathbb{Z}[U, V]$ modules. More generally, for any $\mathbb{Z}[U, V]$ module M let

$$CFK_M(Y, K, \mathfrak{t}) := CFK_{\mathbb{Z}[U, V]}(Y, K, \mathfrak{t}) \otimes_{\mathbb{Z}[U, V]} M.$$

If a subscript is omitted, assume the coefficients are in $\mathbb{Z}[U, V]$. As in Heegaard Floer, taking the connect sum of knots produces a tensor product on the chain level.

The presentation of the knot (Y, K) used in the creation of the knot Floer complex contains two potentially different presentations of the three-manifold Y . Each presentation of the three-manifold comes with its own Maslov grading gr_U and gr_V , and there is then a new grading called the Alexander grading on the generators of $CFK(Y, K, \mathfrak{t})$ represented by $A := \frac{\text{gr}_U - \text{gr}_V}{2}$. Both gr_U and gr_V are homological gradings, i.e. the differential lowers them by 1, while the Alexander grading is preserved by the differential. Note that U will shift the Alexander grading by -1 while V shifts the Alexander grading by 1, so UV fixes the Alexander grading. Thus, the Alexander grading splits $CFK(Y, K, \mathfrak{t})$ into summands as a $\mathbb{Z}[UV]$ -module, and we will use $CFK(Y, K, \mathfrak{t}, s)$ to refer to the Alexander grading s portion of this complex.

Each of U and V can be seen as coming from one of the presentations of the three-manifold. For example, “forgetting” a variable by setting it equal to 1 “forgets” the knot and produces the Heegaard Floer complex associated to the presentation of the three-manifold for the remaining variable. This can be made precise and stronger in the following statement. The complex $CFK_{\mathbb{Z}[U, V, V^{-1}]}(Y, K, \mathfrak{t}, s)$

is canonically isomorphic as a $\mathbb{Z}[UV]$ -complex to $CF^-(Y, \mathfrak{t})$ using one presentation of Y , while $CFK_{\mathbb{Z}[U, U^{-1}, V]}(Y, K, \mathfrak{t}, s)$ is canonically isomorphic as a $\mathbb{Z}[UV]$ -complex to $CF^-(Y, K, \mathfrak{t} + \text{PD}(K))$ using the other presentation. Note the change in Spin^c structure when inverting U . We can view maps such as ι on $CF^-(Y, \mathfrak{t})$ in the Heegaard Floer setting as maps on $CFK_{\mathbb{Z}[U, V, V^{-1}]}(Y, K, \mathfrak{t}, s)$ or $CFK_{\mathbb{Z}[U, U^{-1}, V]}(Y, K, \mathfrak{t}, s)$. These maps are $\mathbb{Z}[U, V]$ -linear in that multiplying by the inverted variable changes s but leaves the map unchanged; however these maps are not necessarily induced by maps on $CFK(Y, K, \mathfrak{t})$.

The knot Floer complex also comes equipped with an map, defined up to chain homotopy,

$$\iota_K : \bigoplus_{\mathfrak{t} \in \text{Spin}^c(Y)} CFK(Y, K, \mathfrak{t}) \rightarrow \bigoplus_{\mathfrak{t} \in \text{Spin}^c(Y)} CFK(Y, K, \mathfrak{t}),$$

which is *skew- $\mathbb{Z}[U, V]$ linear*, which means $\iota_K(U \cdot x) = V \cdot \iota_K(x)$ and gr_U and gr_V are swapped as well. For a given a Spin^c structure \mathfrak{t} and Alexander grading s , $\iota_K : CFK(Y, K, \mathfrak{t}, s) \rightarrow CFK(Y, K, \mathfrak{t} + \text{PD}(K), -s)$. The map ι_K is defined up to chain homotopy.

The presentation used to create knot Floer also induces a map $\Gamma : CF^-(Y, \mathfrak{t} + \text{PD}(K)) \rightarrow CF^-(Y, \mathfrak{t})$, called the flip map. In particular, we can view this as a $\mathbb{Z}[UV]$ linear map

$$\Gamma : CFK_{\mathbb{Z}[U, U^{-1}, V]}(Y, K, \mathfrak{t} + \text{PD}(K), s) \rightarrow CFK_{\mathbb{Z}[U, V, V^{-1}]}(Y, K, \mathfrak{t}, s).$$

As with ι and ι_K , the map Γ is defined up to chain homotopy. The map Γ plays a particularly important role in the surgery formula [25]. While Γ may not necessarily be determined by $\bigoplus_{\mathfrak{t}, s} CFK_{\mathbb{Z}[U, V]}(Y, K, \mathfrak{t}, s)$, the author has work in progress to show that it is determined by ι_K and ι .

Inspired by the above structure on knot Floer homology, we will use the following definition to provide the level of structure we will be looking for in knot lattice homology as an invariant, including what it would mean for two such structures to be equivalent.

Definition 3.1. Given a knot K in a three-manifold Y , a *complete package* for (Y, K) is a triple (C, J_{v_0}, J) , where

- (1) C is a bigraded $\mathbb{Z}[U, V]$ complex that splits as $\bigoplus_{\mathfrak{t} \in \text{Spin}^c(Y)} (C, \mathfrak{t})$ with U having grading shift $(-2, 0)$ and V having grading shift $(0, -2)$.
- (2) A map $J_{v_0} : C \rightarrow C$, which is skew- $\mathbb{Z}[U, V]$ linear. It should send (C, \mathfrak{t}) to $(C, \mathfrak{t} + \text{PD}[\overline{K}])$, and $J_{v_0}^2$ is chain homotopic to the identity.
- (3) A $\mathbb{Z}[U, V]$ -linear map $J : (C, \mathfrak{t}) \otimes \mathbb{Z}[U, V, V^{-1}] \rightarrow (C, \mathfrak{t}) \otimes \mathbb{Z}[U, V, V^{-1}]$ that preserves Alexander grading. Further, J^2 is chain homotopic to the identity.

We will consider two complete packages $(C_1, J_{v_0,1}, J_1)$ and $(C_2, J_{v_0,2}, J_2)$ equivalent if there exists a chain homotopy equivalence $f : C_1 \rightarrow C_2$ that commutes with J_{v_0} up to homotopy and, once included into the tensor with $\mathbb{Z}[U, V, V^{-1}]$, commutes with J up to homotopy.

Remark 3.2. The map ι_K , while conventionally called the knot involution, is not necessarily an involution and squares to the Sarkar map [9]. Furthermore, even if for two knots K_1 and K_2 it is known to be an honest involution, this may become false when taking the connect sum, as the knot involution for $K_1 \# K_2$ is not merely $\iota_{K_1} \otimes \iota_{K_2}$ but has an extra term coming from formal derivative maps

on the component chain complexes [26]. However, the map on the knot lattice side which most closely appears to be its counterpart is always involution, and hence that is what we are using in our definition here. The exact relationship between these maps is not known, and for example, they may potentially agree for prime knots.

Furthermore, in the knot lattice case, we already know that the map corresponding to Γ can be recovered from the maps J and J_{v_0} [21], so we will not keep track of it separately.

In order to express a complete package in homotopy theoretic terms, we will be replacing our $\mathbb{Z}[U, V]$ chain complex with a doubly-filtered topological space, where the action by U and V become inclusions on the filtration. Double filtrations $\{\mathcal{F}_{t_1, t_2}\}$ in this paper will have parameters t_1 and t_2 which come from (potentially different) cosets of $2\mathbb{Z}$ in \mathbb{Q} and there exists an inclusion $\mathcal{F}_{t_1, t_2} \subseteq \mathcal{F}_{t_3, t_4}$ if $t_1 \geq t_3$ and $t_2 \geq t_4$.

Definition 3.3. Given a double filtration $\{\mathcal{F}_{t_1, t_2}\}$ on a topological space X , the *corresponding single filtration* $\{\mathcal{F}_{t_1, -}\}$ is defined to have

$$\mathcal{F}_{t_1, -} := \bigcup_{t_2} \mathcal{F}_{t_1, t_2}.$$

Given two doubly filtered spaces $(X, \{\mathcal{F}_{t_1, t_2}\})$ and $(Y, \{\mathcal{G}_{t_1, t_2}\})$, a continuous map $f: X \rightarrow Y$ is

- (1) *doubly-filtered* if $f(\mathcal{F}_{t_1, t_2}) \subseteq \mathcal{G}_{t_1, t_2}$ for all t_1, t_2 ,
- (2) *singly-filtered* if $f(\mathcal{F}_{t_1, -}) \subseteq \mathcal{G}_{t_1, -}$ for all t_1 , and
- (3) *skew-filtered* if $f(\mathcal{F}_{t_1, t_2}) \subseteq \mathcal{G}_{t_2, t_1}$ for all t_1, t_2 .

Technically the corresponding single filtration would be equivalent to taking coefficients in $\mathbb{Z}[U, V]/(V - 1)$, but adding a second dummy variable recovers $\mathbb{Z}[U, V, V^{-1}]$ as all levels of the filtration have been correspondingly back-populated.

Definition 3.4. Given a knot K in a three-manifold Y a *complete homotopy package* for (Y, K) is a tuple $(X, \mathcal{F}_{t_1, t_2}, J_{v_0}^\natural, J^\natural)$, where

- (1) the space X is a CW-complex that splits as $\bigsqcup_{t \in \text{Spin}^c(Y)} X_t$
- (2) \mathcal{F}_{t_1, t_2} is a double-filtration on X so that the cell decomposition of X restricts to a cell decomposition of \mathcal{F}_{t_1, t_2} for all appropriate t_1, t_2 .
- (3) the map $J_{v_0}^\natural: X \rightarrow X$ is skew-filtered, continuous, and cellular, and it takes X_t to $X_{\frac{t}{t+\text{PD}[K]}}$ with $(J_{v_0}^\natural)^2$ doubly-filtered homotopic to the identity.
- (4) the map $J^\natural: X \rightarrow X$ is singly-filtered, continuous, and cellular, and it takes X_t to $X_{\bar{t}}$ with $(J^\natural)^2$ singly-filtered homotopic to the identity.

Let C_\bullet be the functor that takes a CW-complex with a given cell decomposition to the cellular chain complex associated to that cell decomposition. Here a continuous cellular map $f: X \rightarrow Y$ induces a chain map $f_\sharp: C_\bullet(X) \rightarrow C_\bullet(Y)$ where the coefficients of f_\sharp between $C_n(X)$ and $C_n(Y)$ are calculated using the degrees of the induced maps from X_n/X_{n-1} to Y_n/Y_{n-1} , similar to how the coefficients are calculated on the cellular boundary map. Given a homotopy $H: X \times I \rightarrow Y$ between two maps $f: X \rightarrow Y$ and $g: X \rightarrow Y$, we get an induced chain homotopy $H_\sharp: C_n(X) \rightarrow C_{n+1}(Y)$. In particular $X \times I$ has a cellular structure induced by the cell structure on X , whereby every n -cell e_n generates n -cells $e_n \times \{0\}$ and $e_n \times \{1\}$

and an $n + 1$ -cell $e_n \times (0, 1)$. Let $\tilde{H}_\#$ be the map induced by H , viewing H as a generic continuous map rather than a homotopy. Then $H_\#(e_n) := \tilde{H}_\#(e_n \times (0, 1))$.

Given a complete homotopy package $(X, \{\mathcal{F}_{t_1, t_2}\}, J_{v_0}^\natural, J^\natural)$, we can recover a complete package as

$$(1) \quad \left(\bigoplus_{t_1, t_2} C_\bullet(\mathcal{F}_{t_1, t_2}), (J_{v_0}^\natural)_\#, (J^\natural)_\# \right)$$

Note that while $\bigoplus_{t_1, t_2} C_\bullet(\mathcal{F}_{t_1, t_2})$ is naturally an abelian group, it gains the structure of a $\mathbb{Z}[U, V]$ module by letting U act by the inclusion $\mathcal{F}_{t_1, t_2} \subseteq \mathcal{F}_{t_1-2, t_2}$ and letting V act by the inclusion $\mathcal{F}_{t_1, t_2} \subseteq \mathcal{F}_{t_1, t_2-2}$. Elements of $C_n(\mathcal{F}_{t_1, t_2})$ have the gradings $\text{gr}_U = n + t_1$ and $\text{gr}_V = n + t_2$. Furthermore, $J_{v_0}^\natural$ being skew-filtered means that $(J_{v_0}^\natural)_\#$ is skew- $\mathbb{Z}[U, V]$ linear, and J^\natural being singly-filtered implies that $(J^\natural)_\#$ is a $\mathbb{Z}[U, V]$ -linear map on

$$\bigoplus_{t_1, t_2} C_\bullet(\mathcal{F}_{t_1, -}) \cong \left(\bigoplus_{t_1, t_2} C_\bullet(\mathcal{F}_{t_1, t_2}) \right) \otimes_{\mathbb{Z}[U, V]} \mathbb{Z}[U, V, V^{-1}],$$

that preserves Alexander grading.

We will talk about a doubly-filtered cellular construction Y^\natural realizing a $\mathbb{Z}[U, V]$ -linear construction Y if, following the format above, $(Y^\natural)_\#$ yields Y . We use the word construction loosely here as there are a number of different things we would like to pass back and forth between these two settings, and in each case we will use the idea of realization to signal our intent. For example, the doubly filtered cellular space $(X, \{\mathcal{F}_{t_1, t_2}\})$ realizes the chain complex C , the skew-filtered map $J_{v_0}^\natural$ realizes the map J_{v_0} , and the singly-filtered map J^\natural realizes the map J on C with coefficients in $\mathbb{Z}[U, V, V^{-1}]$. The complete homotopy package $(X, \{\mathcal{F}_{t_1, t_2}\}, J_{v_0}^\natural, J^\natural)$ realizes the complete package in Equation (1). More generally, we can talk about doubly-filtered continuous cellular maps f^\natural realizing chain maps f if $(f^\natural)_\# = f$ and doubly filtered cellular homotopies H^\natural realizing chain homotopies H if $(H^\natural)_\# = H$. We will have that all the components of the proof of Theorem 1.2 realize the components of the proof of Theorem 1.1.

3.2. A Cubical Construction of Lattice Homology. Lattice homology $\mathbb{H}\mathbb{F}(Y, \mathfrak{t})$ is an invariant for a rational homology link of singularity Y equipped with a Spin^c structure and computed using a plumbing resolution for the corresponding collection of singularities $(S, \{p_1, \dots, p_n\})$. We will generally reference this plumbing resolution as X and assume it has graph G with vertices v_1, \dots, v_n and that v_i has weight v_i^2 . Since the information of X is often presented in the form of G , we will often reference G directly and reference a vertex v_i as if it were also the corresponding homology class of a sphere in X . Because we are assuming Y is a rational homology sphere, all vertices represent spheres and G has no cycles. Némethi introduced lattice homology in [16] and expanded on in [17]. We will primarily be drawing notation from [21] and the framework from [16].

Letting \mathfrak{t} be a Spin^c structure of Y represented as an orbit of characteristic cohomology classes $\text{Char}(G, \mathfrak{t})$ under the action by $H_2(X; \mathbb{Z})$, we will now describe the chain complex $\mathbb{C}\mathbb{F}(G, \mathfrak{t})$. This complex has two gradings δ and μ . Here μ is designed to match up with the Maslov grading on $HF^-(Y, \mathfrak{t})$ and thus is also called the Maslov grading, whereas there is no analogue in Heegaard Floer homology for

δ . While both δ and μ are homological gradings, we will use $\mathbb{C}\mathbb{F}_k(Y, \mathfrak{t})$ to refer specifically to the chains of δ -grading k .

To define $\mathbb{C}\mathbb{F}_k(G, \mathfrak{t})$, first consider an orbit of $\text{Char}(G, \mathfrak{t})$ as the integer lattice inside \mathbb{R}^s where s is the dimension of $H^2(X, \mathbb{Z})$. The choice of zero does not matter here, but we would like the choice of basis for \mathbb{R} to match the action of $H_2(X; \mathbb{Z})$ with its preferred basis of base surfaces. The $\text{Char}(G, \mathfrak{t})$ sitting inside \mathbb{R}^s then gives a decomposition of \mathbb{R}^s into cubes. Denote the set of all such cubes as \mathcal{Q} and the set of cubes of a given dimension by \mathcal{Q}_k . Then we define $\mathbb{C}\mathbb{F}_k(G, \mathfrak{t})$ to be the free $\mathbb{Z}[U]$ module generated by \mathcal{Q}_k , and in particular, $\mathbb{C}\mathbb{F}_0(G, \mathfrak{t})$ is generated as a $\mathbb{Z}[U]$ -module by the elements of $\text{Char}(G, \mathfrak{t})$.

The zero-dimensional cubes are the elements of $\text{Char}(G, \mathfrak{t})$ themselves. One-dimensional cubes are edges connecting K and $K + v_i$ where v_i is a base surface. More generally for $K \in \text{Char}(G, \mathfrak{t})$ and E a subset of the vertices of G , we have that the cube $[K, E]$ is the convex hull of the points $\{K + \sum_{I \subseteq E} v_i : I \subseteq E\}$. Here $|E|$ is the dimension of the cube, so $[K, E] \in \mathcal{Q}_{|E|}$. We may write $[K, \emptyset]$ simply as K . We will say that if $v \in E$ then the cube $[K, E]$ is *supported in direction* v . For each direction v that it is supported in, the cube $[K, E]$ has two faces: $[K, E - \{v\}]$, which we will call the *front face of $[K, E]$ in the direction v* , and $[K + v, E - \{v\}]$, which we will call the *back face of $[K, E]$ in the direction v* .

Now that we have the generators of $\mathbb{C}\mathbb{F}(G, \mathfrak{t})$ we need to define the differential. The decomposition of \mathbb{R}^s into cubes presents it as a cubical complex, and up to powers of U the differential on $\mathbb{C}\mathbb{F}(G, \mathfrak{t})$ is the differential induced on this chain complex. In particular, up to some $\varepsilon_{E,v} \in \{1, -1\}$ to account for orientation conventions and some non-negative integers $a_v[K, E]$ and $b_v[K, E]$ to account for the powers of U on the front and back faces we have

$$\partial[K, E] = \sum_{v \in E} \varepsilon_{E,v} \left(U^{a_v[K,E]} [K, E - \{v\}] - U^{b_v[K,E]} [K + v, E - \{v\}] \right).$$

One way to establish $\varepsilon_{E,v}$ is that if

$$E = \{v_{i_1}, v_{i_2}, \dots, v_{i_n}\}$$

with $i_j < i_{j+1}$ then $\varepsilon_{E,v_{i_j}} = (-1)^j$. This choice of signs has the property that if $u \neq v$ then $\varepsilon_{E,v} \varepsilon_{E-\{v\},u} = -\varepsilon_{E,u} \varepsilon_{E-\{u\},v}$, which is what is needed for $\partial^2 = 0$. To recover the U powers, we will first define a height function $h_U : \mathcal{Q} \rightarrow \mathbb{Q}$, where the U coefficient on $[K', E']$ in $\partial[K, E]$ is $U^{\frac{h_U([K', E']) - h_U([K, E])}{2}}$. As such, we define

$$(2) \quad a_v[K, E] := \frac{h_U([K, E - \{v\}]) - h_U([K, E])}{2}$$

and

$$(3) \quad b_v[K, E] := \frac{h_U([K + v, E - \{v\}]) - h_U([K, E])}{2}.$$

The Maslov grading of $U^j[K, E]$ will be $\mu := |E| + h_U([K, E]) - 2j$.

To define h_U , we will start with the elements of $\text{Char}(G, \mathfrak{t})$, where

$$h_U(K) := \frac{K^2 + s}{4}.$$

This is chosen so that $h(c_1(\mathfrak{s}))$ calculates the grading shift of the Heegaard Floer map $F_{W,\mathfrak{s}}^-: HF^-(S^3, 0) \rightarrow HF^-(Y, \mathfrak{t})$ where W is the cobordism achieved by removing a ball from X .

We will then choose the height function on the remaining cubes as

$$\begin{aligned} h_U([K, E]) &= \min\{h_U([K', E']) : [K', E'] \subset [K, E]\} \\ &= \min\{h_U(K') : K' \in [K, E]\}. \end{aligned}$$

Note that under this definition for h_U we have that given a cube $[K, E]$ with a face $[K', E']$, we have that $h_U([K, E]) \leq h_U([K', E'])$, so in particular a_v and b_v will always be non-negative. On an orbit $\text{Char}(G, \mathfrak{t})$, the values of $h_U(K)$ will all be in the same coset of $2\mathbb{Z}$ in \mathbb{Q} , guaranteeing that a_v and b_v are always integers. Furthermore, at this point we can verify that if $c_1(\mathfrak{t}) = 0$ then the Maslov grading μ is an integer grading.

The following proposition will be useful in calculations, since we may want to understand how h acts on a cube by looking at how it acts on opposing faces, and it follows relatively directly from the definition.

Proposition 3.5. *Let v be a vertex and E is a subset of the vertices with $v \in E$, then for cubes $[K, E]$, we have that*

$$h_U([K, E]) = \min(h_U([K, E - \{v\}]), h_U([K + v, E - \{v\}])).$$

In particular, at least one of $a_v[K, E]$ and $b_v[K, E]$ must be zero.

Example 3.6. Figure 4 provides an example of this calculation for the plumbing of S^3 given in Figure 4c. Let v_1 be the vertex with weight -1 and v_2 the vertex with weight -2 . In the figure v_1 is associated with the vertical direction and v_2 with the horizontal direction. The height function is shown on the characteristic cohomology classes, i.e. the vertices, where the upper right vertex with height 0 represents the characteristic class K_0 such that $K_0(v_1) = -1$ and $K_0(v_2) = 0$. The background of Figure 4a shows the ellipses from the quadratic form $\frac{K^2+2}{4}$. Because we work with characteristic cohomology classes, squaring K based on how K evaluates on v_1 and v_2 requires looking at the inverse of the adjacency matrix for the plumbing graph.

The background of Figure 4b colors the squares by where they sit in the filtration. In order to make the figures individually readable, the colors in Figure 4b do not precisely match the ellipses in Subfigure 4a, but in both cases darker means the cube is higher. One can see that the darkest squares in Figure 4b are precisely those that fit in the second smallest ellipse in Figure 4a. There are no squares that fit inside the smallest ellipse from Figure 4a, and the filtration at level 0 gives a path of four vertices and three edges, which receive the darkest coloring in Figure 4b.

The key properties that make this height assignment work are that for every cube $[K, E]$ and face of that cube $[K', E']$, $h_U([K', E']) - h_U([K, E]) \in 2\mathbb{Z}_{\geq 0}$, and for all $r \in \mathbb{Q}$ that there be a finite number of cubes $[K, E]$ such that $h([K, E]) \geq r$. In fact, any height function h_U satisfying these properties will give a complex $\mathbb{C}\mathbb{F}(G, \mathfrak{t}, h_U)$. Given a choice of base characteristic class $k \in \text{Char}(G, \mathfrak{t})$, one can recover the weight system w from [16] as $w([K, E]) = \frac{h_U(k) - h_U([K, E])}{2}$. Much of the discussion of general weight systems by Némethi carries over here, except h_U may go to \mathbb{Q} instead of just \mathbb{Z} and h_U will have the opposite inequalities due to the subtraction in the conversion [16].

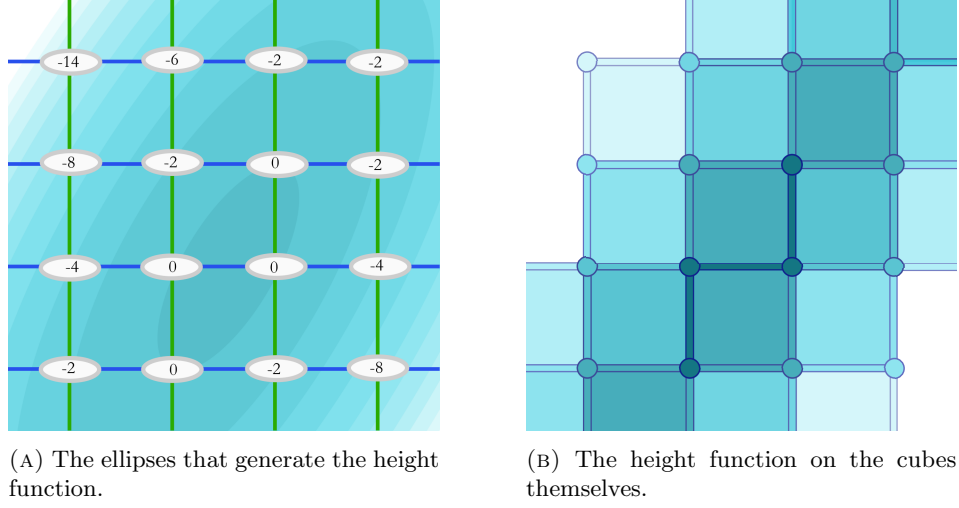

FIGURE 4. An example of the lattice homology filtration. Subfigure 4c gives the plumbing for this example. Subfigure 4a gives the ellipses when using the quadratic form $\frac{K^2+2}{4}$ with the value of the height function labeled on the vertices, i.e. the characteristic cohomology classes. Subfigure 4b shows this height function discretized so that the height of a cube is the same height as its lowest vertex; this gives the filtration for lattice homology. In order to make each figure readable on their own, the colors of the ellipses in Figure 4a are lighter than those for the filtration in figure 4b. However, the relative shadings to agree, and for example the darkest ellipse in Figure 4a and the darkest cubes in Figure 4b are both at height 0.

In order to make defining maps $\varphi : \mathbb{C}\mathbb{F}(G_1, \mathfrak{t}_1) \rightarrow \mathbb{C}\mathbb{F}(G_2, \mathfrak{t}_2)$ easier, we can do so in stages. Letting $\mathbb{C}\mathbb{F}^\infty(G_i, \mathfrak{t}_i)$ denote $\mathbb{C}\mathbb{F}(G_i, \mathfrak{t}_i) \otimes_{\mathbb{Z}[U]} \mathbb{Z}[U, U^{-1}]$, we can first define a graded $\mathbb{Z}[U]$ -linear map $\varphi^\infty : \mathbb{C}\mathbb{F}^\infty(G_1, \mathfrak{t}_1) \rightarrow \mathbb{C}\mathbb{F}^\infty(G_2, \mathfrak{t}_2)$. Note that because U has grading -2 , in order for φ^∞ to be graded, if mU^ζ is the coefficient of $[K_2, E_2]$ in $\varphi^\infty([K_1, E_1])$ with $m \in \mathbb{Z}$, then

$$\zeta = \frac{h_U([K_2, E_2]) - h_U([K_1, E_1])}{2}.$$

In particular, the power on U is determined by $[K_1, E_1]$ and $[K_2, E_2]$, so we can leave it as ζ when defining φ^∞ . Furthermore, the U -power can be effectively ignored when checking that φ^∞ is a chain map, i.e. checking with $\mathbb{Z}[U]/(U-1)$ coefficients suffices. The (chain) map φ^∞ will correspond to a (chain) map $\varphi : \mathbb{C}\mathbb{F}(G_1, \mathfrak{t}_1) \rightarrow$

$\mathbb{C}\mathbb{F}(G_2, \mathfrak{t}_2)$ if for every $[K_2, E_2]$ that has a nonzero coefficient in $\varphi^\infty([K_1, E_1])$, $h_U([K_2, E_2]) \geq h_U([K_1, E_1])$.

One key observation of Némethi is that a $\mathbb{Z}[U]$ -complex $\mathbb{C}\mathbb{F}(G, \mathfrak{t})$ is equivalent to equipping the cube complex for \mathbb{R}^s with a filtration $\{\mathcal{F}_r\}$ where $\mathcal{F}_r := \text{Span}\{[K, E] : h_U([K, E]) \geq r\}$ [16]. The complex is recovered as $\bigoplus_r \mathcal{F}_r$ where r is taken from the coset of $2\mathbb{Z}$ in \mathbb{Q} that contains the image of h_U , and the action of U is the inclusion of \mathcal{F}_r into \mathcal{F}_{r-2} . This approach suggests the following definition:

Definition 3.7. The *lattice space* $\mathbb{C}\mathbb{F}^{\natural}(G, \mathfrak{t})$ associated to a plumbing and Spin^c structure (G, \mathfrak{t}) is the data of the cube decomposition of Euclidean space equipped with the filtration induced by h_U . The *lattice homotopy type* $\mathbb{C}\mathbb{F}^{\natural}(Y, \mathfrak{t})$ is the filtered homotopy type of a given $\mathbb{C}\mathbb{F}^{\natural}(G, \mathfrak{t})$ where (G, \mathfrak{t}) is a particular plumbing representation of (Y, \mathfrak{t}) .

Némethi's proof of $\mathbb{C}\mathbb{F}(Y, \mathfrak{t})$'s invariance worked through homotopy theoretic arguments, though these arguments did not produce a particular homotopy when realizing one space as a deformation retract of another. Subsection 4.2 will provide an explicit construction of such a homotopy.

In describing $\mathbb{C}\mathbb{F}^{\natural}(G, \mathfrak{t})$, a characteristic cohomology class K can be thought of as representing a particular element of \mathcal{Q}_0 and thus a 0-cell in our CW-complex. As such, we will think of K as representing a particular point in $\mathbb{C}\mathbb{F}^{\natural}(G, \mathfrak{t})$. More generally, we will think of \mathcal{Q} as not just the set of generators for $\mathbb{C}\mathbb{F}(G, \mathfrak{t})$ but as the set of cubes from the cell decomposition of $\mathbb{C}\mathbb{F}^{\natural}(G, \mathfrak{t})$ as a CW-complex. With that in mind, let the coordinates on $\mathbb{C}\mathbb{F}^{\natural}(G, \mathfrak{t})$ be given so that

$$(x_1, x_2, \dots, x_i, \dots, x_s) + u_i = (x_1, x_2, \dots, x_i + 1, \dots, x_s),$$

and \mathcal{Q}_0 is precisely the integer lattice. We will represent the k -skeleton of $\mathbb{C}\mathbb{F}^{\natural}(G, \mathfrak{t})$ by $\mathbb{C}\mathbb{F}_k^{\natural}(G, \mathfrak{t})$.

Ozsváth, Stipsicz, and Szabó remarked upon the following equivalence in the chain complex setting, and it can be handled in the filtered setting as well. [21].

Proposition 3.8. *Let G_1 and G_2 be graphs and with Spin^c structures \mathfrak{t}_1 and \mathfrak{t}_2 respectively. Then there exist canonical isomorphisms*

$$\begin{aligned} \varphi &: \mathbb{C}\mathbb{F}(G_1, \mathfrak{t}_1) \otimes \mathbb{C}\mathbb{F}(G_2, \mathfrak{t}_2) \rightarrow \mathbb{C}\mathbb{F}(G_1 \sqcup G_2, \mathfrak{t}_1 \# \mathfrak{t}_2) \\ \varphi^{\natural} &: \mathbb{C}\mathbb{F}^{\natural}(G_1, \mathfrak{t}_1) \times \mathbb{C}\mathbb{F}^{\natural}(G_2, \mathfrak{t}_2) \rightarrow \mathbb{C}\mathbb{F}^{\natural}(G_1 \sqcup G_2, \mathfrak{t}_1 \# \mathfrak{t}_2). \end{aligned}$$

Furthermore if $h_{U,1}$ and $h_{U,2}$ are the height functions for (G_1, \mathfrak{t}_1) and (G_2, \mathfrak{t}_2) respectively then,

$$(4) \quad h_U(\varphi([K_1, E_1] \otimes [K_2, E_2])) = h_{U,1}([K_1, E_1]) + h_{U,2}([K_2, E_2])$$

Proof. Define

$$\varphi^\infty : \mathbb{C}\mathbb{F}^\infty(G_1, \mathfrak{t}_1) \otimes \mathbb{C}\mathbb{F}^\infty(G_2, \mathfrak{t}_2) \rightarrow \mathbb{C}\mathbb{F}^\infty(G_1 \sqcup G_2, \mathfrak{t}_1 \# \mathfrak{t}_2)$$

by

$$\varphi^\infty([K_1, E_1] \otimes [K_2, E_2]) := U^\zeta([K_1, K_2], E_1 \sqcup E_2).$$

This map is a bijection on the generating sets, and an inspection of the differential reveals it to be a chain map, so we will get desired map φ so long as equation (4) holds. This suggests a cellular homeomorphism φ^{\natural} which takes the points in $[K_1, E_1] \times [K_2, E_2]$ linearly to the corresponding point in $[(K_1, K_2), E_1 \sqcup E_2]$.

Furthermore, we have h_U satisfies equation (4) on the vertices, since the intersection form on $X_{G_1 \sqcup G_2}$ is the direct sum of the intersection forms on X_{G_1} and X_{G_2} . Now for $[(K_1, K_2), E_1 \sqcup E_2]$ we have that its vertices are (K'_1, K'_2) where K'_1 is a vertex of $[K_1, E_1]$ and K'_2 is a vertex of $[K_2, E_2]$. So,

$$\begin{aligned} h_U([(K_1, K_2), E_1 \sqcup E_2]) &= \min\{h_U((K'_1, K'_2)) \mid K'_1 \in [K_1, E_1], K'_2 \in [K_2, E_2]\} \\ &= \min\{h_{U,1}(K'_1) + h_{U,2}(K'_2) \mid K'_1 \in [K_1, E_1], K'_2 \in [K_2, E_2]\} \\ &= \min\{h_{U,1}(K'_1) \mid K'_1 \in [K_1, E_1]\} \\ &\quad + \min\{h_{U,2}(K'_2) \mid K'_2 \in [K_2, E_2]\} \\ &= h_{U,1}([K_1, E_1]) + h_{U,2}([K_2, E_2]) \end{aligned}$$

□

Remark 3.9. This definition of $\mathbb{C}\mathbb{F}(G, \mathfrak{t})$ predisposes lattice homology $\mathbb{H}\mathbb{F}(G, \mathfrak{t})$ to many of the formal properties of Heegaard Floer homology. It has an absolute \mathbb{Q} grading for torsion Spin^c structures with a relative \mathbb{Z} grading. Furthermore taking coefficients in $\mathbb{Z}[U, U^{-1}]$ is equivalent to letting every cube appear in every level of the filtration, and thus because \mathbb{R}^s is contractible we would have that $\mathbb{H}\mathbb{F}_0^\infty(G, \mathfrak{t}) \cong \mathbb{Z}[U, U^{-1}]$ and $\mathbb{H}\mathbb{F}_k^\infty(G, \mathfrak{t}) \cong 0$ for $k > 0$. The even and odd parts of $\mathbb{H}\mathbb{F}(G, \mathfrak{t})$ are respectively $\bigoplus_k \mathbb{H}\mathbb{F}_{2k}(G, \mathfrak{t})$ and $\bigoplus_k \mathbb{H}\mathbb{F}_{2k+1}(G, \mathfrak{t})$. Proposition 3.8 mirrors how taking connect sums of three-manifolds yields tensor products on the chain level for Heegaard Floer Homology.

We will now go through a collection of formulas from [21] which are useful in computation. The focus of these calculations is towards understanding $a_v[K, E]$ and $b_v[K, E]$, and they make use of the fact that these values only depend on h_U up to a constant that may depend on $[K, E]$. As such analyzing the behavior of $\frac{h_U(\cdot) - h_U(K)}{2}$ over the vertices of $[K, E]$, $[K, E]$ itself, plus the front and back faces of $[K, E]$ in a direction v yields lots of relevant information. We can then define the following values:

$$\begin{aligned} f([K, I]) &:= \frac{(\sum_{v \in I} K(v)) + (\sum_{v \in I} v)^2}{2} &= \frac{h_U(K + \sum_{v \in I} [v]) - h_U(K)}{2} \\ g([K, E]) &:= \min\{f([K, I]) : I \subseteq E\} &= \frac{h_U([K, E]) - h_U(K)}{2} \\ A_v[K, E] &:= \min\{f([K, I]) : I \subseteq E - \{v\}\} &= \frac{h_U([K, E - \{v\}]) - h_U(K)}{2} \\ B_v[K, E] &:= \min\{f([K, I]) : v \in I \subseteq E\} &= \frac{h_U([K + v, E - \{v\}]) - h_U(K)}{2}. \end{aligned}$$

The first two of these are called the G -weight of $[K, I]$ and the minimal G -weight of $[K, E]$ in [21]. From these, we can see that $a_v[K, E] = A_v[K, E] - g([K, E])$ and $b_v[K, E] = B_v[K, E] - g([K, E])$. We will define a new value Δ_v by

$$\Delta_v[K, E] := \frac{h_U([K + v, E - \{v\}]) - h_U([K, E - \{v\}])}{2},$$

which can be computed using $\Delta_v[K, E] = B_v[K, E] - A_v[K, E]$.

Finally, define a filtered chain map

$$J: \bigoplus_{\mathfrak{t} \in \text{Spin}^c(Y)} \mathbb{C}\mathbb{F}(G, \mathfrak{t}) \rightarrow \bigoplus_{\mathfrak{t} \in \text{Spin}^c(Y)} \mathbb{C}\mathbb{F}(G, \mathfrak{t})$$

by

$$J([K, E]) := \left[-K - \sum_{u \in E} u, E \right].$$

Observe that on the vertices $K \in \text{Char}(G)$, we have $J(K) = -K$. Because our height function is based on a quadratic form, $h_U(J(K)) = h_U(K)$. Since, $h_U([K, E])$ is calculated based on the value of h_U on the vertices the calculation is thus unchanged when considering $J([K, E])$. Thus, $h_U([K, E]) = h_U(J([K, E]))$, meaning there are no U powers needed in our definition. One can model J 's action on $\mathbb{C}\mathbb{F}^{\natural}(G, \mathfrak{t})$ by looking at an affine translation of negation acting on \mathbb{R}^s . This enables us to define a

$$J^{\natural} : \mathbb{C}\mathbb{F}^{\natural}(G, \mathfrak{t}) \rightarrow \mathbb{C}\mathbb{F}^{\natural}(G, \bar{\mathfrak{t}})$$

such that $(J^{\natural})_{\#} = J$. This construction gives the same map as ι on Heegaard Floer homology for almost rational graphs, which are graphs which can be made into L -spaces by lowering the weight on a single vertex [4].

3.3. Knot Lattice Homology: A Second Filtration. Let G_{v_0} be a plumbing graph representing a generalized algebraic knot in a rational homology sphere with an unweighted vertex v_0 , and we will define $G := G_{v_0} - v_0$ to talk about the graph representing the ambient three-manifold. Let \mathfrak{t} be a Spin^c structure on the plumbed three-manifold defined by G . Finally, let $\mathbb{C}\mathbb{F}\mathbb{K}(G_{v_0}, \mathfrak{t})$ be freely generated over $\mathbb{Z}[U, V]$ by all the cubes \mathcal{Q} from the orbit $\text{Char}(G, \mathfrak{t})$. As with lattice homology, we have a homological grading δ , where $\mathbb{C}\mathbb{F}\mathbb{K}_k(G_{v_0}, \mathfrak{t})$ is freely generated by the elements of \mathcal{Q}_k .

Recall from Section 2.1.3 that the vertex v_0 represents a disk in the plumbing resolution X , in particular the boundary connect sum of the fibers of vertices adjacent to v_0 . As a relative homology class, the disk v_0 can act on elements of $\text{Char}(G)$ as $K + v_0 := K + 2\text{PD}(v_0)$, though it will only preserve orbits $\text{Char}(G, \mathfrak{t})$ if the generalized algebraic knot was null-homologous in the ambient three-manifold. This action of v_0 on $\text{Char}(G)$ can extend to an action on the cubes of $\mathbb{C}\mathbb{F}(G)$ that translates the cubes in the direction given by v_0 , i.e. sending $[K, E]$ to $[K + v_0, E]$. Let h_U be defined as above ignoring the vertex v_0 , and define a second height function h_V on the cubes by $h_V([K, E]) := h_U([K + v_0, E])$.

Similar to with lattice homology, we can take the differential associated to the cubical decomposition of \mathbb{R}^s and weight the coefficients with U and V powers associated to the terms. We define

$$\begin{aligned} \partial[K, E] := & \sum_{v \in E} \varepsilon_{E,v} U^{a_v[K,E]} V^{c_v[K,E]} [K, E - \{v\}] \\ & - \sum_{v \in E} \varepsilon_{E,v} U^{b_v[K,E]} V^{d_v[K,E]} [K + v, E - \{v\}], \end{aligned}$$

where a_v and b_v are exactly as in Equations (2) and (3), while c_v and d_v are defined similarly but with h_V instead of h_U . In particular, $c_v[K, E] = a_v[K + v_0, E]$ and $d_v[K, E] = b_v[K + v_0, E]$. The same arguments from Subsection 3.2 ensure that a_v, b_v, c_v and d_v are all non-negative integers. Furthermore, each height function induces a Maslov grading $\text{gr}_U := |E| + h_U$ and $\text{gr}_V := |E| + h_V$ and together they induce an Alexander grading $A = \frac{\text{gr}_U - \text{gr}_V}{2} = \frac{h_U - h_V}{2}$.

Example 3.10. Figures 5 and 6 provide examples of this construction. Both are presented similarly to Figure 4 with one subfigure showing the corresponding ellipses and another showing the discretized version of the height function on the cubes themselves. However, this time there are two sets of ellipses, one in blue representing h_U and one in magenta representing h_V . These have been interlaced with transparency so that being more magenta signifies h_V being higher and being more blue signifies h_U being higher. Note that because our vertices are cohomology classes, but the arrangement of the integer lattice is based off of an action by the second homology, to calculate the translation associated to v_0 one looks at the dual basis to the basis given by the base surfaces. This can be calculated using the inverse of the matrix for the intersection form. Having multiple examples is useful in and of itself, but it will come up again in Section 4, where we will see how the choice of knot can affect our calculations.

Let

$$\mathbb{C}\text{FK}^\infty(G, \mathfrak{t}) := \mathbb{C}\text{FK}(G, \mathfrak{t}) \otimes_{\mathbb{Z}[U, V]} \mathbb{Z}[U, V, U^{-1}V^{-1}].$$

Then, as with lattice homology, when attempting to define a map on $\mathbb{C}\text{FK}$, we can first define bigraded $\mathbb{Z}[U, V]$ linear maps

$$\varphi^\infty : \mathbb{C}\text{FK}^\infty(G_1, \mathfrak{t}_1) \rightarrow \mathbb{C}\text{FK}^\infty(G_2, \mathfrak{t}_2).$$

Similar to in the lattice homology case if $mU^{\zeta_1}V^{\zeta_2}[K_2, E_2]$ appears in $\varphi^\infty([K_1, E_1])$ with $m \in \mathbb{Z}$ then

$$\begin{aligned} \zeta_1 &= \frac{h_U([K_2, E_2]) - h_U([K_1, E_1])}{2} \\ \zeta_2 &= \frac{h_V([K_2, E_2]) - h_V([K_1, E_1])}{2}. \end{aligned}$$

As before, to check that φ^∞ is a chain map it suffices to check over $\mathbb{Z}[U, V]/(U-1, V-1)$ coefficients, i.e. effectively ignoring the powers of U and V . The map φ^∞ will correspond to a map $\varphi : \mathbb{C}\text{FK}(G_1, \mathfrak{t}_1) \rightarrow \mathbb{C}\text{FK}(G_2, \mathfrak{t}_2)$ if and only if for every $[K_2, E_2]$ that has a nonzero coefficient in some $\varphi^\infty([K_1, E_1])$ we have that $h_U([K_2, E_2]) \geq h_U([K_1, E_1])$ and $h_V([K_2, E_2]) \geq h_V([K_1, E_1])$.

Further paralleling the discussion in Subsection 3.2, each height function independently gives us a filtration of superlevel sets, which are cubical subcomplexes. Considered together they form a double-filtration:

$$\mathcal{F}_{t_1, t_2} = \text{Span}\{[K, E] : h_U([K, E]) \geq t_1 \text{ and } h_V([K, E]) \geq t_2\}.$$

As such, the $\mathbb{Z}[U, V]$ module can be recovered as $\bigoplus_{t_1, t_2} \mathcal{F}_{t_1, t_2}$ where t_1 and t_2 are taken from the cosets of $2\mathbb{Z}$ in \mathbb{Q} that contain the image of h_U and h_V respectively. The action of U is the inclusion $\mathcal{F}_{t_1, t_2} \rightarrow \mathcal{F}_{t_1-2, t_2}$ while the action of V is the inclusion $\mathcal{F}_{t_1, t_2} \rightarrow \mathcal{F}_{t_1, t_2-2}$.

This construction suggests the following definition for a corresponding doubly-filtered topological space.

Definition 3.11. The *knot lattice space* $\mathbb{C}\text{FK}^\natural(G_{v_0}, \mathfrak{t})$ associated to a plumbing with unweighted vertex G_{v_0} and Spin^c structure \mathfrak{t} is Euclidean space with the cube decomposition above and the double filtration $\{\mathcal{F}_{t_1, t_2}\}$ induced by h_U and h_V .

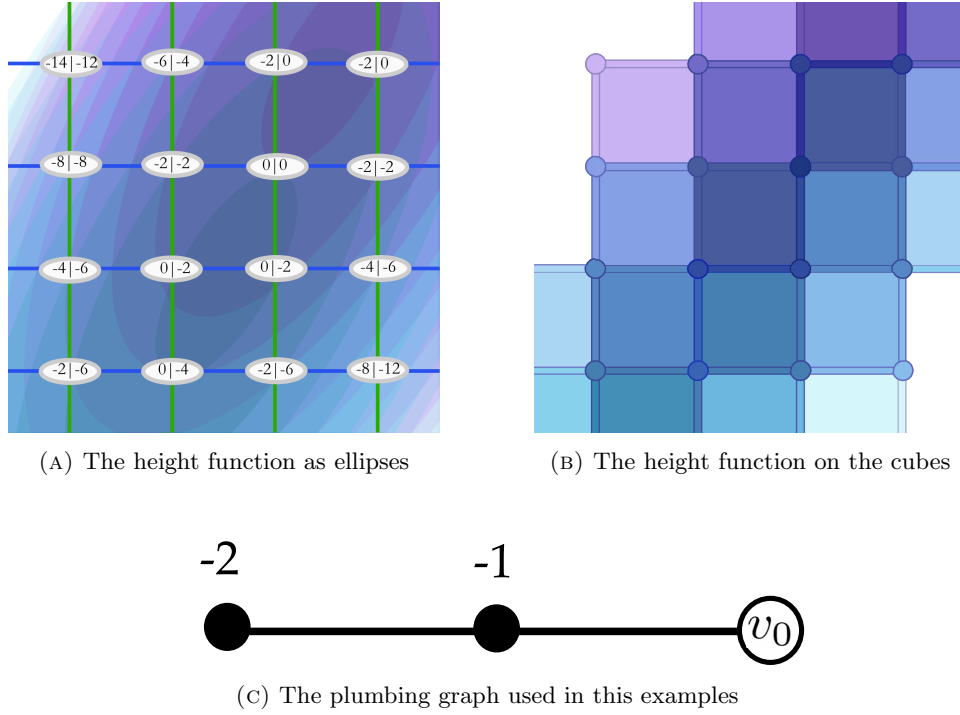

FIGURE 5. A figure illustrating an example of the computation of knot lattice homology. Figure 5c gives the plumbing and knot used for this example. Figure 5a shows both the original ellipses used to create this example with h_U in blue and the translated ellipses created using h_V in magenta. These are done with transparency so that darker ellipses have higher values on the height functions and more magenta means h_V is higher and more blue means h_U is higher. Inside the vertices of Figure 5a are the values (h_U, h_V) . Figure 5b gives the corresponding discretized height function on the cubes. Heights of less than -14 were rendered as white.

Many of the conventions mentioned in Subsection 3.2 carry over here as $\text{CFK}^{\natural}(G_{v_0}, \mathfrak{t})$ is $\text{CF}^{\natural}(G, \mathfrak{t})$ with another filtration added. For example, we can choose our coordinates to respect the action by the vertices, and we will denote the k -skeleton of $\text{CFK}^{\natural}(G_{v_0}, \mathfrak{t})$ as $\text{CFK}_k^{\natural}(G_{v_0}, \mathfrak{t})$.

The following proposition mirrors Proposition 3.8 in Subsection 3.2 and was also noticed by Ozsváth, Stipsicz, and Szabó in the chain complex setting [21].

Proposition 3.12. *Let G_{1,v_0} and G_{2,v_0} be negative definite graphs with an unweighted vertex, with Spin^c structures \mathfrak{t}_1 and \mathfrak{t}_2 respectively. Let $G_{1,v_0} \# G_{2,v_0}$ be the graph which is the disjoint union of the graphs merged at v_0 . Then there exist canonical isomorphisms*

$$\begin{aligned} \varphi: \text{CF}(G_{1,v_0}, \mathfrak{t}_1) \otimes \text{CF}(G_{2,v_0}, \mathfrak{t}_2) &\rightarrow \text{CF}(G_{1,v_0} \# G_{2,v_0}, \mathfrak{t}_1 \# \mathfrak{t}_2) \\ \varphi^{\natural}: \text{CF}^{\natural}(G_{1,v_0}, \mathfrak{t}_1) \times \text{CF}^{\natural}(G_{2,v_0}, \mathfrak{t}_2) &\rightarrow \text{CF}^{\natural}(G_{1,v_0} \# G_{2,v_0}, \mathfrak{t}_1 \# \mathfrak{t}_2). \end{aligned}$$

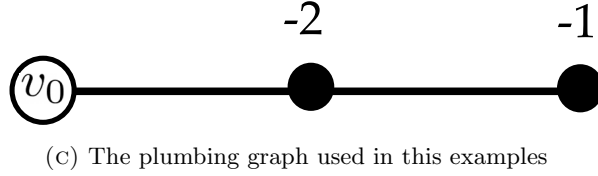
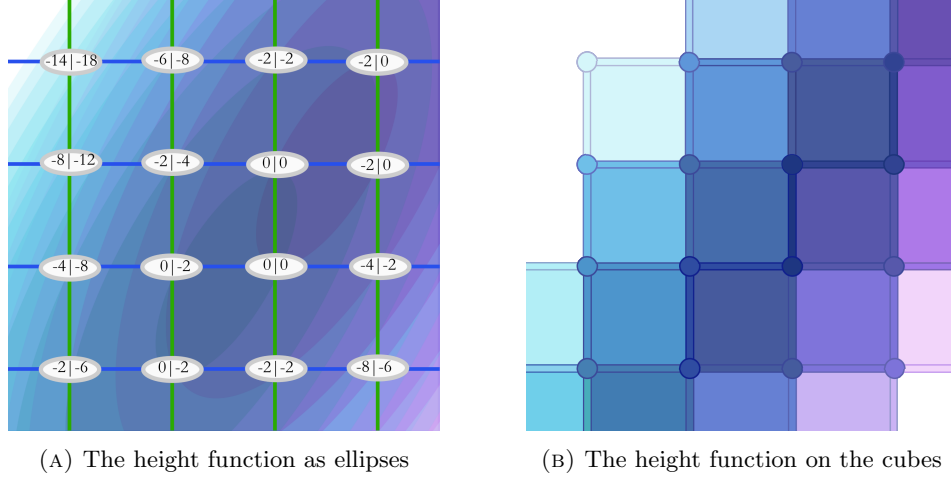

FIGURE 6. Another example of the double filtration for the knot lattice complex. This example has the same three-manifold as Figure 5 but use a different unweighted vertex, as shown in 6c. See Figure 5 for a discussion of how these figures were constructed

Furthermore if $h_{U,1}$ and $h_{V,1}$ are the height functions for (G_1, \mathfrak{t}_1) , while $h_{U,2}$, and $h_{V,2}$ are the height functions on (G_2, \mathfrak{t}_2) , then

$$(5) \quad h_U(\varphi([K_1, E_1] \otimes [K_2, E_2])) = h_{U,1}([K_1, E_1]) + h_{U,2}([K_2, E_2])$$

$$(6) \quad h_V(\varphi([K_1, E_1] \otimes [K_2, E_2])) = h_{V,1}([K_1, E_1]) + h_{V,2}([K_2, E_2])$$

Proof. The maps φ and φ^\sharp follow the same construction as in Proposition 3.8, and Equation (5) becomes Equation (4) proved in that context. What remains to be shown is Equation (6). If (K_1, K_2) is in $\text{Char}(G_{1,v_0} \# G_{2,v_0})$, then $(K_1, K_2) + v_0 = (K_1 + v_0, K_2 + v_0)$ where each v_0 is interpreted to be the unweighted vertex in the appropriate setting. Then for a given $[(K_1, K_2), E_1 \sqcup E_2]$ with E_1 a subset of the vertices of G_{1,v_0} and E_2 a subset of G_{2,v_0} ,

$$\begin{aligned} h_V([(K_1, K_2), E_1 \sqcup E_2]) &= h_U([(K_1, K_2) + v_0, E_1 \sqcup E_2]) \\ &= h_U([(K_1 + v_0, K_2 + v_0), E_1 \sqcup E_2]) \\ &= h_{U,1}([K_1 + v_0, E_1]) + h_{U,2}([K_2 + v_0, E_2]) \\ &= h_{V,1}([K_1, E_1]) + h_{V,2}([K_2, E_2]), \end{aligned}$$

which confirms equation (6). □

Note that by inverting one of U or V in $\mathbb{C}\mathbb{F}\mathbb{K}(G_{v_0}, \mathfrak{t})$, we back populate the corresponding filtration, giving the corresponding single filtration as discussed in Subsection 3.1. As such, that height function no longer has any effect on the homological calculations. Therefore, for each Alexander grading s , $\mathbb{C}\mathbb{F}\mathbb{K}_{\mathbb{Z}[U, V, V^{-1}]}(G_{v_0}, \mathfrak{t}, s) \cong \mathbb{C}\mathbb{F}(G, \mathfrak{t}, h_U)$, similar to in knot Floer homology. Using this identification, we get a bijection between Alexander grading preserving $\mathbb{Z}[U, V]$ linear maps on $\mathbb{C}\mathbb{F}\mathbb{K}_{\mathbb{Z}[U, V, V^{-1}]}(G_{v_0}, \mathfrak{t})$ with maps that are filtered by h_U but not necessarily h_V . In particular, this allows us to view J from Subsection 3.2 as the appropriate map in a complete package, and J^\natural as the corresponding realization in a complete homotopy package.

Finally define

$$J_{v_0} : \mathbb{C}\mathbb{F}\mathbb{K}(G_{v_0}, \mathfrak{t}) \rightarrow \mathbb{C}\mathbb{F}\mathbb{K}(G_{v_0}, \overline{\mathfrak{t} + \text{PD}(v_0)})$$

on the generators by

$$J_{v_0}([K, E]) = \left[-K - v_0 - \sum_{v \in E} v, E \right].$$

The map J_{v_0} can be thought of geometrically via negation and translation (potentially between orbits $\text{Char}(G, \mathfrak{t})$). Note that this can be realized in a continuous manner as

$$J_{v_0}^\natural : \mathbb{C}\mathbb{F}\mathbb{K}^\natural(G_{v_0}, \mathfrak{t}) \rightarrow \mathbb{C}\mathbb{F}\mathbb{K}^\natural(G_{v_0}, \overline{\mathfrak{t} + \text{PD}(v_0)}),$$

similar to J . We can check that J_{v_0} is skew $\mathbb{Z}[U, V]$ -linear by checking that it is skew filtered. Thus observe that

$$\begin{aligned} h_V(J_{v_0}([K, E])) &= h_V \left(\left[-K - v_0 - \sum_{v \in E} v, E \right] \right) \\ &= h_U \left(\left[-K - \sum_{v \in E} v, E \right] \right) \\ &= h_U(J[K, E]) \\ &= h_U([K, E]) \\ h_U(J_{v_0}([K, E])) &= h_U \left(\left[-K - v_0 - \sum_{v \in E} v, E \right] \right) \\ &= h_U(J([K + v_0, E])) \\ &= h_U([K + v_0, E]) \\ &= h_V([K, E]). \end{aligned}$$

Remark 3.13. In this framework the flip map corresponds to a skew $\mathbb{Z}[U, V]$ -linear map

$$\Gamma : \mathbb{C}\mathbb{F}\mathbb{K}(G, \mathfrak{t}) \otimes_{\mathbb{Z}[U, V]} \mathbb{Z}[U, U^{-1}, V] \rightarrow \mathbb{C}\mathbb{F}\mathbb{K}(G, \mathfrak{t}) \otimes_{\mathbb{Z}[U, V]} \mathbb{Z}[U, V, V^{-1}]$$

defined by $\Gamma([K, E]) = V^\zeta \cdot [K + v_0, E]$. This satisfies $h_V([K, E]) = h_U(\Gamma([K, E]))$ confirming that no U powers were needed in defining the function. We are not keeping track of this separately because, letting

$$J_{v_0}^\infty : \mathbb{C}\mathbb{F}\mathbb{K}(G, \mathfrak{t}) \otimes_{\mathbb{Z}[U, V]} \mathbb{Z}[U, U^{-1}, V] \rightarrow \mathbb{C}\mathbb{F}\mathbb{K}(G, \mathfrak{t}) \otimes_{\mathbb{Z}[U, V]} \mathbb{Z}[U, V, V^{-1}],$$

be the map induced by including J_{v_0} into the tensor product and skew-linearity in $\mathbb{Z}[U, V]$, we have that $\Gamma = J \circ J_{v_0}^\infty$.

The definitions below summarize the constructions above. Note that $\mathbb{C}\text{FK}^{\natural}(G_{v_0}, \mathfrak{t})$ contains both the information of the topological space and the double filtration.

Definition 3.14. The *complete knot lattice homology package* for the generalized algebraic knot (Y, K) is the complete package

$$\left(\bigoplus_{\mathfrak{t} \in \text{Spin}^c(Y)} \mathbb{C}\text{FK}(G_{v_0}, \mathfrak{t}), J_{v_0}, J \right),$$

while the *complete knot lattice homotopy package* for (Y, K) is the complete homotopy package

$$\left(\bigsqcup_{\mathfrak{t} \in \text{Spin}^c(Y)} \mathbb{C}\text{FK}^{\natural}(G_{v_0}, \mathfrak{t}), J_{v_0}^{\natural}, J^{\natural} \right).$$

We will now confirm that the formulation above and that given in [21] give the same result. To define the Alexander grading of an element $[K, E]$, the authors of [21] first consider a graph $G_{v_0}(m_0)$, where the vertex v_0 is given the weight m_0 . The value of m_0 will wash out in our calculations, but we will assume it is chosen so $G_{v_0}(m_0)$ is negative definite. This process caps off the disk v_0 to a sphere. Furthermore, G being negative definite means that $\text{PD}(v_0) = \text{PD}(\Sigma_0)$, where Σ_0 is a closed surface in the plumbing associated to G potentially with rational coefficients. Consider then $\Sigma := v_0 - \Sigma_0$ in the plumbing associated to $G_{v_0}(m_0)$. We will also consider an extension L of K in $G_{v_0}(m_0)$ such that

$$L(v_0) = -m_0 + 2g[K, E] - 2g[K + v_0, E].$$

The Alexander grading is then defined to be

$$A([K, E]) = \frac{L(\Sigma) + \Sigma^2}{2}.$$

To show that this gives the same result as our own presentation of knot lattice homology, we only need to show that this definition of the Alexander grading yields the same result as looking at half the difference of the two Maslov gradings. In particular, letting G here also represent the adjacency matrix of the graph G and v_0^* represent $\text{PD}[v_0]$ in $H^2(X; \mathbb{Z})$, we have that $G^{-1}v_0 = \Sigma_0$, and

$$\Sigma^2 = m_0 - 2\langle v_0, G^{-1}v_0^* \rangle + (G^{-1}v_0^*)^2 = m_0 - (G^{-1}v_0^*)^2.$$

Therefore,

$$\begin{aligned}
A[K, E] &= \frac{L_{[K, E]}(\Sigma) + \Sigma^2}{2} \\
&= \frac{L_{[K, E]}(v_0) - L_{[K, E]}(G^{-1}v_0^*) + m_0 - (G^{-1}v_0^*)^2}{2} \\
&= \frac{g[K, E] - g[K + v_0, E] - K(G^{-1}v_0^*) - (G^{-1}v_0^*)^2}{2} \\
&= \frac{g[K, E] - g[K + v_0, E] - \langle v_0^*, K \rangle_{G^{-1}} - \langle v_0^*, v_0^* \rangle_{G^{-1}}^2}{2} \\
&= \frac{g[K, E] - g[K + v_0, E]}{2} - \frac{K^2 - K^2 - 4\langle v_0^*, K \rangle_{G^{-1}} - 4\langle v_0^*, v_0^* \rangle_{G^{-1}}}{8} \\
&= \frac{1}{2} \left(\frac{K^2 + s}{4} + g[K, E] - \frac{(K + v_0)^2 + s}{4} - g[K + v_0, E] \right) \\
&= \frac{1}{2} (h_U[K, E] - h_V([K, E])).
\end{aligned}$$

4. CONTRACTION MAPS

4.1. Contractions: Definition and Existence. Before proving invariance, we will generalize the construction of a contraction as defined in an appendix of [20]. Contractions are endomorphisms of $\mathbb{C}\mathbb{F}(G, \mathfrak{t})$ or $\mathbb{C}\mathbb{F}\mathbb{K}(G_{v_0}, \mathfrak{t})$ which are chain homotopic to the identity and morally serve to collapse one of the dimensions of underlying topological space for $\mathbb{C}\mathbb{F}^{\natural}(G, \mathfrak{t})$ or $\mathbb{C}\mathbb{F}\mathbb{K}^{\natural}(G_{v_0}, \mathfrak{t})$, which is useful because blowing up a graph will necessarily add a new vertex and thus a new potential dimension for our cubes. This idea builds off of the (topological) deformation retraction mentioned by Némethi to prove the invariance of lattice homology, and the work of Ozsváth, Stipsicz, and Szabó provides an explicit algebraic equivalence in the case of blowing up a vertex [16, 21]. In the knot setting, Ozsváth, Stipsicz, and Szabó then show their contraction is filtered with respect to the Alexander filtration in the case of blowing up an edge connecting v_0 to the rest of the graph [21].

We will focus on defining a contraction algebraically first; then in Subsection 4.2, we will provide continuous homotopies that realize the algebraic definitions. We will still introduce the guiding geometric ideas with the algebra, since those ideas will help while wading through the algebraic details, but until Subsection 4.2 we will hold off on claims that these ideas can be realized continuously.

In order to collapse in the direction associated to a given a vertex v in a way that is filtered, we need to know how the height function changes in that direction. More technically, the orbits of the action of v on \mathcal{Q} can each be affinely modeled on \mathbb{Z} . Because h_U comes from a quadratic form when restricted to the orbit of a point K , we have that h_U is a parabola on such an orbit, which is a strictly concave function. Lemma 4.1 confirms strict concavity of h_U over all v -orbits for cubes $[K, E]$. We will want to send every element of \mathcal{Q} to an element in its v orbit that maximizes h_U , though doing so naively may not produce a chain map let alone one chain homotopic to the identity. The definitions that follow achieve a similar result while providing a chain map chain homotopic to the identity.

For the rest of this section, assume that v is the vertex along whose direction we would like to contract. Following the construction of Ozsváth, Stipsicz, and

Szabó, the definition of a contraction will follow several steps, outlined here [21]. First we define a *step in a contraction homotopy* H_0 , which is a chain homotopy constructed from our choice of maxima. This then induces a *step in a contraction* C_0 when paired with the identity map, i.e. C_0 is chain homotopic to id via H_0 . We have that C_0 should move cubes one step towards these maxima, and so iterating C_0 then produces a *contraction* C_v , which takes cubes to these maxima but with enough connective pieces to be a chain map. We have that C_v is chain homotopic to id via a *contraction homotopy* H_v .

These terms will be defined in more detail as they come up, but there are some things we will expect based on the geometric picture. For example if $v \in E$, we expect the cube $[K, E]$ to be flattened by the homotopy and thus $H_v[K, E] = 0 = H_0[K, E]$. Furthermore, if $v \notin E$ we expect $H_0[K, E]$ to represent the space through which $[K, E]$ needs to move to get to $C_0[K, E]$, and thus we would expect $H_0[K, E]$ to be one of the two cubes that has $[K, E]$ as a front or back face in direction v .

The following lemma confirms that the height function on a v orbit is indeed concave.

Lemma 4.1. *Given a negative-definite forest G , a vertex v of G and a cube $[K, E] \in \mathcal{Q}$, then*

$$h_U([K, E]) > \frac{h_U([K + v, E]) + h_U([K - v, E])}{2}.$$

Proof. We start with the case of vertices, i.e. $E = \emptyset$. For any $K \in \text{Char}(G)$, the function $f_{K,v}: \mathbb{R} \rightarrow \mathbb{R}$ given by $f_{K,v}(t) := \frac{K^2 + s}{4} + tK(v) + t^2v^2$ is a concave function, since it is a parabola with negative leading coefficient. Observe that $h_U(K + iv) = f_{K,v}(i)$. For an arbitrary choice of E , by definition,

$$h_U([K + iv, E]) = \min\{f_{K',v}(i) : K' \text{ is a vertex of } [K, E]\},$$

and because minimizing over strictly concave functions gives a strictly concave function, the result follows in this case. \square

Note that the previous lemma guarantees that each v orbit in \mathcal{Q} will obtain a maximum value for h_U . In order to formally define a step in a contraction homotopy, we will first formalize the notation we mean when we talk about choosing our maxima.

Definition 4.2. A *choice of maxima in the direction v* is a function $m: \mathcal{Q} \rightarrow \mathcal{Q}$ such that if $v \notin E$ then $m([K, E])$ represents an element that maximizes h_U in the v -orbit of $[K, E]$. We require that m depends only on the v -orbit of $[K, E]$, and to pin down the behavior when $v \in E$, we require that $m([K, E]) = m([K, E - \{v\}])$. The corresponding *distance to maximum* function $\tilde{m}: \mathcal{Q} \rightarrow \mathbb{Z}$ has $\tilde{m}([K, E]) = i$ if $[K + iv, E] = m([K, E])$.

Remark 4.3. The requirement that $m([K, E]) = m([K, E - \{v\}])$ will not be strictly needed in Subsections 4.1 and 4.3 as we will only need to reference it when $v \notin E$. However, when we try to realize this idea topologically in Subsection 4.2 the \mathbb{Z} -action of v becomes an \mathbb{R} -action, and we will want both that the equivalent function to m exists for all points in those orbits and for that m to be determined by the orbit as an \mathbb{R} action. As such, while not strictly needed it makes sense to include a corresponding condition here.

Lemma 4.4. *Let m be a choice of maxima in direction v , and let $[K, E] \in \mathcal{Q}$ with $v \notin E$. If $\tilde{m}([K, E]) > 0$, $h_U([K, E \cup \{v\}]) = h_U([K, E])$, and if $\tilde{m}([K, E]) < 0$ then $h_U([K - v, E \cup \{v\}]) = h_U([K, E])$.*

Proof. Suppose without loss of generality that $v \notin E$ and $\tilde{m}([K, E]) > 0$. We can inductively show that

$$h_U(m([K, E]) - iv) - h_U(m([K, E]) - (i + 1)v) \geq 0$$

for all $i \geq 0$ including when $i = \tilde{m}([K, E]) - 1$. Because $m([K, E])$ maximizes h_U in its v orbit we have that

$$h_U(m([K, E])) - h_U(m([K, E]) - v) \geq 0,$$

covering the base case. Lemma 4.1 allows us to argue that

$$\begin{aligned} h_U(m([K, E]) - (i + 1)v) - h_U(m([K, E]) - (i + 2)v) &\geq \\ h_U(m([K, E]) - iv) - h_U(m([K, E]) - (i + 1)v), & \end{aligned}$$

for all i thus ensuring the inductive step holds. As such, we have that $h_U([K + v, E]) \geq h_U([K, E])$ as needed for $h_U([K, E \cup \{v\}]) = h_U([K, E])$. \square

Definition 4.5. Given a choice of maxima m , a $\mathbb{Z}[U]$ -linear degree 1 function $H_0 : \mathbb{C}\mathbb{F}^-(G, \mathfrak{t}) \rightarrow \mathbb{C}\mathbb{F}^-(G, \mathfrak{t})$ is the corresponding step in a contraction homotopy if

$$H_0[K, E] = \begin{cases} 0 & v \in E \text{ or } \tilde{m}([K, E]) = 0 \\ -\varepsilon_{E \cup v, v}[K, E \cup v] & v \notin E \text{ and } \tilde{m}([K, E]) > 0 \\ \varepsilon_{E \cup v, v}[K - v, E \cup v] & v \notin E \text{ and } \tilde{m}([K, E]) < 0, \end{cases}$$

A function $H_0 : \mathbb{C}\mathbb{F}^-(G, \mathfrak{t}) \rightarrow \mathbb{C}\mathbb{F}^-(G, \mathfrak{t})$ is a step in a contraction homotopy if it corresponds to some choice of maxima m . The corresponding step in a contraction $C_0 : \mathbb{C}\mathbb{F}^-(G, \mathfrak{t}) \rightarrow \mathbb{C}\mathbb{F}^-(G, \mathfrak{t})$ is defined as $C_0 := \text{id} + H_0\partial + \partial H_0$.

Note that a step in a contraction will exist for every choice of maximums, and since choices of maximums are guaranteed to exist, steps in contractions are guaranteed to exist as well. Furthermore, note that for $[K, E] \in \mathcal{Q}$ with $v \notin E$ and $\tilde{m}([K, E]) \neq 0$, the coefficient of $[K, E]$ in $\partial H_0[K, E]$ is designed to cancel with $[K, E]$, leaving the coefficient of $[K, E]$ in $C_0[K, E]$ to be 0.

Example 4.6. Figure 7 helps visualize what a contraction with respect to v_1 should look like in the context of the example from Figure 4. Each cube supported in the v_1 direction has an up arrow, down arrow, or question mark: up arrows indicate that the maximum in that column must be above that cube, down arrows that the maximum must be below that cube, and question marks reference that the front or back face of that cube could be the chosen maximum. In particular then, down arrows mean that $a_{v_1}[K, E] > 0$, up arrows that $b_{v_1}[K, E] > 0$, and question marks that $a_{v_1}[K, E] = 0 = b_{v_1}[K, E]$. Note then that the horizontal edge of height zero is the maximum of its column no matter what, but in the column to its right there is a choice to be made.

A particular contraction would be achieved by converting each of the question marks to up or down arrows as a part of making a choice of maxima. As an example of how this translates to C_0 consider the characteristic cohomology class K_0 , which represents the upper right height 0 vertex. If all of the question marks became

down arrows we would have that $[K_0, \{v_2\}]$, $K_0 - v_1$, and $K_0 + v_2$ are the maxima of their respective columns. In that case, one can check that

$$\begin{aligned} C_0([K_0 - v_1, \{v_2\}]) &= U[K_0, \{v_2\}] + U^2[K_0 - v_1, \{v_1\}] \\ C_0([K_0, \{v_2\}]) &= [K_0, \{v_2\}] + U[K_0 - v_1, \{v_1\}] \\ C_0([K_0 + v_1, \{v_2\}]) &= [K_0, \{v_2\}]. \end{aligned}$$

If all of the question marks became up arrows, we would have that $[K_0 + v_1, \{v_2\}]$, K_0 , and $K_0 + v_1 + v_2$ are the maxima in their respective columns, and one can confirm that

$$\begin{aligned} C_0([K_0 - v_1, \{v_2\}]) &= U[K_0, \{v_2\}] \\ C_0([K_0, \{v_2\}]) &= [K_0, \{v_1\}] + [K_0 + v_1, \{v_2\}] \\ &= C_0([K_0 + v_1, \{v_2\}]). \end{aligned}$$

In both cases one should note that applying C_0 again to $C_0[K_0, \{v_2\}]$ changes nothing, while the other elements in the same v_1 orbit move closer to $[K_0, \{v_2\}]$. This hints at C_0^n stabilizing as proven in Lemma 4.7.

Lemma 4.7. *Let G be a negative definite forest, v be a vertex of G , m a choice of maximums in direction v , and let C_0 be the corresponding step in a contraction homotopy. Given any $[K, E] \in \mathcal{Q}$, we have that $C_0^n([K, E])$ eventually stabilizes.*

Proof. Let $[K, E]$ be a particular cube and to conserve space let $i_0 = \tilde{m}([K, E])$. Then, define $H_0^n : \mathbb{C}\mathbb{F}(G, \mathfrak{t}) \rightarrow \mathbb{C}\mathbb{F}(G, \mathfrak{t})$ by

$$H_0^n([K, E]) := \begin{cases} -\varepsilon_{E \cup \{v\}, v} \sum_{i=0}^{\min(n-1, i_0-1)} U^{\zeta_i} [K + iv, E \cup \{v\}] & v \notin E \text{ and } i_0 \geq 0 \\ \varepsilon_{E \cup \{v\}, v} \sum_{i=1}^{\min(n, -i_0)} U^{\zeta_i} [K - iv, E \cup \{v\}] & v \notin E \text{ and } i_0 < 0 \\ 0 & v \in E, \end{cases}$$

where the U^{ζ_i} are determined by H_0 having degree 1 with respect to the Maslov grading. Note we are not claiming that H_0^n is H_0 applied n times, but we will inductively show that $C_0^n = \text{id} + \partial H_0^n + H_0^n \partial$. As a base case one when $n = 0$, one can verify that $H_0^0 = 0$, so

$$\text{id} = C_0^0 = \text{id} + \partial H_0^0 + H_0^0 \partial = \text{id}.$$

We will first prove the lemma in the case where $v \notin E$, though we will need the following notation to help us. Given $u \in E$,

$$\begin{aligned} \heartsuit_n &= \begin{cases} U^{\zeta_{\heartsuit, n}} [K + \min(n, i_0)v, E] & i_0 \geq 0 \\ U^{\zeta_{\heartsuit, n}} [K + \max(-n, i_0)v, E] & i_0 < 0 \end{cases} \\ \spadesuit_{n, u, 0} &= \begin{cases} \sum_{i=0}^{\min(n-1, i_0-1)} -\varepsilon_{E \cup \{v\}, v} U^{\lambda_{i, 0}} [K + iv, E \cup \{v\} - \{u\}] & i_0 \geq 0 \\ \sum_{i=1}^{\min(n, -i_0)} \varepsilon_{E \cup \{v\}, v} U^{\lambda_{i, 0}} [K - iv, E \cup \{v\} - \{u\}] & i_0 < 0 \end{cases} \\ \spadesuit_{n, u, 1} &= \begin{cases} \sum_{i=0}^{\min(n-1, i_0-1)} -\varepsilon_{E \cup \{v\}, v} U^{\lambda_{i, 1}} [K + iv + u, E \cup \{v\} - \{u\}] & i_0 \geq 0 \\ \sum_{i=1}^{\min(n, -i_0)} \varepsilon_{E \cup \{v\}, v} U^{\lambda_{i, 1}} [K - iv + u, E \cup \{v\} - \{u\}] & i_0 < 0 \end{cases} \\ \clubsuit_n &= \sum_{u \in E} \varepsilon_{E \cup \{v\}, u} (\spadesuit_{n, u, 0} - \spadesuit_{n, u, 1}). \end{aligned}$$

The U powers are determined to make these functions preserve the Maslov grading. Note then that $\heartsuit_n + \clubsuit_n = \text{id} + \partial H_0^n$, so our claim then becomes that $C_0^n([K, E]) =$

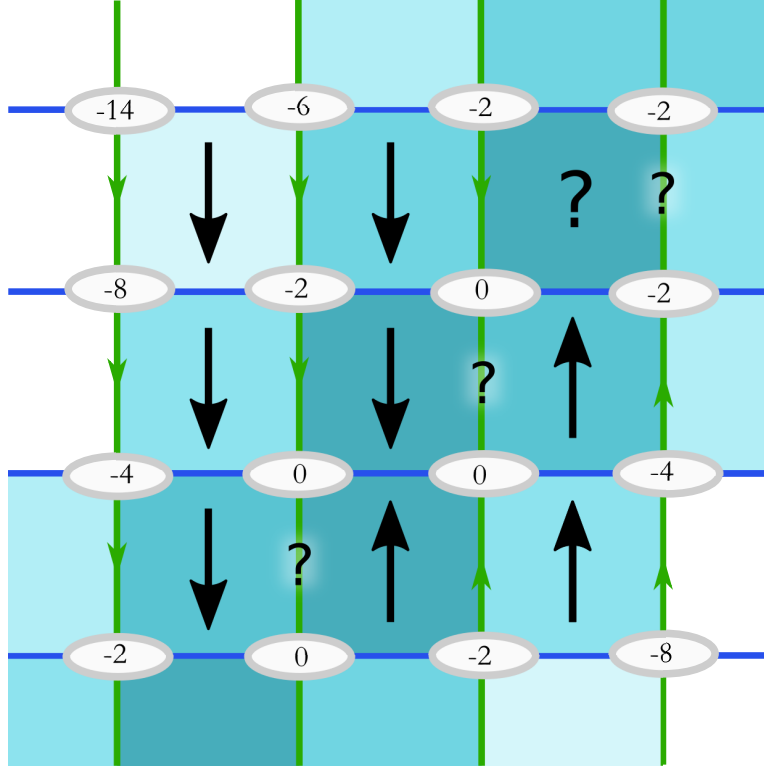

FIGURE 7. An visualization of a contraction with respect to the -1 weighted vertex in Subfigure 4c, which we will call e . Here a downward arrow on a cube signals that H_0 sends the back face of that cube to that cube, while an upward arrow signals that H_0 sends the front face of that cube to that cube. Question marks signal where either choice would yield a contraction.

$\heartsuit_n + \spadesuit_n + H_0^n \partial[K, E]$. Assume as an inductive hypothesis that this holds for some n , and we will show that $C_0^{n+1}([K, E])$ has the same form. Here \spadesuit_n is the portion of ∂H_0 that is supported in the v direction and \heartsuit represents the portion of C_0^n that is moving towards the maximum. Observe that

$$\begin{aligned} \partial H_0 \heartsuit_n &= \heartsuit_{n+1} - \heartsuit_n + \spadesuit_{n+1} - \spadesuit_n \\ H_0(\spadesuit_n) &= 0 \\ H_0 \circ H_0^n &= 0 \\ H_0 \partial \spadesuit_n &= H_0 \partial[K, E] - H_0 \partial \heartsuit_n. \end{aligned}$$

We also have that the portion of $\partial H_0^n \partial[K, E]$ not supported in the v direction consists of $-\partial[K, E]$ and generators that act similarly to \heartsuit_n but for the individual cubes that make up $\partial[K, E]$. So,

$$H_0 \partial H_0^n \partial[K, E] = H_0^{n+1} \partial[K, E] - H_0^n \partial[K, E] - H_0 \partial[K, E],$$

As such

$$\begin{aligned}
C_0^{n+1}([K, E]) &= C_0(\heartsuit_n + \spadesuit_n + H_0^n \partial[K, E]) \\
&= \heartsuit_n + \spadesuit_n + H_0^n \partial[K, E] \\
&\quad + \partial H_0(\heartsuit_n + \spadesuit_n + H_0^n \partial[K, E]) \\
&\quad + H_0 \partial(\heartsuit_n + \spadesuit_n + H_0^n \partial[K, E]) \\
&= \heartsuit_n + \spadesuit_n + H_0^n \partial[K, E] \\
&\quad + \heartsuit_{n+1} - \heartsuit_n + \spadesuit_{n+1} - \spadesuit_n \\
&\quad + H_0 \partial \heartsuit_n + H_0 \partial[K, E] - H_0 \partial \heartsuit_n \\
&\quad + H_0^{n+1} \partial[K, E] - H_0^n \partial[K, E] - H_0 \partial[K, E] \\
&= \heartsuit_{n+1} + \spadesuit_{n+1} + H_0^{n+1} \partial[K, E],
\end{aligned}$$

as needed.

To show that C_0^n eventually stabilizes, let N be the maximum of $|\tilde{m}|$ over $[K, E]$ and its faces. Then C_0^n stabilizes with $n \geq N$.

Now suppose that $v \in E$, and for notational simplicity let $\tilde{m}([K, E - \{v\}]) = i_0$, which we will assume without loss of generality is positive. The inductive hypothesis gives that

$$\begin{aligned}
C_0^n([K, E]) &= [K, E] + \partial H_0^n [K, E] + H_0^n \partial[K, E] \\
&= [K, E] + H_0^n (\varepsilon_{E,v} (U^{a_v [K, E]} [K, E - v] + U^{b_v [K, E]} [K + v, E - \{v\}])) \\
&= [K, E] - \varepsilon_{E,v}^2 \left(\sum_{i=0}^{\min(n-1, i_0-1)} U^{\zeta_i} [K + v, E] - \sum_{i=1}^{\min(n, i_0-1)} U^{\zeta_i} [K + iv, E] \right) \\
&= \begin{cases} U^{\zeta_n} [K + nv, E] & n < i_0 \\ 0 & n \geq i_0 \end{cases}
\end{aligned}$$

If $n \geq i_0$, then the inductive step is immediate, so assume $n < i_0$,

$$\begin{aligned}
C_0^{n+1}([K, E]) &= C_0(U^{\zeta_n} [K + nv, E]) \\
&= U^{\zeta_n} [K + nv, E] + \partial H_0(U^{\zeta_n} [K + n[v], E]) + H_0 \partial(U^{\zeta_n} [K + nv, E]) \\
&= U^{\zeta_n} [K + nv, E] + \varepsilon_{E,v} H_0(U^{\zeta_n + a_v [K + nv, E - \{v\}]} [K + nv, E - \{v\}]) \\
&\quad - U^{\zeta_n + b_v [K + nv, E - \{v\}]} [K + (n+1)v, E - \{v\}] \\
&= -\varepsilon_{E,v} U^{\zeta_{n+1}} H_0([K + (n+1)v, E - \{v\}]).
\end{aligned}$$

If $n+1$, then $U^{\zeta_{n+1}} H_0([K + (n+1)v, E - \{v\}])$ is 0 as needed, and otherwise

$$-\varepsilon_{E,v} U^{\zeta_{n+1}} H_0([K + (n+1)v, E - v]) = U^{\zeta_{n+1}} [K + (n+1)v, E]$$

as needed. To get C_0^n stabilizing in this case, take $n \geq i_0$. \square

We now define C_v , the corresponding contraction with respect to v , to evaluate to the value on which $C_0^n([K, E])$ stabilizes. Letting

$$H_v[K, E] = \begin{cases} -\varepsilon_{E \cup \{v\}, v} \sum_{i=0}^{\tilde{m}([K, E])-1} [K + i[v], E \cup \{v\}] & v \notin E \text{ and } i_0 \geq 0 \\ \varepsilon_{E \cup \{v\}, v} \sum_{i=1}^{\tilde{m}([K, E])} [K - iv, E \cup \{v\}] & v \notin E \text{ and } i_0 < 0 \\ 0 & v \in E, \end{cases}$$

it follows that $C_v = \text{id} + \partial H_v + H_v \partial$. We define H_0 and C_0 first because, for example, it will be easier to check that H_0 can be defined on $\text{CFK}(G_{v_0}, \mathfrak{t})$ and not just $\text{CFK}^\infty(G_{v_0}, \mathfrak{t})$ than checking the same for H_v .

Furthermore, the proof of Lemma 4.18 in Subsection 4.2 implies that not only does C_0^n stabilize to a function C_v but up to a power of U the value of $C_v([K, E])$ depends only on the v orbit of the cube $[K, E]$. For $v \in E$ his value will be 0, and for $v \notin E$ this value will be $m([K, E])$ plus cubes connecting $m([K, E])$ with $m([K', E'])$ where $[K', E']$ appears in $\partial[K, E]$. So, if all the question marks become down arrows in Figure 7 then

$$C_{v_1}([K_0 + mv_1, \{v_2\}]) = U^\zeta([K_0, \{v_2\}] + U[K_0 - v_1, \{v_1\}])$$

for all $m \in \mathbb{Z}$, and if all the question marks become up arrows in Figure 7 then

$$C_{v_1}([K_0 + mv_1, \{v_2\}]) = U^\zeta([K_0, \{v_1\}] + [K_0 + v_1, \{v_2\}])$$

for all $m \in \mathbb{Z}$.

We will now shift from considering $\text{CF}(G, \mathfrak{t})$ to $\text{CFK}(G_{v_0}, \mathfrak{t})$. The previous contractions can be defined on $\text{CFK}^\infty(G_{v_0}, \mathfrak{t})$ by adding V powers as appropriate; however, we will show that there exist choices of maximum which provide maps on $\text{CFK}(G_{v_0}, \mathfrak{t})$, i.e. all of the corresponding V powers will be non-negative.

Definition 4.8. Let v_0 be an unweighted vertex representing a knot in a negative-definite forest G . A choice of maximums is said to be *tuned to v_0* if for all cubes $[K, E]$ with $v \notin E$ $m([K, E])$ maximizes h_V among the set of elements in $[K, E]$'s v -orbit that maximize h_U . We will say that a bigraded contraction

$$C_v^{v_0} : \text{CFK}^\infty(G_{v_0}, \mathfrak{t}) \rightarrow \text{CFK}^\infty(G_{v_0}, \mathfrak{t})$$

is *tuned to v_0* if its step in a contraction homotopy is created using a choice of maxima that is tuned to v_0 .

The idea here is that when the decision of which direction the homotopy should take $[K, E]$ cannot be made by h_U , we then check h_V to see if that can make the decision for us. This is equivalent to keeping all of the arrows from Figure 7 but using h_V in determining what should happen at the question marks.

Remark 4.9. Note that input from the knot is needed, even in the case such as in Figure 7 where the vertex being contracted comes from a blow-up. Checking Figure 5, we would have that the upper right question marks need to become up arrows, but checking Figure 6 we would have that the upper right question marks need to become down arrows. The chain homotopy provided by Jackson [10, Lemma 2.5] does not depend on the choice of unweighted vertex and would not be doubly filtered for the example in Figure 6.

The following lemma shows that the shifted filtration is close to the original, at least in determining where maxima should be. In particular the lemma implies that if there is a strict inequality between the height of two opposing faces of a cube, then for the translated height function there will at still be a (potentially non-strict) inequality. This will be needed in proving Proposition 4.11 which says that contractions tuned to unweighted vertices are doubly filtered.

Lemma 4.10. *Let G_{v_0} be a negative definite graph with unweighted vertex v_0 and let b_v be some weighted vertex of G_{v_0} . If $b_v[K, E] > 0$ then $c_v[K, E] = 0$. Similarly, if $a_v[K, E] > 0$ then $d_v[K + v_0, E] = 0$*

Proof. First, we can use Proposition 3.12 and the definition of the boundary map on a tensor product to reduce to the case where v_0 is a leaf. We will without loss of generality consider the case where $b_v[K, E] > 0$, thus implying that $B_v[K, E] > A_v[K, E]$. Note that $c_v[K, E] = a_v[K + v_0, E]$, so we wish to show that $B_V[K + v_0, E] \geq A_v[K + v_0, E]$. For every $I \subset E \cup \{v\}$, let $x_I = \sum_{w \in I} w$. If $u \in I$, where u is the vertex to which v_0 is adjacent, then

$$\begin{aligned} f([K + v_0, I]) &= \frac{(K + v_0)(x_I) + x_I^2}{2} \\ &= \frac{K(x_{I \setminus u}) + K(u) + 2 + x_I^2}{2} \\ &= f([K, I]) + 1, \end{aligned}$$

and if $u \notin I$ then

$$\begin{aligned} f([K + v_0, I]) &= \frac{(K + v_0)(x_I) + x_I^2}{2} \\ &= \frac{K(x_I) + x_I^2}{2} \\ &= f([K, I]), \end{aligned}$$

Therefore for any vertex $K + x_I$ in $[K, E]$ we have that

$$h_U(K + x_I) - h_U(K) = h_V(K + x_I) - h_V(K) + \varepsilon,$$

where $\varepsilon \in \{0, 1\}$.

As such

$$\begin{aligned} h_V[K, E - \{v\}] - h_V(K) &= h_U([K, E - \{v\}]) - h_U(K) + \alpha \\ h_V([K + v, E - \{v\}]) - h_V(K) &= h_U([K + v, E - \{v\}]) - h_U(K) + \beta, \end{aligned}$$

where $\alpha, \beta \in \{0, 1\}$ depending on if the minimizing values of $f([K, I])$ necessarily had $u \in I$ or not. Hence, $\Delta_v[K + v_0, E] \geq \Delta_v[K, E] - 1 \geq 0$, and thus $c_v[K, E] = 0$. \square

Proposition 4.11. *If $C_v^{v_0}$ is a contraction with respect to v tuned to v_0 , then $C_v^{v_0}$ can be viewed as an endomorphism of $\mathbb{C}\text{FK}(G_{v_0}, \mathfrak{t})$ which is chain-homotopy equivalent to id.*

Proof. Note that $C_v^{v_0}$ is an iterated version of $C_0^{v_0}$, which itself is equal to $\text{id} + H_0\partial + \partial H_0$. Since, id and ∂ are already exist on the level of $\mathbb{C}\text{FK}(G_{v_0}, \mathfrak{t})$, we only need to check that H_0 does as well. By construction it is filtered with respect to h_U , so we can focus on checking that it is filtered with respect to h_V , i.e. $h_V(H_0[K, E]) \geq h_V([K, E])$ for all $[K, E] \in \mathcal{Q}$.

The inequality is automatically satisfied if $v \in E$ or $\tilde{m}([K, E]) = 0$ since then $H_0[K, E] = 0$, so we will now assume that $v \notin E$ and $\tilde{m}([K, E]) \neq 0$. If $\tilde{m}([K, E]) > 0$ and $h_U([K + v, E]) > h_U([K, E])$ then $b_v[K, E \cup \{v\}] > 0$ and Lemma 4.10 ensures that $c_v[K, E \cup \{v\}] = 0$, i.e. that $h_V([K + v, E]) \geq h_V([K, E])$ and

$$h_V(H_0[K, E]) = h_V([K, E \cup \{v\}]) = h_V([K, E]).$$

If $\tilde{m}([K, E]) < 0$ and $h_U([K - v, E]) > h_U([K, E])$ then $a_v[K, E \cup \{v\}] > 0$ and similar to the case above Lemma 4.10 ensures that

$$h_V(H_0[K, E]) = h_V([K - v, E \cup \{v\}]) = h_V([K, E]).$$

Now we only need to check that H_0 is filtered if $H_0[K, E] = -\epsilon_{E \cup v, v}[K, E \cup v]$ and $h_U([K, E]) = h_U([K + v, E])$ or if $H_0[K, E] = \epsilon_{E \cup v, v}[K - v, E]$ and $h_U([K, E]) = h_U([K - v, E])$. However, in these cases, Lemma 4.1 ensures that $[K, E]$ actually maximized h_U in its v -orbit, and in fact that the v -orbit for $[K, E]$ had multiple maximizing elements to choose from. Thus the fact that we chose $m([K, E])$ to maximize h_V among the multiple maximizing elements for h_U ensures that $H_0[K, E]$ will still be doubly-filtered in these cases. \square

The following corollary will be useful in Section 5. More exploration of which contractions are tuned with respect to a unweighted vertex v_0 in a rational homology sphere will happen in Subsection 4.3.

Corollary 4.12. *For a weighted vertex v and an unweighted vertex v_0 of a negative-definite forest G_{v_0} , there always exist contractions C_v which are tuned to v_0*

Proof. For each orbit of the action of v on \mathcal{Q} , we first need to choose a maximum of h_U . If there is only one, this is doable and there is nothing left to check. Then, if there are two, we can check h_V , to see which is bigger. If there are still two, we have to make a choice, but at this point it is arbitrary, and we can choose the one lower with respect to the \mathbb{Z} -linear ordering on the v -orbit. \square

4.2. Creating Topological Homotopies. The bulk of this subsection will be dedicated to showing that any given contraction C_v with respect to a vertex v and tuned to a vertex v_0 can be realized topologically on $\mathbb{C}\text{FK}^{\natural}(G_{v_0}, \mathfrak{t})$. While we will focus on the case of the knot lattice space and thus when C_v is tuned to v_0 , the arguments will work to show that any choice of maxima m will provide a contraction C_v that can be realized on $\mathbb{C}\text{F}^{\natural}(G, \mathfrak{t})$.

Recall that $\mathbb{C}\text{FK}^{\natural}(G_{v_0}, \mathfrak{t})$ is identified with \mathbb{R}^s with a cell structure induced by the integer lattice. The set of weighted vertices for G provide a basis for said lattice, and for a point $x \in \mathbb{C}\text{FK}^{\natural}(G_{v_0}, \mathfrak{t})$ and a vertex u let x_u represent the coordinate for x in direction u . The \mathbb{Z} action on \mathcal{Q} given by v extends to an \mathbb{R} action on $\mathbb{C}\text{FK}^{\natural}(G_{v_0}, \mathfrak{t})$. With this in mind we can define a topological analog

$$m^{\natural} : \mathbb{C}\text{FK}^{\natural}(G_{v_0}, \mathfrak{t}) \rightarrow \mathbb{C}\text{FK}^{\natural}(G_{v_0}, \mathfrak{t})$$

to our choice of maxima m . If $x \in [K, E]$, then define $m^{\natural}(x)$ to agree with x on all coordinates except has the x_v coordinate changed to agree with that of $m([K, E])$ and thus in particular lands in $m([K, E])$. Just as m was likely not a chain map, m^{\natural} is likely not continuous.

Let π^{\natural} be the projection from $\mathbb{C}\text{FK}^{\natural}(G_{v_0}, \mathfrak{t})$ to $\mathbb{C}\text{FK}^{\natural}(G_{v_0}, \mathfrak{t})/v \cong \mathbb{R}^{s-1}$ which drops the v -coordinate. In Section 5, we will see that blow-ups and blow-downs are a case where $\mathbb{C}\text{FK}^{\natural}(G_{v_0}, \mathfrak{t})/v$ can be associated with a knot lattice space; however, that is a special case.

As in Section 4.1, we will construct H_v^{\natural} and C_v^{\natural} in steps. However, these steps will not involve how far the cubes move as in C_0 and H_0 but rather which dimension of cubes we are moving. Algebraically define $H_{v,n}$ to be equal to H_v on $[K, E]$ where $|E \setminus v| = n$ and 0 otherwise and let $C_{v,n} = \text{id} + H_{v,n} \partial + \partial H_{v,n}$. Note, that $C_{v,0} \circ \cdots \circ C_{v,s-1} = C_v$, so if we provide a $H_{v,n}^{\natural}$ for each $H_{v,n}$ we will be able to reconstruct an H_v^{\natural} as the concatenation of these homotopies.

To help in realizing H_v as a cellular map, we define a continuous map ξ along with a homotopy Ξ between ξ and id in order move things which are close to the

k skeleton onto the k skeleton. To do this let $\mathcal{Z}_{[K,E]} \subseteq \mathbb{C}\mathbb{F}\mathbb{K}^{\natural}(G_{v_0}, \mathfrak{t})/v$ contain the points (x_1, \dots, x_{s-1}) where $|x_i - \pi^{\natural}(K)_i| \leq \frac{1}{4}$ if $u_i \notin E$ and $|x_i - \pi^{\natural}(K)_i - \frac{1}{2}| \leq \frac{1}{4}$ for $u_i \in E$. This is illustrated in Figure 8a in the case where $s = 3$, where the $\mathcal{Z}_{[K,E]}$ for vertices are in blue, the $\mathcal{Z}_{[K,E]}$ for edges in green, and the $\mathcal{Z}_{[K,E]}$ for the squares are in yellow. Notice that this provides a thickening of the cell decomposition for $\mathbb{C}\mathbb{F}\mathbb{K}^{\natural}(G_{v_0}, \mathfrak{t})/v$. By contracting the $\mathcal{Z}_{[K,E]}$ in the directions not supported by E and expanding in the directions supported by E , we can continuously deform $\mathcal{Z}_{[K,E]}$ to $\pi^{\natural}([K, E])$, and this can be lifted to a homotopy Ξ on $\mathbb{C}\mathbb{F}\mathbb{K}^{\natural}(G_{v_0}, \mathfrak{t})$, which preserves the x_s coordinate. In this homotopy the blue squares get smaller, the green squares get narrower and longer, and the yellow squares get bigger until they become the vertices, edges, and squares of the initial cell decomposition. This map is doubly filtered, since elements of the cube $[K, E]$ either remain in $[K, E]$ or go to the boundary of $[K, E]$. Since the boundary map is doubly-filtered, we have that Ξ and ξ are doubly-filtered. We will use this as a correction term in other calculations.

Before we define $H_{v,n}^{\natural}$, however, we will first define, for an element $[K, E] \in \mathcal{Q}$, some subsets of $\mathbb{C}\mathbb{F}\mathbb{K}(G_{v_0}, \mathfrak{t})/v$, each only dependent on $\pi^{\natural}([K, E])$, which will help us talk about our desired behavior for our contraction. These are shown in Figures 8b, 8c, and 8d, which respectively show these for the vertices, edges, and squares. To start, define $\mathcal{X}_{[K,E]}$ as the portion of $\pi^{\natural}([K, E])$ of distance at most $\frac{1}{4}$ from its center under the sup norm. Note this is also the portion of $\pi^{\natural}([K, E])$ that is not in the interior of some $\mathcal{Z}_{[K',E']}$ where $[K', E']$ is a subcube of $[K, E]$. These sets are shown in dark green in Figures 8b, 8c, and 8d. The set $\mathcal{X}_{[K,E]}$ is important as it will be the set on which points will be moving similarly to the naive formulation of $C_v[K, E]$. It is not all of $[K, E]$ because we need some buffer room in order to ensure continuity.

The sets $\mathcal{Y}_{[K,E]}$ describe the buffer around $\mathcal{X}_{[K,E]}$ on which points will be moving in order to ensure continuity. In particular, we will define $\mathcal{Y}_{[K,E]}$ to be the points of distance at most $\frac{1}{4}$ from $\mathcal{X}_{[K,E]}$ under the taxicab metric. Figures 8b, 8c, and 8d show the sets $\mathcal{Y}_{[K,E]}$ in green-ish yellow with a darker boundary. The following lemma gives how the sets $\mathcal{Y}_{[K,E]}$ relate to the sets $\mathcal{Z}_{[K,E]}$.

Lemma 4.13. *Let $[K, E]$ be a cube in the cell decomposition of $\mathbb{C}\mathbb{F}\mathbb{K}^{\natural}(G_{v_0}, \mathfrak{t})$ and let $\mathcal{S}_{[K,E]}$ be the set of all cubes in the closure of $[K, E]$. Then,*

$$\mathcal{Y}_{[K,E]} \subseteq \bigcup_{[K',E'] \in \mathcal{S}} \mathcal{Z}_{[K',E']}$$

Proof. Let \bar{E} be the set of vertices not in E , and assume without loss of generality that the coordinates \mathbb{R}^s on $\mathbb{C}\mathbb{F}\mathbb{K}^{\natural}(G_{v_0}, \mathfrak{t})/v$ are given by $\mathbb{R}^{\bar{E}} \times \mathbb{R}^E$. Let $\diamond_{\frac{1}{4}}$ be the closed ball of radius $\frac{1}{4}$ around K with the taxicab metric, and let $\square_{\frac{1}{4}}$ be the closed ball of radius $\frac{1}{4}$ around K with the supremum metric. Then, $\mathcal{Z}_{[K,E]}$ has the structure of $\square_{\frac{1}{4}} \times \pi(\mathcal{X}_{[K,E]})$ and the portion of $\mathcal{Y}_{[K,E]}$ has the same coordinates $\mathcal{X}_{[K,E]}$. Note that $\diamond_{\frac{1}{4}} \subseteq \square_{\frac{1}{4}}$, so we now need to cover the points in $\mathcal{Y}_{[K,E]}$ that do not project down onto $\mathcal{X}_{[K,E]}$.

Let x be such a point. Let $\{v_1, \dots, v_n\}$ be the vertices representing the coordinates in \mathbb{R}^E for which x has a distance greater than $\frac{1}{4}$ from the center of $[K, E]$, and let $E' = E - \{v_1, \dots, v_n\}$. For each v_i , one can ask whether the v_i -coordinate

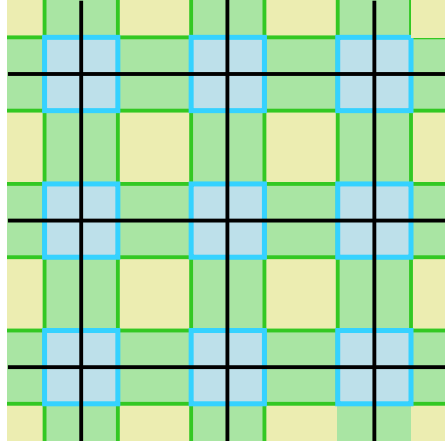

(A) The sets $\mathcal{Z}_{[K,E]}$. When $|E| = 0$ these are blue, when $|E| = 1$ these are green and when $|E| = 2$ these are yellow.

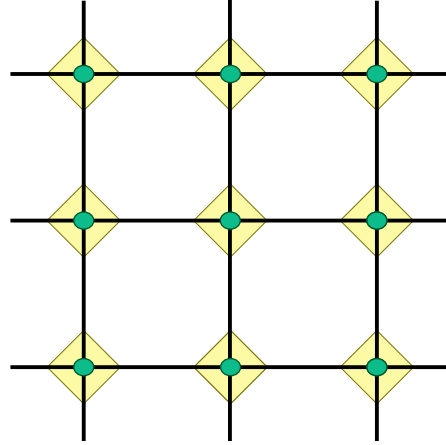

(B) The sets $\mathcal{X}_{[K,E]}$ and $\mathcal{Y}_{[K,E]}$ for $|E| = 0$. The $\mathcal{X}_{[K,E]}$ are the portions of the edges shown in dark green and the $\mathcal{Y}_{[K,E]}$ are the regions in yellow-green.

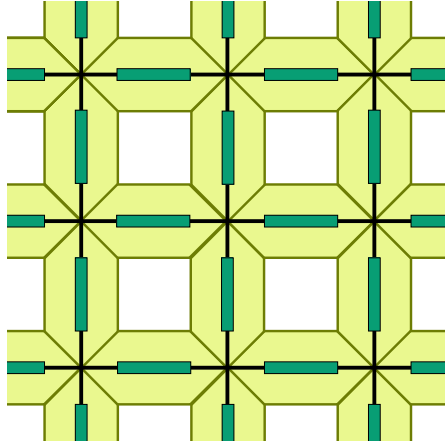

(C) The sets $\mathcal{X}_{[K,E]}$ and $\mathcal{Y}_{[K,E]}$ for $|E| = 1$. The $\mathcal{X}_{[K,E]}$ are the portions of the edges shown in dark green and the $\mathcal{Y}_{[K,E]}$ are the regions in yellow-green.

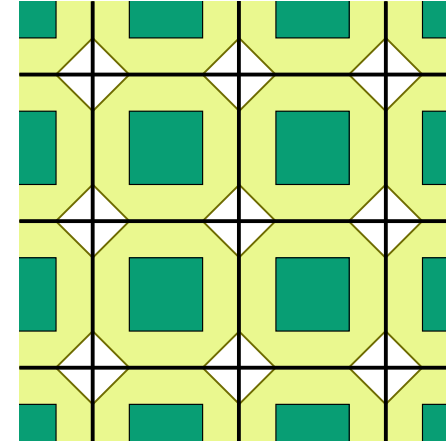

(D) The sets $\mathcal{X}_{[K,E]}$ and $\mathcal{Y}_{[K,E]}$ for $|E| = 2$. The $\mathcal{X}_{[K,E]}$ are the portions of the edges shown in dark green and the $\mathcal{Y}_{[K,E]}$ are the regions in yellow-green.

FIGURE 8. Figures illustrating the sets $\mathcal{Z}_{[K,E]}$, $\mathcal{X}_{[K,E]}$, and $\mathcal{Y}_{[K,E]}$ for various $[K, E]$.

of x is closer to that of K or that of $K + v_i$, and let κ_i be 0 if it is closer to K and 1 if it is closer to $K + v_i$. Let $K' = K + \sum_{i=1}^n \kappa_i v_i$.

Then $[K', E']$ is a subcube of $[K, E]$ and we will show that $x \in \mathcal{Z}_{[K', E']}$. We will denote the center for $[K, E]$ by y and the center for $[K', E']$ by z , which is at $K' + \sum_{u \in E'} \frac{1}{2} u$. For each vertex w of V we have the following cases

- (1) w is not in E ,
- (2) w is in E' ,

- (3) w is a v_i with $\kappa_i = 1$, or
- (4) w is a v_i with $\kappa_i = 0$,

where we will be comparing the w -coordinate of x , x_w , with the w -coordinates for y and z , respectively y_w and z_w . In the first case, y_w is the same as the w coordinate of any point in $\mathcal{X}_{[K,E]}$, and since x has to be less than $\frac{1}{4}$ from $\mathcal{X}_{[K,E]}$ under the taxicab metric, x_w has to be less than $\frac{1}{4}$ from z_w . In the second case, $z_w = y_w$, so because x_w is within $\frac{1}{4}$ of z_w it will still be within $\frac{1}{4}$ of the center for $[K', E']$. In the third case, z_w is $\frac{1}{2}$ more than y_w , and we know that $y_w + \frac{1}{4} < x_w \leq z_w$, so $z_w - \frac{1}{4} \leq x_w \leq z_w + \frac{1}{4}$. In the fourth case z_w is $\frac{1}{2}$ less than y_w and the argument otherwise follows similarly to the third case. \square

We will let \mathcal{X}_n be the union of the $\mathcal{X}_{[K,E]}$ for all $[K, E]$ such that $|E \setminus v| = n$ and let \mathcal{Y}_n be defined similarly for the $\mathcal{Y}_{[K,E]}$, as we will want to reference what is happening for all $[K, E]$ with $|E \setminus \{v\}| = n$ for a given $C_{0,n}^{\natural}$ and not just for a given cube. The following lemma ensures that we can define maps on all of \mathcal{Y}_n by defining what happens on the various $\mathcal{Y}_{[K,E]}$ separately so long as they agree the boundary of each $\mathcal{Y}_{[K,E]}$. If they share a common value on all portions of the boundary then this can be extended to all of $\mathbb{C}\mathbb{F}\mathbb{K}(G_{v_0}, \mathfrak{t})$.

Lemma 4.14. *If $\pi^{\natural}([K, E])$ and $\pi^{\natural}([K', E'])$ both have the same dimension (i.e. $|E \setminus \{v\}| = |E' \setminus \{v\}|$), but $\pi^{\natural}([K, E])$ and $\pi^{\natural}([K', E'])$ are not equal, then the interiors of $\mathcal{Y}_{[K,E]}$ and $\mathcal{Y}_{[K',E']}$ will be disjoint.*

Proof. Note that we only need to show that under the taxicab metric that $\mathcal{X}_{[K,E]}$ and $\mathcal{X}_{[K',E']}$ are at least distance $\frac{1}{2}$ apart. If the cubes $\pi^{\natural}([K, E])$ and $\pi^{\natural}([K', E'])$ do not share a subcube then they are at least 1 apart in the taxicab metric. If they do share a subcube, then they will be distance $\frac{1}{2}$ apart, either by differing by $\frac{1}{2}$ in a single coordinate in the case where $E \setminus \{v\} = E' \setminus \{v\}$, or by differing by $\frac{1}{4}$ in two coordinates. \square

We will now define a continuous function ρ_n on $\mathbb{C}\mathbb{F}\mathbb{K}^{\natural}(G_{v_0}, \mathfrak{t})$, which gives the vertical distance we intend a point to travel. Let $m_v([K, E])$ represent the v coordinate of the cube $m([K, E])$. Then for x with $\pi^{\natural}(x) \in \mathcal{Y}_{[K,E]}$ and $|E \setminus v| = n$, we define

$$\rho_n(x) := (m_v([K, E]) - x_v) \frac{d(\pi^{\natural}(x), \partial\mathcal{Y}_{[K,E]})}{d(\pi^{\natural}(x), \partial\mathcal{Y}_{[K,E]}) + d(\pi^{\natural}(x), \mathcal{X}_{[K,E]})},$$

where d represents the Euclidean metric. Observe that on $(\pi^{\natural})^{-1}(\mathcal{X}_{[K,E]})$ we have that the fraction is 1 and so we are left with $m_v([K, E]) - x$ as desired. By Lemma 4.14, the choice of associated $\mathcal{Y}_{[K,E]}$ is well defined and choices of maxima are defined so that any cube with $\pi^{\natural}([K', E']) = \pi^{\natural}([K, E])$ has $m([K', E']) = m([K, E])$ and thus $m_v([K, E])$ is well defined. Therefore, ρ_n is a continuous function on $(\pi^{\natural})^{-1}(\mathcal{Y}_{[K,E]})$. Meanwhile, the function ρ_n is 0 on points in $(\pi^{\natural})^{-1}(\partial\mathcal{Y}_{[K,E]})$. As such, we get a well defined function on $(\pi^{\natural})^{-1}(\mathcal{Y}_n)$, which can be extended to all of $\mathbb{C}\mathbb{F}\mathbb{K}^{\natural}(G_{v_0}, \mathfrak{t})$ by making it 0 on the complement.

Naively one might define a homotopy $\widehat{H}_{v,n}^{\natural}(x,t) = x + t\rho_n(\pi^{\natural}(x))v$, which would correctly change the v -coordinate, but unfortunately, $\widehat{H}_{v,n}^{\natural}$ is not cellular nor guaranteed to be filtered. Instead, we incorporate Ξ into our definition as follows

$$H_{v,n}^{\natural}(x,t) := \begin{cases} \Xi(x, 2t) & \text{if } t < \frac{1}{2} \\ \xi(x) + (2t-1)\rho_n(x)v & \text{if } t \geq \frac{1}{2}. \end{cases}$$

Proposition 4.15. *The homotopy $H_{v,n}^{\natural}$ realizes $H_{v,n}$.*

Proof. We have to check that $H_{v,n}^{\natural}$ is a cellular map, that $H_{v,n}^{\natural}$ is doubly filtered, and that $(H_{v,n}^{\natural})_{\#} = H_{v,n}$. First, we will check that $H_{v,n}^{\natural}$ is a cellular map, and in particular we will to check cells of the form $[K, E] \times I$ and $[K, E] \times \{1\}$ are mapped into the $(|E| + 1)$ -skeleton and $|E|$ -skeleton respectively. Recall that we represent the k -skeleton of $\mathbb{C}\text{FK}^{\natural}(G_{v_0}, \mathfrak{t})$ as $\mathbb{C}\text{FK}_k^{\natural}(G_{v_0}, \mathfrak{t})$. A cell $[K, E] \times I$ stays in $\mathbb{C}\text{FK}_{|E|+1}^{\natural}(G_{v_0}, \mathfrak{t})$, because $\widehat{H}_{v,n}^{\natural}$ only changes the x_v coordinate of points, thus allowing points to pass through cubes of only one higher dimension, and correcting with Ξ does not change that. If $x \in [K, E]$ then $H_{v,n}^{\natural}(x, 1)$ will be in a cube supported in at most the directions $E \cup v$. If $\pi^{\natural}(x) \in \mathcal{X}_{[K, E]}$ with $|E \setminus \{v\}| = n$, we then have that x is moved to the maximum (staying still if already at the maximum), which lands it on another cube of the same dimension. If x is not in the interior of some $\mathcal{Y}_{[K, E]}$ with $|E| = n$ then x is not moved by $\widehat{H}_{v,n}^{\natural}$ and thus condition 2 is satisfied. Otherwise, Ξ will send x to a cube $[K', E']$ of strictly lower dimension, so movement by $\widehat{H}_{v,n}^{\natural}$ can at most get us back to a cube of the same dimension as our original.

To confirm that $(H_{v,n}^{\natural})_{\#}([K, E] \times I) = H_{v,n}([K, E])$ when $v \in E$, note that the image of $H_{v,n}^{\natural}([K, E] \times I)$ is contained in the closure of the v -orbit of $[K, E]$. The image of $H_{v,n}^{\natural}([K, E] \times I)$ must be contained in $\mathbb{C}\text{FK}_{|E|}(G_{v_0}, \mathfrak{t})$ and thus is 0 in the cellular homology of the pair

$$(\mathbb{C}\text{FK}_{|E|+1}(G_{v_0}, \mathfrak{t}), \mathbb{C}\text{FK}_{|E|}(G_{v_0}, \mathfrak{t})).$$

If $v \notin E$ and $|E| = n$, then we need to pick up every cube between $[K, E]$ and $m([K, E])$ in $(H_{v,n}^{\natural})_{\#}([K, E] \times I)$. The cubes of dimension $|E| + 1$ which can intersect $\widehat{H}_{v,n}^{\natural}([K, E] \times I)$ are precisely those between $[K, E]$ and $m([K, E])$, as we move points in $[K, E]$ vertically at most $\widehat{m}([K, E])$ in the v direction and some points in $[K, E]$ will move that far. The correction by Ξ moves points towards cubes of strictly lower dimension, so new cubes will be hit. Taking a point from the interior of one of these cubes and looking at its preimage under $H_{v,n}^{\natural}$, only one point in $[K, E] \times I$ will be hit. This is true for $\widehat{H}_{v,n}^{\natural}$ and the correction using Ξ will only cause problems on the boundary of the v -orbit of $[K, E]$.

If $|E| \neq n$ we then want $(H_{v,n}^{\natural})_{\#}([K, E]) = 0$, which we will show via the claim that $H_{v,n}^{\natural}([K, E] \times I)$ does not hit the interior of any cube of dimension $|E| + 1$. If additionally $|E| < n$, then $[K, E]$ is at best in the boundary of any given $\mathcal{Y}_{[K', E']}$ with $|E' \setminus \{v\}| = n$, and thus points in $[K, E]$ remain fixed. As such, they do not pass through the interior of any cubes of dimension $|E| + 1$. If $|E| > n$, then it is possible for points on interior of $[K, E]$ to move, but they will do so first by moving to a cube $[K', E']$ on the boundary of $[K, E]$ and then in the direction of v . Thus they will pass through cubes supported in dimensions $E' \cup \{v\}$ and $|E'| < |E|$, so it

is impossible for points in $[K, E]$ to at any point in $[0, 1]$ pass through the interior of a cube of dimension $|E| + 1$.

This is be done with the correct sign because the other sign choice for $H_{v,n}$ would give for $C_{v,n}([K, E])$ a coefficient of 2 on $[K, E]$ where $\tilde{m}([K, E]) \neq 0$ and $v \notin E$. However, given an x in such a $[K, E]$, we have that either $\xi(x)$ is in the boundary of $[K, E]$ or $x \in (\pi^{\natural})^{-1}(\mathcal{X}_{[K, E]})$. In both cases $H_{v,n}^{\natural}(x, 1) = C_{v,n}^{\natural}(x)$ is not in the interior of $[K, E]$ and thus cannot contribute to the coefficient of $[K, E]$ in $(C_{v,n}^{\natural})_{\#}([K, E])$.

To address $H_{v,n}^{\natural}$ being doubly-filtered, Ξ will either keep a point in its current cube or move it to the current cube's boundary, and because the boundary map on $\mathbb{C}\text{FK}(G_{v_0}, \mathfrak{t})$ is filtered this portion of the homotopy is filtered. Now suppose $x \in \mathcal{Y}_{[K, E]}$. By Lemma 4.13, $x \in \mathcal{Z}_{[K', E']}$ for some $[K', E']$ in the closure of $[K, E]$, so and in particular $\xi(x)$ is in the closure of $[K, E]$. When acted on by v , we have that it passes through the closure of the cells associated to $H_{v,n}[K, E]$, and since those were filtered and the boundary map is filtered, we have that the homotopy remains filtered. Since this argument only relies on our knowledge of ∂ and $H_{v,n}$ being filtered, it works when there are two filtrations at play. \square

This leads to a proof of the following theorem:

Theorem 4.16. *Given a contraction C_v with respect to v and tuned to v_0 , there exists a realization C_v^{\natural} for C_v including having a realization H_v^{\natural} of the chain homotopy H_v .*

Proof. Let

$$C_v^{\natural} = C_{v,0}^{\natural} \circ C_{v,1}^{\natural} \circ \cdots \circ C_{v,s-1}^{\natural}.$$

Because $C_{v,n}^{\natural}$ realizes $C_{v,n}$ and

$$C_v = C_{v,0} \circ C_{v,1} \circ \cdots \circ C_{v,s-1},$$

we get that $C_{v,n}^{\natural}$ realizes C_v . That each $C_{v,n}^{\natural}$ is homotopic to the identity, their composition is as well. \square

Remark 4.17. If one wanted a realization for C_0 instead of C_v , define

$$M: (\pi^{\natural})^{-1}(\mathcal{Y}_n) \rightarrow \mathbb{R}$$

on $\mathcal{Y}_{[K, E]}$ as $\sigma \max\{|m^{\natural}([K, E]) - x_s|, 1\}$, where σ is the sign of $m(s) - x_s$. Use this in place of m_v and adjust ρ accordingly. However, it is not the case that C_0^{\natural} eventually stabilizes.

We will now prove that the value of a contraction on a point x only depends on the v orbit of x . This is a nice fact about the form of topological contractions, which has similar implications for contractions on the chain level. Furthermore this will be useful in Section 5 in order to use contractions in helping us define certain continuous cellular maps.

Lemma 4.18. *The value of $C_v^{\natural}(x)$ only depends on the v orbit of x , and thus up to a power of U , $C_v([K, E])$ only depends on the v orbit of $[K, E]$.*

Proof. If x and x' only differ by the action of v then the same can be said of $C_{v,n}^{\natural}(x)$ and $C_{v,n}^{\natural}(x')$ for all n , so we only need to check that for each $x \in \mathbb{R}^s$ there will be an n so that the x_s coordinate of

$$(C_{v,n}^{\natural} \circ C_{v,n+1}^{\natural} \circ \cdots \circ C_{v,s-1}^{\natural})(x)$$

is determined by its v orbit. For a given x , once this is true for some n it will be true for all smaller n . Note that for each $C_{v,n}^{\natural}$, the map $C_{v,n}^{\natural}(x)$ will be determined by its v orbit if it is in \mathcal{X}_n or not in \mathcal{Y}_n . Furthermore, if $\pi^{\natural}(C_{v,n}^{\natural}(x))$ is in the interior of a cube of dimension n then $\pi^{\natural}(x) \in \mathcal{X}_n$. If

$$\pi^{\natural}((C_{v,n}^{\natural} \circ C_{v,n+1}^{\natural} \circ \cdots \circ C_{v,s-1}^{\natural})(x))$$

is in the interior of a cube of dimension n or greater, then

$$(C_{v,n}^{\natural} \circ C_{v,n+1}^{\natural} \circ \cdots \circ C_{v,s-1}^{\natural})(x)$$

is determined by the v orbit of x . For C_v , this becomes if $\pi^{\natural}(C_v(x))$ is in a cube of dimension 0 or greater then it is determined by its v orbit, but that hypothesis is necessarily true. \square

4.3. Constructing Tuned Contractions. While the previous sections guarantee the existence of contractions with respect to vertices v tuned to unweighted vertices v_0 , it does not give much control over what the contractions look like, which this section seeks to address. In particular, we currently have an algorithm for constructing contractions: in each v -orbit find the maximums of h_U then of those find an element maximizing h_V . However, both of these steps are easier said than done.

Thus this section concerns itself with providing tools and constructions which may make this process easier and connects these with other examples, such as the contraction in the appendix of [20]. Proposition 4.20 eliminates the need to calculate h_V directly, while Proposition 4.21 limits the region in a v -orbit of a cube $[K, E]$ where the choice of maxima $m([K, E])$ can occur based on the value of $K(v)$. Lemma 4.19, which is used to prove both of these propositions, will come also up explicitly in Subsection 5.2.

In the case where v is a good vertex, i.e. the degree of v plus v^2 is non-positive, the chain homotopy given by Ozsváth, Stipsicz, and Szabó in the appendix to [20] is indeed a step in a contraction homotopy. We reproduce this step in a contraction homotopy below as \tilde{H}_0^a . To compute T , we need to check the behavior of $[K + 2i_0v^*, E]$ for the value where $(K + i_0v)(v) \in [-k, k)$. If $a_v[K + i_0v, E \cup v] = 0$, Ozsváth, Stipsicz, and Szabó define $[K, E]$ to be of type-a and set $T = -1$, and if $a_v[K + i_0v, E \cup v] > 0$ they define $[K, E]$ to be of type-b and set $T = 1$.

$$\tilde{H}_0^a([K, E]) = \begin{cases} 0 & \text{if } v \in E \text{ or } (T-2)k \leq K(v) < Tk \\ [K, E \cup v] & \text{if } v \notin E \text{ or } K(v) \geq Tk \\ [K - v, E \cup v] & \text{if } v \notin E \text{ or } K(v) < (T-2)k \end{cases}$$

To check that this is a contraction homotopy, notice that Lemma 7.3 of [20] guarantees that for $v \notin E$ at least one of $[K + i_0v_0, E]$ and $[K + (i_0 + 1)v, E]$ is a maximum for the v orbit of $[K, E]$. A closer inspection of the proof Lemma 7.3 reveals that $a_v[K + (i_0 + 1)v, E] > 0$, since in order for an inequality used to show that $B_v[K + (i_0 + 1)v, E] \leq A_v[K + (i_0 + 1)v, E]$ to actually be an equality for a good vertex, one would need $K(v) \leq v^2$. As such, we can rule out the case where both $[K + (i_0 + 1)v, E]$ and $[K + (i_0 + 2)v, E]$ are maxima, but we cannot rule out both $[K + (i_0 - 1)v, E]$ and $[K + i_0v, E]$ being maxima. In that case, we can simply choose the maximum that is in $\{i_0, i_0 + 1\}$ as the guiding maximum for the contraction. Then, the only problem is if both $[K + i_0v_0, E]$ and $[K + (i_0 + 1)v, E]$ are maxima, at

which point the decision to define type-a in terms of $a_v[K + i_0v, E \cup v] = 0$ (instead of $b_v[K + i_0v, E \cup v] > 0$) means the preference is to treat $i_0 + 1$ as the maximum.

We will generalize the decisions made here to cases where v is not good by letting H_0^a be the step in a contraction homotopy that, when there are two choices of maximum, chooses the higher one with respect to the induced \mathbb{Z} ordering. The corresponding contraction will be C_v^a . Similarly, we can define H_0^b to be the step in a contraction homotopy such that when there are two choices of maximum, it prefers the lower one, and it will have corresponding contraction C_v^b . In terms of Figure 7, C_v^a is the one with all the question marks become up arrows, and C_v^b has all the question marks become down arrows.

Recall that

$$\Delta_v[K, E] = \frac{h_U([K + v, E - \{v\}]) - h_U([K, E - \{v\}])}{2}.$$

As such in order to check when C_v^a or C_v^b is tuned to v_0 , we will need to check that if $\Delta_v[K, E] = 0$, then $\Delta_v[K + v_0, E] \geq 0$ in the case of C_v^a or $\Delta_v[K + v_0, E] \leq 0$ in the case of C_v^b .

We will want to be able to compute $\Delta_v[K, E]$ recursively, and to do so will require us to define some auxiliary functions. In particular, for a vertices v and w of G , we will define E_w^v to be all vertices $u \in E$ such that the unique path from u to v includes w . Note that if $u \in E$ then $u \in E_u^v$, and $E_v^v = E$. Now define $\Delta_u^v[K, E]$ to be $\Delta_u[K, E_u^v]$ (and similarly $A_u^v[K, E] = A_u[K, E_u^v]$ and $B_u^v[K, E] = B_u[K, E_u^v]$).

Lemma 4.19. *Let $u, v \in G$, and let u_1, u_2, \dots, u_m be the neighbors of u which are farther from v than u . Let $\gamma_u^v[K, E]$ be the number of u_i for which $\Delta_{u_i}^v[K, E] < 0$. Then $\Delta_u^v[K, E] = f[K, \{u\}] + \gamma$.*

Proof. First, we will find an expression for $B_u^v[K, E]$, and thus let $I \subseteq E_u^v$ with $u \in I$. We can rewrite I as $\{u\} \sqcup \bigsqcup_{u_i} I_{u_i}^v$. Using this, have that

$$f[K, I] = f[K, \{u\}] + \sum_{u_i \in I_{u_i}^v} (f([K, I_{u_i}^v]) + 1) + \sum_{u_i \notin I_{u_i}^v} f([K, I_{u_i}^v]).$$

For, finding the set I that minimizes $f[K, I]$, we will then work on minimizing the contribution from each $I_{u_i}^v$. If $u_i \in I_{u_i}^v$, the minimum contribution is $B_{u_i}^v[K, E] + 1$, whereas if $u_i \notin I_{u_i}^v$ then the minimum is achieved by $A_{u_i}^v[K, E]$. Let $\mathcal{Y} = \{u_i \mid \Delta_{u_i}^v[K, E] < 0\}$. By tracking which of these is the true minimum, we can thus compute that

$$B_u^v[K, E] = f[K, \{u\}] + \sum_{u_i \in \mathcal{Y}} (B_{u_i}^v[K, E] + 1) + \sum_{u_i \notin \mathcal{Y}} A_{u_i}^v[K, E].$$

A similar calculation allows us to work out that

$$A_u^v[K, E] = \sum_{u_i \in \mathcal{Y}} B_{u_i}^v[K, E] + \sum_{u_i \notin \mathcal{Y}} A_{u_i}^v[K, E].$$

Comparing terms gets us our end result. □

Finally the following propositions help us determine when a contraction is tuned with respect to an unweighted vertex v_0 . Proposition 4.20 gives us that at least one of C_a and C_b will always work, while Proposition 4.21 provides a range in which appropriate choices of maxima can be made in terms of $K(v)$. This generalizes

Lemma 7.3 of [21] beyond the setting of good vertices, which is relevant to this paper because blowing up an edge produces a non-good vertex, while still remaining relatively controlled.

Proposition 4.20. *Suppose the graph G represents a plumbing of a rational homology sphere Y . If the parity of the distance from v to v_0 is odd then C_v^a is tuned with respect to v_0 . If the parity of the distance from v to v_0 is even then C_v^b is tuned with respect to v_0 . If v_0 and v are on separate components of the graph G then both C_v^a and C_v^b are tuned with respect to v_0 .*

Proof. As mentioned above, to show that C_v^a is doubly filtered, we have to show that if $\Delta_v[K, E] = 0$ then $\Delta_v[K + v_0, E] \geq 0$. To show that C_v^b is doubly-filtered, we have to show that if $\Delta_v[K, E] = 0$ then $\Delta_v[K + v_0, E] \leq 0$. First to handle the case where v_0 and v are on separate components, use Proposition 3.12 to see that $\Delta_v[K, E] = \Delta_v[K_1, E_1]$. Because $[K_1, E_1]$ is not affected by the action of v_0 , $\Delta_v[K, E] = \Delta_v[K + v_0, E] = 0$ as needed.

Now suppose that v_0 and v are on the same component of G . Since G represents a rational homology sphere, we know that it is a forest and all vertices represent spheres. In particular, there exists a unique path from v_0 to v , which we will write $v_0, u_1, u_2, \dots, u_m = v$. We will prove more generally that for i odd that $\Delta_{u_i}^v[K + v_0, E] \geq \Delta_{u_i}^v[K, E]$ and for i even that $\Delta_{u_i}^v[K + v_0, E] \leq \Delta_{u_i}^v[K, E]$. In the case where $i = 1$ this reduces to the calculation in [21] or equivalently using Lemma 4.19 we have that the number γ remains unchanged and $f[K, \{u_1\}]$ has increased by 1.

Now assume we have shown it to be true for some i . Note that $f[K, \{u_{i+1}\}]$ is unchanged between considering $[K, E]$ and $[K + v_0, E]$. So, by Lemma 4.19, we only need to consider the relation between $\gamma_{u_{i+1}}^v[K, E]$ with $\gamma_{u_{i+1}}^v[K + v_0, E]$, which leads to the corresponding relation between $\Delta_{u_{i+1}}^v[K, E]$ and $\Delta_{u_{i+1}}^v[K + v_0, E]$. Furthermore, all such neighbors w of u_{i+1} other than u_i will have $\Delta_w^v[K + v_0, E] = \Delta_w^v[K, E]$, since from the perspective of E_w^v , v_0 is on a separate component or otherwise has no means of influencing the outcome. Finally, if i is even we would have by our inductive hypothesis $\Delta_{u_i}^v[K + v_0, E] \geq \Delta_{u_i}^v[K, E]$, so $\gamma_{u_{i+1}}^v[K, E] \geq \gamma_{u_{i+1}}^v[K + v_0, E]$. Similarly if i is odd, we would have by our inductive hypothesis that $\Delta_{u_i}^v[K + v_0, E] \leq \Delta_{u_i}^v[K, E]$, so $\gamma_{u_{i+1}}^v[K + v_0, E] \geq \gamma_{u_{i+1}}^v[K, E]$. \square

Proposition 4.21. *Let v be a vertex with degree d and let $\eta = \max\{v^2 + d, 0\}$. Furthermore, let v_0 be an unweighted vertex. One can always select choice of maxima m with respect to v tuned to v_0 so that if $m([K', E]) = [K, E]$, then*

$$(7) \quad v^2 - 2\eta \leq K(v) < -v^2.$$

With v_0 not adjacent to v , we can further assume

$$v^2 - 2\eta < K(v) < -v^2,$$

provided such a K exists in the v -orbit of $[K', E]$.

Proof. Observe that in each v orbit there will be a K that satisfies the conditions of Equation (7), so we show separately that we always have the option to not have $K(v)$ above the target range and to not have $K(v)$ be below the target range. To show that we can assume that $K(v) < -v^2$, note that Lemma 7.3 of [21] gives that

if $K(v) \geq -v^2$ and $v \in E$ then $a_v[K, E] = 0$. Furthermore, if $K(v) \geq -v^2$ then $(K + v_0)(v) \geq -v^2$, so $a_v[K + v_0, E] = 0$ as well. As such, we have both

$$\begin{aligned} h_U([K + v, E]) &\geq h_U([K, E]) \\ h_V([K + v, E]) &\geq h_V([K, E]), \end{aligned}$$

so so may assume that a tuned choice of maxima m has $\tilde{m}([K, E]) > 0$.

Now suppose that v_0 is adjacent to v , $K(v) < v^2 - 2\eta$ and that $v \in E$. Then, $f[K, \{v\}] < v^2 - \eta$ and $f[K + v_0, \{v\}] \leq v^2 - \eta$. Furthermore,

$$\gamma_v[K, E] \leq |E| \leq d \leq -v^2 + \eta,$$

and the same argument gives $\gamma_v[K + v_0, E] \leq -v^+ \eta$. Therefore, by Lemma 4.19, we have that $\Delta_v[K - v, E] < 0$ and $\Delta_v[K - v + v_0, E] \leq 0$. As such,

$$\begin{aligned} h_U([K, E]) &\leq h_U([K, E]) \\ h_V([K, E]) &\leq h_V([K, E]), \end{aligned}$$

and we may assume that a tuned choice of maxima m has $\tilde{m}([K, E]) < 0$. If v_0 is not adjacent to v then $f[K, \{v\}]$ does not change between $[K, E]$ and $[K + v_0, E]$, and as such, we merely need to assume that $K(v) \leq v^2 - 2\eta$ to get the same result. \square

Note then that Proposition 4.21 says that the case of a vertex with degree d and $v^2 + d \leq 1$ with v_0 not adjacent to v is similar to the case of a good vertex. This case is of particular interest because blowing up the edge connecting two weighted vertices results in such a case. Here then we can use the definition of C_v^a given in [21], and we can use a \tilde{C}_v^b defined similarly to the contraction in [21] but with type-a being defined, not by $a_v[K + i_0 v, E] = 0$ but by $b_v[K + i_0 v, E] > 0$.

5. THE (CHAIN) HOMOTOPY EQUIVALENCES

5.1. General Strategy. From now on we will specifically be showing that knot lattice homology and homotopy are invariant under blow-ups, which will complete the proofs of Theorems 1.1 and 1.2. Recall from Theorem 1.3 that the topological knot type determines the nested singularity type, so we only need to consider the five moves shown in Figure 3:

- (1) generic blow-ups,
- (2) blow-ups of a weighted vertex,
- (3) blow-ups of the unweighted vertex,
- (4) blow-ups of edges connecting two weighted vertices, and
- (5) blow-ups of edges incident to the unweighted vertex.

We will first cover some constructions and lemmas that hold in all of the cases above. The lemmas reduce the dependence on knowledge about v_0 and provide the structure for our approach, and we cover how these play out in the case of the blow-up of the unweighted vertex. This framework will be able to convert the proofs of invariance on the chain level provided by Ozsváth, Stipsicz, and Szabó for the cases of blow-ups of the unweighted vertex, generic blow-ups, and blow-ups of edges incident to the unweighted vertex to proofs of invariance of doubly-filtered CW-complexes. The framework also allows the proof of invariance under blow-ups of edges incident to the unweighted vertex to transfer to the case of blow-ups of weighted vertices. What will remain in Subsection 5.2 is checking the details of this framework in the case of blow ups of edges between weighted vertices.

Let G_{v_0} be a negative-definite forest with unweighted vertex, and let G'_{v_0} be some blow-up of G_{v_0} at a point p . Note that p can be perturbed slightly to give a generic blow-up G''_{v_0} . Let X be the plumbing for G_{v_0} , X' the plumbing for G'_{v_0} , and X'' the plumbing for G''_{v_0} . Both X' and X'' can be achieved by adding a two-handle to X representing the exceptional sphere e . Additionally, X' and X'' are diffeomorphic, and in fact, if the blow-up was already generic or a blow-up of the unweighted vertex, their handle decompositions are the same. Otherwise X' and X'' are related by a handle slide or two of existing handles over the new handle, which become the new edges connecting e to the rest of the graph.

Now because the intersection form for X'' is the intersection form for X direct sum $[-1]$, there is a canonical projection of characteristic cohomology classes from $\text{Char}(G'')$ to $\text{Char}(G)$ which forgets evaluation on e . Furthermore, the handle slide from X' to X'' provides a map identifying $\text{Char}(G')$ and $\text{Char}(G'')$. Let $\tilde{P} : \text{Char}(G') \rightarrow \text{Char}(G'')$ be the composition of these maps. The map \tilde{P} preserves the orbits given by the action of the second homology and thus provides a bijection between $\text{Spin}^c(Y_G)$ and $\text{Spin}^c(Y_{G'})$ where Y_G and $Y_{G'}$ are the associated three-manifolds. As such, we will be using \mathfrak{t} to represent a Spin^c structure on Y_G or $Y_{G'}$ under this identification. So, given a particular \mathfrak{t} , we get that \tilde{P} restricts to a map $\text{Char}(G', \mathfrak{t}) \rightarrow \text{Char}(G, \mathfrak{t})$.

In more singularity theoretic language, this is equivalent to defining \tilde{P} based off of how the canonical map from a blow-up to the original resolution affects homology. To get a map on the second cohomology, the map sending a curve to its total transform preserves the intersection form and goes in the appropriate direction to induce the needed cohomological map. The change of basis induced by the handle slides play the same role as changing between the total and proper transforms.

The map \tilde{P} can be extended to a continuous (but not necessarily filtered) map

$$P^\natural : \text{CFK}^\natural(G'_{v_0}, \mathfrak{t}) \rightarrow \text{CFK}^\natural(G_{v_0}, \mathfrak{t}),$$

by reproducing the above identifications using coefficients in \mathbb{R} rather than \mathbb{Z} . The handle slides provide a change of basis for the second homology and thus a change in cellular structure, so the map from $\text{Char}(G') \rightarrow \text{Char}(G'')$ is not necessarily cellular. However, the change in basis only involved handle slides over the new handle for e , which results in a sheering action on the previous cube decomposition in the direction of e . During the projection to $\text{Char}(G)$ the action of this sheering disappears and cubes in $\text{Char}(G')$ are sent to cubes in $\text{Char}(G)$. As such P^\natural is a cellular map and gives a bigraded chain map

$$P : \text{CFK}^\infty(G'_{v_0}, \mathfrak{t}) \rightarrow \text{CFK}^\infty(G_{v_0}, \mathfrak{t}).$$

The name has been chosen deliberately to match the map P given in the appendix of [21]. Furthermore, the map P^\natural is onto and the preimage of any given point is an e -orbit in $\text{CFK}^\natural(G'_{v_0}, \mathfrak{t})$, so identifying $\text{CFK}^\natural(G_{v_0}, \mathfrak{t})$ with $\text{CFK}^\natural(G'_{v_0}, \mathfrak{t})/e$, the map P^\natural plays the role of π^\natural .

In all but the blow-ups involving the unweighted vertex, we have that the disk represented by v_0 represents a specific relative homology class preserved throughout the identifications, and thus action by v_0 commutes with P and P^\natural in those cases. Otherwise, it commutes for the same reason that the map P^\natural is cellular: any change of basis associated with handle-slides washes out with in the final projection. The map P^\natural will also commute with J^\natural , since J^\natural represents the action of negation on cohomology, which passes through the maps used to define P^\natural . Because $J_{v_0}^\natural$ can be

recovered from J^\natural and the action of v_0 , the map $J_{v_0}^\natural$ must also commute with P^\natural . That P^\natural commutes with v_0 is powerful and leads to the following Lemma.

Lemma 5.1. *The map P^\natural is doubly-filtered if it induces a map*

$$P : \mathbb{C}\mathbb{F}(G', \mathfrak{t}) \rightarrow \mathbb{C}\mathbb{F}(G, \mathfrak{t}).$$

Proof. If P^\natural induces a map on lattice homology, then it must be that for every $[K, E] \in \mathcal{Q}_{G'}$, $h_U(P([K, E])) \geq h_U([K, E])$. However, in that case,

$$\begin{aligned} h_V(P([K, E])) &= h_U(P([K, E]) + v_0) \\ &= h_U(P([K + v_0, E])) \\ &\geq h_U([K + v_0, E]) \\ &= h_V([K, E]), \end{aligned}$$

and thus P^\natural actually induces a map with coefficients in $\mathbb{Z}[U, V]$. Furthermore, the image under P^\natural of a cube $[K, E]$ with $e \notin E$ is a single cube in \mathcal{Q}_G , not just algebraically but on the nose. As such, the calculation of the height function for cubes where $P([K, E])$ is algebraically non-zero translates to the check for whether P^\natural is doubly-filtered. If $e \in E$, then $P^\natural([K, E])$ is the same as P^\natural of $[K, E]$'s front and back faces in direction e . Because P^\natural is filtered on both the front and back faces of $[K, E]$ and $h_U([K, E])$ is the minimum of h_U across the front and back faces, then P^\natural must be filtered on the points in $[K, E]$ as well. \square

After we have used Lemma 5.1 to check that P^\natural is doubly-filtered, we would like to provide a map

$$R^\natural : \mathbb{C}\mathbb{F}\mathbb{K}^\natural(G_{v_0}, \mathfrak{t}) \rightarrow \mathbb{C}\mathbb{F}\mathbb{K}^\natural(G'_{v_0}, \mathfrak{t})$$

so that together P^\natural and R^\natural together are a pair of homotopy equivalences. The following lemma will simplify that procedure, so that in the construction of R^\natural we do not need to worry about continuity or h_V , essentially reducing us to the lattice homology case.

Lemma 5.2. *Suppose G_{v_0} is a negative definite forest with an unweighted vertex, G'_{v_0} is a blow-up of G_{v_0} , and let P^\natural and P be the maps defined above. If P can be viewed as a map on $\mathbb{C}\mathbb{F}$ not just $\mathbb{C}\mathbb{F}^\infty$ and if there exists a function $\phi : \mathcal{Q}_G \rightarrow \mathcal{Q}_{G'}$ which is not necessarily a chain map but is singly filtered with respect to h_U , then for each Spin^c structure \mathfrak{t} there exists a map*

$$R^\natural : \mathbb{C}\mathbb{F}\mathbb{K}^\natural(G_{v_0}, \mathfrak{t}) \rightarrow \mathbb{C}\mathbb{F}\mathbb{K}^\natural(G'_{v_0}, \mathfrak{t}),$$

so that P^\natural and R^\natural together provide equivalences of complete homotopy packages for the knot (Y, K) .

Proof. First, because P can be viewed as a map on $\mathbb{C}\mathbb{F}$ we can use Lemma 5.1 to guarantee that P^\natural is a doubly filtered. What remains is to construct R^\natural and prove that it is a doubly-filtered homotopy inverse to P^\natural .

Choose some K in $\text{Char}(G, \mathfrak{t})$ for a given Spin^c structure \mathfrak{t} . Then for all subsets E of the vertices, all cubes supported in the directions in E can be written as $[K, E] + \sum_{u \in V} n_u u$. Define a function

$$\tilde{\phi} : \mathbb{C}\mathbb{F}\mathbb{K}(G_{v_0}, \mathfrak{t}) \rightarrow \mathbb{C}\mathbb{F}\mathbb{K}(G'_{v_0}, \mathfrak{t})$$

by

$$\tilde{\phi}([K, E]) := U^{\zeta_1} V^{\zeta_2} \left[\phi(K) + \sum_{u \in V} n_u u, E \right],$$

with ζ_1 and ζ_2 determined by making $\tilde{\phi}$ bigraded. The definition of front and back faces passes through $\tilde{\phi}$, so $\tilde{\phi}$ is a chain map, and in fact can be realized as a continuous cellular map, $\tilde{\phi}^\natural$. Furthermore, the action of the vertices of G on $\phi(K)$ commutes with P , since the change of basis induced by the handle slides changes the sum $\phi(K) + \sum_{u \in V} n_u u$ by subtracting off a multiple of e that is subsequently dropped in the projection. Therefore, since ϕ was a section of P so is $\tilde{\phi}$.

Now let C_e^\natural be the realization of some contraction with respect to e tuned to v_0 with corresponding choice of maxima m^\natural . Define $R^\natural = C_e^\natural \circ \tilde{\phi}^\natural$. This is a continuous cellular map, and by Lemma 4.18, we have that this is equivalent to using the choice of maxima m^\natural to determine the section and then applying the contraction.

To get that R^\natural is doubly-filtered, we need that for any x there exists some x_1 and x_2 in the e -orbit of x such that

$$(8) \quad h_U(x_1) \geq h_U(P^\natural(x))$$

and

$$(9) \quad h_V(x_2) \geq h_V(P^\natural(x)),$$

for all x because then for a choice of maxima m^\natural tuned to v_0 we have that $h_U(m^\natural(x)) \geq h_U(x_1)$ and $h_V(m^\natural(x)) \geq h_V(x_2)$.

The existence of the section ϕ guarantees that Equation (8) holds. Let x'_2 be the choice satisfying Equation (8) for $x + v_0$. Because P^\natural commutes with the action of v_0 , we have that

$$\begin{aligned} h_V(x'_2 - v_0) &= h_U(x'_2) \\ &\geq h_U(P^\natural(x + v_0)) \\ &= h_U(P^\natural(x) + v_0) \\ &= h_V(P^\natural(x)), \end{aligned}$$

and thus $x'_2 - v_0$ satisfies Equation 9 as needed.

To see that R^\natural and P^\natural provide homotopy inverses first observe that $P^\natural \circ R^\natural$ has a similar effect to the map as ξ introduced in Subsection 4.2, except without the extraneous dimension given by e . It is doubly-filtered homotopic to the identity for the same reasons as ξ . Next, note that $R^\natural \circ P^\natural = C_v^\natural$, which is doubly-filtered homotopic to the identity via H_v^\natural . Since P^\natural commutes with $J_{v_0}^\natural$ and J^\natural , we have that R^\natural must commute with $J_{v_0}^\natural$ and J^\natural up to doubly-filtered homotopy. \square

Remark 5.3. The condition that there exists a singly-filtered section ϕ is equivalent to saying that the maximum value of h_U in each e orbit matches the value of h_U after applying P . However, in order to prove that statement, one would have to produce the maxima in question, i.e. provide a section, so we have phrased it as it will be used in practice.

Furthermore, while this lemma allows us to ignore v_0 when deciding if R^\natural exists, it does not mean that the map R^\natural has no dependence on v_0 , only that any such dependence can be handled by our ability to always find a choice of maxima tuned

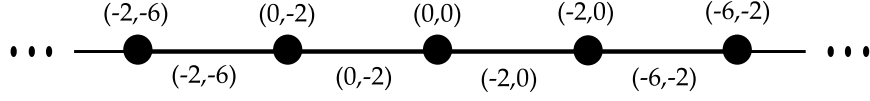

(A) The knot lattice space for a blown up unknot. The heights for the cells are labeled with (h_U, h_V) with the vertices labeled above and the edges labeled below.



(B) the graph of the blown up unknot

FIGURE 9. Subfigure 9a gives the knot lattice space $\mathbb{C}\mathbb{F}\mathbb{K}^{\natural}(G'_{v_0}, \mathfrak{t})$ for the case of the blown up unknot used in the proof that knot lattice homotopy is invariant under blowing up the unweighted vertex. The graph used to create this example is given in Subfigure 9b.

to v_0 . As such, if one wishes to get a more concrete description of R^{\natural} in a particular case, the tools of Subsection 4.3 may be helpful.

To cover a specific case, note that blowing up the unweighted vertex results in connect summing with a copy of the unknot, which Ozsváth, Stipsicz, and Szabó already showed to be chain homotopy equivalent to $\mathbb{Z}[U, V]_0$, where the subscript represents the element 1 being in grading 0 [21]. However, we will review this case to show that this can be done in the topological setting and to provide a specific example of the above discussion. The proof for generic blow-ups follows especially similar to this one.

Let G_{v_0} be the graph for the unknot given by a single unweighted vertex, and let G'_{v_0} represent this graph blown up at the unweighted vertex, with the new vertex having label e . The knot lattice space associated to G_{v_0} is a point K with $h_U(K) = 0$ and $h_V(K) = 0$, while the knot lattice space associated to G'_{v_0} is shown in Figure 9. The map P^{\natural} is the unique map from $\mathbb{C}\mathbb{F}\mathbb{K}^{\natural}(G_{v_0}, \mathfrak{t})$ to $\mathbb{C}\mathbb{F}\mathbb{K}^{\natural}(G'_{v_0}, \mathfrak{t})$. This map is doubly-filtered by Lemma 5.1, since $h_U([K, E]) \leq 0$ and $h_V([K, E]) \leq 0$ for $[K, E]$ a cube of $\mathbb{C}\mathbb{F}\mathbb{K}^{\natural}(G'_{v_0}, \mathfrak{t})$. Letting K_0 represent the characteristic cohomology class on G' with $K_0(e) = -1$, observe that $h_U(K_0) = 0$ and $h_V(K_0) = 0$. Then, define

$$R^{\natural}: \mathbb{C}\mathbb{F}\mathbb{K}^{\natural}(G_{v_0}, \mathfrak{t}) \rightarrow \mathbb{C}\mathbb{F}\mathbb{K}^{\natural}(G'_{v_0}, \mathfrak{t}),$$

by $R^{\natural}(K) = K_0$. Using $m([K, E]) = K_0$ as our choice of maxima, then the corresponding contraction $C_e^{v_0}$ is tuned with respect to v_0 . The contraction homotopy H_e^{\natural} provides the doubly-filtered homotopy from the identity to $R^{\natural} \circ P^{\natural}$, showing that $\mathbb{C}\mathbb{F}\mathbb{K}^{\natural}(G_{v_0}, \mathfrak{t})$ and $\mathbb{C}\mathbb{F}\mathbb{K}^{\natural}(G'_{v_0}, \mathfrak{t})$ are homotopy equivalent. Even if we only had noticed that $h_U(K_0 - e) = 0$ and set $\phi(K) = K_0 - e$, we would still have that $C_e^{v_0}(\phi(K)) = K_0 = R^{\natural}(K)$.

Furthermore, J^{\natural} and $J_{v_0}^{\natural}$ are given by the identity on $\mathbb{C}\mathbb{F}\mathbb{K}^{\natural}(G_{v_0}, \mathfrak{t})$, while on $\mathbb{C}\mathbb{F}\mathbb{K}^{\natural}(G'_{v_0}, \mathfrak{t})$, J^{\natural} is given by reflection across the middle of the edge to the left of

K_0 , and $J_{v_0}^{\natural}$ is given by reflection across the vertex K_0 . Note that P^{\natural} commutes with both, and R^{\natural} commutes with $J_{v_0}^{\natural}$. Additionally, H_e^{\natural} provides the homotopy which allows us to say that R^{\natural} commutes with J^{\natural} up to homotopy.

Additionally blowing up the edge connecting the unweighted vertex to the rest of the graph was covered by Ozsáth, Stipsicz, and Szabó in the appendix of [20]. Having a topological realization and commuting up to homotopy with J^{\natural} and $J_{v_0}^{\natural}$ follow similarly to the case discussed here. Additionally, Lemmas 5.1 and 5.2 allow us to handle any dependence on a choice of v_0 , so the same proof works for blowing up an weighted vertex up to the fact that the contraction tuned to the unweighted vertex may change. As such all that remains is blowing up an edge connecting two weighted vertices.

5.2. Blow-Up of Edges Between Weighted Vertices. Due to Lemmas 5.1 and 5.2, most of the details here are related to checking that P respects the filtration of h_U and that it has a singly filtered section ϕ . Hence, this can be seen as filling in details from the proof of Némethi's proof of the invariance of lattice homology [16]. While the strategy is the same as in the single vertex case, the care needed in finding the singly-filtered section is subtle and thus deserves to be spelled out. Ozsváth, Stipsicz, and Szabó have in the appendix to [20] their own proof of invariance for lattice homology under blow ups of edges, but it passes through the surgery formula for knot lattice homology and therefore does not directly comment on P or the existence of a singly filtered section ϕ , though perhaps it could be made to do so indirectly.

Let G be the graph before blowing up, and let v_1 and v_2 be two vertices connected by an edge. Let G' be the blow-up of G along the edge connecting v_1 and v_2 , and we will name the new vertex e . Again let v_0 be an unweighted vertex representing a knot, and assume that the vertices v_0 is connected to remain the same during the blow-up. We will denote a characteristic co-class on G by (K, p_1, p_2) where p_i is how the class evaluates on v_i and we will denote a characteristic co-class on G' by (k, p_1, p_2, j) where j is how the class evaluates on e .

In this case, the map P^{\natural} discussed in Subsection 5.1 induces the map

$$P : \mathbb{C}\mathbb{F}^{\infty}(G', \mathfrak{t}) \rightarrow \mathbb{C}\mathbb{F}\mathbb{K}^{\infty}(G, \mathfrak{t}),$$

which is defined by

$$P[(K, p_1, p_2, j), E] := \begin{cases} U^{\zeta}[(K, p_1 + j, p_2 + j), E] & \text{if } e \notin E \\ 0 & \text{if } e \in E \end{cases},$$

where ζ is determined by requiring P be graded. The discussion in Subsection 5.1 guarantees that P^{\natural} is continuous and thus P is a chain map. The following proposition checks the hypotheses of Lemma 5.1 to get that P^{\natural} is doubly-filtered.

Proposition 5.4. *The map P can be viewed as a map on $\mathbb{C}\mathbb{F}$ instead of $\mathbb{C}\mathbb{F}^{\infty}$.*

Proof. To prove that $\zeta \geq 0$ for all cubes in $\mathcal{Q}_{G'}$, we will establish that $h_U(P[(K, p_1, p_2, j), E]) \geq h_U([(K, p_1, p_2, j), E])$ for an arbitrary characteristic cohomology class $(K, p_1, p_2, j) \in \text{Char}(G', \mathfrak{t})$ and E that does not contain e . Observe that

$$(K, p_1 + j, p_2 + j)^2 - 1 = (K, p_1 + j + 1, p_2 + j + 1, -1)^2,$$

using that blowing up an edge is equivalent via change of basis to taking the disjoint union of G with a single vertex weighted -1 . Furthermore,

$$\begin{aligned} (K, p_1, p_2, j)^2 &= ((K, p_1 + j + 1, p_2 + j + 1, -1) - (j + 1)\text{PD}[e])^2 \\ &= (K, p_1 + j + 1, p_2 + j + 1, -1)^2 + 2(j + 1) - (j + 1)^2 \\ &= (K, p_1 + j, p_2 + j)^2 - j^2. \end{aligned}$$

As such, using the definition of the height function we get that

$$\begin{aligned} &h_U(P[(K, p_1, p_2, j), E]) - h_U([(K, p_1, p_2, j), E]) \\ &= \frac{(K, p_1 + j, p_2 + j)^2 + s}{4} + 2g[(K, p_1 + j, p_2 + j), E] \\ &\quad - \frac{(K, p_1, p_2, j)^2 + s + 1}{4} - 2g[(K, p_1, p_2, j), E] \\ &= \frac{(K, p_1 + j, p_2 + j)^2 - (K, p_1, p_2, j)^2 - 1}{4} \\ &\quad + 2g[(K, p_1 + j, p_2 + j), E] - 2g[(K, p_1, p_2, j), E] \\ &= \frac{j^2 - 1}{4} + 2g[(K, p_1 + j, p_2 + j), E] - 2g[(K, p_1, p_2, j), E]. \end{aligned}$$

To show that P is filtered we just then need

$$\frac{j^2 - 1}{4} + 2g[(K, p_1 + j, p_2 + j), E] \geq 2g[(K, p_1, p_2, j), E].$$

Note that this will be true if

$$\frac{j^2 - 1}{4} + 2f[(K, p_1 + j, p_2 + j), I] \geq 2f[(K, p_1, p_2, j), I]$$

for every $I \subseteq E$.

Now, assume that $v_1, v_2 \notin I$. Then, the value of f on both sides depends only on K , which is the same for both, and therefore we only need to check that $\frac{j^2 - 1}{4} \geq 0$ for all applicable j . Note then that the only integer for which this fails is 0, and by assuming we are working with characteristic vectors we know that j must be odd.

Now assume that one of v_1 and v_2 , without loss of generality v_1 , is in I and the other is not. Then,

$$2f[(K, p_1 + j, p_2 + j), I] - 2f[(K, p_1, p_2, j), I] = j + 1.$$

Therefore, what we need to hold is

$$0 \leq \frac{j^2 - 1}{4} + j + 1 = \frac{j^2 + 4j + 3}{4} = \frac{(j + 1)(j + 3)}{4}.$$

Similarly to before, the only integer for which this fails even, in this case 2.

Finally, assuming that $v_1, v_2 \in I$,

$$2f[(K, p_1 + j, p_2 + j), I] - 2f[(K, p_1, p_2, j), I] = 2j + 4$$

As such the requirement then becomes

$$0 \leq \frac{j^2 - 1}{4} + 2j + 3 = \frac{j^2 + 8j + 15}{4} = \frac{(j + 3)(j + 5)}{4},$$

which yet again only fails on an even integer. \square

We are going to be using Lemma 5.2 in order to produce a (chain) homotopy interse for P . To do so, we need a singly-filtered section ϕ , and we will first establish a candidate here. For notational convenience, fix a (K, p_1, p_2) and let

$$\tilde{K}_i := (K, p_1 + 1, p_2 + 1, -1) + ie.$$

We will compute $\Delta_e[\tilde{K}_i, E \cup e]$ based off of information from $[(K, p_1, p_2), E]$. A maximum will occur at the first i such that $\Delta_e[\tilde{K}_i, E] \leq 0$, and if $\Delta_e[\tilde{K}_i, E] = 0$ then there will be a maximum at $i + 1$ as well. These computations will reference Lemma 4.19 extensively.

Note that in the calculation of $\Delta_{v_1}^{v_2}[(K, p_1, p_2), E]$ the calculation of $f[K, \{v_1\}]$ is $\frac{p_1 - k_1}{2} = \frac{(p_1 + 1) - k_1 - 1}{2}$, thus giving us the same value as $f[\tilde{K}_0, \{v_1\}]$ used in the calculation of $\Delta_{v_1}^e[\tilde{K}_0, E]$. Furthermore, for all other calculations using $E_{v_1}^{v_2}$, the cubes $[\tilde{K}_0, E]$ and $[K, E]$ are indistinguishable, and as such $\Delta_{v_1}^{v_2}[(K, p_1, p_2), E] = \Delta_{v_1}^e[\tilde{K}_0, E]$. Additionally, $f[\tilde{K}_i, \{v_1\}] = f[\tilde{K}_0, \{v_1\}] + i$, so $\Delta_{v_1}^e[\tilde{K}_i, E] = \Delta_{v_1}^{v_2}[(K, p_1, p_2), E] + i$. Similarly $\Delta_{v_2}^{v_1}[(K, p_1, p_2), E] + i = \Delta_{v_2}^e[\tilde{K}_i, E]$.

The information above can be used to calculate $\gamma_e[\tilde{K}_i, E]$. Let Δ_{min} be the minimum of $\Delta_{v_1}^{v_2}[(K, p_1, p_2), E]$, $\Delta_{v_2}^{v_1}[(K, p_1, p_2), E]$, and let Δ_{max} be the maximum of these values. Then, $\gamma_e[\tilde{K}_i, E] = 1$ if $i < -\Delta_{max}$, $\gamma_e[\tilde{K}_i, E] = 0$ if $-\Delta_{min} \leq i < -\Delta_{max}$, and $\gamma_e[\tilde{K}_i, E] = 0$ if $-\Delta_{min} \leq i$. Furthermore, $f[\tilde{K}_i, \{e\}] = -1 - i$. Therefore, we can compute that

$$\Delta_e[\tilde{K}_i, E \cup e] = \begin{cases} 1 - i & \text{if } i < -\Delta_{max} \\ -i & \text{if } -\Delta_{max} \leq i < -\Delta_{min} \\ -1 - i & \text{if } -\Delta_{min} \leq i. \end{cases}$$

The effects on the location of the maximum in the e orbit of $[\tilde{K}_0, E]$ are described in the table below.

Condition on Δ_{min} and Δ_{max}	Set of locations of maxima
$-\Delta_{max} > 1$	$\{1, 2\}$
$-\Delta_{max} = 1$	$\{1\}$
$-\Delta_{max} \leq 0 < -\Delta_{min}$	$\{0, 1\}$
$-\Delta_{min} = 0$	$\{0\}$
$-\Delta_{min} < 0$	$\{-1, 0\}$

We will at this point define $\phi[(K, p_1, p_2), E]$ as $U^{\zeta_1} V^{\zeta_2}[\tilde{K}_1, E]$ if $\Delta_{max} \leq -1$ and define R to be $U^{\zeta_1} V^{\zeta_2} C_e^{v_0}[\tilde{K}_0, E]$ otherwise.

Theorem 5.5. *There exists a bigraded map $R: \mathbb{C}FK(G_{v_0}, \mathfrak{t}) \rightarrow \mathbb{C}FK(G'_{v_0}, \mathfrak{t})$ with realization R^{\natural} so that R^{\natural} together with P^{\natural} gives a homotopy equivalence.*

Proof. Note that P satisfies all of the needed properties from Lemma 5.2. All that is left is showing that the map ϕ induces a singly-filtered section, by showing that it preserves h_U . We will show the slightly stronger statement that P preserves the grading of

- (1) $[\tilde{K}_1, E]$ if $\Delta_{max} \leq -1$
- (2) $[\tilde{K}_1, E]$ and $[\tilde{K}_0, E]$ if $\Delta_{min} \leq -1 \leq \Delta_{max}$
- (3) $[\tilde{K}_0, E]$ if $\Delta_{min} \geq 0$

These are chosen to be maximal elements in the orbit of $[\tilde{K}_0, E]$, and $C_e^{v_0}$ will not change that fact. Since P is already known to be filtered by Proposition 5.4, we only need to show in each case that $h_U([\tilde{K}_i, E]) \geq h_U(P[\tilde{K}_i, E])$ for our desired i .

First, suppose that $\Delta_{max} \leq -1$. Then, $\Delta_{v_j}^e[\tilde{K}_1, E] \leq 0$ for both $j = 1$ and $j = 2$. Because $e \notin E$ we know that $g[\tilde{K}_1, E]$ can be minimized at an I where $v_1, v_2 \in I$, following the proof of Lemma 4.19. Furthermore, in the proof of Proposition 5.4, that in that case

$$h_U \left(P \left(\tilde{K}_1 + \sum_{u \in I} u \right) \right) = h_U \left(\tilde{K}_1 + \sum_{u \in I} u \right)$$

precisely when \tilde{K}_1 evaluates to -3 or -5 on $n e$ and $\tilde{K}_1 = -3$. This proves that $h_U[\tilde{K}_1, E] \geq h_U(P[\tilde{K}_1, E])$.

Now suppose that $\Delta_{min} \leq -1 < \Delta_{max}$. We know that there exists a $g[\tilde{K}_0, E]$ minimizing I that includes the vertex corresponding to Δ_{min} but excludes the vertex corresponding to Δ_{max} . As such, we can now reference the proof of Proposition 5.4 to see that in that case

$$h_U \left(\tilde{K}_0 + \sum_{u \in I} u \right) = h_U \left(P \left(\tilde{K}_0 + \sum_{u \in I} u \right) \right)$$

precisely when \tilde{K} evaluates to -1 or -3 on e . As before this allows us to conclude that $h_U([\tilde{K}_0, E]) \geq h_U(P[\tilde{K}_0, E])$. Showing that this is true for $[\tilde{K}_1, E]$ requires two observations. First, we can still find the minimizing vertex of the cube $[\tilde{K}_1, E]$ that contains one of v_1 or v_2 but not the other because $\Delta_{min} + 1 \leq 0 < \Delta_{max} + 1$. Second, \tilde{K}_1 evaluates to be -3 on e thus satisfying the needed condition from 5.4.

Now suppose that $\Delta_{min} \geq 0$. Then, $g[\tilde{K}_0, E]$ can be minimized on a subset I that contains neither v_1 nor v_2 . We also have that \tilde{K}_0 evaluates to be -1 on e . Similar to the above arguments, we can then insure on a particular grading minimizing vertex of $[\tilde{K}_0, E]$ that P preserves the grading. This ensures that $h_U([\tilde{K}_0, E]) \geq h_U(P[\tilde{K}_0, E])$. □

Together Lemma 5.2 and Propositions 5.4 and 5.5 prove the following.

Theorem 5.6. *The type of $(\text{CFK}(G_{v_0}, \mathfrak{t}), J_{v_0}, J)$ as a complete package is invariant under blow-ups of the edges for G representing a rational homology sphere.*

Theorem 5.7. *The equivalence type of $(\text{CFK}^{\natural}(G_{v_0}, \mathfrak{t}), J_{v_0}^{\natural}, J^{\natural})$ as a complete homotopy package is invariant under blow-ups of the edges for G representing a rational homology sphere.*

Together Theorems 1.3 and 5.6 as well as the discussion in Subsection 5.1 prove that the chain homotopy equivalence type of $(\text{CFK}(G_{v_0}, \mathfrak{t}), J_{v_0}, J)$ is an invariant for generalized algebraic knots, as needed for Theorem 1.1. Theorem 5.7 replaces Theorem 5.6 in the proof of Theorem 1.2.

REFERENCES

- [1] A. Alfieri. Deformations of lattice homology and the epsilon invariant. Preprint available at <https://arxiv.org/pdf/2111.05229.pdf>, 2020.
- [2] W. Barth, C. Peters, and A. van de Ven. *Compact complex surfaces*. Ergebnisse der Mathematik und ihrer Grenzgebiete. Springer-Verlag, 1984.

- [3] M. Can and Ç. Karakurt. Calculating Heegaard - Floer homology by counting lattice points in tetrahedra. *Acta mathematica Hungarica*, 144(1):43–75, 2014.
- [4] I. Dai and C. Manolescu. Involutive Heegaard Floer homology and plumbed three-manifolds. *J. Inst. Math. Jussieu*, 18(6):2535–2574, 2019.
- [5] D. Eisenbud. *Commutative Algebra with a View Toward Algebraic Geometry*. Springer, 2004.
- [6] D. Eisenbud and W. Neumann. *Three-Dimensional Link Theory and Invariants of Plane Curve singularities*. Princeton University Press, 1985.
- [7] H. Grauert. Über modifikationen und exceptionelle analytische raumforme. *Math Ann.*, 146:331–368, 1962.
- [8] J. Greene. A surgery triangle for lattice cohomology. *Algebr. Geom. Topol.*, 13(1):441 – 451, 2013.
- [9] K. Hendricks and C. Manolescu. Involutive Heegaard Floer homology. *Duke Math Journal*, 166(7):1211–1299, 2017.
- [10] M. Jackson. The invariance of knot lattice homology. Preprint available at <https://arxiv.org/pdf/2111.05229.pdf>, 2021.
- [11] P. Kronheimer and C. Manolescu. Periodic Floer pro-spectra from the Seiberg-Witten equations. Preprint available at <https://arxiv.org/pdf/math/0203243.pdf>, 2003.
- [12] H. B. Laufer. *Normal Two-Dimensional Singularities*. Princeton University Press, 1971.
- [13] C. Manolescu. Seiberg-Witten-Floer stable homotopy type of three-manifolds with $b_1 = 0$. *Geometry and Topology*, 7:889–932, 2003.
- [14] C. Manolescu and S. Sarkar. A knot Floer stable homotopy type. Preprint at <https://arxiv.org/pdf/2108.13566.pdf>, 2021.
- [15] A. Némethi. On the Ozsváth-Szabó invariant of negative definite plumbed 3-manifolds. *Geometry & Topology*, 9:991–1042, 2005.
- [16] A. Némethi. Lattice cohomology of normal surface singularities. *Publications of the Research Institute for Mathematical Sciences*, 44(2):507–543, 2007.
- [17] A. Némethi. Two exact sequences for lattice cohomology. In *Noncommutative geometry and global analysis*, 2011.
- [18] W. D. Neumann. A calculus for plumbing applied to the topology of complex surface singularities and degenerating complex curves. *Transactions of the American Mathematical Society*, 268(2):288–344, 1981.
- [19] W. D. Neumann and F. Raymond. *Seifert manifolds, plumbing, μ -invariant and orientation reversing maps*, pages 163–196. Springer, 1970.
- [20] P. Ozsváth, A. Stipsicz, and Z. Szabó. Knots in lattice homology. Preprint available at <https://arxiv.org/pdf/1208.2617.pdf>, 2012.
- [21] P. Ozsváth, A. Stipsicz, and Z. Szabó. Knots in lattice homology. *Commentarii Mathematici Helvetici*, 89(4):783–818, 2013.
- [22] P. Ozsváth, A. I. Stipsicz, and Z. Szabó. Knot lattice homology in L-spaces. *Journal of Knot Theory and Its Ramifications*, 25(1), 2016.
- [23] P. Ozsváth and Z. Szabó. On the Floer homology of plumbed three-manifolds. *Geometry & Topology*, 7:185–224, 2003.
- [24] P. Ozsváth and Z. Szabó. Holomorphic disks and topological invariants for closed three-manifolds. *Annals of Mathematics*, 159(3):1027–1158, 2004.
- [25] P. Ozsváth and Z. Szabó. Knot Floer homology and integer surgeries. *Algebr. Geom. Topol.*, 8(1):101–153, 2008.
- [26] I. Zemke. Connected sums and involutive knot floer homology. *Proceedings of the London Mathematical Society*, 119(1):214–265, 2019.
- [27] I. Zemke. The equivalence of lattice and Heegaard Floer homology. Preprint available at <https://arxiv.org/pdf/2111.14962.pdf>, 2021.