

KLEENE THEOREM FOR HIGHER-DIMENSIONAL AUTOMATA

ULI FAHRENBERG^a, CHRISTIAN JOHANSEN^b, GEORG STRUTH^{c,d},
AND KRZYSZTOF ZIEMIAŃSKI^e

^a EPITA Research Laboratory (LRE), France
e-mail address: uli@lrde.epita.fr

^b NTNU, Norway
e-mail address: christian.johansen@ntnu.no

^c University of Sheffield, UK
e-mail address: g.struth@sheffield.ac.uk

^d Collegium de Lyon, France

^e University of Warsaw, Poland
e-mail address: ziemians@mimuw.edu.pl

ABSTRACT. We prove a Kleene theorem for higher-dimensional automata. It states that the languages they recognise are precisely the rational subsumption-closed sets of finite interval pomsets. The rational operations on these languages include a gluing composition, for which we equip pomsets with interfaces. For our proof, we introduce higher-dimensional automata with interfaces, which are modelled as presheaves over labelled precube categories, and develop tools and techniques inspired by algebraic topology, such as cylinders and (co)fibrations. Higher-dimensional automata form a general model of non-interleaving concurrency, which subsumes many other approaches. Interval orders are used as models for concurrent and distributed systems where events extend in time. Our tools and techniques may therefore yield templates for Kleene theorems in various models and applications.

1. INTRODUCTION

Higher-dimensional automata (HDAs) were introduced by Pratt and van Glabbeek as a general geometric model for non-interleaving concurrency [Pra91, vG91]. They support autoconcurrency and events with duration or structure, whereas events in interleaving models must be instantaneous. They subsume, for example, event structures and safe Petri nets [vG06a], while asynchronous transition systems and standard automata correspond to two-dimensional and one-dimensional HDAs, respectively [Gou02]. We have recently used van Glabbeek's (execution) paths [vG06a] to relate HDAs with certain languages of interval pomsets [FJSZ21]. Yet a precise description of the relationship between HDAs and these languages in terms of a Kleene theorem – a key theorem for any type of automaton – has so far been missing. Our main contribution lies in the formalisation and proof of such a theorem.

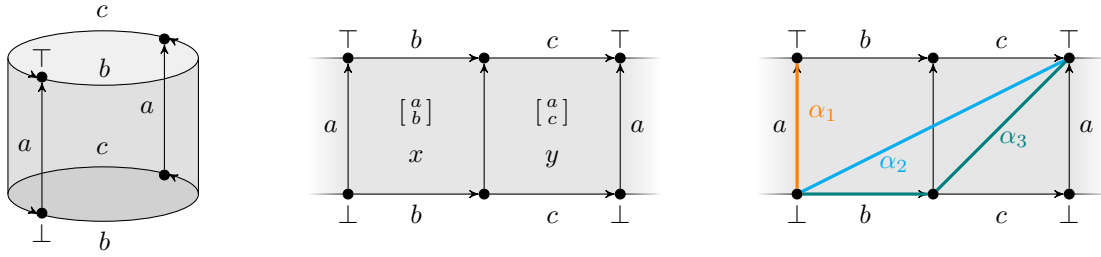

Figure 1: HDA with two 2-dimensional cells x and y modelling the parallel execution of a and $(bc)^*$ on the left, an unfolded view in the middle and three accepting paths of this automaton on the right.

HDAs consist of cells and lists of concurrent events that are active in them. Zero-dimensional cells represent states in which no event is active, while 1-dimensional cells represent transitions in which exactly one event is active – as for standard automata. Higher n -dimensional cells model higher transitions in which n concurrent events are active. Figure 1 shows an example of an HDA with cells of dimension ≤ 2 . In its 2-dimensional cells x and y , the concurrent events $\begin{bmatrix} a \\ b \end{bmatrix}$ and $\begin{bmatrix} a \\ c \end{bmatrix}$ are active, respectively. Cells at any dimension may serve as start and accept cells. In Figure 1, these are labelled with \perp and \top .

Lower-dimensional cells or faces are attached to higher-dimensional ones by face maps. These maps also indicate when particular events start or end their activity. In Figure 1, the lower face $\delta_a^0(x)$ of x forms the lower b -transition in which a is not yet active; its upper face $\delta_a^1(x)$ forms the upper b -transition in which a is no longer active. Intuitively, events can thus be terminated in upper faces and unstarted in lower faces, where “unstarted” refers to the dual of “terminated”. The cubical structure of cells is determined by relations between faces.

Executions of HDAs are (higher-dimensional) paths [vG06a]: sequences of cells, which indicate where events start or terminate. Every path α is characterised by the temporal precedences between the intervals of activity of the concurrent events $\text{ev}(\alpha)$ that occur in it. This naturally induces interval orders, as is further explained in Section 2. In addition, $\text{ev}(\alpha)$ is equipped with source and target interfaces, which model events that are already active in the initial cell of α or still active in its final cell, respectively, and a secondary event order, which captures the list order of events in cells and is useful for coordinating the composition of paths along the interfaces at their ends.

The isomorphism classes of such labelled posets with interfaces and an event order form *ipomsets*. The language of an HDA is then related to the set of (interval) ipomsets associated with all its accepting paths – from start cells to accept cells [FJSZ21]. Languages of HDAs must in particular be down-closed with respect to less concurrent executions, modelled by a subsumption preorder and restricted to interval ipomsets. This motivates the definition of languages as subsumption-closed sets of interval ipomsets.

Kleene theorems usually require a notion of *rational* language. Ours is based on the union \cup , gluing (serial) composition $*$, parallel composition \parallel , and (serial) Kleene plus $^+$ of languages. These definitions are not entirely straightforward, as down-closure and the interval property must be preserved. In particular, in the presence of interfaces, gluing composition is more complicated than, for instance, the standard series composition of pomsets. We consider finite HDAs only and thus can neither include the parallel Kleene

star nor the full serial Kleene star as a rational operation: the latter contains the identity language, which would require an HDA of infinite dimension.

Our Kleene theorem shows that the rational languages are precisely the regular ones (recognised by finite HDAs). To show that regular languages are rational, we translate the cells of an HDA into a standard automaton and reuse one direction of the classical Kleene theorem. Proving that rational languages are regular is harder. Regularity of \cup is straightforward, and for \parallel , the corresponding operation on HDAs is a tensor product. Yet $*$ and $^+$ require an intricate gluing operation on HDAs along higher-dimensional cells and ultimately a new variant of HDAs.

Beyond the Kleene theorem for HDAs, three contributions seem of independent interest. We model HDAs as presheaves on novel precube categories, where events and labels feature in the base category. These are equivalent to standard HDAs [vG06a], but constructions related to the Kleene theorem become simpler, the precedence ordering of events with respect to the beginning and end of their activity becomes more transparent, and the relationship between iposets and precubical sets becomes clearer.

We also introduce HDAs with interfaces (iHDAs), which may assign events to source or target interfaces. This allows us to indicate events that cannot terminate in a given iHDA by assigning them to a target interface, or those that cannot be unstarted by assigning them to a source interface, and to keep track of them across the iHDA.

Using operations of resolution and closure, we show that any HDA can be converted into an equivalent iHDA with respect to language recognition and vice versa. Both variants play a role in our proofs, and we frequently switch between them.

Another tool in our proof of the Kleene theorem is motivated by algebraic topology. We introduce cylinder objects and show that each map between (i)HDAs can be decomposed into an (initial or final) inclusion followed by a (future or past) path-lifting map. This allows us to pull apart start and accept cells of iHDAs when dealing with serial compositions and loops – we refer to the resulting iHDAs as “proper”.

The remainder of this article has three main parts. In its first part, Sections 1 to 5, we introduce HDAs and their languages to the point where we can state and discuss the Kleene theorem for HDAs in its second part, Section 6. In the third part, Sections 7 to 15, we introduce more advanced concepts and develop our main proofs. More specifically, Section 2 contains a detailed semi-formal overview of the relationship between HDAs and their languages. In Section 3 we introduce precube categories and formalise HDAs as presheaves on them. In Section 4 we define ipomsets and their languages, while in Section 5 we define executions of HDAs and languages recognised by them.

Section 6 constitutes the central part of this paper. Here, we formulate the Kleene theorem for HDAs and provide a roadmap towards its proof. We then show in Section 7 how HDAs can be converted into classical finite state automata over an extended alphabet and use this construction together with the standard Kleene theorem to prove that regular languages are rational. In Section 8 we introduce track objects, which provide an alternative description of executions of HDAs. Tensor products of HDAs are defined in Section 9, and they are used to show that parallel compositions of regular languages are regular.

Higher-dimensional automata with interfaces are introduced in Section 10, and translations between HDAs and iHDAs are discussed in Section 11. In Section 12 we introduce cylinders for iHDAs. This construction allows us to replace iHDAs by proper ones without changing their languages. Finally, in Sections 13 and 14, we use proper iHDAs to prove that

gluings of regular languages yields regular languages. These arguments are further refined in Section 15 to show an analogous result for the Kleene plus.

This article is a complete revision of a previous conference paper [FJSZ22a], published at CONCUR, with concepts and notation reconsidered, an overview section (Section 2), pictures and examples added, and in particular the complete technical development leading to the Kleene theorem and its proof, which could only be sketched in the CONCUR paper.

2. OVERVIEW

Higher-dimensional automata generalise standard finite state automata. Let Σ stand for a fixed alphabet of actions (of a concurrent system).

A *higher-dimensional automaton* (HDA) X is defined by the following data:

- a set $\text{Cell}(X)$ of *cells*;
- for each cell $x \in \text{Cell}(X)$ a totally ordered set of Σ -labelled events $\text{ev}(x)$;
- for each cell $x \in \text{Cell}(X)$ and disjoint subsets $A, B \subseteq \text{ev}(x)$ a cell $\delta_{A,B}(x)$, called a *face* of x , with set of events $\text{ev}(x) \setminus (A \cup B)$;
- the identity $\delta_{\emptyset,\emptyset}(x) = x$ for each $x \in \text{Cell}(X)$;
- the equality $\delta_{A,B}(\delta_{C,D}(x)) = \delta_{A \cup C, B \cup D}(x)$ whenever $A, B, C, D \subseteq \text{ev}(x)$ are disjoint;
- sets $X_{\perp}, X_{\top} \subseteq \text{Cell}(X)$ of *start cells* and *accept cells*, respectively.

HDAs without start and accept cells are known as *precubical sets*.

Cells correspond to transitions of concurrent events in a concurrent system. These include degenerate transitions where no event is active, corresponding to states of a classical automaton, transitions where one single event is active, as in a classical automaton, but also higher transitions in which more than one event is active. The name “cell” also emphasises the roots of HDAs in topology and geometry.

The set $\text{ev}(x)$ of events records the concurrent events that are active in the cell x . The total *event order* $--\rightarrow$ on $\text{ev}(x)$ can be seen as an order on indices of concurrent events. We also use it to identify events across cells and their faces and to relate HDAs with the ipomsets that model their behaviour. The labelling function $\lambda : \text{ev}(x) \rightarrow \Sigma$ associates events with the actions they perform. We call $(\text{ev}(x), --\rightarrow, \lambda)$ the *concurrency list* of x .

The faces $\delta_{A,B}(x)$ of the cell x keep track of the intervals of activity of concurrent events in an HDA. Each cell $\delta_{A,\emptyset}(x)$, also written $\delta_A^0(x)$, forms a *lower face* of x ; each cell $\delta_{\emptyset,B}(x)$, also written $\delta_B^1(x)$, forms an *upper face* of x . In $\delta_A^0(x)$, the events in A , which are active in x , have not yet started; in $\delta_B^1(x)$, the events in B , which are active in x , have terminated. All events in $\text{ev}(x) \setminus A$ remain active in $\delta_A^0(x)$ and those in $\text{ev}(x) \setminus B$ remain active in $\delta_B^1(x)$. The functional relationship between each cell x and its faces, for each $A, B \subseteq \text{ev}(x)$, allows us to view the $\delta_{A,B}$ as *face maps* for x , which attach faces to cells. The identity in the penultimate bullet point above states that the result of removing disjoint sets of events (terminating or does not depend on the order in which these removals occur; it implies $\delta_{A,B} = \delta_A^0 \delta_B^1 = \delta_B^1 \delta_A^0$.

Example 2.1. The diagram on the left of Figure 2 shows an HDA with cells x, x_1, \dots, x_8 , where x_1, \dots, x_8 are faces of x . The concurrent events active in x are $\text{ev}(x) = \{a, b\}$, where we assume that $a --\rightarrow b$. Here, and henceforth in this article, we identify events with their actions, whenever suitable. We call the cells x_1, x_3, x_6 and x_8 0-dimensional and x_2, x_4, x_5 and x_7 1-dimensional, while x is a 2-dimensional cell. The arrows in this diagram indicate the face maps of x . For simplicity, we also write δ_{ab}^0 instead of $\delta_{\{a,b\}}^0$ and likewise. The faces

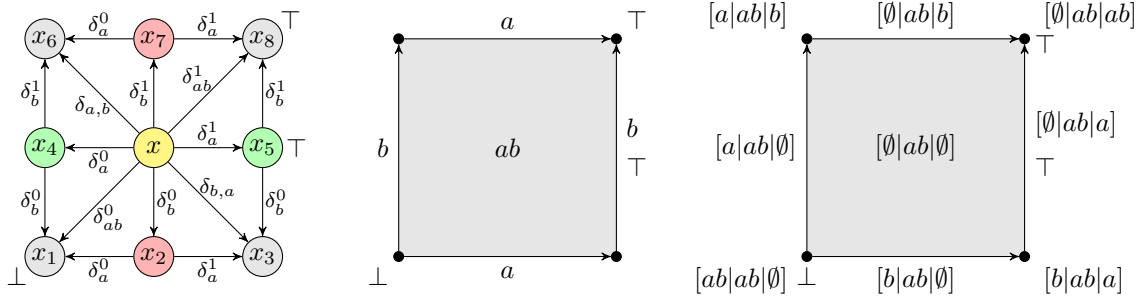

Figure 2: Three representations of a two-dimensional HDA.

of x are given by

$$\begin{aligned}
 x_1 &= \delta_{ab}^0(x) = \delta_a^0(x_2) = \delta_b^0(x_4) = \delta_a^0(\delta_b^0(x)) = \delta_b^0(\delta_a^0(x)) = \delta_{ab,\emptyset}(x), \\
 x_2 &= \delta_b^0(x), \\
 x_3 &= \delta_a^1(x_2) = \delta_b^0(x_5) = \delta_a^1(\delta_b^0(x)) = \delta_b^0(\delta_a^1(x)) = \delta_{b,a}(x), \\
 x_4 &= \delta_a^0(x), \\
 x_5 &= \delta_a^1(x), \\
 x_6 &= \delta_b^1(x_4) = \delta_a^0(x_7) = \delta_b^1(\delta_a^0(x)) = \delta_a^0(\delta_b^1(x)) = \delta_{a,b}(x), \\
 x_7 &= \delta_b^1(x), \\
 x_8 &= \delta_{ab}^1(x) = \delta_b^1(x_5) = \delta_a^1(x_7) = \delta_b^1(\delta_a^1(x)) = \delta_a^1(\delta_b^1(x)) = \delta_{\emptyset,ab}(x).
 \end{aligned}$$

The face x_1 , for instance, is a lower face of x , x_2 and x_4 . Neither a nor b is active in x_1 , whereas a , but not b , is active in x_2 and b , but not a , is active in x_4 . Indeed, the result of removing first a and then b , or first b and then a , lead to the same face of x , namely x_1 . The cell x_3 is neither a lower nor an upper face of x , though it is the upper face of x_2 and the lower face of x_5 . Yet it is a face of x as $x_3 = \delta_{b,a}(x)$, which indicates that b has not yet started, but a has terminated in x_3 . The remaining faces satisfy similar relationships.

The cell x_1 is the start cell of the HDA, while x_5 and x_8 are accept cells. As in the introduction, we label such cells \perp and \top , respectively.

The 0-cells of the HDA, where no event is active, are grey, and its 1-cells, where precisely one event is active, a in the pink cells and b in the green ones, correspond to the states and transitions of a classical automaton. The 2-cell x , in yellow, where a and b are concurrently active, models a higher transition. It has no classical analogue. Similarly, the HDA has the 1-cell x_5 as an accept cell, while classical automata can only accept in 0-cells.

The diagram in the middle represents the HDA geometrically in terms of the actions that are concurrently active in each cell. The 0- and 1-cells are represented as states and arrows. The 2-cell is represented as a filled-in square. Cells of dimension strictly greater than 0 are labelled with their active events or actions. This geometric view allows depicting events as paths or trajectories that traverse the HDA along the directions of the arrows.

Relative to the cell x and its faces, the diagram on the right uses triples $[-| -| -]$ to list the events or actions that are not yet active in a face in the first component, those that are active in the “top cell” x in the second, and those that have already terminated in the face in the third. This notation is local to the faces of particular top cells.

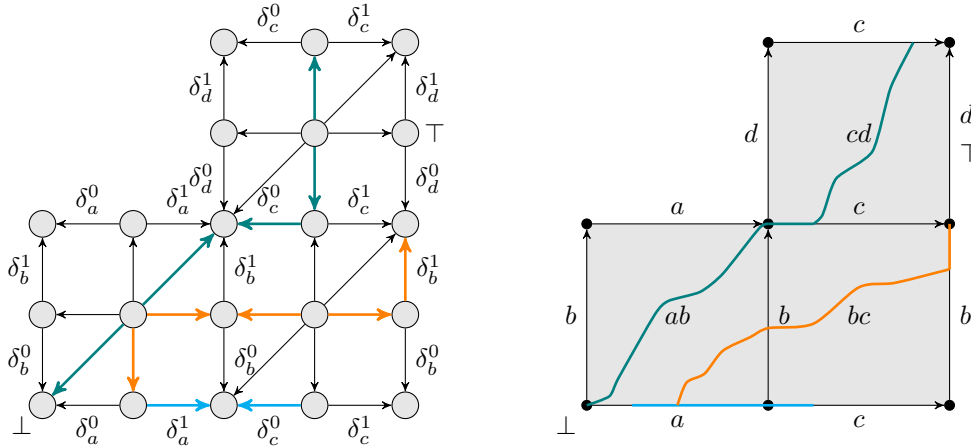

Figure 3: Paths in an HDA

Remark 2.2. Precubical sets and HDAs can be represented by geometric objects, which are higher-dimensional cubes in topological spaces. Details of these geometric realisations of precubical sets and HDAs can be found in the literature [Gra09,FGH⁺16,FRG06]. Geometric realisations provide intuitions for concurrent systems evolving continuously across higher-dimensional cells, while their events start, are active and terminate. Yet our results do not require their formalisation.

Example 2.3. The classical finite state automata are one-dimensional HDAs in which all start and accept cells have dimension 0 and hence no active events. The 0-cells without active events form the states of such automata, 1-cells with precisely one active, a say, correspond to a -labelled transitions. The face maps δ_a^0 and δ_a^1 attach source and target states to transitions.

A *path* on an HDA X is a sequence of *steps*, formed by triples of two cells and a step between them, so that each subsequent step must start in the cell in which the previous one has terminated. We distinguish two kinds of steps:

- *up-steps* ($\delta_A^0(x) \nearrow^A x$) from a lower face of the cell x to x ;
- *down-steps* ($x \searrow_B \delta_B^1(x)$) from x to one of its upper faces.

Up-steps start events while down-steps terminate them. Steps thus keep track of the events that start or terminate in them. If $y = \delta_A^0(x) = \delta_C^0(x)$ for $A, C \subseteq \text{ev}(x)$ and $A \neq C$, then $(y \nearrow^A x)$ and $(y \nearrow^C x)$ are distinct. While the termination of a specific set of events that are active in a given cell is a deterministic operation, starting new events in a given cell can be nondeterministic, as any cell may be a lower face of several cells.

In finite state automata as in Example 2.3, every transition consists of an up-step followed by a down-step.

Each path α is associated with its *set of events* $\text{ev}(\alpha)$. It contains the local events of all cells appearing in α , but certain events of consecutive cells are identified. In a step $(\delta_A^0(x) \nearrow^A x)$, for instance, the events of $\delta_A^0(x)$ are identified with events in x via the equivalence \cong induced by the unique event-order preserving bijection between sets in $\text{ev}(\delta_A^0(x)) \cong \text{ev}(x) \setminus A \subseteq \text{ev}(x)$.

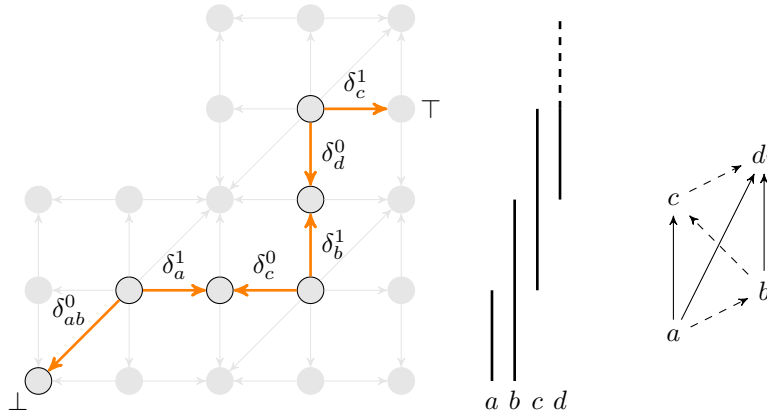

Figure 4: Interval ipomset of path in HDA

Example 2.4. Figure 3 shows three paths through an HDA with three 2-cells that are glued along two 1-dimensional faces. The diagram on the left shows paths consisting of up-steps and down-steps. Note that the direction of up-steps goes against the direction of lower face maps, while the direction of down-steps and upper face maps coincides. The concurrency lists of the missing faces and the missing face maps can be reconstructed from the data shown. The diagram on the right shows a geometric realisation with piecewise smooth paths or trajectories crossing the HDA from bottom left to top right.

The set $\text{ev}(\alpha)$ carries additional structure:

- the *precedence* order $<$, where $p < q$ holds if event p is active in some cell before event q is active in a different cell, and if there is no cell in which they are both active;
- the *event order* \dashrightarrow , which is constructed from the local event orders in the concurrency lists of individual cells,
- the *source interface* of α , which contains all events of the source cell, the first cell of α , and the *target interface* of α , which contains all events of the target cell, the last cell of α .

The resulting structure, formed by events labelled with actions and equipped with a precedence, an event order and source and target interfaces, is called the (labelled) *iposet* of the path α (it satisfies some extra conditions omitted here: in particular $<$ is an interval order, see Figure 4.) As usual in concurrency theory, we define an *ipomset* as an isomorphism class of iposets, where isomorphisms are order preserving and reflecting and label and interface preserving bijections between iposets.

A path of an HDA is *accepting* if its source is a start cell and its target an accept cell of the HDA. The set of all ipomsets associated with accepting paths in X is the *language* $\text{Lang}(X)$ of X .

Example 2.5. Figure 4 shows the iposet of an accepting path α on the HDA from Figure 3 on the left. The bar codes in the centre indicate when the events a, b, c and d in the HDA start, are active and terminate relative to each other. The dashed part of the interval for d indicates that d remains active in the accept state $\text{tgt}(\alpha)$.

The Hasse diagram on the right shows the ipomset of α . The precedence on events is indicated by solid arrows. The event order, given here by the lexicographical order on events, is indicated by dashed arrows. As d does not terminate in $\text{tgt}(\alpha)$, it is in $\text{ev}(\text{tgt}(\alpha))$, the concurrency list of $\text{tgt}(\alpha)$, and hence in the target interface of the ipomset of α . We

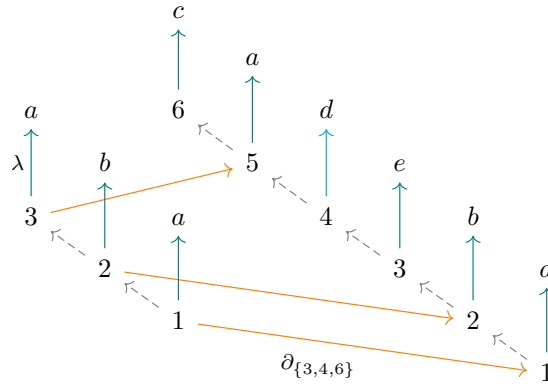

Figure 5: Conclists $1 \dashrightarrow 2 \dashrightarrow 3$ and $1 \dashrightarrow 2 \dashrightarrow \dots \dashrightarrow 6$ with lo-map $\partial_{\{3,4,6\}}$ and labelling function λ into $\Sigma = \{a, b, c, d, e\}$.

indicate this by writing $d\bullet$. Similarly, we would have indicated membership in the source interface of this ipomset by adding a bullet to the left of the event, for instance $\bullet e$, but here $\text{ev}(\text{src}(\alpha))$ is empty because no event is active in the HDA at the beginning of the path.

3. HIGHER-DIMENSIONAL AUTOMATA

In this section we provide a formal definition of higher-dimensional automata. It differs from those in the literature and it is slightly more general. We relate our definition to previous ones in Appendix A. It is technically convenient to model HDAs as labelled precubical sets equipped with start and accept cells. Precubical sets in turn can be modelled as presheaves on a so-called labelled precube category. Objects of this category are concurrency lists; morphisms are precube maps, which are order and label preserving maps enriched with information about the activity of events, their start and termination.

Concurrency lists. Throughout the paper, we fix an alphabet Σ of labels, which are meant to represent the actions of a concurrent system.

A *concurrency list* or *conclist* $(U, \dashrightarrow, \lambda)$ consists of a finite set U equipped with a strict total *event order* \dashrightarrow on U and a labelling function $\lambda : U \rightarrow \Sigma$ that assigns actions to events. An *lo-map* $f : U \rightarrow V$ between conclists U and V is a label and (event) order preserving map. Conclists and lo-maps form a category.

We often write conclists vertically as vectors of events or actions, which we often do not distinguish, especially in diagrams. Recall from Section 2 that the set U models the concurrent local events active in a cell of an HDA, \dashrightarrow can be seen as their index order and λ associates events with their actions. Since \dashrightarrow is strict and total, every lo-map is injective.

By construction, each lo-map $f : U \rightarrow V$ order-embeds the conclist U into the conclist V in a unique way. Hence f identifies the events in the conclist U with events in the conclist V in a way compatible with \dashrightarrow_U and \dashrightarrow_V . It further determines a unique set $A = V \setminus f(U)$ of elements which are inserted into U to obtain V . Conversely, the conclist U and lo-map f are uniquely determined by the restriction of the conclist V to the events outside of A .

$$[2] \xrightarrow{\partial_{\{1\}}} \begin{bmatrix} 1 \\ 2 \end{bmatrix} \circ \begin{bmatrix} 1 \\ 2 \end{bmatrix} \xrightarrow{\partial_{\{3,4\}}} \begin{bmatrix} 1 \\ 2 \\ 3 \\ 4 \end{bmatrix} = [2] \xrightarrow{\partial_{\{1,3,4\}}} \begin{bmatrix} 1 \\ 2 \\ 3 \\ 4 \end{bmatrix}$$

Figure 6: Composition of two lo-maps.

We therefore write $\partial_{A \subseteq V} : U \hookrightarrow V$ for lo-maps to emphasise this relationship or simply $\partial_A : U \hookrightarrow V$ if the dependency on V is clear. See Figure 5 for an example. The composite of $\partial_{A \subseteq V} : U \hookrightarrow V$ and $\partial_{B \subseteq W} : V \hookrightarrow W$ is

$$\partial_{B \subseteq W} \circ \partial_{A \subseteq V} = \partial_{\partial_B(A) \cup B \subseteq W} : U \hookrightarrow W,$$

as illustrated in Figure 6.

Two conclists are isomorphic, $U \cong V$, if there exists a bijective lo-map $U \rightarrow V$ that is an order embedding. Isomorphism classes of conclists can be seen as lists of actions, and lo-maps extended to equivalence classes. Each such map then inserts letters from Σ into a Σ -list. Alternatively we can see isomorphism classes of conclists as lists of actions indexed by natural numbers. This leads to a more standard view of HDAs, see aee Appendix A. In our proof of the Kleene theorem, working with maps ∂_A has notational advantages.

Conclist maps. Next we introduce conclist maps, which form the morphisms of our labelled precube categories. These are lo-maps in which the information, whether events that are not in their images have terminated or not yet started, is made explicit.

A *conclist map* $d_{A,B \subseteq V} : U \rightarrow V$, or shortly $d_{A,B} : U \rightarrow V$, is a triple $(\partial_{A \cup B \subseteq V}, A, B)$ with $A, B \subseteq V$ disjoint and $\partial_{A \cup B \subseteq V} : U \hookrightarrow V$ a lo-map.

Intuitively, $d_{A,B} : U \rightarrow V$ identifies the events in U with events in $V \setminus (A \cup B)$, as prescribed by $-->_U$ and $-->_V$, while A and B are those local events in V that have not yet started and have terminated in U , respectively. Compared to the face maps in Section 2, the direction of arrows is reversed.

The composite of the conclist maps $d_{A,B \subseteq V} : U \rightarrow V$, $d_{C,D \subseteq W} : V \rightarrow W$ is defined as

$$d_{C,D \subseteq W} \circ d_{A,B \subseteq V} = (\partial_{C \cup D \subseteq W} \circ \partial_{A \cup B \subseteq V}, \partial_{C \cup D \subseteq W}(A) \cup C, \partial_{C \cup D \subseteq W}(B) \cup D).$$

This formula simplifies when V is a subset of W , which can be guaranteed up to isomorphism of conclists. For pairwise disjoint $A, B, C, D \subseteq W$ and $V = W \setminus (C \cup D)$,

$$d_{C,D \subseteq W} \circ d_{A,B \subseteq V} = d_{A \cup C, B \cup D \subseteq W}. \quad (3.1)$$

Figure 7 shows an example. Further, we write $d_{A \subseteq V}^0$ for $d_{A, \emptyset \subseteq V}$ and $d_{B \subseteq V}^1$ for $d_{\emptyset, B \subseteq V}$, or more briefly d_A^0 and d_B^1 .

Labelled precube categories. Next we define the base categories of precubical sets and higher-dimensional automata modelled as presheaves.

The *full labelled precube category* \square has conclists as objects and conclist maps as morphisms. To work with equivalence classes of conclists, we define the *labelled precube category* \square as the quotient of \square with respect to the isomorphism \cong . Its objects are isomorphism classes of conclists, its conclist maps equivalence classes of conclist maps in \square .

$$\begin{array}{c}
[b] \xrightarrow{d_{a,\emptyset}} \begin{bmatrix} a \\ b \end{bmatrix} \circ \begin{bmatrix} a \\ b \end{bmatrix} \xrightarrow{d_{c,a'}} \begin{bmatrix} a \\ b \\ c \\ a' \end{bmatrix} = [b] \xrightarrow{d_{ac,a'}} \begin{bmatrix} a \\ b \\ c \\ a' \end{bmatrix} \\
\\
\begin{array}{ccc}
\begin{array}{c} a \\ \vdots \\ b \end{array} & \begin{array}{c} a \\ \vdots \\ b \end{array} & \begin{array}{c} a \\ \vdots \\ c \\ \vdots \\ b \\ \vdots \\ a' \end{array} \\
\circ & & = \\
\begin{array}{c} b \\ \longrightarrow \end{array} & \begin{array}{c} b \\ \longrightarrow \end{array} & \begin{array}{c} b \\ \longrightarrow \end{array}
\end{array}
\end{array}$$

0 1 0 1

Figure 7: Composition conclist maps. Annotations **0** and **1** indicate events that have not yet started (**0**) or terminated (**1**), as defined in the triple $(\partial_{A \cup B}, A, B)$.

To define the latter, note that two conclist maps $d_{A,B} : U \rightarrow V$ and $d_{A',B'} : U' \rightarrow V'$ are equivalent in \square if there exists a conclist isomorphism $\psi : V \rightarrow V'$ such that $\psi(A) = A'$ and $\psi(B) = B'$. As mentioned before, such ψ are unique. This definition guarantees in particular that U and U' are isomorphic conclists, via unique isomorphisms

$$U \cong V \setminus (A \cup B) \cong V' \setminus (A' \cup B') \cong U'.$$

The category \square has countably many objects and hence it is small. It is skeletal: isomorphisms between conclists are unique in the presence of \dashrightarrow , and the quotient functor $\square \rightarrow \square$ is an equivalence of categories. We switch freely between \square and \square and identify morphisms $[U] \rightarrow [V]$ on equivalence classes of event orders with representatives $d_{A,B} : U \rightarrow V$ on conclists. See again Figure 7 for an example.

Precubical sets and higher-dimensional automata. Our formalisation of precubical sets and higher-dimensional automata differs from previous definitions [Gra09, vG06a, Gou02]. One difference is that labels are directly incorporated into the base category of the presheaf. See Appendix A for a comparison.

A *precubical set* X (a *pc-set* for short) is a presheaf on \square , hence a functor $\square^{\text{op}} \rightarrow \text{Set}$. We write

- $X[U]$ for the value of X at object U of \square and call the elements of $X[U]$ *cells*;
- $\text{Cell}(X) = \bigsqcup_{U \in \square} X[U]$ for the set of all cells of X ;
- $\text{ev}(x) = U$ for each $x \in X[U]$ to recover the conclist of concurrent events that are active within the cell $X[U]$ ($\text{ev}(x)$ is defined only up to isomorphism);
- $\delta_{A,B \subseteq U} = X[d_{A,B \subseteq U}] : X[U] \rightarrow X[U \setminus (A \cup B)]$ for the *face map* associated to the conclist map $d_{A,B \subseteq U} : U \setminus (A \cup B) \rightarrow U$;
- $\delta_{A \subseteq U}^0 = X[d_{A \subseteq U}^0]$ and $\delta_{B \subseteq U}^1 = X[d_{B \subseteq U}^1]$ for face maps attaching lower and upper faces to the cells in $X[U]$.

As before, we drop the index U from face maps if convenient.

A precubical set X is *finite* if $\text{Cell}(X)$ is finite. The *dimension* of a cell $x \in X[U]$ is the cardinality $|U|$ of U . The *dimension* $|X|$ of the presheaf X is the maximal dimension among its cells. It is finite whenever X is.

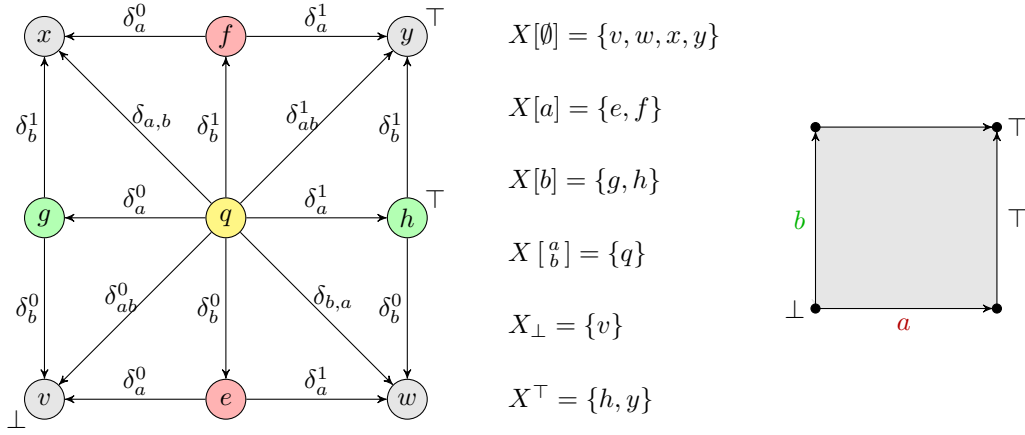

Figure 8: A two-dimensional HDA X on $\Sigma = \{a, b\}$.

A *higher-dimensional automaton* (HDA) is a finite precubical set X equipped with a set of start cells $X_{\perp} \subseteq \text{Cell}(X)$ and a set of target cells $X^{\top} \subseteq \text{Cell}(X)$.

Remark 3.1. The set $\text{Cell}(X)$ may be regarded as the set of objects of the category of elements of presheaf X , and $\text{ev} : \text{Cell}(X) \rightarrow \square$ may be regarded as the canonical projection.

Example 3.2. Figure 8 shows once again the HDA and its geometric realisation from Figure 2. The first four elements of the column in the centre show how conclists of the base category are mapped to sets of cells. The empty conclist, for instance, is mapped to the four 0-cells where no event is active. The conclist a is mapped to the two red 1-cells where a is active and the conclist b to the two green 1-cells where b is active. Finally, the conclist ab is mapped to the yellow 2-cell where both of these events are active concurrently. We omit braces and simplify notation as in Section 2.

A *map of precubical sets* (pc-map) is a natural transformation $f : X \rightarrow Y$ of precubical sets X, Y regarded as presheaves $\square^{\text{op}} \rightarrow \text{Set}$. Its components are given by the functions $(f[U] : X[U] \rightarrow Y[U])_{U \in \square}$ that commute with face maps. An *HDA-map* is a map of precubical sets that preserves start and accept cells: $f(X_{\perp}) \subseteq Y_{\perp}$ and $f(X^{\top}) \subseteq Y^{\top}$.

We write $\square\text{Set}$ and HDA for the categories of precubical sets and HDAs.

Standard cubes. Standard cubes form the building blocks of precubical sets. The *standard U-cube* \square^U of the conclist U is the precubical set represented by U , as given by the Yoneda embedding $\square \rightarrow \square\text{Set}$. Thus, for each $V \in \square$, $\square^U[V] = \square(V, U)$, the set of all conclist maps from V to U . We write $[A|U|B]$ and sometimes $[A|B]$ for a conclist map $d_{A,B} : V \rightarrow U$, regarded as cell in $\square^U[V]$. Further, for any conclist map $d_{A,B} : U \rightarrow W$ ($A, B \subseteq W$, $U = W \setminus (A \cup B)$) we write $\square^{d_{A,B}} : \square^U \rightarrow \square^W$ for the induced pc-map given by $\square^{d_{A,B}}([C|U|D]) = [A \cup C|W|B \cup D]$.

Example 3.3. Let $U = \{a, b\}$. Then \square^U has the cells $[-| -| -]$ in the right-hand cube in Figure 2, which is reproduced below. Their first components list the events that have not yet started in this cell, the second ones the events active in U and the third ones those that have terminated.

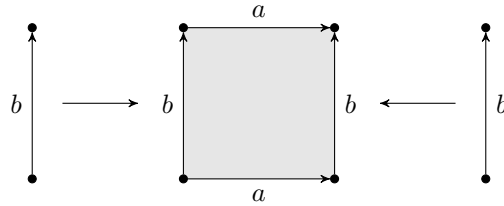
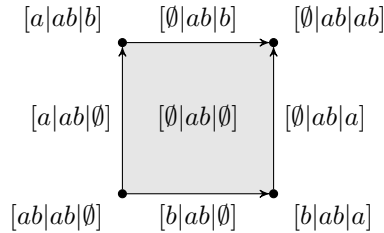

Figure 9: The standard cube \square^{ab} has two cells with event conclist $[b]$, which correspond to two pc-maps from \square^b .



As an example, $[a|ab|\emptyset]$ indicates that a has not yet started and no element has terminated in the associated face, while b is active. We have omitted set braces and likewise, as usual.

The following property of standard cubes is immediate from the Yoneda lemma.

Lemma 3.4. *For each pc-set X and $x \in X[U]$ there is a unique pc-map $\iota_x : \square^U \rightarrow X$ such that $\iota_x([\emptyset|U|\emptyset]) = x$. Hence there is a canonical bijection $X[U] \cong \square\text{Set}(\square^U, X)$. \square*

This allows representing the cells of HDAs as morphism of the precube category (hence as pc-maps); see Figure 9 for an example. We use such representations frequently in Section 12 and the subsequent ones.

4. POMSETS WITH INTERFACES

Pomsets, or partially ordered multisets, form a standard model of non-interleaving concurrency. In a nutshell, pomsets are isomorphism classes of finite node-labelled posets, where nodes represent events of concurrent systems and labels represent their actions. Associating pomsets with executions of HDAs requires some adaptations. First, we need to equip them with source and target interfaces, which are subsets of their minimal and maximal elements, respectively. Second, we add an event order, which extends the event orders of conclists. Third, we restrict our attention by and large to interval pomsets. These are based on posets whose nodes can be represented as intervals on the real line and whose (strict) order relation reflects the precedence of intervals along the real line. Interval pomsets with interfaces have been introduced as models for the behaviours of HDAs in [FJSZ21]. They capture in particular the precedences of activities of concurrent events in HDAs, as explained in Section 2. Here we recall the basic definitions.

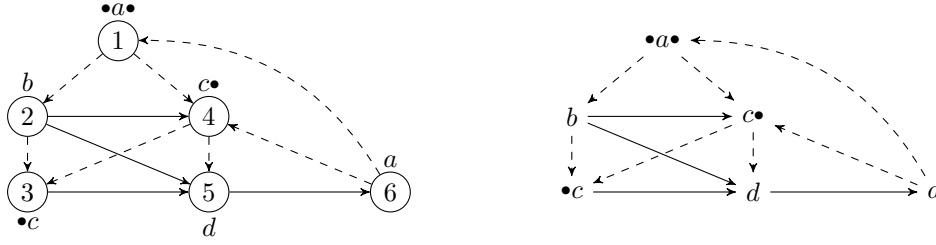

Figure 10: Hasse diagram of an iposet on the left with $P = \{1, 2, 4, 5, 6\}$, $<$ indicate by solid arrows, $S = \{1, 3\}$, $T = \{1, 4\}$, $\Sigma = \{a, b, c, d\}$ and $\lambda : 1 \mapsto a, 2 \mapsto b, 3 \mapsto c, 4 \mapsto c, 5 \mapsto d, 6 \mapsto a$, the corresponding ipomset on the right.

Iposets and ipomsets. A *labelled poset with interfaces (iposet)* $(P, <, \dashrightarrow, S, T, \lambda)$ consists of the following data:

- P is a finite set (of events);
- the *precedence* $<$ is a strict order on P ;
- the *event order* \dashrightarrow is a strict order on P , each pair in P must be comparable by $=$, $<$ or \dashrightarrow ;
- the sets $S, T \subseteq P$ form the *source* and *target interface* of P , elements of S must be $<$ -minimal and those of T $<$ -maximal;
- $\lambda : P \rightarrow \Sigma$ is a labelling function.

We write ε for the empty iposet. To indicate that action a is part of a source or target interface, we write $\bullet a$ and $a \bullet$, respectively. Hence $\bullet a \bullet$ indicates that a is part of both interfaces. See the left Hasse diagram in Figure 10 for an example.

The event order is not part of the standard definition of labelled posets in concurrency theory. It is inherited from HDAs that generate them. It is also instrumental for coordinating the gluing of iposets along their interfaces, as discussed in the next section. Unlike the event order on conclists, that on iposets need not be linear. Conclists may be regarded as iposets with empty precedence and empty interfaces. Conversely, interfaces of iposets with \dashrightarrow and labelling restricted to their elements form conclists.

Source and target interfaces allow us to model events that are active outside a given poset. This is particularly natural when events extend in time and we need to cut across them to decompose concurrent systems. Accordingly, events in a poset that do not belong to an interface start and end their activity within that poset.

A *subsumption* of an iposet P by an iposet Q is a bijection $f : P \rightarrow Q$ between the elements of P and Q such that

- $f(S_P) = S_Q$ and $f(T_P) = T_Q$;
- f is $<$ -reflecting ($f(x) <_Q f(y)$ implies $x <_P y$);
- f is \dashrightarrow -preserving on $<_P$ -incomparable elements ($x \not<_P y$, $y \not<_P x$ and $x \dashrightarrow_P y$ imply $f(x) \dashrightarrow_Q f(y)$);
- labels are respected ($\lambda_P = \lambda_Q \circ f$).

This definition adapts the standard one [Gra81] to event orders and interfaces. Intuitively, P has more order and less concurrency than Q if $P \rightarrow Q$ is a subsumption. See Figure 11 for an example.

An *isomorphism* of iposets is a subsumption that is an order isomorphism. The event order makes such isomorphisms unique. We write $P \sqsubseteq Q$ and say that P is subsumed by Q ,

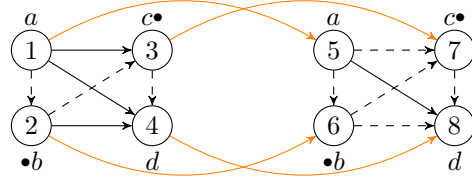

Figure 11: Subsumption map, indicated in orange, between two iposets.

or that Q subsumes P , if there exists a subsumption $P \rightarrow Q$. We write $P \cong Q$ if P and Q are isomorphic. An *ipomset* is an isomorphism class of iposets.

Intuitively, isomorphic iposets have the same order and action structure, while the identity of events has been forgotten. The uniqueness of isomorphisms allows us to switch freely between ipomsets and iposets. In particular it makes sense to say that an ipomset is subsumed by another. This is the case if one can choose representatives in the two ipomsets in such a way that the subsumption map is the identity on representatives. The Hasse diagram on the right of Figure 10 shows the ipomset corresponding to the iposet on the left.

An ipomset P is *discrete* if $<$ is empty and hence \dashrightarrow total. For each conclist $(U, \dashrightarrow_U, \lambda_U)$ and subsets $S, T \subseteq U$ we define the discrete ipomset

$${}_S U_T = (U, \emptyset, \dashrightarrow_U, S, T, \lambda_U).$$

Ipomsets ${}_U U_U$ are called *identity* ipomsets. We often write discrete ipomsets as vectors and indicate interfaces by bullets: $[\bullet^a_b \bullet]$, for instance, stands for the ipomset $\{a \dashrightarrow b\}$ with a in the source and b in the target interface.

Recall that a strict partial order $<$ on P is an *interval order* if it admits an interval representation [Fis85]: a pair $b, e : P \rightarrow \mathbb{R}$ such that $b(x) \leq e(x)$ for all $x \in P$ and $x < y$ if and only if $e(x) < b(y)$ for all $x, y \in P$. This excludes precisely the poset $2 + 2$ of shape

$$\begin{array}{ccc} w & \longrightarrow & x \\ & & \searrow \\ & & y & \longrightarrow & z \end{array}$$

as an induced subposet, so that $w < z$ or $y < x$ whenever $w < x$ and $y < z$.

This notion extends to iposets and ipomsets: an iposet is *interval* if its precedence is an interval order. We write iPoms and iiPoms for the sets of ipomsets and interval ipomsets, respectively.

Compositions. The standard serial and parallel compositions of pomsets [Gra81] can be adapted for ipomsets. The serial composition, in particular, becomes a gluing composition, as studied previously by Winkowski [Win77]. Yet he considered a less general class of ipomsets, in which interfaces are formed by all minimal and all maximal elements, respectively, and where events with the same label must be related by precedence.

The *parallel composition* $P \parallel Q$ of labelled iposets P, Q is the coproduct with respect to precedences and interfaces, while the event order is extended so that events in P are prior to those in Q . Formally, $P \parallel Q$

- has the disjoint union $P \sqcup Q$ as carrier set;
- $S_{P \parallel Q} = S_P \sqcup S_Q$ and $T_{P \parallel Q} = T_P \sqcup T_Q$;
- $<_{P \parallel Q} = <_P \sqcup <_Q$;
- $x \dashrightarrow_{P \parallel Q} y$ iff $x \dashrightarrow_P y$, $x \dashrightarrow_Q y$, or $x \in P$ and $y \in Q$;

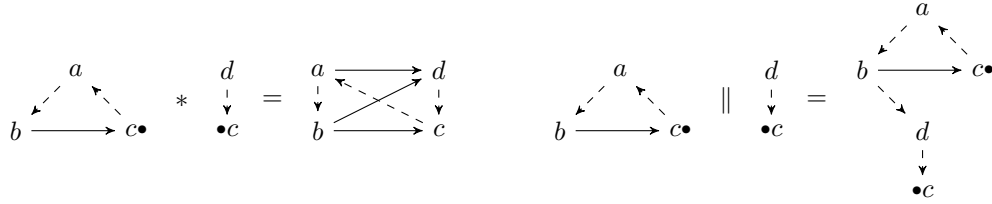

Figure 12: Gluing and parallel composition of ipomsets.

- $\lambda_{P\parallel Q}$ is the standard extension of λ_P and λ_Q to $P \sqcup Q$.

The *gluing composition* $P * Q$ of labelled ipomsets P, Q is a partial operation, defined whenever $T_P \cong S_Q$, and

- its carrier set is the quotient $(P \sqcup Q)_{/x \sim f(x)}$, where $f : T_P \rightarrow S_Q$ denotes the unique order isomorphism between these interfaces;
- $S_{P*Q} = S_P$ and $T_{P*Q} = T_Q$;
- $x <_{P*Q} y$ iff $x <_P y$, $x <_Q y$, or $x \in P \setminus T_P$ and $y \in Q \setminus S_Q$;
- \dashrightarrow_{P*Q} is the transitive closure of \dashrightarrow_P and \dashrightarrow_Q on $(P \sqcup Q)_{/x \sim f(x)}$;
- λ_{P*Q} is the standard extension of λ_P and λ_Q to $(P \sqcup Q)_{/x \sim f(x)}$.

The structural inclusions $P \hookrightarrow P * Q \hookleftarrow Q$ preserve both the precedence and the event order. The event order is crucial in this definition: it allows identifying elements of T_P with elements in S_Q in a unique way.

For ipomsets with empty interfaces, the gluing composition becomes the standard serial pomset composition [Gra81]. For ipomsets, in which interfaces are given by minimal and maximal elements and where events with the same label are related by precedence, we recover Winkowski’s definition [Win77]. In both cases we ignore of course the event order.

The gluing and parallel compositions of ipomsets respect isomorphisms and thus lift to associative, non-commutative operations on ipomsets (commutativity of \parallel is broken by the event order). Ipomsets form a category with identity ipomsets as objects, ipomsets as arrows and $*$ as composition. Examples of gluing and parallel compositions can be found in Figure 12.

Example 4.1. Interval ipomsets are closed under gluing compositions [FJSZ21], but not under parallel composition: the parallel composition of the interval ipomset $a \rightarrow b$ with itself yields the ipomset

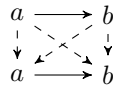

which obviously contains $2 + 2$ as an induced subposet in its precedence. So it does not have the interval property.

The following fact is important for constructing interval ipomsets from paths of HDAs in Section 5.

Proposition 4.2 [FJSZ21, Proposition 44]. *Interval ipomsets are closed under gluing composition, and all interval ipomsets can be generated by gluing finitely many discrete ipomsets.*

The *width* $\text{wid}(P)$ of an ipomset P is the cardinality of a maximal $<$ -antichain; its *size* is $\#(P) = |P| - \frac{1}{2}(|S| + |T|)$.

We glue ipomsets along interfaces and hence remove half of the interfaces when computing $\#$, which may thus be fractional. All identity ipomsets have size 0. The following lemmas are immediate consequences of the definitions.

Lemma 4.3. *Let P and Q be ipomsets. Then*

- (1) $\text{wid}(P \parallel Q) = \text{wid}(P) + \text{wid}(Q)$ and $\#(P \parallel Q) = \#(P) + \#(Q)$,
- (2) $T_P = S_Q$ implies $\text{wid}(P * Q) = \max(\text{wid}(P), \text{wid}(Q))$ and $\#(P * Q) = \#(P) + \#(Q)$,
- (3) $P \sqsubseteq Q$ implies $\text{wid}(P) \leq \text{wid}(Q)$ and $\#(P) = \#(Q)$.

Lemma 4.4.

- (1) For conclists $W \subseteq V \subseteq U$, ${}_W V_V * {}_V U_U = {}_W U_U$.
- (2) For conclists $V, W \subseteq U$ with $U = V \cup W$, ${}_V V_{V \cap W} * {}_{V \cap W} W_W \sqsubseteq {}_V U_W$.

Lemma 4.4 can be illustrated by the following pictures:

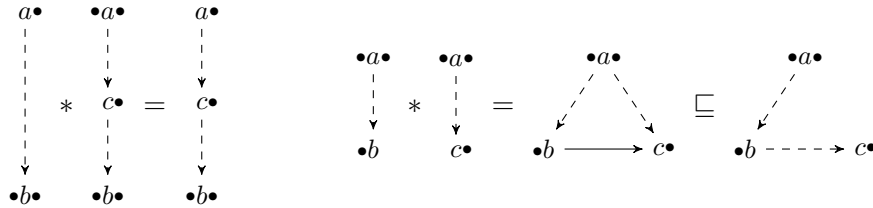

Ipomset languages and rational languages. We define an *interval ipomset language* (a *language* for short) as a subset $L \subseteq \text{iiPoms}$ that is *down-closed* with respect to subsumption: if $P \sqsubseteq Q$ and $Q \in L$, then $P \in L$. If X is a set of ipomsets, then

$$X \downarrow = \{P \in \text{iiPoms} \mid \exists Q \in X : P \sqsubseteq Q\}$$

indicates the language that is its down-closure with respect to subsumption.

We define the *rational operations* \cup , $*$, \parallel and $^+$, the Kleene plus, for languages as set union,

$$L * M = \{P * Q \mid P \in L, Q \in M, T_P = S_Q\} \downarrow,$$

$$L \parallel M = \{P \parallel Q \mid P \in L, Q \in M\} \downarrow,$$

$$L^+ = \bigcup_{n \geq 1} L^n, \quad \text{for } L^1 = L \text{ and } L^{n+1} = L * L^n.$$

Down-closure is needed because parallel compositions of interval ipomsets may not be interval ipomsets and gluing and parallel compositions of down-closed languages may not be down-closed.

Example 4.5. $\{[a] \parallel [b]\} = \{[\begin{smallmatrix} a \\ b \end{smallmatrix}]\} = \{[\begin{smallmatrix} a \\ \bullet \\ b \end{smallmatrix}]\} * \{[\begin{smallmatrix} \bullet \\ a \\ b \end{smallmatrix}]\}$ is not down-closed.

It is routine to check that gluing and parallel composition of languages are associative and that neither operation is commutative. The identity of \parallel is $\{\varepsilon\}$, that of $*$ is the *identity language* $\text{ld} = \{{}_U U_U \mid U \in \square\}$ of all identity ipomsets.

The *rational languages* are then the smallest class of languages that contains the empty language, the empty-pomset language and the singleton pomset languages

$$\emptyset, \{\varepsilon\}, \{[a]\}, \{[\bullet a]\}, \{[a \bullet]\}, \{[\bullet a \bullet]\}, \quad a \in \Sigma, \quad (4.1)$$

and that is closed under the rational operations \cup , $*$, \parallel and $^+$.

We define the *width* of a language L as the maximal width among its elements:

$$\text{wid}(L) = \sup\{\text{wid}(P) \mid P \in L\}.$$

Lemma 4.3 implies that all rational languages have finite width. The identity language Id , however, has infinite width and is therefore not rational. This explains why we consider the Kleene plus instead of the more conventional Kleene star in the definition of rationality: $L^* = \text{Id} \cup L^+$, like Id , is not rational.

Separated languages. An ipomset P is *separated* if $P \setminus (S_P \cup T_P) \neq \emptyset$, that is, it contains an “interior” element that does not belong to an interface. A language is *separated* if all its ipomsets are separated.

Lemma 4.6. *If a language L with $L \cap \text{Id} = \emptyset$ has finite width and if n is sufficiently large, then L^n is separated.*

Proof. For every ipomset $Q \in L^n$ there exists an ipomset $P = P_1 * \dots * P_n$ such that each $P_k \in L$ and $Q \sqsubseteq P$. As $\#(P_k) \geq \frac{1}{2}$, additivity of size implies

$$\#(Q) = \#(P) = \#(P_1) + \dots + \#(P_n) \geq \frac{n}{2}.$$

Thus $|S_Q|, |T_Q| \leq \text{wid}(Q) \leq \text{wid}(P) = \max_k \text{wid}(P_k) \leq \text{wid}(L)$, as gluing compositions do not increase width. Eventually,

$$|S_Q| + |T_Q| \leq 2 \text{wid}(L) < n \leq 2 \#(Q) = 2|Q| - |S_Q| - |T_Q|$$

holds for $n \geq 2 \text{wid}(L) + 1$ and therefore $|S_Q| + |T_Q| < |Q|$. \square

5. EXECUTIONS OF HIGHER-DIMENSIONAL AUTOMATA

Executions of HDAs are higher-dimensional paths that keep track of the cells and face maps traversed [vG06a]. In this section we recall their definition. As an important stepping stone towards a Kleene theorem, we then relate paths of HDAs with ipomsets – for a more general class than in [FJSZ21]. We also introduce notions of path equivalence and subsumption. The latter corresponds to ipomset subsumption. We end with a definition of regular languages.

Paths. A *path* of length n in a precubical set X is a sequence

$$\alpha = (x_0, \varphi_1, x_1, \varphi_2, \dots, \varphi_n, x_n), \tag{5.1}$$

where the $x_k \in X[U_k]$ are cells and, for all k , either

- an *up-step* $\varphi_k = d_A^0 \in \square(U_{k-1}, U_k)$, $A \subseteq U_k$ and $x_{k-1} = \delta_A^0(x_k)$ or
- a *down-step* $\varphi_k = d_B^1 \in \square(U_k, U_{k-1})$, $B \subseteq U_{k-1}$, $\delta_B^1(x_{k-1}) = x_k$.

We write $x_{k-1} \nearrow^A x_k$ for the up-steps and $x_{k-1} \searrow_B x_k$ for the down-steps in α , generally assuming that $A \neq \emptyset \neq B$. We further refer to the up- or down-steps in paths as *steps* and write P_X for the set of all paths on the precubical set X .

Example 5.1. The diagram on the right of Figure 1 in the introduction depicts the paths

$$\begin{aligned}\alpha_1 &= (\delta_{ab}^0(x) \nearrow^a \delta_b^0(x) \searrow_a \delta_{b,a}(y)), \\ \alpha_2 &= (\delta_{ab}^0(x) \nearrow^{ab} x \searrow_b \delta_b^1(x) \nearrow^c y \searrow_{ac} \delta_{ac}^1(y)), \\ \alpha_3 &= (\delta_{ab}^0(x) \nearrow^b \delta_a^0(x) \searrow_b \delta_{ac}^0(y) \nearrow^{ac} y \searrow_{ac} \delta_{ac}^1(y)).\end{aligned}$$

We define the *source* and *target* of a path α , as in formula (5.1), as $\text{src}(\alpha) = x_0$ and $\text{tgt}(\alpha) = x_n$. Each pc-map $f : X \rightarrow Y$ induces a map $f : \mathbf{P}_X \rightarrow \mathbf{P}_Y$. For α as above it is

$$f(\alpha) = (f(x_0), \varphi_1, f(x_1), \varphi_2, \dots, \varphi_n, f(x_n)). \quad (5.2)$$

The *concatenation* of paths $\alpha = (x_0, \varphi_1, \dots, x_n)$ and $\beta = (y_0, \psi_1, \dots, y_m)$ with $\text{tgt}(\alpha) = \text{src}(\beta)$ is defined as $\alpha * \beta = (x_0, \varphi_1, \dots, x_n, \psi_1, \dots, y_m)$, hence again by gluing ends. This turns \mathbf{P}_X into a category with cells of X as objects and paths as morphisms, in generalisation of the standard path categories generated by digraphs. Moreover, for $x, y \in X$, we write

$$\mathbf{P}_X(x, y) = \{\alpha \in \mathbf{P}_X \mid \text{src}(\alpha) = x, \text{tgt}(\alpha) = y\}$$

for the homset of paths from x to y .

Reachability and accessibility. The cell $y \in X$ is *reachable* from the cell $x \in X$, denoted $x \preceq y$, if there is a path from x to y in X . This reachability preorder is generated by $\delta_A^0(x) \preceq x \preceq \delta_B^1(x)$ for $x \in X$ and $A, B \subseteq \text{ev}(x)$. The precubical set X is *acyclic* if \preceq is a partial order, or equivalently, if $\mathbf{P}_X(x, x)$ contains only the constant path (x) for each $x \in X$.

A path $\alpha \in \mathbf{P}_X$ in an HDA X is *accepting* if $\text{src}(\alpha) \in X_\perp$ and $\text{tgt}(\alpha) \in X^\top$. A cell x is *accessible* if there exists a path from a start cell to x , and *co-accessible* if there is a path from x to an accept cell. A cell is *essential* if it is both accessible and co-accessible. All cells in accepting paths are essential.

Ipomsets of paths. Next we introduce a map ev that computes ipomsets of paths.

The interval ipomset $\text{ev}(\alpha)$ of a path $\alpha \in \mathbf{P}_X$ is computed recursively:

- If $\alpha = (x)$ is a path of length 0, then $\text{ev}(\alpha) = \text{ev}(x)\mathbf{ev}(x)_{\text{ev}(x)}$.
- If $\alpha = (y \nearrow^A x)$, then $\text{ev}(\alpha) = \text{ev}(x)\setminus_A \mathbf{ev}(x)_{\text{ev}(x)}$.
- If $\alpha = (x \searrow_B y)$, then $\text{ev}(\alpha) = \text{ev}(x)\mathbf{ev}(x)_{\text{ev}(x)\setminus B}$.
- If $\alpha = \beta_1 * \dots * \beta_n$ is a concatenation of steps β_i , then $\text{ev}(\alpha) = \text{ev}(\beta_1) * \dots * \text{ev}(\beta_n)$.

Interfaces and gluings of ipomsets are essential for this construction. The event order allows us to identify the target events of a preceding ipomset with the events of a succeeding one.

Example 5.2. The ipomset of the path α_1 in Example 5.1 is computed as

$$\text{ev}(\alpha_1) = \text{ev}(\delta_{ab}^0(x) \nearrow^a \delta_b^0(x)) * \text{ev}(\delta_b^0(x) \searrow_a \delta_{b,a}(y)) = \emptyset a_a * a a_\emptyset = a.$$

Those of the other two paths in the example are $\text{ev}(\alpha_2) = a \parallel (b \rightarrow c)$ and $\text{ev}(\alpha_3) = b * \begin{bmatrix} a \\ c \end{bmatrix}$. Figure 4 contains an additional example.

Proposition 4.2 guarantees the following important structural property.

Lemma 5.3. *For each path $\alpha \in \mathbf{P}_X$, $\text{ev}(\alpha)$ is an interval ipomset.*

The following facts are immediate from the definition of ev and induced paths maps, as well as associativity of gluing composition.

Lemma 5.4. *Let $\alpha, \beta \in \mathbf{P}_X$. Then $\text{ev}(\alpha * \beta) = \text{ev}(\alpha) * \text{ev}(\beta)$ whenever $\text{tgt}(\alpha) = \text{src}(\beta)$.*

Lemma 5.5. *If $f : X \rightarrow Y$ is a pc-map and $\alpha \in P_X$, then $\text{ev}(f(\alpha)) = \text{ev}(\alpha)$.*

Event consistency for paths. Let X be an HDA. For any path $\alpha = (x_0, \varphi_1, \dots, x_n) \in P_X$, the conclists $\text{ev}(x_k)$ are defined only up to isomorphism. Similarly, the φ_k are morphisms in \square and not actual conclist maps, but rather their equivalence classes. The next lemma allows choosing conclists and conclist maps as representatives in a consistent way, and using the simple composition of conclist maps in formula (3.1) in calculations.

Lemma 5.6. *For every $\alpha = (x_0, \varphi_1, \dots, x_n) \in P_X$ there exist conclists $U_0, \dots, U_n \subseteq \text{ev}(\alpha)$ such that $\text{ev}(x_k) = U_k$ and either*

- $U_{k-1} \subseteq U_k$ and $\varphi_k = d_{U_k \setminus U_{k-1}}^0 : U_{k-1} \rightarrow U_k$ or
- $U_{k-1} \supseteq U_k$ and $\varphi_k = d_{U_{k-1} \setminus U_k}^1 : U_k \rightarrow U_{k-1}$.

Proof. The structural inclusion

$$\text{ev}(x_k) \subseteq \text{ev}(x_0, \varphi_1, \dots, x_k) * \text{ev}(x_k) * \text{ev}(x_k, \varphi_{k+1}, \dots, x_n)$$

defines an ipomset inclusion $j_k : \text{ev}(x_k) \subseteq \text{ev}(\alpha)$. So let $U_k = j_k(\text{ev}(x_k))$. If $\varphi_k = d_A^0$ is an up-step, then $U_{k-1} \subseteq U_k$ and $x_{k-1} = \delta_{U_k \setminus U_{k-1}}^0(x_k)$; if $\varphi_k = d_B^1$ is a down-step, then $U_k \subseteq U_{k-1}$ and $x_k = \delta_{U_{k-1} \setminus U_k}^1(x_{k-1})$. \square

Note that if $x_i = x_j$ for $i \neq j$, then U_i and U_j are different, but isomorphic subsets of $\text{ev}(\alpha)$. Henceforth we choose conclists of cells in paths as in Lemma 5.6. This simplifies calculations and underlines the relevance of \square as a base category for precubical sets.

Path equivalence and subsumption. *Path equivalence* is the congruence \simeq on P_X generated by

- (1) $(z \nearrow^A y \nearrow^B x) \simeq (z \nearrow^{A \cup B} x)$,
- (2) $(x \searrow_A y \searrow_B z) \simeq (x \searrow_{A \cup B} z)$,
- (3) $\gamma * \alpha * \delta \simeq \gamma * \beta * \delta$ whenever $\alpha \simeq \beta$.

Further, *path subsumption* is the transitive relation \sqsubseteq on P_X generated by

- (4) $(y \searrow_B w \nearrow^A z) \sqsubseteq (y \nearrow^A x \searrow_B z)$, for disjoint $A, B \subseteq \text{ev}(x)$,
- (5) $\gamma * \alpha * \delta \sqsubseteq \gamma * \beta * \delta$ whenever $\alpha \sqsubseteq \beta$,
- (6) $\alpha \sqsubseteq \beta$ whenever $\alpha \simeq \beta$.

We say that β *subsumes* α if $\alpha \sqsubseteq \beta$.

Intuitively, if β subsumes α , then β is more concurrent than α and α more sequential than β . Both \simeq and \sqsubseteq preserve sources and targets of paths, and they translate to ipomsets as follows.

Lemma 5.7. *If $\alpha, \beta \in P_X$, then*

- (1) $\alpha \simeq \beta \Rightarrow \text{ev}(\alpha) = \text{ev}(\beta)$,
- (2) $\alpha \sqsubseteq \beta \Rightarrow \text{ev}(\alpha) \sqsubseteq \text{ev}(\beta)$.

Proof. We need to check items (1)–(6) from the definition of path equivalence and subsumption. Item (1) holds because

$$\begin{aligned}
\text{ev}(z \nearrow^A y \nearrow^B x) &= \text{ev}(z \nearrow^A y) * \text{ev}(y \nearrow^B x) && \text{(Lemma 5.4)} \\
&= \text{ev}(y) \setminus_A \text{ev}(y)_{\text{ev}(y)} * \text{ev}(x) \setminus_B \text{ev}(x)_{\text{ev}(x)} \\
&= \text{ev}(z) \text{ev}(y)_{\text{ev}(y)} * \text{ev}(y) \text{ev}(x)_{\text{ev}(x)} \\
&= \text{ev}(z) \text{ev}(x)_{\text{ev}(x)} && \text{(Lemma 4.4.(1))} \\
&= \text{ev}(x) \setminus_{(A \cup B)} \text{ev}(x)_{\text{ev}(x)} \\
&= \text{ev}(z \nearrow^{A \cup B} x),
\end{aligned}$$

The proof of (2) is similar and (3) follows immediately from Lemma 5.4. For (4), fix $x \in X$ and suppose $A, B \subseteq \text{ev}(x)$ are disjoint subsets. Let $y = \delta_A^0(x)$, $z = \delta_B^1(x)$, $w = \delta_{A,B}(x)$ and denote $U = \text{ev}(x)$, $V = U \setminus A = \text{ev}(y)$, $W = U \setminus B = \text{ev}(z)$. Then

$$\begin{aligned}
\text{ev}(y \searrow_A w \nearrow^B z) &= \text{ev}(y \searrow_A w) * \text{ev}(w \nearrow^B z) && \text{(Lemma 5.4)} \\
&= \text{ev}(y) \text{ev}(y)_{\text{ev}(y) \setminus A} * \text{ev}(z) \setminus_B \text{ev}(z)_{\text{ev}(z)} \\
&= V V_{V \cap W} * V \cap W W_W \\
&\sqsubseteq V U_W = V U_U * U U_W && \text{(Lemma 4.4.(2))} \\
&= \text{ev}(x) \setminus_A \text{ev}(x)_{\text{ev}(x)} * \text{ev}(x) \text{ev}(x)_{\text{ev}(x) \setminus B} \\
&= \text{ev}(z \nearrow^A x \searrow_B z).
\end{aligned}$$

Finally, (5) follows again from Lemma 5.4 and (6) is straightforward. \square

Example 5.8. It is easy to check that the path α_3 in Example 5.1 is subsumed by α_2 , and so are the corresponding pomsets in Example 5.2: $\text{ev}(\alpha_3) = b * \begin{bmatrix} a \\ c \end{bmatrix} \sqsubseteq a \parallel (b \rightarrow c) = \text{ev}(\alpha_2)$.

Regular languages. An ipomset P is *recognised* by the HDA X if $P = \text{ev}(\alpha)$ for some accepting path α of X . We write

$$\text{Lang}(X) = \{\text{ev}(\alpha) \mid \alpha \in \mathbf{P}_X \text{ is accepting}\}$$

for the set of interval ipomsets recognised by X . The language L is *regular* if it is recognised by an HDA, that is, $L = \text{Lang}(X)$ for some HDA X .

Every regular language is down-closed by Proposition 8.3 below and an interval ipomset language by Lemma 5.3.

Lemma 5.9. *Regular languages have finite width.*

Proof. Let X be an HDA. We show that $\text{wid}(\text{Lang}(X)) \leq \dim(X)$. It is clear that $\text{wid}(\text{ev}(\alpha)) \leq \dim(X)$ for any path α in X . The claim then follows by Lemma 4.3. \square

By a distant analogy with topology, we call an HDA map $f : X \rightarrow Y$ a *weak equivalence* if for every accepting path $\beta \in \mathbf{P}_Y$ there exists an accepting path $\alpha \in \mathbf{P}_X$ with $f(\alpha) = \beta$ with respect to the induced $f : \mathbf{P}_X \rightarrow \mathbf{P}_Y$ defined in (5.2).

Lemma 5.10. *Let $f : X \rightarrow Y$ be an HDA-map. Then*

- (1) $\text{Lang}(X) \subseteq \text{Lang}(Y)$,
- (2) *if f is a weak equivalence, then $\text{Lang}(X) = \text{Lang}(Y)$.*

Proof. Suppose $P \in \text{Lang}(X)$. Then there is an accepting path $\alpha \in P_X$ such that $\text{ev}(\alpha) = P$. Thus the induced path $f(\alpha)$ is also accepting and $P = \text{ev}(\alpha) = \text{ev}(f(\alpha)) \in \text{Lang}(Y)$ by Lemma 5.5. The second claim is clear. \square

We conclude this section with two elementary facts about regular languages.

Proposition 5.11. *The empty language, the empty-pomset language and the singleton pomset languages in (4.1) are regular.*

Proof. These languages are recognised by the following HDAs:

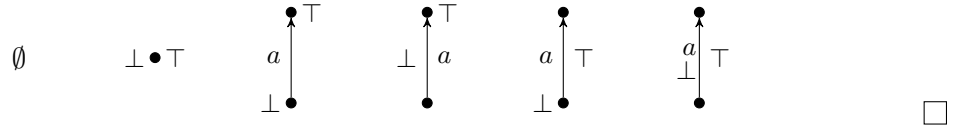

Proposition 5.12. *Finite unions of regular languages are regular.*

Proof. $\text{Lang}(X \sqcup Y) = \text{Lang}(X) \cup \text{Lang}(Y)$, where the HDA $X \sqcup Y$ is the coproduct of the HDAs X and Y . \square

6. KLEENE THEOREM

We can now state the Kleene theorem for HDAs, which relates them with interval ipomset languages. In this section, we also provide a roadmap towards its proof. Technical details and advanced concepts needed for it are introduced in the remaining sections of this article.

Theorem 6.1 (Kleene theorem for HDAs). *A language is regular if and only if it is rational.*

The Kleene theorem follows from a series of propositions, which we explain in the sequel. First we outline its left-to-right direction.

Proposition 6.2. *Every regular language is rational.*

This proposition is obtained from a translation to the Kleene theorem for standard finite state automata in Section 7. For each HDA we construct a standard automaton with an alphabet ranging over discrete ipomsets, and we show that it accepts the same language as the HDA.

Proving the right-to-left direction of Theorem 6.1 is harder. Our proof follows that of the classical Kleene theorem. We inductively construct HDAs that accept the generators of rational languages and the languages obtained by application of the rational operations to regular languages. We have already shown (Propositions 5.11 and 5.12) that the empty language, the empty-pomset language and the singleton pomset languages are regular, and that regularity is preserved by finite unions. So it remains to prove that the remaining rational operations – parallel compositions, gluing composition and the Kleene plus – preserve regularity as well.

Proposition 6.3. *Parallel compositions of regular languages are regular.*

In Section 9 we introduce tensor products of HDAs and show that tensor products of HDAs recognise the parallel composition of their languages. The proof uses an alternative definition of languages of HDAs via track objects, introduced in Section 8.

The corresponding proofs for gluing compositions and the Kleene plus are more intricate and require additional machinery. They constitute the main technical contribution of this paper, and the tools introduced may be of independent interest.

Proposition 6.4. *Gluing compositions of regular languages are regular.*

Proposition 6.5. *The Kleene plus of a regular language is regular.*

The ideas behind the proofs of these propositions are outlined in the remainder of this section; the proofs themselves are developed in Sections 10 to 15. The left-to-right direction of the Kleene theorem then follows.

Corollary 6.6. *Every rational language is regular.*

Proof. By Propositions 5.11, 5.12 and 6.3–6.5. □

It then remains to reap what we have sown.

Proof of Theorem 6.1. By Proposition 6.2 and Corollary 6.6. □

The ideas behind the proofs of Propositions 6.4 and 6.5 and the intricacies encountered are similar. We focus on Proposition 6.4 because the tools needed for proving Proposition 6.5 are more complicated.

Our goal in the proof of Proposition 6.4 is the construction, for each pair of HDAs X and Y , of an HDA Z that recognises $\text{Lang}(X) * \text{Lang}(Y)$. For simplicity, we assume that both HDAs have one start cell ($X_{\perp} = \{x_{\perp}\}$, $Y_{\perp} = \{y_{\perp}\}$) and one accept cell ($X^{\top} = \{x^{\top}\}$, $Y^{\top} = \{y^{\top}\}$), respectively. We further assume that the conclists of x^{\top} and y_{\perp} agree: $\text{ev}(x^{\top}) = \text{ev}(y_{\perp}) = U$. A natural candidate for Z is the HDA obtained from $X \sqcup Y$ by identifying x^{\top} in X and y_{\perp} in Y , or more formally, from a *gluing composition* of X and Y defined as

$$X * Y = \text{colim} \left(X \xleftarrow{\iota_{x^{\top}}} \square^U \xrightarrow{\iota_{y_{\perp}}} Y \right).$$

It is then routine to check that $\text{Lang}(X) * \text{Lang}(Y) \subseteq \text{Lang}(X * Y)$.

For standard finite automata X, Y , this construction yields indeed $\text{Lang}(X * Y) = \text{Lang}(X) * \text{Lang}(Y)$ whenever there are no transitions from x^{\top} into a state of X and no transitions from a state of Y into y_{\perp} . Otherwise, Z could allow scanning strings in $\text{Lang}(X)$ after having started scanning strings in $\text{Lang}(Y)$. For HDAs, we thus need a construction that brings X and Y into a similar shape to prevent such backdoor scanning. A second complication that is particular to HDAs is that gluing compositions $X * Y$ not only identify x^{\top} and y_{\perp} . Paths that do not cross the “gluing” cell may therefore appear and contribute to the language of $X * Y$, though their prefixes or suffixes are not in the language of X or Y , see Figure 13.

We introduce two tools to deal with this situation. First, we introduce higher-dimensional automata with interfaces (iHDAs) in Section 10 as an alternative to HDAs, which allows us to mark events that cannot terminate and those that cannot be unstated in an HDA, and to trace such elements across cells. HDAs and iHDAs are related to each other via a pair of language-preserving functors $\text{Res} : \text{HDA} \rightarrow \text{iHDA}$ and $\text{Cl} : \text{iHDA} \rightarrow \text{HDA}$, introduced in Section 11, which we call *resolution* and *closure*. In particular, we use these functors to show that HDAs and iHDAs recognise the same class of regular languages. This allows us to work with both kinds of automata, depending on the context, but using iHDAs guarantees better properties of some of our gluing constructions.

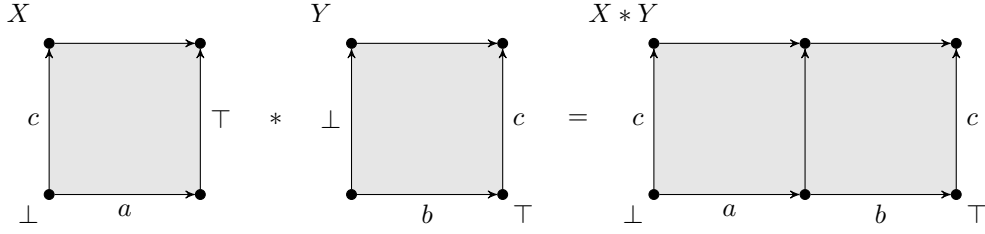

Figure 13: The language of gluings of HDAs need not be the gluing composition of their languages: $\text{Lang}(Y) = \emptyset$, but $ab \in \text{Lang}(X * Y) \neq \text{Lang}(X) * \text{Lang}(Y) = \emptyset$.

Second, we introduce a construction that removes transitions into start cells or out of accept cells – but generally not both – and which separates start or accept cells, so that the sets of their faces are disjoint. The resulting iHDAs are called (start or accept) proper. To enable this construction, we introduce cylinders in Section 12. It is once again important for gluing HDAs in a principled way.

In Sections 13 and 14 we use these tools to prove Proposition 6.4. Finally, in Section 15, we prove Proposition 6.5 while dealing with the additional issue that iHDAs are generally not both start and accept proper.

7. REGULAR LANGUAGES ARE RATIONAL

In this section we construct for any finite HDA a finite automaton that recognises essentially the same language, in a sense explained below.

Let X be an HDA with $\dim(X) = n$. We define the automaton $G(X) = (\Omega, Q, I, E, F)$ by the following data:

- The *input alphabet* Ω consists of the set of discrete ipomsets with at most n elements.
- The *set of states* $Q = \text{Cell}(X) \cup \{x_\perp \mid x \in X_\perp\}$. The states of $G(X)$ are the cells of X with an extra copy of every start cell added.
- The *start states* $I = \{x_\perp \mid x \in X_\perp\}$ and the *accept states* $F = \{x \mid x \in X^\top\}$.
- The *set of transitions* E is given by:
 - For every $x \in X[U]$ and $A \subseteq U$ there is a transition $d_A^0 : \delta_A^0(x) \rightarrow x$ labelled with $(U \setminus A)U_U$.
 - For every $x \in X[U]$ and $B \subseteq U$ there is a transition $d_B^1 : x \rightarrow \delta_B^1(x)$ labelled with $U(U \setminus B)$.
 - For every $x \in X_\perp$, $x \in X[U]$, there is a transition $q_x : x_\perp \rightarrow x$ labelled with UU_U .

We write $\text{Lang}(G(X))$ for the language of words over Ω recognised by the automaton $G(X)$, and $\text{P}_{G(X)}$ for the set of paths in $G(X)$.

Example 7.1. Figure 14 shows an example for the construction of the standard automaton $G(X)$ from a simple HDA X .

Proposition 7.2. $\text{Lang}(X) = \{P_1 * P_2 * \dots * P_n \mid P_1 P_2 \dots P_n \in \text{Lang}(G(X)), n \geq 1\}$.

Proof. There is a one-to-one correspondence between the accepting paths in X and $G(X)$:

$$\text{P}_X \ni \alpha = (x_0, \varphi_1, x_1, \dots, x_n) \mapsto \left((x_0)_\perp \xrightarrow{q_x} x_0 \xrightarrow{\varphi_1} x_1 \xrightarrow{\varphi_2} \dots \xrightarrow{\varphi_n} x_n \right) = \omega \in \text{P}_{G(X)}.$$

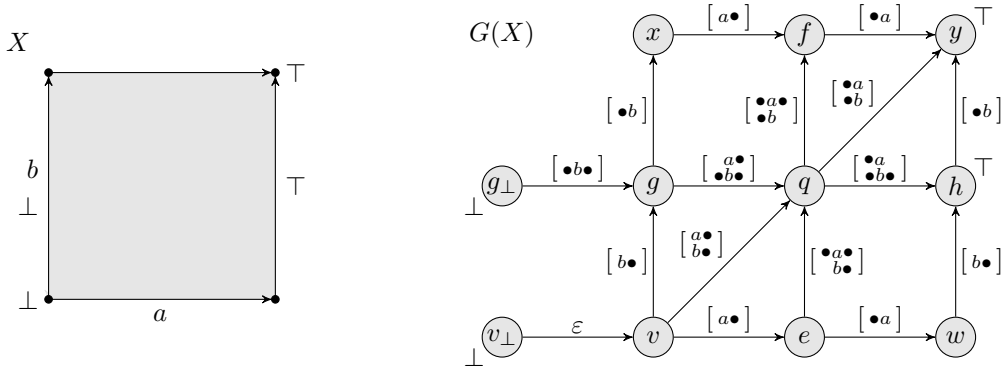

Figure 14: An HDA X and the corresponding standard finite automaton $G(X)$.

Suppose $\beta_i = \text{ev}(x_{i-1}, \varphi_i, x_i)$, which is a discrete ipomset. If

$$Q = \text{ev}(\alpha) = \text{ev}(\beta_1) * \cdots * \text{ev}(\beta_n) \in \text{Lang}(X),$$

then $\text{ev}(x_0) \text{ev}(\beta_1) \cdots \text{ev}(\beta_n) \in \text{Lang}(G(X))$. This shows the inclusion \subseteq .

If $P_1 P_2 \cdots P_n \in \text{Lang}(G(X))$ is recognised by a path ω , then P_1 is an identity pomset. If the corresponding path α in X is not constant, then it recognises $P_2 * \cdots * P_n = P_1 * \cdots * P_n$. If α is constant, then it recognises P_1 (and $n = 1$). This shows \supseteq . \square

We have added copies of start cells in the definition above to avoid states in $G(X)$ that are both start and accept states. Otherwise, constant paths in $G(X)$ could recognise the empty word while their counterparts in X would recognise non-empty identity ipomsets.

Proof of Proposition 6.2. Let X be an HDA of dimension n . Then $\text{Lang}(G(X))$ is a regular language over Ω that does not contain the empty word. The Kleene theorem for finite state automata thus guarantees that $\text{Lang}(G(X))$ can be represented by a regular expression $w(U_1, \dots, U_n)$ with operations \cup , $*$ and $(-)^+$ and $U_i \in \Omega$.

Each U_i can be presented as a parallel composition $U_i = e_i^1 \parallel \cdots \parallel e_i^{k(i)}$ of singleton ipomsets. Using Proposition 7.2, we conclude that $\text{Lang}(X)$ is represented by

$$w(e_1^1 \parallel \cdots \parallel e_1^{k(1)}, \dots, e_n^1 \parallel \cdots \parallel e_n^{k(n)})$$

and therefore rational. \square

Remark 7.3. The proof above, in combination with the other direction of the Kleene theorem (Corollary 6.6), implies that any regular expression can be normalised so that parallel compositions appear below all other operators in parse trees. For example,

$$\{a\}^+ \parallel \{b\} = (\{a\} \parallel \{b\}) \cup (\{a\bullet\} \parallel \{b\bullet\}) * ((\{a\bullet\} \parallel \{b\bullet\}) * (\{a\bullet\} \parallel \{b\bullet\}))^+ * (\{a\bullet\} \parallel \{b\bullet\}).$$

8. TRACK OBJECTS AND TRACKS

Track objects and tracks on HDAs have been introduced in [FJSZ21]. They provide an alternative description of the executions and languages of HDAs, which is more abstract, and sometimes more convenient. Like cells of an HDA can be represented as pc-maps from standard cubes (see Lemma 3.4), paths can be represented as maps from track objects. Here

we extend results on tracks, which we proved for the subclass of event consistent HDAs in [FJSZ21], to general HDAs, as they are needed in our constructions.

The *track object* \square^P of an ipomset P is an HDA defined as follows.

- $\square^P[U]$ is the set of functions $c : P \rightarrow \{0, \ulcorner, 1\}$ such that $c^{-1}(\ulcorner) \cong U$ and for all $p, q \in P$,

$$p < q \implies (c(p), c(q)) \in \{(0, 0), (\ulcorner, 0), (1, 0), (1, \ulcorner), (1, 1)\}. \quad (8.1)$$

- For $A, B \subseteq U \cong c^{-1}(\ulcorner)$ with $A \cap B = \emptyset$,

$$\delta_{A,B}(c)(p) = \begin{cases} 0 & \text{if } c(p) = 0 \text{ or } p \in A, \\ \ulcorner & \text{if } p \in U \setminus (A \cup B), \\ 1 & \text{if } c(p) = 1 \text{ or } p \in B. \end{cases}$$

- \square^P has one source cell c_{\perp}^P and one target cell c_P^{\top} :

$$c_{\perp}^P(p) = \begin{cases} \ulcorner & \text{for } p \in S_P, \\ 0 & \text{for } p \notin S_P, \end{cases} \quad c_P^{\top}(p) = \begin{cases} \ulcorner & \text{for } p \in T_P, \\ 1 & \text{for } p \notin T_P. \end{cases}$$

A cell c of \square^P can be regarded as a temporary snapshot of an execution of events in P : for $p \in P$, $c(p)$ is 0 if p has not yet started, \ulcorner if p is currently active and 1 if p has terminated. This clearly enforces condition (8.1).

See [FJSZ21, Example 61] for the construction of a track object of a particular ipomset.

Lemma 8.1 [FJSZ21, Proposition 92]. $\text{Lang}(\square^P) = \{P\}_{\downarrow}$.

The following proposition relates paths with track objects.

Proposition 8.2. *Let X be a precubical set, x and y cells of X and P an ipomset. The following conditions are equivalent:*

- (1) *There exists a path $\alpha \in \mathbf{P}_X(x, y)$ such that $\text{ev}(\alpha) = P$.*
- (2) *There exists a pc-map $f : \square^P \rightarrow X$ such that $f(c_{\perp}^P) = x$ and $f(c_P^{\top}) = y$.*

Thus, for each HDA X ,

$$\text{Lang}(X) = \{P \in \text{iiPoms} \mid \text{HDA}(\square^P, X) \neq \emptyset\}.$$

Proof. (2) \implies (1) There exists a path $\beta \in \mathbf{P}_{\square^P}(c_{\perp}^P, c_P^{\top})$ such that $\text{ev}(\beta) = P$ (see [FJSZ21, Proposition 67] for further information). So $\alpha = f(\beta)$ satisfies the conditions required.

(1) \implies (2) By induction on the length n of α . First, suppose $n = 0, 1$. We abbreviate $U = \text{ev}(x)$. If $\alpha = (x)$, then $\square^P = \square^U$, $c_{\perp}^P = c_P^{\top} = [\emptyset|U|\emptyset]$ and then $f = \iota_x$ satisfies (b). If $\alpha = (x \searrow_B \delta_B^1(x))$ is a down-step, then $P = {}_U U \cup_{\setminus B}$, $\square^P = \square^U$, $c_{\perp}^P = [\emptyset|U|\emptyset]$, $c_P^{\top} = [\emptyset|U|B]$, and, as before, $f = \iota_x$ satisfies (b). The proof for up-steps is symmetric.

If $n > 1$, then $\alpha = \beta * \gamma$ for paths β, γ of length $< n$. We write $z = \text{tgt}(\beta) = \text{src}(\gamma)$, $Q = \text{ev}(\beta)$, $R = \text{ev}(\gamma)$ for short. By the inductive hypothesis, there are precubical maps $g : \square^Q \rightarrow X$ and $h : \square^R \rightarrow X$ such that $g(c_{\perp}^Q) = x$, $g(c_Q^{\top}) = h(c_{\perp}^R) = z$ and $h(c_R^{\top}) = y$. Let $U = \text{ev}(z) \cong T_Q \cong S_R$. By [FJSZ21, Lemma 65], there is a pushout diagram

$$\begin{array}{ccc} \square^Q & \xrightarrow{j_Q} & \square^P \\ \uparrow \iota_{c_Q^{\top}} & & \uparrow j_R \\ \square^U & \xrightarrow{\iota_{c_{\perp}^R}} & \square^R \end{array}$$

such that $j_Q(c_\perp^Q) = c_\perp^P$ and $j_R(c_R^\top) = c_P^\top$. Since $g \circ \iota_{c_\perp^Q} = \iota_z = h \circ \iota_{c_\perp^R}$, by the universal property of pushouts, the maps g and h glue to a map $f : \square^P \rightarrow X$. Moreover, we have $f(c_\perp^P) = f(j_Q(c_\perp^Q)) = g(c_\perp^Q) = x$ and $f(c_P^\top) = f(j_R(c_R^\top)) = h(c_R^\top) = y$. \square

Proposition 8.3. *Languages of HDAs are down-closed with respect to subsumption.*

Proof. Let X be an HDA. If $P \sqsubseteq Q$ and $Q \in \mathbf{Lang}(X)$ then there is an HDA-map $\square^Q \rightarrow X$ by Proposition 8.2 and $P \in \mathbf{Lang}(\square^Q)$ by Lemma 8.1. Thus $P \in \mathbf{Lang}(X)$ by Lemma 5.10. \square

9. TENSOR PRODUCT OF HIGHER-DIMENSIONAL AUTOMATA

The *tensor product* of HDAs X and Y is the HDA $X \otimes Y$ defined, for $U, V, W \in \square$, $x \in X[V]$, $y \in Y[W]$ and $A, B \subseteq U$ as

$$\begin{aligned} (X \otimes Y)[U] &= \bigcup_{V \parallel W = U} X[V] \times Y[W], \\ \delta_{A,B}(x, y) &= (\delta_{A \cap V, B \cap V}(x), \delta_{A \cap W, B \cap W}(y)), \\ (X \otimes Y)_\perp &= X_\perp \times Y_\perp, \\ (X \otimes Y)^\top &= X^\top \times Y^\top. \end{aligned}$$

See [FJSZ21, Example 107] for an example. The following proposition is shown for event-consistent HDAs in [FJSZ21, Theorem 108]. We need a proof without this restriction.

Proposition 9.1. *Let X and Y be HDAs. Then $\mathbf{Lang}(X \otimes Y) = \mathbf{Lang}(X) \parallel \mathbf{Lang}(Y)$.*

Proof. For $\mathbf{Lang}(X) \parallel \mathbf{Lang}(Y) \subseteq \mathbf{Lang}(X \otimes Y)$ the argument in [FJSZ21, Theorem 108] works: if $P \in \mathbf{Lang}(X) \parallel \mathbf{Lang}(Y)$, then, by definition, there are $Q \in \mathbf{Lang}(X)$ and $R \in \mathbf{Lang}(Y)$ such that $P \sqsubseteq Q \parallel R$. By Proposition 8.2, there are HDA-maps $\alpha : \square^Q \rightarrow X$ and $\beta : \square^R \rightarrow Y$. Their composition

$$\square^P \rightarrow \square^{Q \parallel R} \cong \square^Q \otimes \square^R \xrightarrow{\alpha \otimes \beta} X \otimes Y$$

shows that $P \in \mathbf{Lang}(X \otimes Y)$. Finally, the isomorphism $\square^{Q \parallel R} \cong \square^Q \otimes \square^R$ is shown in [FJSZ21, Lemma 105].

The proof of the converse direction in [FJSZ21] depends on event consistency, so we need another one. Suppose $\alpha = ((x_0, y_0), \varphi_1, \dots, (x_n, y_n)) \in \mathbf{P}_{X \otimes Y}$, and $x_k \in X[U_k]$ as well as $y_k \in Y[V_k]$, for $k = 0, \dots, n$. For any k ,

- if $\varphi_k = d_A^0 \in \square(U_{k-1} \parallel V_{k-1}, U_k \parallel V_k)$, then we put $\psi_k = d_{A \cap U_k}^0 \in \square(U_{k-1}, U_k)$ and $\omega_k = d_{A \cap V_k}^0 \in \square(V_{k-1}, V_k)$.
- If $\varphi_k = d_B^1$, we put $\psi_k = d_{B \cap U_{k-1}}^1$ and $\omega_k = d_{B \cap V_{k-1}}^1$.

It is then routine to check that $\beta = (x_0, \psi_0, \dots, x_n) \in \mathbf{P}_X$ and $\gamma = (y_0, \omega_0, \dots, y_n) \in \mathbf{P}_Y$. We write $\pi_X(\alpha) = \beta$, $\pi_Y(\alpha) = \gamma$.

We prove that $\mathbf{ev}(\alpha) \sqsubseteq \mathbf{ev}(\beta) \parallel \mathbf{ev}(\gamma)$ by induction on n . If $n = 1$ and α is an up-step, then

$$\mathbf{ev}(\alpha) = (u_0 \parallel v_0)(U_1 \parallel V_1)_{(U_1 \parallel V_1)} = u_0(U_1)_{U_1} \parallel v_0(V_1)_{V_1} = \mathbf{ev}(\beta) \parallel \mathbf{ev}(\gamma).$$

For down-step the same formula holds by symmetry. The case $n = 0$ is similar.

If $n > 1$, then α can be decomposed into a non-trivial composition $\alpha = \alpha' * \alpha''$. Let $\beta' = \pi_X(\alpha')$, $\gamma' = \pi_Y(\alpha')$, $\beta'' = \pi_X(\alpha'')$, $\gamma'' = \pi_Y(\alpha'')$. Using the inductive hypothesis and the weak interchange law $(P \parallel P') * (Q \parallel Q') \sqsubseteq (P * Q) \parallel (P' * Q')$ of ipomsets [FJSZ22b],

$$\begin{aligned} \text{ev}(\alpha) &= \text{ev}(\alpha') * \text{ev}(\alpha'') \\ &\sqsubseteq (\text{ev}(\beta') \parallel \text{ev}(\beta'')) * (\text{ev}(\gamma') \parallel \text{ev}(\gamma'')) \\ &\sqsubseteq (\text{ev}(\beta') * \text{ev}(\beta'')) \parallel (\text{ev}(\gamma') * \text{ev}(\gamma'')) \\ &= \text{ev}(\beta' * \beta'') \parallel \text{ev}(\gamma' * \gamma'') \\ &= \text{ev}(\beta) \parallel \text{ev}(\gamma). \end{aligned}$$

Now let $P \in \text{Lang}(X \otimes Y)$ and let $\alpha \in \mathbf{P}_{X \otimes Y}$ be an accepting path such that $\text{ev}(\alpha)$. Then both $\beta = \pi_X(\alpha) \in \mathbf{P}_X$ and $\gamma = \pi_Y(\alpha) \in \mathbf{P}_Y$ are accepting, and

$$P = \text{ev}(\alpha) \sqsubseteq \text{ev}(\beta) \parallel \text{ev}(\gamma).$$

As $\text{ev}(\alpha) \in \text{Lang}(X)$ and $\text{ev}(\beta) \in \text{Lang}(Y)$, down-closure yields $P \in \text{Lang}(X) \parallel \text{Lang}(Y)$. \square

It follows that parallel compositions of regular languages are regular.

Proof of Proposition 6.3. Let L and M be regular languages. Then $L = \text{Lang}(X)$ and $M = \text{Lang}(Y)$ for some HDA X and Y . Thus $L \parallel M = \text{Lang}(X) \parallel \text{Lang}(Y) = \text{Lang}(X \otimes Y)$ is recognised by $X \otimes Y$ by Proposition 9.1 and therefore regular. \square

10. HIGHER-DIMENSIONAL AUTOMATA WITH INTERFACES

In this section we introduce higher-dimensional automata with interfaces (iHDAs). The main difference to HDAs is that the elements in the lists of concurrent events that are assigned to cells are now equipped with interfaces. Every event of an iHDA can thus be labelled as a source event or a target event, or as both. Target events may not be terminated while source events cannot be “unstarted”. Moreover, start cells must only contain source events, and target cells only target events. The advantage of this variant is that source and target events of an iHDA can be traced along its execution, as shown for instance in Figure 16 below.

Concurrency lists with interfaces. A *concurrency list with interfaces* (*iconclist*) is a triple (S, U, T) of a conclist U , a *source interface* $S \subseteq U$ and a *target interface* $T \subseteq U$.

We also write ${}_S U_T$ or just U for an iconclist (S, U, T) . In the latter case, we write S_U and T_U for the interfaces of U . Conclists may be regarded as iconclists with empty interfaces and iconclists as discrete ipomsets.

An *ilo-map* $f : U \rightarrow V$ is an lo-map that also satisfies $S_U = f^{-1}(S_V)$ and $T_U = f^{-1}(T_V)$. An *iconclist isomorphism* is an invertible ilo-map. We write $U \cong V$ if iconclists U and V are isomorphic.

As for conclists, there is at most one isomorphism between iconclists. Isomorphism classes of iconclists can be modelled as words over the extended alphabet $\Sigma_\bullet = \{a, \bullet a, a\bullet, \bullet a\bullet \mid a \in \Sigma\}$, where $\bullet a$ indicates membership in a source interface and so on. As in Figure 1, we represent such words as column vectors.

Let $U = (S_U, U, T_U)$ and $V = (S_V, V, T_V)$ be iconclists. An *iconclist map* from U to V is a conclist map $d_{A,B} : U \rightarrow V$ such that

- source and target events are preserved: $d_{A,B}^{-1}(S_V) = S_U$ and $d_{A,B}^{-1}(T_V) = T_U$,

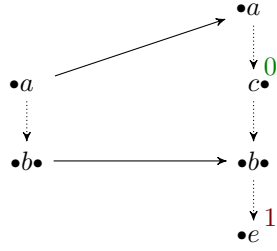

Figure 15: An example of an iconclist map. Annotations 0 and 1 indicate events that have not yet started (0) or terminated (1), as in Figure 7. Bullets indicate source and target interfaces. Note that $c\bullet$ cannot be marked by 1 since it is in the target interface; similarly, $\bullet e$ cannot be marked by 0. No marking is possible for $\bullet b\bullet$ and thus it must be in the image.

- source events cannot be unstated and target events not be terminated: $A \cap S_V = \emptyset = B \cap T_V$.

See Figure 15 for an example. Compositions of iconclist maps are defined as for conclist maps.

The *full labelled precube category with interfaces*, $\mathbf{I}\square$, has iconclists as objects and iconclist maps as morphisms. Every pair of isomorphic iconclists admits exactly one isomorphism between them. Thus, we define the *labelled precube category with interfaces* $\mathbf{I}\square$ as the quotient of $\mathbf{I}\square$ by isomorphisms. The quotient functor $\mathbf{I}\square \rightarrow \mathbf{I}\square$ is an equivalence of categories. The category $\mathbf{I}\square$ is skeletal, and its objects are words on $\Sigma_\bullet = \{a, \bullet a, a\bullet, \bullet a\bullet \mid a \in \Sigma\}$.

We can assign an iconclist with empty interfaces to any conclist using the inclusion functors $\square \ni U \mapsto {}_\emptyset U_\emptyset \in \mathbf{I}\square$ and $\square \rightarrow \mathbf{I}\square$. Conversely, there are forgetful functors $\mathbf{I}\square \rightarrow \square$ and $\mathbf{I}\square \rightarrow \square$ that ignore interfaces and assign the underlying conclist to each iconclist.

The involutive *reversal* functor on $\mathbf{I}\square$ and $\mathbf{I}\square$ maps ${}_S U_T$ to ${}_T U_S$ and $d_{A,B}$ to $d_{B,A}$. It swaps events that have not yet started and those that have terminated.

Precubical sets with interfaces and iHDAs. A *precubical set with interfaces* (*ipc-set*) is a presheaf on $\mathbf{I}\square$. We write $X[U]$ for the value of X on object U of $\mathbf{I}\square$, and $\delta_{A,B} = X[d_{A,B}] : X[U] \rightarrow X[U \setminus (A \cup B)]$ for the *face map* associated to the coface map $d_{A,B} : U \setminus (A \cup B) \rightarrow U$. Elements of $X[U]$ are *cells* of X . We write $\text{Cell}(X) = \bigsqcup_{U \in \mathbf{I}\square} X[U]$ for the set of cells of X . An ipc-set Y is an *ipc-subset* of X if $Y[U] \subseteq X[U]$ for all $U \in \mathbf{I}\square$ and the face maps of Y are the restrictions of face maps of X .

If $x \in X[{}_S U_T]$, we write $\text{iev}(x) = {}_S U_T \in \mathbf{I}\square$ and $\text{ev}(x) = U \in \square$. As before, we also write δ_A^0 for $X[d_A^0]$ and δ_B^1 for $X[d_B^1]$. We may view a precubical set as an ipc-set X such that $X[{}_S U_T] = \emptyset$ whenever $S \neq \emptyset$ or $T \neq \emptyset$. As for pc-sets, $\text{Cell}(X)$ may be regarded as the category of elements of X , with the projection functor $\text{iev} : \text{Cell}(X) \rightarrow \mathbf{I}\square$. We often view X as a set of cells, that is, objects of $\text{Cell}(X)$.

A *higher-dimensional automaton with interfaces* (*iHDA*) is a finite ipc-set X with subsets X_\perp of *start cells* and X^\top of *accept cells*. These are required to satisfy $S = U$ for all $x \in X_\perp$ with $\text{iev}(x) = {}_S U_T$, and $T = U$ for all $x \in X^\top$ with $\text{iev}(x) = {}_S U_T$. Neither X_\perp nor X^\top is necessarily an ipc-subset.

HDAs are not simply special cases of iHDAs due to the above requirements on interfaces of start and accept cells. See Figure 16 for examples.

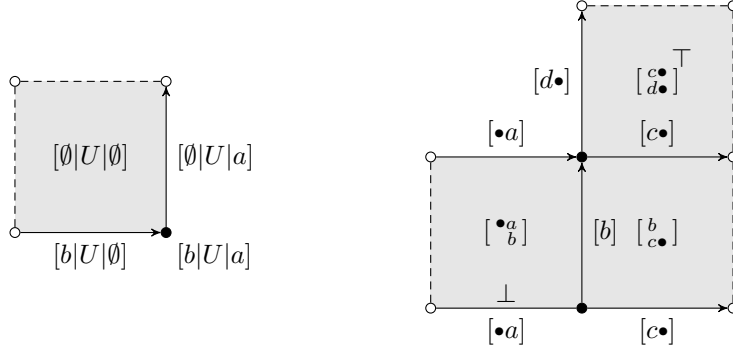

Figure 16: Left: the standard icube \square^U for $U = [\bullet^a_b \bullet]$ with names of cells. Right: an example of an iHDA with iconclists associated to particular cells. The presence of interfaces causes that some faces are “missing”. Those are indicated by dashed lines or circles.

An *ipc-map* is a natural transformation $f : X \rightarrow Y$ of ipc-sets X, Y , an *iHDA-map* must preserve start and accept cells as well: $f(X_\perp) \subseteq Y_\perp$ and $f(X^\top) \subseteq Y^\top$. We write $\mathbb{I}\square\text{Set}$ and $\mathbb{I}\text{HDA}$ for the resulting categories of ipc-sets and iHDAs.

The reversal on $\mathbb{I}\square$ translates to ipc-sets and iHDAs. It maps $\delta_{A,B}$ to $\delta_{B,A}$ and exchanges start and accept cells if present.

Standard icubes. The *standard icube* $\mathbb{I}\square^U$ is the presheaf represented by an iconclist $U \in \mathbb{I}\square$, that is, $\mathbb{I}\square^U[W] = \mathbb{I}\square(W, U)$. Every morphism $d_{A,B} \in \mathbb{I}\square(U, V)$ defines an ipc-map $\mathbb{I}\square^{d_{A,B}} : \mathbb{I}\square^U \rightarrow \mathbb{I}\square^V$, which gives a functor $\mathbb{I}\square \ni U \mapsto \mathbb{I}\square^U \in \mathbb{I}\square\text{Set}$.

An example of a standard icube is given on the left in Figure 16.

The analogue of Lemma 3.4 holds for iHDA as well. For every iHDA X and cell $x \in X[U]$ there exists a unique iHDA-map $\iota_x : \mathbb{I}\square^U \rightarrow X$ such that $\iota_x(\text{id}_U) = x$. (Note that $\text{id}_U = [\emptyset|U|\emptyset] \in \mathbb{I}\square(U, U) \cong \mathbb{I}\square^U[U]$ is the top cell of $\mathbb{I}\square^U$).

Executions of iHDAs. Paths in iHDAs, their ipomsets and languages are defined by analogy to HDAs in Section 5. A path in an iHDA X is a sequence $(x_0, \varphi_1, \dots, x_n)$ such that every step $(x_{k-1}, \varphi_k, x_k)$ is either an up-step $\delta_A^0(x) \nearrow^A x = (\delta_A^0(x), d_A^0, x)$ or a down-step $x \searrow_B \delta_B^1(x) = (x, d_B^1, \delta_B^1(x))$. The ipomset of a path is a gluing composition of ipomsets of consecutive steps, which are $(U \setminus_A)U$ and $U(U \setminus_B)$ for up-steps and down-steps as specified above.

The set of ipomsets of accepting paths forms the language $\text{Lang}(X)$ of X . We will see in the next section that $\text{Lang}(X)$ is down-closed, that is, an interval ipomset language. Further, any iHDA can be translated to an HDA that recognises the same language, and vice versa.

As for HDA maps, we call an iHDA map $f : X \rightarrow Y$ a *weak equivalence* if for every accepting path $\beta \in \text{P}_Y$ there is an accepting path $\alpha \in \text{P}_X$ such that $f(\alpha) = \beta$. The analogue of Lemma 5.10 holds for iHDA: for every iHDA map $f : X \rightarrow Y$ we have $\text{Lang}(X) \subseteq \text{Lang}(Y)$, and $\text{Lang}(X) = \text{Lang}(Y)$ if f is a weak equivalence.

11. HIGHER-DIMENSIONAL AUTOMATA WITH AND WITHOUT INTERFACES

In this section we discuss the relationship between HDAs and iHDAs. We show that there are two functors that translate between them: the resolution $\text{Res} : \text{HDA} \rightarrow \text{iHDA}$ and the closure $\text{Cl} : \text{iHDA} \rightarrow \text{HDA}$, both of which preserve languages. Finite HDAs and finite iHDAs therefore recognise the same class of regular languages.

Resolution. The *resolution* of a precubical set X is the ipc-set $\text{Res}(X) = X \circ \mathbf{F}$, where $\mathbf{F} : \mathbb{I}\square \rightarrow \square$ is the forgetful functor.

For ${}_S U_T \in \mathbb{I}\square$ and $A, B \subseteq U$, the definition of Res expands to

$$\begin{aligned} \text{Res}(X)[{}_S U_T] &= \{(x; S, T) \mid x \in X[U]\}, \\ \delta_{A,B}((x; S, T)) &= (\delta_{A,B}(x); S \setminus B, T \setminus A). \end{aligned}$$

The functor $F : \mathbb{I}\square \rightarrow \square$ forgets interfaces, but the composition $\mathbb{I}\square \xrightarrow{F} \square \xrightarrow{X} \text{Set}$ produces copies of cells of X equipped with all possible combinations of interfaces. Notation such as $(x; S, T)$ indicates that $\text{Res}(X)[{}_S U_T]$ is essentially the same set as $X[U]$, but each $x \in X[U]$ is tagged with S and T . For every HDA X we define $(x; S, T) \in \text{Res}(X)[{}_S U_T]$ to be a start cell if $x \in X_\perp$ and $S = U$, and an accept cell if $x \in X^\top$ and $T = U$.

This extends Res to a functor $\text{HDA} \rightarrow \text{iHDA}$. Every cell $x \in X[U]$ produces $4^{|U|}$ cells in $\text{Res}(X)$. Thus $\text{Res}(X)$ is finite whenever X is.

Example 11.1. For an HDA X with $x \in X[a]$ and $v, w \in X[\emptyset]$,

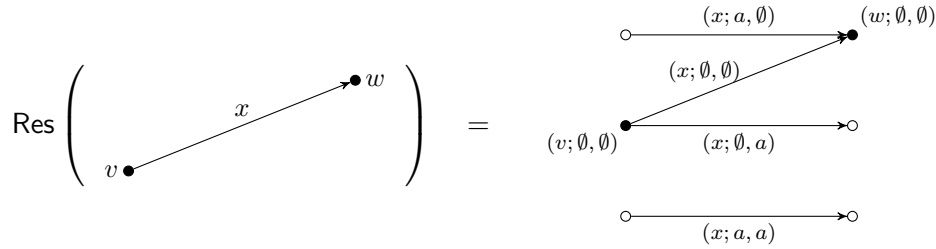

Proposition 11.2. If X is an HDA, then $\text{Lang}(\text{Res}(X)) = \text{Lang}(X)$.

Proof. If $((x_0; S_0, T_0), \varphi_1, (x_1; S_1, T_1), \varphi_2, \dots, \varphi_n, (x_n; S_n, T_n))$ is an accepting path in $\text{Res}(X)$, then $(x_0, \varphi_1, x_1, \varphi_2, \dots, \varphi_n, x_n)$ is an accepting path in X with the same event ipomset. Conversely, if $\alpha = (x_0, \varphi_1, x_1, \dots, \varphi_n, x_n)$, $x_k \in X[U_k]$ is an accepting path in X , we define S_k and T_k recursively (recall that, by Lemma 5.6, the U_k may be taken as subsets of $\text{ev}(\alpha)$):

- $S_0 = U_0, T_n = U_n$,
- if $\varphi_k = d_{U_k \setminus U_{k-1}}^0$, then $S_k = S_{k-1}$ and $T_{k-1} = T_k \cap U_{k-1}$,
- if $\varphi_k = d_{U_{k-1} \setminus U_k}^1$, then $S_k = S_{k-1} \cap U_k$ and $T_{k-1} = T_k$.

This yields an accepting path $((x_k; S_k, T_k), \varphi_k)$ in $\text{Res}(X)$ with the same event ipomset as α in X . \square

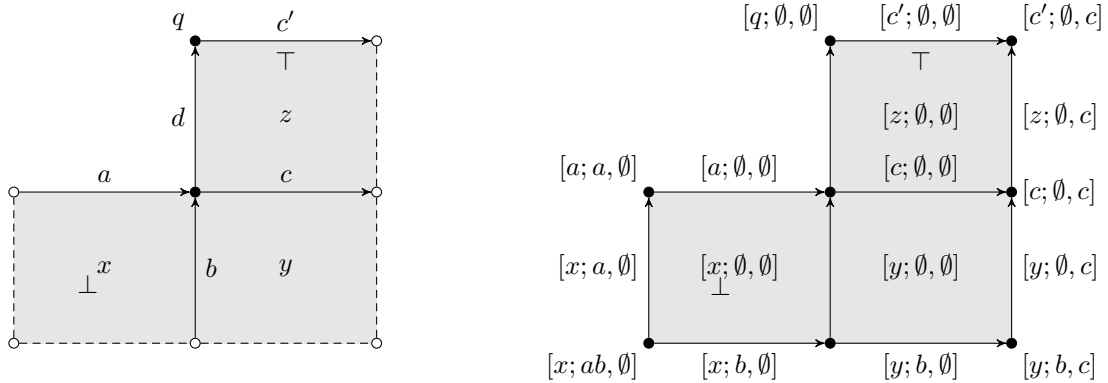

Figure 17: An example of an iHDA (left) and its closure (right). Not all cells are captioned. The iconclists of cells on the left are $\text{iev}(x) = \begin{bmatrix} a \\ b \end{bmatrix}$, $\text{iev}(y) = \begin{bmatrix} \bullet \\ c \end{bmatrix}$, $\text{iev}(z) = \begin{bmatrix} c \\ d \end{bmatrix}$.

Closure. The closure is the left adjoint to resolution, though we neither need nor prove this fact in this article. Instead, we give an explicit definition.

The *closure* of the ipc-set X is the pc-set $\text{Cl}(X)$ defined, for all $U \in \square$, as

$$\text{Cl}(X)[U] = \{[x; A, B] \mid \exists {}_S V_T \in \square : x \in X[V], A \subseteq S, B \subseteq T, A \cap B = \emptyset, U = V \setminus (A \cup B)\}.$$

We write $[x; A, B]$ instead of $(x; A, B)$ to distinguish the provenance of these elements. Face maps are given by

$$\delta_{C,D}([x; A, B]) = [\delta_{C \setminus S, D \setminus T}(x); A \cup (C \cap S), B \cup (D \cap T)],$$

where U and ${}_S V_T$ are as above and the $C, D \subseteq U$ satisfy $C \cap D = \emptyset$. An ipc-map $f : X \rightarrow Y$ induces a pc-map $\text{Cl}(f) : \text{Cl}(X) \rightarrow \text{Cl}(Y)$ such that $\text{Cl}(f)[U]([x; A, B]) = [f(x); A, B]$. This makes $\text{Cl} : \square\text{Set} \rightarrow \square\text{Set}$ a functor.

Intuitively, $\text{Cl}(X)$ fills in the missing cells of the ipc-set X . The function $\delta_{C \setminus S, D \setminus T}$ takes as much of the face map as possible, while the remaining events that should be unstarted or terminated are added to A and B , respectively. See Figure 17 for an example.

For an iHDA X we define

$$\text{Cl}(X)_\perp = \{[x; \emptyset, \emptyset] \mid x \in X_\perp\} \quad \text{and} \quad \text{Cl}(X)^\top = \{[x; \emptyset, \emptyset] \mid x \in X^\top\}.$$

This extends Cl to a functor $\text{iHDA} \rightarrow \text{HDA}$, which is the left adjoint of the extension of the functor Res .

Lemma 11.3. *If ${}_S U_T$ is an iconclist, then $\text{Cl}(\square^{{}_S U_T}) \cong \square^U$.*

Proof. The isomorphism maps a cell $[A|B] \in \square^U[U \setminus (A \cup B)]$ into $[(A \setminus S)|(B \setminus T)]; A \cap S, B \cap T$ in the set $\text{Cl}(\square^{{}_S U_T})[U \setminus (A \cup B)]$. \square

Proposition 11.4. *If X is an iHDA, then $\text{Lang}(\text{Cl}(X)) = \text{Lang}(X)$.*

Proof. If $(x_0, \varphi_1, \dots, \varphi_n, x_n)$ is an accepting path in X , then

$$([x_0; \emptyset, \emptyset], \varphi_1, \dots, \varphi_n, [x_n; \emptyset, \emptyset])$$

is an accepting path in $\text{Cl}(X)$. Conversely, let $\alpha = ([x_0; A_0, B_0], \varphi_1, \dots, \varphi_n, [x_n; A_n, B_n])$ be a path in $\text{Cl}(X)$. Then, for all $\varphi_k = d_{C_k}^0$, we have $A_{k-1} \supseteq A_k$ and $B_{k-1} = B_k$, and for all $\varphi_k = d_{D_k}^1$, $A_{k-1} = A_k$ and $B_{k-1} \subseteq B_k$. Hence $A_0 \supseteq \dots \supseteq A_n$ and $B_0 \subseteq \dots \subseteq B_n$. If α is accepting, then $A_0 = B_n = \emptyset$ and thus $A_k = B_k = \emptyset$ for all k . \square

Proposition 11.5. *HDAs and iHDAs recognise the same class of languages: that of regular languages.*

Proof. Resolution and closure preserves finiteness of automata. The result then follows from Propositions 11.2 and 11.4. \square

We conclude with an easy technical lemma that is needed later on.

Lemma 11.6. *Let X be an iHDA, $x \in X$ and $[y; A, B] \in \text{Cl}(X)$. Then $[y; A, B]$ is a face of $[x; \emptyset, \emptyset]$ in $\text{Cl}(X)$ if and only if y is a face of x in X .*

Proof. If $y = \delta_{C,D}(x)$, then

$$\delta_{A,B}(\delta_{C,D}([x; \emptyset, \emptyset])) = \delta_{A,B}([y; \emptyset, \emptyset]) = [y; A, B],$$

and if $[y; A, B] = \delta_{C,D}([x; \emptyset, \emptyset])$, then $y = \delta_{C \setminus S, D \setminus T}(x)$, where $S = S_{\text{iev}(x)}$, $T = T_{\text{iev}(x)}$. \square

Simple languages. An iHDA X is *start simple* if it has exactly one start cell, *accept simple* if it has exactly one accept cell, and *simple* if it is both start and accept simple. A regular language is *simple* if it is recognised by a simple iHDA.

Example 11.7. HDAs with one start and one accept cell recognise a larger class of languages than simple iHDA. The HDA X with a single 0-cell x , a 1-loop labelled a on x , and $X_{\perp} = X^{\top} = \{a\}$ is simple and recognises the language of all ipomsets $[a \cdots a]$, but no simple iHDA does. This is because $[a]$ may only be an ipomset of a constant path (x) such that $x \in X[a]$ and $x \in X_{\perp} \cap X^{\top}$. Yet the event a cannot be terminated in any path starting at x , so no such path may recognise $[aa]$.

Lemma 11.8. *Every regular language is a finite union of simple regular languages.*

Proof. Proposition 11.5 allows us to work with a suitable iHDA X . Let $X_{\perp} = \{x_{\perp}^i\}_{i=1}^m$ and $X^{\top} = \{x_j^{\top}\}_{j=1}^n$. For each pair (i, j) , let X_i^j be the iHDA with the same underlying ipc-set as X and $(X_i^j)_{\perp} = \{x_{\perp}^i\}$, $(X_i^j)^{\top} = \{x_j^{\top}\}$. Then $\text{Lang}(X) = \bigcup_{i,j} \text{Lang}(X_i^j)$. \square

Intuitively, we switch off all start and accept states but one of each in this proof.

Normal form of paths on closures of iHDAs. The next lemma gives a normal form for paths on HDAs that are closures of iHDAs.

Lemma 11.9. *Let $X \in \text{iHDA}$, $\alpha \in \text{P}_{\text{Cl}(X)}$. Then α is subsumed by a path of the form*

$$([x; C \cup A, D] \nearrow^A [x; C, D]) * \beta * ([y; C, D] \searrow_B [y; C, D \cup B]),$$

where $\beta = ([x_0; C, D], \varphi_0, \dots, [x_n; C, D])$.

See Figure 18 for an example. Note that the restriction of $\alpha = ([x_k; A_k, B_k], \varphi_k) \in \text{P}_{\text{Cl}(X)}$ to the first coordinate gives a path $\alpha' = (x_k, \varphi'_k) \in \text{P}_X$ with, possibly, trivial steps (*i.e.*, $\varphi'_k = d_{\emptyset}^0$ or $\varphi'_k = d_{\emptyset}^1$). In Lemma 11.9 we regard A, B, C, D as subsets of $\text{ev}(\alpha')$.

Proof. Without loss of generality we assume that α is a *dense* path, that is, all its steps either start ($d_{\{a\}}^0$) or terminate ($d_{\{a\}}^1$) a single event a . Every single step σ in α falls into one of three categories:

$$(+) \sigma = [x; A, B] \searrow_b [x; A, B \cup \{b\}] \text{ for } b \in T_{\text{ev}(x)},$$

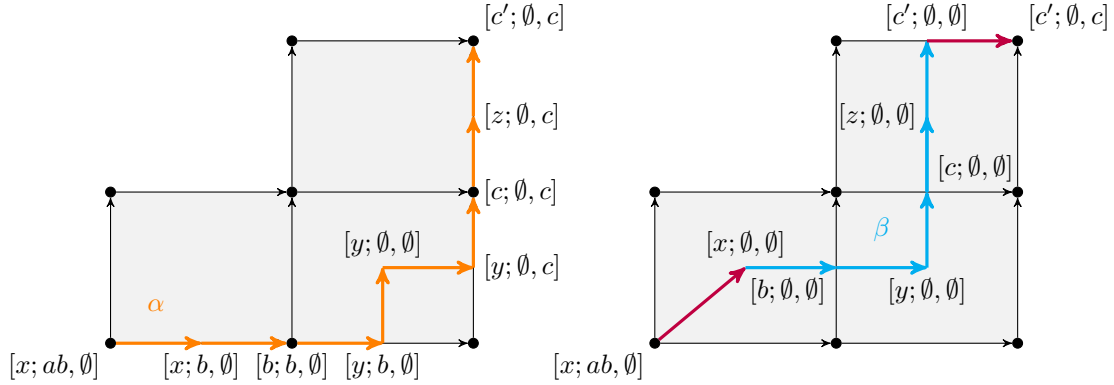

Figure 18: An illustration of Lemma 11.9 using the iHDA from Figure 17. The orange path α on the left is subsumed by $([x; ab, \emptyset] \nearrow^{ab} [x; \emptyset, \emptyset]) * \beta * ([c'; \emptyset, \emptyset] \searrow_c [c'; \emptyset, c])$ on the right.

- (-) $\sigma = [x; A \cup \{a\}, B] \nearrow^a [x; A, B]$ for $a \in S_{\text{ev}(x)}$,
- (0) neither of the above, so $\sigma = [x; A, B] \searrow_b [\delta_b^1(x); A, B]$ or $\sigma = [\delta_a^0(x); A, B] \nearrow^a [x; A, B]$.

We show that the steps of α can be rearranged so that all (0)-steps are preceded by (-)-steps and succeeded by (+)-steps. Let ${}_sU_T = \text{iev}(x)$. For $b \in T$, $c \in U \setminus T$,

$$\begin{aligned} ([x; A, B] \searrow_b [x; A, B \cup \{b\}] \searrow_c [\delta_c^1(x); A, B \cup \{b\}]) \\ \simeq ([x; A, B] \searrow_c [\delta_c^1(x); A, B] \searrow_b [\delta_c^1(x); A, B \cup \{b\}]) . \end{aligned}$$

For $a \in U \setminus S$, $b \in T$,

$$\begin{aligned} ([\delta_a^0(x); A, B] \searrow_b [\delta_a^0(x); A, B \cup \{b\}] \nearrow^a [x; A, B \cup \{b\}]) \\ \sqsubseteq ([\delta_a^0(x); A, B] \nearrow^a [x; A, B] \searrow_b [x; A, B \cup \{b\}]) . \end{aligned}$$

Thus every (+)-step followed by a (0)-step, can be swapped, possibly passing to a subsuming path. Likewise, we can swap every (0)-step followed by a (-)-step. Further, for $a \in S$, $b \in T$,

$$\begin{aligned} ([x; A \cup \{a\}, B] \searrow_b [x; A \cup \{a\}, B \cup \{b\}] \nearrow^a [x; A, B \cup \{b\}]) \\ \sqsubseteq ([x; A \cup \{a\}, B] \nearrow^a [x; A, B] \searrow_b [x; A, B \cup \{b\}]) , \end{aligned}$$

so every (+)-step followed by a (-)-step can be swapped, too. Finally, we can concatenate all (-)-steps, (0)-steps and (+) steps to obtain the conclusion. \square

12. CYLINDERS

In this section we introduce cylinders for ipc-sets. This construction is motivated by the double mapping cylinder from topology and may be regarded as a significant generalization of resolving ε -transitions. For a pair of ipc-maps $f : Y \rightarrow X$ and $g : Z \rightarrow X$, we construct an ipc-set $C(f, g)$, which is equivalent to X in a sense explained below. This allows us to replace f and g by injections $\tilde{f} : Y \rightarrow C(f, g)$ and $\tilde{g} : Z \rightarrow C(f, g)$ whose images are initial and final in $C(f, g)$, respectively, in the sense of the following definition. Cylinders are used

later as tools that separate initial and accept states in iHDAs, that is, which replace them by proper ones in such a way that the languages accepted do not change.

Initial and final inclusions. Let X be an ipc-set. A ipc-subset $Y \subseteq X$ is *initial* if it is down-closed with respect to the reachability preorder \preceq in X . Equivalently, Y is initial in X if $\delta_B^1(x) \in Y$ implies $x \in Y$ for all $x \in X[U]$ and $B \subseteq U \setminus T_U$. (Since Y is an ipc-set, the implication $x \in Y \implies \delta_A^0(x) \in Y$ follows.) By reversal, Y is *final* if it is up-closed with respect to \preceq or, equivalently, $\delta_A^0(x) \in Y$ implies $x \in Y$. An *initial (final) inclusion* is an injective ipc-map whose image is an initial (final) ipc-subset.

Lemma 12.1. *Let $f : Y \rightarrow X$ be an initial (final) inclusion of ipc-sets. Then its closure $\text{Cl}(f) : \text{Cl}(Y) \rightarrow \text{Cl}(X)$ is an initial (final) inclusion of pc-sets.*

Proof. Suppose f is an initial inclusion, $x \in X[U]$, and $\delta_D^1([x; A, B]) \in \text{im}(\text{Cl}(f))$. Then $\delta_{D \setminus T_U}^1(x) \in \text{im}(f)$ because

$$\delta_D^1([x; A, B]) = [\delta_{D \setminus T_U}^1(x); A, B \cup (D \cap T_U)] \in \text{im}(\text{Cl}(f)).$$

Thus $x \in \text{im}(f)$ because f is initial, and $[x; A, B] \in \text{im}(\text{Cl}(f))$ follows. The proof for final inclusions is similar. \square

Proper iHDAs. The *start* and *accept maps* of an iHDA X are the ipc-maps

$$\iota_{\perp}^X = \bigsqcup_{x \in X_{\perp}} \iota_x : \bigsqcup_{x \in X_{\perp}} \mathbb{I}\square^{\text{iev}(x)} \rightarrow X \quad \text{and} \quad \iota_X^{\top} = \bigsqcup_{x \in X^{\top}} \iota_x : \bigsqcup_{x \in X^{\top}} \mathbb{I}\square^{\text{iev}(x)} \rightarrow X.$$

An iHDA is *start proper* if its start map is an initial inclusion and *accept proper* if its accept map is a final inclusion. An iHDA is *proper* if it is start proper, accept proper and the images of the start map and the accept map are disjoint.

The following lemma and example explain the structure of start and accept proper iHDAs.

Lemma 12.2. *All start cells of start proper iHDAs are \preceq -minimal. All accept cells of accept proper iHDAs are \preceq -maximal.*

Proof. Let $x_{\perp} \in X_{\perp}$ and $U = \text{iev}(x_{\perp})$. Then obviously $S_U = U$. The top cell $c = [\emptyset|U|\emptyset]$ of $\mathbb{I}\square^U$ is thus \preceq -minimal, in particular when regarded as a cell in $\bigsqcup_{x \in X_{\perp}} \mathbb{I}\square^{\text{iev}(x)}$. But $x_{\perp} = i_{\perp}^X(c)$ and initial inclusions preserve \preceq -minimal elements. So x_{\perp} is \preceq -minimal. The claim for accept cells follows by reversal. \square

Example 12.3. The condition of Lemma 12.2 is not sufficient for properness. The following diagrams show examples of iHDAs that are not start proper:

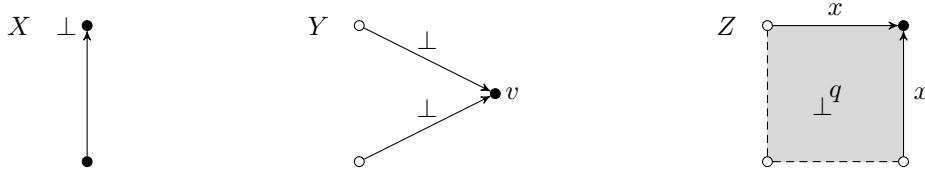

Edges marked with x have been identified. In the first diagram, the start map ι_{\perp}^X is an inclusion, but not initial. In the second and third diagram, neither ι_{\perp}^Y nor ι_{\perp}^Z is an inclusion: ι_{\perp}^Y maps two different vertices to v ; ι_{\perp}^Z maps two different edges of $\mathbb{I}\square^{\text{iev}(q)}$ to x .

Lifting properties. An ipc-map $f : Y \rightarrow X$ has the *future lifting property (FLP)* if for every up-step $\alpha = (\delta_A^0(x) \nearrow^A x)$ in X and every $y \in Y$ such that $f(y) = \delta_A^0(x)$ there is an up-step $\beta = (y \nearrow^A z)$ in Y such that $f(\beta) = \alpha$. The *past lifting property (PLP)* is defined by reversal.

FLP and PLP are equivalent to the lifting properties in the following diagrams:

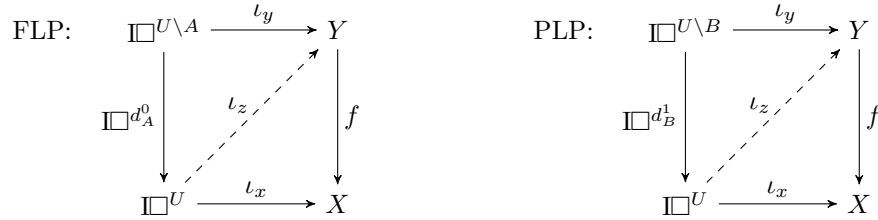

The next lemma states that path lifting properties allow to lift paths along f , given that their source or target cells can be lifted. It is immediate from the definitions.

Lemma 12.4. *An ipc-map $f : Y \rightarrow X$ has the FLP if and only if for every $\alpha \in P_X$ and $y \in f^{-1}(\text{src}(\alpha))$ there exists a path $\beta \in P_Y$ such that $\text{src}(\beta) = y$ and $f(\beta) = \alpha$. An analogous property holds for PLP.* \square

Let $f : Y \rightarrow X$ be an ipc-map and $S, T \subseteq X$, that is, these are subsets, but not necessarily ipc-subsets. Then f has the *total lifting property (TLP)* with respect to S and T if for every path $\alpha \in P_X$ with $\text{src}(\alpha) \in S$ and $\text{tgt}(\alpha) \in T$ and every $y \in f^{-1}(\text{src}(\alpha))$ and $z \in f^{-1}(\text{tgt}(\alpha))$, there exists a path $\beta \in P_Y(y, z)$ such that $f(\beta) = \alpha$.

Proposition 12.5. *Let $f : Y \rightarrow X$ be an iHDA map such that the functions $Y_{\perp} \rightarrow X_{\perp}$ and $Y^{\top} \rightarrow X^{\top}$ induced by f are surjective. Suppose at least one of the following holds:*

- (1) *f has the future lifting property and $Y^{\top} = f^{-1}(X^{\top})$,*
- (2) *f has the past lifting property and $Y_{\perp} = f^{-1}(X_{\perp})$,*
- (3) *f has the total lifting property with respect to X_{\perp} and X^{\top} .*

Then f is a weak equivalence.

Proof. For (1), there exists an $y \in Y_{\perp}$ such that $f(y) = \text{src}(\alpha)$ by assumption, and $\beta \in P_Y$ such that $\text{src}(\beta) = y$ and $f(\beta) = \alpha$ by Lemma 12.4. Moreover,

$$\text{tgt}(\beta) \in f^{-1}(\text{tgt}(\alpha)) \subseteq f^{-1}(X^{\top}) = Y^{\top}.$$

Item (2) follows from (1) by reversal.

For (3), there are $y \in Y_{\perp}$, $z \in Y^{\top}$ such that $f(y) = \text{src}(\alpha)$, $f(z) = \text{tgt}(\alpha)$ by assumption. Since f has the TLP, there exists a $\beta \in P_Y(y, z)$ such that $f(\beta) = \alpha$. \square

Cylinders. Let $X, Y, Z \in \mathbb{I}\square\text{Set}$ and $f : Y \rightarrow X$, $g : Z \rightarrow X$ be ipc-maps. Assume further that f and g have disjoint images. This is not directly used in the construction, but crucial in proofs.

The *cylinder* $C(f, g)$ is the ipc-set such that $C(f, g)[U]$ is the set of (x, K, L, φ, ψ) , where

- $x \in X[U]$;
- K is an initial ipc-subset of $\mathbb{I}\square^U$;
- L is a final ipc-subset of $\mathbb{I}\square^U$;
- $\varphi : K \rightarrow Y$ is an ipc-map such that $f \circ \varphi = \iota_x|_K$;

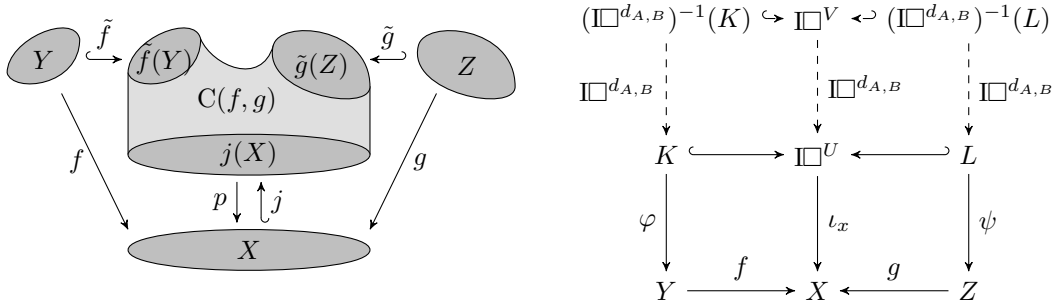
Figure 19: The cylinder $C(f, g)$ and a diagram defining its cell.

- $\psi : L \rightarrow Z$ is an ipc-map such that $g \circ \psi = \iota_x|_L$.

For $d_{A,B} \in \mathbb{I}\Box(V, U)$ and $(x, K, L, \varphi, \psi) \in C(f, g)[U]$, we put

$$\delta_{A,B}(x, K, L, \varphi, \psi) = (\delta_{A,B}(x), (\mathbb{I}\Box^{d_{A,B}})^{-1}(K), (\mathbb{I}\Box^{d_{A,B}})^{-1}(L), \varphi \circ \mathbb{I}\Box^{d_{A,B}}, \psi \circ \mathbb{I}\Box^{d_{A,B}}).$$

Equivalently, $C(f, g)[U]$ is the set of commutative diagrams of solid arrows in Figure 19 and the face map $\delta_{A,B}$ composes the diagram with the dashed arrows. The following is then clear (recall that $f(Y) \cap g(Z) = \emptyset$).

Lemma 12.6. *Let $(x, K, L, \varphi, \psi) \in C(f, g)$. Then $K \subseteq (\iota_x)^{-1}(f(Y))$ and $L \subseteq (\iota_x)^{-1}(g(Z))$. Thus $K \cap L = \emptyset$, $x \in f(Y)$ implies $L = \emptyset$, and $x \in g(Z)$ implies $K = \emptyset$.*

$C(f, g)$ is equipped with the ipc-maps shown in Figure 19. They are defined by

$$\begin{aligned} j(x) &= (x, \emptyset, \emptyset, \emptyset, \emptyset), & p(x, K, L, \varphi, \psi) &= x, \\ \tilde{f}(y) &= (f(y), \mathbb{I}\Box^{\text{iev}(y)}, \emptyset, \iota_y, \emptyset), & \tilde{g}(z) &= (g(z), \emptyset, \mathbb{I}\Box^{\text{iev}(z)}, \emptyset, \iota_z). \end{aligned}$$

Intuitively, $C(f, g)$ may be regarded as a result of the following procedure: in the disjoint union of $Y \sqcup X \sqcup Z$, add ε -transitions $y \rightarrow f(y)$ for all cells $y \in Y$ and $g(z) \rightarrow z$ for all $z \in Z$. Next, resolve all ε -transitions. (Alas, we know no satisfactory definition of ε -transitions for ipc-sets). See Figure 20 for an example.

Next we collect some of properties of cylinders.

Lemma 12.7.

- (1) $p \circ \tilde{f} = f$, $p \circ \tilde{g} = g$, and $p \circ j = \text{id}_X$.
- (2) \tilde{f} is an initial inclusion and $\tilde{f}(Y) = \{(x, K, L, \varphi, \psi) \in C(f, g) \mid K = \mathbb{I}\Box^{\text{iev}(x)}, L = \emptyset\}$.
- (3) \tilde{g} is a final inclusion and $\tilde{g}(Z) = \{(x, K, L, \varphi, \psi) \in C(f, g) \mid K = \emptyset, L = \mathbb{I}\Box^{\text{iev}(x)}\}$.
- (4) j is an inclusion and $j(X) = \{(x, \emptyset, \emptyset, \emptyset, \emptyset) \in C(f, g)\}$.
- (5) $\tilde{f}(Y)$, $\tilde{g}(Z)$ and $j(X)$ are pairwise disjoint.

Proof. Item (1) is straightforward from the definition.

For (2), let $Y' \subseteq C(f, g)$ be the right-hand side of the equation. We show that

$$h : Y' \ni (x, \mathbb{I}\Box^{\text{iev}(x)}, \emptyset, \varphi, \emptyset) \mapsto \varphi([\emptyset|\emptyset]) \in Y$$

is the inverse of $\tilde{f} : Y \rightarrow Y'$. Indeed,

$$h(\tilde{f}(y)) = h(f(y), \mathbb{I}\Box^{\text{iev}(y)}, \emptyset, \iota_y, \emptyset) = \iota_y([\emptyset|\emptyset]) = y$$

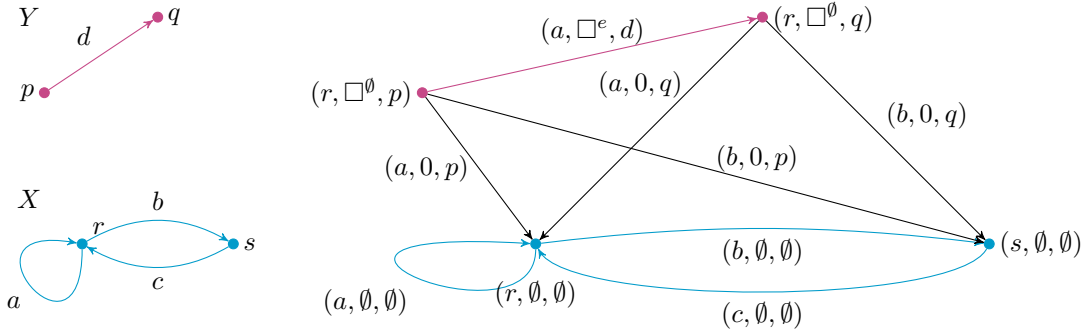

Figure 20: The cylinder $C(f, \emptyset)$ for a map $f : Y \rightarrow X$ determined by $f(d) = a$. All edges are labelled by e . Cells are marked by sequences $(x, K, \varphi(y))$, where y is the top cell of K . $K = 0$ stands for $\{\emptyset\} \subseteq \square^e$.

and

$$\begin{aligned} \tilde{f}(h(x, \mathbb{I}\square^{\text{iev}(x)}, \emptyset, \varphi, \emptyset)) &= \tilde{f}(\varphi([\emptyset|\emptyset])) = (f(\varphi([\emptyset|\emptyset]), \mathbb{I}\square^{\text{iev}(x)}, \emptyset, \iota_{\varphi([\emptyset|\emptyset])}, \emptyset)) \\ &= (\iota_x([\emptyset|\emptyset]), \mathbb{I}\square^{\text{iev}(x)}, \emptyset, \varphi, \emptyset) \\ &= (x, \mathbb{I}\square^{\text{iev}(x)}, \emptyset, \varphi, \emptyset). \end{aligned}$$

In the above, $f \circ \varphi = \iota_x$ holds by definition, and $\varphi = \iota_{\varphi([\emptyset|\emptyset])}$ since ipc-maps from $\mathbb{I}\square^{\text{iev}(x)}$ are determined by their values on $[\emptyset|\emptyset]$. Thus, \tilde{f} defines an isomorphism between Y and its image Y' . It remains to show that $Y' \subseteq C(f, g)$ is an initial subset. Suppose $\delta_B^1(x, K, L, \varphi, \psi) \in Y'$. Then $(\mathbb{I}\square^{d_B^1})^{-1}(K) = \mathbb{I}\square^{U \cup B}$ and $(\mathbb{I}\square^{d_B^1})^{-1}(L) = \emptyset$. Hence, K is an initial subset of $\mathbb{I}\square^U$ containing an upper face $[\emptyset|B]$, so also $[\emptyset|\emptyset] \in K$ and then $K = \mathbb{I}\square^{\text{iev}(x)}$. Therefore, $L = \emptyset$ and $(x, K, L, \varphi, \psi) \in Y'$.

Finally, (3) follows from (2) by reversal, (4) is obvious from the definition and (5) follows from (2)–(4) since $\mathbb{I}\square^{\text{iev}(x)} \neq \emptyset$ for all $x \in X$. \square

Lifting properties of cylinders. The following proposition allows us to use cylinders for replacing iHDAs with proper iHDAs that accept the same languages.

Proposition 12.8. *The projection $p : C(f, g) \rightarrow X$ has the future and past lifting property, as well as the total lifting property with respect to $f(Y)$ and $g(Z)$.*

Proof. Suppose $x \in X[U]$, $y \in C(f, g)[U \setminus A]$ and $p(y) = \delta_A^0(x)$. Then $y = (\delta_A^0(x), K, L, \varphi, \psi)$ for some K, L, φ, ψ . For $z = (x, \mathbb{I}\square^{d_A^0}(K), \mathbb{I}\square^{d_A^0}(L), \varphi \circ (\mathbb{I}\square^{d_A^0})^{-1}, \psi \circ (\mathbb{I}\square^{d_A^0})^{-1})$ we have $p(z) = x$ and $\delta_A^0(z) = y$. Thus p has the FLP, and the PLP follows by reversal.

For the TLP, let $\alpha = (x_0, \omega_1, \dots, x_n) \in P_X$, $y, z \in C(f, g)$, and suppose $p(y) = x_0$, $p(z) = x_n$. Then $y = (x_0, K_0, \emptyset, \varphi_0, \emptyset)$ and $z = (x_n, \emptyset, L_n, \emptyset, \psi_n)$ for some $K_0, \varphi_0, L_n, \psi_n$, and the remaining items are empty by Lemma 12.6. We abbreviate $U_k = \text{iev}(x_k)$.

Define $K_k \subseteq \mathbb{I}\square^{U_k}$ and $\varphi_k : K_k \rightarrow Y$ inductively:

- if $\omega_k = d_B^1$, $B \subseteq U_{k-1} \setminus T_{U_{k-1}}$, then $K_k = (\mathbb{I}\square^{d_B^1})^{-1}(K_{k-1})$, $\varphi_k = \varphi_{k-1} \circ \mathbb{I}\square^{d_B^1}$;
- if $\omega_k = d_A^0$, $A \subseteq U_k \setminus S_{U_k}$, then $K_k = \mathbb{I}\square^{d_A^0}(K_{k-1})$, $\varphi_k = \varphi_{k-1} \circ (\mathbb{I}\square^{d_A^0})^{-1}$.

We further define L_k and ψ_k inductively in backwards fashion. Now

$$\beta = ((x_0, K_0, L_0, \varphi_0, \psi_0), \omega_1, \dots, (x_n, K_n, L_n, \varphi_n, \psi_n))$$

is a path in $C(f, g)$ such that $p(\beta) = \alpha$. Moreover, $L_0 = \emptyset = K_n$ by Lemma 12.6, and therefore $\text{src}(\beta) = y$ and $\text{tgt}(\beta) = z$. The TLP with respect to $f(Y)$ and $g(Z)$ is thus established. \square

Using cylinders we can now show that it suffices to focus on start or accept proper iHDAs as recognisers of regular languages. Recall that by Lemma 11.8, every regular language is a finite union of simple regular languages. This prepares us for the gluing compositions of iHDAs in the following sections.

Proposition 12.9. *Every simple regular language is recognised by a start simple and start proper iHDA, and by an accept simple and accept proper iHDA.*

Proof. We prove only the first claim; the second then follows by reversal. Suppose L is recognised by the simple iHDA X with start cell $x_\perp \in X[U]$. Let Y be the iHDA with underlying precubical set $C(\iota_\perp^X, \emptyset)$, where $\emptyset : \emptyset \rightarrow X$ is the empty map. Further, let $y_\perp = (x_\perp, \mathbb{I}^U, \emptyset, \text{id}_{\mathbb{I}^U}, \emptyset)$ be the only start cell of Y and $Y^\top = p^{-1}(X^\top)$. Since $\iota_\perp^Y = \widetilde{\iota_\perp^X}$, Y is start proper by Lemma 12.7(b). Moreover, the projection $p : Y \rightarrow X$ has the FLP by Proposition 12.8. Thus $\text{Lang}(Y) = \text{Lang}(X) = L$ by Proposition 12.5(a). \square

Proposition 12.10. *If the language L is regular, then so is $L \setminus \text{Id}$.*

Proof. Suppose first that L is simple. Let X be a start simple and start proper iHDA recognising L , owing to Proposition 12.9, and let Y be the iHDA with the same underlying ipc-set and start cells as X , and with accept cells $Y^\top = X^\top \setminus X_\perp$. By Lemma 12.2, an accepting path $\alpha \in P_X$ is accepting in Y if and only if it has positive length ($\text{ev}(\alpha)$ is not an identity). Thus $\text{Lang}(Y) = \text{Lang}(X) \setminus \text{Id} = L \setminus \text{Id}$ is regular. If L is not simple, then let $L = \bigcup_i L_i$ be a finite sum of simple languages. Then $L \setminus \text{Id} = (\bigcup_i L_i) \setminus \text{Id} = \bigcup_i (L_i \setminus \text{Id})$ is regular by the first case and Proposition 5.12. \square

13. GLUING TOOLBOX

We now present several constructions of composite HDAs from simpler pieces and study properties of their paths.

Sequential gluing. We fix precubical sets X_1, \dots, X_n and Y_1, \dots, Y_{n-1} , initial inclusions $f_k : Y_k \rightarrow X_{k+1}$ and final inclusions $g_k : Y_k \rightarrow X_k$ ($1 \leq k < n$). We also assume that the $f_{k-1}(Y_{k-1}), g_k(Y_k) \subseteq X_k$ are disjoint subsets and that the Y_k are acyclic, which means by definition that they are partially ordered by the reachability preorder \preceq (see Section 5).

The *sequential gluing* given by this data forms the precubical set

$$Z = Z_n((X_k)_{k=1}^n, (Y_k)_{k=1}^{n-1}, (f_k)_{k=1}^{n-1}, (g_k)_{k=1}^{n-1}),$$

which is the colimit of the diagram

$$\begin{array}{ccccccc}
 X_1 & & X_2 & & \dots & & X_n \\
 & \swarrow g_1 & \nearrow f_1 & \swarrow g_2 & \nearrow f_2 & \swarrow g_{n-1} & \nearrow f_{n-1} \\
 & & Y_1 & & Y_2 & & Y_{n-1}
 \end{array} . \tag{13.1}$$

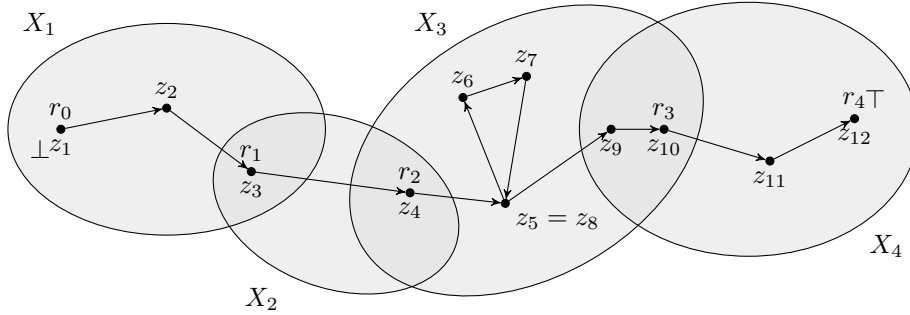

Figure 21: Example of checkpoint sequence.

Colimits of presheaves can be calculated pointwise. So Z is obtained from $\bigsqcup_{k=1}^n X_k$ by identifying cells $g_k(y) \in X_k$ and $f_k(y) \in X_{k+1}$ for all $1 \leq k \leq n-1$ and $y \in Y_k$. Let $j_k : X_k \rightarrow Z$ and $i_k : Y_k \rightarrow Z$ denote the structural maps.

Lemma 13.1. *The maps i_k and j_k are injective for all $1 \leq k < n$. Moreover, $i_k(Y_k) = j_k(X_k) \cap j_{k+1}(X_{k+1})$.*

Proof. As $f_{k-1}(Y_{k-1}) \cap g_k(Y_k) = \emptyset$, each cell $x_k \in X_k$ can be identified with at most one other cell in either X_{k-1} or X_{k+1} . Consequently, different cells of X_k are never identified. Since $j_{k+1} \circ f_k = i_k = j_k \circ g_k$, we have $i_k(Y_k) \subseteq j_k(Y_k) \cap j_{k+1}(Y_{k+1})$. Further, if $j_k(x_k) = j_{k+1}(x_{k+1})$ then x_k and x_{k+1} represent the same element in Z . Equivalence classes have at most two elements, so $x_k = g_k(y)$ and $x_{k+1} = f_k(y)$ for some $y \in Y_k$. \square

It follows that X_k is isomorphic to its image $j_k(X_k)$ in Z and Y_k is isomorphic to $i_k(Y_k)$. For simplicity, we regard X_k and Y_k as precubical subsets of Z such that $Y_k = X_k \cap X_{k+1}$ is a final subset of X_k and an initial subset of X_{k+1} . We can then turn Z into an HDA with $Z_\perp = (X_1)_\perp$, $Z^\top = (X_n)^\top$ for any HDAs X_1, X_n .

A *checkpoint sequence* for an accepting path $\alpha = (z_1, \varphi_1, \dots, z_m) \in \mathbf{P}_Z$ is a sequence (r_0, r_1, \dots, r_n) such that $r_0 = z_1$, $r_n = z_m$ and, for every $0 < k < n$, $r_k \in Y_k$ and $r_k = z_l$ for some $l = l(k)$. See Figure 21 for an example.

Lemma 13.2. *Every accepting path $\alpha \in \mathbf{P}_Z$ admits a checkpoint sequence. If $(r_k)_{k=0}^n$ is a checkpoint sequence for α , then*

- (1) *the indices $l(k)$ are uniquely determined by $(r_k)_{k=0}^n$ and increasing,*
- (2) *$z_{l(k-1)}, z_{l(k-1)+1}, \dots, z_{l(k)} \in X_k$,*
- (3) *$\alpha = \beta_1 * \dots * \beta_n$, where $\beta_k = (z_{l(k-1)}, \varphi_{l(k-1)}, \dots, z_{l(k)}) \in \mathbf{P}_{X_k}(r_{k-1}, r_k)$.*

Proof. Define the function $h : Z \rightarrow \mathbb{N}$ by

$$h(z) = \begin{cases} 2k & \text{if } z \in Y_k, \\ 2k-1 & \text{if } z \in X_k \setminus (Y_{k-1} \cup Y_k). \end{cases}$$

If $z \in Y_k$, then $\delta_A^0(z), \delta_B^1(z) \in Y_k$. If $z \in X_k \setminus (Y_{k-1} \cup Y_k)$, then $\delta_A^0(z) \in X_k \setminus Y_k$, since $Y_k \subseteq X_k$ is a final subset, and $\delta_B^1(z) \in X_k \setminus Y_{k-1}$, since $Y_{k-1} \subseteq X_k$ is an initial subset. Therefore, if (z, φ, z') is a step in Z , then either $h(z) = h(z')$ or $h(z) = h(z') - 1$.

Let $\alpha = (z_1, \varphi_1, \dots, z_m)$. The sequence $h(z_1), \dots, h(z_m)$ is then increasing by steps of size 0 and 1, and $h(z_1) \in \{1, 2\}$, $h(z_m) \in \{2n-2, 2n-1\}$. Thus, there is a sequence

$l(1) < \dots < l(n-1)$ of indices such that $h(z_{l(k)}) = 2k$, that is, $r_k = z_{l(k)} \in Y_k$ and (r_k) is a checkpoint sequence for α .

For (1), fix a checkpoint sequence (r_k) for α . Suppose $r_k = z_l = z_{l'} \in Y_k$ for $l \leq l'$. Then $h(z_j) = 2k$ for all $l \leq j \leq l'$ and $(z_l, \varphi_l, \dots, z_{l'})$ is a cycle in Y_k . By assumption, Y_k is acyclic, and therefore $l = l' = l(k)$. The sequence $l(k)$ is increasing because the sequence $h(z_i)$ is.

For (2), note that $2k - 2 = h(z_{l(k-1)}) \leq h(z_j) \leq h(z_{l(k)}) = 2k$ for every $l(k-1) \leq j \leq l(k)$. Thus, $z_j \in X_k$.

Finally, (3) follows from (2) and injectivity of the maps j_k . \square

Vertical decomposition. We reuse the notation from the previous subsection. We assume that $Y_k = \bigsqcup_{q \in C_k} Y_{k,q}$ is written as a disjoint union of components. For any sequence $\mathbf{q} = (q_k)_{k=1}^{n-1}$, $q_k \in C_k$ we write

$$Z(\mathbf{q}) = Z_n((X_k)_{k=1}^n, (Y_{k,q_k})_{k=1}^{n-1}, (f_k|_{Y_{k,q_k}})_{k=1}^{n-1}, (g_k|_{Y_{k,q_k}})_{k=1}^{n-1}).$$

This is the sequential gluing of the X_k 's in which we do not glue along the whole pc-sets Y_k , but only along their chosen components. By taking the union indexed by all possible choices we obtain an HDA that is weakly equivalent to the original sequential gluing:

Proposition 13.3. *The map $\bigsqcup_{\mathbf{q} \in C_1 \times \dots \times C_{n-1}} Z(\mathbf{q}) \rightarrow Z$ induced by the identities on X_k and the inclusions $Y_{k,q_k} \subseteq Y_k$ is a weak equivalence.*

Proof. Suppose $\alpha \in P_Z$ is an accepting path and (r_k) a checkpoint sequence for α . Let q_k be the index of the component Y_{k,q_k} containing r_k . The representation $\alpha = \beta_1 * \dots * \beta_n$ associated to (r_k) also defines a path α' in $Z(\mathbf{q})$, which obviously maps to α under the canonical map. \square

Self-gluing. Let X be an HDA, Y a precubical set, $f : Y \rightarrow X$ an initial inclusion and $g : Y \rightarrow X$ a final inclusion. Suppose Y is acyclic and the sets $f(Y)$, $g(Y)$, X_\perp and X^\top are pairwise disjoint. Below we identify $f(Y)$, the ‘‘initial’’ copy of Y in X , with the ‘‘final’’ copy $g(Y)$. Then we show that the resulting automaton is weakly equivalent to the union of the sequence of the finite gluing compositions.

Define an HDA

$$V = \mathbb{V}(X, Y, f, g) = \text{colim} \left(Y \begin{array}{c} \xrightarrow{f} \\ \xrightarrow{g} \end{array} X \right). \quad (13.2)$$

Let $j : X \rightarrow V$, $i : Y \rightarrow V$ be the structural maps, let $V_\perp = j(X_\perp)$ and $V^\top = j(X^\top)$. Hence V is obtained from X by identifying cells $f(y)$ and $g(y)$ for $y \in Y$. Every cell $z \in V$ is either represented by a single cell $x \in X$ if $z \notin i(Y)$ or by a pair of cells $(f(y), g(y))$, $y \in Y$.

Unlike for sequential gluings, we cannot assume that X is proper. Hence j is not necessarily injective and X need not be a precubical subset of V .

For $n \geq 1$ let

$$Z_n(X, Y, f, g) = Z_n((X_k)_{k=1}^n, (Y_k)_{k=1}^{n-1}, (f_k)_{k=1}^{n-1}, (g_k)_{k=1}^{n-1})$$

where we take $X_k = X$, $Y_k = Y$, $f_k = f$, $g_k = g$ for all k . As before, we let

$$Z_n(X, Y, f, g)_\perp = (X_1)_\perp, \quad Z_n(X, Y, f, g)^\top = (X_n)^\top.$$

The transformation from diagram (13.1) to (13.2) that maps all X_k 's into X , Y_k 's into Y , f_k 's into f and g_k 's into g induces a map $\pi_n : Z_n(X, Y, f, g) \rightarrow \mathbb{V}(X, Y, f, g)$.

Proposition 13.4. *The map*

$$\pi = \bigsqcup \pi_n : \mathbf{Z}_n(X, Y, f, g) \rightarrow \mathbf{V}(X, Y, f, g)$$

is a weak equivalence.

Proof. Suppose $\alpha = (z_1, \varphi_1, \dots, z_m) \in \mathbf{P}_V$ is an accepting path. We can choose a sequence $1 < l(1) < \dots < l(n-1) < m$ of indices such that $z_{l(k)} \in i(Y)$. Then there exists $b(k)$ with $l(k-1) < b(k) < l(k)$ such that $z_{b(k)} \notin i(Y)$ ($1 < k < n-1$) and k is maximal. Further, let $b(0) = 1$, $b(n) = m$. Equivalently, we can choose one representative $l(k)$ from every sequence of consecutive cells of α that belong to $i(Y)$, and we can choose representatives $b(k)$ from all sequences of cells that not belong to $i(Y)$. For $1 < k < n-1$ we choose cells $x_s^k \in j^{-1}(z_s)$ for $l(k-1) \leq s \leq l(k)$. If $z_s \notin i(Y)$, then x_s^k is the only element of $j^{-1}(z_s)$. Otherwise, $j^{-1}(z_s) = \{f(y_s), g(y_s)\}$ for some $y_s \in Y$ and we put $x_s^k = f(y_s)$ for $s < b(k)$ and $x_s^k = g(y_s)$ for $s > b(k)$.

We show that $\beta_k = (x_{l(k-1)}^k, \varphi_{l(k-1)}, \dots, x_{l(k)}^k)$ is a path in X . Pick an arbitrary index $s \in \{l(k-1), \dots, l(k)-1\}$ and assume that $\varphi_s = d_B^1$. We must check that $\delta_B^1(x_s^k) = x_{s+1}^k$. It is clear that both $\delta_B^1(x_s^k)$ and x_{s+1}^k belong to $j^{-1}(z_{s+1})$ because $z_{s+1} = \delta_B^1(z_s)$. If $z_{s+1} \notin i(Y)$, then $j^{-1}(z_{s+1})$ has one element and there is nothing to prove. Otherwise, $j^{-1}(z_{s+1}) = \{f(y), g(y)\}$ for some $y \in Y$.

- If $z_s \notin i(Y)$, then $s+1 > b(k)$, and thus, by definition, $x_{s+1}^k = g(y)$. Further, $\delta_B^1(x_s^k) \notin f(Y)$ (since $x_s^k \notin f(Y)$ and $f(Y)$ is an initial subset of X). Hence $\delta_B^1(x_s^k) = g(y) = x_{s+1}^k$.
- If $z_s \in i(Y)$, then either $s > b(k)$ and $x_s^k, x_{s+1}^k \in g(Y)$, or $s+1 < b(k)$ and $x_s^k, x_{s+1}^k \in f(Y)$. In both cases $\delta_B^1(x_s^k) = x_{s+1}^k$.

The case $\varphi_k = d_A^0$ follows by reversal. Finally, $\beta_k \in \mathbf{P}_X$.

Let $\alpha_k = (x_{l(k-1)}^k, \varphi_{l(k-1)}, \dots, x_{l(k)}^k) \in \mathbf{P}_X$. Then clearly $j(\beta_k) = \alpha_k$ and there are cells $y_k \in Y$ such that $\text{tgt}(\beta_k) = g(y_k)$ and $\text{src}(\beta_{k+1}) = f(y_k)$. Then $\gamma = j_1(\beta_1) * \dots * j_n(\beta_n)$, where $j_k : X \cong X_k \rightarrow \mathbf{Z}_n(X, Y, f, g)$ is the structural map, is a well-defined concatenation. This yields

$$\pi_n(\gamma) = \pi_n(j_1(\beta_1) * \dots * j_n(\beta_n)) = j(\beta_1) * \dots * j(\beta_n) = \alpha$$

and the claim holds. \square

14. SEQUENTIAL COMPOSITION OF SIMPLE IHDA S

Let $X_1, \dots, X_n \in \text{iHDA}$. Suppose that X_1 is accept simple and accept proper, that X_2, \dots, X_{n-1} are simple and proper, and that X_n is start simple and start proper. Let x_{\perp}^k ($k > 1$) and x_k^{\top} , for $k < n$, be the only start and accept cells of X_k , and assume that $\text{ev}(x_k^{\top}) = \text{ev}(x_{\perp}^{k+1}) = U_k$. The domains of both maps $\text{Cl}(\iota_{x_k^{\top}})$ and $\text{Cl}(\iota_{x_{\perp}^{k+1}})$ are thus equal to \square^{U_k} by Lemma 11.3. We do not require that $\text{iev}(x_k^{\top}) = \text{iev}(x_{\perp}^{k+1})$.

The *sequential composition* of X_1, \dots, X_n is the HDA

$$X_1 * \dots * X_n = \mathbf{Z}_n(\text{Cl}(X_k)_{k=1}^n, (\square^{U_k})_{k=1}^{n-1}, \text{Cl}(\iota_{x_{\perp}^k})_{k=1}^{n-1}, \text{Cl}(\iota_{x_k^{\top}})_{k=1}^{n-1}) \quad (14.1)$$

with $(X_1 * \dots * X_n)_{\perp} = \text{Cl}(X_1)_{\perp}$, $(X_1 * \dots * X_n)^{\top} = \text{Cl}(X_n)^{\top}$. The assumptions required by (13.1) are thus satisfied: the cubes \square^{U_k} are acyclic and the images of $\text{Cl}(\iota_{x_{\perp}^k})$ and $\text{Cl}(\iota_{x_k^{\top}})$ are disjoint by properness of the X_k . Note that the sequential composition considered is an

n -ary operation: it maps a sequence of iHDAs to an HDA. For short, we henceforth write Z for the HDA in (14.1).

We have $\text{iev}(x_k^\top) = S_k(U_k)_{U_k}$ and $\text{iev}(x_\perp^{k+1}) = U_k(U_k)_{T_k}$ for some $S_k, T_k \subseteq U_k$, which are not necessarily disjoint. The $i_k : \square^{U_k} \rightarrow Z$, $j_k : \text{Cl}(X_k) \rightarrow Z$ are structural maps, which we sometimes omit, regarding $\text{Cl}(X_k)$ and \square^{U_k} as precubical subsets of Z . Let $u_k = i_k([\emptyset|\emptyset]) = j_k([x_k^\top; \emptyset, \emptyset]) = j_{k+1}([x_\perp^{k+1}; \emptyset, \emptyset])$.

Proposition 14.1. $\text{Lang}(X_1) * \cdots * \text{Lang}(X_n) \subseteq \text{Lang}(X_1 * \cdots * X_n)$.

Proof. If $P \in \text{Lang}(X_1) * \cdots * \text{Lang}(X_n)$, then $P \sqsubseteq Q_1 * \cdots * Q_n$ for some $Q_k \in \text{Lang}(X_k)$. Choose accepting paths $\beta_k \in \mathbf{P}_{\text{Cl}(X_k)}$ such that $\text{ev}(\beta_k) = Q_k$, according to Proposition 11.4. Since $\text{tgt}(\beta_k) = [x_k^\top; \emptyset, \emptyset]$ and $\text{src}(\beta_{k+1}) = [x_\perp^{k+1}; \emptyset, \emptyset]$ represent the same cell u_k in Z , the β_k can be composed. Then

$$P \sqsubseteq Q_1 * \cdots * Q_n = \text{ev}(\beta_1) * \cdots * \text{ev}(\beta_n) = \text{ev}(\beta_1 * \cdots * \beta_n) \in \text{Lang}(X_1 * \cdots * X_n). \quad \square$$

The *defect* of an accepting path $\alpha \in \mathbf{P}_Z$ is

$$\min \left\{ \sum_{k=1}^{n-1} (|U_k| - \dim(r_k)) \mid (r_k)_{k=0}^n \text{ is a checkpoint sequence for } \alpha \right\}.$$

The defect of α measures how far α passes from the cells u_k . It is non-negative since $\dim(\square^{U_k}) = |U_k|$ and equal to 0 if and only if $r_k = u_k$ for all $1 \leq k < n$ since u_k are the only cells in \square^U of dimension $|U_k|$. A checkpoint sequence for which the minimum is obtained is called *maximal*, because it consists of cells with the maximal dimensions possible.

Lemma 14.2. *Let $\alpha \in \mathbf{P}_Z$ be a path that is not subsumed by another path with a smaller defect. Then $(u_k)_{k=0}^n$ is a checkpoint sequence for α (we assume $u_0 = \text{src}(\alpha)$, $u_k = \text{tgt}(\alpha)$).*

Proof. Let (r_k) be a maximal checkpoint sequence for α . By assumption, $r_k = \delta_{E_k, F_k}(u_k)$ and E_k, F_k are uniquely determined by injectivity of i_k . We wish to show that $E_k = F_k = \emptyset$.

Let $r_0 = \text{src}(\alpha)$, $r_n = \text{tgt}(\alpha)$. Let $\alpha = \beta_1 * \cdots * \beta_n$, $\beta_k \in \mathbf{P}_{X_k}(r_{k-1}, r_k)$, be the representation determined by $(r_k)_{k=0}^n$ according to Lemma 13.2.(c). By Lemma 11.9, every path β_k is subsumed by a path γ_k of the form

$$(r_{k-1} = [y; C_k \cup A_k, D_k] \nearrow^{A_k} [y; C_k, D_k]) * \beta'_k * ([z; C_k, D_k] \searrow_{B_k} [z; C_k, D_k \cup B_k] = r_k).$$

We show that $B_k = \emptyset$. For $k = n$, $[z; C_k, D_k \cup B_k] = [x_n^\top; \emptyset, \emptyset] \in \text{Cl}(X_n)^\top$ and thus $C_n = D_n \cup B_n = \emptyset$. For $k < n$, the cell r_k is a face of u_k . Then $[z; C_k, D_k \cup B_k]$ is a face of $[x_k^\top; \emptyset, \emptyset]$ by injectivity of j_k , z is a face of x_k^\top by Lemma 11.6 and $[z; C_k, D_k]$ is a face of $[x_k^\top; \emptyset, \emptyset]$ by the same lemma. Thus $[z; C_k, D_k]$ is a face of u_k , or equivalently, $[z; C_k, D_k] \in \square^{U_k}$. If $B \neq \emptyset$, then $[z; C_k, D_k]$ is of higher dimension than $r_k = [z; C_k, D_k \cup B_k]$. Then,

$$(r_1, \dots, r_{k-1}, [z; C_k, D_k], r_{k+1}, \dots, r_{n-1})$$

is a checkpoint sequence that contradicts the maximality of (r_k) and shows that $B_k = \emptyset$. Similarly, $A_k = \emptyset$ follows by reversal. This shows that every β_k has the form $([z_j^k; C_k, D_k], \varphi_j^k)_{j=1}^{m_k}$, that is, the second and third coordinates in β_k remain constant.

Next, we relate the sets C_k , D_k , E_k and F_k . For every $k = 1, \dots, n-1$,

$$r_k = \delta_{E_k, F_k}([x_k^\top; \emptyset, \emptyset]) = [\delta_{E_k \setminus S_k}^0(x_k^\top); E_k \cap S_k, F_k],$$

and hence $C_k = E_k \cap S_k$, $D_k = F_k$. Moreover,

$$r_k = \delta_{E_k, F_k}([x_{\perp}^{k+1}; \emptyset, \emptyset]) = [\delta_{F_k \setminus T_k}^0(x_{\perp}^{k+1}); E_k, F_k \cap T_k],$$

and thus $C_{k+1} = E_k$, $D_{k+1} = F_k \cap T_k$. Therefore, $C_k \subseteq C_{k+1}$ and $D_k \supseteq D_{k+1}$. Furthermore, $C_1 = D_1 = \emptyset$ since $\text{src}(\beta_1) \in \text{Cl}(X_1)_{\perp}$ and $C_n = D_n = \emptyset$ since $\text{tgt}(\beta_n) \in \text{Cl}(X_n)^{\top}$. The sets C_k , D_k , E_k and F_k are therefore empty, $r_k = \delta_{E_k, F_k}(u_k) = u_k$ and α has defect 0. \square

Lemma 14.3. *Every accepting path $\gamma \in \mathbf{P}_Z$ is subsumed by a path α with checkpoint sequence $(\text{src}(\alpha), u_1, \dots, u_{n-1}, \text{tgt}(\alpha))$. Thus α traverses the interiors of the gluing cubes \square^{U_k} .*

Proof. Let $\alpha \in \mathbf{P}_Z$ be a path with minimal defect among all paths subsuming γ . The conclusion then follows by Proposition 14.2. \square

Proposition 14.4. $\text{Lang}(X_1 * \dots * X_n) = \text{Lang}(X_1) * \dots * \text{Lang}(X_n)$.

Proof. Let $P \in \text{Lang}(Z)$ and $\gamma \in \mathbf{P}_Z$ be an accepting path such that $\text{ev}(\gamma) = P$. Then γ is subsumed by an $\alpha \in \mathbf{P}_Z$ with checkpoint sequence $(u_k)_{k=0}^n$ by Lemma 14.3 and the $\beta_k \in \mathbf{P}_{\text{Cl}(X_k)}$ determined by $(u_k)_{k=0}^n$, according to Lemma 13.2, are accepting. Therefore

$$\begin{aligned} P = \text{ev}(\gamma) &\sqsubseteq \text{ev}(\alpha) \\ &= \text{ev}(j_1(\beta_1) * \dots * j_n(\beta_n)) \\ &= \text{ev}(\beta_1) * \dots * \text{ev}(\beta_n) \in \text{Lang}(\text{Cl}(X_1)) * \dots * \text{Lang}(\text{Cl}(X_n)) \\ &= \text{Lang}(X_1) * \dots * \text{Lang}(X_n) \end{aligned}$$

and thus $\text{Lang}(Z) \subseteq \text{Lang}(X_1) * \dots * \text{Lang}(X_n)$. The converse inclusion follows from Proposition 14.1. \square

After all these preparations we can finally show that gluing compositions of regular languages are regular.

Proof of Proposition 6.4. Let L and M be regular languages. If they are simple, then there exist simple iHDAs X and Y that recognise L and M . Proposition 12.9 allows us to assume that X is accept simple and accept proper and that Y is start simple and start proper. Proposition 14.4 then implies that

$$\text{Lang}(X * Y) = \text{Lang}(X) * \text{Lang}(Y) = L * M$$

is regular. Otherwise, if L and M are not simple, then $L = \bigcup_i L_i$ and $M = \bigcup_j M_j$ for simple regular languages L_i and M_j by Lemma 11.8. In this case,

$$L * M = \left(\bigcup_i L_i \right) * \left(\bigcup_j M_j \right) = \bigcup_i \bigcup_j L_i * M_j$$

is regular by Proposition 5.12. \square

15. KLEENE PLUS

Suppose X is an iHDA such that $\text{Lang}(X)$ is separated. We construct an HDA X^+ such that $\text{Lang}(X^+) = \text{Lang}(X)^+$. We wish to identify accept cells with start cells that have the same events. But identifying all of them would produce too many accepting paths. For every accept cell y we thus add a copy for every start cell compatible with y , and an extra one to replace the original one – and likewise for start cells. We must then ensure that the iHDA constructed is proper. The following fact ensures that we can construct the cylinder below.

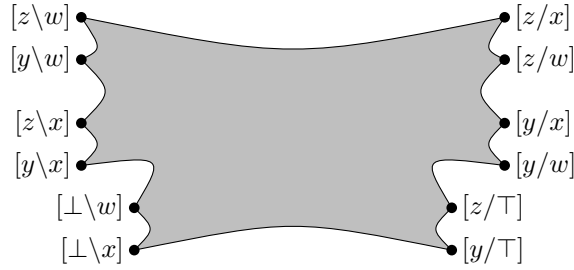

Figure 22: A specimen of spider

Lemma 15.1. *Let $X \in \mathbf{iHDA}$ and $\mathbf{Lang}(X)$ be separated. Then $\text{im}(\iota_{\perp}^X) \cap \text{im}(\iota_X^{\top}) = \emptyset$.*

Proof. Suppose $y \in \text{im}(\iota_{\perp}^X) \cap \text{im}(\iota_X^{\top})$ for some $y \in X[V]$. Then $\delta_B^1(x) = y = \delta_A^0(z)$ for some $U, W \in \mathbf{I}\square$, $x \in X_{\perp}[U]$, $z \in X^{\top}[W]$, $B \subseteq U$, $A \subseteq W$ and $U \setminus B = V = W \setminus A$ because start/accept cells have only upper/lower faces. Then every event of the ipomset

$$\text{ev}(x \searrow_B y \nearrow^A z) = {}_U U_V * {}_V W_W$$

in $\mathbf{Lang}(X)$ lies in one of the interfaces U , W and $\mathbf{Lang}(X)$ is not separated. \square

Let $G = \{(y, x) \mid y \in X^{\top}, x \in X_{\perp}, \text{ev}(x) = \text{ev}(y)\}$, let $G_{\perp} = \{(\perp, x) \mid x \in X_{\perp}\}$ and $G^{\top} = \{(y, \top) \mid y \in X^{\top}\}$. Define

$$J_{\perp} = \bigsqcup_{(y,x) \in G \cup G_{\perp}} \mathbf{I}\square^{\text{iev}(x)} \quad \text{and} \quad J^{\top} = \bigsqcup_{(y,x) \in G \cup G^{\top}} \mathbf{I}\square^{\text{iev}(y)}.$$

Further, let $w_{\perp} = \bigsqcup \iota_x : J_{\perp} \rightarrow X$, $w^{\top} = \bigsqcup \iota_y : J^{\top} \rightarrow X$. The maps w_{\perp} and w^{\top} are similar to the start and accept maps, but more than one cube can be mapped into a start or accept cell.

We define the *spider* of X as the cylinder $\mathbf{Sp}(X) = C(w_{\perp}, w^{\top})$. It is well-defined because $\text{im}(w_{\perp}) \cap \text{im}(w^{\top}) = \text{im}(\iota_{\perp}^X) \cap \text{im}(\iota_X^{\top}) = \emptyset$, since $\mathbf{Lang}(X)$ is separated and by Lemma 15.1. The spider is equipped with an initial inclusion $\tilde{w}_{\perp} : J_{\perp} \rightarrow \mathbf{Sp}(X)$ and a final inclusion $\tilde{w}^{\top} : J^{\top} \rightarrow \mathbf{Sp}(X)$ (Lemma 12.7). We write

$$\begin{aligned} [y \setminus x] &= \tilde{w}_{\perp}((y, x), [\emptyset | \emptyset]) \in \mathbf{Sp}(X)[\text{iev}(x)], \\ [y/x] &= \tilde{w}^{\top}((y, x), [\emptyset | \emptyset]) \in \mathbf{Sp}(X)[\text{iev}(y)] \end{aligned}$$

for $(y, x) \in G \cup G_{\perp}$ in the upper line and $(y, x) \in G \cup G^{\top}$ in the lower line.

Each cell $[y \setminus x]$ is a ‘‘copy’’ of x that is to be connected to a copy $[y/x]$ of y . Such copies serve as start and accept cells of $\mathbf{Sp}(X)$: we put $\mathbf{Sp}(X)_{\perp} = \{[\perp \setminus x] \mid x \in X_{\perp}\}$ and $\mathbf{Sp}(X)^{\top} = \{[y/\top] \mid y \in X^{\top}\}$. See Figure 22 for an example.

We also use $\mathbf{Sp}(X)$ in combination with other sets of start and accept cells: for each subset $S, T \subseteq \mathbf{Sp}(X)$, $\mathbf{Sp}(X)_{S}^T$ denotes the iHDA with underlying ipc-set $\mathbf{Sp}(X)$, start cells S and accept cells T . We use a similar convention for X .

Lemma 15.2. *For $(y', x) \in G \cup G_{\perp}$, $(y, x') \in G \cup G^{\top}$, the projection map*

$$p : \mathbf{Sp}(X)_{[y \setminus x']}^{[y/x']} \rightarrow X_x^y$$

is a weak equivalence.

Proof. We have $p([y' \setminus x]) = x \in \text{im}(w_\perp)$ and $p([y/x']) = y \in \text{im}(w^\top)$. Since p has the TLP with respect to x, y by Proposition 12.8, it is a weak equivalence by Proposition 12.5(c). \square

Every accepting path $\alpha \in P_X(x, y)$ can therefore be lifted to a path from any copy of x to any copy of y .

Next, we identify “start copies” with “accept copies”. To achieve this we need to pass to HDAs. We abbreviate $\text{CSp}(X) = \text{Cl}(\text{Sp}(X))$. We regard cells $[y \setminus x]$ and $[y/x]$ as cells of $\text{CSp}(X)$ – formally, we should write $[[y \setminus x]; \emptyset, \emptyset]$ and $[[y/x]; \emptyset, \emptyset]$ instead.

Let $W_\perp(X) \subseteq J_\perp$, $W^\top(X) \subseteq J^\top$ be the unions of cubes indexed by G (we omit G_\perp and G^\top , respectively). The closures of $W_\perp(X)$ and $W^\top(X)$ are naturally isomorphic to

$$W(X) = \bigsqcup_{(x,y) \in G} \square^{\text{ev}(x)} = \bigsqcup_{(x,y) \in G} \square^{\text{ev}(y)}$$

by Lemma 11.3. Let $f, g : W(X) \rightarrow \text{CSp}(X)$ be the closures of the restrictions $f = \text{Cl}(\tilde{w}_\perp|_{W_\perp(X)})$ and $g = \text{Cl}(\tilde{w}^\top|_{W^\top(X)})$. Since $W_\perp(X) \subseteq J_\perp$ and $W^\top(X) \subseteq J^\top$ are initial and final subsets, f is an initial inclusion and g a final one by Lemma 12.1. Now we are ready to define the HDA

$$X^+ = \mathbf{V}(\text{CSp}(X), W(X), f, g).$$

It remains to show that $\text{Lang}(X^+) = \text{Lang}(X)^+$. The map

$$\bigsqcup_{n \geq 1} Z_n(\text{CSp}(X), W(X), f, g) \rightarrow \mathbf{V}(\text{CSp}(X), W(X), f, g) \quad (15.1)$$

is a weak equivalence by Proposition 13.4. For any sequence $\Gamma = (x_k, y_k)_{k=1}^{n-1} \in G^{n-1}$ and $U_k = \text{ev}(x_k) = \text{ev}(y_k)$ we define

$$\begin{aligned} \mathfrak{S}_n(X; \Gamma) &= Z_n(\text{CSp}(X)_{k=1}^n, (\square^{U_k})_{k=1}^{n-1}, \text{Cl}(t_{[y_k \setminus x_k]})_{k=1}^{n-1}, \text{Cl}(t_{[y_k/x_k]})_{k=1}^{n-1}) \\ &= \text{Sp}(X)_{[\perp \setminus X_\perp]}^{[y_1/x_1]} * \text{Sp}(X)_{[y_1 \setminus x_1]}^{[y_2/x_2]} * \cdots * \text{Sp}(X)_{[y_{n-1} \setminus x_{n-1}]}^{[X^\top/\top]}, \end{aligned}$$

where $[\perp \setminus X_\perp] = \{[\perp \setminus x] \mid x \in X_\perp\}$, $[X^\top/\top] = \{[y/\top] \mid y \in X^\top\}$.

Proposition 13.3, applied to the decomposition (15.1), shows that

$$\bigsqcup_{\Gamma \in G^{n-1}} \mathfrak{S}_n(X; \Gamma) \rightarrow Z_n(\text{CSp}(X), W(X), f, g)$$

is a weak equivalence. As weakly equivalent HDAs have equal languages (Lemma 5.10), we obtain the following fact.

Lemma 15.3. $\text{Lang}(X^+) = \bigcup_{n \geq 1} \bigcup_{\Gamma \in G^{n-1}} \text{Lang}(\mathfrak{S}_n(X; \Gamma))$.

Proposition 14.4 and Lemma 15.2 then imply that

$$\begin{aligned} &\text{Lang}(\mathfrak{S}_n(X; \Gamma)) \\ &= \text{Lang}\left(\text{Sp}(X)_{[\perp \setminus X_\perp]}^{[y_1/x_1]}\right) * \text{Lang}\left(\text{Sp}(X)_{[y_1 \setminus x_1]}^{[y_2/x_2]}\right) * \cdots * \text{Lang}\left(\text{Sp}(X)_{[y_{n-1} \setminus x_{n-1}]}^{[X^\top/\top]}\right) \\ &= \text{Lang}(X_{X_\perp}^{y_1}) * \text{Lang}(X_{x_1}^{y_2}) * \cdots * \text{Lang}(X_{x_{n-1}}^{X^\top}). \end{aligned} \quad (15.2)$$

Lemma 15.4. $\bigcup_{\Gamma \in G^{n-1}} \text{Lang}(\mathfrak{S}_n(X; \Gamma)) = \text{Lang}(X)^n$.

Proof. We have

$$\begin{aligned}
\text{Lang}(X)^n &= \text{Lang}(X) * \cdots * \text{Lang}(X) \\
&= \left(\bigcup_{y_1 \in X^\top} \text{Lang}(X_{X_\perp}^{y_1}) \right) * \left(\bigcup_{\substack{x_1 \in X_\perp \\ y_2 \in X^\top}} \text{Lang}(X_{x_1}^{y_2}) \right) * \cdots * \left(\bigcup_{x_{n-1} \in X_\perp} \text{Lang}(X_{x_{n-1}}^{X^\top}) \right) \\
&= \bigcup_{\substack{x_1, \dots, x_{n-1} \in X_\perp \\ y_1, \dots, y_{n-1} \in X^\top}} \text{Lang}(X_{X_\perp}^{y_1}) * \text{Lang}(X_{x_1}^{y_2}) * \cdots * \text{Lang}(X_{x_{n-1}}^{X^\top}) \\
&\stackrel{(\dagger)}{=} \bigcup_{\Gamma = (x_k, y_k) \in G^{n-1}} \text{Lang}(X_{X_\perp}^{y_1}) * \text{Lang}(X_{x_1}^{y_2}) * \cdots * \text{Lang}(X_{x_{n-1}}^{X^\top}) \\
&\stackrel{(15.2)}{=} \bigcup_{\Gamma \in G^{n-1}} \text{Lang}(\mathfrak{S}_n(X; \Gamma)).
\end{aligned}$$

In (\dagger) we use the fact that $\text{Lang}(X_{x_{k-1}}^{y_k}) * \text{Lang}(X_{x_k}^{y_{k+1}}) = \emptyset$ whenever $\text{ev}(y_k) \neq \text{ev}(x_k)$. \square

Proposition 15.5. *The Kleene plus of a separated regular language is regular.*

Proof. From Lemmas 15.3 and 15.4 it follows that

$$\text{Lang}(X^+) = \bigcup_{n \geq 1} \text{Lang}(X)^n = \text{Lang}(X)^+. \quad \square$$

Finally we can prove that the Kleene plus of any regular language is regular.

Proof of Proposition 6.5. Suppose L is regular. If $L \cap \text{Id} = \emptyset$, then L^n is separated for sufficiently large n by Lemma 4.6. In this case,

$$L^+ = \bigcup_{i=1}^n L^i \cup \left(\bigcup_{i=1}^n L^i \right) * (L^n)^+$$

is regular by Propositions 5.12, 6.4 and 15.5. If $L \cap \text{Id} \neq \emptyset$, then

$$L^+ = ((L \cap \text{Id}) \cup (L \setminus \text{Id}))^+ = (L \cap \text{Id}) \cup (L \setminus \text{Id})^+$$

is regular by Propositions 5.12 and 12.10. \square

As outlined in Section 6, the proof of the Kleene theorem for higher-dimensional automata is now complete.

16. CONCLUSION

Automata accept languages, but higher-dimensional automata have for a long time been an exception to this rule. Here, we have proved a Kleene theorem for HDAs, connecting models to behaviours through an equivalence between regular and rational languages.

Showing that regular languages are rational was quite direct, while the converse direction required some effort. One reason is that HDAs may be glued not only at states, but also at higher-dimensional cells. This led us to consider languages of ipomsets and to equip HDAs with interfaces, yielding iHDAs. After showing that HDAs and iHDAs recognise the same languages, we used constructions inspired by topology to glue (i)HDAs and show that rational operations on languages can be reflected by operations on them.

Kleene theorems build bridges between machines and languages, and there is a vast literature on this subject. In non-interleaving concurrency, one school considers Mazurkiewicz trace languages. Zielonka introduces asynchronous automata and shows that languages are regular if and only if they are recognisable [Zie87]. Droste’s automata with concurrency relations have similar properties [Dro94]. Yet not all rational trace languages that are generated from singletons using union, concatenation and Kleene star are recognisable [CG95]. Trace languages use a binary notion of independence and already 2-dimensional HDAs may exhibit behaviour that cannot be captured by trace languages [Gou02].

Another school studies Kleene theorems for series-parallel pomset languages and automata models for these, such as branching and pomset automata [LW00, KBL⁺19], and Petri automata [BP17]. Series-parallel pomsets are incomparable to the interval orders accepted by Petri nets or HDAs [Vog92, FJSZ22b].

HDAs have been developed first of all with a view on operational, topological and geometric aspects of concurrency, see [FGH⁺16] and the extensive bibliography in [vG06a]. But languages for HDAs have only been introduced recently [FJSZ21]. Topological intuitions have also guided our present work, for example in the cylinder construction.

Our formalisation of (i)HDAs as presheaves on a category of labelled posets opens up connections to presheaf automata [Sob15], coalgebra, and open maps [JNW96], which we intend to explore. Finally, our introduction of iHDA morphisms akin to cofibrations and trivial fibrations hints at factorisation systems. Weak factorisation systems and model categories have been considered in a bisimulation context, for example in [KR05], and we wonder about the connection.

Acknowledgments. We are very grateful to the anonymous reviewers who helped us to improve the presentation of our results significantly.

REFERENCES

- [BP17] Paul Brunet and Damien Pous. Petri automata. *Logical Methods in Computer Science*, 13(3), 2017. doi:10.23638/LMCS-13(3:33)2017.
- [CG95] Christian Choffrut and Leucio Guerra. Logical definability of some rational trace languages. *Mathematical Systems Theory*, 28(5):397–420, 1995. doi:10.1007/BF01185864.
- [Dro94] Manfred Droste. A Kleene theorem for recognizable languages over concurrency monoids. In Serge Abiteboul and Eli Shamir, editors, *ICALP*, volume 820 of *Lecture Notes in Computer Science*, pages 388–399. Springer, 1994. doi:10.1007/3-540-58201-0_84.
- [FGH⁺16] Lisbeth Fajstrup, Eric Goubault, Emmanuel Haucourt, Samuel Mimram, and Martin Raussen. *Directed Algebraic Topology and Concurrency*. Springer, 2016. doi:10.1007/978-3-319-15398-8.
- [Fis85] Peter C. Fishburn. *Interval Orders and Interval Graphs: A Study of Partially Ordered Sets*. Wiley, 1985.
- [FJSZ21] Uli Fahrenberg, Christian Johansen, Georg Struth, and Krzysztof Ziemiański. Languages of higher-dimensional automata. *Mathematical Structures in Computer Science*, 31(5):575–613, 2021. doi:10.1017/S0960129521000293.
- [FJSZ22a] Uli Fahrenberg, Christian Johansen, Georg Struth, and Krzysztof Ziemiański. A Kleene theorem for higher-dimensional automata. In Bartek Klin, Slawomir Lasota, and Anca Muscholl, editors, *CONCUR*, volume 243 of *Leibniz International Proceedings in Informatics*, pages 29:1–29:18. Schloss Dagstuhl - Leibniz-Zentrum für Informatik, 2022. URL: <https://doi.org/10.4230/LIPIcs.CONCUR.2022.29>, doi:10.4230/LIPIcs.CONCUR.2022.29.
- [FJSZ22b] Uli Fahrenberg, Christian Johansen, Georg Struth, and Krzysztof Ziemiański. Posets with interfaces as a model for concurrency. *Information and Computation*, 285(B):104914, 2022. doi:10.1016/j.ic.2022.104914.

- [FRG06] Lisbeth Fajstrup, Martin Raussen, and Eric Goubault. Algebraic topology and concurrency. *Theoretical Computer Science*, 357(1-3):241–278, 2006.
- [GM03] Marco Grandis and Luca Mauri. Cubical sets and their site. *Theory and Applications of Categories*, 11(8):185–211, 2003.
- [Gou02] Eric Goubault. Labelled cubical sets and asynchronous transition systems: an adjunction. In *CMCIM*, 2002. <http://www.lix.polytechnique.fr/~goubault/papers/cmcm02.ps.gz>.
- [Gra81] Jan Grabowski. On partial languages. *Fundamentae Informatica*, 4(2):427, 1981.
- [Gra09] Marco Grandis. *Directed algebraic topology: models of non-reversible worlds*. New mathematical monographs. Cambridge University Press, 2009.
- [JNW96] André Joyal, Mogens Nielsen, and Glynn Winskel. Bisimulation from open maps. *Information and Computation*, 127(2):164–185, 1996.
- [KBL⁺19] Tobias Kappé, Paul Brunet, Bas Luttik, Alexandra Silva, and Fabio Zanasi. On series-parallel pomset languages: Rationality, context-freeness and automata. *Journal of Logic and Algebraic Methods in Programming*, 103:130–153, 2019. doi:10.1016/j.jlamp.2018.12.001.
- [KR05] Alexander Kurz and Jiří Rosický. Weak factorizations, fractions and homotopies. *Applied Categorical Structures*, 13(2):141–160, 2005.
- [LW00] Kamal Lodaya and Pascal Weil. Series-parallel languages and the bounded-width property. *Theoretical Computer Science*, 237(1-2):347–380, 2000. doi:10.1016/S0304-3975(00)00031-1.
- [Pra91] Vaughan R. Pratt. Modeling concurrency with geometry. In *POPL*, pages 311–322, New York City, 1991. ACM Press.
- [Sob15] Pawel Sobocinski. Relational presheaves, change of base and weak simulation. *J. Comput. Syst. Sci.*, 81(5):901–910, 2015. doi:10.1016/j.jcss.2014.12.007.
- [vG91] Rob J. van Glabbeek. Bisimulations for higher dimensional automata. Email message, June 1991. <http://theory.stanford.edu/~rvg/hda>.
- [vG06a] Rob J. van Glabbeek. On the expressiveness of higher dimensional automata. *Theoretical Computer Science*, 356(3):265–290, 2006. See also [vG06b].
- [vG06b] Rob J. van Glabbeek. Erratum to “On the expressiveness of higher dimensional automata”. *Theoretical Computer Science*, 368(1-2):168–194, 2006.
- [Vog92] Walter Vogler. *Modular Construction and Partial Order Semantics of Petri Nets*, volume 625 of *Lecture Notes in Computer Science*. Springer, 1992. doi:10.1007/3-540-55767-9.
- [Win77] Józef Winkowski. An algebraic characterization of the behaviour of non-sequential systems. *Information Processing Letters*, 6(4):105–109, 1977. doi:10.1016/0020-0190(77)90021-7.
- [Zie87] Wiesław Zielonka. Notes on finite asynchronous automata. *RAIRO - Theoretical Informatics and Applications*, 21(2):99–135, 1987. doi:10.1051/ita/1987210200991.

APPENDIX A. DEFINITIONS OF HDAs

Precubical sets and HDAs appear in different incarnations in the literature, all of them more or less equivalent. We discuss some of these in this Appendix to relate them with our own approach, but make no claim as to completeness.

Precubical sets. Precubical sets à la Grandis [GM03, Gra09] are presheaves on a small category \square_G , defined by the following data:

- objects are $\{0, 1\}^n$ for $n \geq 0$;
- elementary coface maps $d_i^\nu : \{0, 1\}^n \rightarrow \{0, 1\}^{n+1}$, for $i = 1, \dots, n+1$ and $\nu = 0, 1$, are given by $d_i^\nu(t_1, \dots, t_n) = (t_1, \dots, t_{i-1}, \nu, t_i, \dots, t_n)$.

Elementary coface maps compose to coface maps $\{0, 1\}^m \rightarrow \{0, 1\}^n$ for $n \geq m$ in the standard way.

\square_G -sets, that is, elements $X \in \mathbf{Set}^{\square_G^{\text{op}}}$, are then graded sets $X = \{X_n\}_{n \geq 0}$, where $X_n = X[\{0, 1\}^n]$, together with face maps $X_n \rightarrow X_m$ for $n \geq m$. The elementary face maps

are denoted $\delta_i^\nu = X[d_i^\nu]$. They must satisfy the *precubical identity*, for any $\nu, \mu \in \{0, 1\}$ and $i < j$:

$$\delta_i^\nu \delta_j^\mu = \delta_{j-1}^\mu \delta_i^\nu. \quad (\text{A.1})$$

This description of \square_G -sets may be taken as a definition without using presheaves. For example, van Glabbeek [vG06a] defines a precubical set $Q = (Q, s, t)$ as a family of sets $(Q_n)_{n \geq 0}$ and maps $s_i : Q_n \rightarrow Q_{n-1}$, $1 \leq i \leq n$, such that $\alpha_i \circ \beta_j = \beta_{j-1} \circ \alpha_i$ for all $1 \leq i < j \leq n$ and $\alpha, \beta \in \{s, t\}$. This is equivalent to the above.

We have previously introduced another base category, \square_Z , defined as follows [FJSZ21]:

- objects are totally ordered sets (S, \dashrightarrow_S) ;
- morphisms $S \rightarrow T$ are pairs (f, ε) , where $f : S \hookrightarrow T$ is an order preserving injection and $\varepsilon : T \rightarrow \{0, \lrcorner, 1\}$ satisfies $f(S) = \varepsilon^{-1}(\lrcorner)$.

The element \lrcorner stands for “active”, a notation previously used by van Glabbeek. Writing $A = \varepsilon^{-1}(0)$ and $B = \varepsilon^{-1}(1)$ makes the above notion of morphism equivalent to the triples (f, A, B) consisting of $f : S \hookrightarrow T$ (order preserving and injective) and $A, B \subseteq T$ such that $T = A \sqcup f(S) \sqcup B$ (disjoint union). Except for the labels, this is our definition of \square in Section 3.

Using this definition, it can be shown that the full subcategory of \square_Z spanned by the objects \emptyset and $\{1, \dots, n\}$ for $n \geq 1$ is skeletal and equivalent to \square_Z [FJSZ21]. Moreover, this subcategory, \square_Z , is isomorphic to \square_G , and the presheaf categories on \square_Z and on \square_G (and thus also on \square_G) are uniquely naturally isomorphic. It is clear that \square_Z is a representative of the quotient of \square_Z with respect to isomorphisms, so, except for the labelling, this is again our category \square from Section 3.

The advantage of \square_Z and \square over the skeletal versions is that the precubical identity (A.1) is automatic and that there is a built-in notion of events and actions, that is, in a \square_Z -set X , each cell $x \in X[U]$ has events U .

HDAs. Higher-dimensional automata are Σ -labelled precubical sets with specified start and accept cells. The labelling may be obtained using the labelling object $!\Sigma$ [Gou02]. This is the precubical set with $!\Sigma_n = \Sigma^n$ and $\delta_i^\nu((a_1, \dots, a_n)) = (a_1, \dots, a_{i-1}, a_{i+1}, \dots, a_n)$. A labelled precubical set is then a precubical map $X \rightarrow !\Sigma$, that is, an object of the slice category of precubical sets over $!\Sigma$.

Each labelling function $\lambda : X \rightarrow !\Sigma$ induces a function $\lambda_1 : X_1 \rightarrow \Sigma$ satisfying $\lambda_1(\delta_1^0(x)) = \lambda_1(\delta_1^1(x))$ and $\lambda_1(\delta_2^0(x)) = \lambda_1(\delta_2^1(x))$ for all $x \in X_2$. Conversely, each such function extends uniquely to a precubical map $X \rightarrow !\Sigma$ [FJSZ21, Lemma 14], so that λ_1 may be taken as the primary definition instead. This is the approach in [vG06a], where HDAs are defined as precubical sets Q equipped with functions $\lambda_1 \rightarrow \Sigma$ such that $\lambda_1(s_i(q)) = \lambda_1(t_i(q))$ for all $q \in Q_2$ and $i = 1, 2$, and subsets of start and accept states $I, F \subseteq Q_0$.

Regarded as a presheaf, $!\Sigma(S) = \text{Set}(S, \Sigma)$. Hence $!\Sigma$ is representable in Set via the forgetful functor $\square_Z \rightarrow \text{Set}$ [FJSZ21]. Labels can thus be integrated into the base category, which turns \square_Z into our category \square , with labelled totally ordered sets as objects. Using \square instead of \square_Z allows working in a labelled setting ab initio instead of taking a slice category.

To summarise, starting from an HDA X as defined in this article, an HDA $(Q, s, t, \lambda_1, I, F)$ à la van Glabbeek [vG06a] can be obtained as follows:

- $Q_n = \bigsqcup_{U \in \square, |U|=n} X[U]$.
- If $x \in X[U]$, then $s_i(x) = \delta_u^0(x)$ and $t_i(x) = \delta_u^1(x)$, where $u \in U$ is the i -th smallest element of U in the order \dashrightarrow_U .

- If $x \in X[U] \subseteq Q_{\perp}$ with $U = (\{e\}, \emptyset, \lambda(e) = a)$, then $\lambda_1(x) = a$.
- $I = X_{\perp}$, $F = X^{\top}$.

Conversely, let $(Q, s, t, \lambda_1, I, F)$ be an HDA à la van Glabbeek. Then there are unique labelling functions $\lambda_n : Q_n \rightarrow \Sigma^n$ that satisfy $\lambda_{n-1}(\alpha_i(q)) = \delta_i(\lambda_n(q))$ [FJSZ21, Lemma 14], where $\alpha \in \{s, t\}$ and δ_i discards the i -th element of a sequence. We can then construct an HDA X in the sense of this article as follows:

- $X[U] = \{q \in Q_n \mid \lambda_n(q) = U\}$ for $U \in \square$ and $|U| = n$.
- $\delta_a^0(q) = s_i(q)$ and $\delta_a^1(q) = t_i(q)$ for $q \in X[U]$ and $a \in U$ the i -th smallest element of U in the order \dashrightarrow_U . The remaining face maps are composites of these.
- $X_{\perp} = I$ and $X^{\top} = F$.