

Dijkstra-Through-Time: Ahead of time hardware scheduling method for deterministic workloads

Vincent Tableau Roche

Nokia Bell Labs

Antwerp, Belgium

vincent.tableau_roche.ext@nokia.com

Purushotham Murugappa Velayuthan

Nokia Bell Labs

Antwerp, Belgium

purushotham.mv@nokia-bell-labs.com

Abstract—Most of the previous works on data flow optimizations for Machine Learning hardware accelerators try to find algorithmic re-factorization such as loop-reordering and loop-tiling. However, the analysis and information they provide are still at very high level and one must further map them onto instructions that hardware can understand. This paper presents “Dijkstra-Through-Time” (DTT), an ahead of time compute and memory scheduling-mapping algorithm for deterministic workloads. It provides a simple implementation and supports accelerators with complex NoC configurations, at the expense of a long compilation process. This initial paper illustrates a proof of concept implementation to merge scheduling and data cache coherence mechanisms to get more optimized data flows.

Index Terms—Machine Learning, Place and route, Accelerator, Tool chain, Data flow optimization

I. INTRODUCTION

In recent years there has been a Cambrian explosion of hardware accelerators particularly related to area of Machine Learning (ML) [1]. One of the driving factors for this is the wide and ever-increasing application domain of machine learning, with each application imposing its unique size, cost, latency, accuracy, and power performance requirements. Additionally, the flexibility to support various or a select class of Neural Network (NN) models together with the ability to efficiently perform training along with inference are considered desirable [2]. Recent works such as nGraph [3], Glow [4] and TVM [5] aim to solve the issue of software compiler support for custom NN accelerators, while tools such as ZigZag [6], MAESTRO [7] and TimeLoop [8] implement complex hardware-aware data flow optimizations.

Most accelerators often rely on a multi-core architecture to perform computations in parallel. In many of these multi-core architectures, data movement follows a design philosophy similar to that of the original Stanford DASH processor [9]. DASH uses a cache coherence protocol that ensures the right copy of a page will always be used in the hardware, even if very little determinism can be assumed from the processing elements (called PEs henceforth).

In practice however, one might notice that the behavior of the PEs is in fact determined by the (known) program they execute. If the code sequence is deterministic (i.e. with no data dependent conditional codes present) one could try to read the programs of the PEs and create an optimized data flow

that guarantees cache coherence without any classic hardware-implemented data consistency protocol.

A precedent for such a data flow can be found in the field of supply chain management which defines Pulled and Pushed flow [10]. In a **pulled flow**, the goods are only produced when ordered by a consumer, which is often preferred in practice because it scales well with uncertainty. On the other hand, in a **pushed flow** goods are produced before they are ordered and stored until purchase. **Pushed flows** create determinism in the supply chain, enabling economies of scale by producing or shipping the goods in bulk.

In the context of NN accelerator design, a typical implementation would be with PEs requesting data explicitly and receiving pages of data to work on i.e. with a **pulled flow**. In this paper, we investigate the **pushed flow**, where the PEs receive the data without explicitly requesting it. The idea stems from the fact that most NN workloads are deterministic in nature without conditional statements. Hence, this determinism can be exploited to pre-schedule workloads across PEs in an efficient way.

In this paper we are presenting “Dijkstra-Through-Time” (DTT) a python-based tool as a proof of feasibility of this idea. As the name indicates, DTT applies Dijkstra’s algorithm on a snapshot of system states taken at every instant. As these are our first results, we present the methodology with some qualitative analysis and leave quantitative comparison with practical NN models as future work.

The rest of the paper is organized as follows: In the first section, we present a high-level intuition of the DTT method, taking the implementation into account. The second section provides examples of using the algorithm to clarify the way DTT works, while in the final section we are going to present what a theoretical architecture leveraging the DTT algorithm would look like.

II. ALGORITHM OVERVIEW

A. Intuition of the Method

Before delving into the details of the DTT algorithm, we explain the logic behind this method on a trivial example described in the Fig. 1. The key idea behind DTT is that a data movement is the action of taking data in one place at some cycle and sending it to another place, where it will arrive at an ulterior cycle. Both the spatial (i.e. where the data is moving)

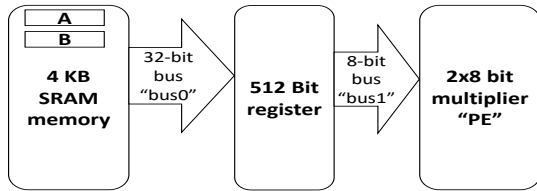

Fig. 1: Trivial memory and PE hardware layout

and temporal (i.e. when the data is moving) components must be taken into account.

Let us consider in Fig. 1 that we are trying to perform a multiplication between two 8 bits operands A and B initially loaded in the SRAM at cycle 0. The interconnect between SRAM and register is 32 bits wide while the one between register and multiplier is 8 bits wide. Both interconnect buses have a latency of 1 clock cycle. The proposed DTT algorithm would reach its solution in two steps. First, it notices that the only way to perform the multiplication is to send the operands A and B to the multiplier and that the first cycle where the required data can actually reach the PE is the cycle 3 (because of the bottleneck of “bus1”). We shall refer to this step in DTT as the **placing step**. Next, we use Dijkstra’s algorithm to find how to send both A and B to the PE at cycle 3. To do this, we are going to find a path on an abstract scheduling graph, shown in Fig. 2. In short, we are using Dijkstra’s algorithm to explore the different schedules and choose the best one where A and B reach the PE at cycle 3. We shall refer to this step as the **routing step** of the DTT method.

Dijkstra’s algorithm must route the operands one by one. The scheduling graph for the data movement of A is shown on the Fig. 2a. The source node is shown in blue, the target node in orange, and the solution of the algorithm in green. Fig. 2b shows the scheduling graph when moving operand B. The link in red indicates that “bus1” is unavailable between the cycle 1 and 2, because it is already carrying the operand A which occupies all the available bandwidth (i.e. 8 bits). In simple terms, the data movement schedule presented in Fig. 2a is

- 1) First move A from SRAM to the register at cycle 0.
- 2) Then move A from the register to the PE at cycle 1.
- 3) Wait inside the PE until cycle 3.

Similarly, for Fig. 2b, the movement of B is

- 1) First move B from SRAM to the register at cycle 0.
- 2) Then let B wait one cycle inside the register (as the 8 bit bus is busy moving A).
- 3) Finally, move B from the register at cycle 2 and reach the PE at cycle 3.

B. Data structures for the Algorithm

In this section, we briefly describe the data structures that were used to implement the DTT algorithm in our proof of concept Python code. The four main classes used for the implementation are the *Datum* class, the *Node* class, the *Wire* class and the *Actor* class.

The *Datum* class is used to represent a single unit of information (eg. a byte) in the algorithm. For instance in Fig. 1, A and B would each be a distinct *Datum*. In terms of code implementation, a *Datum* can be a simple integer.

The *Node* class represents some memory element in the physical hardware and is used to build the scheduling graph. In Fig. 1 “SRAM”, “Reg” and “PE” would be instances of the *Node* class. The *Node* class represents a node in the hardware layout and not a node in the scheduling graph, which contains an additional temporal information, as seen in Fig. 2. The history of the *Node* is implemented with a dictionary which yields for any clock cycle the list of *Datum* present in the *Node*.

The *Wire* class represents a path for data to move in the hardware layout. In the Fig. 1, “bus0” and “bus1” would be *Wire* instances. Note that not all *Wire* instances refer to physical wires. To let a *Datum* wait inside a *Node*, a pseudo waiting *Wire* is drawn, which is simply a *Wire* going from the *Node* to itself. The *Node* and *Wire* classes are used during the routing step of the DTT algorithm.

An *Actor* class is a dedicated class used in during the placing step describing some hardware element which can perform a specific action. For instance in Fig. 1, “PE” is an *Actor* which is able to perform a multiplication. The *Actor* class can also represent more complex hardware as described in section II-C.

C. Placing Algorithm

The purpose of the placing step of DTT is to assign the operations to *Actor* instances such that it shall lead the routing step to find the best solution. But since the routing step is expensive, the placing step must rely on a simpler, less granular representation of the state of the hardware. This is analogous to the place and route algorithm used for FPGAs. Unlike for the routing step, which is done using Dijkstra’s algorithm, there is no single algorithm which can be used for the placing step of DTT. Heuristics can be used to obtain a better placement, which will lead to a better overall scheduling.

In this section, we are going to describe a simple placing algorithm, the *First Best Fit* algorithm. One requirement for this algorithm is to have some *affinity* function, which scores how fit an *Actor* is for some data. One possible *affinity* function would be to count the values in the input data already cached by the *Actor*. The high-level code for this *First Best Fit* placing is provided in Algorithm 1. The exact condition on which an *Actor* becomes busy depends on the context. In this paper we will consider reconfigurable MAC arrays as PEs, which become busy when all their multipliers are in use for one or more dot products. The output of the placing step should be a succession of instructions holding at least 3 pieces of information: **which** list of *Datum* should be sent, **where** they should go (i.e. which *Actor*) and **when** they should arrive.

D. Routing Algorithm

The core step of DTT is the routing algorithm, performed with Dijkstra’s algorithm applied on the scheduling graph. The

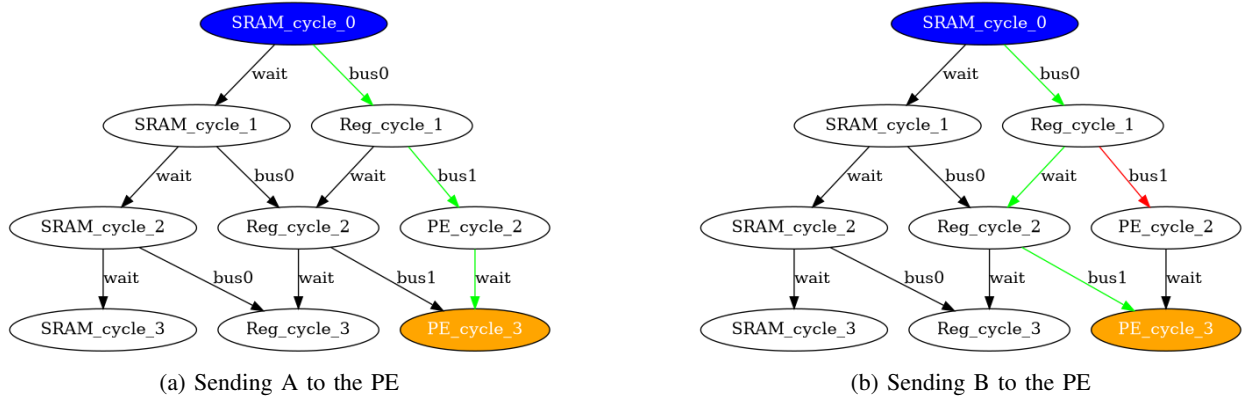

Fig. 2: Scheduling graph for trivial example in Fig. 1

Algorithm 1 First Best Fit placing algorithm

```

for all operations to schedule do
  if any actor is available then
    Take the Actor with highest affinity for the current
    operation.
    Assign the operation to this Actor.
    if the Actor is full then
      Mark the Actor busy for  $X$  cycles.
    end if
  else
    Wait one cycle, the Actors might already be busy.
  end if
end for

```

Algorithm 2 High-level pseudo-code of the routing step

```

for all operations to route do
  Get the target of the path (i.e. the Node + cycle where
  the data is needed).
  for all Datum in the input of the operation do
    Find all the locations (Node + cycle) where the Datum
    is present throughout the history.
    Find path between any of the sources and the target.
    for all Node and cycle in the path do
      Mark in the Node that at the given cycle, it holds
      the involved Datum.
    end for
  end for
  Mark the Wires involved in a similar manner.
end for

```

output of the placing step gives information about what data should move, and the routing step finds how or through what to optimally move the data. The high-level pseudo-code for this routing step is given in Algorithm 2. A part of this routing step is illustrated on the simple example of the Fig. 2. We can see that the operand A goes from “SRAM” at cycle 0 to “Reg” at cycle 1, and from there reaches “PE” at cycle 2, where it remains until cycle 3. As the algorithm 2 states, we would write this information in the associated *Node* and *Wire*

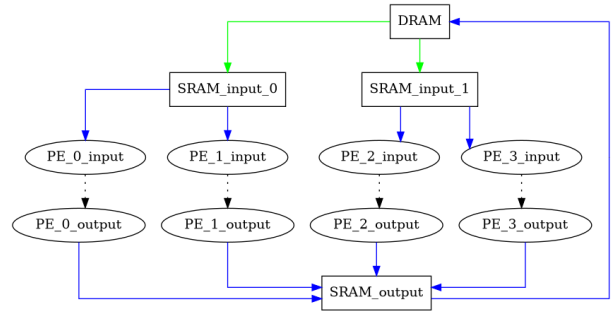

Fig. 3: Simple hardware used for the detailed example

TABLE I: Detailed information about the hardware of Fig. 3

element_name	size	cost	delay
DRAM	512B	0	0
SRAM_*	64B	0	0
PE_*_input	4B	0	0
PE_*_output	2B	0	0
green bus	16B	10	4
blue bus	1B	2	1
wait wire	∞	ϵ	1

instances. Thus, we can deduce that the operand B cannot go through “bus1” at cycle 1 (recall “bus 1” is busy moving A, Fig. 2b).

III. CASE STUDIES

A. Step by Step Example

In this section, we are going to do a step by step run of DTT on a simple reproducible example, which can be used to test a DTT implementation. The hardware we are considering is described in Fig. 3. It contains a global DRAM, two input SRAM, four processing elements and one output SRAM. All the sizes, costs and delays of the elements of the hardware are given in the Table I. The information in Table I is enough to build the scheduling graph for the routing step. The PEs also must be described for the placing step, with a simple black box model provided in Table II. Some of this information was estimated, and there might be more than one way to determine the right values to use. For instance, the Actor cool down, i.e. the delay in cycles that should be left between two successive

TABLE II: Detailed information for the placing step of Fig. 3

Field	Value	Comment
Actor cooldown X	1 cycle	see algorithm 1
multiplication delay	1 cycle	after which the result is ready
distribution latency	8 cycles	estimated time to fetch the operands
memory size	4 bytes	size of the operand buffer
multiplier count	2	inferred from the memory size

TABLE III: Example workload description and its placing result for example of Fig. 3

(a) Workload (b) Result of placing step

Operation	Result	Offset	Cycle	Node	Data
0×1					[0, 1,
$+ 2 \times 3$	100	0	8	PE_0_input	2, 3]
1×2					[1, 2,
$+ 3 \times 4$	101	0	8	PE_1_input	3, 4]
2×3	102	0	8	PE_2_input	[2, 3]
4×5	103	0	8	PE_2_input	[4, 5]
100×101					[100, 101,
$+ 102 \times 103$	104	20	28	PE_0_input	102, 103]

operations, is usually determined through trial and error, as an underestimated value would lead to a timing fault in the routing step.

Before any computation is scheduled, the initial memory content must be described to DTT in order for it to know where each *Datum* can be found. This would be done by arbitrarily adding the *Datum* to the history of the DRAM *Node* (see the section II-B). In this example, we initially load the data numbered 0 to 5 in the DRAM. The workload used for the example is described in Table IIIa, with an offset on the last operation to handle data dependency. Note that we consider dot products for our operations, that is because of the operations which can be sped up in ML computations involve some dot products. Examples of such operations include fully connected layers or convolutional neural networks. Running the placing step for the provided workload yields the Table IIIb. The PEs are assumed to be reconfigurable, hence several different dot products are scheduled together when multipliers are available. Before running the routing step, one must explain to DTT how the output values 100 to 104 will appear in the hardware, here by arbitrarily adding a *Datum* in the history of the appropriate *Node* instances (see the section II-B). This is similar to how *Datum* are loaded in the DRAM during the initialization. Once that has been taken care of, the routing step can be pursued, and its result is provided in Table IV. A deeper look into the Table IV reveals two important strengths of the DTT algorithm. First, DTT will spontaneously optimize the data movements for the operations. For instance, the **red part of the Table IV** shows that the *Datum* 1 was originally sent to the PE_0 for the first dot product, and DTT will fetch it from cache instead of DRAM for the second operation. Similarly, notice **in blue** that DTT will naturally use the *Datum* 100 to 103 to perform the last dot product. DTT treats these values in the same way it treats values coming from the DRAM. If neural network layers are represented as a sequence of dot products, DTT will thus be able to optimize data movement across more than one layer at a time unlike classic for-loop

TABLE IV: Detailed result of the routing step for Fig. 3

<i>Datum</i>	source <i>Node</i>	start cycle	end <i>Node</i>	end cycle
0	DRAM	3	SRAM_input_0	7
0	SRAM_input_0	7	PE_0_input	8
1	DRAM	2	SRAM_input_0	6
1	SRAM_input_0	6	PE_0_input	7
2	DRAM	1	SRAM_input_0	5
2	SRAM_input_0	5	PE_0_input	6
3	DRAM	0	SRAM_input_0	4
3	SRAM_input_0	4	PE_0_input	5
1	SRAM_input_0	7	PE_1_input	8
2	SRAM_input_0	6	PE_1_input	7
3	SRAM_input_0	5	PE_1_input	6
4	DRAM	0	SRAM_input_0	4
4	SRAM_input_0	4	PE_0_input	5
2	DRAM	3	SRAM_input_1	7
2	SRAM_input_1	7	PE_2_input	8
3	DRAM	2	SRAM_input_1	6
3	SRAM_input_1	6	PE_2_input	7
4	DRAM	1	SRAM_input_1	5
4	SRAM_input_1	5	PE_2_input	6
5	DRAM	0	SRAM_input_1	4
5	SRAM_input_1	4	PE_2_input	5
100	PE_0_output	21	SRAM_output	22
100	SRAM_output	22	DRAM	23
100	DRAM	23	SRAM_input_0	27
100	SRAM_input_0	27	PE_0_input	28
101	PE_1_output	20	SRAM_output	21
101	SRAM_output	21	DRAM	22
101	DRAM	22	SRAM_input_0	26
101	SRAM_input_0	26	PE_0_input	27
102	PE_2_output	19	SRAM_output	20
102	SRAM_output	20	DRAM	21
102	DRAM	21	SRAM_input_0	25
102	SRAM_input_0	25	PE_0_input	26
103	PE_2_output	18	SRAM_output	19
103	SRAM_output	19	DRAM	20
103	DRAM	20	SRAM_input_0	24
103	SRAM_input_0	24	PE_0_input	25

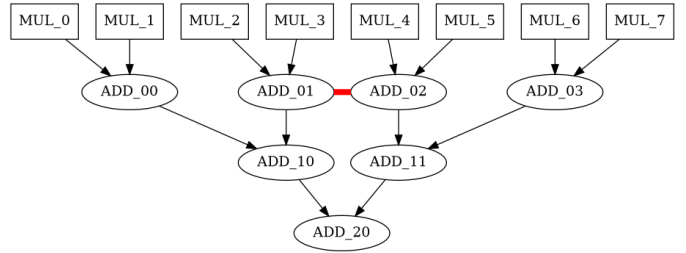

Fig. 4: Example of using DTT for a reduction network

refactoring algorithms. Thus if weights are reused in a NN model, DTT will try to reuse them on chip as far as possible without reloading them from main memory. To enable this, the reused weights must be marked during workload description to DTT.

B. Reduction Network

A reduction network is a set of interconnected adders which will accumulate the result of some multipliers. This is used to compute one or several dot products at the same time. Scheduling reductions with DTT is not immediately obvious, as the algorithm is naturally more suited for distributing values. In practice, one only needs to pretend to distribute

```

# We start by creating a ReductionNetwork object.
reduction_network = ReductionNetwork()
# We add all the nodes involved in the network.
# The multipliers.
for i in range(8):
    reduction_network.node(size=2, name=f"MUL_{i}")
# The first layer of 4 reduction nodes.
for i in range(4):
    reduction_network.node(size=4, name=f"ADD_0{i}")
# The second layer with two nodes.
reduction_network.node(size=4, name=f"ADD_10")
reduction_network.node(size=4, name=f"ADD_11")
# The top-most of the network, where the result would exit from.
reduction_network.outNode(size=4, name=f"ADD_20")

# We add all the wires involved in the reduction network.
# We add the wires between the multipliers and the first layer.
for i in range(8):
    reduction_network.wire(
        source=f"MUL_{i}",
        destination=f"ADD_0{i//2}",
        bandwidth=1,
        cost=2,
        delay=1,
    )
# We add the connections from the first layer to the second one.
for i in range(4):
    reduction_network.wire(
        source=f"ADD_0{i}",
        destination=f"ADD_1{i//2}",
        bandwidth=1,
        cost=2,
        delay=1,
    )
# We add the connections from the second layer to the output.
reduction_network.wire(
    source="ADD_10", destination="ADD_20", bandwidth=1, cost=2, delay=1
)
reduction_network.wire(
    source="ADD_11", destination="ADD_20", bandwidth=1, cost=2, delay=1
)
# If requested by the user, we add a MAERI style interconnect.
if maery_style:
    # Here we assume the bidirectional connection is made of two wires,
    # other models are possible.
    reduction_network.wire(
        source="ADD_01", destination="ADD_02", bandwidth=1, cost=2, delay=1
    )
    reduction_network.wire(
        source="ADD_02", destination="ADD_01", bandwidth=1, cost=2, delay=1
    )
# We return the prepared network.
return reduction_network

```

Fig. 5: DTT code for the reduction network of Fig. 4

the results to the multipliers and play the computed data flow backwards to schedule a reduction. This is because the addition and data reuse operation have an opposite data flow.

Most reduction networks take the form of a binary tree where the leaves are multipliers and the nodes are adders. One limitation of such a reduction network is that performing more than one dot product at a time on the network will lead to a lot of blocking. To improve on this design, the paper [11] proposed the “augmented reduction tree” recreated in Fig. 4, which is a binary tree with an additional connection between ADD_01 and ADD_02. Hypothetically, a hardware designer would want to benchmark the accelerator with and without the “augmented connection” to see if its benefits over weigh its costs. DTT can be used to create a prototyping back end for this purpose, which can be simply modified to compare the two reduction trees: simply remove from the description of the hardware graph the *Wire* between the *Node* instances ADD_01 and ADD_02 to benchmark the simple reduction tree, as shown in Fig. 5.

Some information that designers might find interesting and

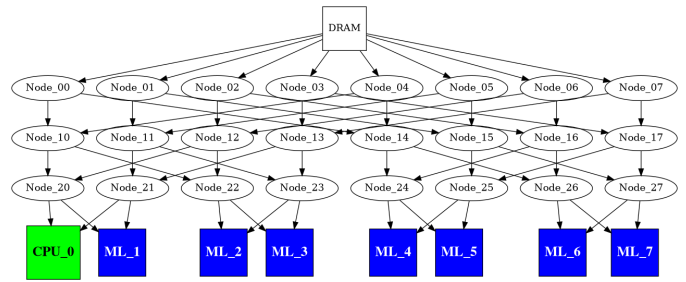

Fig. 6: Example of complex hardware covered by DTT

Algorithm 3 Placing Algorithm tuned for Fig. 6

```

for all operations to schedule do
    Filter the Actors which can perform the operation
    Use First Best Fit to place the operation among those
    valid Actors
end for

```

can be easily extracted from DTT are:

- 1) The **energy savings** for a given workload with the augmented connection,
- 2) The **runtime difference** between the normal and augmented reduction trees,
- 3) The **utilization rate** of the augmented connection in the workload,

These low-level statistics would then be used to decide whether an augmented reduction tree or a simple reduction tree should be included in the designed hardware.

C. Working with complex Hardware

For the last example, we are going to explain how a more complex hardware can be handled by DTT. This is meant to show the flexibility of the algorithm in more interesting cases. The hardware for this example is shown in Fig. 6. It uses a butterfly-style distribution network to send data from a global DRAM to several high-level components. In this design, seven ML accelerators are used (in blue along with a general-purpose processor (in green on the Fig 6). The idea here is that the NN model is made of several types of operations. Let us assume that only dot products, matrix multiplications and custom functions are used here. The dot products and matrix multiplications can be carried out by either the CPU or an accelerator, but an accelerator would be faster and more efficient. The rare custom functions however may only be performed out by the CPU. We are going to modify the placing step described in Algorithm 1. Since not every PE can carry out every operations, we first have to filter for the provided operation code the **Actors** which are relevant for the computation. The new placing step is presented in 3. The routing step however would remain unchanged. This may come as a surprise, since several different operations are involved, but as mentioned before the only information considered for the routing step are: **what** data should be moved, **where** is it going to and **when** should it arrive. For as far as the routing algorithm is concerned, moving data for

a dot product is no different than moving it for a custom computation. This also implies that DTT will spontaneously optimize data movements across different operations.

When benchmarking such hardware, a new issue might arise: the upstream DSE tool used probably does not understand what a butterfly network is. One would provide a simpler hardware description to optimize the workload for, and then take the optimized neural network and use DTT to schedule it for the complex hardware. For instance, the hardware of Fig. 6 could be described as Fig. 7 to a tool such as ZigZag or Timeloop. Although giving an inaccurate description of the

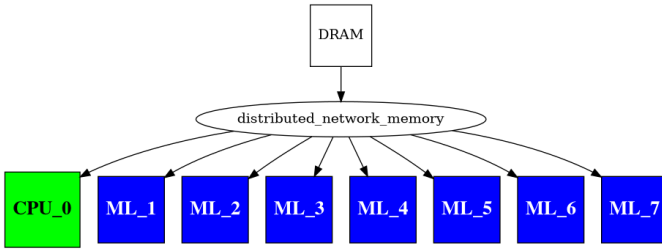

Fig. 7: Simpler description of Fig. 6 for higher level tools

accelerator to the DSE tool could mean that its solution will be sub-optimal, it should still give a much better starting point for DTT.

IV. DTT-BASED NOC

In this last part, we are going to present and end to end theoretical architecture that would take advantage of the DTT algorithm to optimize data movements in its NoC. In this architecture, the *Datum* considered will thus be entire memory pages.

A. Compiler overview

The compiler for the architecture would take as input a single threaded stream of operations to execute on the hardware. Its first task is to multi-thread those tasks between the various PEs in the architecture by running the placing step of the DTT algorithm. This approach is reminiscent of VLIW compilers [12], except that VLIW compilers also have to deal with runtime branches, while those do not appear in DTT's deterministic workloads. As explained in section III-C, this placing step can accommodate heterogeneous PEs.

Once the placing step of DTT is over, the compiler knows when each operation should be performed and where they should take place. The routing step is used to decide how to send the data to the PEs so that they will be able to start their computations on time. The order in which data movement will happen in the NoC is:

- 1) The controller asks a source *Node* to send a page to another PE
- 2) The data movement takes place and the PE receives the page
- 3) The controller sends the instruction to the PE and the computation starts

Because data arrives before the PEs start their operations, the PEs will never cache miss. In practice though, DTT has two weaknesses which prevent us from using it directly:

- The routing step is too expensive to be performed on an edge device,
- The output of the routing step (a list of data movements) is too big to be reasonably sent to an edge device.

Fortunately, there is a known solution to those issues, which is inspired by macro-routing [13]. The idea is to provide DTT with checkpoints that it can use to forget what came before. Hence, once the compiler is done performing the routing step, it only saves way-points (i.e. a few specific points the path has to traverse in order) from the paths instead of the whole path. Those way-points will be placed by the compiler into a binary file along with the scheduled operations for the accelerator.

B. DTT controller

Because we rely on DTT, the PEs used in our theoretical architecture do not use a distributed cache coherence protocol, but instead a global hardware controller connected to the NoC. This controller is here intended to be a small CPU core, although dedicated hardware might also be used. This controller has three main responsibilities:

- 1) It reads the input program for the accelerator
- 2) It reconstructs the paths for the data movements from the way-points
- 3) It sends control packets to the PEs in order to have them realize the data movements it computed

The way points computed by the compiler and saved into the program file are sent to the hardware controller, which will run Dijkstra's algorithm again to fill in the missing movements between the way-points at run-time. This technique could be seen as analogous to compressing a video to only its key-frames, then filling the intermediary frames via interpolation [14]. After the reconstruction of paths from the DTT algorithm, each data movement has to be turned into a control packet that will be sent by the controller to the relevant PEs.

The control packets would be sent over the NoC using dynamic routing protocols (as opposed to a fixed route decided by the controller) and should have plenty of time to reach their targets before the data movement needs to be carried out. To be sure that the control packets are consumed at the right time, a simple TTL (Time-toLive) mechanism could be used. Once the control packets are consumed, they will trigger a 2-way DMA access, sending the data from the source to the target (without going through the controller) and following the route decided by DTT. This ensures no unexpected congestions will appear in the NoC, as all the data movements have been foreseen by the controller.

C. Comparison with directory-based protocol

One significant asset of using DTT, compared to other coherent networking approaches, is its ability to optimize the data movements. Two possible traffic optimizations with DTT are shown in Fig. 8. During the routing step, DTT will

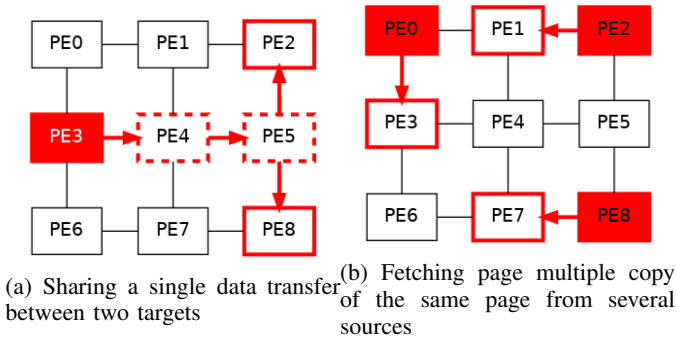

Fig. 8: Illustration of possible data-movement optimizations in DTT

TABLE V: Comparison of DTT with classic coherence protocols

Protocol	Bus-snooping	DTT	Full-directory
Bottleneck	Bus bandwidth	Controller compute	Node distance
Best for	Small NoC	Medium NoC	Large NoC
Determinism	No	Required	No

use Dijkstra’s algorithm to find the shortest way to bring the required data to the PEs for the operations, leading to an expected improvement in the overall performance of the accelerator. This works because the cache coherence is ensured by one omniscient actor, hence finding correct optimizations becomes much easier.

The controller used in the theoretical architecture creates a bottleneck for the execution, as every operation needs to be processed by the controller before being executed in the chosen PE. Thus, a DTT based architecture is expected to not scale as well as a directory-based architecture, which is summarized in Table V.

V. CONCLUSION

In this paper we presented DTT, a low complexity ahead of time hardware scheduling method. We explained how the algorithm works and detailed important parts of its implementation. Several examples were shown to show how DTT can handle reconfigurable and custom hardware. Finally, we highlighted that DTT opens new opportunities for hardware designers by enabling them to quickly draft prototyping back ends. As mentioned at the beginning of the paper, DTT is currently a proof of concept. As future improvement we would like to show its usage with an application on a real ML workload.

REFERENCES

- [1] A. Reuther, P. Michaleas, M. Jones, V. Gadepally, S. Samsi, and J. Kepner, “Survey and benchmarking of machine learning accelerators,” in *IEEE High Performance Extreme Computing Conference*, 2019.
- [2] V. Sze, Y.-H. Chen, T.-J. Yang, and J. S. Emer, *Efficient Processing of Deep Neural Networks*. Morgan & Claypool Publishers, 2020.
- [3] S. Cyphers, A. K. Bansal, A. Bhiwandiwala, J. Bobba, M. Brookhart, A. Chakraborty, W. Constable, C. Convey, L. Cook, O. Kanawi, R. Kimball, J. Knight, N. Korovaiko, V. K. Vijay, Y. Lao, C. R. Lishka, J. Menon, J. Myers, S. A. Narayana, A. Procter, and T. J. Webb, “Intel nGraph: An Intermediate Representation, Compiler, and Executor for Deep Learning,” 2018. [Online]. Available: <http://arxiv.org/abs/1801.08058>

- [4] N. Rotem, J. Fix, S. Abdulrasool, S. Deng, R. Dzhabarov, J. Hegeman, R. Levenstein, B. Maher, N. Satish, J. Olesen, J. Park, A. Rakhov, and M. Smelyanskiy, “Glow: Graph lowering compiler techniques for neural networks,” 2018. [Online]. Available: <http://arxiv.org/abs/1805.00907>
- [5] T. Chen, T. Moreau, Z. Jiang, L. Zheng, E. Q. Yan, H. Shen, M. Cowan, L. Wang, Y. Hu, L. Ceze, C. Guestrin, and A. Krishnamurthy, “TVM: an automated end-to-end optimizing compiler for deep learning,” in *USENIX Symposium on Operating Systems Design and Implementation*, 2018.
- [6] L. Mei, P. Houshmand, V. Jain, J. S. P. Giraldo, and M. Verhelst, “Zigzag: A memory-centric rapid DNN accelerator design space exploration framework,” 2020. [Online]. Available: <https://arxiv.org/abs/2007.11360>
- [7] H. Kwon, P. Chatarasi, V. Sarkar, T. Krishna, M. Pellauer, and A. Parashar, “MAESTRO: A Data-Centric Approach to Understand Reuse, Performance, and Hardware Cost of DNN Mappings,” *IEEE Micro*, 2020.
- [8] A. Parashar, P. Raina, Y. S. Shao, Y. Chen, V. A. Ying, A. Mukkara, R. Venkatesan, B. Khailany, S. W. Keckler, and J. Emer, “Timeloop: A systematic approach to dnn accelerator evaluation,” in *IEEE International Symposium on Performance Analysis of Systems and Software*, 2019.
- [9] D. Lenoski, J. Laudon, K. Gharachorloo, W. . Weber, A. Gupta, J. Hennessy, M. Horowitz, and M. S. Lam, “The stanford dash multiprocessor,” *Computer*, vol. 25, no. 3, pp. 63–79, 1992.
- [10] D. Pyke and M. Cohen, “Push and pull in manufacturing and distribution systems,” *Journal of Operations Management*, vol. 9, p. 24–43, 01 1990.
- [11] H. Kwon, A. Samajdar, and T. Krishna, “MAERI: Enabling Flexible Dataflow Mapping over DNN Accelerators via Reconfigurable Interconnects,” in *Architectural Support for Programming Languages and Operating Systems*, 2018.
- [12] S. Jee and K. Palaniappan, “Dynamically scheduling vliw instructions with dependency information,” 02 2002, pp. 15 – 23.
- [13] S. Dragos and M. Collier, “Macro-routing: a new hierarchical routing protocol,” in *IEEE Global Telecommunications Conference*, 2004.
- [14] C.-Y. Wu, N. Singhal, and P. Krähenbühl, “Video compression through image interpolation,” 2018. [Online]. Available: <https://arxiv.org/abs/1804.06919>