

SPANNING HYPERTREES, VERTEX TOURS AND MEANDERS

ROBERT CORI AND GÁBOR HETYEI

À la mémoire de Pierre Rosenstiehl

ABSTRACT. This paper revisits the notion of a spanning hypertree of a hypermap introduced by one of its authors and shows that it allows to shed new light on a very diverse set of recent results.

The tour of a map along one of its spanning trees used by Bernardi may be generalized to hypermaps and we show that it is equivalent to a dual tour described by Cori [5] and Machì [23]. We give a bijection between the spanning hypertrees of the reciprocal of the plane graph with 2 vertices and n parallel edges and the meanders of order n and a bijection of the same kind between semimeanders of order n and spanning hypertrees of the reciprocal of a plane graph with a single vertex and $n/2$ nested edges. We introduce hyperdeletions and hypercontractions in a hypermap which allow to count the spanning hypertrees of a hypermap recursively, and create a link with the computation of the Tutte polynomial of a graph. Having a particular interest in hypermaps which are reciprocals of maps, we generalize the reduction map introduced by Franz and Earnshaw to enumerate meanders to a reduction map that allows the enumeration of the spanning hypertrees of such hypermaps.

INTRODUCTION

This paper is about *hypermaps*, a notion that has interested several researchers in combinatorics. This notion generalizes that of a *combinatorial map* (sometimes also called a *ribbon graph*), which represents the embedding of a graph into an orientable surface with a pair of a permutation and of a fixed point free involution. The same way hypergraphs generalize graphs by introducing hyperedges incident to more than two vertices, hypermaps generalize maps by replacing the involution with a permutation that has cycles of arbitrary length. Hence one may interpret a hypermap as an embedding of a hypergraph into an orientable surface. The main goal of this paper is to return to the notion of a *spanning hypertree* of a hypermap introduced by Cori, Penaud [5, 7] and Machì [23] with the purpose of showing that several recent results on various combinatorial objects may be enlightened by interpreting them in terms of spanning hypertrees of certain families of hypermaps. These results concern apparently very distant areas such as the tour of a graph with the purpose of computing its Tutte polynomial [1] or the determination of the number of meanders and semimeanders. The main results of this paper are the following:

Date: June 30, 2022.

2010 Mathematics Subject Classification. Primary 05C30; Secondary 05C10, 05C15.

Key words and phrases. set partitions, noncrossing partitions, genus of a hypermap.

- Theorem 3.12 and its Corollary 3.14 which generalizes the “motion function” used by Bernardi [1] to hypermaps and provides a simple treatment in this more general setting.
- Theorems 4.7 and 4.9 characterizing the process of deletions and contractions in a hypermap which allow to obtain all spanning hypertrees of a hypermap. These use a result of Goulden and Young [14, Theorem 2.2] on a minimal decomposition of a permutation into a product of transpositions.
- Theorem 5.4 which gives a formula counting the number of spanning hypertrees of a hypermap in terms of the spanning hypertrees of a set of hypermaps obtained by deletions of contractions from the original hypermap.
- Theorems 6.2 and 6.4 which provide bijections between the spanning hypertrees of the reciprocal hypermaps of a plane graph with 2 vertices and n edges and meanders of order n , respectively bijections of the same type between semimeanders and plane maps with one vertex and $n/2$ parallel loops.
- Theorem 7.5 and its Corollary 7.6 which generalize a result of Franz on meanders to hypermaps that are reciprocals of maps.

Our paper is divided into seven sections, discussing the above mentioned questions.

In the preliminary Section 1 we remind the reader of the definition of a hypermap as a pair of permutations, one representing the vertices the other one the hyperedges, the faces may then be expressed by a composition of these permutations and one may define the genus by counting cycles. We also define some simple transforms of hypermaps, such as the reciprocal (obtained by exchanging the vertices and the hyperedges) and the dual (obtained by exchanging the vertices and the faces). The central notion of a spanning hypertree is then introduced. It relies on an order on the permutations based on their cycle decompositions. Section 2 recalls a result obtained by Machì [23], generalizing the result of Cori [5] and Cori and Penaud [7] showing the connection between the spanning hypertrees and various other parameters of the pairs of permutations. In Section 3 we introduce the hyperdeletion and hypercontraction operations for hypermaps, each of these multiply the constituting permutations by a single transposition. These operations generalize the well-known deletion and contraction operations on graphs and combinatorial maps. Finding a spanning hypertree amounts to a sequence of operations based on writing permutations as products of transpositions. Using a dual description of face tours and vertex tours, we show that every hypermap has a *two-disk diagram* where vertices form a noncrossing partition inside a vertex tour, faces form another noncrossing partition inside the face tour. Drawing a diagram of a hypermap thus corresponds to drawing a bipole (a hypermap with two vertices) on a surface of the same genus as that of a hypermap, and then adding some detail in a noncrossing fashion inside the two vertices, representing the face tour and the vertex tour, respectively. The sequence of operations introduced in Section 3 is described in detail in Section 4 which opens a pathway to the construction of a Tutte polynomial. Based on the results in Section 4 there would be several ways to define a Tutte polynomial. We did not commit to any specific choice, because any such definition would depend on the ordering of the hyperedges, unfortunately. It should be noted that there is a hypergraph Tutte polynomial defined by Bernardi, Kálmán and Postnikov [3, Formula (2)] which is independent of the ordering of the hyperedges and relies on labeling bases in

a (poly)matroid (see also [16, 17, 18] for related constructions). It is unclear, however, whether this approach could be extended to hypermaps, and it should be noted that in the Bernardi-Kálmán-Postnikov construction some elements in the ground set need to be considered simultaneously externally and internally active, which hints at more complex relation with deletion-contraction processes. Section 5 provides a recursive formula for the number of spanning hypertrees in terms of certain hypermaps obtained by hyperdeletions and hypercontractions. Our formula uses the same decomposition of the noncrossing partition lattice as the one used by Simion and Ullman [26, Theorem 2] as an aid to recursively construct a symmetric chain decomposition of the noncrossing partition lattice. Section 6 is dedicated to semimeanders and meanders, whose enumeration is the interest of many authors, among whom Rosenstiehl was a first [25]. We show that their enumeration may be reduced to counting the spanning hypertrees of particular hypermaps: reciprocals of monopolar, respectively bipolar maps with noncrossing parallel edges. This study, together with the observation that besides duality taking the reciprocal of a hypermap is part of the hypermap analogue of Tutte's trinity, makes one think that reciprocals of maps must have special properties. This leads to Section 7 where we generalize the work of Franz [11, 12], and we develop a labeled tree representation of the spanning hypertrees of the reciprocal of a map. In particular, we show that the set of these spanning hypertrees is bijectively equivalent to all trees that can be obtained from the map by a sequence of topological vertex splittings. This observation allows us to generalize the idea of Franz and Earnshaw [13] of a constructive enumeration of meanders to an idea of a constructive enumeration of all spanning hypertrees of the reciprocal of a map.

1. PRELIMINARIES

1.1. Hypermaps and hypertrees. Informally, a *hypermap* is a hypergraph, topologically embedded in a surface. Formally, it is a pair of permutations (σ, α) acting on the same finite set of labels, generating a transitive permutation group. Fig. 1 represents the planar hypermap (σ, α) for $\sigma = (1, 2, 3)(4, 5, 6)(7, 8, 9, 10)(11, 12)$ and $\alpha = (1, 6)(2, 11, 9, 5)(3, 7)(4, 10)(8, 12)$. The cycles of σ are the *vertices* of the hypermap, the cycles of α are its *hyperedges*. A hypermap is a *map* if the length of each cycle in α is at most 2.

For planar hypermaps it is convenient to choose some drawing conventions. In Fig. 1 we follow the following rules: the cycles of σ list the exits in counterclockwise order, and we place the labels on the left hand side of each exit (seen from the vertex). Following these conventions, the cycles of $\alpha^{-1}\sigma = (1, 5)(2, 7, 12)(3, 6, 10)(4, 9)(8, 11)$ label the regions in the plane, created by the vertices and hyperedges, and we call the cycles of the permutation $\alpha^{-1}\sigma$ the *faces* of the hypermap. Note that *we multiply permutations from the right to the left*, in other words we compose them as functions. One of our main sources, Machì [23], multiplies permutations from the left to the right, and when he defines the faces as the cycles of $\alpha^{-1}\sigma$, these are the cycles of $\sigma\alpha^{-1}$ in our notation. When following Machì's convention, it is more convenient to place the labels on the right of each exit, thus the cycles of $\sigma\alpha^{-1}$ label the regions created by the vertices and hyperedges.

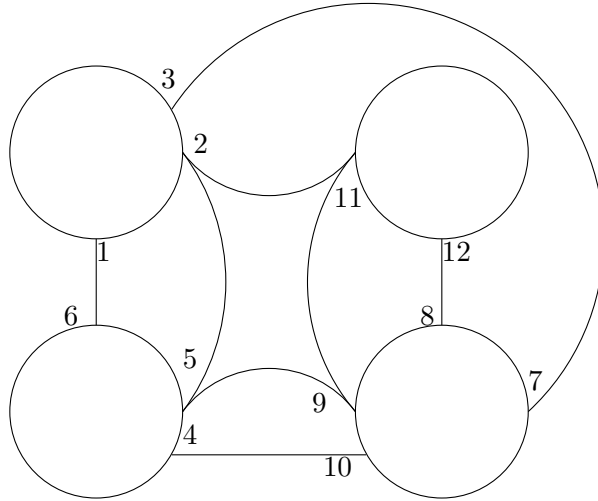
FIGURE 1. The hypermap (σ, α)

There is a well-known formula, due to Jacques [15] determining the smallest genus $g(\sigma, \alpha)$ of a surface on which a hypermap (σ, α) may be drawn. This number is given by the equation

$$n + 2 - 2g(\sigma, \alpha) = z(\sigma) + z(\alpha) + z(\alpha^{-1}\sigma), \quad (1.1)$$

where $z(\pi)$ denotes the number of cycles of the permutation π and n is the number of permuted elements. The number $g(\sigma, \alpha)$ is always an integer and it is called *the genus of the hypermap* (σ, α) . In our example, $n = 12$, $z(\sigma) = 4$, $z(\alpha) = 5$, $z(\alpha^{-1}\sigma) = 5$ and Equation (1.1) gives $g(\sigma, \alpha) = 0$, that is, we have a planar hypermap.

A key notion of this paper is the *spanning hypertree of a hypermap*, first introduced for planar hypermaps in [5] and generalized to hypermaps of arbitrary genus in [23]. A hypermap (σ, α) is a *unicellular hypermap* if it has only one face. We call a unicellular hypermap a *hypertree* if its genus is zero. Note that Machì [23] uses the term hypertree even for unicellular hypermaps of a higher genus. At this point our terminology is in line with the widely used term *unicellular map* which is a map with only one face. A permutation θ is a *refinement* of a permutation γ , if there exists a pair of decompositions $\gamma = \gamma_1 \cdots \gamma_t$ and $\theta = \theta_1 \cdots \theta_t$ such that the γ_i s are pairwise disjoint cycles of γ , the θ_i s are products of disjoint cycles of θ , for each i the permutations γ_i and θ_i act on the same set of elements, and they satisfy $g(\theta_i, \gamma_i) = 0$. It has been shown in [4, Theorem 1] that for a circular permutation σ (that is, a permutation with a single cycle) and an arbitrary permutation α , acting on the same set of elements, the condition $g(\sigma, \alpha) = 0$ is equivalent to requiring that the cycles of α list the elements of a *noncrossing partition* according to the circular order determined by σ . Hence the definition of a refinement may be equivalently restated by requiring that, starting with the decomposition $\gamma = \gamma_1 \cdots \gamma_t$ of γ into pairwise disjoint cycles, we replace each cycle with a permutation θ_i whose cycles represent a noncrossing partition of the points moved by γ_i , with respect to the circular order represented by γ_i . The following is an immediate consequence of the definition of a refinement.

Corollary 1.1. *Let γ and θ be permutations of the same set. Then θ is a refinement of γ if and only if θ^{-1} is a refinement of γ^{-1} .*

Furthermore, refinements can be characterized as follows.

Proposition 1.2. *Let θ and γ be permutations of an n -element set. The permutation θ is a refinement of γ if and only if the two following conditions are satisfied:*

- (1) *For any i , the two elements i and $\theta(i)$ are in the same cycle of γ .*
- (2) *$z(\theta^{-1}\gamma) + z(\theta) = n + z(\gamma)$ holds.*

Proof. The first condition is equivalent to stating that each for each cycle of γ there is a product of cycles of θ acting on the same set. Introducing n_i as the cycle length of γ_i , the condition $g(\theta_i, \gamma_i) = 0$ is equivalent to

$$0 = n_i + 2 - z(\gamma_i) - z(\theta_i) - z(\gamma_i^{-1}\theta_i).$$

The second condition may be obtained by adding all equations of the above form, keeping in mind that the number of equations to be added is $z(\gamma)$. Conversely, the second condition implies that all $g(\theta_i, \gamma_i) = 0$ as the genus of any hypermap is nonnegative. \square

Corollary 1.3. *If γ and θ are permutations of the same n -element set then θ is a refinement of γ if and only if the same holds for $\theta^{-1}\gamma$.*

Notice that since the pairs γ_i, θ_i define *monopoles* (that is, hypermaps with a single vertex) of genus 0, for a given γ_i the number of θ_i which are a refinements of γ_i is the Catalan number C_{n_i} , where n_i is the number of elements of the cycle γ_i . Thus we obtain the following.

Proposition 1.4. *Let γ be a permutation whose cycles are of length n_1, n_2, \dots, n_k , respectively. Then the number of refinements of γ is $\prod_{i=1}^k C_{n_i}$.*

A hypermap (σ, α') *spans* the hypermap (σ, α) if α' is a refinement of α . Note that not all refinements α' of α have the property that (σ, α') is a hypermap. The *complexity* of a hypermap of genus g is the number of unicellular hypermaps of genus g spanning it.

Using Proposition 1.2 we may establish a bijection between the spanning genus k unicellular hypermaps of a hypermap (σ, α) and the spanning genus $(g(\sigma, \alpha) - k)$ unicellular hypermaps of its *dual* $(\alpha^{-1}\sigma, \alpha^{-1})$ for $k = 0, 1, \dots, g(\sigma, \alpha)$ as follows.

Theorem 1.5. *Let (σ, α) be a hypermap and let θ be a permutation of the same set of points. Then (σ, θ) is a spanning unicellular hypermap of (σ, α) if and only if $(\alpha^{-1}\sigma, \alpha^{-1}\theta)$ is a spanning unicellular hypermap of the dual hypermap $(\alpha^{-1}\sigma, \alpha^{-1})$. Furthermore, if the above are satisfied we have*

$$g(\sigma, \theta) + g(\alpha^{-1}\sigma, \alpha^{-1}\theta) = g(\sigma, \alpha).$$

Proof. By Corollary 1.3, θ is a refinement of α if and only if $\theta^{-1}\alpha$ is a refinement of α . By Corollary 1.1, $\theta^{-1}\alpha$ is a refinement of α if and only if $\alpha^{-1}\theta$ is a refinement of α^{-1} . Observe furthermore that the face permutation of $(\alpha^{-1}\sigma, \alpha^{-1}\theta)$ is

$$(\alpha^{-1}\theta)^{-1}\alpha^{-1}\sigma = \theta^{-1}\alpha\alpha^{-1}\sigma = \theta^{-1}\sigma.$$

Combining the above observations we obtain that (σ, θ) is a spanning unicellular hypermap of (σ, α) if and only if $(\alpha^{-1}\sigma, \alpha^{-1}\theta)$ is a spanning unicellular hypermap of $(\alpha^{-1}\sigma, \alpha^{-1})$.

Finally, the stated equation connecting the genres holds because of (1.1) and the second statement in Proposition 1.2. Indeed, (1.1) yields

$$\begin{aligned} g(\sigma, \theta) &= \frac{1}{2} \cdot (n + 2 - z(\sigma) - z(\theta) - z(\theta^{-1}\sigma)) \\ g(\alpha^{-1}\sigma, \alpha^{-1}\theta) &= \frac{1}{2} \cdot (n + 2 - z(\alpha^{-1}\sigma) - z(\alpha^{-1}\theta) - z(\theta^{-1}\sigma)) \quad \text{and} \\ -g(\sigma, \alpha) &= \frac{1}{2} \cdot (-n - 2 + z(\sigma) + z(\alpha) + z(\alpha^{-1}\sigma)). \end{aligned}$$

Using $z(\theta^{-1}\sigma) = 1$ we obtain

$$g(\sigma, \theta) + g(\sigma\alpha^{-1}, \theta\alpha^{-1}) - g(\sigma, \alpha) = \frac{1}{2} \cdot (n - z(\theta) - z(\alpha^{-1}\theta) + z(\alpha)).$$

We may replace $z(\alpha^{-1}\theta)$ with $z((\alpha^{-1}\theta)^{-1}) = z(\theta^{-1}\alpha)$ on the right hand side of the last equation, which is then is zero by the second statement in Proposition 1.2. \square

Note that the drawing conventions stated for planar hypermaps above may be easily generalized to hypermaps drawn on an oriented surface of a fixed genus. As noted earlier, in such a setting, the definition of a refinement θ of γ requires to replace each cycle γ_i of γ by a noncrossing partition in which the parts respect the cyclic order of γ_i . Furthermore, a permutation θ' refines the permutation θ further exactly when each cycle of θ' is contained in a cycle γ_i of γ , and the restriction of θ' onto the set of elements permuted by γ_i is a noncrossing partition, which is a refinement of the noncrossing partition associated to the action of θ on the elements permuted by γ_i . For noncrossing partitions we use the term refinement in the same sense as Kreweras [19], who has shown that noncrossing partitions form a lattice under refinement.

The key result we use depends on the notion of the *hyperdual* of a hypermap, introduced in [7]. The *dual* of the hypermap (σ, α) is the hypermap $(\alpha^{-1}\sigma, \alpha^{-1})$, this notion of duality generalizes the usual duality of planar graphs, exchanging vertices and faces. The *reciprocal* of the hypermap (σ, α) is the hypermap (α, σ) . Taking the reciprocal generalizes taking the line graph of a graph. Repeated use of taking the dual and the reciprocal yields the following commutative diagram, which itself is a generalization of Tutte's "trinity" [28] from graphs to hypermaps:

$$\begin{array}{ccccc} & & (\alpha, \sigma) & \xrightarrow{d} & (\sigma^{-1}\alpha, \sigma^{-1}) & & \\ & \nearrow r & & & & \searrow r & \\ (\sigma, \alpha) & & & & & & (\sigma^{-1}, \sigma^{-1}\alpha) \\ & \searrow d & & & & \nearrow d & \\ & & (\alpha^{-1}\sigma, \alpha^{-1}) & \xrightarrow{r} & (\alpha^{-1}, \alpha^{-1}\sigma) & & \end{array}$$

All hypermaps in the hexagonal diagram above have the same genus. Diagonally opposite to (σ, α) we find the *hyperdual* of (σ, α) , defined as $(\sigma^{-1}, \sigma^{-1}\alpha)$. Note that taking the hyperdual is also an involution. Besides the hypermaps shown in the above

hexagonal diagram, sometimes we will also consider the *mirrored hypermap* $(\sigma^{-1}, \alpha^{-1})$ and the *Kreweras dual* $(\sigma, \alpha^{-1}\sigma)$ of the hypermap (σ, α) . The proof of the fact that the mirrored hypermap $(\sigma^{-1}, \alpha^{-1})$ has the same genus as (σ, α) is left to the reader. The Kreweras dual of a noncrossing partition (that is, a genus zero monopole) was introduced in [19]. The Kreweras dual of a hypermap (σ, α) is obtained from its hyperdual $(\sigma^{-1}, \sigma^{-1}\alpha)$, by taking its mirrored hypermap.

1.2. Meanders, semimeanders, and stamp folding. Meanders and semimeanders have a vast literature, here we use the terminology introduced in [10]. A *meander* of order n is a closed, self-avoiding loop, crossing a straight line at $2n$ points. We can visualize a meander as a closed, self-avoiding walk in the plane crossing a river at $2n$ bridges. If we number the crossings on the straight line left to right, and then list the crossings in the order in which the meander encounters them, we obtain a *meandric permutation*. As pointed out by M. LaCroix [20], before the modern theory of enumerating meanders was developed, Rosenstiehl has studied these permutations under the name of *planar permutations* [25].

A *semimeander* is a closed, self-avoiding walk that crosses a half-line at n points. As it is stated in [10], the number of semimeanders of order n is the same as the number of *foldings* $n - 1$ *stamps* [22, 27]. We will use the following equivalent definition of stamp foldings.

Definition 1.6. *A folding of $n - 1$ stamps is a permutation $\underline{\pi} = (\pi(1), \dots, \pi(n))$ of the set $\{1, 2, \dots, n\}$, written as an ordered list, satisfying the following conditions.*

- (1) $\pi(1) = 1$.
- (2) *The list $\underline{\pi}$ does not contain any sublist of the form $(2i, 2j, 2i + 1, 2j + 1)$.*
- (3) *The list $\underline{\pi}$ does not contain any sublist of the form $(2i - 1, 2j - 1, 2i, 2j)$.*

Arch diagrams representing stamp foldings are shown in the right half of Figures 11 and 12 in Section 6. In both diagrams we see an ordered list beginning with 1. Each even label $2i$ is connected to the label $2i + 1$ by an upright arch (if $2i + 1$ exists as a label), and each odd label $2i - 1$ is connected to the label $2i$ by an upside-down arch (if $2i$ exists as a label). Conditions (2) and (3) are equivalent to stating that the resulting set of arcs does not cross.

2. A CONSEQUENCE OF MACHÌ'S RESULT AND ITS INTERPRETATION

The starting point of our present investigation is the following result of Machì [23], generalizing a result of Cori [5, 7].

Theorem 2.1. *Given a hypermap (σ, α) , there is a bijection between the genus g unicellular hypermaps θ spanning its hyperdual $(\sigma^{-1}, \sigma^{-1}\alpha)$, and the set $C_\sigma(\sigma, \alpha)$, defined as the set of circular permutations ζ satisfying $g(\sigma, \zeta) = g(\sigma, \alpha)$ and $g(\alpha, \zeta) = 0$. The bijection is given by the rule $\theta \mapsto \zeta = \sigma\theta$.*

Proof. Although the above statement appears to be identical to Machì's result, we need to check it is still valid, even though we multiply permutations right to left, whereas he multiplies them left to right.

We begin with translating Machi's result into right to left multiplication form: given a hypermap (σ, α) , there is a bijection between the spanning genus g unicellular hypermaps θ' of the hypermap $(\sigma^{-1}, \alpha\sigma^{-1})$, and the set $C_\sigma(\sigma, \alpha)$, defined as the set of circular permutations ζ satisfying $g(\sigma, \zeta) = g(\sigma, \alpha)$ and $g(\alpha, \zeta) = 0$. The bijection is given by the rule $\theta' \mapsto \zeta = \theta'\sigma$. Note that the definition of $C_\sigma(\sigma, \alpha)$ remains unchanged, as the definition of the genus depends only on counting cycles in a way that is independent of the direction of the multiplication, as a consequence of the identity

$$z(\alpha\beta) = z(\beta\alpha) \quad (2.1)$$

which is a direct consequence of the fact that $\alpha\beta = \beta^{-1}(\beta\alpha)\beta$ is a conjugate of $\beta\alpha$. The hypermap $(\sigma^{-1}, \alpha\sigma^{-1})$ is not the hyperdual of (σ, α) in our terminology, but it is isomorphic to it: $\alpha\sigma^{-1} = \sigma(\sigma^{-1}\alpha)\sigma^{-1}$ is a conjugate of $\sigma^{-1}\alpha$ and sending each i into $\sigma(i)$ induces map from $(\sigma^{-1}, \sigma^{-1}\alpha)$ to $(\sigma^{-1}, \alpha\sigma^{-1})$ that is an isomorphism of hypermaps. As a consequence, sending each spanning unicellular hypermap θ of $(\sigma^{-1}, \sigma^{-1}\alpha)$ into $\theta' = \sigma\theta\sigma^{-1}$ we obtain a bijection between the spanning unicellular hypermaps of $(\sigma^{-1}, \sigma^{-1}\alpha)$ and the spanning unicellular hypermaps of $(\sigma^{-1}, \alpha\sigma^{-1})$. Composing the map $\theta \mapsto \theta' = \sigma\theta\sigma^{-1}$ with the map $\theta' \mapsto \zeta = \theta'\sigma$ we obtain the desired bijection $\theta \mapsto \zeta = \sigma\theta\sigma^{-1}\sigma = \sigma\theta$. \square

By replacing the hypermap (σ, α) by its Kreweras dual $(\sigma, \alpha^{-1}\sigma)$ in Theorem 2.1 we obtain the following consequence.

Corollary 2.2. *There is a bijection between the spanning genus g unicellular hypermaps θ of a hypermap (σ, α) of genus g and the set*

$$C_\sigma(\sigma, \alpha^{-1}\sigma) = \{\zeta : z(\zeta) = 1, g(\sigma, \zeta) = g(\sigma, \alpha^{-1}\sigma), g(\alpha^{-1}\sigma, \zeta) = 0\},$$

taking each spanning unicellular hypermap θ into $\zeta = \theta^{-1}\sigma$.

Note that $\zeta = \theta^{-1}\sigma$ is the permutation whose only cycle is the only face of the hypermap (σ, θ) . The hypermap $(\sigma, \theta^{-1}\sigma)$ is the Kreweras dual of (σ, θ) , requiring $g(\sigma, \zeta) = g(\sigma, \alpha^{-1}\sigma)$ is equivalent to requiring that the spanning unicellular hypermap (σ, θ) must have the same genus as (σ, α) . Less immediate is the following consequence: visiting the labels in the order of ζ amounts to traversing the only face of (σ, θ) according to its orientation. During this traversal we visit the faces of (σ, α) in their cyclic order in $\alpha^{-1}\sigma$. Least obvious is the fact that the above criteria on the genres and the number of cycles *characterize* the only faces of spanning unicellular hypermaps.

Example 2.3. Consider the hypermap (σ, α) shown in Fig. 1. The permutation $\theta = (1)(2, 9)(3)(4, 10)(5)(6)(7)(8, 12)(11)$ is a refinement of α , and the hypermap (σ, θ) is a spanning hypertree of the hypermap (σ, α) . This spanning hypertree, together with its only face $\theta^{-1}\sigma = (1, 9, 4, 5, 6, 10, 7, 12, 11, 8, 2, 3)$ is shown in Fig. 2.

It should not confuse the reader that the spanning hypertree in Example 2.3 is also a tree. We include a second example of a spanning hypertree: this example is not a tree, and the hypermap is also nonplanar.

Example 2.4. Consider the hypermap

$$(\sigma, \alpha) = ((1, 4, 7)(2, 5, 8)(3, 6, 9), (1, 2, 3)(4, 5, 6)(7, 8, 9))$$

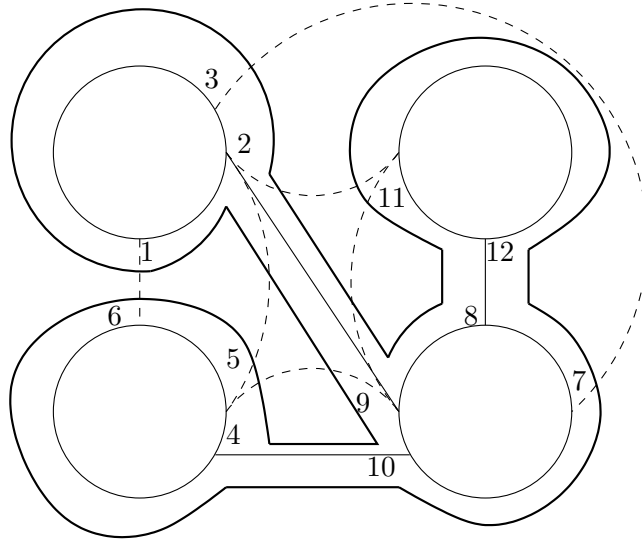

FIGURE 2. A spanning hypertree of the hypermap shown in Fig.1

shown in Fig. 3. It has genus 1, hence we draw it on a torus: the reader is supposed to identify pairs of points having the same first or second coordinate on the boundary of the bounding box. The circles represent the vertices, the hyperedges are bounded by dashed lines, except for the cycle $(1, 2, 3)$. The permutation $\theta = (1, 2, 3)$ is a refinement of α and (σ, θ) is a spanning hypertree. The only face of (σ, θ) is $\theta^{-1}\sigma = (1, 4, 7, 3, 6, 8, 2, 5, 8)$.

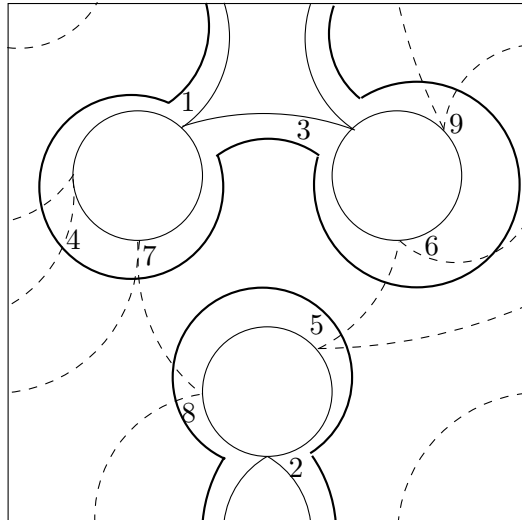

FIGURE 3. A hypermap of genus 1 and its spanning hypertree

We may use the cyclic order of $\theta^{-1}\sigma$ to obtain a special representation of the spanning hypertree of a genus zero hypermap, which we call the *one-line diagram* $D(\sigma, \alpha, \theta)$. We list the labels in the order they appear in $\theta^{-1}\sigma$, starting with 1, in the left to right order, below a horizontal line. Above the horizontal line we connect the elements that

are adjacent in a cycle of $\alpha^{-1}\sigma$, below the horizontal line we connect the labels that are adjacent in a cycle of σ , and we shade the regions representing the cycles of these permutations, as shown in Fig. 4. We make sure that the labels are recorded on the left hand side of the points corresponding to them on the horizontal line.

The following statement is an obvious consequence of the definition of $C_\sigma(\sigma, \alpha^{-1}\sigma)$.

Proposition 2.5. *Let (σ, α) be a genus zero hypermap on the set $\{1, 2, \dots, n\}$. The circular permutation of $\{1, 2, \dots, n\}$ is the only face of a spanning hypertree of (σ, α) if and only if its one-line diagram satisfies the following.*

- (1) *The arcs above the horizontal line represent the parts of a noncrossing partition whose parts are the cycles of $\alpha^{-1}\sigma$, that is, the faces.*
- (2) *The arcs below the horizontal line represent the parts of a noncrossing partition whose parts are the cycles of σ , that is, the vertices.*

For hypermaps of higher genus a similar characterization may be formulated, which we will present in Section 3. It is worth noting that the regions between the shaded

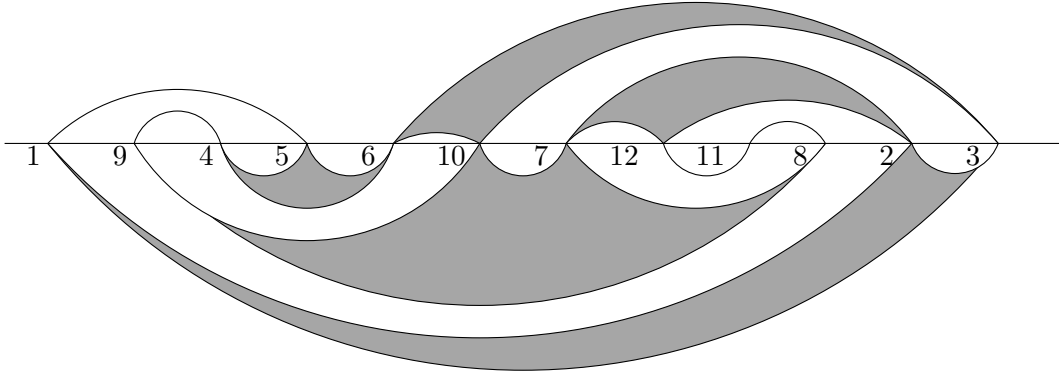

FIGURE 4. One-line representation of the spanning hypertree shown in Fig.2

areas allow us to read off the hyperedges of (σ, α) and (σ, θ) respectively.

Theorem 2.6. *Let (σ, α) be a hypermap of genus zero and (σ, θ) a spanning hypertree of (σ, α) . Disregarding the horizontal line, the unshaded regions between and around the regions representing the cycles of σ and $\sigma^{-1}\alpha$ in $D(\sigma, \theta, \alpha)$ contain the labels of the hyperedges of (σ, α) . The parts of these regions below the horizontal line are labeled with the hyperedges of (σ, θ) .*

Proof. (Sketch.) The first statement is a direct consequence of the definition. To prove the second statement, observe that going around the spanning hypertree, on one side we have the vertices and the hyperedges of (σ, θ) and the vertices and on the other side we have the faces and parts of the hyperedges of (σ, α) which connect the cycles of θ into cycles of α □

3. HYPERDELETIONS, HYPERCONTRACTIONS AND COMPATIBLE PAIRS OF TOURS

Recall that a transposition $\tau = (i, j)$ connects a permutation π if i and j belong to different cycles of π , otherwise we say that it disconnects π . The reason behind this

terminology is *Serret's lemma*, according to which for a transposition τ connecting π we have $z(\tau\pi) = z(\pi\tau) = z(\pi) - 1$ and for a transposition τ disconnecting π we have $z(\tau\pi) = z(\pi\tau) = z(\pi) + 1$. For example, when τ disconnects π , the cycles of $\pi\tau$ and the cycles of $\tau\pi$ are obtained from the cycles of π by breaking the single cycle containing both i and j into two cycles, one containing i , one containing j . Keeping this in mind, we make the following definition.

Definition 3.1. *A hyperdeletion is the operation of replacing a hypermap (σ, α) with the hypermap $(\sigma, \alpha\delta)$ where $\delta = (i, j)$ is a transposition disconnecting α . We call the hyperdeletion topological if δ also connects $\alpha^{-1}\sigma$, that is, $z(\delta\alpha^{-1}\sigma) = z(\alpha^{-1}\sigma) - 1$. In short, we will say that δ is a hyperdeletion for (σ, α) if the operation $(\sigma, \alpha) \mapsto (\sigma, \alpha\delta)$ is a hyperdeletion.*

It is part of the definition of a hyperdeletion that $(\sigma, \alpha\delta)$ must still be a hypermap. We are simply not allowed to replace α with $\alpha\delta$ if σ and $\alpha\delta$ do not generate a transitive group. In that case we will say that δ is an *isthmus*. Note that this definition coincides with the usual definition if (σ, α) is a map in which each cycle of α has at most two elements, equivalently, $\alpha = \alpha^{-1}$ holds. In that case, disconnecting a cycle of α , while keeping σ unchanged, corresponds to deleting an edge. For topological deletions, the fact that $z(\delta\alpha^{-1}\sigma) = z(\alpha^{-1}\sigma) - 1$ automatically guarantees that $(\sigma, \alpha\delta)$ is also a hypermap, this was already noted in [6] and [23]. Note that, for all hyperdeletions, the faces of $(\sigma, \alpha\delta)$ are the cycles of $\delta\alpha^{-1}\sigma$. By Serret's lemma, for topological hyperdeletions we have $z(\alpha\delta) = z(\alpha) + 1$ and $z(\alpha^{-1}\sigma) = z(\delta\alpha^{-1}\sigma) + 1$, hence the hypermap $(\sigma, \alpha\delta)$ has the same genus as (σ, α) . If the hyperdeletion is not topological then we have $z(\alpha\delta) = z(\alpha) + 1$ and $z(\alpha^{-1}\sigma) = z(\delta\alpha^{-1}\sigma) - 1$, and we have $g(\sigma, \alpha\delta) = g(\sigma, \alpha) - 1$. As a consequence, non-topological hyperdeletions exist only for hypermaps of positive genus, and they decrease the genus of the hypermap by one.

Dually, we define *hypercontractions* as follows.

Definition 3.2. *A hypercontraction is the operation of replacing a hypermap (σ, α) with the hypermap $(\gamma\sigma, \gamma\alpha)$ where $\gamma = (i, j)$ is a transposition disconnecting α . We call a hypercontraction topological if it also connects σ , that is, we have $z(\gamma\sigma) = z(\sigma) - 1$. In short, we will say that γ is a hypercontraction for (σ, α) if the operation $(\sigma, \alpha) \mapsto (\gamma\sigma, \gamma\alpha)$ is a hypercontraction.*

Once again, we require $(\gamma\sigma, \gamma\alpha)$ to be a hypermap, and we do not allow the operation $(\sigma, \alpha) \mapsto (\gamma\sigma, \gamma\alpha)$ if $\gamma\sigma$ and $\gamma\alpha$ generate a non-transitive subgroup.

The description of non-topological hypercontractions is intuitively less obvious, even for maps. Clearly $\gamma = (i, j)$ is a topological hypercontraction if and only if i and j belong to different cycles of σ . If i and j belong to the same cycle of σ in a map (σ, α) then (i, j) is a loop and $(\gamma\sigma, \gamma\alpha)$ is obtained by deleting this loop and *splitting* the vertex incident to this loop into two vertices.

Definition 3.3. *Given an undirected multigraph G , we define a vertex splitting as an operation that replaces a vertex v of G with two vertices v_1 and v_2 , and that replaces each edge e connecting some vertex u with v as follows: if $u \neq v$ then e is replaced with an edge connecting u with v_1 or v_2 , if $u = v$ then the loop edge incident to v is replaced with a loop edge incident to v_1 or v_2 or by an edge connecting v_1 with v_2 . If*

the graph H is obtained from G by vertex splitting, we say that G is obtained from H by vertex merging. For a hypermap (σ, α) , a topological vertex splitting is a map $(\sigma, \alpha) \mapsto ((i, j)\sigma, (i, j)\alpha)$ where i and j belong to the same cycle of σ .

Remark 3.4. Various definitions of a vertex splitting exist in the literature of graph theory, and the one given in Definition 3.3 above does not seem to be the most frequently used one. That said, this definition of a vertex splitting is used for example in [8].

Note that we allow the use of a non-topological contraction only if the resulting graph is not disconnected. For example for $\gamma = (1, 2)$ and the monopole $(\sigma, \alpha) = ((1, 2, 3, 4), (1, 2)(3, 4))$ the pair of permutations $(\gamma\sigma, \gamma\alpha) = ((1)(2, 3, 4), (1)(2)(3, 4))$ is not a map: it has two isolated vertices, one of them is incident to the loop $(3, 4)$. On the other hand, for $\gamma = (1, 3)$ and the monopole $(\sigma, \alpha) = ((1, 2, 3, 4), (1, 3)(2, 4))$ the pair of permutations $(\gamma\sigma, \gamma\alpha) = ((1, 2)(3, 4), (1)(2, 4)(3))$ is a map: we obtain two vertices connected by the edge $(2, 4)$.

A topological hypercontraction does not disconnect the hypermap, nor does it change the genus, whereas a non-topological hypercontraction may disconnect a hypermap, and if it does not then it decreases the genus by one. Hyperdeletions and hypercontractions are dual to each other in the following sense.

Lemma 3.5. *Given a hypermap (σ, α) and a transposition τ disconnecting α , the operation $(\sigma, \alpha) \mapsto (\sigma, \alpha\tau)$ is a hyperdeletion if and only if the operation $(\alpha^{-1}\sigma, \alpha^{-1}) \mapsto (\tau\alpha^{-1}\sigma, \tau\alpha^{-1})$ is a hypercontraction. If one of these operations is topological then so is the other one.*

The straightforward verification is left to the reader. It is worth memorizing that hyperdeletions keep the vertices unchanged and change the number of faces, whereas hypercontractions keep faces unchanged and change the number of vertices. In analogy to [23, Lemma 3] we may note the following.

Lemma 3.6. *If δ is a deletion (γ is a contraction) for the hypermap (σ, α) then the permutation $\alpha\delta$ (the permutation $\gamma\alpha$) is a refinement of α .*

To allow repeated use of hyperdeletions and hypercontractions, we make the following definition.

Definition 3.7. *Given a hypermap (σ, α) we call a sequence of transpositions $\delta_1, \dots, \delta_k$ a sequence of hyperdeletions for (σ, α) if δ_1 is a hyperdeletion for (σ, α) and for each i satisfying $1 < i \leq k$ the transposition δ_i is a hyperdeletion for $(\sigma, \alpha\delta_1 \cdots \delta_{i-1})$. Dually, we call a sequence of transpositions $\gamma_1, \dots, \gamma_k$ a sequence of hypercontractions for (σ, α) if γ_1 is a hypercontraction for (σ, α) and for each i satisfying $1 < i \leq k$ the transposition γ_i is a hypercontraction for $(\gamma_{i-1} \cdots \gamma_1\sigma, \gamma_{i-1} \cdots \gamma_1\alpha)$.*

In analogy to [23, Lemma 1], one may note that we can always find a topological hyperdeletion δ decreasing the number of faces of a hypermap, as long as (σ, α) is not unicellular. Indeed, if all transpositions connecting $\alpha^{-1}\sigma$ also connect α then the cycles of α are contained in the cycles of $\alpha^{-1}\sigma$, the permutations α and $\alpha^{-1}\sigma$ do not generate a transitive permutation group, the same holds for α and σ , in contradiction with (σ, α) being a hypermap. Thus we obtain the following statement.

Lemma 3.8. *For any hypermap (σ, α) with more than one face, there is a sequence of topological hyperdeletions $\delta_1, \dots, \delta_{z(\alpha^{-1}\sigma)-1}$ of length $z(\alpha^{-1}\sigma) - 1$. For any sequence of hyperdeletions of such length, the hypermap $(\sigma, \alpha\delta_1 \cdots \delta_{z(\alpha^{-1}\sigma)-1})$ is a spanning unicellular hypermap of (σ, α) of genus $g(\sigma, \alpha)$.*

The following strengthening of Lemma 3.8 is implicit in the proof of [23, Theorem 1].

Proposition 3.9. *Given a hypermap (σ, α) of genus g and a spanning genus g unicellular hypermap (σ, θ) of it, there is a sequence of topological hyperdeletions of length $z(\alpha^{-1}\sigma) - 1$ taking (σ, α) into (σ, θ) . Conversely, applying any sequence of topological hyperdeletions of length $z(\alpha^{-1}\sigma) - 1$ to (σ, α) yields a spanning genus g unicellular hypermap of (σ, α) .*

The key idea behind proving Proposition 3.9 is that refining α to θ amounts to replacing each cycle of α with a noncrossing partition with respect to its cyclic order, and noncrossing partitions are intersections of the coatoms in the noncrossing partition lattice. Each coatom had exactly two parts, replacing a single cycle with two noncrossing cycles amounts to applying a topological hyperdeletion.

Applying Proposition 3.9 to the dual hypermap we obtain the following.

Corollary 3.10. *Given a hypermap (σ, α) of genus g , the set of all spanning genus g unicellular hypermaps of its dual hypermap $(\alpha^{-1}\sigma, \alpha^{-1})$ are exactly the hypermaps obtained by applying a sequence of topological hyperdeletions $\gamma_1, \gamma_2, \dots, \gamma_{z(\sigma)-1}$ to $(\alpha^{-1}\sigma, \alpha^{-1})$.*

By Lemma 3.5, Corollary 3.10 may be rephrased as follows.

Corollary 3.11. *Given a hypermap (σ, α) of genus g , the spanning genus g unicellular hypermaps of its dual $(\alpha^{-1}\sigma, \alpha^{-1})$ are exactly the duals of all hypermonopoles of the form $(\gamma\sigma, \gamma\alpha)$ where $\gamma = \gamma_{z(\sigma)-1}\gamma_{z(\sigma)-2}\cdots\gamma_1$, and $\gamma_1, \gamma_2, \dots, \gamma_{z(\sigma)-1}$ is a sequence of topological hypercontractions for (σ, α) .*

Note that the dual of the hypermonopole $(\gamma\sigma, \gamma\alpha)$ is $(\alpha^{-1}\sigma, \alpha^{-1}\gamma^{-1})$. By Theorem 1.5, the hypermap $(\alpha^{-1}\sigma, \alpha^{-1}\gamma^{-1})$ is a spanning genus g unicellular hypermap of $(\alpha^{-1}\sigma, \alpha^{-1})$ if and only if (σ, γ^{-1}) is a spanning hypertree of (σ, α) .

To summarize, we obtain the following result.

Theorem 3.12. *Given a hypermap (σ, α) , a hypermonopole may be obtained from it by a sequence of topological hypercontractions if and only if it is of the form $(\gamma\sigma, \gamma\alpha)$ where (σ, γ^{-1}) is any spanning hypertree of (σ, α) .*

Applying Corollary 2.2 to the spanning genus g unicellular hypermaps of the dual of a hypermap of genus g we obtain the following statement.

Proposition 3.13. *For a hypermap (σ, α) there is a bijection between the spanning hypertrees of (σ, α) and the set*

$$C_{\alpha^{-1}\sigma}(\alpha^{-1}\sigma, \sigma) = \{\eta : z(\eta) = 1, g(\alpha^{-1}\sigma, \eta) = g(\sigma, \alpha), g(\sigma, \eta) = 0\},$$

taking each spanning hypertree (σ, γ^{-1}) of (σ, α) into $\eta = \gamma\sigma$.

Proof. Each spanning hypertree (σ, γ^{-1}) of (σ, α) corresponds to a spanning genus g unicellular hypermap $(\alpha^{-1}\sigma, \alpha^{-1}\gamma^{-1})$ of the dual hypermap $(\alpha^{-1}\sigma, \alpha^{-1})$. The map described in Corollary 2.2 sends $(\alpha^{-1}\sigma, \alpha^{-1}\gamma^{-1})$ into $\eta = (\alpha^{-1}\gamma^{-1})^{-1}\alpha^{-1}\sigma = \gamma\sigma$. The range of the map $(\sigma, \gamma^{-1}) \mapsto \gamma\sigma$ is

$$C_{\alpha^{-1}\sigma}(\alpha^{-1}\sigma, \sigma) = \{\eta : z(\eta) = 1, g(\alpha^{-1}\sigma, \eta) = g(\alpha^{-1}\sigma, \sigma), g(\sigma, \eta) = 0\}.$$

Note finally that $g(\alpha^{-1}\sigma, \sigma) = g(\sigma, \alpha)$ is a direct consequence of (1.1) and $z(\sigma^{-1}\alpha^{-1}\sigma) = z(\alpha)$. \square

A particularly important instance of Proposition 3.13 is the case of maps. For these hyperdeletions and hypercontraction are actual deletions and contractions, as defined in graph theory. A sequence of deletions or contractions is a list of pairwise disjoint transpositions, their order does not matter, only the subgraph formed by the deleted, respectively contracted edges. As a consequence a sequence of contractions $\gamma_1, \dots, \gamma_k$ yields an involution $\gamma = \gamma_k \cdots \gamma_1$ which is its own inverse. We obtain the following corollary.

Corollary 3.14. *For a map (σ, α) there is a bijection between the spanning trees of the underlying graph of (σ, α) and the set*

$$C_{\alpha^{-1}\sigma}(\alpha^{-1}\sigma, \sigma) = \{\eta : z(\eta) = 1, g(\alpha^{-1}\sigma, \eta) = g(\sigma, \alpha), g(\sigma, \eta) = 0\},$$

taking each spanning tree (σ, γ) into $\eta = \gamma\sigma$.

We wish to point out that Corollary 3.14 implies Bernardi's [1, Lemma 4.2] stating that the *tour* of a spanning tree of an embedded topological graph is always a cyclic permutation. For each spanning tree (σ, γ) we may define the inverse of $\eta = \gamma\sigma$ as the *vertex tour* of the spanning tree. We illustrate this observation with the next example.

Example 3.15. The map (σ, α) , given by $\sigma = (1, 4, 2, 12)(8, 11, 9)(5, 7, 3, 6)(10)$ and $\alpha = (1, 7)(2, 8)(3, 9)(4, 10), (5, 11)(6, 12)$, and shown in Figure 5, is isomorphic as an embedded topological graph to an example of Bernardi. (It is drawn as the mirror image of the embedded topological graph on the left hand side of [1, Figure 1]. Bernardi's letters a through f correspond to the numbers 1 through 6, while the letters a' through f' correspond to the numbers 7 through 12 in our picture. We took the mirror image of Bernardi's figure to match his counterclockwise listing of vertex labels with our clockwise listing. Bernardi gives an example of a spanning tree [1, Figure 4], which corresponds to $\gamma = (1, 7)(2, 8)(4, 10)$, marked in bold on the left hand side of Figure 5. The order of the transpositions does not matter, contracting these edges results in a monopole. The permutation

$$\eta = \gamma\sigma = (1, 10, 4, 8, 11, 9, 2, 12, 7, 3, 6, 5) \in C_{\alpha^{-1}\sigma}(\alpha^{-1}\sigma, \sigma)$$

corresponds to the list $(a, d', d, b', e', c', b, f', a', c, f, e)$ in Bernardi's notation which is the inverse of the tour of the graph (or *motion function*) defined by Bernardi [1, p. 145].

The map shown in Figure 5 has genus 1, and we may draw it on the torus without crossing edges, as shown on the right hand side of the figure. (The rules of identifying pairs of points on the boundary of the bounding box are the same as in Figure 3.) The spanning tree on the left may be extended to a spanning genus 1 unicellular hypermap

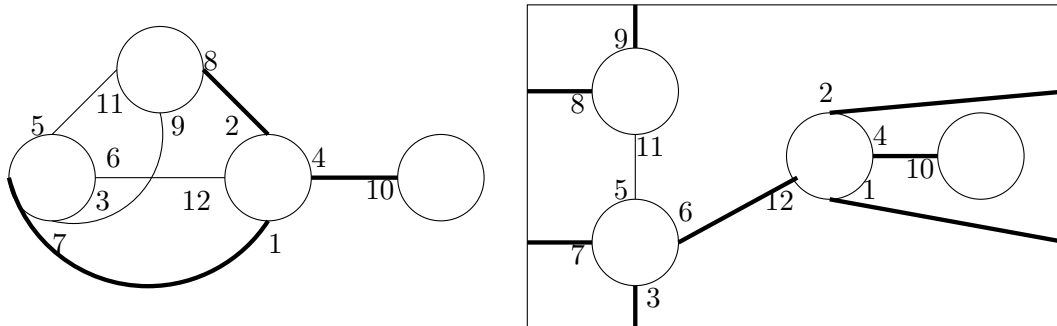

FIGURE 5. Bernardi's example

by adding the edges (3, 9) and (6, 12), also shown in bold on the right hand side. The spanning genus 1 unicellular hypermap $\theta = (1, 7)(2, 8)(3, 9)(4, 10)(6, 12)$ corresponds to

$$\zeta = \theta^{-1}\sigma = (1, 10, 4, 8, 11, 3, 12, 7, 9, 2, 6, 5) \in C_\sigma(\sigma, \alpha^{-1}\sigma)$$

via the bijection described in Corollary 2.2. This too is a *tour* of a spanning tree, albeit it is the tour of a spanning tree of genus 1. This observation inspires the following definition.

Definition 3.16. *Given a hypermap (σ, α) of genus g , for each spanning hypertree (σ, γ^{-1}) of (σ, α) we call the cyclic permutation $\eta = \gamma\sigma$ the vertex tour of the spanning hypertree, and for each spanning genus g unicellular hypermap (σ, θ) we call the cyclic permutation $\zeta = \theta^{-1}\sigma$ the face tour of the spanning genus g unicellular hypermap.*

By Corollary 2.2 the set of face tours is exactly the set $C_\sigma(\sigma, \alpha)$. If we write the labels in the cyclic order of a face tour ζ and represent the faces as in the upper half of Figure 4, we get a noncrossing representation of the faces since, by the definition of $C_\sigma(\sigma, \alpha)$, we have $g(\alpha^{-1}\sigma, \zeta) = 0$. Similarly, by Corollary 3.13 the set of vertex tours is exactly the set $C_{\alpha^{-1}\sigma}(\alpha^{-1}\sigma, \sigma)$. If we write the labels in the cyclic order of a face tour η and represent the vertices as in the lower half of Figure 4, we get a noncrossing representation of the vertices. The notion of a face tour and a vertex tour coincides for genus zero hypermaps.

The relation between the spanning genus 1 unicellular hypermap and spanning tree in Figure 5 and their associated face- and vertex tours may be also interpreted as follows. We begin with a hypermap (σ, α) of genus g . We perform a sequence of topological hyperdeletions $\delta_1, \dots, \delta_{|\alpha^{-1}\sigma|-1}$ and obtain a spanning genus g unicellular hypermap $(\sigma, \alpha\delta)$ of (σ, α) with the single face $\zeta = \delta^{-1}\alpha^{-1}\sigma \in C_\sigma(\sigma, \alpha^{-1}\sigma)$. These topological hyperdeletions leave the vertices σ unchanged. Next we perform a sequence of topological hypercontractions $\gamma_1, \dots, \gamma_{|\sigma|-1}$ and obtain a monopole $(\gamma\sigma, \gamma\alpha\delta)$ with the single vertex $\eta = \gamma\sigma \in C_{\alpha^{-1}\sigma}(\alpha^{-1}\sigma, \sigma)$ and single face ζ . Here $\gamma = \gamma_{|\sigma|-1} \cdots \gamma_1$ and (σ, γ^{-1}) is a spanning hypertree of (σ, α) . The vertex η is shown as a dashed circle in the middle of Figure 6, and the face ζ appears as a collection of four line segments (also to be interpreted as a circle on the torus) on the same illustration. Inside the circle representing η we find the cycles of σ , represented by the shaded areas. Inside the circle represented by ζ (shown in the four corners of Figure 6) we find the cycles of

$\alpha^{-1}\sigma = (1, 10, 4, 8, 5)(2, 6, 11, 3, 12, 7, 9)$, represented by the shaded areas. Between the two circles we have the hyperedges of $(\eta, \eta\zeta^{-1}) = (\gamma\sigma, \gamma\theta)$.

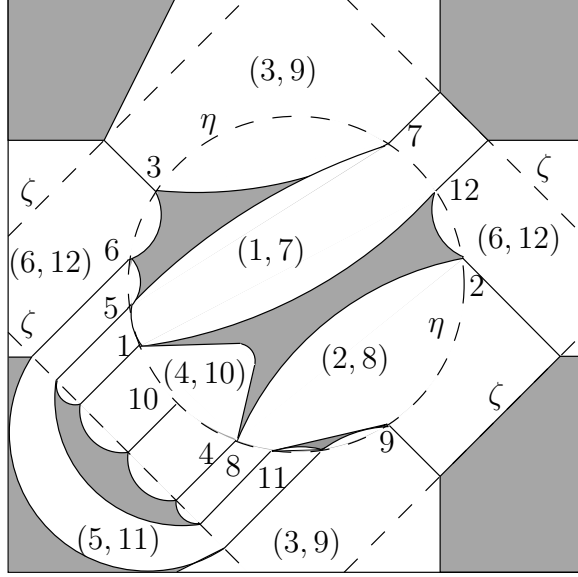

FIGURE 6. A 2-disk diagram of Bernardi's example

Wanting to generalize this picture to all hypermaps, we make the following definition.

Definition 3.17. *Given a hypermap (σ, α) , we say that the pair of circular permutations (η, ζ) satisfying $\eta \in C_{\alpha^{-1}\sigma}(\alpha^{-1}\sigma, \sigma)$ and $\zeta \in C_\sigma(\sigma, \alpha)$ is a compatible pair of tours if $(\eta, \eta\zeta^{-1})$ is a hypermap of genus $g(\sigma, \alpha)$.*

Remark 3.18. Note that the only vertex of $(\eta, \eta\zeta^{-1})$ is the only cycle of η and the only face is the only cycle of $(\eta\zeta^{-1})^{-1}\eta = \zeta$.

Theorem 3.19. *Given a hypermap (σ, α) , the pair of circular permutations (η, ζ) satisfying $\eta \in C_{\alpha^{-1}\sigma}(\alpha^{-1}\sigma, \sigma)$ and $\zeta \in C_\sigma(\sigma, \alpha)$ is compatible if and only if there is a sequence of topological hyperdeletions $\delta_1, \dots, \delta_{|\alpha^{-1}\sigma|-1}$ followed by a sequence of topological hypercontractions $\gamma_1, \dots, \gamma_{|\sigma|-1}$ taking (σ, α) into $(\eta, \eta\zeta^{-1})$.*

Proof. Assume first that there is a sequence of topological hyperdeletions $\delta_1, \dots, \delta_{|\alpha^{-1}\sigma|-1}$ followed by a sequence of hypercontractions $\gamma_1, \dots, \gamma_{|\sigma|-1}$ taking (σ, α) into $(\eta, \eta\zeta^{-1})$. Introducing $\delta = \delta_1 \cdots \delta_{|\alpha^{-1}\sigma|-1}$ and $\gamma = \gamma_{|\sigma|-1} \cdots \gamma_1$, the hypermap obtained from (σ, α) after performing these topological hyperdeletions and hypercontractions is $(\gamma\sigma, \gamma\alpha\delta)$. Here $\eta = \gamma\sigma$ and the equality $\eta\zeta^{-1} = \gamma\alpha\delta$ implies $\zeta = (\eta\zeta^{-1})^{-1}\eta = (\gamma\alpha\delta)^{-1}\gamma\sigma = \delta^{-1}\alpha^{-1}\sigma$. Since topological hyperdeletions and hypercontractions do not change the genus, we have $g(\eta, \eta\zeta^{-1}) = g(\sigma, \alpha)$ and (η, ζ) is a compatible pair of circular permutations.

Conversely, assume that (η, ζ) is a compatible pair of tours. By definition, ζ belongs to $C_\sigma(\sigma, \alpha)$, and by Corollary 2.2 there is a spanning genus g unicellular hypermap (σ, θ) of (σ, α) satisfying $\theta^{-1}\sigma = \zeta$. By Proposition 3.9 there is a sequence of topological hyperdeletions $\delta_1, \dots, \delta_{|\alpha^{-1}\sigma|-1}$ taking (σ, α) into (σ, θ) . (Note that the number of

topological hyperdeletions must be $|\alpha^{-1}\sigma| - 1$ since each hyperdeletion decreases the number of faces by one.) The hypermap (σ, θ) has the same genus as (σ, α) . Furthermore we have

$$\begin{aligned} 2g(\eta, \theta^{-1}\sigma) &= n + 2 - z(\eta) - z(\theta^{-1}\sigma) - z((\theta^{-1}\sigma)^{-1}\eta) = n + 2 - z(\eta) - z(\zeta) - z(\zeta^{-1}\eta) \\ &= n + 2 - z(\eta) - z((\eta\zeta^{-1})^{-1}\zeta) - z(\zeta^{-1}\eta) = 2g(\eta, \eta\zeta^{-1}), \end{aligned}$$

which, by our assumption implies $g(\eta, \theta^{-1}\sigma) = g(\sigma, \alpha)$. Since $\eta \in C_{\alpha^{-1}\sigma}(\alpha^{-1}\sigma, \sigma)$ also implies $g(\eta, \sigma) = 0$, we obtain that η belongs to $C_{\theta^{-1}\sigma}(\theta^{-1}\sigma, \sigma)$. By Proposition 3.13 there is a sequence of contractions taking (σ, θ) into $(\eta, \eta\zeta^{-1})$. \square

A compatible pair of tours (η, ζ) of a hypermap (σ, α) allows to create a *two-disk diagram* $D(\sigma, \alpha, \eta, \zeta)$ of the hypermap (σ, α) on an appropriate surface of genus $g(\sigma, \alpha)$ as follows:

- (1) We create a diagram of the hypermap $(\eta, \eta\zeta^{-1})$ with noncrossing lines on a surface of genus $g(\eta, \eta\zeta^{-1}) = g(\sigma, \alpha)$ as follows. We take two disjoint disks and we list the points on the boundaries of both, in the cyclic order of η , respectively ζ . By the result of Jacques [15] there is a surface of genus $g(\sigma, \alpha)$ on which the disks representing η and ζ may be drawn in such a way that filling in the hyperedges of $\eta\zeta^{-1}$ results in no crossings. See also Remark 3.20 below.
- (2) We draw the vertices of (σ, α) as a noncrossing partition inside the disk bounded by the vertex tour η .
- (3) We draw the faces of (σ, α) as a noncrossing partition inside the disk bounded by the face tour ζ .

An illustration of the process is shown in Figure 6. The diagram is drawn on a torus, the dashed circle in the middle is the vertex tour η . The circle representing the face tour ζ appears as the union of four slanted dashed line segments in the picture, due to the usual toric identifications on the boundaries of the picture. The shaded regions in the interior of the disk bounded by η are the vertices, that is, the cycles of σ . The shaded regions in the interior of the disk bounded by ζ (appearing as the four corners in the picture) are the faces, that is, the cycles of $\alpha^{-1}\sigma$. Note that the unshaded regions inside the disk bounded by η may be labeled by the hypercontractions and the unshaded regions inside the disk bounded by ζ may be labeled by the topological hyperdeletions.

Remark 3.20. The second and the third steps of the above process are obvious, the reader might wonder why not just apply the result of Jacques [15] directly. By creating a two-disk diagram we reduce the challenge of drawing an arbitrary hypermap to that of drawing a unicellular monopole $(\eta, \eta\zeta^{-1})$. The surface to be used does not change if we add or remove points that are fixed points of the collection of hyperedges $\eta\zeta^{-1}$. For the map shown in Figure 6, removing all the fixed points of $\eta\zeta^{-1}$ results in the map $((3, 6, 9, 12), (3, 9)(6, 12))$ on the set of points $\{3, 6, 9, 12\}$, which, after renumbering, is isomorphic to the map $((1, 2, 3, 4), (1, 3)(2, 4))$. Hence, to classify the surfaces we need, we may restrict our attention to unicellular monopoles $(\eta, \eta\zeta^{-1})$ satisfying not only $z(\eta) = z(\zeta) = 1$ but also that $\eta\zeta^{-1}$ has no fixed point, implying $1 \leq z(\eta\zeta^{-1}) \leq n/2$. A direct consequence of (1.1) to such a hypermap is $2g(\eta, \eta\zeta^{-1}) + 1 \leq n \leq 4g(\eta, \eta\zeta^{-1})$ for any positive genus. Thus the number of substantially different two-disk diagrams

of genus $g > 0$ is finite: an infinite number of possibilities arises only after adding some fixed points to $\eta\zeta^{-1}$ and selecting a pair of noncrossing partitions inside the two disks. For $g = 1$ we get $3 \leq n \leq 4$. Without loss of generality we may assume $\eta = (1, 2, \dots, n)$, then the only two genus 1 unicellular monopoles $(\eta, \eta\zeta^{-1})$ to consider are $((1, 2, 3), (1, 3, 2))$ and $((1, 2, 3, 4), (1, 3)(2, 4))$. In particular, we may create the two-disk diagram of any genus 1 map by drawing $((1, 2, 3, 4), (1, 3)(2, 4))$ to a torus and then refining the picture by adding more points and a pair of noncrossing partitions to the picture.

We conclude this section with a two-disk diagram of the hypermap presented in Example 2.4. This time we consider $\gamma = (1, 2)(5, 6)$ and $\theta = (1, 2)(5, 6)(7, 8, 9)$, yielding

$$\eta = \gamma\sigma = (1, 4, 7, 2, 6, 9, 3, 5, 8) \quad \text{and} \quad \zeta = \theta^{-1}\sigma = (1, 4, 7, 9, 3, 5, 7, 2, 6, 8).$$

We have $\eta\zeta^{-1} = (7, 8, 9)$ hence the drawing process starts with creating a diagram for $(\eta, \eta\zeta^{-1}) = ((1, 4, 7, 2, 6, 9, 3, 5, 8), (7, 8, 9))$. After the removal of the fixed points of $\eta\zeta^{-1}$ we need to find a two-disk diagram of $((7, 9, 8), (7, 8, 9))$ on the set of points $\{7, 8, 9\}$. Essentially this is the only example of a unicellular hypermonopole of genus 1 that is not a map.

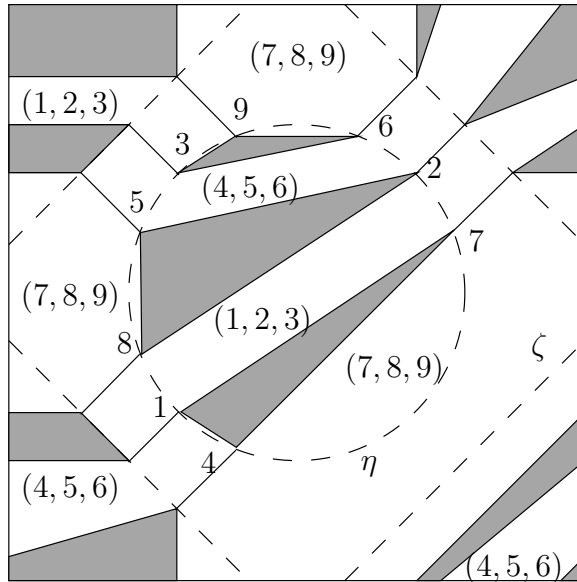

FIGURE 7. A 2-disk diagram of the hypermap presented in Example 2.4.

Just like in the previous example, the unshaded regions inside ζ and η , respectively, represent the hyperdeletions and hypercontractions, respectively. Note furthermore that, after removing the dashed curves representing ζ and η , the unshaded regions represent the hyperedges. For example there is a contiguous region labeled $(1, 2, 3)$ and its part inside η corresponds to the hypercontraction $(1, 2)$. Another contiguous region is labeled $(4, 5, 6)$ and its part inside ζ corresponds to the hyperdeletion $(4, 6)$. In general, when we write $(\eta, \eta\zeta^{-1}) = (\gamma\sigma, \gamma\alpha\delta)$, the cycles of γ label the unshaded regions inside η and the cycles of δ label the unshaded regions inside ζ .

4. DELETION-CONTRACTION PROCESSES

In this section we generalize the definition of deletion-contraction processes used to define the Tutte polynomial, from connected graphs to hypermaps. Our generalization is inspired by the following definition of the Tutte polynomial:

- (1) We fix a numbering of the edges of the graph, and we consider all deletion-contraction processes in which we delete or contract each edge in decreasing order of their numbers.
- (2) We may freely choose an edge to be deleted or contracted, except for the following two restrictions:
 - (a) We must contract an edge if deleting it would disconnect a graph. Such edges are *internally active*.
 - (b) We must delete an edge if it is a loop (hence contracting it would not be topological). Such edges are *externally active*.
- (3) For each such deletion-contraction process we take the variable x to the power of the number of internally active edges and multiply it with the variable y to the power of the number of externally active edges. The Tutte polynomial is the sum of the contributions of all deletion-contraction processes.

It has been shown by Tutte that the resulting polynomial is independent of the numbering of the edges. Furthermore, the set of (topologically) contracted edges must be a spanning tree of the graph, each spanning tree, together with the fixed numbering uniquely defines the deletion-contraction process: all edges which were not contracted must be deleted.

This definition of a Tutte polynomial is immediately applicable to maps as they are connected graphs with some additional topological structure, which we may ignore. The only “topological” part of the definition of the Tutte polynomial is that we disallow non-topological hypercontractions which may be defined in abstract terms by disallowing the contractions of loops. Furthermore, the final monopole with no edges *depends on the set of contracted edges only*, not the order in which the deletions and contractions are performed. The order matters only in the definition of the activities.

A plausible generalization of the above definition of a deletion-contraction process to a hypermap (σ, α) is the following. We consider all sequences of (arbitrary) hyperdeletions and topological hypercontractions which take hypermaps into hypermaps, result in a hypermap $(\gamma\sigma, \gamma\alpha\delta)$ where $z(\gamma\sigma) = 1$ (at the end we have a single vertex) and $\gamma\alpha\delta$ is the identity (“we have no hyperedges”).

Definition 4.1. *Given a hypermap (σ, α) , a deletion-contraction process is a sequence of hyperdeletions and topological hypercontractions resulting in a hypermap $(\gamma\sigma, \gamma\alpha\delta)$ where $z(\gamma\sigma) = 1$ and $\gamma\alpha\delta$ is the identity. Each hyperdeletion and hypercontraction is induced by a transposition, which we call the transposition underlying the operation, and we call the set of all these transpositions the set of underlying transpositions of the deletion-contraction process.*

Definition 4.2. *Given a hypermap (σ, α) and a deletion-contraction process for it, the graph G of underlying transpositions of the process is the graph, whose vertices are the cycles of σ and whose edges are the underlying transpositions (u, v) .*

Note that the graph of underlying transpositions of a deletion-contraction process depends only on the set of underlying transpositions of the process, which set may be uniquely reconstructed from the graph. The graph G is not a map, as several underlying transpositions (u, v) may involve the same point u , but it is a *topological graph*, that is, a graph whose edges may be cyclically ordered around each vertex (u_1, u_2, \dots, u_k) as follows:

$$\begin{aligned} & (u_1, v_{1,1}), (u_1, v_{1,2}), \dots, (u_1, v_{1,\ell_1}), \\ & (u_2, v_{2,1}), (u_2, v_{2,2}), \dots, (u_2, v_{2,\ell_2}), \dots \\ & (u_k, v_{k,1}), (u_k, v_{k,2}), \dots, (u_1, v_{k,\ell_k}). \end{aligned}$$

Here, for each $i \in \{1, 2, \dots, k\}$ the cycle $(u_i, v_{i,1}, v_{i,2}, \dots, v_{i,\ell_i})$ is the cycle of α^{-1} containing the point u_i . Note that when we draw a hypermap (σ, α) of genus zero following the conventions of Figure 1, we obtain a counterclockwise list of all edges incident to the vertex (u_1, u_2, \dots, u_k) . Next we state some necessary conditions.

Proposition 4.3. *Given a hypermap (σ, α) , the set of underlying transpositions of a deletion-contraction process must satisfy the following criteria:*

- (1) *For each transposition (u, v) the points u and v belong to the same cycle of α .*
- (2) *For each cycle α_i of α , the transpositions swapping two points permuted by α_i form a tree on the set of points permuted by α_i . This tree has non-crossing edges if we draw the points of α_i in cyclic order on a cycle.*

Proof. Each transposition underlying a hyperdeletion or hypercontraction must disconnect the current permutation representing the hyperedges, hence each transposition (u, v) must have both u and v in the same cycle of the original permutation α . Since no underlying transposition is allowed to reconnect already disconnected cycles, the set of transpositions swapping two points permuted by α_i must form the edges of a cycle-free graph. Since, by the end of the process, the cycle α_i must be completely disconnected, the set of underlying transpositions swapping points permuted by α_i must form a tree on all points permuted by α_i . The non-crossing property may be shown by induction on the number of points, keeping in mind that the first transposition applied disconnects α_i into two cycles of cyclically consecutive points. \square

Definition 4.4. *Given a hypermap (σ, α) , we call the topological graph G on the vertex set of the cycles of σ , and indexed by ordered pairs of points of the hypermap, locally tree-like if the set of transpositions constituting the edge set of G satisfy the criteria stated in Proposition 4.3.*

The next necessary condition is on the subsets of underlying transpositions that may represent the hypercontractions in a deletion-contraction process.

Proposition 4.5. *Let (σ, α) be a hypermap and let G be the graph of underlying transpositions for a deletion-contraction process. Consider the subgraph T of G whose edges are the transpositions representing hypercontractions. Then T must be a spanning tree of G and must satisfy the following criterion: given any point u , and the cycle $(u, v_1, v_2, \dots, v_k)$ of α^{-1} containing u , the transpositions representing hypercontractions on the list $(u, v_1), (u, v_2), \dots, (u, v_k)$ must precede the transpositions representing hyperdeletions.*

Proof. The subgraph T has to be a spanning tree to assure that the hypermap $(\gamma\sigma, \gamma\alpha\delta)$ obtained at the end of a vertex has a single vertex and that all hypercontractions performed are topological. The second criterion is a direct consequence of a result of Goulden and Yong [14, Theorem 2.2]. This states that when we write a cyclic permutation as a minimal composition of transpositions, then these transpositions must form the edges of a noncrossing tree on the points represented on a cycle in a clockwise order, and around each point the transpositions moving that point must be performed in a counterclockwise order. Conversely, any sequence of transpositions satisfying the above conditions is a factoring of the cyclic permutation. Introducing γ_i respectively δ_i to denote the product of transpositions underlying the hypercontractions, respectively hyperdeletions acting on the set of points permuted by the cycle α_i of α , the permutation $\gamma_i\alpha_i\delta_i$ must be the identity permutation, equivalently we must have $\alpha_i^{-1} = \delta_i\gamma_i$. Note that the transpositions constituting δ_i must be all after the transpositions constituting γ_i . \square

Definition 4.6. *Given a locally tree-like topological graph G associated to a hypermap (σ, α) , we call a spanning tree T allowable if it has the property stated in Proposition 4.5. We say that the topological graph is a deletion-contraction graph of (σ, α) if it is locally tree-like and has an allowable spanning tree. We will use the notation $(\sigma, \alpha) \models G$ to indicate that G is a deletion-contraction graph for (σ, α) .*

Definition 4.6 is justified by the next theorem, stating that the criteria listed in Propositions 4.3 and 4.5 are also sufficient.

Theorem 4.7. *Given a hypermap (σ, α) , a topological graph G is the map of underlying transpositions of a deletion-contraction process if and only if $(\sigma, \alpha) \models G$ holds. Furthermore, all deletion-contraction processes with the same graph of underlying transpositions are fully characterized by the following criteria:*

- (i) *The edges of G underlying a hypercontraction form an allowable spanning tree of G .*
- (ii) *For each cycle α_i of α , if we list the points permuted by α_i in clockwise order, at each point u the hyperdeletions whose underlying transposition moves u are performed in counterclockwise order and the hypercontractions whose underlying transposition moves u are performed in clockwise order.*

Proof. By Propositions 4.3 and 4.5, $(\sigma, \alpha) \models G$ is a necessary condition. To prove its sufficiency, it suffices to prove the stated characterization of deletion-contraction processes and then show that the hyperdeletions and hypercontractions may be performed in such order that the conditions (i) and (ii) are satisfied.

Condition (i) is not only a necessary but also a sufficient condition to assure that the hypermap $(\gamma\sigma, \gamma\alpha\delta)$ obtained at the end of a vertex has a single vertex and that all hypercontractions performed are topological. Condition (ii) is a direct consequence of the already cited result of Goulden and Yong [14, Theorem 2.2]. As pointed out in the proof of Proposition 4.5, we must have $\alpha_i^{-1} = \delta_i\gamma_i$ for each cycle α_i of α and this equation holds if and only if the transpositions constituting $\delta_i\gamma_i$ are performed in the cyclic order of α_i^{-1} around each point moved by α_i . The order in which we apply the hypercontractions is the opposite to the order in which the corresponding transpositions

are composed to obtain γ_i^{-1} whereas the hyperdeletions are applied in the same order as the corresponding transpositions are composed to obtain δ_i^{-1} .

We are left to show that for every map G satisfying $(\sigma, \alpha) \models G$ there is a deletion-contraction process whose underlying graph of transpositions is G . First we select any spanning tree of G then we number the cycles of α in some order: $\alpha_1, \alpha_2, \dots, \alpha_m$. We will first number all edges of G contained in α_1 , then the ones contained in α_2 , and so on. Hence all edges of G contained in the same α_i will be labeled consecutively. Let us represent the points permuted by α_i on a circle in clockwise order. We only need to show that the edges of this tree can be numbered in such a way that for each point u the numbers of all edges containing u increase in clockwise order. We may then reverse the numbering on the transpositions underlying to hypercontractions and use the resulting numbering to label the edges of G contained in the set of points permuted by α_i . Executing all hyperdeletions and hypercontractions in decreasing order of the labels satisfies the conditions (i) and (ii).

The conclusion of the proof is a direct consequence of Lemma 4.8 below. \square

Lemma 4.8. *Given a set of m points on a circle, numbered in clockwise order, and a noncrossing tree on this set of points one may number the edges of this tree in such a way that for each point u the edges incident to u are numbered on increasing clockwise order.*

Proof. We proceed by induction on the number of points. Consider a leaf of the tree. By cyclic rotation of the numbering, if necessary, we may assume that this leaf is (i, m) and that the point numbered m is not contained in any other edge. Deleting this edge from the tree results in a pair of trees: a tree T_1 on the set $\{1, 2, \dots, i-1, i\}$ and a tree T_2 on the set $(i, i+1, i+2, \dots, m-1)$. Consider the factorization

$$(1, 2, \dots, m) = (1, 2, \dots, i-1, i)(i, m)(i, i+1, i+2, \dots, m-1)$$

and apply the induction hypothesis to the cycles $(1, 2, \dots, i-1, i)$ and $(i, i+1, i+2, \dots, m-1)$, and the trees T_1 and T_2 . Number the edges of T_1 first, then number the edge (i, j) and then number the edges of T_2 . \square

Deletion-contraction graphs may be equivalently described in terms of the permutations γ , obtained by composing all the hypercontractions of a deletion-contraction process. The proof of this statement is more easily presented by using the notion of the Kreweras dual of a hypermap.

Theorem 4.9. *Let (σ, α) be a hypermap of genus g on the set of points $\{1, 2, \dots, n\}$. Let G be a graph whose vertices are the cycles of σ and whose edges are transpositions (u, v) where $1 \leq u < v \leq n$. Then G is a deletion-contraction graph, if and only if there is a spanning genus g unicellular hypermap (σ, γ^{-1}) of (σ, α) such that the following are satisfied by the permutations γ and $\delta = \alpha^{-1}\gamma^{-1}$:*

- (1) *Each edge of G either connects two points on the same cycle of γ , or on the same cycle of δ .*
- (2) *The restriction of G to any cycle of γ or δ is a noncrossing tree if we represent the points in the cyclic order of the cycle of α containing the cycle of γ or δ .*

Proof. Consider first a deletion-contraction process. The hyperdeletions of the process leave the vertices unchanged, each topological contraction merges two vertices (and

refines a current hyperedge into two). The resulting monopole $\gamma\sigma$ is a vertex tour of the hypermap, and conversely, every vertex tour arises as the composition of topological hypercontractions. As seen in Section 3, the permutation $\gamma\sigma$ is a vertex tour of the hypermap if and only if (σ, γ^{-1}) is a spanning hypertree of (σ, α) . Whenever this condition is satisfied, $\gamma\alpha$ is a refinement of α , and the transpositions underlying a hypercontraction must form a tree on each cycle of γ . Introducing δ as the composition of all transpositions underlying a hyperdeletion, the permutation $\gamma\alpha\delta$ is the identity permutation if and only if $\delta = \alpha^{-1}\gamma^{-1}$ holds. The transpositions underlying the hyperdeletions must form trees on each cycle of δ since, starting with $\gamma\alpha$, each hyperdeletion refines a hyperedge into two, and at the end of the process $\gamma\alpha\delta$ is the identity permutation.

To prove the converse, assume that $\alpha_1, \alpha_2, \dots, \alpha_m$ are the cycles of α and for each i let us denote by γ_i , respectively δ_i the products of cycles of γ , respectively δ_i contained in α_i . To state that $\gamma\alpha$ is a refinement of α is equivalent to stating that $(\alpha_i, \gamma_i^{-1})$ is a noncrossing partition for each i . (Note that α_i is the single vertex here!) Furthermore $\delta = \alpha^{-1}\gamma^{-1}$ is equivalent to stating that $(\alpha_i, \delta_i^{-1})$ is the Kreweras dual of $(\alpha_i, \gamma_i^{-1})$ for each i .

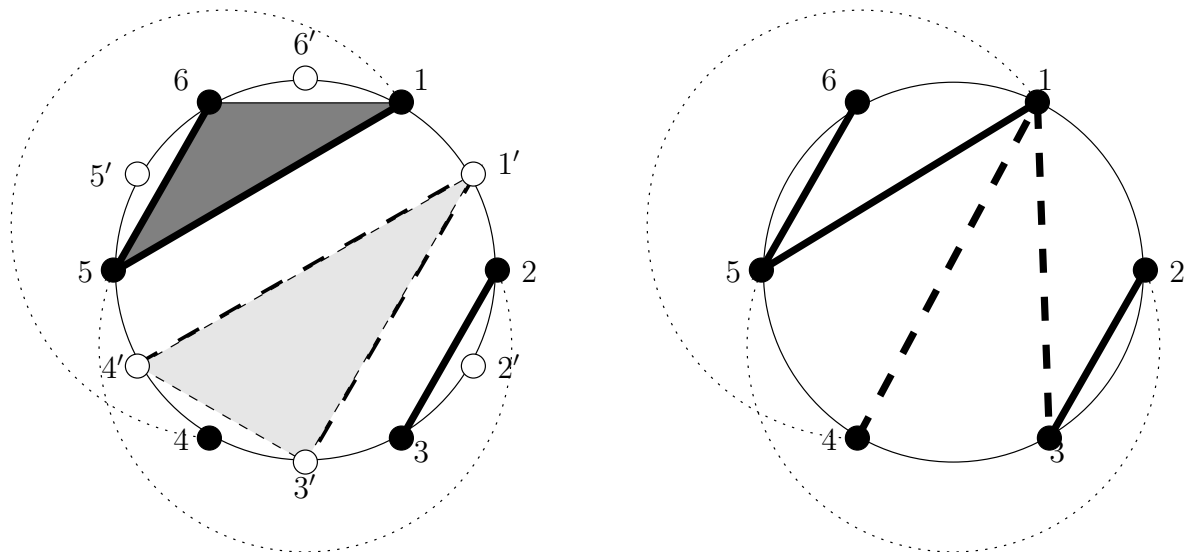

FIGURE 8. The hypermap (σ, α) with $\sigma = (1, 4)(2, 5)(3)(6)$, $\alpha = (1, 2, 3, 4, 5, 6)$, $\gamma^{-1} = (1, 5, 6)(2, 3)(4)$ and $\delta^{-1} = (1, 3, 4)(2)(5)(6)$.

At this point it is useful to recall the visualization of the Kreweras dual, as introduced in [19]. The left hand side of Figure 8 contains an illustration for a genus 1 hypermap which, for simplicity's sake contains a single hyperedge $\alpha_1 = (1, 2, 3, 4, 5, 6)$. We draw these on a circle in the clockwise order and represent the cycles of γ_1^{-1} on these points. For each point p we also introduce a new point p' immediately after p in the clockwise order. The Kreweras dual of a noncrossing partition is the coarsest noncrossing partition on the new points whose parts do not intersect the parts of the original noncrossing partition. For a general hypermap we repeat this representation for each α_i . Now we may take a tree on each cycle of γ_i , respectively δ_i thus represented, and conclude by

referring to Lemma 4.8. In Figure 8 the selected hypercontractions are marked with bold solid lines and the hyperdeletions with bold dashed lines. The resulting admissible tree is shown on the right hand side of Figure 8. \square

The proof of Theorem 4.9 contains the proof of the following, stronger statement:

Proposition 4.10. *Let (σ, α) be a hypermap, let G be a deletion-contraction graph for it, and let T be an admissible spanning tree of G . Let γ be the permutations obtained by the transpositions marking the edges of T composed in such an order that each cycle of α transpositions incident to the same point are performed in the cyclic order of α . Let $\delta = \alpha^{-1}\gamma^{-1}$. Then there is a deletion-contraction process whose underlying graph of transpositions is G , the transpositions underlying the hypercontractions are the edges of T , and hypercontractions, respectively hyperdeletions belonging to the same cycle of γ , respectively δ are performed consecutively.*

Let us call the deletion-contraction processes described Proposition 4.10 *canonical*.

Unfortunately, it seems unlikely that activities could be associated to the hyperdeletions and hypercontractions in a way that their statistics would be independent of the ordering of these operations. Consider the example shown in Figure 9. This is the hypermap (σ, α) with $\sigma = (1, 4)(2, 5)(3)$ and $\alpha = (1, 2, 3)(4, 5)$.

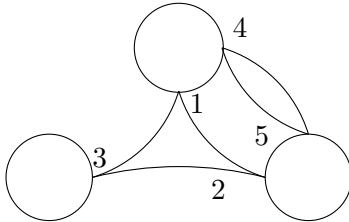

FIGURE 9. Hypermap of genus zero with two hyperedges

This hypermap has two hyperedges and three spanning hypertrees (σ, γ^{-1}) , the possible values of γ^{-1} are $(1, 2, 3)(4)(5)$, $(1)(2, 3)(4, 5)$ and $(1, 3)(2)(4, 5)$. In two of these spanning hypertrees the edge $(4, 5)$ is contracted, in one of them it is deleted. If we try to replicate Tutte's proof swapping two adjacent edge labels, and creating a bijection between spanning trees, in the hypertree version we would need to match both hypertrees with $(4, 5)$ contracted to the only hypertree with $(4, 5)$ deleted. There is no such bijection. If we refine the picture to deletion-contraction processes, the only spanning hypertree with a cycle of length 3 gives rise to three maps, whereas each of the other two spanning hypertrees gives rise to only one map each. A Tutte style bijection remains elusive.

5. DELETION-CONTRACTION FORMULAS COUNTING SPANNING HYPERTREES

Let $M = (\sigma, \alpha)$ be a map and $e = (i, j)$ one of its edges. It is well known that the number of spanning trees of M is equal to the number of spanning trees of the map $M' = (\sigma, \alpha(i, j))$ obtained by deleting e plus the number of spanning trees of the map $M'' = ((i, j)\sigma, (i, j)\alpha)$ obtained by contracting e . It is understood that deleting e is not allowed if this disconnects the map (in this case M' is not a map, as σ and $\alpha(i, j)$ do not

generate a transitive permutation group), and contracting (i, j) is not allowed if (i, j) is a loop (and generates a non-topological contraction). The justification is very simple: the spanning trees of M' are exactly the spanning trees of M not containing the edge (i, j) , and the spanning trees $((i, j)\sigma, \theta')$ of M'' correspond bijectively to those spanning trees (σ, θ) of M which contain the edge (i, j) , via the correspondence $\theta' = (i, j)\theta$.

The obvious generalization of this result does not hold for counting spanning hypertrees of a hypermap, as the following example shows. Consider the hypermap (σ, α) shown in Figure 9 and the transposition $(1, 2)$. The hyperdeletion of $(1, 2)$ gives the hypermap $(\sigma, \alpha(1, 2))$ where $\alpha(1, 2) = (1, 3)(2)(4, 5)$. This hypermap has only one spanning hypertree $(\sigma, (1, 3)(4, 5))$. The hypercontraction of $(1, 2)$ gives the hypermap $((1, 2)\sigma, (1, 2)\alpha)$ where $(1, 2)\sigma = (1, 4, 2, 5)(3)$ and $(1, 2)\alpha = (1)(2, 3)(4, 5)$, which has the only spanning hypertree $((1, 2)\sigma, (2, 3)(4)(5))$. However, as noted at the end of the last section, the hypermap (σ, α) shown in Figure 9 has three hypertrees.

Hyperdeletions and hypercontractions still remain useful tools in describing the set of spanning genus g unicellular hypermaps of a hypermap, because of the next two results.

Proposition 5.1. *Let $H = (\sigma, \alpha)$ be a hypermap and let i, j be two points belonging to the same cycle of α . Let g be any nonnegative integer. If $H' = (\sigma, \alpha(i, j))$ obtained by applying the hyperdeletion (i, j) , is a hypermap then its spanning genus g unicellular hypermaps form a subset of the set of all spanning genus g unicellular hypermaps of H : this subset contains only spanning genus g unicellular hypermaps (σ, θ) for which i and j belong to different cycles of θ .*

Proof. Let (σ, θ) be a spanning genus g unicellular hypermap of H' . Clearly (σ, θ) is a genus g unicellular hypermap. In order to check that it is a spanning genus g unicellular hypermap of H one has to prove that θ is a refinement of α . This holds since θ is a refinement of $\alpha(i, j)$ and i, j being in the same cycle of α , the permutation $\alpha(i, j)$ is a refinement of α . \square

Remark 5.2. Regarding the interpretation of Proposition 5.1 one should note that $H' = (\sigma, \alpha(i, j))$ may not be a hypermap, because the permutation group generated by σ and $\alpha(i, j)$ may not be transitive. This also happens when we delete an isthmus in a map. Furthermore (i, j) may induce a non-topological hyperdeletion, which will decrease the genus. If g is the genus of H then none of the spanning genus g unicellular hypermaps of H will be a spanning genus g unicellular hypermaps of a hypermap H' obtained by a non-topological hyperdeletion. That said, the genus of a unicellular hypermap (σ, θ) does not change if we change the hypermap in which it is a spanning unicellular hypermap.

Regarding hypercontractions we have the following analogous result.

Proposition 5.3. *Let $H = (\sigma, \alpha)$ be a hypermap and let i, j be two points belonging to the same cycle of α . Assume that the hypercontraction of (i, j) in H does not disconnect H : it results in the hypermap $H'' = ((i, j)\sigma, (i, j)\alpha)$. Then the spanning unicellular hypermaps of H'' are all hypermaps of the form $((i, j)\sigma, (i, j)\theta)$ where (σ, θ) is any spanning unicellular hypermap of H satisfying that i and j belong to the same cycle of θ . Here $g((i, j)\sigma, (i, j)\theta) = g(\sigma, \theta)$ if i and j belong to different cycles of σ and $g((i, j)\sigma, (i, j)\theta) = g(\sigma, \theta) - 1$ otherwise.*

Proof. Note first that the only situation when the hypercontraction of (i, j) may disconnect H is when i and j belong to the same cycle of σ and no spanning unicellular hypermap (σ, θ) of H contains i and j on the same cycle of θ . Indeed, only a non-topological hypercontraction may disconnect hypermap. Assume by way of contradiction that i and j belong to the same cycle of θ for some spanning unicellular hypermap (σ, θ) . The hypercontraction of (i, j) takes (σ, θ) into $((i, j)\sigma, (i, j)\theta)$ which is a unicellular hypermap since $((i, j)\theta)^{-1}(i, j)\sigma = \theta^{-1}\sigma$ is a circular permutation. Since (i, j) disconnects θ , the permutation $(i, j)\theta$ refines $(i, j)\alpha$, hence $((i, j)\sigma, (i, j)\alpha)$ is also a hypermap.

Let $((i, j)\sigma, \theta')$ be a genus g unicellular hypermap of H'' . The points i, j must belong to different cycles of θ' as this permutation is a refinement of $(i, j)\alpha$ which contains i and j on different cycles. Hence $\theta = (i, j)\theta'$ has i and j on the same cycle. If i and j belong to different cycles of σ , then they also belong to the same cycle of $(i, j)\sigma$ and the map $(\sigma, \theta) \mapsto ((i, j)\sigma, (i, j)\alpha)$ is a topological hypercontraction, not changing the number of faces, nor the genus. If i and j belong to the same cycle of σ and hence to different cycles of $(i, j)\sigma$ then the map $(\sigma, \theta) \mapsto ((i, j)\sigma, (i, j)\alpha)$ is a non-topological hypercontraction decreasing the genus by one. \square

Theorem 5.4. *Let $H = (\sigma, \alpha)$ a hypermap such that $(1, 2, \dots, m)$ is a cycle of α . If $m \geq 2$ and $g \geq 0$ then the set of all spanning genus g unicellular hypermaps (σ, θ) of H is the disjoint union of the following sets S_1, S_2, \dots, S_m :*

- (1) S_1 is the set of all spanning genus g unicellular hypermaps of $H_1 = (\sigma, \alpha(1, m))$, obtained by the hyperdeletion of $(1, m)$ in H . We set $S_1 = \emptyset$ if the hyperdeletion of $(1, m)$ disconnects H .
- (2) Let $H_2 = ((1, 2)\sigma, (1, 2)\alpha)$ be the hypermap obtained by applying the hypercontraction of $(1, 2)$ to H . We set $S_2 = \emptyset$ if the hypercontraction of $(1, 2)$ disconnects H . Otherwise S_2 is the set of all spanning genus g unicellular hypermaps of the form $(\sigma, (1, 2)\theta')$ where $((1, 2)\sigma, \theta')$ is any spanning genus g (genus $g - 1$) unicellular hypermap of H_2 if the hypercontraction of $(1, 2)$ is topological (non-topological).
- (3) For $k = 3, \dots, m$ we set $H_k = ((1, k)\sigma, (1, k)\alpha(1, k-1))$, obtained by applying the hyperdeletion of $(1, k-1)$ and the hypercontraction $(1, k)$ in H . We set $S_k = \emptyset$ if the hyperdeletion of $(1, k-1)$ and the hypercontraction $(1, k)$ disconnect H . Otherwise S_k is the set of all genus g unicellular hypermaps $(\sigma, (1, k)\theta')$, where $((1, k)\sigma, \theta')$ is any spanning genus g (genus $g - 1$) unicellular hypermap of the hypermap H_k if the hypercontraction of $(1, k)$ is topological (non-topological).

Proof. Given a spanning genus g unicellular hypermap (σ, θ) of H we define $\phi(\theta) = 1$ if 1 is a fixed point of θ and as the second smallest element of the cycle of θ containing 1 otherwise. We show for all k that (σ, θ) belongs to the set S_k if and only if $\phi(\theta) = k$. For this purpose let us describe the hyperedges of the hypermaps H_1, H_2, \dots, H_m . Since all hyperdeletions and hypercontractions involve points on the cycle $(1, 2, \dots, m)$ of α , only hyperedges contained in the set $\{1, 2, \dots, m\}$ are different in the hypermaps obtained by our hyperdeletions and hypercontractions.

For $k = 1$, we have

$$(1, 2, \dots, m)(1, m) = (1)(2, 3, \dots, m).$$

Any element of S_1 must satisfy $\phi(\theta) = 1$. Conversely, if 1 is a fixed point of θ then the spanning genus g unicellular hypermap (σ, θ) is also a spanning genus g unicellular hypermap of H_1 by Proposition 5.1.

By Proposition 5.3, the spanning genus g unicellular hypermap (σ, θ) belongs to S_2 if and only if 1 and 2 belong to the same cycle of θ , which is equivalent to $\phi(\theta) = 2$.

For $k \geq 3$ we have

$$(1, k)(1, 2, \dots, m)(1, k-1) = (1)(k, k+1, \dots, m)(2, 3, \dots, k-1).$$

Any spanning unicellular hypermap $((1, k)\sigma, \theta')$ of H_k must satisfy that θ' is a refinement of the above permutation, hence the cycles of θ' containing the elements $2, 3, \dots, k-1$ can not contain 1 or k . The permutation $\theta = (1, k)\theta'$ has then 1 and k on the same cycle, but the elements $2, 3, \dots, k-1$ are still not on this cycle, forcing $\phi(\theta) = k$. Conversely, if we have $\phi(\theta) = k$ then θ is a refinement of

$$(1, 2, \dots, m)(1, k-1) = (1, k, k+1, \dots, m)(2, 3, \dots, k-1)$$

hence (σ, θ) is a spanning unicellular hypermap of $(\sigma, \theta(1, k-1))$ by Proposition 5.1 and 1 and k are on the same cycle of θ , hence Proposition 5.3 is applicable. Note finally that for $k \geq 2$ the stated relations between $g(\sigma, \theta)$ and $g((1, k)\sigma, \theta')$ are direct consequences of Proposition 5.3. \square

Corollary 5.5. *If H has at least one nontrivial hyperedge, we may use Theorem 5.4 to write the number of its spanning genus g unicellular hypermaps as the sum of the numbers of spanning genus g and genus $g-1$ unicellular hypermaps of at most m smaller hypermaps. Here m is the size of the smallest nontrivial hyperedge in H .*

Remark 5.6. We may use Theorem 5.4 to find the number of spanning hypertrees of the hypermap H presented in Example 2.4. We may apply the theorem to the cycles $\alpha_1 = (1, 2, 3)$, $\alpha_2 = (4, 5, 6)$ and $\alpha_3 = (7, 8, 9)$ independently: let us denote by H_{i_1, i_2, i_3} the hypermap obtained by considering the case i_j for the cycle α_j . Note that H_{i_1, i_2, i_3} is isomorphic to H_{i_2, i_3, i_1} since the operation $x \mapsto x + 3$ (modulo 9) on the set of points is an automorphism of H . If the list (i_1, i_2, i_3) contains more than one copy of 2 or 3 then H_{i_1, i_2, i_3} is obtained by using at least one non-topological contraction, and may be disregarded. $H_{1,1,1}$ is not a hypermap: it is disconnected. The hypermaps $H_{1,1,2}$, $H_{1,2,1}$ and $H_{2,1,1}$ are maps consisting of 3 parallel edges between two vertices, whereas $H_{1,1,3}$, $H_{1,3,1}$ and $H_{3,1,1}$ are maps consisting of 2 parallel edges between two vertices. Finally, all 6 hypermaps of the form H_{i_1, i_2, i_3} with no repeated index are hypermonopoles. We obtain that the number of spanning hypertrees of H is $3 \times 3 + 3 \times 2 + 6 \times 1 = 21$.

Remark 5.7. The refinements of the cycle $(1, 2, \dots, m)$, ordered by the refinement relation, form a poset that is isomorphic to the lattice of noncrossing partitions on the set $\{1, 2, \dots, m\}$. Since α contains the cycle $(1, 2, \dots, m)$, every spanning genus g unicellular hypermap (σ, θ) has the property that each cycle of θ acts on a set that is either contained in or disjoint from the set $\{1, 2, \dots, m\}$. The answer to the question whether (σ, θ) belongs to S_k only depends on the cycles of θ acting on the set $\{1, 2, \dots, m\}$. Remarkably (σ, θ) belongs to S_k if and only if the noncrossing partition corresponding to the cycles of θ acting on the set $\{1, 2, \dots, m\}$ belongs to the set R_k defined by Simion and Ullman [26, Theorem 2] as an aid to recursively construct a symmetric chain decomposition of the noncrossing partition lattice.

Remark 5.8. For spanning hypertrees the classes S_1, S_2, \dots, S_m may be visualized as follows. Let us represent the cycle $(1, 2, \dots, m)$ of α in this cyclic order on the boundary of a disc, and let us also represent the vertex tour of the spanning hypertree with a dotted curve as shown in Figure 10. The class S_1 contains those spanning hypertrees whose vertex tour cuts out the point 1 from the hyperedge, leaving the points $2, 3, \dots, m$ on the outside. For $k \geq 2$ the class S_k contains exactly those spanning hypertrees whose vertex tour contains the points 1 and k inside the tour (that is, on the side containing the spanning hypertree) and leaves the points $2, 3, \dots, k-1$ of the hyperedge on the outside. Nothing can be assumed regarding the points $k+1, k+2, \dots, m$. In a way, the index k of the set S_k determines “which way we turn” when the vertex tour arrives near the point 1.

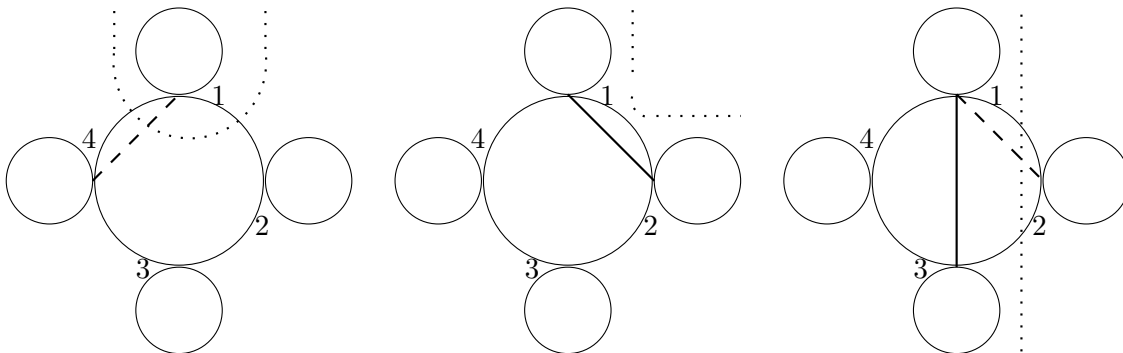

FIGURE 10. A local image of the vertex tour for the classes S_1, S_2 , and S_3 in the case when $m = 4$.

6. SEMIMEANDERS, MEANDERS AND RECIPROCAL OF MONOPOLES AND BIPOLES

Definition 6.1. For each integer $m \geq 0$ we define the monopole with m nested edges as the hypermap, whose vertex permutation is $(2, 4, \dots, 2m, 2m-1, 2m-3, \dots, 3, 1)$ and whose edge permutation is the involution $(1, 2)(3, 4) \dots (2m-1, 2m)$. For each $m \in \{\frac{1}{2}, \frac{3}{2}, \frac{5}{2}, \dots\}$ we define the monopole with m nested edges as the hypermap, whose vertex permutation is $(2, 4, \dots, 2m-1, 2m, 2m-2, \dots, 3, 1)$ and whose edge permutation is the involution $(1, 2)(3, 4) \dots (2m-2, 2m-1)(2m)$.

The reciprocal of a monopole with 2.5, respectively 3, nested edges may be seen in Figure 11, respectively 12 below. Note that we may think of the loop (3) in Figure 11 as a “half of an edge”.

Theorem 6.2. The number of semimeanders of order n equals the number of spanning hypertrees of the reciprocal of a monopole with $n/2$ nested edges.

Proof. We prove the theorem by showing that there is a bijection between the set of spanning hypertrees of the reciprocal of a monopole with $n/2$ nested edges and the set of foldings of $n-1$ stamps defined in Section 1.2. Introducing $m = \lfloor n/2 \rfloor$, we have $n = 2m + 1$ if n is odd and $n = 2m$ if n is even.

If n is odd, then the reciprocal of the monopole with $n/2$ nested edges is (σ, α) where

$$\begin{aligned}\sigma &= (1, 2)(3, 4) \cdots (2m - 1, 2m)(2m + 1) \quad \text{and} \\ \alpha &= (2, 4, \dots, 2m, 2m + 1, 2m - 1, 2m - 3, \dots, 3, 1).\end{aligned}$$

Figure 11 below is an example of the case when $n = 5$. Note that the faces of our hy-

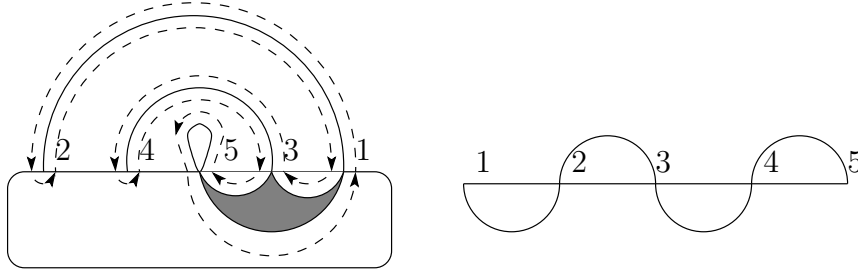

FIGURE 11. Spanning hypertree of a reciprocal monopole with 2.5 nested edges and the corresponding stamp folding

permap are given by $\alpha^{-1}\sigma = (1)(2, 3)(4, 5) \cdots (2m, 2m + 1)$. To any spanning hypertree θ of (σ, α) we associate the one line representation described in Proposition 2.5. On the right hand side of Figure 11 we see the one line representation associated to the spanning hypertree $\theta = (1, 5, 3)(2)(4)$. This corresponds to $\theta^{-1}\sigma = (1, 2, 3, 4, 5)$, we list the points on the line in this order. Above the line we see the faces $\alpha^{-1}\sigma$ of our hypermap, below the line we see the vertices σ . Note that the union of the set of non-singleton cycles of $\alpha^{-1}\sigma$ and of σ are all two-cycles of the form $(i, i + 1)$ for $\leq i \leq n - 1$. This union is a disjoint union, the two-cycles with an even smaller element belong to $\alpha^{-1}\sigma$, the others belong to σ . Hence we obtain the diagram of a stamp folding.

A similar bijection may be constructed when n is even. In this case we have

$$\begin{aligned}\sigma &= (1, 2)(3, 4) \cdots (2m - 1, 2m) \quad \text{and} \\ \alpha &= (2, 4, \dots, 2m, 2m - 1, 2m - 3, \dots, 3, 1).\end{aligned}$$

Figure 12 below is an example of the case when $n = 6$.

In this case we have $\alpha^{-1}\sigma = (1)(2, 3)(4, 5) \cdots (2m - 1, 2m - 1)(2m)$. The example in Figure 12 represents the spanning hypertree $\theta = (1)(2, 4)(3, 6)(5)$ and we have $\theta^{-1}\sigma = (1, 4, 6, 5, 3, 2)$. Once again the one line representation described in Proposition 2.5 is a stamp folding diagram. \square

Definition 6.3. We define the dipole with n parallel edges as the map whose vertex permutation is $(1, 3, 5, 2n - 1)(2n, 2n - 2, \dots, 4, 2)$ and whose edges are $(2n, 1)(2, 3)(4, 5) \cdots (2n - 2, 2n - 1)$.

Theorem 6.4. The number of meanders of order n equals the number of spanning hypertrees of the reciprocal of a dipole with n parallel edges.

Proof. The proof is analogous to the proof of Theorem 6.2. The reciprocal hypermap $\sigma\alpha$ is given by

$$\sigma = (2n, 1)(2, 3)(4, 5)(2n - 2, 2n - 1) \quad \text{and} \quad \alpha = (1, 3, \dots, 2n - 1)(2n, 2n - 2, \dots, 4, 2).$$

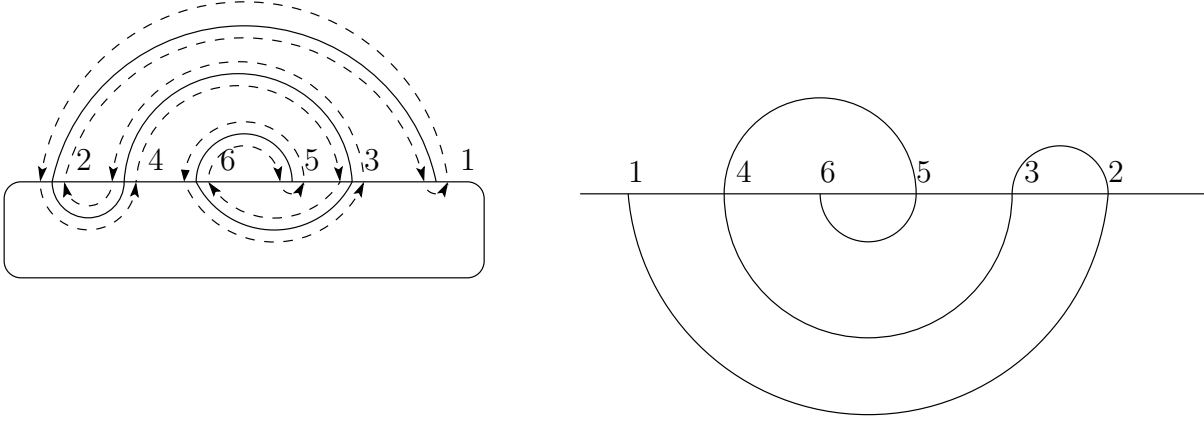

FIGURE 12. Spanning hypertree of a reciprocal monopole with 3 nested edges and the corresponding stamp folding

Note that we have $\alpha^{-1}\sigma = (1, 2)(3, 4) \dots (2n - 1, 2n)$.

An example of the reciprocal of a dipole with 4 parallel edges is shown in Figure 13.

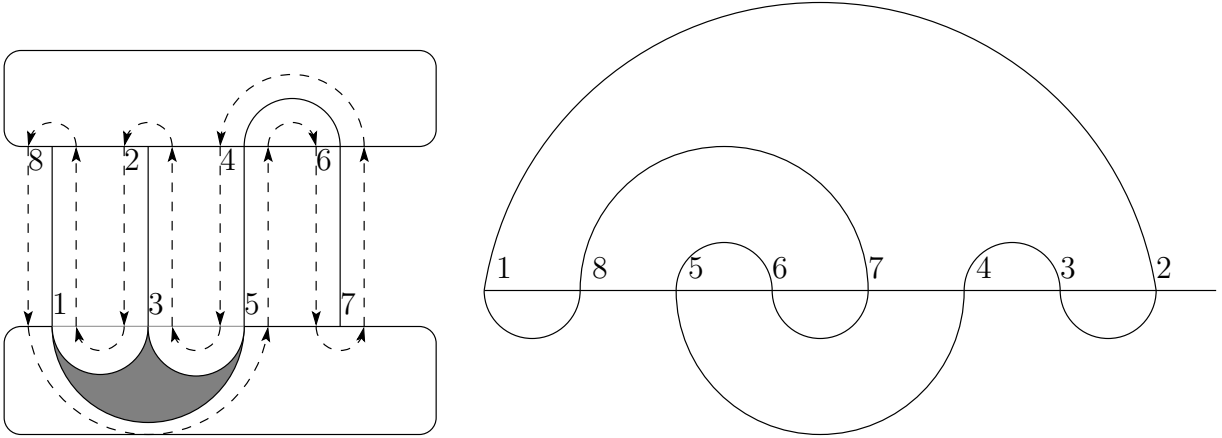

FIGURE 13. Spanning hypertree of a reciprocal dipole with 4 parallel edges and the corresponding meander

The example in the figure represents the spanning hypertree $\theta = (1, 3, 5)(2)(4, 6)(7)(8)$, yielding $\theta^{-1}\sigma = (1, 8, 5, 6, 7, 4, 3, 2)$. \square

Remark 6.5. Since any spanning hypertree θ of (σ, α) is a refinement of α , a permutation with two cycles of the same size, we may think of each spanning hypertree as a pair of noncrossing partitions on the same n -element set. This identification is easier to visualize if we relabel $2i + 1$ as i for $1 \leq i \leq n - 1$, relabel 1 as n , and relabel $2i$ as i' for $1 \leq i \leq n$. We then obtain

$$\sigma = (1, 1')(2, 2')(3, 3')(n, n') \quad \text{and} \quad \alpha = (1, 2, \dots, n)(n', (n - 1)', \dots, 1').$$

Each cycle of θ contains either labels from the set $\{1, \dots, n\}$ or from the set $\{1', \dots, n'\}$. The cycles of θ contained in $\{1, \dots, n\}$ must form a noncrossing partition, represented

in the usual way, and the cycles of θ contained in $\{1', \dots, n'\}$ must form a noncrossing partition, represented with cycles in the reverse order compared to the usual way. Thus we arrive precisely at the representation first developed by Franz [11]. The structure of this representation was further studied and utilized in [12] and in [13].

7. SPANNING HYPERTREES OF RECIPROALS OF MAPS

In this section we generalize the construction of Franz [11] defining labeled plane trees representing meanders to define labeled plane trees representing spanning hypertrees of the reciprocal of a map. Our construction is illustrated with the map and a spanning hypertree of its reciprocal shown in Figure 14.

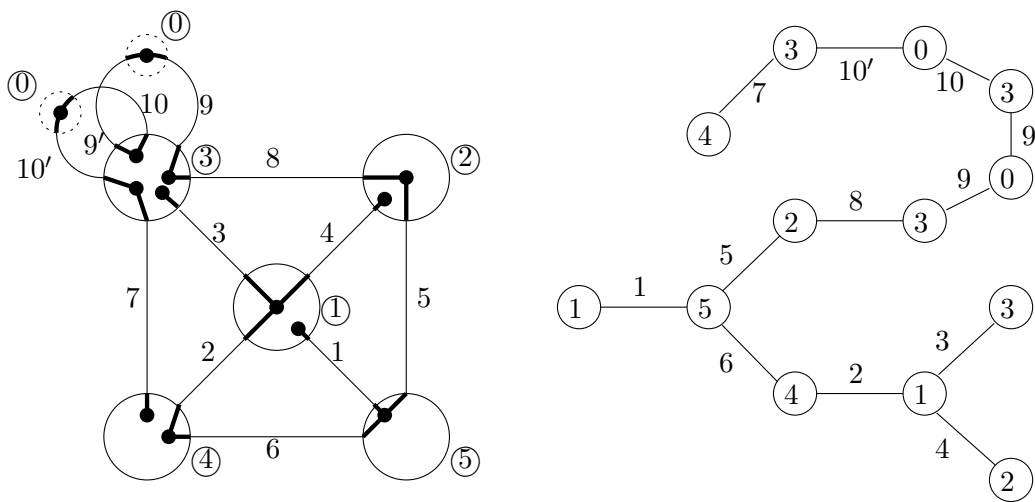

FIGURE 14. A map and a spanning hypertree of its reciprocal

Given a map (σ, α) , we number its vertices (these numbers are circled in Figure 14) and we number its edges. Furthermore, for each loop edge (that is, a 2-cycle of α , whose points belong to the same cycle of σ) whose number is i we also associate a duplicate label i' . Thanks to this duplication, every point of the map may be uniquely described by the ordered pair (i, j) where i is the label of the vertex and j is the label of the edge containing it. For example, after identifying each point with its pair of labels, cycle number 3 of σ is $((3, 7), (3, 3), (3, 8), (3, 9), (3, 10), (3, 9'), (3, 10'))$, cycle number 5 of α is $((2, 5), (5, 5))$ and cycle number 9 of α is $((3, 9), (3, 9'))$.

Definition 7.1. We call a numbering of vertices and edges of a map, together with the labeling of its points as defined above a vertex-edge labeling of the map.

Next we fix a spanning hypertree (α, θ) of the reciprocal hypermap (α, σ) . The permutation θ is a refinement of the permutation σ : for each cycle of σ , the cycles of θ contained in it form a genus zero permutation. For example the cycles of θ contained in the first cycle of σ form the permutation $((1, 1), (1, 2), (1, 4), (1, 3))$. We associate a *center* to each cycle of θ and to each loop edge of α : these are small black disks in Figure 14. Note that the dotted circles around the centers of the loop edges of α are *not* vertices of our map (σ, α) , but they will become vertices in the associated tree on the

right hand side. We connect each center to the points on its cycle (of θ or α , shown in bold). By merging the edges connecting the centers to the points on their cycles with the edges of our map, we obtain a graph on the centers. For example, in Figure 14 we connect the center of the cycle $((1, 2), (1, 4), (1, 3))$ to the point $(1, 2)$, we continue this edge using the cycle $((1, 2), (4, 2))$ of α to the point $(4, 2)$ and then we continue to the center of the cycle $((4, 2)(4, 6))$. The resulting topological graph is shown on the right hand side of Figure 14. We label the center of each loop edge of α with 0, and we label all other centers with the number of the cycle of σ containing the cycle of θ containing the center. Note that the second coordinates of all points on an edge connecting two centers are the same: we label the edge connecting two centers with this coordinate. The map we see in Figure 14 is a *coherently* (σ, α) -labeled plane tree. We explain its definition in several steps.

Definition 7.2. *Given a map (σ, α) with a vertex-edge labeling, a (σ, α) -labeled map (σ', α') is a map with numbered vertices and edges, subject to the following rules:*

- (1) *Each vertex of (σ', α') is either labeled with zero or it is labeled with the first coordinate of a point in the vertex-edge labeling of (σ, α) . The same label may appear on several vertices of (σ', α') .*
- (2) *The set of edge labels of (σ', α') is the set of the second coordinates of the points in the vertex-edge labeling (σ, α) . Each edge label appears exactly once.*
- (3) *The vertices labeled 0 of (σ', α') have degree 2 and they correspond to the set of loop edges of (σ, α) bijectively: if j is the label of a loop edge in (σ, α) then there is exactly one vertex labeled 0 of (σ', α') that is incident to a pair of edges labeled j and j' respectively.*

Alternatively, using Definition 3.3, we may describe (σ, α) -labeled maps as follows.

Proposition 7.3. *The map (σ', α') is a (σ, α) -labeled map if and only if its underlying graph may be obtained from the underlying graph of (σ, α) by subdividing each loop edge into two edges and then applying several vertex splitting operations (as defined in Definition 3.3) that never split the newly introduced subdividing vertices.*

Indeed, the vertices of (σ', α') that were added as vertices subdividing the loop edges are labeled with zero, each other vertex of (σ', α') is labeled with the number of the vertex of (σ, α) that was split (possibly several times) to obtain it). The edges of (σ', α') are identifiable with the edges of (σ, α) after subdividing each loop edge of (σ, α) into two edges. Each vertex of (σ', α') of color $i > 0$ is a cyclic permutation acting on a subset of points moved by cycle number i of σ and the collection of all such cyclic permutations of the same color $i > 0$ is a permutation of all points moved by cycle number i of σ .

Definition 7.4. *Given a map (σ, α) with a vertex-edge labeling and a (σ, α) -labeled map (σ', α') , we call the (σ, α) -labeling coherent if for each vertex label $i > 0$, the cycles forming the set of vertices of color i in σ' form a refinement of the unique cycle numbered i in σ .*

In the case when the (σ, α) -labeled map (σ', α') is a tree (of genus 0), we may draw it in the plane in such a way that for each vertex of σ' of positive color the incident edges listed in the counterclockwise order mark the corresponding points in the order of the

cycle of σ' . We call the resulting plane tree corresponding to a coherently (σ, α) -labeled map a *coherently (σ, α) -labeled plane tree*.

Theorem 7.5. *For a map (σ, α) , there is a bijection between its spanning hypertrees and the coherently (σ, α) -labeled plane trees.*

Proof. Let the map (σ', α') be a coherently (σ, α) -labeled plane tree. Note that the edge set of α' is obtained by subdividing each loop edge in α into two edges, and the requirement of coherence is equivalent to requiring that the restriction σ'' of σ' to the set of the original points must be a refinement of σ . Conversely, for any refinement σ'' of σ , we may introduce a center to each cycle of σ'' , a center to each loop edge of (σ, α) and create a labeled topological graph using the procedure described at the beginning of this section. We only need to show that (α, σ'') is a hypertree if and only if the map (σ', α') is a tree. The hypermap (α, σ'') is a hypertree if and only if $z(\sigma''^{-1}\alpha) = 1$. The map (σ', α') is a tree if and only if $z(\alpha'^{-1}\sigma') = z(\sigma'^{-1}\alpha') = 1$. The statement is now a consequence of the fact that $\sigma'^{-1}\alpha'$ may be computed from $\sigma''^{-1}\alpha$ by replacing $(\dots i\sigma''^{-1}(j)\dots)$ with $(\dots ip_{i,j}\sigma''^{-1}(j)\dots)$ for each loop edge (i, j) in α . Here $p_{i,j}$ is the midpoint inserted in (i, j) to obtain α' . \square

Theorem 7.5 and its justification have the following consequence.

Corollary 7.6. *The spanning hypertrees of the reciprocal (α, σ) of a map (σ, α) are the reciprocals of all trees obtained from (σ, α) by a sequence of topological vertex splittings.*

Corollary 7.6 inspires considering the generation of the spanning hypertrees of the reciprocal of a map by a sequence of topological vertex splittings. Using this approach, the key move presented in the work of Franz and Earnshaw [13] may be generalized as follows. Let (σ, α) be a map and consider a spanning hypertree of its reciprocal, represented as a coherently (σ, α) -labeled plane tree (σ', α') . Take two vertices of the same color, representing adjacent blocks of σ' that can be merged and still have a noncrossing partition. For example, we may merge the two vertices of color 1 of the plane tree shown in Figure 14 in such a way that the edges around the only vertex of color 1 are listed $(1, 4, 3, 2)$ in the counterclockwise order. The resulting plane graph has a unique cycle. In our example, this cycle is a triangle with vertices of color 1, 4, 5, and edges labeled 1, 2, and 6. We may obtain another plane tree representing a spanning hypertree by performing a topological vertex splitting that breaks this cycle without disconnecting the graph. For example we may replace the unique cycle $((5, 1), (5, 6), (5, 5))$ of color 5 with the pair of cycles $((5, 1), (5, 6))((5, 5))$ or with the pair of cycles $((5, 1))((5, 6), (5, 5))$. (We cannot use $((5, 1), (5, 5)), ((5, 6))$ as the resulting plane graph would still contain a cycle and the edge $((5, 1), (1, 1))$ would be disconnected from the rest of the graph. This *reciprocal tree flipping* is analogous to replacing a spanning tree T with the spanning tree $T - \{f\} \cup \{e\}$ where e is an edge external to T and f belongs to the unique cycle contained in $T \cup \{e\}$. Franz and Earnshaw [13] apply this idea to maps with 2 vertices and n parallel (non-intersecting) edges, and they call the operation a *reduction* if it merges the first block of the first vertex with the block containing the first point not in the first block and then splits the first available block in some order that breaks the cycle. It is not hard to see that the idea of this reduction map may be generalized to the reciprocal of an arbitrary map. Using some ordering on the points, the reduction map

becomes well-defined, its inverse is not unique but has been useful in the constructive enumeration of meanders.

A remarkable consequence of Theorem 7.5 is that for loopless maps with vertices of degree at most three the number of spanning hypertrees of the reciprocal only depends on the underlying graph and not on the cyclic order of the edges around the vertices.

Corollary 7.7. *Let (σ, α) be a map such that each cycle of σ has length at most 3 and each cycle of α has length 2, containing points of two different cycles of σ . Let $G = (V, E)$ be a graph whose vertices are the cycles of σ and whose edges are bijectively labeled with the cycles of α in such a way that the edge labeled (i, j) connects the vertices containing the points i and j respectively. Then the spanning hypertrees of the reciprocal hypermap (α, σ) are in bijection with all labeled trees T having the following properties:*

- (1) *The edges of T are bijectively labeled with the edge set E .*
- (2) *Each vertex of T is labeled with a vertex of G .*
- (3) *The vertex labeling is a proper coloring: no two vertices of T of the same vertex label are adjacent.*
- (4) *The set of edge labels of all edges incident to some vertex labeled with $v \in V$ is the set of all edges incident to v in G .*

Indeed, by Theorem 7.5, the spanning hypertrees of (α, σ) are in bijection with (σ, α) -labeled plane trees in which each vertex has degree at most 3. The criteria stated in Corollary 7.7 match the definition of a (σ, α) -labeled plane tree, except there is no topological restriction on the order of the edges around the vertices. These restrictions have no meaning for vertices of degree one or two, neither on the (α, σ) side nor on the plane tree side. For each vertex $v \in V$ of degree 3, there are two possible cyclic orientations of the edges around the vertex. This orientation becomes irrelevant if there is more than one vertex labeled v in T . Otherwise exactly one cyclic orientation of the edges incident to the unique v -colored vertex in T satisfies the definition of the (σ, α) -labeling. On the other hand, for any tree in which the maximum degree is three, each planar embedding of the tree may be uniquely described by choosing a cyclic orientation around each vertex of degree three, and these choices may be made independently.

ACKNOWLEDGMENTS

The authors are indebted to two anonymous referees for the very careful reading of this manuscript and many valuable suggestions. The second author wishes to express his heartfelt thanks to Labri, Université Bordeaux I, for hosting him as a visiting researcher in Summer 2019, when this research was started. This work was partially supported by a grant from the Simons Foundation (#514648 to Gábor Heteyei).

REFERENCES

- [1] O. Bernardi, A characterization of the Tutte polynomial via combinatorial embeddings, *Ann. Comb.* **12** (2008), 139–153.
- [2] O. Bernardi, Tutte polynomial, subgraphs, orientations and sandpile model: new connections via embeddings, *Electron. J. Combin.* **15** (2008), Research Paper 109, 53 pp.
- [3] O. Bernardi, T. Kalman and A. Postnikov, Universal Tutte polynomial, preprint 2020, arXiv:2004.00683 [math.CO].
- [4] R. Cori, “Un code pour les Graphes Planaires et ses applications,” *Asterisque* **27** (1975).

- [5] R. Cori, Codage d'une carte plane et hyperarbres recouvrants, Colloques Internat. C.N.R.S, Orsay (1976).
- [6] R. Cori and A. Machì, Su alcune proprietà del genere di una coppia di permutazioni, *Boll. Un. Mat. Ital.* (5) 18-A (1981), 84–89.
- [7] R. Cori and J-G. Penaud, The complexity of a planar hypermap and that of its dual, *Ann. Discrete Math.* **9** (1980), 53–62.
- [8] P. Eades and C. F. X. de Mendonça Neto, Vertex splitting and tension-free layout, Graph drawing (Passau, 1995), 202–211, Lecture Notes in Comput. Sci., 1027, Springer, Berlin, 1996.
- [9] P. Flajolet and R. Sedgewick, Analytic combinatorics, Cambridge University Press, Cambridge, 2009.
- [10] P. Di Francesco, O. Golinelli and E. Guitter, Meander, folding, and arch statistics, Combinatorics and physics (Marseilles, 1995), *Math. Comput. Modelling* **26** (1997), 97–147.
- [11] R.O.W. Franz, A partial order for the set of meanders, *Ann. Comb.* **2** (1998), 7–18.
- [12] R.O.W. Franz, On the representation of meanders, *Bayreuth. Math. Schr.* (2003), 163–201.
- [13] R.O.W. Franz and B.A. Earnshaw, A constructive enumeration of meanders, *Ann. Comb.* **6** (2002), 7–17.
- [14] I. Goulden and A. Yong, Tree-like properties of cycle factorizations, *J. Combin. Theory Ser. A* **98** (2002), 106–117.
- [15] A. Jacques, Sur le genre d'une paire de substitutions, *C. R. Acad. Sci. Paris* **267** (1968), 625–627.
- [16] T. Kálmán, A version of Tutte's polynomial for hypergraphs, *Adv. Math.* **244** (2013), 823–873.
- [17] T. Kálmán and A. Postnikov, Root polytopes, Tutte polynomials, and a duality theorem for bipartite graphs, *Proc. Lond. Math. Soc.* (3) **114** (2017), 561–588.
- [18] T. Kálmán and L. Tóthmérész, Hypergraph polynomials and the Bernardi process, *Algebr. Comb.* **3** (2020), 1099–1139.
- [19] G. Kreweras, Sur les partitions non croisées d'un cycle, *Discrete Math.* **1** (1972), 333–350.
- [20] M. LaCroix, Approaches to the enumerative theory of meanders, Masters Essay, University of Waterloo, Waterloo, Ontario, Canada, 2003. <https://www.math.uwaterloo.ca/~malacroix/Latex/Meanders.pdf>.
- [21] S. Legendre, Foldings and meanders, *Australas. J. Combin.* **58** (2014), 275–291.
- [22] W. F. Lunnon, A map-folding problem, *Math. Comp.* **22** (1968), 193–199.
- [23] A. Machì, On the complexity of a hypermap, *Discrete Math.* **42** (1982), 221–226.
- [24] N.J.A. Sloane, "On-Line Encyclopedia of Integer Sequences," <http://www.research.att.com/~njas/sequences>
- [25] P. Rosenstiehl, Planar permutations defined by two intersecting Jordan curves, Graph theory and combinatorics (Cambridge, 1983), 259–271, Academic Press, London, 1984.
- [26] R. Simion and D. Ullman, On the structure of the lattice of noncrossing partitions, *Discrete Math.* **98** (1991), 193–206.
- [27] J. Touchard, Contribution à l'étude du problème des timbres poste, *Canad. J. Math.* **2** (1950), 385–398.
- [28] W. T. Tutte, Duality and trinity. Infinite and finite sets (Colloq., Keszthely, 1973; dedicated to P. Erdős on his 60th birthday), Vol. III, pp. 1459–472. Colloq. Math. Soc. János Bolyai, Vol. 10, North-Holland, Amsterdam, 1975.

LABRI, UNIVERSITÉ BORDEAUX 1, 33405 TALENCE CEDEX, FRANCE.
 WWW: <http://www.labri.fr/perso/cori/>.

DEPARTMENT OF MATHEMATICS AND STATISTICS, UNC CHARLOTTE, CHARLOTTE NC 28223-0001. WWW: <http://webpages.uncc.edu/ghetyei/>.