

F -RATIONALITY OF TWO-DIMENSIONAL GRADED RINGS WITH A RATIONAL SINGULARITY

KOHISUKE SHIBATA

ABSTRACT. It is known that a two-dimensional F -rational ring has a rational singularity. However a two-dimensional ring with a rational singularity is not F -rational in general. In this paper, we investigate F -rationality of a two-dimensional graded ring with a rational singularity in terms of the multiplicity. Moreover, we determine when a two-dimensional graded ring with a rational singularity and a small multiplicity is F -rational.

1. INTRODUCTION

It is well known by now that there is an interesting connection between F -singularities and singularities in birational geometry. In [8], Hara and Watanabe showed that a strongly F -regular ring has log terminal singularities and an F -pure ring has log canonical singularities. In [15], Smith showed that an F -rational ring has pseudo-rational singularities. Therefore a two-dimensional excellent F -rational ring has a rational singularity. However two-dimensional excellent ring with a rational singularity is not F -rational in general. Thus a natural question is when rings with rational singularities are F -rational.

In [7], Hara and Watanabe investigated F -rationality of a two-dimensional graded ring with a rational singularity in terms of Pinkham-Demazure construction and gave the necessary and sufficient condition for F -rationality of a two-dimensional graded ring with a rational singularity.

In April 2020, Kei-ichi Watanabe asked the author the following question.

Question 1.1. Let $D = \sum_{i=1}^r \frac{c_i}{d_i} P_i$ be an ample \mathbb{Q} -divisor on \mathbb{P}_k^1 , where $c_i \in \mathbb{Z}$, $d_i \in \mathbb{N}$ and P_i are distinct points of \mathbb{P}_k^1 . Let $R = \bigoplus_{n \geq 0} H^0(\mathbb{P}_k^1, \mathcal{O}_{\mathbb{P}_k^1}([nD]))t^n$. Assume that R has a rational singularity and $d_i > p$ for all i . Then is R F -rational?

In this paper, we give an affirmative answer to this question.

Theorem 1.2. *Let $D = \sum_{i=1}^r \frac{c_i}{d_i} P_i$ be an ample \mathbb{Q} -divisor on \mathbb{P}_k^1 , where $c_i \in \mathbb{Z}$, $d_i \in \mathbb{N}$ and P_i are distinct points of \mathbb{P}_k^1 . Let $R = \bigoplus_{n \geq 0} H^0(\mathbb{P}_k^1, \mathcal{O}_{\mathbb{P}_k^1}([nD]))t^n$. Assume that R has a rational singularity and p does not divide any d_i . Then R is F -rational. In particular, Question 1.1 is affirmative.*

In [6], Hara proved that a two-dimensional log terminal singularity is strongly F -regular if the characteristic is larger than 5. This implies that a two-dimensional

2020 *Mathematics Subject Classification.* 13A35, 14J17, 13A02.

Key words and phrases. F -rational rings, rational singularities, graded rings.

rational double point is F -rational if the characteristic is larger than 5. In this paper, we investigate F -rationality of a two-dimensional graded ring with a rational singularity in terms of the multiplicity. We prove the following theorem.

Theorem 1.3. *Let $m \in \mathbb{N}$. There exists a positive integer $p(m)$ such that R is F -rational for any two-dimensional graded ring R with a rational singularity, $e(R) = m$ and $R_0 = k$, an algebraically closed field of characteristic $p \geq p(m)$.*

Moreover, we can determine $p(3)$ and $p(4)$ in the above theorem.

Theorem 1.4. *Let R be a two-dimensional graded ring with a rational singularity.*

- (1) *If $e(R) = 3$ and $p \geq 7$, then R is F -rational.*
- (2) *If $e(R) = 4$ and $p \geq 11$, then R is F -rational.*

Furthermore, these inequalities are best possible.

The paper is organized as follows. In Section 2, we review definitions and some facts on F -rational rings, rational singularities and Pinkham-Demazure construction. In Section 3, we investigate F -rationality of a two-dimensional graded ring with a rational singularity in terms of Pinkham-Demazure construction and give an affirmative answer to Question 1.1. In Section 4, we prove Theorem 1.3. In Section 5, we classify two-dimensional graded rings with a rational singularity and multiplicity 3 and 4 in terms of Pinkham-Demazure construction. In Section 6, we determine $p(3)$ and $p(4)$ in Theorem 1.3.

Acknowledgement. The author would like to thank Kei-ichi Watanabe for the discussion and many suggestions. The author are grateful to Alessandro De Stefani and Ilya Smirnov for insightful conversations and comments on a rough draft of this paper. The author is partially supported by JSPS KAKENHI Grant Number JP20J00132.

Conventions. Throughout this paper, p is a prime number and k is an algebraically closed field of characteristic p . We assume that a ring is essentially of finite type over k . By a graded ring, we mean a ring $R = \bigoplus_{n \geq 0} R_n$, which is finitely generated over the subring $R_0 = k$.

2. PRELIMINARIES

In this section we introduce definitions and some facts on F -rational rings, rational singularities and Pinkham-Demazure construction.

2.1. F -rational rings and rational singularities. In this subsection we introduce the definitions of F -rational rings and rational singularities.

Definition 2.1. Let R be a ring and I an ideal of R . The tight closure I^* of I is defined by $x \in I^*$ if and only if there exists $c \in R^\circ$ such that $cx^{p^e} \in I^{[p^e]}$ for $e \gg 0$, where R° is the set of elements of R which are not in any minimal prime ideal and $I^{[p^e]}$ is the ideal generated by the p^e -th powers of the elements of I . We say that I is tightly closed if $I^* = I$.

Definition 2.2. A local ring (R, \mathfrak{m}) is F -rational if every parameter ideal is tightly closed. An arbitrary ring R is F -rational if $R_{\mathfrak{m}}$ is F -rational for every maximal ideal \mathfrak{m} .

Definition 2.3. A local ring (R, \mathfrak{m}) is F -injective if R -module homomorphism

$$H_{\mathfrak{m}}^i(F) : H_{\mathfrak{m}}^i(R) \rightarrow H_{\mathfrak{m}}^i(R)$$

is injective for all i . An arbitrary ring R is F -injective if $R_{\mathfrak{m}}$ is F -injective for every maximal ideal \mathfrak{m} .

Definition 2.4. Let R be a two-dimensional normal ring, and let $f : Y \rightarrow X := \text{Spec}(R)$ be a resolution of singularities. The ring R is said to be (or have) a rational singularity if $R^1 f_* \mathcal{O}_Y = 0$.

Remark 2.5. It is known that there exists a resolution of singularity even in positive characteristic for any two-dimensional excellent normal ring (see e.g. [13]).

2.2. Hirzebruch-Jung Continued fraction. In this subsection, we introduce the definition and basic properties of the Hirzebruch-Jung continued fraction.

Definition 2.6. Let a_1, a_2, \dots, a_n be real numbers. We denote by $[[a_1, \dots, a_n]]$ the Hirzebruch-Jung continued fraction:

$$[[a_1, \dots, a_n]] := a_1 - \frac{1}{a_2 - \frac{1}{a_3 - \frac{1}{\dots - \frac{1}{a_n}}}}$$

Lemma 2.7. Let m, n be positive integers with $m < n$, and let a_1, \dots, a_n be real numbers. Then we have

$$[[a_1, \dots, a_n]] = [[a_1, \dots, a_m, [[a_{m+1}, \dots, a_n]]]]$$

Proof. This follows directly from the definition. □

Lemma 2.8. Let a_1, \dots, a_n be positive integers with $\min\{a_1, \dots, a_n\} \geq 2$. Then

$$[[a_1, \dots, a_n]] > 1.$$

Proof. We prove this by induction on n . If $n = 1$, then $[[a_1]] = a_1 > 1$. If $n > 1$, then

$$[[a_1, \dots, a_n]] = [[a_1, [[a_2, \dots, a_n]]]] > a_1 - 1 \geq 1$$

by Lemma 2.7. □

Lemma 2.9. Let $a_1, \dots, a_l, b_1, \dots, b_m, c_1, \dots, c_n$ be positive integers with $b_1 < c_1$ and $\min\{a_1, \dots, a_l, b_1, \dots, b_m, c_1, \dots, c_n\} \geq 2$. Then

- (1) $[[a_1, \dots, a_l, b_1, \dots, b_m]] < [[a_1, \dots, a_l]]$.
- (2) $[[a_1, \dots, a_l, b_1, \dots, b_m]] < [[a_1, \dots, a_l, c_1, \dots, c_n]]$.

Proof. (1) By Lemma 2.7 and Lemma 2.8, we have

$$[[a_1, \dots, a_l, b_1, \dots, b_m]] < [[a_1, \dots, a_l, N]] = [[a_1, \dots, a_l - \frac{1}{N}]] < [[a_1, \dots, a_l]]$$

for a positive integer $N > [[b_1, \dots, b_m]] > 1$.

(2) By Lemma 2.7, it is enough to prove that

$$[[b_1, \dots, b_m]] < [[c_1, \dots, c_n]].$$

By Lemma 2.7, Lemma 2.8 and Lemma 2.9.(1), we have

$$[[b_1, \dots, b_m]] \leq b_1 \leq c_1 - 1 < [[c_1, [[c_2, \dots, c_n]]]] = [[c_1, \dots, c_n]].$$

□

We denote by $(2)^l$ the sequence obtained by repeating l times the number 2.

Example 2.10. Let l be a positive integer. Then we have

$$[[(2)^l]] = \frac{l+1}{l}.$$

Indeed, if $[[(2)^n]] = \frac{n+1}{n}$ holds for $n \in \mathbb{N}$, we have

$$[[(2)^{n+1}]] = [[2, (2)^n]] = [[2, \frac{n+1}{n}]] = 2 - \frac{n}{n+1} = \frac{n+2}{n+1}.$$

Example 2.11. $2 = [[2]] < [[3, (2)^l]] = 3 - \frac{l}{l+1}$ for any $l \in \mathbb{Z}_{\geq 0}$.

2.3. Pinkham-Demazure construction. In this subsection we introduce the construction of a two-dimensional normal graded ring using a \mathbb{Q} -divisor on a smooth curve. By a \mathbb{Q} -divisor on a variety X , we mean a \mathbb{Q} -linear combination of codimension-one irreducible subvarieties of X . If $D = \sum a_i D_i$, where $a_i \in \mathbb{Q}$ and D_i are distinct irreducible subvarieties, we set $[D] = \sum [a_i] D_i$, where $[a]$ denotes the greatest integer less than or equal to a .

In [14], Pinkham proved the following result. In [1], Demazure generalized this result in higher dimensional case.

Theorem 2.12 ([1],[14]). *Let R be a two-dimensional normal graded ring over $R_0 = k$. Then there exists an ample \mathbb{Q} -divisor D on $C = \text{Proj}(R)$ such that*

$$R \cong R(C, D) := \bigoplus_{n \geq 0} H^0(C, \mathcal{O}_C([nD]))t^n.$$

We call this representation Pinkham-Demazure construction.

Remark 2.13. (1) A divisor D on a smooth curve is ample if and only if $\deg D > 0$ (see [9, IV.Corollary 3.3]).

(2) Let D_1, D_2 be ample \mathbb{Q} -divisors on a smooth curve C . If $D_1 - D_2$ is a principal divisor on C , then $R(C, D_1) \cong R(C, D_2)$. Indeed, let f be the rational function on C with $\text{div}(f) = D_1 - D_2$, and let g be a rational function on C with $\text{div}(g) + nD_1 \geq 0$. Then $\text{div}(f^n g) + nD_2 = \text{div}(g) + nD_1 \geq 0$. Therefore we have an isomorphism $R(C, D_1) \cong R(C, D_2)$ defined by $gt^n \mapsto f^n gt^n$.

- (3) If $C = \mathbb{P}_k^1$, we can put $D = sP_0 - \sum_{i=1}^r a_i P_i$ in Theorem 2.12, where $s \in \mathbb{N}$ and $a_i \in \mathbb{Q}_{>0}$ with $0 < a_i < 1$, and P_i are distinct points of \mathbb{P}_k^1 . Indeed, since P is linearly equivalent to Q for any points P, Q of \mathbb{P}_k^1 by [9, II.Proposition 6.4], this remark holds by the above remark.

A resolution of a singularity is said to be good if the exceptional divisor has normal crossing and each irreducible components of the exceptional divisor is smooth. A resolution of a surface singularity is called a minimal good resolution if the resolution is the smallest resolution of good resolutions, i.e. every good resolution factors through a minimal good resolution. An exceptional divisor E of the minimal good resolution of a two-dimensional singularity is said to be a central curve if E has positive genus or E meets at least three other exceptional divisors of the minimal good resolution. The dual graph of the minimal good resolution is said to be star-shaped if the dual graph has at most one central curve.

In [14], Pinkham determined the exceptional set of the minimal good resolution of $\text{Spec}(R(\mathbb{P}_k^1, D))$.

Theorem 2.14 ([14]). *Let $D = sP_0 - \sum_{i=1}^r \frac{c_i}{d_i} P_i$ be an ample \mathbb{Q} -divisor on \mathbb{P}_k^1 , where $s, c_i, d_i \in \mathbb{N}$ with $0 < c_i < d_i$, and P_i are distinct points of \mathbb{P}_k^1 . Let b_{i1}, \dots, b_{im_i} be positive integers with $\frac{d_i}{c_i} = [[b_{i1}, \dots, b_{im_i}]]$. Then the exceptional set of the minimal good resolution of $\text{Spec}(R(\mathbb{P}_k^1, D))$ consists of*

- (1) unique central curve $E_0 \cong \mathbb{P}_k^1$ with $E_0^2 = -s$ and
- (2) r branches of \mathbb{P}_k^1 's $E_{i1} - E_{i2} - \dots - E_{im_i}$ corresponding to P_i with $E_{ij}^2 = -b_{ij}$ and $E_0 E_{i1} = 1$.

Thus the dual graph is star-shaped as follows:

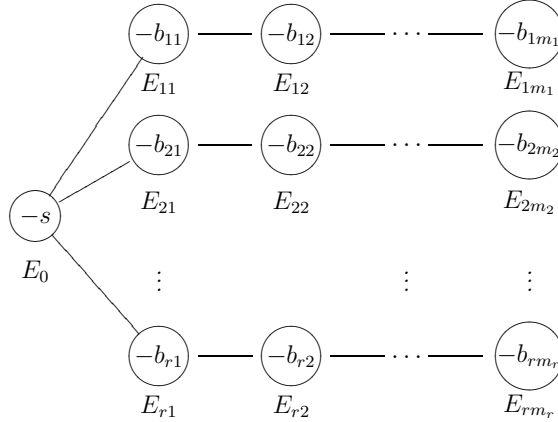

Definition 2.15. Let (R, \mathfrak{m}) be a d -dimensional normal graded ring. The a -invariant $a(R)$ of R is defined by

$$a(R) := \max \{ n \in \mathbb{Z} \mid [H_{\mathfrak{m}}^d(R)]_n \neq 0 \},$$

where $[H_{\mathfrak{m}}^d(R)]_n$ denotes the n -th graded piece of the highest local cohomology module of $H_{\mathfrak{m}}^d(R)$.

Theorem 2.16 is a very useful characterization of a rational singularity.

Theorem 2.16 ([14, Corollary 5.8],[5, Korollary 3.10],[16, Theorem 2.2]). *Let C be a smooth curve, D an ample \mathbb{Q} -divisor on C and $R = R(C, D)$. Then the following conditions are equivalent.*

- (1) R has a rational singularity.
- (2) $C = \mathbb{P}_k^1$ and $\deg[nD] \geq -1$ for any positive integer n .
- (3) $a(R) < 0$.

Lemma 2.17. *Let $D = sP_0 - \sum_{i=1}^r \frac{c_i}{d_i} P_i$ be an ample \mathbb{Q} -divisor on \mathbb{P}_k^1 , where $s, c_i, d_i \in \mathbb{N}$ with $0 < c_i < d_i$, and P_i are distinct points of \mathbb{P}_k^1 . If $s + 2 \leq r$, then $R(\mathbb{P}_k^1, D)$ does not have a rational singularity.*

Proof. Since $\deg[D] = s - r \leq -2$, $R(\mathbb{P}_k^1, D)$ does not have a rational singularity by Theorem 2.16. \square

In [10], Hochster and Huneke gave a necessary and sufficient condition for a graded ring to be F -rational.

Theorem 2.18 ([10, Theorem 7.12]). *Let R be a two-dimensional normal graded ring. Then R is F -rational if and only if R is F -injective and $a(R) < 0$.*

2.4. Fundamental cycle. In this subsection, we introduce the definition and useful properties of the fundamental cycle.

Let (X, x) be a two-dimensional normal singularity, and let $f : Y \rightarrow X$ be a resolution of singularity. We denote by $\text{Exc}(f)$ the exceptional set of f . We call the minimum element of the set

$$\left\{ Z \in \text{Div}(Y) \setminus \{0\} \mid \begin{array}{l} \text{Supp}(Z) \subset \text{Exc}(f) \text{ and } ZE \leq 0 \\ \text{for any prime exceptional divisor } E \text{ of } f \end{array} \right\}.$$

the fundamental cycle of f . For an exceptional divisor D on Y , we denote by $p_a(D) := \frac{D^2 + K_Y D}{2} + 1$ and call it the virtual genus of D .

Proposition 2.19. *Let R be a two-dimensional local ring with a rational singularity, $f : X \rightarrow \text{Spec}(R)$ the minimal good resolution and E_1, \dots, E_r the prime exceptional divisors of f . Let $Z = \sum_{i=1}^r n_i E_i$ be the fundamental cycle of f . Then*

$$e(R) = -Z^2 = \sum_{i=1}^r n_i (-E_i^2 - 2) + 2.$$

Proof. We can compute Z by a computation sequence of cycles

$$0 < Z_1 < \dots < Z_s = Z$$

defined by $Z_1 = F_1$ (we can take any prime exceptional divisor of f) and $Z_i = Z_{i-1} + F_i$, where F_i is any prime exceptional divisor f with $Z_{i-1}F_i > 0$ (see for example [11, Proposition 7.2.4]). Then we have

$$p_a(Z_i) = p_a(Z_{i-1}) + p_a(F_i) + Z_{i-1}F_i - 1 \geq p_a(Z_{i-1})$$

$$\text{and } Z_i^2 = Z_{i-1}^2 + 2Z_{i-1}F_i + F_i^2$$

since $p_a(F_i) \geq 0$ by [11, Proposition 7.2.8]. Since $p_a(Z) = 0$ by [11, Proposition 7.3.1], we have $p_a(F_i) = 0$ and $Z_{i-1}F_i = 1$ for all i . Hence we have

$$e(R) = -Z^2 = \sum_{i=1}^r n_i(-E_i^2 - 2) + 2.$$

by [11, Proposition 7.3.5]. □

Remark 2.20. Note that the dual graph of the minimal good resolution of a two-dimensional rational singularity does not have a (-1) -curve since the minimal resolution of a two-dimensional rational singularity is the minimal good resolution. Indeed, we have $p_a(F_i) = 0$ and $Z_{i-1}F_i = 1$ in the above proof, which implies that all irreducible components of the exceptional set have to be smooth rational curves, pairwise intersecting transversally in at most one point (see [11, Proposition 7.2.8. (ii)]).

Once we have the coefficient of the central curve of the fundamental cycle of the minimal good resolution of $\text{Spec}(R(\mathbb{P}_k^1, D))$, the fundamental cycle can be computed by the following formula.

For a divisor $D = \sum_{i=1}^r a_i E_i$, where E_i is a prime divisor, we denote by $\text{Coeff}_{E_i} D$ the coefficient a_i . For a real number a , we denote by $\lceil a \rceil$ the smallest integer greater than or equal to a .

Lemma 2.21. *Let $D = sP_0 - \sum_{i=1}^r \frac{c_i}{d_i} P_i$ be an ample \mathbb{Q} -divisor on \mathbb{P}_k^1 , where $s, c_i, d_i \in \mathbb{N}$ with $0 < c_i < d_i$, and P_i are distinct points of \mathbb{P}_k^1 . Let $f : X \rightarrow \text{Spec}(R(\mathbb{P}_k^1, D))$ be the minimal good resolution. Let F be a non-zero effective divisor on X with $\text{Supp}(F) \subset \text{Exc}(f)$ and n_0 the coefficient of the central curve E_0 on F . Let $E_{i1} - E_{i2} - \dots - E_{im_i}$ be the branch of \mathbb{P}_k^1 's corresponding to P_i such that*

$$\frac{d_i}{c_i} = \lceil [b_{i1}, b_{i2}, \dots, b_{im_i}] \rceil,$$

$E_{ij}^2 = -b_{ij}$ and $E_0 E_{i1} = 1$. Define $e_{i1}, \dots, e_{im_i} \in \mathbb{Q}$ by

$$e_{ij} = \lceil [b_{ij}, b_{i,j+1}, \dots, b_{im_i}] \rceil.$$

We assume that the coefficient n_{ij} of E_{ij} on F is given inductively,

$$n_{i1} = \left\lceil \frac{n_0}{e_{i1}} \right\rceil = \left\lceil \frac{n_0 c_i}{d_i} \right\rceil, \dots, n_{i,j+1} = \left\lceil \frac{n_{ij}}{e_{i,j+1}} \right\rceil, \dots, n_{im_i} = \left\lceil \frac{n_{i,m_i-1}}{e_{im_i}} \right\rceil.$$

Then F is the smallest element of the set

$$\left\{ G \in \text{Div}(X) \setminus \{0\} \left| \begin{array}{l} \text{Supp}(G) \subset \text{Exc}(f), \text{Coeff}_{E_0} G = n_0 \\ \text{and } GE \leq 0 \text{ for any prime exceptional} \\ \text{divisor } E \text{ of } f \text{ with } E \neq E_0 \end{array} \right. \right\}.$$

Moreover if n_0 is equal to the coefficient of the central curve of the fundamental cycle of f , then F is the the fundamental cycle.

Proof. The statement follows from [12, Lemma 1.1]. □

Corollary 2.22. *Let $D = sP_0 - \sum_{i=1}^r \frac{c_i}{d_i} P_i$ be an ample \mathbb{Q} -divisor on \mathbb{P}_k^1 , where $s, c_i, d_i \in \mathbb{N}$ with $0 < c_i < d_i$, and P_i are distinct points of \mathbb{P}_k^1 . Let Z be the fundamental cycle of the minimal good resolution of $\text{Spec}(R(\mathbb{P}_k^1, D))$, and let E_0 be the central curve of the minimal good resolution. Then*

$$\text{Coeff}_{E_0} Z = \min\{n \in \mathbb{N} \mid \deg[nD] \geq 0\}.$$

In particular, if $s + 1 \leq r$, then

$$\text{Coeff}_{E_0}(Z) \geq 2.$$

Proof. Let $f : X \rightarrow \text{Spec}(R(\mathbb{P}_k^1, D))$ be the minimal good resolution. For $l \in \mathbb{N}$, let F_l be the smallest element of the set

$$\left\{ G \in \text{Div}(X) \setminus \{0\} \left| \begin{array}{l} \text{Supp}(G) \subset \text{Exc}(f), \text{Coeff}_{E_0} G = l \\ \text{and } GE \leq 0 \text{ for any prime exceptional} \\ \text{divisor } E \text{ of } f \text{ with } E \neq E_0 \end{array} \right. \right\}.$$

Then we have

$$F_l E_0 = -ls + \sum_{i=1}^r \left\lfloor \frac{lc_i}{d_i} \right\rfloor = -\deg[lD]$$

for $l \in \mathbb{N}$ by Lemma 2.21. Let n_0 be the coefficient of E_0 in Z . Then $F_{n_0} = Z$ by Lemma 2.21. Therefore

$$n_0 = \min\{n \in \mathbb{N} \mid \deg[nD] \geq 0\}.$$

If $s + 1 \leq r$, then $\deg[D] \leq -1$. Therefore we have $\text{Coeff}_{E_0}(Z) \geq 2$. \square

3. F -RATIONALITY OF $R(\mathbb{P}_k^1, D)$

In this section, we investigate F -rationality of a two-dimensional graded ring with a rational singularity in terms of Pinkham-Demazure construction and give an affirmative answer to Question 1.1.

The following criterion for F -rationality is given in [7].

Theorem 3.1 ([7, Theorem 2.9]). *Let D be an ample \mathbb{Q} -divisor on \mathbb{P}_k^1 and $R = R(\mathbb{P}_k^1, D)$. Let $B_n = -p[-nD] + [-pnD]$ for a positive integer n , and let $(B_n)_{\text{red}}$ be the reduced divisor with the same support as B_n . Assume that R has a rational singularity. Then R is F -rational if and only if for every positive integer n , we have*

$$\deg[-pnD] + \deg(B_n)_{\text{red}} \leq 1.$$

Remark 3.2. Let $D = \sum_{i=1}^r a_i P_i$ with $a_i \in \mathbb{Q}$. Then

$$\deg(B_n)_{\text{red}} \leq \#\{i \mid na_i \notin \mathbb{Z}\}.$$

In general, $\deg(B_n)_{\text{red}} \neq \#\{i \mid na_i \notin \mathbb{Z}\}$. For example, if $p = 2$ and $D = \frac{2}{3}P$, then $\deg(B_1)_{\text{red}} = 0$ and $\#\{i \mid a_i \notin \mathbb{Z}\} = 1$.

Proposition 3.3. *Let $D = sP_0 - \sum_{i=1}^r \frac{c_i}{d_i} P_i$ be an ample \mathbb{Q} -divisor on \mathbb{P}_k^1 , where $s, c_i, d_i \in \mathbb{N}$ with $0 < c_i < d_i$, and P_i are distinct points of \mathbb{P}_k^1 .*

- (1) *If $s \geq r$, then $R(\mathbb{P}_k^1, D)$ is F -rational.*
- (2) *If $R(\mathbb{P}_k^1, D)$ has a rational singularity and is not F -rational, then $s + 1 = r$.*

- (3) If $R(\mathbb{P}_k^1, D)$ has a rational singularity, $\deg D \geq 1$ and $p \geq r - 1$, then $R(\mathbb{P}_k^1, D)$ is F -rational.

Proof. Let $B_n = -p[-nD] + [-pnD]$ for a positive integer n .

(1) Since $\deg[nD] \geq 0$ for any positive integer n , $R(\mathbb{P}_k^1, D)$ has a rational singularity by Theorem 2.16. Note that $\deg[-pnD] \leq -s$ and $\deg(B_n)_{\text{red}} \leq r$ for any positive integer n . Therefore $R(\mathbb{P}_k^1, D)$ is F -rational by Theorem 3.1.

(2) This statement follows from Lemma 2.17 and Proposition 3.3.(1).

(3) Since $\deg[-pnD] \leq \deg(-pnD) \leq -pn$ and $\deg(B_n)_{\text{red}} \leq r$ for any positive integer n , $R(\mathbb{P}_k^1, D)$ is F -rational by Theorem 3.1. \square

Example 3.4. Let $D = 2P_0 - \frac{1}{3}(P_1 + P_2 + P_3)$, where P_i are distinct points of \mathbb{P}_k^1 . Then $R(\mathbb{P}_k^1, D)$ is F -rational for all p . Indeed, since $\deg[nD] \geq -1$ for any positive integer n , $R(\mathbb{P}_k^1, D)$ has a rational singularity by Theorem 2.16. Therefore $R(\mathbb{P}_k^1, D)$ is F -rational by Proposition 3.3.(3).

Watanabe asked the following question.

Question 3.5. Let $D = \sum_{i=1}^r \frac{c_i}{d_i} P_i$ be an ample \mathbb{Q} -divisor on \mathbb{P}_k^1 , where $c_i \in \mathbb{Z}$, $d_i \in \mathbb{N}$ and P_i are distinct points of \mathbb{P}_k^1 . Let $R = R(\mathbb{P}_k^1, D)$. Assume that R has a rational singularity and $d_i > p$ for all i . Then is R F -rational?

Theorem 3.6. Let $D = \sum_{i=1}^r \frac{c_i}{d_i} P_i$ be an ample \mathbb{Q} -divisor on \mathbb{P}_k^1 , where $c_i \in \mathbb{Z}$, $d_i \in \mathbb{N}$ and P_i are distinct points of \mathbb{P}_k^1 . Let $R = R(\mathbb{P}_k^1, D)$. Assume that R has a rational singularity and p does not divide any d_i . Then R is F -rational. In particular, Question 3.5 is affirmative.

Proof. We assume that R is not F -rational. Then there exists a positive integer m such that

$$\deg[-pmD] + \deg(B_m)_{\text{red}} \geq 2,$$

where $B_m = -p[-mD] + [-pmD]$ by Theorem 3.1. Since R has a rational singularity, we have for every positive integer n ,

$$\deg[nD] \geq -1$$

by Theorem 2.16. Let $l = \#\{i \in \mathbb{N} \mid \frac{mc_i}{d_i} \notin \mathbb{Z}\}$. Then we have

$$\left\lfloor \frac{pmc_j}{d_j} \right\rfloor - \left\lceil \frac{pmc_j}{d_j} \right\rceil = 1$$

for $j \in \{i \in \mathbb{N} \mid \frac{mc_i}{d_i} \notin \mathbb{N}\}$ and $\deg(B_m)_{\text{red}} \leq l$ (see Remark 3.2). We have

$$\begin{aligned} \deg[-pmD] &= \sum_{i=1}^r \left\lfloor -\frac{pmc_i}{d_i} \right\rfloor = -\sum_{i=1}^r \left\lceil \frac{pmc_i}{d_i} \right\rceil = -l - \sum_{i=1}^r \left\lfloor \frac{pmc_i}{d_i} \right\rfloor \\ &= -l - \deg[pmD] \leq -l + 1. \end{aligned}$$

Hence we have

$$2 \leq \deg[-pmD] + \deg(B_m)_{\text{red}} \leq -l + 1 + l = 1,$$

which is a contradiction. Therefore R is F -rational. \square

4. F -RATIONALITY OF TWO-DIMENSIONAL GRADED RINGS WITH A RATIONAL SINGULARITY

In this section we show that for a positive integer m , any two-dimensional graded ring with multiplicity m and a rational singularity is F -rational if the characteristic of the base field is sufficiently large depending on m .

An irreducible curve E on a smooth surface is called a $(-i)$ -curve if $E \cong \mathbb{P}_k^1$ with $E^2 = -i$.

Definition 4.1. Let R be a two-dimensional normal ring and i a positive integer. We define $C_i(R)$ to be the number of $(-i)$ -curves in the exceptional set of the minimal good resolution of $\text{Spec}(R)$.

Definition 4.2. Let a be a rational number with $a > 1$. Let $a = [[b_1, \dots, b_m]]$ be the Hirzebruch-Jung continued fraction of a and $n = \#\{i \mid b_i = 2\}$. Let $\{j_1, j_2, \dots, j_{m-n}\}$ be the set of numbers such that $b_{j_l} \neq 2$ and $j_l < j_{l+1}$. We define $T(a) = (b_{j_1}, b_{j_2}, \dots, b_{j_{m-n}}) \in \mathbb{N}^{m-n}$ if $m \neq n$, and $T(a) = \emptyset$ if $m = n$.

Example 4.3. $T([[2, 3, 2, 4, 2, 2, 5]]) = (3, 4, 5)$.

Lemma 4.4. For any positive integer l , let $D_l = sP_0 - \sum_{i=1}^r \frac{c_i^{(l)}}{d_i^{(l)}} P_i$ be an ample \mathbb{Q} -divisor on \mathbb{P}_k^1 , where $s, c_i^{(l)}, d_i^{(l)} \in \mathbb{N}$ with $0 < c_i^{(l)} < d_i^{(l)}$, and P_i are distinct points of \mathbb{P}_k^1 . We assume that $\frac{c_i^{(l)}}{d_i^{(l)}} \leq \frac{c_i^{(l+1)}}{d_i^{(l+1)}}$ for any i, l and $\lim_{l \rightarrow \infty} \frac{c_i^{(l)}}{d_i^{(l)}} \in \mathbb{Q}$ for any i . Let c_i, d_i be positive integers with $\frac{c_i}{d_i} = \lim_{l \rightarrow \infty} \frac{c_i^{(l)}}{d_i^{(l)}}$. Let $D = sP_0 - \sum_{i=1}^r \frac{c_i}{d_i} P_i$. Assume $R(\mathbb{P}_k^1, D_l)$ has a rational singularity for any l . For any positive integer n , let $B_n^l = -p[-nD_l] + [-pnD_l]$ and $B_n = -p[-nD] + [-pnD]$ and let $(B_n^l)_{\text{red}}$ and $(B_n)_{\text{red}}$ be the reduced divisor with the same support as B_n^l and B_n , respectively.

(1) We have

$$\deg[nD] = sn - \sum_{i=1}^r \left\lceil \frac{nc_i}{d_i} \right\rceil \geq -1$$

for any positive integer n . In particular, if $\deg D > 0$, then $R(\mathbb{P}_k^1, D)$ has a rational singularity.

(2) If p does not divide any d_i , then

$$\deg[-pnD] + \deg(B_n)_{\text{red}} \leq 1$$

for any positive integer n .

(3) If $p > d_i$ for any i , then

$$\deg[-pnD_l] + \deg(B_n^l)_{\text{red}} \leq \deg[-pnD] + \deg(B_n)_{\text{red}}$$

for any positive integer n and any sufficiently large number l .

Proof. (1) If the lemma fails, then there exists a positive integer m such that

$$\deg[mD] = sm - \sum_{i=1}^r \left\lceil \frac{mc_i}{d_i} \right\rceil \leq -2.$$

Since $R(\mathbb{P}_k^1, D_l)$ has a rational singularity for any l , we have

$$\deg[nD_l] = sn - \sum_{i=1}^r \left\lceil \frac{nc_i^{(l)}}{d_i^{(l)}} \right\rceil \geq -1$$

for any positive integer n by Theorem 2.16. Since $\frac{c_i^{(l)}}{d_i^{(l)}} \leq \frac{c_i^{(l+1)}}{d_i^{(l+1)}}$ for any i, l , we have

$$\left\lceil \frac{mc_i}{d_i} \right\rceil = \left\lceil \frac{mc_i^{(l)}}{d_i^{(l)}} \right\rceil$$

for any i and any sufficiently large number l . Therefore for any sufficiently large l , we have

$$-1 \leq \deg[mD_l] = \deg[mD] \leq -2,$$

which is contradiction.

If $\deg D > 0$, then $R(\mathbb{P}_k^1, D)$ has a rational singularity by Theorem 2.16.

(2) If the lemma fails, then there exists a positive integer m such that

$$\deg[-pmD] + \deg(B_m)_{\text{red}} \geq 2.$$

We have for every positive integer n ,

$$\deg[nD] = sn - \sum_{i=1}^r \left\lceil \frac{nc_i}{d_i} \right\rceil \geq -1$$

by Lemma 4.4 (1). Let $l = \#\{i \in \mathbb{N} \mid \frac{mc_i}{d_i} \notin \mathbb{Z}\}$. Then we have

$$\left\lceil \frac{pmc_j}{d_j} \right\rceil - \left\lfloor \frac{pmc_j}{d_j} \right\rfloor = 1$$

for $j \in \{i \in \mathbb{N} \mid \frac{mc_i}{d_i} \notin \mathbb{N}\}$ and $\deg(B_m)_{\text{red}} \leq l$. We have

$$\deg[-pmD] = -pms + \sum_{i=1}^r \left\lceil \frac{pmc_i}{d_i} \right\rceil = -pms + \sum_{i=1}^r \left\lfloor \frac{pmc_i}{d_i} \right\rfloor - l \leq 1 - l.$$

Hence we have

$$2 \leq \deg[-pmD] + \deg(B_m)_{\text{red}} \leq 1 - l + l = 1,$$

which is a contradiction.

(3) Let $I = \{i \in \mathbb{N} \mid 1 \leq i \leq r\}$, $U_n = \{i \in I \mid \frac{nc_i}{d_i} \in \mathbb{Z}, \frac{c_i^{(l)}}{d_i^{(l)}} \neq \frac{c_i}{d_i} \text{ for any } l\}$ and

$V_n = \{i \in I \mid \frac{nc_i}{d_i} \notin \mathbb{Z}\}$. If $\frac{nc_i}{d_i} \in \mathbb{Z}$ and $\frac{c_i^{(l)}}{d_i^{(l)}} \neq \frac{c_i}{d_i}$, then $\left\lceil \frac{pmc_i}{d_i} \right\rceil - \left\lfloor \frac{pmc_i^{(l)}}{d_i^{(l)}} \right\rfloor \geq 1$.

Therefore we have for any positive integer n, l ,

$$\sum_{i=1}^r \left\lceil \frac{pmc_i}{d_i} \right\rceil - \sum_{i=1}^r \left\lfloor \frac{pmc_i^{(l)}}{d_i^{(l)}} \right\rfloor \geq \#U_n.$$

Since $p > d_i$ for any i , we have $-p \left[\frac{nc_i}{d_j} \right] + \left[\frac{pnc_i}{d_j} \right] \geq 1$ for any positive integer n and $j \in V_n$. Therefore we have for any positive integer n ,

$$\deg(B_n)_{\text{red}} = \deg \left(-p \left[\sum_{i=1}^r \frac{nc_i}{d_i} P_i \right] + \left[\sum_{i=1}^r \frac{pnc_i}{d_i} P_i \right] \right)_{\text{red}} = \#V_n.$$

Since $\frac{c_i^{(l)}}{d_i^{(l)}} \leq \frac{c_i^{(l+1)}}{d_i^{(l+1)}}$ for any i, l , we have $i \in U_n \cup V_n$ for any positive integer n , any sufficiently large number l and $i \in I$ with $\frac{nc_i^{(l)}}{d_i^{(l)}} \notin \mathbb{Z}$. Hence we have for any positive integer n and any sufficiently large number l ,

$$\#U_n + \#V_n \geq \# \left\{ i \in I \mid \frac{nc_i^{(l)}}{d_i^{(l)}} \notin \mathbb{Z} \right\} \geq \deg(B_n^l)_{\text{red}}.$$

Therefore for any positive integer n ,

$$\begin{aligned} \deg[-pnD] + \deg(B_n)_{\text{red}} &= -pns + \sum_{i=1}^r \left[\frac{pnc_i}{d_i} \right] + \deg(B_n)_{\text{red}} \\ &\geq -pns + \sum_{i=1}^r \left[\frac{pnc_i^{(l)}}{d_i^{(l)}} \right] + \#U_n + \#V_n \geq \deg[-pnD_l] + \deg(B_n^l)_{\text{red}}. \end{aligned}$$

□

Theorem 4.5. *Let $m \in \mathbb{N}$. There exists a positive integer $p(m)$ such that R is F -rational for any two-dimensional graded ring R with a rational singularity, $e(R) = m$ and $R_0 = k$, an algebraically closed field of characteristic $p \geq p(m)$.*

Proof. If the theorem fails, then by Theorem 2.12 and Theorem 2.16, there exist a positive integer m and a sequence $\{D_l\}_{l \in \mathbb{N}}$ of ample \mathbb{Q} -divisors on $\mathbb{P}_{k_l}^1$ such that $R(\mathbb{P}_{k_l}^1, D_l)$ is a two-dimensional non- F -rational graded ring with a rational singularity,

$$e(R(\mathbb{P}_{k_l}^1, D_l)) = m$$

and

$$\lim_{l \rightarrow \infty} p_l = \infty,$$

where p_l is the characteristic of the field k_l . Let E_0^l be the central curve of the exceptional set of the minimal good resolution of $\text{Spec}(R(\mathbb{P}_{k_l}^1, D_l))$. Then $-(E_0^l)^2 \leq m$ by Proposition 2.19. Therefore by taking a subsequence of $\{D_l\}_{l \in \mathbb{N}}$, we may assume that $(E_0^l)^2$ is constant for any l . We put $s = -(E_0^l)^2$ for any l . Since $R(\mathbb{P}_{k_l}^1, D_l)$ has a rational singularity and is not F -rational, by Proposition 3.3.(2), we may put $D_l = sP_0^{(l)} - \sum_{i=1}^{s+1} \frac{c_i^{(l)}}{d_i^{(l)}} P_i^{(l)}$, where $s, c_i^{(l)}, d_i^{(l)} \in \mathbb{N}$ with $0 < c_i^{(l)} < d_i^{(l)}$, and $P_i^{(l)}$ are distinct points of $\mathbb{P}_{k_l}^1$.

By Proposition 2.19, $C_j(R(\mathbb{P}_{k_l}^1, D_l)) \leq m$ for any l, j with $3 \leq j \leq m$ and $C_{j'}(R(\mathbb{P}_{k_l}^1, D_l)) = 0$ for any l, j' with $j' \geq m+1$. Therefore we may assume that $C_j(R(\mathbb{P}_{k_l}^1, D_l))$ is constant for any l when we fix j with $3 \leq j \leq m$. Hence we may assume that the number of $(-j)$ -curves in the branch corresponding to $P_i^{(l)}$ in the

dual graph of the minimal good resolution of $\text{Spec}(R(\mathbb{P}_{k_l}^1, D_l))$ is constant for any l when we fix i, j . Since we can compute the Hirzebruch-Jung continued fraction of $\frac{d_i^{(l)}}{c_i^{(l)}}$ using the exceptional set of the minimal good resolution of $\text{Spec}(R(\mathbb{P}_{k_l}^1, D_l))$ by Theorem 2.14, we may assume that $T(\frac{d_i^{(l)}}{c_i^{(l)}})$ is constant for any l when we fix i . Hence we may assume that $\frac{c_i^{(l)}}{d_i^{(l)}} \leq \frac{c_i^{(l+1)}}{d_i^{(l+1)}}$ for any i, l by Lemma 2.9. Thus when we fix i , we may assume that a sequence $\left\{ \frac{c_i^{(l)}}{d_i^{(l)}} \right\}_l$ is constant or strictly increasing. Let $I = \left\{ i \in \mathbb{N} \mid \left\{ \frac{c_i^{(l)}}{d_i^{(l)}} \right\}_l \text{ is strictly increasing} \right\}$. Then for $i \in I$, the Hirzebruch-Jung continued fraction of $\frac{d_i^{(l)}}{c_i^{(l)}}$ can be expressed as follows:

$$\frac{d_i^{(l)}}{c_i^{(l)}} = [[b_{i1}, b_{i2}, \dots, b_{im_i}, (2)^{e_i^{(l)}}, f_{i1}^{(l)}, \dots, f_{im_i}^{(l)}]]$$

with

$$\lim_{l \rightarrow \infty} e_i^{(l)} = \infty.$$

Note that b_{ij} is independent of l . We have for $i \in I$,

$$[[b_{i1}, b_{i2}, \dots, b_{im_i}, (2)^{e_i^{(l)} + n_i^{(l)}}]] \leq \frac{d_i^{(l)}}{c_i^{(l)}} \leq [[b_{i1}, b_{i2}, \dots, b_{im_i}, (2)^{e_i^{(l)}}]]$$

by Lemma 2.9. Therefore we have for $i \in I$,

$$\lim_{l \rightarrow \infty} \frac{d_i^{(l)}}{c_i^{(l)}} = [[b_{i1}, b_{i2}, \dots, b_{im_i-1}, b_{im_i} - 1]] \in \mathbb{Q}.$$

Let c_i, d_i be positive integers with $0 < c_i \leq d_i$ and

$$\frac{c_i}{d_i} = \lim_{l \rightarrow \infty} \frac{c_i^{(l)}}{d_i^{(l)}}.$$

Let $D = sP_0 - \sum_{i=1}^{s+1} \frac{c_i}{d_i} P_i$, where P_i are distinct points of \mathbb{P}_k^1 . Since $\lim_{l \rightarrow \infty} p_l = \infty$, by Lemma 4.4 (2) and (3), we have for any positive integer n and any sufficiently large number l

$$\deg[-pnD_l] + \deg(B_n^l)_{\text{red}} \leq 1,$$

where $B_n^l = -p_l[-nD_l] + [-p_l n D_l]$. By Theorem 3.1, $R(\mathbb{P}_{k_l}^1, D_l)$ is F -rational for any sufficiently large number l , which is contradiction. \square

Example 4.6. Let $D = 2P_0 - \frac{p+1}{2p}P_1 - \frac{p-1}{p}P_2 - \frac{1}{2}P_3$, where P_i are distinct points of \mathbb{P}_k^1 . Then $R = R(\mathbb{P}_k^1, D)$ has a rational singularity with $e(R) = \lceil \frac{p+1}{2} \rceil$ but is not F -rational. Indeed, we have for $m \in \mathbb{N}$,

$$\deg[2mD] = \left\lceil \frac{2m}{p} \right\rceil - \left\lceil \frac{m}{p} \right\rceil \geq -1$$

and

$$\deg[(2m-1)D] = \left\lfloor \frac{2m-1}{p} \right\rfloor - \left\lfloor \frac{p+2m-1}{2p} \right\rfloor \geq -1.$$

Therefore R has a rational singularity by Theorem 2.16. Since

$$\deg[-pD] + \deg(B_1)_{\text{red}} = 2,$$

where $B_1 = -p[-D] + [-pD]$, R is not F -rational by Theorem 3.1.

If $p = 2$, then the dual graph of the minimal good resolution of $\text{Spec}(R)$ is the following:

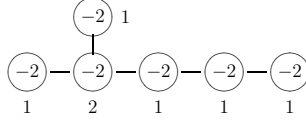

Here the number next to a vertex means the coefficient of the relevant exceptional divisor in the fundamental cycle. Therefore we have $e(R) = 2$ by Proposition 2.19.

If $p \geq 3$, then the dual graph of the minimal good resolution of $\text{Spec}(R)$ is the following:

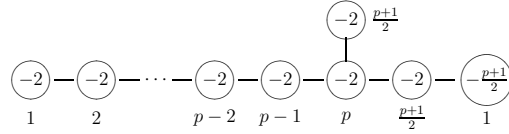

Note that $\min\{n \in \mathbb{N} \mid \deg[nD] \geq 0\} = p$. Therefore we can compute the fundamental cycle by Lemma 2.21 and Corollary 2.22. We have $e(R) = \frac{p+1}{2}$ by Proposition 2.19.

Remark 4.7. Example 4.6 implies that $p(m) > 2m - 1$, where $p(m)$ is the positive integer in Theorem 4.5.

Remark 4.8. Theorem 4.5 does not hold for higher dimensional graded rings. In fact, consider the ring $R = k[x, y, z, w]/(x^3 + y^3 + z^3 + w^p)$. Then R has rational singularities but R is not F -rational if 3 does not divide $p - 1$ by Theorem 2.18, [2, Remark 3.8] and [3, Proposition 2.1].

5. CLASSIFICATION OF $R(\mathbb{P}_k^1, D)$ WHICH IS A RATIONAL TRIPLE POINT AND RATIONAL FOURTH POINT

In this section we classify normal graded rings $R(\mathbb{P}_k^1, D)$ with a rational singularity and $e(R(\mathbb{P}_k^1, D)) = 3$ and 4.

5.1. Preliminaries of classification of $R(\mathbb{P}_k^1, D)$. In this subsection, we give results for the classification of $R(\mathbb{P}_k^1, D)$ with a rational singularity and $e(R(\mathbb{P}_k^1, D)) = 3$ and 4.

Lemma 5.1. *Let $D_1 = \sum_{i=1}^r a_i P_i$ and $D_2 = \sum_{i=1}^r b_i P_i$ be ample \mathbb{Q} -divisors on \mathbb{P}_k^1 , where P_i are distinct points of \mathbb{P}_k^1 . Assume $a_i \geq b_i$ for any i . If $R(\mathbb{P}_k^1, D_2)$ has a rational singularity, then $R(\mathbb{P}_k^1, D_1)$ has a rational singularity.*

Proof. Since $\deg[nD_1] \geq \deg[nD_2]$ for any $n \in \mathbb{N}$, $R(\mathbb{P}_k^1, D_1)$ has a rational singularity by Theorem 2.16. \square

Lemma 5.2. *Let $D = sP_0 - \sum_{i=1}^r \frac{c_i}{d_i} P_i$ be an ample \mathbb{Q} -divisor on \mathbb{P}_k^1 , where $s, c_i, d_i \in \mathbb{N}$ with $0 < c_i < d_i$, and P_i are distinct points of \mathbb{P}_k^1 . Let $R = R(\mathbb{P}_k^1, D)$ and $f : X \rightarrow \text{Spec}(R)$ the minimal good resolution. Assume that R has a rational singularity.*

- (1) *If $e(R) = 3$, then the dual graph of f has the following property;
There is unique (-3) -curve and others are (-2) -curves. In this case, D is one of the following: for some $n_i, a, b \in \mathbb{Z}_{\geq 0}$,*

$$3P_0 - \sum_{i=1}^3 \frac{n_i}{n_i + 1} P_i \quad \text{or}$$

$$2P_0 - \sum_{i=1}^2 \frac{n_i}{n_i + 1} P_i - \frac{1}{[[(2)^a, 3, (2)^b]]} P_3.$$

- (2) *If $e(R) = 4$, then the dual graph of f has one of the following properties;
(a) *There is unique (-4) -curve and others are (-2) -curves. In this case, D is one of the following: for some $n_i, a, b \in \mathbb{Z}_{\geq 0}$,**

$$4P_0 - \sum_{i=1}^4 \frac{n_i}{n_i + 1} P_i \quad \text{or}$$

$$2P_0 - \sum_{i=1}^2 \frac{n_i}{n_i + 1} P_i - \frac{1}{[[(2)^a, 4, (2)^b]]} P_3.$$

- (b) *There is unique (-3) -curve and others are (-2) -curves. In this case, D is one of the following: for some $n_i, a, b \in \mathbb{Z}_{\geq 0}$,*

$$3P_0 - \sum_{i=1}^4 \frac{n_i}{n_i + 1} P_i \quad \text{or}$$

$$2P_0 - \sum_{i=1}^2 \frac{n_i}{n_i + 1} P_i - \frac{1}{[[(2)^a, 3, (2)^b]]} P_3.$$

- (c) *There are two (-3) -curves and others are (-2) -curves. In this case, D is one of the following: for some $n_i, n, a, b, c, d \in \mathbb{Z}_{\geq 0}$,*

$$3P_0 - \sum_{i=1}^2 \frac{n_i}{n_i + 1} P_i - \frac{1}{[[(2)^a, 3, (2)^b]]} P_3,$$

$$3P_0 - \sum_{i=1}^2 \frac{n_i}{n_i + 1} P_i - \frac{1}{[[(2)^a, 3, (2)^b, 3, (2)^c]]} P_3 \quad \text{or}$$

$$2P_0 - \frac{n}{n+1} P_1 - \frac{1}{[[(2)^a, 3, (2)^b]]} P_2 - \frac{1}{[[(2)^c, 3, (2)^d]]} P_3.$$

Proof. We prove only (2), as (1) is proved similarly. By Proposition 2.19, the dual graph of f has one of the following properties;

- (a) There is unique (-4) -curve and others are (-2) -curves.
(b) There is unique (-3) -curve and others are (-2) -curves.

(c) There are two (-3) -curves and others are (-2) -curves.

By Lemma 2.17, we have $s+1 \geq r$. Let Z be the fundamental cycle of f , and let E_0 be the central curve of f . If $s+1 = r$, then $\text{Coeff}_{E_0}(Z) \geq 2$ by Corollary 2.22. Therefore by Proposition 2.19, if E_0 is a (-4) -curve and $r = 5$, then $e(R) \geq 6$, and if there are two (-3) -curves in the dual graph, E_0 is a (-3) -curve and $r = 4$, then $e(R) \geq 5$.

Note that $[[(2)^m]] = \frac{m+1}{m}$ for $m \in \mathbb{N}$ by Example 2.10. By Theorem 2.14, we can determine the coefficients of D . \square

Lemma 5.3. *Let $n, a, b \in \mathbb{Z}_{\geq 0}$ with $n \geq 2$. Then we have*

$$[[(2)^a, n, (2)^b]] = \frac{((a+1)n - (2a+1))b + (a+1)n - a}{(an - (2a-1))b + an - (a-1)}.$$

Proof. Note that $[[(2)^m]] = \frac{m+1}{m}$ for $m \in \mathbb{N}$ by Example 2.10. We prove this by induction on a . If $a = 0$, then

$$[[(2)^0, n, (2)^b]] = [[n, \frac{b+1}{b}]] = n - \frac{b}{b+1} = \frac{(n-1)b + n}{b+1}.$$

If $a > 0$, then

$$\begin{aligned} [[(2)^{a+1}, n, (2)^b]] &= [[2, (2)^a, n, (2)^b]] \\ &= [[2, \frac{((a+1)n - (2a+1))b + (a+1)n - a}{(an - (2a-1))b + an - (a-1)}]] \\ &= 2 - \frac{(an - (2a-1))b + an - (a-1)}{((a+1)n - (2a+1))b + (a+1)n - a} \\ &= \frac{((a+2)n - (2a+3))b + (a+2)n - (a+1)}{((a+1)n - (2a+1))b + (a+1)n - a}. \end{aligned}$$

\square

Lemma 5.4. *Let $a, b, c \in \mathbb{Z}_{\geq 0}$. Then we have*

$$[[(2)^a, 3, (2)^b, 3, (2)^c]] = \frac{((a+2)b + 3a + 5)c + (2a+4)b + 5a + 8}{((a+1)b + 3a + 2)c + (2a+2)b + 5a + 3}.$$

Proof. We prove this by induction on a . If $a = 0$, then by Lemma 5.3

$$[[(2)^0, 3, (2)^b, 3, (2)^c]] = [[3, \frac{(b+2)c + 2b + 3}{(b+1)c + 2b + 1}]] = \frac{(2b+5)c + 4b + 8}{(b+2)c + 2b + 3}.$$

If $a > 0$, then

$$\begin{aligned}
 [[(2)^{a+1}, 3, (2)^b, 3, (2)^c]] &= [[2, (2)^a, 3, (2)^b, 3, (2)^c]] \\
 &= \left[\left[2, \frac{((a+2)b+3a+5)c + (2a+4)b + 5a + 8}{((a+1)b+3a+2)c + (2a+2)b + 5a + 3} \right] \right] \\
 &= 2 - \frac{((a+1)b+3a+2)c + (2a+2)b + 5a + 3}{((a+2)b+3a+5)c + (2a+4)b + 5a + 8} \\
 &= \frac{((a+3)b+3a+8)c + (2a+6)b + 5a + 13}{((a+2)b+3a+5)c + (2a+4)b + 5a + 8}.
 \end{aligned}$$

□

In next subsections, we will use Lemma 5.1 and the following result to check whether $R(\mathbb{P}_k^1, D)$ has a rational singularity for D in the list of Lemma 5.2.

Lemma 5.5. *Let $D = 2P_0 - a_1P_1 - a_2P_2 - a_3P_3$ be a \mathbb{Q} -divisor on \mathbb{P}_k^1 , where $a_i \in \mathbb{Q}_{\geq 0}$ and P_i are distinct points of \mathbb{P}_k^1 . Then $R(\mathbb{P}_k^1, D)$ has a rational singularity, if (a_1, a_2, a_3) is equal to $(\frac{1}{2}, \frac{1}{2}, \frac{n}{n+1})$ for some $n \in \mathbb{Z}_{\geq 0}$ or $(\frac{1}{2}, \frac{2}{3}, \frac{4}{5})$.*

Proof. If $(a_1, a_2, a_3) = (\frac{1}{2}, \frac{1}{2}, \frac{n}{n+1})$ for some $n \in \mathbb{Z}_{\geq 0}$, then for any $l \in \mathbb{N}$,

$$\deg[lD] = 2l - \left\lfloor \frac{l}{2} \right\rfloor - \left\lfloor \frac{l}{2} \right\rfloor - \left\lfloor \frac{ln}{n+1} \right\rfloor \geq \left\lfloor \frac{l}{2} \right\rfloor - \left\lfloor \frac{l}{2} \right\rfloor \geq -1,$$

which implies that $R(\mathbb{P}_k^1, D)$ has a rational singularity by Theorem 2.16.

If $(a_1, a_2, a_3) = (\frac{1}{2}, \frac{2}{3}, \frac{4}{5})$, then $\deg[lD] \geq -1$ for any $l \in \mathbb{N}$ with $1 \leq l \leq 29$ and $\deg[30D] = 1$. Since $\deg[lD] = \deg[(l-30)D] + \deg[30D]$ any $l \in \mathbb{N}$ with $l \geq 30$, $\deg[lD] \geq -1$ for any $l \in \mathbb{N}$. Hence $R(\mathbb{P}_k^1, D)$ has a rational singularity by Theorem 2.16. □

In next subsections, we determine D in the list of Lemma 5.2 such that $R(\mathbb{P}_k^1, D)$ has a rational singularity with $e(R(\mathbb{P}_k^1, D)) = 3$ and 4 using the following steps:

- (1) We will check whether $R(\mathbb{P}_k^1, D)$ has a rational singularity by Theorem 2.16 or Lemma 5.1.
- (2) We will determine the fundamental cycle of the minimal good resolution of $\text{Spec}(R(\mathbb{P}_k^1, D))$ by Theorem 2.14, Lemma 2.21 and Corollary 2.22.
- (3) We will determine $e(R(\mathbb{P}_k^1, D))$ by Proposition 2.19.
- (4) We will compute the Hirzebruch-Jung continued fractions

$$[[(2)^a, 3, (2)^b]], [[(2)^a, 4, (2)^b]], [[(2)^a, 3, (2)^b, 3, (2)^c]]$$

by Lemma 5.3 and Lemma 5.4.

5.2. The case there is unique (-3) -curve. In this subsection we classify the $R(\mathbb{P}_k^1, D)$ with a rational singularity such that there is unique (-3) -curve in the dual graph of the minimal good resolution of $\text{Spec}(R(\mathbb{P}_k^1, D))$ and others are (-2) -curves. First, we consider the case the central curve is a (-3) -curve.

Recall that the number next to a vertex of a dual graph denotes the coefficient of the relevant exceptional divisor in the fundamental cycle.

Proposition 5.6. *Let $D = 3P_0 - \sum_{i=1}^4 a_i P_i$ be an ample \mathbb{Q} -divisor on \mathbb{P}_k^1 , where $a_i \in \mathbb{Q}_{\geq 0}$ and P_i are distinct points of \mathbb{P}_k^1 . Assume that $a_1 \leq a_2 \leq a_3 \leq a_4$, $a_1 = \frac{a}{a+1}$, $a_2 = \frac{b}{b+1}$, $a_3 = \frac{c}{c+1}$ and $a_4 = \frac{d}{d+1}$ for $a, b, c, d \in \mathbb{Z}_{\geq 0}$ and $R(\mathbb{P}_k^1, D)$ has a rational singularity. Then $(a_1, a_2, a_3, a_4) = (0, \frac{b}{b+1}, \frac{c}{c+1}, \frac{d}{d+1})$ for $0 \leq b \leq c \leq d$ or $(\frac{1}{2}, \frac{1}{2}, \frac{c}{c+1}, \frac{d}{d+1})$ for $1 \leq c \leq d$. Moreover if*

$$(a_1, a_2, a_3, a_4) = (0, \frac{b}{b+1}, \frac{c}{c+1}, \frac{d}{d+1})$$

for $0 \leq b \leq c \leq d$, then $e(R(\mathbb{P}_k^1, D)) = 3$ and if

$$(a_1, a_2, a_3, a_4) = (\frac{1}{2}, \frac{1}{2}, \frac{c}{c+1}, \frac{d}{d+1})$$

for $1 \leq c \leq d$, then $e(R(\mathbb{P}_k^1, D)) = 4$.

Proof. Since $R(\mathbb{P}_k^1, D)$ has a rational singularity, we have $\deg[2D] \geq -1$. Therefore $a = 0$ or $a = b = 1$.

Assume $(a_1, a_2, a_3, a_4) = (0, \frac{b}{b+1}, \frac{c}{c+1}, \frac{d}{d+1})$ for $0 \leq b \leq c \leq d$. $R(\mathbb{P}_k^1, D)$ has a rational singularity since $\deg[lD] \geq 0$ for any $l \in \mathbb{N}$. The dual graph of the minimal good resolution of $\text{Spec}(R(\mathbb{P}_k^1, D))$ is the following:

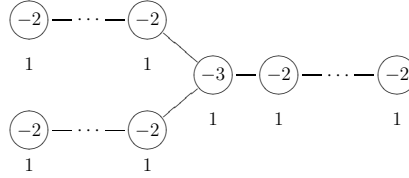

Therefore $e(R(\mathbb{P}_k^1, D)) = 3$.

Assume $(a_1, a_2, a_3, a_4) = (\frac{1}{2}, \frac{1}{2}, \frac{c}{c+1}, \frac{d}{d+1})$ for $1 \leq c \leq d$. Then

$$\deg[lD] = 3l + \left[-\frac{l}{2} \right] + \left[-\frac{l}{2} \right] + \left[-\frac{lc}{c+1} \right] + \left[-\frac{ld}{d+1} \right] \geq \left[\frac{l}{2} \right] + \left[-\frac{l}{2} \right] \geq -1$$

for any $l \in \mathbb{N}$. Therefore $R(\mathbb{P}_k^1, D)$ has a rational singularity. The dual graph of the minimal good resolution of $\text{Spec}(R(\mathbb{P}_k^1, D))$ is the following:

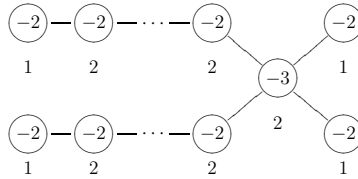

Therefore $e(R(\mathbb{P}_k^1, D)) = 4$. □

Next, we consider the case the central curve is a (-2) -curve.

Proposition 5.7. *Let $D = 2P_0 - \sum_{i=1}^3 a_i P_i$ be an ample \mathbb{Q} -divisor on \mathbb{P}_k^1 , where $a_i \in \mathbb{Q}_{\geq 0}$ and P_i are distinct points of \mathbb{P}_k^1 . Assume that $a_1 \leq a_2$, $a_1 = \frac{m}{m+1}$, $a_2 = \frac{n}{n+1}$, $\frac{1}{a_3} = [(2)^a, 3, (2)^b]$ for $m, n, a, b \in \mathbb{Z}_{\geq 0}$ and $R(\mathbb{P}_k^1, D)$ has a rational singularity.*

(i) If $e(R(\mathbb{P}_k^1, D)) = 3$, then (a_1, a_2, a_3) is one of the following:

- | | |
|---|---|
| (1) $(0, \frac{n}{n+1}, \frac{(a+1)b+2a+1}{(a+2)b+2a+3})$ | for $n \geq 0, a \geq 0, b \geq 0$, |
| (2) $(\frac{1}{2}, \frac{n}{n+1}, \frac{b+1}{2b+3})$ | for $n \geq 1, b \geq 0$ |
| (3) $(\frac{1}{2}, \frac{1}{2}, \frac{(a+1)b+2a+1}{(a+2)b+2a+3})$ | for $a \geq 1, b \geq 0$, |
| (4) $(\frac{1}{2}, \frac{2}{3}, \frac{2b+3}{3b+5})$ | for $b \geq 0$, |
| (5) $(\frac{1}{2}, \frac{2}{3}, \frac{3b+5}{4b+7})$ | for $b \geq 0$, |
| (6) $(\frac{1}{2}, \frac{2}{3}, \frac{7}{9})$, | (7) $(\frac{1}{2}, \frac{3}{4}, \frac{3}{5})$, |
| (8) $(\frac{1}{2}, \frac{4}{5}, \frac{3}{5})$, | (9) $(\frac{2}{3}, \frac{n}{n+1}, \frac{1}{3})$ |

(ii) If $e(R(\mathbb{P}_k^1, D)) = 4$, then (a_1, a_2, a_3) is one of the following:

- | | | | |
|---|------------------|---|------------------|
| (1) $(\frac{1}{2}, \frac{2}{3}, \frac{4b+7}{5b+9})$ | for $b \geq 1$, | (2) $(\frac{1}{2}, \frac{3}{4}, \frac{2b+3}{3b+5})$ | for $b \geq 1$, |
| (3) $(\frac{1}{2}, \frac{4}{5}, \frac{2b+3}{3b+5})$ | for $b \geq 1$, | (4) $(\frac{1}{2}, \frac{5}{6}, \frac{3}{5})$, | |
| (5) $(\frac{1}{2}, \frac{6}{7}, \frac{3}{5})$, | | (6) $(\frac{2}{3}, \frac{2}{3}, \frac{b+1}{2b+3})$ | for $b \geq 1$, |
| (7) $(\frac{2}{3}, \frac{3}{4}, \frac{b+1}{2b+3})$ | for $b \geq 1$, | (8) $(\frac{2}{3}, \frac{4}{5}, \frac{2}{5})$, | |
| (9) $(\frac{3}{4}, \frac{3}{4}, \frac{1}{3})$, | | (10) $(\frac{3}{4}, \frac{4}{5}, \frac{1}{3})$, | |
| (11) $(\frac{3}{4}, \frac{5}{6}, \frac{1}{3})$. | | | |

Proof. Case 1. We assume that $m = 0$. Then $R(\mathbb{P}_k^1, D)$ has a rational singularity since $\deg[lD] \geq 0$ for any $l \in \mathbb{N}$. The dual graph of the minimal good resolution of $\text{Spec}(R(\mathbb{P}_k^1, D))$ is the following:

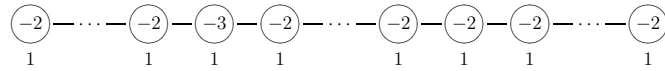

Therefore $e(R(\mathbb{P}_k^1, D)) = 3$.

Case 2. We assume that $m = 1$ and $a = 0$. Note that $D \geq 2P_0 - \frac{1}{2}P_1 - \frac{n}{n+1}P_2 - \frac{1}{2}P_3$ by Lemma 2.9. Therefore $R(\mathbb{P}_k^1, D)$ has a rational singularity by Lemma 5.1 and Lemma 5.5. The dual graph of the minimal good resolution of $\text{Spec}(R(\mathbb{P}_k^1, D))$ is the following:

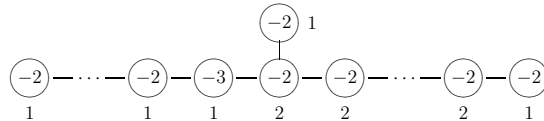

Therefore $e(R(\mathbb{P}_k^1, D)) = 3$.

Case 3. We assume that $m = n = 1$ and $a \geq 1$. Note that $D \geq 2P_0 - \frac{1}{2}P_1 - \frac{1}{2}P_2 - \frac{a+b+1}{a+b+2}P_3$ by Lemma 2.9. Therefore $R(\mathbb{P}_k^1, D)$ has a rational singularity by Lemma 5.1 and Lemma 5.5. The dual graph of the minimal good resolution of $\text{Spec}(R(\mathbb{P}_k^1, D))$ is the following:

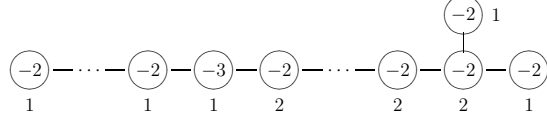

Therefore $e(R(\mathbb{P}_k^1, D)) = 3$.

Case 4. We assume that $m = 1$, $n = 2$ and $1 \leq a \leq 3$. Note that $D \geq 2P_0 - \frac{1}{2}P_1 - \frac{2}{3}P_2 - \frac{4}{5}P_3$ by Lemma 2.9. Therefore $R(\mathbb{P}_k^1, D)$ has a rational singularity by Lemma 5.1 and Lemma 5.5. The dual graphs of the minimal good resolution of $\text{Spec}(R(\mathbb{P}_k^1, D))$ are the following:

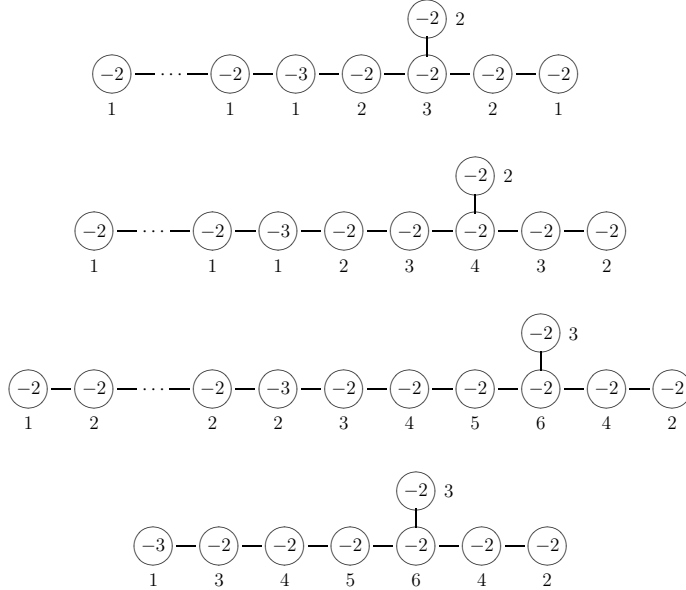

Therefore $e(R(\mathbb{P}_k^1, D)) = 3$ when $1 \leq a \leq 2$ or $a = 3$ and $b = 0$ and $e(R(\mathbb{P}_k^1, D)) = 4$ when $a = 3$ and $b \geq 1$.

Case 5. Assume one of the following holds:

- (i) $m = 1$, $n = 2$ and $a \geq 4$.
- (ii) $m = 1$, $n \geq 5$, $a = 1$ and $b \geq 1$.
- (iii) $m = 1$, $n \geq 7$ and $a \geq 1$.
- (iv) $m \geq 2$ and $a \geq 1$.
- (v) $m \geq 3$, $n \geq 7$ and $a = 0$.
- (vi) $m \geq 3$ and $b \geq 1$.

Then $R(\mathbb{P}_k^1, D)$ does not have a rational singularity since there exists $l \in \{2, 3, 5, 7\}$ such that $\deg[lD] \leq -2$.

Case 6. We assume that $m = 1$, $3 \leq n \leq 4$ and $a = 1$. Note that $D \geq 2P_0 - \frac{1}{2}P_1 - \frac{4}{5}P_2 - \frac{2}{3}P_3$ by Lemma 2.9. Therefore $R(\mathbb{P}_k^1, D)$ has a rational singularity

by Lemma 5.1 and Lemma 5.5. The dual graphs of the minimal good resolution of $\text{Spec}(R(\mathbb{P}_k^1, D))$ are the following:

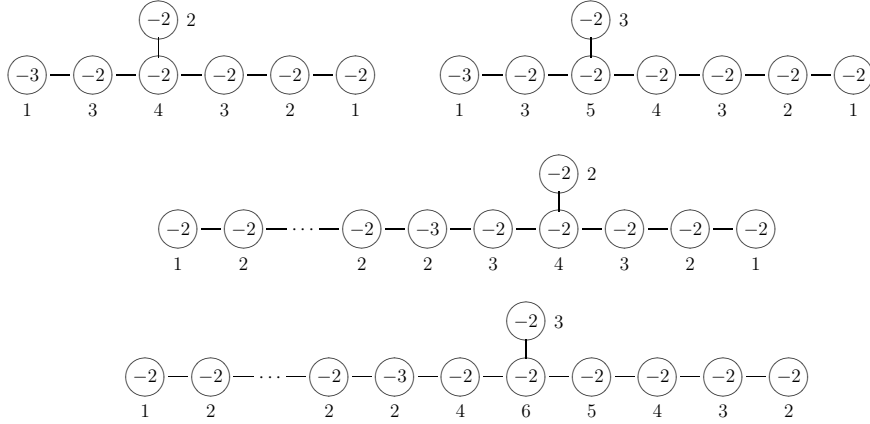

Therefore $e(R(\mathbb{P}_k^1, D)) = 3$ when $n = 3, 4$ and $b = 0$ and $e(R(\mathbb{P}_k^1, D)) = 4$ when $n = 3, 4$ and $b \geq 1$.

Case 7. We assume that $m = 1$, $5 \leq n \leq 6$, $a = 1$ and $b = 0$. Let $D' = 2P_0 - \frac{1}{2}P_1 - \frac{6}{7}P_2 - \frac{3}{5}P_3$. Then $\deg[lD'] \geq -1$ for any $l \in \mathbb{N}$ since $\deg[lD'] \geq -1$ for $1 \leq l \leq 69$ and $\deg[70D'] \geq 1$. Note that $D \geq D'$ by Lemma 2.9. Therefore $R(\mathbb{P}_k^1, D)$ has a rational singularity by Lemma 5.1. The dual graphs of the minimal good resolution of $\text{Spec}(R(\mathbb{P}_k^1, D))$ are the following:

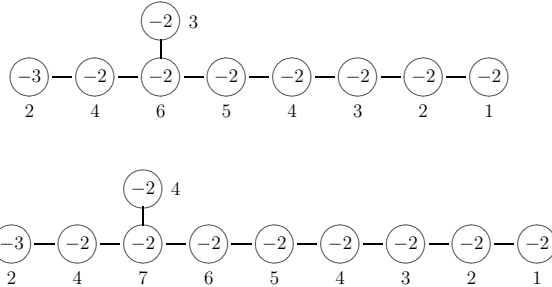

Therefore $e(R(\mathbb{P}_k^1, D)) = 4$.

Case 8. We assume that $m = 2$, $a = 0$ and $b = 0$. Then $R(\mathbb{P}_k^1, D)$ has a rational singularity since $\deg[lD] \geq 2l + [-\frac{2l}{3}] - l + [-\frac{l}{3}] = [\frac{l}{3}] + [-\frac{l}{3}] \geq -1$ for any $l \in \mathbb{N}$. The dual graph of the minimal good resolution of $\text{Spec}(R(\mathbb{P}_k^1, D))$ is the following:

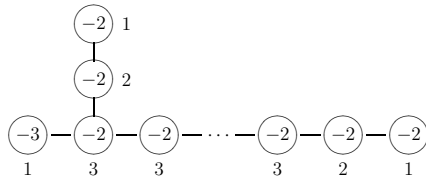

Therefore $e(R(\mathbb{P}_k^1, D)) = 3$.

Case 9. We assume that $m = 2$, $2 \leq n \leq 4$, $a = 0$ and $b \geq 1$. Note that $D \geq 2P_0 - \frac{2}{3}P_1 - \frac{4}{5}P_2 - \frac{1}{2}P_3$ by Lemma 2.9. Therefore $R(\mathbb{P}_k^1, D)$ has a rational

singularity by Lemma 5.1 and Lemma 5.5. The dual graphs of the minimal good resolution of $\text{Spec}(R(\mathbb{P}_k^1, D))$ are the following:

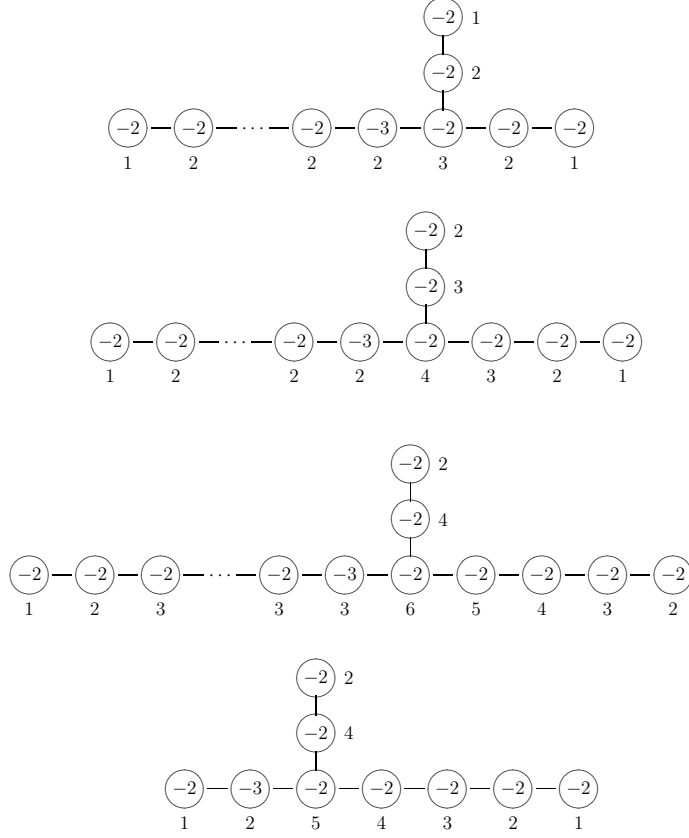

Hence $e(R(\mathbb{P}_k^1, D)) = 4$ when $n = 2, 3$ or $n = 4$ and $b = 1$ and $e(R(\mathbb{P}_k^1, D)) = 5$ when $n = 4$ and $b \geq 2$.

Case 10. We assume that $m = 2$, $n \geq 5$, $a = 0$ and $b \geq 1$. Let E_0 be the central curve of the minimal good resolution of $\text{Spec}(R(\mathbb{P}_k^1, D))$ and E_1 be the (-3) -curve in its dual graph. Let Z be the fundamental cycle of the minimal good resolution of $\text{Spec}(R(\mathbb{P}_k^1, D))$. Then $\text{Coeff}_{E_0}(Z) \geq 6$ by Corollary 2.22. Therefore $\text{Coeff}_{E_1}(Z) \geq 3$. Hence $e(R(\mathbb{P}_k^1, D)) \geq 5$.

Case 11. We assume that $m = 3$, $3 \leq n \leq 6$ and $a = b = 0$. Let $D' = 2P_0 - \frac{3}{4}P_1 - \frac{6}{7}P_2 - \frac{1}{3}P_3$. Then $\deg[lD'] \geq -1$ for any $l \in \mathbb{N}$ since $\deg[lD'] \geq -1$ for $1 \leq l \leq 83$ and $\deg[84D'] \geq 1$. Note that $D \geq D'$ by Lemma 2.9. Therefore $R(\mathbb{P}_k^1, D)$ has a rational singularity by Lemma 5.1. The dual graphs of the minimal good resolution of $\text{Spec}(R(\mathbb{P}_k^1, D))$ are the following:

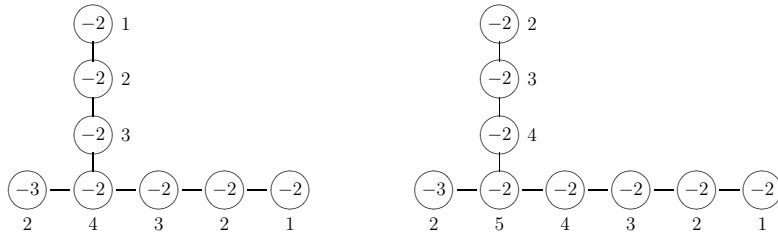

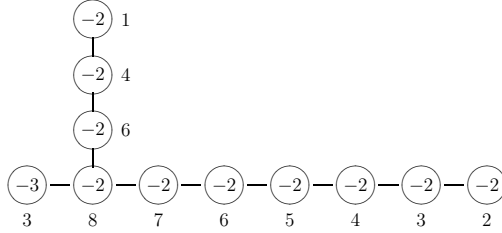
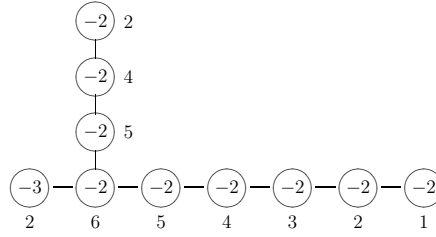

Therefore $e(R(\mathbb{P}_k^1, D)) = 4$ when $3 \leq n \leq 5$ and $e(R(\mathbb{P}_k^1, D)) = 5$ when $n = 6$. □

5.3. The case there is unique (-4) -curve. In this subsection we classify the $R(\mathbb{P}_k^1, D)$ with a rational singularity such that there is unique (-4) -curve in the dual graph of the minimal good resolution of $\text{Spec}(R(\mathbb{P}_k^1, D))$ and others are (-2) -curves. First, we consider the case the central curve is a (-4) -curve.

Proposition 5.8. *Let $D = 4P_0 - \sum_{i=1}^4 a_i P_i$ be an ample \mathbb{Q} -divisor on \mathbb{P}_k^1 , where $a_i \in \mathbb{Q}_{\geq 0}$ and P_i are distinct points of \mathbb{P}_k^1 . Assume that $a_1 = \frac{a}{a+1}$, $a_2 = \frac{b}{b+1}$, $a_3 = \frac{c}{c+1}$ and $a_4 = \frac{d}{d+1}$ for $a, b, c, d \in \mathbb{Z}_{\geq 0}$. Then $R(\mathbb{P}_k^1, D)$ has a rational singularity with $e(R(\mathbb{P}_k^1, D)) = 4$.*

Proof. $R(\mathbb{P}_k^1, D)$ has a rational singularity since $\deg[lD] \geq 0$ for any $l \in \mathbb{N}$. The dual graph of the minimal good resolution of $\text{Spec}(R(\mathbb{P}_k^1, D))$ is the following:

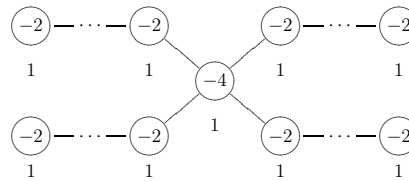

Therefore $e(R(\mathbb{P}_k^1, D)) = 4$. □

Next, we consider the case the central curve is a (-2) -curve.

Proposition 5.9. *Let $D = 2P_0 - \sum_{i=1}^3 a_i P_i$ be an ample \mathbb{Q} -divisor on \mathbb{P}_k^1 , where $a_i \in \mathbb{Q}_{\geq 0}$ and P_i are distinct points of \mathbb{P}_k^1 . Assume that $a_1 \leq a_2$, $a_1 = \frac{m}{m+1}$, $a_2 = \frac{n}{n+1}$, $\frac{1}{a_3} = [((2)^a, 4, (2)^b)]$ for $m, n, a, b \in \mathbb{Z}_{\geq 0}$ and $R(\mathbb{P}_k^1, D)$ has a rational*

singularity with $e(R(\mathbb{P}_k^1, D)) = 4$. Then (a_1, a_2, a_3) is one of the following:

- (1) $(0, \frac{n}{n+1}, \frac{(2a+1)b+3a+1}{(2a+3)b+3a+4})$ for $n \geq 0, a \geq 0, b \geq 0$,
- (2) $(\frac{1}{2}, \frac{n}{n+1}, \frac{b+1}{3b+4})$ for $n \geq 1, b \geq 0$
- (3) $(\frac{1}{2}, \frac{1}{2}, \frac{(2a+1)b+3a+1}{(2a+3)b+3a+4})$ for $a \geq 1, b \geq 0$,
- (4) $(\frac{1}{2}, \frac{2}{3}, \frac{3b+4}{5b+7})$ for $b \geq 0$,
- (5) $(\frac{1}{2}, \frac{2}{3}, \frac{5b+7}{7b+10})$ for $b \geq 0$,
- (6) $(\frac{1}{2}, \frac{2}{3}, \frac{7b+10}{9b+13})$ for $b \geq 0$,
- (7) $(\frac{1}{2}, \frac{3}{4}, \frac{3b+4}{5b+7})$ for $b \geq 0$,
- (8) $(\frac{1}{2}, \frac{4}{5}, \frac{3b+4}{5b+7})$ for $b \geq 0$,
- (9) $(\frac{1}{2}, \frac{5}{6}, \frac{4}{7})$,
- (10) $(\frac{1}{2}, \frac{6}{7}, \frac{4}{7})$,
- (11) $(\frac{2}{3}, \frac{n}{n+1}, \frac{b+1}{3b+4})$ for $n \geq 2, b \geq 0$,
- (12) $(\frac{3}{4}, \frac{n}{n+1}, \frac{1}{4})$ for $n \geq 3$.

Proof. Case 1. We assume that $m = 0$. Then $R(\mathbb{P}_k^1, D)$ has a rational singularity since $\deg[lD] \geq 0$ for any $l \in \mathbb{N}$. The dual graph of the minimal good resolution of $\text{Spec}(R(\mathbb{P}_k^1, D))$ is the following:

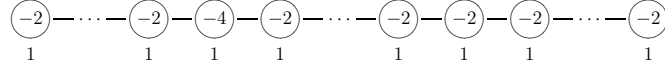

Therefore $e(R(\mathbb{P}_k^1, D)) = 4$.

Case 2. We assume that $m = 1$ and $a = 0$. Note that $D \geq 2P_0 - \frac{1}{2}P_1 - \frac{n}{n+1}P_2 - \frac{1}{2}P_3$ by Lemma 2.9. Therefore $R(\mathbb{P}_k^1, D)$ has a rational singularity by Lemma 5.1 and Lemma 5.5. The dual graph of the minimal good resolution of $\text{Spec}(R(\mathbb{P}_k^1, D))$ is the following:

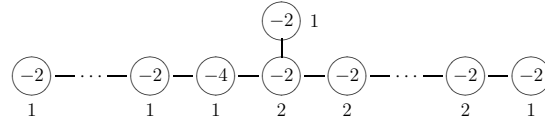

Therefore $e(R(\mathbb{P}_k^1, D)) = 4$.

Case 3. We assume that $m = n = 1$ and $a \geq 1$. Note that $D \geq 2P_0 - \frac{1}{2}P_1 - \frac{1}{2}P_2 - \frac{a+b+1}{a+b+2}P_3$ by Lemma 2.9. Therefore $R(\mathbb{P}_k^1, D)$ has a rational singularity by Lemma 5.1 and Lemma 5.5. The dual graph of the minimal good resolution of $\text{Spec}(R(\mathbb{P}_k^1, D))$ is the following:

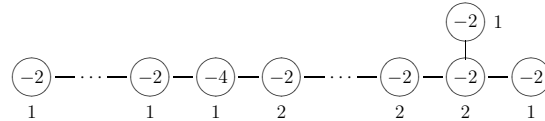

Therefore $e(R(\mathbb{P}_k^1, D)) = 4$.

Case 4. We assume that $m = 1$, $n = 2$ and $1 \leq a \leq 3$. Note that $D \geq 2P_0 - \frac{1}{2}P_1 - \frac{2}{3}P_2 - \frac{4}{5}P_3$ by Lemma 2.9. Therefore $R(\mathbb{P}_k^1, D)$ has a rational singularity by Lemma 5.1 and Lemma 5.5. The dual graphs of the minimal good resolution of $\text{Spec}(R(\mathbb{P}_k^1, D))$ are the following:

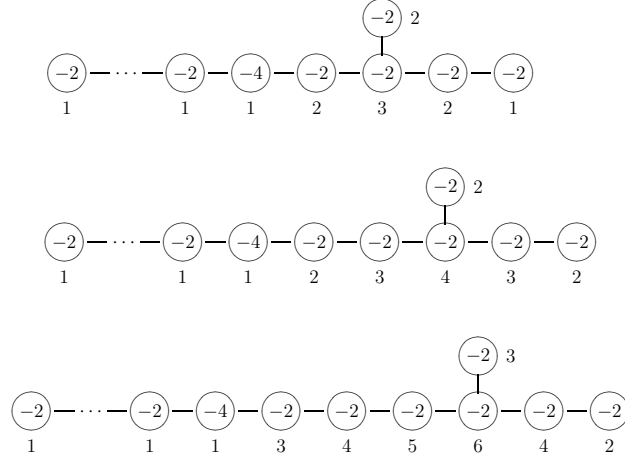

Therefore $e(R(\mathbb{P}_k^1, D)) = 4$.

Case 5. Assume one of the following holds:

- (i) $m = 1$, $n = 2$ and $a \geq 4$.
- (ii) $m = 1$, $n \geq 3$ and $a \geq 2$.
- (iii) $m = 1$, $n \geq 7$, $a \geq 1$ and $b \geq 1$.
- (iv) $m = 1$, $n \geq 9$ and $a \geq 1$.
- (v) $m \geq 2$ and $a \geq 1$.

Then $R(\mathbb{P}_k^1, D)$ does not have a rational singularity since there exists $l \in \{2, 3, 5, 7, 9\}$ such that $\deg[lD] \leq -2$.

Case 6. We assume that $m = 1$, $3 \leq n \leq 6$ and $a = 1$. Note that $\frac{5}{3} = [[2, 3]]$ and $D \geq 2P_0 - \frac{1}{2}P_1 - \frac{6}{7}P_2 - \frac{3}{5}P_3$ by Lemma 2.9. Therefore $R(\mathbb{P}_k^1, D)$ has a rational singularity by Lemma 5.1 and Proposition 5.7(ii)(5). The dual graphs of the minimal good resolution of $\text{Spec}(R(\mathbb{P}_k^1, D))$ are the following:

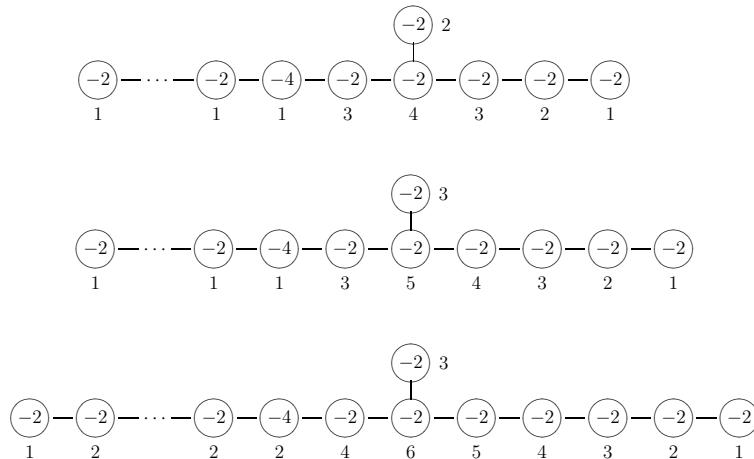

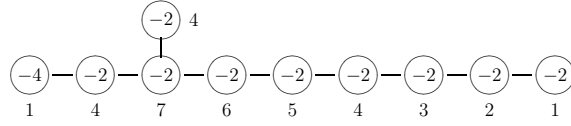
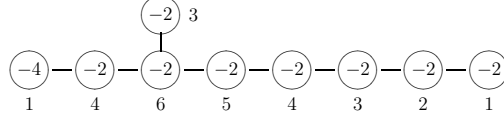
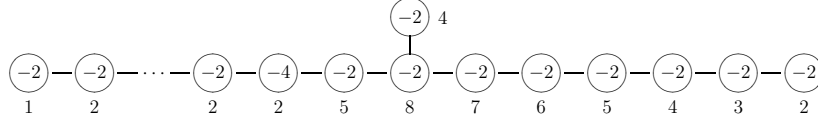

Therefore $e(R(\mathbb{P}_k^1, D)) = 4$ when $n = 3, 4$ or $n = 5, 6$ and $b = 0$ and $e(R(\mathbb{P}_k^1, D)) = 6$ when $n = 5, 6$ and $b \geq 1$.

Case 7. Assume one of the following holds:

- (i) $m = 1$, $7 \leq n \leq 8$, $a = 1$ and $b = 0$.
- (ii) $m = 3$, $a = 0$ and $b \geq 1$.
- (iii) $m \geq 4$ and $a = 0$.

In this case, we have $e(R(\mathbb{P}_k^1, D)) \geq 6$. We consider only case (i) since we can apply the same argument to case (ii) and (iii). Let E_0 be the central curve of the minimal good resolution of $\text{Spec}(R(\mathbb{P}_k^1, D))$ and E_1 be the (-4) -curve in its dual graph. Let Z be the fundamental cycle of the minimal good resolution of $\text{Spec}(R(\mathbb{P}_k^1, D))$. We have $\text{Coeff}_{E_0}(Z) \geq 8$ by Corollary 2.22. Therefore $\text{Coeff}_{E_1}(Z) \geq 2$ by Lemma 2.21. Hence $e(R(\mathbb{P}_k^1, D)) \geq 6$.

Case 8. We assume that $m = 2$ and $a = 0$. Note that $D \geq 2P_0 - \frac{2}{3}P_1 - \frac{n}{n+1}P_2 - \frac{1}{3}P_3$ by Lemma 2.9. Therefore $R(\mathbb{P}_k^1, D)$ has a rational singularity by Lemma 5.1 and Proposition 5.7(i)(9). The dual graph of the minimal good resolution of $\text{Spec}(R(\mathbb{P}_k^1, D))$ is the following:

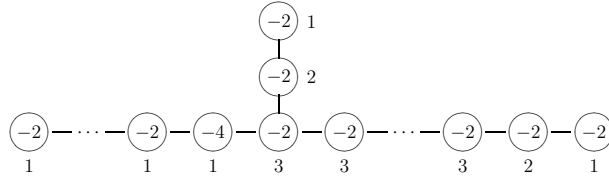

Therefore $e(R(\mathbb{P}_k^1, D)) = 4$.

Case 9. We assume that $m = 3$ and $a = b = 0$. Then $R(\mathbb{P}_k^1, D)$ has a rational singularity since $\deg[lD] \geq 2l + [-\frac{3l}{4}] - l + [-\frac{l}{4}] = [\frac{l}{4}] + [-\frac{l}{4}] \geq -1$ for any $l \in \mathbb{N}$.

The dual graph of the minimal good resolution of $\text{Spec}(R(\mathbb{P}_k^1, D))$ is the following:

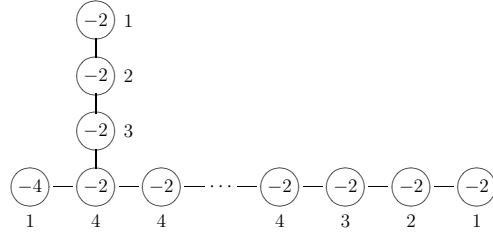

Therefore $e(R(\mathbb{P}_k^1, D)) = 4$. □

5.4. The case there are two (-3) -curves. In this subsection we classify the $R(\mathbb{P}_k^1, D)$ with a rational singularity such that there are two (-3) -curves in the dual graph of the minimal good resolution of $\text{Spec}(R(\mathbb{P}_k^1, D))$ and others are (-2) -curves. First, we consider the case the central curve is a (-3) -curve.

Proposition 5.10. *Let $D = 3P_0 - \sum_{i=1}^3 a_i P_i$ be an ample \mathbb{Q} -divisor on \mathbb{P}_k^1 , where $a_i \in \mathbb{Q}_{\geq 0}$ and P_i are distinct points of \mathbb{P}_k^1 . Assume that $a_1 = \frac{m}{m+1}$, $a_2 = \frac{n}{n+1}$, $\frac{1}{a_3} = [(2)^a, 3, (2)^b]$ for $m, n, a, b \in \mathbb{Z}_{\geq 0}$. Then $R(\mathbb{P}_k^1, D)$ has a rational singularity with $e(R(\mathbb{P}_k^1, D)) = 4$.*

Proof. $R(\mathbb{P}_k^1, D)$ has a rational singularity since $\deg[lD] \geq 0$ for any $l \in \mathbb{N}$. The dual graph of the minimal good resolution of $\text{Spec}(R(\mathbb{P}_k^1, D))$ is the following:

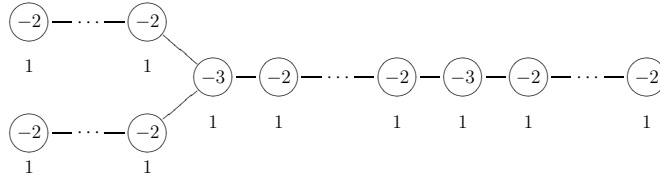

Therefore $e(R(\mathbb{P}_k^1, D)) = 4$. □

Next, we consider the case the central curve is a (-2) -curve and there are two (-3) -curves in one branch.

Proposition 5.11. *Let $D = 2P_0 - \sum_{i=1}^3 a_i P_i$ be an ample \mathbb{Q} -divisor on \mathbb{P}_k^1 , where $a_i \in \mathbb{Q}_{\geq 0}$ and P_i are distinct points of \mathbb{P}_k^1 . Assume that $a_1 \leq a_2$, $a_1 = \frac{m}{m+1}$, $a_2 = \frac{n}{n+1}$, $\frac{1}{a_3} = [(2)^a, 3, (2)^b, 3, (2)^c]$ for $m, n, a, b, c \in \mathbb{Z}_{\geq 0}$ and $R(\mathbb{P}_k^1, D)$ has a*

rational singularity with $e(R(\mathbb{P}_k^1, D)) = 4$. Then (a_1, a_2, a_3) is one of the following:

- (1) $(0, \frac{n}{n+1}, \frac{((a+1)b+3a+2)c+(2a+2)b+5a+3}{((a+2)b+3a+5)c+(2a+4)b+5a+8})$ for $n, a, b, c \geq 0$,
- (2) $(\frac{1}{2}, \frac{n}{n+1}, \frac{(b+2)c+2b+3}{(2b+5)c+4b+8})$ for $n \geq 1, b \geq 0, c \geq 0$,
- (3) $(\frac{1}{2}, \frac{1}{2}, \frac{((a+1)b+3a+2)c+(2a+2)b+5a+3}{((a+2)b+3a+5)c+(2a+4)b+5a+8})$ for $a \geq 1, b \geq 0, c \geq 0$,
- (4) $(\frac{1}{2}, \frac{2}{3}, \frac{(2b+5)c+4b+8}{(3b+8)c+6b+13})$ for $b \geq 0, c \geq 0$,
- (5) $(\frac{1}{2}, \frac{2}{3}, \frac{(3b+8)c+6b+13}{(4b+11)c+8b+18})$ for $b \geq 0, c \geq 0$.

Proof. Case 1. We assume that $m = 0$. Then $R(\mathbb{P}_k^1, D)$ has a rational singularity since $\deg[lD] \geq 0$ for any $l \in \mathbb{N}$. The dual graph of the minimal good resolution of $\text{Spec}(R(\mathbb{P}_k^1, D))$ is the following:

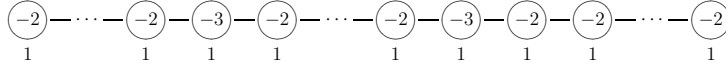

Therefore $e(R(\mathbb{P}_k^1, D)) = 4$.

Case 2. We assume that $m = 1$ and $a = 0$. Note that $D \geq 2P_0 - \frac{1}{2}P_1 - \frac{n}{n+1}P_2 - \frac{1}{2}P_3$ by Lemma 2.9. Therefore $R(\mathbb{P}_k^1, D)$ has a rational singularity by Lemma 5.1 and Lemma 5.5. The dual graph of the minimal good resolution of $\text{Spec}(R(\mathbb{P}_k^1, D))$ is the following:

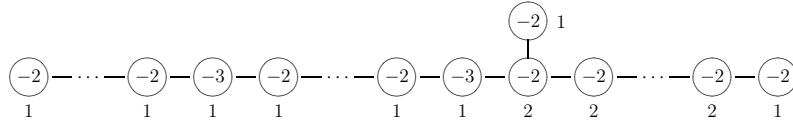

Therefore $e(R(\mathbb{P}_k^1, D)) = 4$.

Case 3. We assume that $m = n = 1$ and $a \geq 1$. Note that $D \geq 2P_0 - \frac{1}{2}P_1 - \frac{1}{2}P_2 - \frac{a+b+c+2}{a+b+c+3}P_3$ by Lemma 2.9. Therefore $R(\mathbb{P}_k^1, D)$ has a rational singularity by Lemma 5.1 and Lemma 5.5. The dual graph of the minimal good resolution of $\text{Spec}(R(\mathbb{P}_k^1, D))$ is the following:

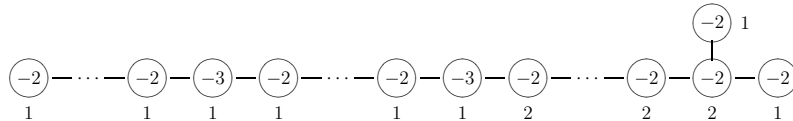

Therefore $e(R(\mathbb{P}_k^1, D)) = 4$.

Case 4. We assume that $m = 1, n = 2$ and $1 \leq a \leq 3$. Note that $D \geq 2P_0 - \frac{1}{2}P_1 - \frac{2}{3}P_2 - \frac{4}{5}P_3$ by Lemma 2.9. Therefore $R(\mathbb{P}_k^1, D)$ has a rational singularity by Lemma 5.1 and Lemma 5.5. The dual graph of the minimal good resolution

of $\text{Spec}(R(\mathbb{P}_k^1, D))$ is the following:

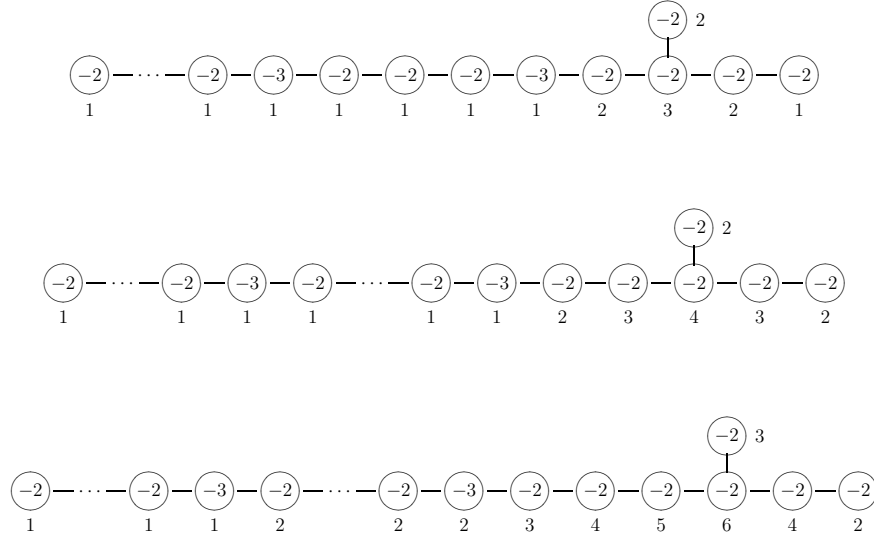

Therefore $e(R(\mathbb{P}_k^1, D)) = 4$ when $a = 1, 2$ and $e(R(\mathbb{P}_k^1, D)) = 5$ when $a = 3$.

Case 5. Assume one of the following holds:

- (i) $m = 1, n = 2$ and $a \geq 4$.
- (ii) $m = 1, n \geq 3$ and $a \geq 2$.
- (iii) $m \geq 2$ and $a \geq 1$.

Then $R(\mathbb{P}_k^1, D)$ does not have a rational singularity since there exists $l \in \{2, 3, 5\}$ such that $\deg[lD] \leq -2$.

Case 6. Assume one of the following holds:

- (i) $m = 1, n \geq 3$ and $a = 1$.
- (ii) $m \geq 2$ and $a = 0$.

In this case, we have $e(R(\mathbb{P}_k^1, D)) \geq 5$. We consider only case (i) since we can apply the same argument to case (ii). Let E_0 be the central curve of the minimal good resolution of $\text{Spec}(R(\mathbb{P}_k^1, D))$ and E_1, E_2 be the (-3) -curves in its dual graph. Let Z be the fundamental cycle of the minimal good resolution of $\text{Spec}(R(\mathbb{P}_k^1, D))$. We have $\text{Coeff}_{E_0}(Z) \geq 4$ by Corollary 2.22. Therefore $\text{Coeff}_{E_1}(Z) + \text{Coeff}_{E_2}(Z) \geq 3$ by Lemma 2.21. Hence $e(R(\mathbb{P}_k^1, D)) \geq 5$. □

Finally, we consider the case the central curve is a (-2) -curve and there is one (-3) -curve in one branch.

Proposition 5.12. *Let $D = 2P_0 - \sum_{i=1}^3 a_i P_i$ be an ample \mathbb{Q} -divisor on \mathbb{P}_k^1 , where $a_i \in \mathbb{Q}_{\geq 0}$ and P_i are distinct points of \mathbb{P}_k^1 . Assume that $a_2 \leq a_3, a_1 = \frac{m}{m+1}, \frac{1}{a_2} = [((2)^a, 3, (2)^b)]$, $\frac{1}{a_3} = [((2)^c, 3, (2)^d)]$ for $m, a, b, c, d \in \mathbb{Z}_{\geq 0}$ and $R(\mathbb{P}_k^1, D)$ has a*

rational singularity with $e(R(\mathbb{P}_k^1, D)) = 4$. Then (a_1, a_2, a_3) is one of the following:

- (1) $(0, \frac{(a+1)b+2a+1}{(a+2)b+2a+3}, \frac{(c+1)d+2c+1}{(c+2)d+2c+3})$ for $a \geq 0, b \geq 0, c \geq 0, d \geq 0$
- (2) $(\frac{m}{m+1}, \frac{b+1}{2b+3}, \frac{d+1}{2d+3})$ for $m \geq 1, b \geq 0, d \geq 0$
- (3) $(\frac{1}{2}, \frac{b+1}{2b+3}, \frac{(c+1)d+2c+1}{(c+2)d+2c+3})$ for $b \geq 0, c \geq 1, d \geq 0$
- (4) $(\frac{1}{2}, \frac{2b+3}{3b+5}, \frac{2d+3}{3d+5})$ for $b \geq 0, d \geq 0$,
- (5) $(\frac{1}{2}, \frac{3}{5}, \frac{3d+5}{4d+7})$ for $d \geq 0$,
- (6) $(\frac{1}{2}, \frac{3}{5}, \frac{4d+7}{5d+9})$ for $d \geq 0$,
- (7) $(\frac{2}{3}, \frac{1}{3}, \frac{(c+1)d+2c+1}{(c+2)d+2c+3})$ for $c \geq 1, d \geq 0$,
- (8) $(\frac{m}{m+1}, \frac{1}{3}, \frac{2d+3}{3d+5})$ for $m \geq 1, d \geq 0$.

Proof. Note that $a \leq c$ by Lemma 2.9.

Case 1. We assume that $m = 0$. Then $R(\mathbb{P}_k^1, D)$ has a rational singularity since $\deg[lD] \geq 0$ for any $l \in \mathbb{N}$. The dual graph of the minimal good resolution of $\text{Spec}(R(\mathbb{P}_k^1, D))$ is the following:

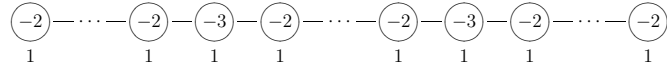

Therefore $e(R(\mathbb{P}_k^1, D)) = 4$.

Case 2. We assume that $m \geq 1$ and $a = c = 0$. Note that $D \geq 2P_0 - \frac{m}{m+1}P_1 - \frac{1}{2}P_2 - \frac{1}{2}P_3$ by Lemma 2.9. Therefore $R(\mathbb{P}_k^1, D)$ has a rational singularity by Lemma 5.1 and Lemma 5.5. The dual graph of the minimal good resolution of $\text{Spec}(R(\mathbb{P}_k^1, D))$ is the following:

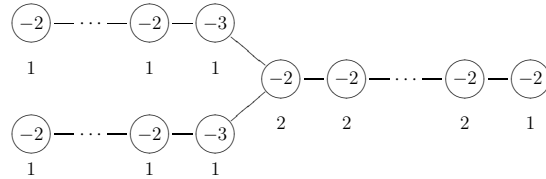

Therefore $e(R(\mathbb{P}_k^1, D)) = 4$.

Case 3. We assume that $m = 1$, $a = 0$ and $c \geq 1$. Note that $D \geq 2P_0 - \frac{1}{2}P_1 - \frac{1}{2}P_2 - \frac{c+d+1}{c+d+2}P_3$ by Lemma 2.9. Therefore $R(\mathbb{P}_k^1, D)$ has a rational singularity by Lemma 5.1 and Lemma 5.5. The dual graph of the minimal good resolution of

$\text{Spec}(R(\mathbb{P}_k^1, D))$ is the following:

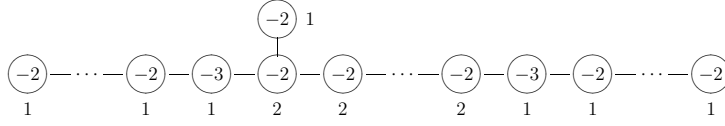

Therefore $e(R(\mathbb{P}_k^1, D)) = 4$.

Case 4. We assume that $m = 1$, $a = 1$ and $1 \leq c \leq 3$. Note that $D \geq 2P_0 - \frac{1}{2}P_1 - \frac{2}{3}P_2 - \frac{4}{5}P_3$ by Lemma 2.9. Therefore $R(\mathbb{P}_k^1, D)$ has a rational singularity by Lemma 5.1 and Lemma 5.5. The dual graphs of the minimal good resolution of $\text{Spec}(R(\mathbb{P}_k^1, D))$ are the following:

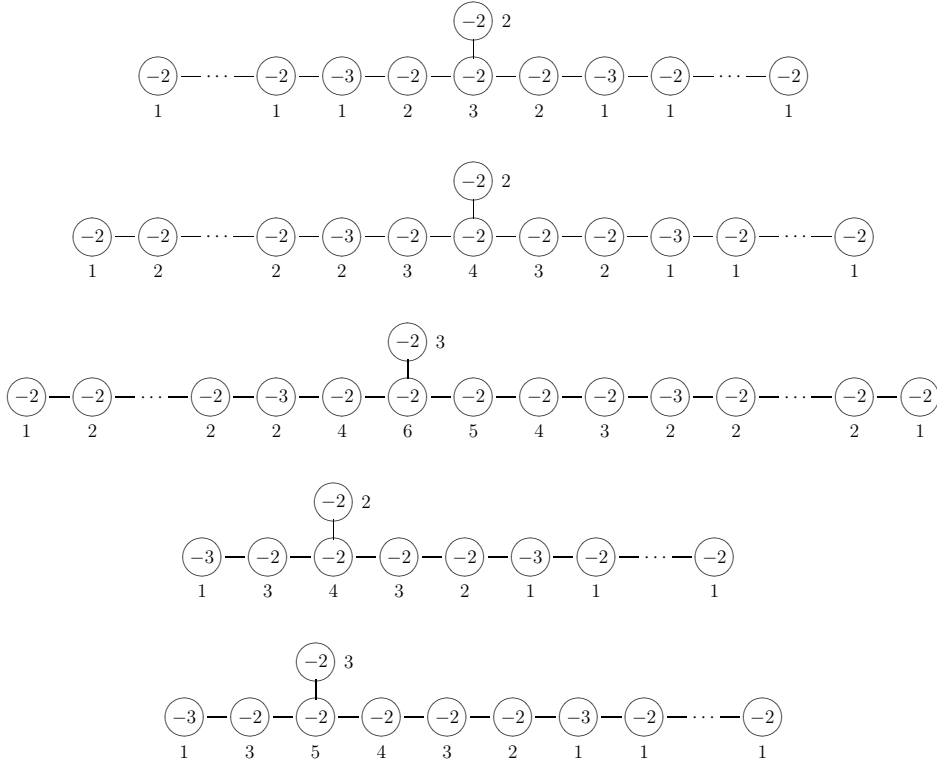

Therefore $e(R(\mathbb{P}_k^1, D)) = 4$ when $c = 1$ or $c = 2, 3$ and $b = 0$, $e(R(\mathbb{P}_k^1, D)) = 5$ when $c = 2$ and $b \geq 1$ and $e(R(\mathbb{P}_k^1, D)) = 6$ when $c = 3$ and $b \geq 1$.

Case 5. Assume one of the following holds:

- (i) $m = 1$, $a = 1$ and $c \geq 4$.
- (ii) $m \geq 2$, $a = 0$, $b \geq 1$ and $c \geq 1$.
- (iii) $m \geq 3$, $a = b = 0$ and $c \geq 2$.

In this case, we have $e(R(\mathbb{P}_k^1, D)) \geq 5$. We consider only case (i) since we can apply the same argument to case (ii) and (iii). Let E_0 be the central curve of the minimal good resolution of $\text{Spec}(R(\mathbb{P}_k^1, D))$ and E_1 be the (-3) -curve in the branch corresponding to P_2 in its dual graph. Let Z be the fundamental cycle of the minimal good resolution of $\text{Spec}(R(\mathbb{P}_k^1, D))$. We have $\text{Coeff}_{E_0}(Z) \geq 6$ by Corollary 2.22. By Lemma 2.21, we have $\text{Coeff}_{E_1}(Z) \geq 2$. Hence $e(R(\mathbb{P}_k^1, D)) \geq 5$.

Case 6. Assume one of the following holds:

- (1) $m \geq 1$, $a \geq 2$ and $c \geq 2$.
- (2) $m \geq 2$ and $a \geq 1$.

Then $R(\mathbb{P}_k^1, D)$ does not have a rational singularity since there exists $l \in \{2, 3\}$ such that $\deg[lD] \leq -2$.

Case 7. We assume that $m = 2$, $a = b = 0$ and $c \geq 1$. Note that $D \geq 2P_0 - \frac{2}{3}P_1 - \frac{1}{3}P_2 - \frac{c+d+1}{c+d+2}P_3$ by Lemma 2.9. Therefore $R(\mathbb{P}_k^1, D)$ has a rational singularity by Lemma 5.1 and Proposition 5.7.(i).(9). The dual graph of the minimal good resolution of $\text{Spec}(R(\mathbb{P}_k^1, D))$ is the following:

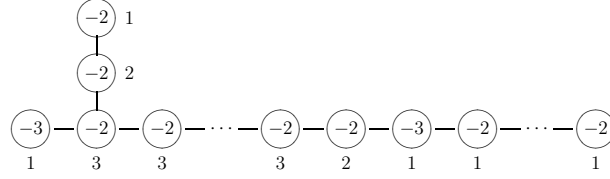

Therefore $e(R(\mathbb{P}_k^1, D)) = 4$.

Case 8. We assume that $m \geq 3$, $a = b = 0$ and $c = 1$. Note that $D \geq 2P_0 - \frac{m}{m+1}P_1 - \frac{1}{3}P_2 - \frac{2}{3}P_3$ by Lemma 2.9. Therefore $R(\mathbb{P}_k^1, D)$ has a rational singularity by Lemma 5.1 and Proposition 5.7.(i).(9). The dual graph of the minimal good resolution of $\text{Spec}(R(\mathbb{P}_k^1, D))$ is the following:

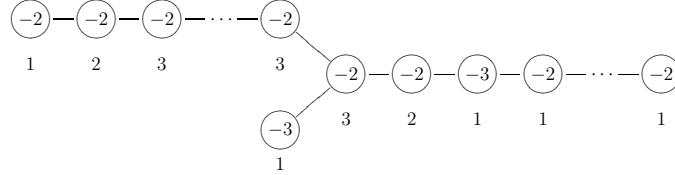

Therefore $e(R(\mathbb{P}_k^1, D)) = 4$. □

5.5. Classification of $R(\mathbb{P}_k^1, D)$ which is a rational triple point and rational fourth point. In this subsection, we summarize our results of this section in the following theorem.

Theorem 5.13. *Let $D = sP_0 - \sum_{i=1}^r a_i P_i$ be an ample \mathbb{Q} -divisor on \mathbb{P}_k^1 , where $s \in \mathbb{N}$ and $a_i \in \mathbb{Q}$ with $0 \leq a_i < 1$ and P_i are distinct points of \mathbb{P}_k^1 . Assume that $R(\mathbb{P}_k^1, D)$ has a rational singularity. Suppose if $T(\frac{1}{a_i}) = T(\frac{1}{a_j})$ for $i < j$, then $a_i \leq a_j$, and if $T(\frac{1}{a_i}) = \emptyset$ and $T(\frac{1}{a_j}) \neq \emptyset$, then $i < j$, where $T(*)$ is defined in Definition 4.2.*

(1) If $e(R(\mathbb{P}_k^1, D)) = 3$, then (s, a_1, \dots, a_r) is one of the following: Here, n, a, b, c are any non-negative integers.

1. $(3, \frac{a}{a+1}, \frac{b}{b+1}, \frac{c}{c+1})$,
2. $(2, 0, \frac{n}{n+1}, \frac{(a+1)b+2a+1}{(a+2)b+2a+3})$,
3. $(2, \frac{1}{2}, \frac{n+1}{n+2}, \frac{b+1}{2b+3})$,
4. $(2, \frac{1}{2}, \frac{1}{2}, \frac{(a+2)b+2a+3}{(a+3)b+2a+5})$,
5. $(2, \frac{1}{2}, \frac{2}{3}, \frac{2b+3}{3b+5})$,
6. $(2, \frac{1}{2}, \frac{2}{3}, \frac{3b+5}{4b+7})$,
7. $(2, \frac{1}{2}, \frac{2}{3}, \frac{7}{9})$,

8. $(2, \frac{1}{2}, \frac{3}{4}, \frac{3}{5})$, 9. $(2, \frac{1}{2}, \frac{4}{5}, \frac{3}{5})$, 10. $(2, \frac{2}{3}, \frac{n+2}{n+3}, \frac{1}{3})$,

(2) If $e(R(\mathbb{P}_k^1, D)) = 4$, then (s, a_1, \dots, a_r) is one of the following: Here, m, n, a, b, c, d are any non-negative integers.

- | | | |
|---|---|--|
| 1. $(3, \frac{1}{2}, \frac{1}{2}, \frac{c}{c+1}, \frac{d}{d+1})$, | 2. $(2, \frac{1}{2}, \frac{2}{3}, \frac{4b+11}{5b+14})$, | 3. $(2, \frac{1}{2}, \frac{3}{4}, \frac{2b+5}{3b+8})$, |
| 4. $(2, \frac{1}{2}, \frac{4}{5}, \frac{2b+5}{3b+8})$, | 5. $(2, \frac{1}{2}, \frac{5}{6}, \frac{3}{5})$, | 6. $(2, \frac{1}{2}, \frac{6}{7}, \frac{3}{5})$, |
| 7. $(2, \frac{2}{3}, \frac{2}{3}, \frac{b+2}{2b+5})$, | 8. $(2, \frac{2}{3}, \frac{3}{4}, \frac{b+2}{2b+5})$, | 9. $(2, \frac{2}{3}, \frac{4}{5}, \frac{2}{5})$, |
| 10. $(2, \frac{3}{4}, \frac{3}{4}, \frac{1}{3})$, | 11. $(2, \frac{3}{4}, \frac{4}{5}, \frac{1}{3})$, | 12. $(2, \frac{3}{4}, \frac{5}{6}, \frac{1}{3})$, |
| 13. $(4, \frac{a}{a+1}, \frac{b}{b+1}, \frac{c}{c+1}, \frac{d}{d+1})$, | 14. $(2, 0, \frac{n}{n+1}, \frac{(2a+1)b+3a+1}{(2a+3)b+3a+4})$, | |
| 15. $(2, \frac{1}{2}, \frac{n+1}{n+2}, \frac{b+1}{3b+4})$, | 16. $(2, \frac{1}{2}, \frac{1}{2}, \frac{(2a+3)b+3a+4}{(2a+5)b+3a+7})$, | |
| 17. $(2, \frac{1}{2}, \frac{2}{3}, \frac{3b+4}{5b+7})$, | 18. $(2, \frac{1}{2}, \frac{2}{3}, \frac{5b+7}{7b+10})$, | 19. $(2, \frac{1}{2}, \frac{2}{3}, \frac{7b+10}{9b+13})$, |
| 20. $(2, \frac{1}{2}, \frac{3}{4}, \frac{3b+4}{5b+7})$, | 21. $(2, \frac{1}{2}, \frac{4}{5}, \frac{3b+4}{5b+7})$, | 22. $(2, \frac{1}{2}, \frac{5}{6}, \frac{4}{7})$, |
| 23. $(2, \frac{1}{2}, \frac{6}{7}, \frac{4}{7})$, | 24. $(2, \frac{2}{3}, \frac{n+2}{n+3}, \frac{b+1}{3b+4})$, | 25. $(2, \frac{3}{4}, \frac{n+3}{n+4}, \frac{1}{4})$, |
| 26. $(3, \frac{m}{m+1}, \frac{n}{n+1}, \frac{(a+1)b+2a+1}{(a+2)b+2a+3})$, | | |
| 27. $(2, 0, \frac{n}{n+1}, \frac{((a+1)b+3a+2)c+(2a+2)b+5a+3}{((a+2)b+3a+5)c+(2a+4)b+5a+8})$, | | |
| 28. $(2, \frac{1}{2}, \frac{n+1}{n+2}, \frac{(b+2)c+2b+3}{(2b+5)c+4b+8})$, | | |
| 29. $(2, \frac{1}{2}, \frac{1}{2}, \frac{((a+2)b+3a+5)c+(2a+4)b+5a+8}{((a+3)b+3a+8)c+(2a+6)b+5a+13})$, | | |
| 30. $(2, \frac{1}{2}, \frac{2}{3}, \frac{(2b+5)c+4b+8}{(3b+8)c+6b+13})$, | 31. $(2, \frac{1}{2}, \frac{2}{3}, \frac{(3b+8)c+6b+13}{(4b+11)c+8b+18})$, | |
| 32. $(2, 0, \frac{(a+1)b+2a+1}{(a+2)b+2a+3}, \frac{(c+1)d+2c+1}{(c+2)d+2c+3})$, | 33. $(2, \frac{m+1}{m+2}, \frac{b+1}{2b+3}, \frac{d+1}{2d+3})$, | |
| 34. $(2, \frac{1}{2}, \frac{b+1}{2b+3}, \frac{(c+2)d+2c+3}{(c+3)d+2c+5})$, | 35. $(2, \frac{1}{2}, \frac{2b+3}{3b+5}, \frac{2d+3}{3d+5})$, | |
| 36. $(2, \frac{1}{2}, \frac{3}{5}, \frac{3d+5}{4d+7})$, | 37. $(2, \frac{1}{2}, \frac{3}{5}, \frac{4d+7}{5d+9})$, | |
| 38. $(2, \frac{2}{3}, \frac{1}{3}, \frac{(c+2)d+2c+3}{(c+3)d+2c+5})$, | 39. $(2, \frac{m+1}{m+2}, \frac{1}{3}, \frac{2d+3}{3d+5})$. | |

6. F-RATIONALITY OF TWO-DIMENSIONAL GRADED RINGS WITH RATIONAL TRIPLE POINT AND RATIONAL FOURTH POINT

In this section, we determine $p(3)$ and $p(4)$ in Theorem 1.3 using the classification in Section 5.

We can reduce the calculation to check the F -rationality of $R(\mathbb{P}_k^1, D)$ using the following lemma when we prove the theorems in this section.

Lemma 6.1. *Let $D = 2P_0 - \sum_{i=1}^3 b_i P_i$ be an ample \mathbb{Q} -divisor on \mathbb{P}_k^1 , where $b_i \in \mathbb{Q}_{>0}$ and P_i are distinct points of \mathbb{P}_k^1 .*

- (1) *If $(b_1, b_2, b_3) = (\frac{1}{2}, \frac{1}{2}, \frac{n}{n+1})$ for $n \in \mathbb{N}$, then $\deg[-lD] \leq -2$ for $l \in \mathbb{N} \setminus 2\mathbb{N}$ and $\deg[-lD] \leq -1$ for $l \in 2\mathbb{N}$.*
- (2) *If $(b_1, b_2, b_3) = (\frac{1}{2}, \frac{2}{3}, \frac{3}{4})$, then $\deg[-lD] \leq -2$ for $l \in \mathbb{N}$ with $l \neq 2, 3, 4, 6, 8, 12$.*
- (3) *If $(b_1, b_2, b_3) = (\frac{1}{2}, \frac{2}{3}, \frac{4}{5})$, then $\deg[-lD] \leq -2$ for $l \in \mathbb{N}$ with $l \neq 2, 3, 4, 5, 6, 8, 9, 10, 12, 14, 15, 18, 20, 24, 30$.*

- (4) If $(b_1, b_2, b_3) = (\frac{1}{3}, \frac{2}{3}, \frac{n}{n+1})$ for $n \in \mathbb{N}$, then $\deg[-lD] \leq -2$ for $l \in \mathbb{N} \setminus 3\mathbb{N}$ and $\deg[-lD] \leq -1$ for $l \in 3\mathbb{N}$.
- (5) If $(b_1, b_2, b_3) = (\frac{1}{4}, \frac{3}{4}, \frac{n}{n+1})$ for $n \in \mathbb{N}$, then $\deg[-lD] \leq -2$ for $l \in \mathbb{N} \setminus 4\mathbb{N}$ and $\deg[-lD] \leq -1$ for $l \in 4\mathbb{N}$.

Proof. This lemma follows immediately by direct computation. \square

Theorem 6.2. *Let R be a two-dimensional graded ring with $e(R) = 3$ and a rational singularity. If $p \geq 7$, then R is F -rational. Furthermore, this inequality is best possible.*

Proof. Example 4.6 shows that there exists a two-dimensional non- F -rational graded ring R with a rational singularity, $e(R) = 3$ and $p = 5$.

From now on, we assume that $p \geq 7$. By Theorem 2.12, Theorem 2.16 and Theorem 5.13, there exists an ample \mathbb{Q} -divisor D on \mathbb{P}_k^1 in the list of Theorem 5.13.(1) with $R \cong R(\mathbb{P}_k^1, D)$. Let $D = sP_0 - \sum_{i=1}^3 a_i P_i$, where $s \in \mathbb{N}$, $0 \leq a_i < 1$ and P_i are distinct points of \mathbb{P}_k^1 . Let n, a, b, c be non-negative integers. If necessary, we switch the order of (a_1, a_2, a_3) .

Case 1. We assume that (s, a_1, a_2, a_3) is one of the followings:

$$(3, \frac{a}{a+1}, \frac{b}{b+1}, \frac{c}{c+1}), \quad (2, 0, \frac{n}{n+1}, \frac{(a+1)b+2a+1}{(a+2)b+2a+3}).$$

Then $R(\mathbb{P}_k^1, D)$ is F -rational by Proposition 3.3.(1).

Case 2. We assume that $s = 2$ and (a_1, a_2, a_3) is one of the followings:

$$(\frac{1}{2}, \frac{2}{3}, \frac{7}{9}), \quad (\frac{1}{2}, \frac{3}{4}, \frac{3}{5}), \quad (\frac{1}{2}, \frac{4}{5}, \frac{3}{5}).$$

Then $R(\mathbb{P}_k^1, D)$ is F -rational by Theorem 3.6.

Case 3. We assume that $s = 2$ and (a_1, a_2, a_3) is one of the followings:

$$(\frac{1}{2}, \frac{b+1}{2b+3}, \frac{n+1}{n+2}), \quad (\frac{1}{2}, \frac{1}{2}, \frac{(a+2)b+2a+3}{(a+3)b+2a+5}).$$

Then $D \geq 2P_0 - \frac{1}{2}P_1 - \frac{1}{2}P_2 - \frac{l}{l+1}P_3$ for sufficiently large number l . Therefore $R(\mathbb{P}_k^1, D)$ is F -rational by Theorem 3.1 and Lemma 6.1.

Case 4. We assume that $s = 2$ and (a_1, a_2, a_3) is one of the followings:

$$(\frac{1}{2}, \frac{2}{3}, \frac{2b+3}{3b+5}), \quad (\frac{1}{2}, \frac{2}{3}, \frac{3b+5}{4b+7}).$$

Then $D \geq 2P_0 - \frac{1}{2}P_1 - \frac{2}{3}P_2 - \frac{3}{4}P_3$. Therefore $R(\mathbb{P}_k^1, D)$ is F -rational by Theorem 3.1 and Lemma 6.1.

Case 5. We assume that $(s, a_1, a_2, a_3) = (2, \frac{1}{3}, \frac{2}{3}, \frac{n+2}{n+3})$. Then $D \geq 2P_0 - \frac{1}{3}P_1 - \frac{2}{3}P_2 - \frac{l}{l+1}P_3$ for sufficiently large number l . Therefore $R(\mathbb{P}_k^1, D)$ is F -rational by Theorem 3.1 and Lemma 6.1.

By the above discussion, if $p \geq 7$, then R is F -rational. \square

Theorem 6.3. *Let R be a two-dimensional graded ring with $e(R) = 4$ and a rational singularity. If $p \geq 11$, then R is F -rational. Furthermore, this inequality is best possible.*

Proof. Example 4.6 shows that there exists a two-dimensional non- F -rational graded ring R with a rational singularity, $e(R) = 4$ and $p = 7$.

From now on, we assume that $p \geq 11$. By Theorem 2.12, Theorem 2.16 and Theorem 5.13, there exists an ample \mathbb{Q} -divisor D on \mathbb{P}_k^1 in the list of Theorem 5.13.(2) with $R \cong R(\mathbb{P}_k^1, D)$. Let $D = sP_0 - \sum_{i=1}^r a_i P_i$, where $s \in \mathbb{N}$, $0 \leq a_i < 1$ and P_i are distinct points of \mathbb{P}_k^1 . Let m, n, a, b, c, d be non-negative integers.

Case 1. We assume that $(s, a_1, \dots, a_r) = (3, \frac{1}{2}, \frac{1}{2}, \frac{c}{c+1}, \frac{d}{d+1})$. we have $\deg[-lD] \leq -2$ for $l \in 2\mathbb{N}$ and $\deg[-lD] \leq -3$ for $l \in \mathbb{N} \setminus 2\mathbb{N}$. Then $R(\mathbb{P}_k^1, D)$ is F -rational by Theorem 3.1.

Case 2. We assume that $s = 2$ and (a_1, a_2, a_3) is one of the followings:

$$\begin{aligned} & \left(\frac{1}{2}, \frac{5}{6}, \frac{3}{5}\right), \left(\frac{1}{2}, \frac{6}{7}, \frac{3}{5}\right), \left(\frac{2}{3}, \frac{4}{5}, \frac{2}{5}\right), \left(\frac{3}{4}, \frac{3}{4}, \frac{1}{3}\right), \\ & \left(\frac{3}{4}, \frac{4}{5}, \frac{1}{3}\right), \left(\frac{3}{4}, \frac{5}{6}, \frac{1}{3}\right), \left(\frac{1}{2}, \frac{5}{6}, \frac{4}{7}\right), \left(\frac{1}{2}, \frac{6}{7}, \frac{4}{7}\right). \end{aligned}$$

Then $R(\mathbb{P}_k^1, D)$ is F -rational by Theorem 3.6.

Case 3. We assume that (s, a_1, \dots, a_r) is one of the followings:

$$\begin{aligned} & \left(4, \frac{a}{a+1}, \frac{b}{b+1}, \frac{c}{c+1}, \frac{d}{d+1}\right), \quad \left(2, 0, \frac{n}{n+1}, \frac{(2a+1)b+3a+1}{(2a+3)b+3a+4}\right), \\ & \left(3, \frac{m}{m+1}, \frac{n}{n+1}, \frac{(a+1)b+2a+1}{(a+2)b+2a+3}\right), \\ & \left(2, 0, \frac{n}{n+1}, \frac{((a+1)b+3a+2)c+(2a+2)b+5a+3}{((a+2)b+3a+5)c+(2a+4)b+5a+8}\right), \\ & \left(2, 0, \frac{(a+1)b+2a+1}{(a+2)b+2a+3}, \frac{(c+1)d+2c+1}{(c+2)d+2c+3}\right). \end{aligned}$$

Then $R(\mathbb{P}_k^1, D)$ is F -rational by Proposition 3.3.(1).

In the rest of this proof, we always assume that $s = 2$ and $r = 3$. If necessary, we switch the order of (a_1, a_2, a_3) .

Case 4. We assume that (a_1, a_2, a_3) is one of the followings:

$$\begin{aligned} & \left(\frac{1}{2}, \frac{2}{3}, \frac{4b+11}{5b+14}\right), \left(\frac{1}{2}, \frac{2b+5}{3b+8}, \frac{3}{4}\right), \left(\frac{1}{2}, \frac{2b+5}{3b+8}, \frac{4}{5}\right), \left(\frac{b+2}{2b+5}, \frac{2}{3}, \frac{2}{3}\right), \\ & \left(\frac{b+2}{2b+5}, \frac{2}{3}, \frac{3}{4}\right), \left(\frac{1}{2}, \frac{2}{3}, \frac{3b+4}{5b+7}\right), \left(\frac{1}{2}, \frac{2}{3}, \frac{5b+7}{7b+10}\right), \\ & \left(\frac{1}{2}, \frac{2}{3}, \frac{7b+10}{9b+13}\right), \left(\frac{1}{2}, \frac{3b+4}{5b+7}, \frac{3}{4}\right), \left(\frac{1}{2}, \frac{3b+4}{5b+7}, \frac{4}{5}\right), \\ & \left(\frac{1}{2}, \frac{2}{3}, \frac{(2b+5)c+4b+8}{(3b+8)c+6b+13}\right), \left(\frac{1}{2}, \frac{2}{3}, \frac{(3b+8)c+6b+13}{(4b+11)c+8b+18}\right), \end{aligned}$$

$$\left(\frac{1}{2}, \frac{2b+3}{3b+5}, \frac{2d+3}{3d+5}\right), \left(\frac{1}{2}, \frac{3}{5}, \frac{3d+5}{4d+7}\right), \left(\frac{1}{2}, \frac{3}{5}, \frac{4d+7}{5d+9}\right).$$

Then $D \geq 2P_0 - \frac{1}{2}P_1 - \frac{2}{3}P_2 - \frac{4}{5}P_3$. Therefore $R(\mathbb{P}_k^1, D)$ is F -rational by Theorem 3.1 and Lemma 6.1.

Case 5. We assume that (a_1, a_2, a_3) is one of the followings:

$$\begin{aligned} &\left(\frac{1}{2}, \frac{b+1}{3b+4}, \frac{n+1}{n+2}\right), \left(\frac{1}{2}, \frac{1}{2}, \frac{(2a+3)b+3a+4}{(2a+5)b+3a+7}\right), \left(\frac{1}{2}, \frac{(b+2)c+2b+3}{(2b+5)c+4b+8}, \frac{n+1}{n+2}\right), \\ &\left(\frac{1}{2}, \frac{1}{2}, \frac{((a+2)b+3a+5)c+(2a+4)b+5a+8}{((a+3)b+3a+8)c+(2a+6)b+5a+13}\right), \\ &\left(\frac{b+1}{2b+3}, \frac{d+1}{2d+3}, \frac{m}{m+1}\right), \left(\frac{1}{2}, \frac{b+1}{2b+3}, \frac{(c+2)d+2c+3}{(c+3)d+2c+5}\right). \end{aligned}$$

Then $D \geq 2P_0 - \frac{1}{2}P_1 - \frac{1}{2}P_2 - \frac{l}{l+1}P_3$ for sufficiently large number l . Note that if $(a_1, a_2, a_3) = \left(\frac{b+1}{2b+3}, \frac{d+1}{2d+3}, \frac{m}{m+1}\right)$, then we have $\deg[-lD] \leq -3$ for $l \in 2\mathbb{N}$. Therefore $R(\mathbb{P}_k^1, D)$ is F -rational by Theorem 3.1 and Lemma 6.1.

Case 6. We assume that (a_1, a_2, a_3) is one of the followings:

$$\left(\frac{b+1}{3b+4}, \frac{2}{3}, \frac{n+2}{n+3}\right), \left(\frac{1}{3}, \frac{2}{3}, \frac{(c+2)d+2c+3}{(c+3)d+2c+5}\right), \left(\frac{1}{3}, \frac{2d+3}{3d+5}, \frac{m+1}{m+2}\right).$$

Then $D \geq 2P_0 - \frac{1}{3}P_1 - \frac{2}{3}P_2 - \frac{l}{l+1}P_3$ for sufficiently large number l . Therefore $R(\mathbb{P}_k^1, D)$ is F -rational by Theorem 3.1 and Lemma 6.1.

Case 7. We assume that $(a_1, a_2, a_3) = \left(\frac{3}{4}, \frac{n+3}{n+4}, \frac{1}{4}\right)$. Then $R(\mathbb{P}_k^1, D)$ is F -rational by Theorem 3.1 and Lemma 6.1.

By the above discussion, if $p \geq 11$, then R is F -rational. \square

REFERENCES

- [1] M. Demazure, Anneaux gradués normaux, Introduction a la théorie des singularités II; Travaux En Cours vol.37, Hermann, Paris (1988), 35-68
- [2] F. Enescu and M. Hochster. The Frobenius structure of local cohomology. Algebra Number Theory 2.7 (2008), 721-754.
- [3] R. Fedder, F-purity and rational singularity, Trans. Amer. Math. Soc. 278, No. 2. (1983), 461-480.
- [4] R. Fedder and K.-i. Watanabe, A characterization of F -regularity in terms of F -purity, Commutative algebra (Berkeley, CA, 1987), Math. Sci. Res. Inst. Publ., 15, Springer, New York, (1989), 227-245
- [5] H. Flenner, Quasihomogene Rationale Singularitäten, Arch. Math. 36 (1981), 35-44.
- [6] N. Hara, Classification of two-dimensional F -regular and F -pure singularities. Adv. Math. 133 (1998), no. 1, 33-53
- [7] N. Hara and K.-i. Watanabe, The injectivity of Frobenius acting on cohomology and local cohomology modules, Manuscripta, Math. 90 (1996), 301-315.
- [8] N. Hara and K.-i. Watanabe, F -regular and F -pure rings vs. log terminal and log canonical singularities, J. Algebraic Geom. 11:2 (2002), 363-392.
- [9] R. Hartshorne, Algebraic geometry, Springer-Verlag, New York-Heidelberg, 1977. Graduate Texts in Mathematics, No. 52.

- [10] M. Hochster and C. Huneke, Tight closure of parameter ideals and splitting in module-finite extensions, *J. Alg. Geom.* 3 (1994), 599-670.
- [11] S. Ishii, Introduction to singularities. Springer, 2018.
- [12] K. Konno and D. Nagashima, Maximal ideal cycle over normal surface singularities of Brieskorn type, *Osaka J. Math.*, 49, (2012), 225-245.
- [13] J. Lipman, Rational singularities with applications to algebraic surfaces and unique factorization, *Inst. Hautes Études Sci . Publ. Math.* 36. (1969), 195-279.
- [14] H. Pinkham, Normal surface singularities with \mathbb{C}^* -action, *Math. Ann.*, 227 (1977), 183-193
- [15] K. E. Smith, F -rational rings have rational singularities, *Amer. J. Math.* 119 (1997), 159-180
- [16] K.-i. Watanabe, Rational singularities with k^* -action, in: *Commutative Algebra (Trento,1981)*, Lecture Notes in Pure and Appl. Math. 84, Marcel Dekker, New York, (1983), 339-351.

DEPARTMENT OF MATHEMATICS, COLLEGE OF HUMANITIES AND SCIENCES, NIHON UNIVERSITY, 3-25-40 SAKURAJOSUI SETAGAYA-KU, TOKYO 156-8550, JAPAN

Email address: shibata.kohsuke@gmail.com