

DIAMETER, WIDTH AND THICKNESS IN THE HYPERBOLIC PLANE

ÁKOS G.HORVÁTH

ABSTRACT. This paper contains a new concept to measure the width and thickness of a convex body in the hyperbolic plane. We compare the known concepts with the new one and prove some results on bodies of constant width, constant diameter and given thickness.

1. INTRODUCTION

In hyperbolic geometry there are several concepts to measure the breadth of a convex set. In the first section of this paper we introduce a new idea and compare it with four known ones. Correspondingly, we define three classes of bodies, bodies of constant width, bodies of constant diameter and bodies having the constant shadow property, respectively. In Euclidean space more or less these classes agree but in the hyperbolic plane we need to differentiate them. Among others we find convex compact bodies of constant width which size essential in the fulfilment of this property (see Statement 7) and others where the size dependence is non-essential (see Statementst:circle). We prove that the property of constant diameter follows to the fulfilment of constant shadow property (see Theorem 2), and both of them are stronger as the property of constant width (see Theorem 1). In the last part of this paper, we introduce the thickness of a constant body and prove a variant of Blaschke's theorem on the larger circle inscribed to a plane-convex body of given thickness.

1.1. The hyperbolic concepts of width (breadth) introduced earlier.

1.1.1. $\text{width}_1(\cdot)$: Santaló in his paper [14] developed the following approach. For a convex set K , let z be a point in the boundary of K . Let L_z be the supporting line of K passing through z and let L_z^\perp be the orthogonal line to L_z at the point z . Choose another supporting line L_v of K that is orthogonal to L_z^\perp , then the *breadth of K corresponding to z* is the hyperbolic distance between L_v and L_z , i.e., the length of the segment L_z^\perp joining the lines L_v and L_z . Under this approach, the set K is said to have constant width λ if the breadth of K with respect to every point in its boundary is λ . The problem with this approach that there is no chance to define "opposite points" on the boundary of K , and the Euclidean concept of affine diameter cannot be interpretable.

1.1.2. $\text{width}_2(\cdot)$: Historically the next development is due to J. Filmore in [7] who introduced the following notion. If a set of the hyperbolic plane holds the property that with every pair x, y of its points it contains the intersection of all paracyclic (horocyclic) domains which contain x and y , then we say that the set is a h-convex set of the plane. Of course every h-convex set is also convex in the standard hyperbolic meaning but for example a convex polygon is not h-convex. Let K be an h-convex set with smooth boundary and fix a point O in the plane. Consider a half-line through the point O and consider that pair of paracycles which tangents to K and go through on the ideal point of the given half-line. The width in the direction of this half-line is the length of the segment which endpoints are the intersection points of the above paracycles with the line containing the given half-line. The width in this approach depends on the point O and cannot measure the sets which convex but not h-convex one.

1.1.3. $\text{width}_3(\cdot)$: K. Leichtweiss introduced a concept in [12] which don't use touching lines or paracycles to measure the width of a h-convex set. His idea is to start with strip regions which are homogeneous in the sense that they admit one-parameter subgroups of motions, which in the hyperbolic case is the group of translations correspondingly to a given line. (More precisely, regard those translations which are the product of two reflections in lines which are orthogonal to the given line. These translations form a subgroup of motions of the hyperbolic plane. The strips which invariant against the elements of

2010 *Mathematics Subject Classification.* 51M09,51M10.

Key words and phrases. constant width property, diameter of a convex set, hyperbolic plane, thickness of a convex set, width function.

this subgroup must be bounded by geodesic parallel curves of constant curvature, which are the so-called hypercycles (distance curves) of the given line.) Thus it is quite natural to define the width a horocyclic convex curve C in a certain direction by means of the width of the supporting strip region of this direction. In this approach the condition of h-convexity also needs because the curvature of the boundary points of the strip region is less than the curvature of paracycles but again it is non-zero. Consequently, this method cannot be applied for polygons, too. On the other hand it is a strong connection with the notions of spherical geometry and we can define appropriate signed support function $h(\theta)$ for a h-convex set like in the classical convex geometry. The width $w(\theta)$ in a direction holds the equality $w(\theta) = h(\theta) + h(\theta + \pi)$. Observe that these functions depends on the origin and so the "width of the h-convex set in a direction" doesn't an inner property of the set, like the earlier concept of Filmore. Advantage of this building up that in the case of h-convex sets we can say about "opposite points" and "affine diameters" as in the Euclidean situation.

1.1.4. $\text{width}_4(\cdot)$: Recent approach in the literature is in the paper of J. Jeronimo-Castro and F. G. Jimenez-Lopez [6]. The authors first introduce the notion of opposite points for an arbitrary compact convex body K of the hyperbolic plane. We translate the definition to the model-free language of the hyperbolic plane. Transform with an isometry the point z of the boundary of K to a given (and fixed) point O of the plane such a way that a given (and fixed) line l of the plane through O will be a supporting (tangent) line L_z of the image. In the second step search a point w on the boundary of K for which a support line L_w at w has equal alternate angle with the segment $[z, w]$ as the angle between $[z, w]$ and L_z . By definition such a pair z and w of points are *opposite points* with respect to K and the segment $[z, w]$ is an *isometric diameter*. The existence at least one opposite pair to a given z can be seen immediately from the Poincare's disk model. Similarly, it can be seen easily that if K smooth and h-convex z uniquely determines its opposite pair w . Let denote by $L_{z,w}$ the line of the segment $[z, w]$. Since $L_{z,w}$ has equal alternate angles with L_z and L_w these latter are ultraparallel lines (non intersected and non-parallel) implying that, there is an unique distance of it. This distance is the width of the body corresponding to the isometric diameter $[z, w]$. Note that in this approach there is no such width function which for every direction uniquely determines a real number. It is possible, that for the same boundary point z we find two opposite points w' and w'' for which the corresponding width are distinct to each other. But immediately can be defined the notion of *curve of constant width* with the property that all widths let be the same value with respect to all pairs of opposite points.

Our method gives a synthesization of the above concepts preserving the important properties of those ones.

1.2. **Comparison of the known concepts of width.** First we observe that we can compare the Santalo's breadth $\text{width}_1(z)$ with $\text{width}_4(z)$ of Jeronimo-Castro and Jimenez-Lopez. Both of them corresponds the value of width to the points of the boundary of K . Concentrating to the method of [6], if the boundary of K smooth and horocyclic convex, a point on the boundary has an unique opposite pair and the width with respect to this point can be defined as the distance of the opposite (in this sence) tangent lines.

Statement 1. *Let K be a convex compact body of the plane with smooth and h-convex boundary. Then we have*

$$(1) \quad \text{width}_4(z) \geq \text{width}_1(z).$$

Equality holds at that point z where the normal is a double-normal.

Proof. The breadth of [14] can be seen as the distance of the tangent at the points z and v , while the width of [6] can be found as the distance of the lines L_z and L_w (see Fig. 1). From synthetic absolute geometry (see in [1]) we know that this latter quantity attend at the perpendicular to L_z from the midpoint M of the segment $[z, w]$.

In the figure it is the length of the segment $[T_z, T_w]$. Since the points w and z are in distinct half-planes of the line $T_z T_w$. the boundary of K intersects the segment $[T_z T_w]$ in two points, one of them (say N) is on the segment $[M, T_w]$. Note that the lines L_w and L_z^\perp either non-intersecting or intersect each other in a point L . In the second case, the quadrangle with vertices L, z, T_z and T_w is a Saccheri quadrangle implying that $T_w L z \angle$ is acute angle. From this follows that the touching point v – which needed to the determination of the Santalo's breadth – is on the arc $w N z$. This also true in the first case, hence L_v intersects the segment $[N, T_w]$ in a point T . This provides the following inequalities:

$$(2) \quad \text{width}_4(z) = |[T_z, T_w]| \geq |[T, T_z]| \geq |[K, z]| = \text{dist}(L_z, L_v) = \text{width}_1(z).$$

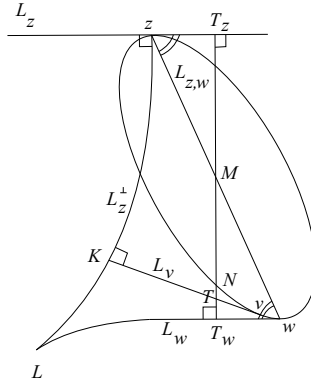

FIGURE 1. Comparison of Santaló width function to the width of Jerónimo-Castro and Jimenez-Lopez

(The second inequality follows from the fact that the distance of two lines is less or equal to the length of another transversalis of them.) Clearly in the case of equality we have $z = T_z$, $w = v = T_w$ and the isometric diameter $[z, w]$ is a double normal of the boundary of K . \square

Our second note that there is a simple comparison of width_2 and width_3 . As we can see on Fig. 2 these functions correspond to a direction of the plane defined by a half-line starting from a given point O of the plane. Here we assume that the origin O is in the interior of the body K . (We can consider that the origin is an arbitrary point of the plane, but more comfortable if the getting support functions have only positive values, respectively. In the case of Fillmore's paper this follows from the fact that the domain of the investigated paracycles contains K and Leichtweiss directly assumed that the origin is in the interior of K .)

Statement 2. *Let K be a horocycle-convex compact body of the plane with the origin in its interior. Then we have*

$$(3) \quad \text{width}_2(\theta) \geq \text{width}_3(\theta).$$

Moreover, equality holds if and only if the touching points z and v are the endpoints of a double-normal of the boundary of K .

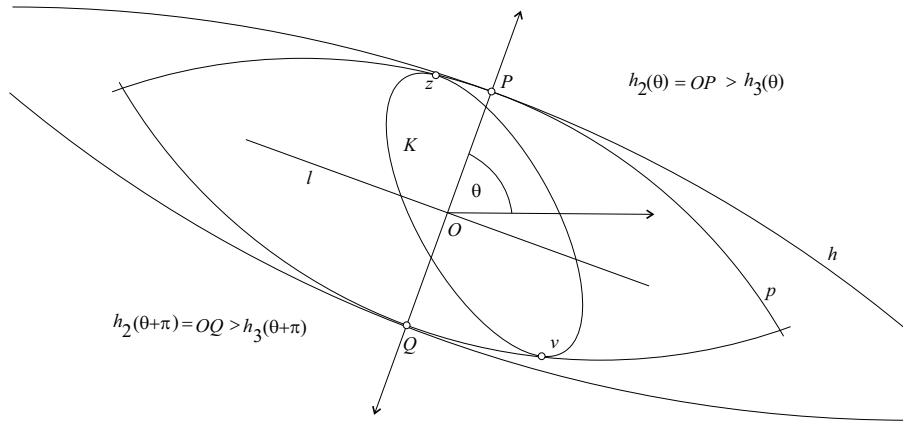

FIGURE 2. Connection between the width function of Fillmore and the width function of Leichtweiss

Proof. Let denote by $h_2(\cdot)$ and $h_3(\cdot)$ the corresponding support functions. If θ any parameter determining the direction of the half-line \overrightarrow{OP} then $\text{width}_2(\theta) = h_2(\theta) + h_2(\theta + \pi) = |OP| + |OQ|$. In Fig.2 p is that paracycle which touches K . One of its axis is \overrightarrow{OP} . The angle θ also corresponds to a value of the support function $h_3(\theta)$ of paper [12]. Since it should be the distance of a hypercycle of the leading line l , which is perpendicular to the direction \overrightarrow{OP} we have to consider the hypercycle h which goes through the point

P . However, h doesn't touch K , because its curvature is less than the curvature of the paracycle p . This means that $h_3(\theta) \leq h_2(\theta)$ consequently $\text{width}_3(\theta) \leq \text{width}_2(\theta)$ as we stated. Equality holds for a θ if and only if $P = z$ and $Q = v$ meaning that the normals at the touching points go through the origin O , respectively. Hence the segment $[z, v]$ is a double-normal of the boundary of K (and so it is also an isometric-diameter). \square

2. A NEW WIDTH FUNCTION OF THE HYPERBOLIC PLANE

In this section, we propose a new definition of the width function. We eliminate that dependence of the width function on the origin, which is present in the concept width_3 . Using again hypercycles we define such strips which leading-lines don't go through a fix origin. Denote by \mathcal{I} the set of ideal points. (To name "ideal point" in our terminology means a point on the boundary of a disk model. In a model-independent approach an ideal points is such a new object which corresponds to a congruence class of hyperbolic parallel half-lines.)

Definition 1. Let O be a point in the interior of the convex compact body K . Let \overrightarrow{OX} be a half-line with ideal point X and consider a line YX where $Y \in \mathcal{I}$, YX is parallel to \overrightarrow{OX} and intersects K . Then there are two hypercycles corresponding to the leading-line YX , which touch K and the strip between them contains K . The distance of these distance-curves are $d_K^+(YX)$ and $d_K^-(YX)$, respectively. Let denote by $d_K(YX) := d_K^+(YX) + d_K^-(YX)$. The width of K in the direction of X is

$$(4) \quad \text{width}_K(X) := \sup\{d_K(YX) : Y \in \mathcal{I}\}.$$

It follows by a standard compactness argument, that for an ideal point X there is at least one Y^* such that $\text{width}_K(X) = d_K(Y^*X)$. So the supremum in (4) is a maximum.

Remark 1. In Euclidean geometry the width in a direction means the needed size of a gate on which we can push across the body along the given direction (without any rotation). In hyperbolic geometry, we imagine this gate at an ideal point. We can push the body along several distinct half-lines corresponding to this point. The gate has to be enough big to that, the passage through the gate should be successful regardless of which route we used. This explains why we chose supremum instead of infimum in our definition.

Statement 3. For every ideal point X holds the inequality: $\text{width}_K(X) \geq \text{width}_3(X)$. Moreover, for every $X \in \mathcal{I}$ we can chose a point $z(X)$ on the boundary of K for which holds the inequality $\text{width}_K(X) \geq \text{width}_1(z(X))$. If K is strictly convex and smooth then there is a homeomorphism $\varphi : \mathcal{I} \rightarrow \text{bd}(K)$ $\varphi(X) = z(X)$ such that $\text{width}_K(X) \geq \text{width}_1(\varphi(X))$.

Proof. It is clear, that if O' any point of the interior of K then all half-line $\overrightarrow{O'X}$ is a subset of such a line YX which is parallel to \overrightarrow{OX} . Hence $\text{width}_K(X) \geq \text{width}_3(\overrightarrow{OX})$ holds with respect to any pair of O and \overrightarrow{OX} .

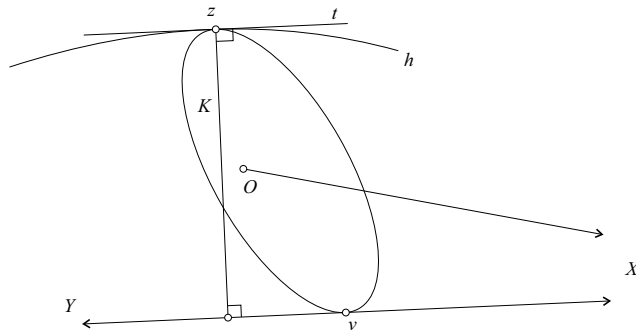

FIGURE 3. Comparison of the width function of Santaló with $\text{width}_K(\cdot)$

For a given direction \overrightarrow{OX} let Y such that YX touches K at the point v . One of the corresponding hypercycles is the line YX and the other touches the boundary of K at the point z . Now the distance of the point z to YX is $d_K(YX)$ which also represents $\text{width}_1(z)$ (see Fig.3). Hence if we correspond to the direction \overrightarrow{OX} the above point $z(X)$ on the boundary of K we get that $\text{width}_1(z(X)) \leq \text{width}_K(X)$.

To prove the last statement consider a Cayley-Klein model. In this model the smooth and strictly convex body has the same property. Obviously we can assume that K contains the origin O of the model. For a point X of the model circle we can associate two points, which are the tangent points of the tangent lines of K through X . We start from that point X_0 of the model circle for which $\overrightarrow{OX_0}$ is the positive half of the axis x of an Euclidean coordinate system. Let $\varphi(X_0)$ that tangent point for which the line $\varphi(X_0)X_0$ has positive directional tangent. Hence the triangle $O\varphi(X_0)X_0$ has positive (counterclockwise) direction and by definition we choose that tangent point as the $\varphi(X)$ image of X for which this property holds. Clearly our conditions on the boundary of K guarantees that φ is a homeomorphism. \square

We have also an immediate connection between $\text{width}_4(z)$ and our function $\text{width}_K(X)$.

Statement 4. *Let K be a h -convex compact body. For every point $X \in \mathcal{I}$ there is a point $Y \in \mathcal{I}$ such that the supporting strip of the leading line YX touches K in the endpoints z, w of an isometric diameter. Conversely, for every isometric diameter $[z, w]$ there is a line YX with $X, Y \in \mathcal{I}$ for which the respective touching points of the supporting strip of YX are z and w . Moreover for corresponding pairs $X, Y \in \mathcal{I}$ and $z, w \in \text{bd}(K)$ holds $\text{width}_K(X) \geq d_K(YX) \geq \text{width}_4(z) = \text{width}_4(w)$, with equality in the second inequality if and only if the isometric diameter $[z, w]$ is a double-normal.*

Proof. Let $Y \in \mathcal{I}$ such that holds the equality $d_K^+(YX) = d_K^-(YX)$. (The continuity property of the distance function implies the existence of such line YX .) Denote by z and w a pair of touching points lying in the distinct bounding hypercycles. Then z and w are opposite points in the sense of [6]. In fact, the triangles zT_zM_Δ and wT_wM_Δ in the left hand figure of Fig. 4 are congruent so the chord $[z, w]$ has equal alternate angle with the corresponding tangent lines t_z and t_w . Since these lines disjoint to this strip that their distance is greater than the width of it. Equality holds if and only if the isometric diameter $[z, w]$ is a double-normal of K .

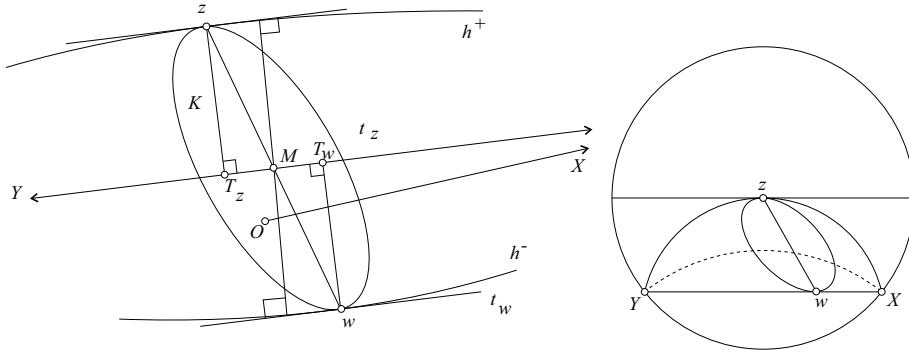

FIGURE 4. Illustration of the proof of Statement4

Conversely, we prove that every isometric diameter of a h -convex body can be get with the above method. Precisely, if $[z, w]$ is an isometric diameter there is a line YX for which $\text{dist}(z, XY) = \text{dist}(w, XY)$. See the picture on the right hand side of Fig. 4. This shows the isometric diameter $[z, w]$ in the Poincare's disk model. Let X and Y be the respective intersections of the Euclidean tangent line at the point w and the model circle. Then the Euclidean line XY represents an hypercycle of the hyperbolic plane corresponding to the leading hyperbolic line with ideal points X and Y . Using an inversion to the absolute (to the circle of ideal points) we get from this hypercycle its opposite pair which has the same distance from the hyperbolic line YX . Inversion sends the Euclidean line YX to a circle which goes through the origin, the intersections with the model circle are X and Y and tangents K at z . The only question is that this strip contains or not the body K . If K is a h -convex body then its curvature at the point z is greater than the curvature of the hypercycle YzX and the strip contains the body, as we stated. \square

Note that if K is a polygon the two endpoints of a double-normal typically cannot be considered to the touching pair of points of a strip which is bounded by hypercycles of the same leading line.

We call a strip *symmetric to its leading line* if the boundary hypercycles have the same distance from the leading line.

We have two symmetries in the calculation, the first one is with respect to the line of AB and the second one is with respect to the bisector of AB , meaning that we can assume that $\alpha \leq \alpha^*$. Denote by t the length of the segment AM and consider a perpendicular from M to AX . Its length is m . This segment divides the angle AMX_{\angle} into two parts; one of them say γ is the second acute angle of a right triangle, the other one is the parallel angle μ corresponding to the distance m . Hence we have

$$\cos \mu = \tanh m \quad \sin \mu = \frac{1}{\cosh m}.$$

From the right triangle AMT_{Δ} we get the equalities

$$\cos \gamma = \frac{\tanh m}{\tanh t} \quad \sin \gamma = \frac{\sqrt{\tanh^2 t - \tanh^2 m}}{\tanh t}.$$

By the further notation of the figure, we get

$$\sin \delta = \sin(\pi - \delta) = \frac{\tanh m}{\cosh m \tanh t} + \frac{\tanh m \sqrt{\tanh^2 t - \tanh^2 m}}{\tanh t}.$$

Finally, from the right triangle AMT_{Δ} we get

$$\sinh m = \sin \alpha \sinh t \quad \cosh m = \sqrt{1 + \sin^2 \alpha \sinh^2 t} \quad \tanh m = \frac{\sin \alpha \sinh t}{\sqrt{1 + \sin^2 \alpha \sinh^2 t}}.$$

Now we can deduce the following formula

$$\sin \delta = \frac{\sin \alpha (\cosh t + \cos \alpha \sinh t)}{1 + \sin^2 \alpha \sinh^2 t} = \frac{\sin \alpha}{\cosh t - \cos \alpha \sinh t}.$$

Our function is

$$(6) \quad f(t) := d_A + d_B = \sinh^{-1}(\sin \delta \sinh t) + \sinh^{-1}(\sin \delta \sinh(d-t)) = \\ \sinh^{-1} \frac{\sin \alpha \sinh t}{\cosh t - \cos \alpha \sinh t} + \sinh^{-1} \frac{\sin \alpha \sinh(d-t)}{\cosh t - \cos \alpha \sinh t}.$$

The derivative of $f(t)$ is

$$f'(t) = \frac{\sin \alpha}{(\cosh t - \cos \alpha \sinh t) \sqrt{(\cosh t - \cos \alpha \sinh t)^2 + \sin^2 \alpha \sinh^2 t}} + \\ \frac{\sin \alpha (-\cosh d + \cos \alpha \sinh d)}{(\cosh t - \cos \alpha \sinh t) \sqrt{(\cosh t - \cos \alpha \sinh t)^2 + \sin^2 \alpha \sinh^2(d-t)}}.$$

Since $\cosh t - \cos \alpha \sinh t > 0$ holds for all positive t and also we assumed that $\sin \alpha > 0$, the condition $f'(t) = 0$ is equivalent to the following equality:

$$\cosh d - \cos \alpha \sinh d = \frac{\sqrt{(\cosh t - \cos \alpha \sinh t)^2 + \sin^2 \alpha \sinh^2(d-t)}}{\sqrt{(\cosh t - \cos \alpha \sinh t)^2 + \sin^2 \alpha \sinh^2 t}}.$$

Introducing the notation $x(t) := \cosh t - \cos \alpha \sinh t$ we can write

$$x^2(d) - 1 = \frac{\sin^2 \alpha (\sinh^2(d-t) - \sinh^2 t)}{x^2(t) + \sin^2 \alpha \sinh^2 t}.$$

This leads to

$$(\sinh^2 d (1 + \cos^2 \alpha) - \cos \alpha \sinh(2d)) (\cosh 2t - \cos \alpha \sinh 2t) = \\ \sin^2 \alpha (\sinh^2 d \cosh(2t) - \sinh(2t) \sinh d \cosh d),$$

from which straightforward calculation shows the following equivalent form:

$$0 = (\cosh d - \cos \alpha \sinh d) ((1 + \cos^2 \alpha) \sinh(2t) - 2 \cos \alpha \cosh(2t)).$$

Since the first term is always positive we get that the only zero is attend at

$$\tanh(2t) = \frac{2 \cos \alpha}{1 + \cos^2 \alpha}.$$

From this $\tanh t = \cos \alpha$, therefore the function $f(t)$ has one maximum at the point $t = \tanh^{-1}(\cos \alpha)$. It can be seen that at this value $\delta = \pi/2$, so the triangle AXM_{Δ} is a right one. Of course, the fix value d sometimes less than that t where the maximum is attend, in this case from that t 's which we allowed, $t = d$ produces the larger widthness. \square

3. BODIES OF CONSTANT WIDTH

One of the most interesting question with respect to the width function is the characterization problem of bodies of constant width. In this section we investigate this question. First we determine the with function of an important body, the with function of a symmetric bounded hypercycle domain.

Statement 6. *The width function of the symmetric hypercycle domain $ABCD$ is a combination of the width functions of the "diagonal chords" AC and BD . Using the notation of Fig.6 we have on the arc $X_0 \leq X \leq X'$ the following function*

(7)

$$\text{width}_K(X) = \max\{\text{width}_{AC}(X), \text{width}_{BD}(X)\} = \begin{cases} \sinh^{-1} \frac{\tanh h (\cosh a + \sinh a)}{\sqrt{\cosh^2 a \cosh^2 h - 1}} & \text{if } X_0 < X \leq X_1 \\ d & \text{if } X_1 < X \leq X_2 \\ \tanh^{-1} \cos(\gamma + \delta) & \text{if } X_2 < X < X' \end{cases} .$$

The complete function has rotational symmetry of order 4.

Proof. Let K be a convex, compact body and let X be a direction. Then we have

$$\text{width}_K(X) = \sup\{\text{width}_{AB}(X) : A, B \in K\}.$$

From this we can deduce the width function of a symmetric hypercycle domain D . Let its height $2h$ meaning that its leading line has distance h from the points of the hypercycle arcs, respectively (see the left picture in Fig.6). The chord FG on the leading line has length $2a$. Clearly AC and BD are

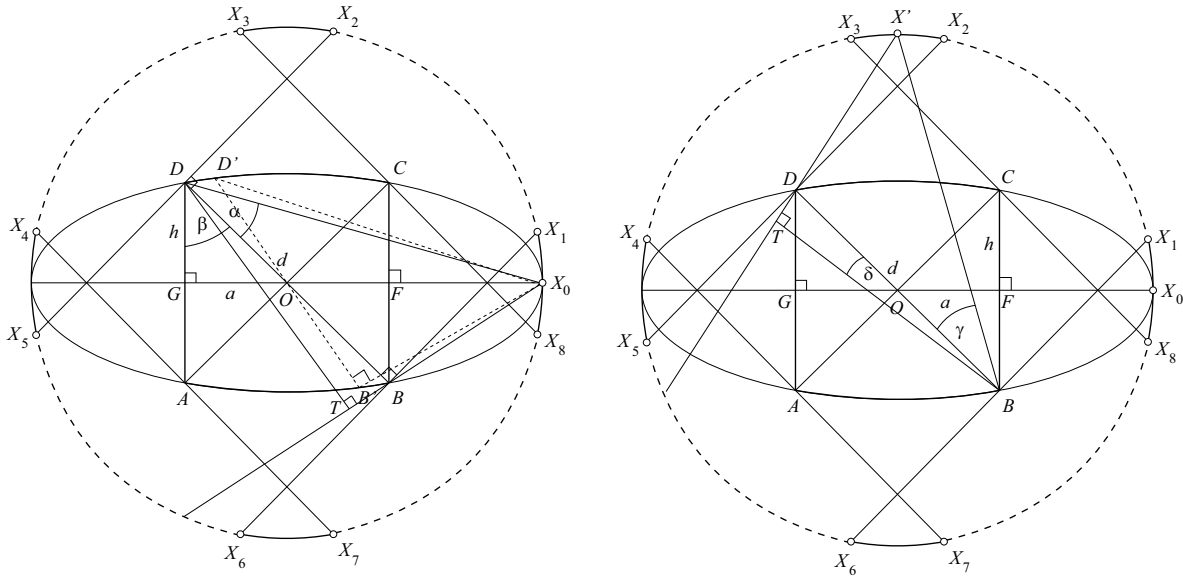

FIGURE 6

the longest chords in the domain, they common length is $d = 2 \cosh^{-1} (\cosh a \cosh h)$. Observe that any hypercycle domain which contains these two segments also contains those segments which one endpoint is AB and the other one is in CD . Hence we have to concentrate those segments which ends lying in the hypercycle arcs. From those ideal points which are on the dashed arcs on Fig.6 the value of the width is d by Lemma5. The question is the following: What can we say about the widthness from the points on the bold arcs of the model circle? Clearly, we have $\text{width}_D(X_0) \geq 2h$. On the other hand we can calculate the width of the segment BD from this direction, too. In fact, Lemma5 says, that

$$\text{width}_{BD}(X) = \sinh^{-1} \left(\frac{\sin \alpha \sinh d}{\cosh d - \cos \alpha \sinh d} \right),$$

where $\alpha + \beta$ is the parallel-angle of the distance h and $\sin \beta = \frac{\sinh a}{\sinh d/2}$. Since $\cos(\alpha + \beta) = \tanh h$ we get

$$\tanh h = \cos \alpha \cos \beta - \sin \alpha \sin \beta = \cos \alpha \sqrt{1 - \frac{\sinh^2 a}{\sinh^2 \frac{d}{2}}} - \sin \alpha \frac{\sinh a}{\sinh \frac{d}{2}}.$$

By the hyperbolic theorem of cosine $\cosh \frac{d}{2} = \cosh a \cosh h$ and we get that

$$\sin \alpha = \frac{\tanh h(\cosh a - \sinh a)}{\sinh \frac{d}{2}},$$

which gives that

$$\cos \alpha = \frac{\cosh a \sinh^2 h + \sinh a}{\cosh h \sinh \frac{d}{2}}.$$

We can use formula (5) to determine the width:

$$\text{width}_{BD}(X_0) = \sinh^{-1} \frac{\sin \alpha \sinh d}{\cosh d - \cos \alpha \sinh d}.$$

Long but straightforward calculation shows that

$$\text{width}_{BD}(X_0) = \sinh^{-1} \frac{\tanh h(\cosh a + \sinh a)}{\sinh \frac{d}{2}} = \sinh^{-1} \frac{\tanh h(\cosh a + \sinh a)}{\sqrt{\cosh^2 a \cosh^2 h - 1}}.$$

For fixed value h we can use the above formula to determine the width of the chord $B(t)D(t)$ as a function of $a(t)$. The least possible value of $a(t)$ attend at that a' when the corresponding $B'D'X_0$ is the parallel angle of the value d' . From this we get

$$\frac{\tanh h(\cosh a' - \sinh a')}{\sinh \frac{d'}{2}} = \sin \alpha' = \frac{1}{\cosh d'} = \frac{1}{\cosh^2 \frac{d'}{2} + \sinh^2 \frac{d'}{2}}.$$

If $a(t) \leq a'$ from (5) we get that

$$d(t) = \text{width}_{B(t)D(t)}(X_0) \leq \sinh^{-1} \frac{\tanh h(\cosh a' + \sinh a')}{\sinh \frac{d'}{2}} = \sinh^{-1} \left(\frac{1}{\cosh d'} + 2 \frac{\sinh a'}{\sinh \frac{d'}{2}} \right).$$

The width a chord from X_0 which connects two points of the opposite hypercycle is equal to the width from X_0 of such a chord which goes through O . So we get

$$\text{width}_K(X_0) = \text{width}_{BD}(X_0) = \sup \{ \text{width}_{B(t)D(t)}(X_0) : 0 \leq a(t) \leq a \}.$$

The same true for the other points of the arc X_0X_1 .

Assume that $X_2 < X < X_3$ holds for the point X (see the right picture in Fig. 6). We can observe that from these points the width of K is always equal to the width of one of the segments AC and BD . On the figure, we drew that situation when $\text{width}_{BD}(X) = BT$ implying the equality

$$\tanh(\text{width}_{BD}(X)) = \tanh BT = \cos(\gamma + \delta),$$

where we used the notation of the figure. This proves the statement. \square

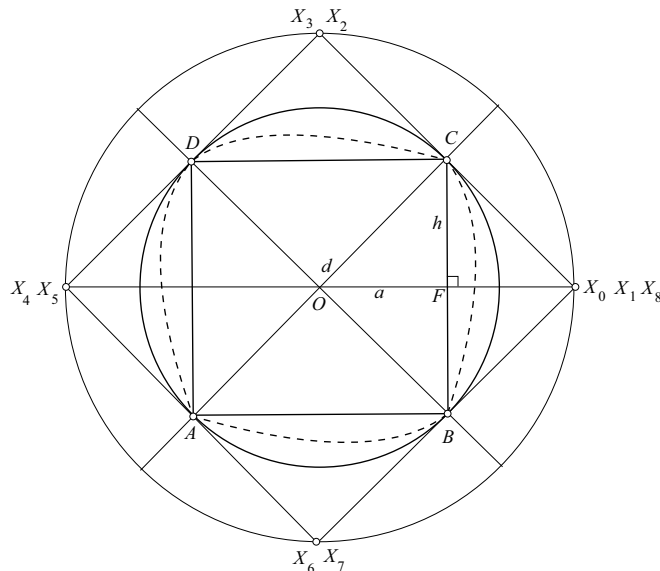

FIGURE 7. Bodies of constant width

Definition 2. We say that the compact convex body K has constant width if there is a $\lambda \in \mathbb{R}^+$ that for every ideal point X $\text{width}_K(X) = \lambda$ holds.

Remark 2. There is an interesting consequence of the Statement 6. When the arcs $\{X : X_8 \leq X \leq X_1\}$ and $\{X : X_2 \leq X \leq X_3\}$ degenerate to a point the width function of the hypercycle domain has constant value. In this case, $\tanh(d/2) = \cos \pi/4 = \sqrt{2}/2$, from which $\cosh^2 d/2 - 1 = \sinh^2 d/2 = (1/2) \cosh^2 d/2$ implying that $\cosh d/2 = \sqrt{2}$ and the unique value of the width function is $d = 2 \cosh^{-1}(\sqrt{2}) = 2 \ln(\sqrt{2} + 1)$. Since $\sqrt{2} = \cosh a \cosh h$ and also $\sinh h = \sqrt{2}/2 \sinh d/2 = \sqrt{2}/2$ we get that $a = \cosh^{-1} \sqrt{\frac{4}{3}}$ and $h = \cosh^{-1} \sqrt{\frac{3}{2}}$. This phenomenon exclude the characterization of bodies of constant width, because each convex body belonging to a circular disk of diameter $d = 2 \ln(\sqrt{2} + 1)$ and containing the endpoints of a pair of orthogonal diameters is a convex body of constant width. (E.g. see in Fig. 7 the circle, the quadrangle with equal angles and sides, and the body which bounded by the dotted curve, respectively.)

The following statement generalises this observation.

Statement 7. Let $k \geq 2$ an integer number. Assume that the radius r of the circumscribed circle of a regular n -polygon P holds

$$\tanh r \geq \tanh r_{\min} := \begin{cases} \frac{-1 + \sqrt{1 + 4 \sin \frac{\pi}{2k-1} \cot \frac{(k-1)\pi}{2k-1}}}{2 \cos \frac{(k-1)\pi}{2k-1}} & \text{if } n = 2k - 1, \\ \frac{1}{\sqrt{\cos^2 \frac{(k-1)\pi}{2k} + \tan^2 \frac{(k-1)\pi}{2k}}} & \text{if } n = 2k. \end{cases}$$

Then P is a body of constant width d , where

$$\sinh \frac{d}{2} = \begin{cases} \frac{\sinh r}{\sin \frac{(k-1)\pi}{2k-1}} & \text{if } n = 2k - 1, \\ \frac{\sinh r}{\sin \frac{(k-1)\pi}{2k}} & \text{if } n = 2k. \end{cases}$$

Proof. If $n = 2k$ is an even number then we can use the train of thought of Remark 2. Put the polygon

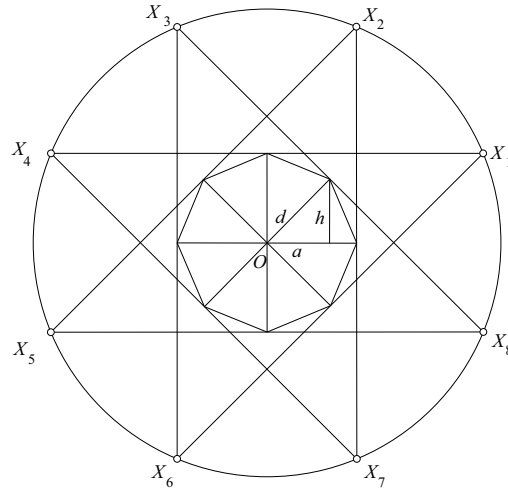

FIGURE 8. Regular $2k$ -polygon of constant width

into the center of a projective model with a large radius similarly as you can see on Fig. 8. Consider those pairs of support lines of P which go through the opposite vertices of a diameter. This $2k$ bands intersect the boundary of the model those ideal points from which at least one diameter has width d . We determine the radius of the model such a way that the getting arcs cover the circle but not overlap. The common points are X_i $i = 1, \dots, 2k$. The endpoints of one support line are $X_i X_{i+n-1}$ where we take the indices modulo $2k$. The central angle of such a line is $\frac{(k-1)\pi}{k}$ thus the parallel angle corresponds to $d/2$ is $\frac{(k-1)\pi}{2k}$. Hence

$$\tanh \frac{d}{2} = \cos \frac{(k-1)\pi}{2k}$$

from which we get that

$$\tanh d = \frac{2 \cos \frac{(k-1)\pi}{2k}}{1 + \cos^2 \frac{(k-1)\pi}{2k}}$$

The corresponding radius r of the circumscribed circle holds:

$$\sinh r = \frac{\sinh \frac{d}{2}}{\sin \frac{(k-1)\pi}{2k}} = \frac{\frac{\tanh \frac{d}{2}}{\sqrt{1 - \tanh^2 \frac{d}{2}}}}{\sin \frac{(k-1)\pi}{2k}} = \frac{\cos \frac{(k-1)\pi}{2k}}{\sin^2 \frac{(k-1)\pi}{2k}},$$

or

$$\tanh r = \frac{\cos \frac{(k-1)\pi}{2k}}{\sqrt{\sin^4 \frac{(k-1)\pi}{2k} + \cos^2 \frac{(k-1)\pi}{2k}}} = \frac{\cos \frac{(k-1)\pi}{2k}}{\sqrt{1 - \sin^2 \frac{(k-1)\pi}{2k} \cos^2 \frac{(k-1)\pi}{2k}}} = \frac{1}{\sqrt{\cos^2 \frac{(k-1)\pi}{2k} + \tan^2 \frac{(k-1)\pi}{2k}}}.$$

The odd case is more complicated. A diametral chord doesn't contain the origin. It determines a set of ideal points from which the widthness of the chord is d . In the model these sets are the union of two non-congruent arcs, the longest one is in that half-plane of the chord which contains the origin. We guarantee the constant widthness property if the rotated copies (n -times by the angle $2\pi/n$) of these sets cover the whole boundary of the model. If the vertices of the polygon are P_1, \dots, P_{2k-1} , then the diametral chords are the segments $P_i P_{i+k-1}$ respectively. The diametral chords are rotated copies of each other by the integer multipliers of the angle $2\pi/(2k-1)$ around the origin. (See Fig. 9.) Denote

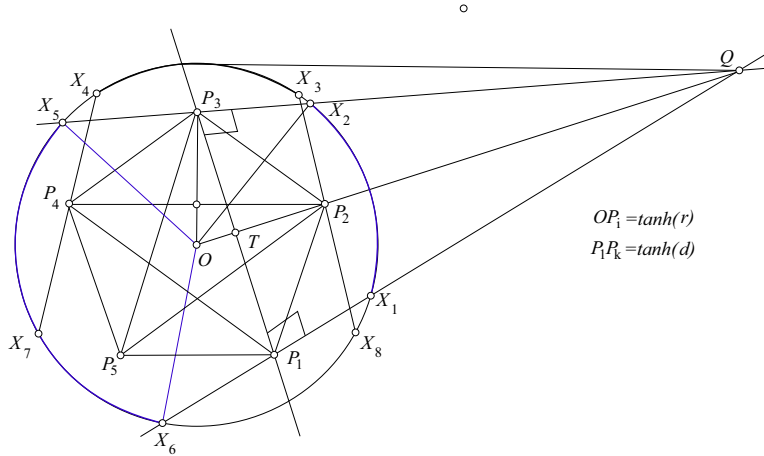

FIGURE 9. Regular $2k - 1$ -polygon of constant width

by $X_1 X_2 \cup X_{2k-1} X_{2k}$ and $X_3 X_4 \cup X_{2k+1} X_{2k+2}$ the sets of ideal points from which the diametral chords $P_1 P_k$ and $P_2 P_{k+1}$ can be seen in their common real length d . When $X_{2k-1} X_{2k}$ and $X_{2k+1} X_{2k+2}$ overlap the rotational symmetry guarantees that the polygon is a body of constant width d , since for every ideal points one of the diametral chord can be seen in its real length d . Thus we have to determine the central angle $X_{2k-1} O X_{2k}$. The minimal value of r occurs when $X_{2k-1} O X_{2k} = 2\pi/(2k-1)$.

Since $P_3 O Q \angle = \frac{(k-1)\pi}{2k-1}$ and the radius of the model is 1, the Euclidean distance of the diametral chords to the origin is $O T = \cos \frac{(k-1)\pi}{2k-1} \tanh r$. The pole of the chord containing the segment $P_1 P_k$ is Q so $O Q = (\cos \frac{(k-1)\pi}{2k-1} \tanh r)^{-1}$. Let denote by $\alpha = \frac{(k-1)\pi}{2k-1}$ and $\beta := O Q P_k \angle$, respectively. Since Q, X_2 and X_{2k-1} are collinear points we have $Q X_2 \cdot Q X_{2k-1} = O Q^2$ where $Q X_2$ and $Q X_{2k-1}$ are the roots of the polynomial equation of second order:

$$0 = x^2 - 2O Q \cdot x \cos \beta + O Q^2 - 1.$$

Hence the two roots are $x_{1,2} = O Q \cos \beta \pm \sqrt{1 - \sin^2 \beta O Q^2}$, so $Q X_{2k-1} = O Q \cos \beta + \sqrt{1 - \sin^2 \beta O Q^2}$. Now if the half of the central angle of the arc $X_{2k-1} X_{2k}$ is equal to the half of the central angle $P_1 O P_2 \angle = \frac{2\pi}{2k-1} = \frac{\alpha}{k-1}$, then we get the equality:

$$\sin \frac{\alpha}{k-1} = \sin\left(\pi - \frac{\alpha}{k-1}\right) = Q X_{2k-1} \sin \beta = \sin \beta \left(O Q \cos \beta + \sqrt{1 - \sin^2 \beta O Q^2} \right).$$

From this equality we can determine again OQ and get

$$0 = OQ^2 - 2 \sin \frac{\alpha}{k-1} \cot \beta OQ + \frac{\sin^2 \frac{\alpha}{k-1}}{\sin^2 \beta} - 1,$$

from which

$$OQ = \sin \frac{\alpha}{k-1} \cot \beta \pm \cos \frac{\alpha}{k-1}.$$

From the Euclidean right triangle $TQP_{k\Delta}$ we have that

$$\cot \beta = \frac{OQ - OT}{\sin \alpha \tanh r} = \frac{\frac{1}{\cos \alpha \tanh r} - \cos \alpha \tanh r}{\sin \alpha \tanh r} = \frac{1 - \cos^2 \alpha \tanh^2 r}{\cos \alpha \sin \alpha \tanh^2 r},$$

and get the equality

$$\frac{1}{\tanh r \cos \alpha} = \sin \frac{\alpha}{k-1} \frac{1 - \cos^2 \alpha \tanh^2 r}{\cos \alpha \sin \alpha \tanh^2 r} \pm \cos \frac{\alpha}{k-1}.$$

From this equation we get either the equality (\star):

$$(\star) \quad 0 = \tanh^2 r \sin \frac{(k-2)\alpha}{k-1} \cos \alpha - \tanh r \sin \alpha + \sin \frac{\alpha}{k-1}$$

or the equality ($\star\star$):

$$(\star\star) \quad 0 = \tanh^2 r \sin \frac{k\alpha}{k-1} \cos \alpha + \tanh r \sin \alpha + \sin \frac{\alpha}{k-1}.$$

The corresponding solutions are

$$(\star) \quad \tanh r = \frac{\sin \alpha \pm \sqrt{\sin^2 \alpha - 4 \sin \frac{(k-2)\alpha}{k-1} \sin \frac{\alpha}{k-1} \cos \alpha}}{2 \sin \frac{(k-2)\alpha}{k-1} \cos \alpha}$$

and

$$(\star\star) \quad \tanh r = \frac{-\sin \alpha \pm \sqrt{\sin^2 \alpha + 4 \sin \frac{k\alpha}{k-1} \sin \frac{\alpha}{k-1} \cos \alpha}}{2 \sin \frac{k\alpha}{k-1} \cos \alpha},$$

respectively. Substituting $\alpha = \frac{(k-1)\pi}{2k-1}$ we get

$$(\star) \quad \tanh r = \frac{\sin \frac{(k-1)\pi}{2k-1} \pm \sqrt{\sin^2 \frac{(k-1)\pi}{2k-1} - 4 \sin \frac{(k-2)\pi}{2k-1} \sin \frac{\pi}{2k-1} \cos \frac{(k-1)\pi}{2k-1}}}{2 \sin \frac{(k-2)\pi}{2k-1} \cos \frac{(k-1)\pi}{2k-1}}$$

and

$$(\star\star) \quad \tanh r = \frac{-\sin \frac{(k-1)\pi}{2k-1} \pm \sqrt{\sin^2 \frac{(k-1)\pi}{2k-1} + 4 \sin \frac{k\pi}{2k-1} \sin \frac{\pi}{2k-1} \cos \frac{(k-1)\pi}{2k-1}}}{2 \sin \frac{k\pi}{2k-1} \cos \frac{(k-1)\pi}{2k-1}}.$$

Among these solutions there is only one which have to take into consideration. In (\star) (by the inequality $\tanh r < 1$) we need that

$$\left(\sin \alpha - 2 \sin \frac{(k-2)\alpha}{k-1} \cos \alpha \right) < \mp \sqrt{\sin^2 \alpha - 4 \sin \frac{(k-2)\alpha}{k-1} \sin \frac{\alpha}{k-1} \cos \alpha},$$

from which the inequality:

$$-4 \sin \alpha \sin \frac{(k-2)\alpha}{k-1} \sin \frac{\alpha}{k-1} \cos \alpha + 4 \sin^2 \frac{(k-2)\alpha}{k-1} \cos^2 \alpha < -4 \sin \frac{(k-2)\alpha}{k-1} \sin \frac{\alpha}{k-1} \cos \alpha$$

holds. Simplifying it we get

$$\sin \frac{(k-2)\alpha}{k-1} \cos \alpha < \sin \alpha \sin \frac{\alpha}{k-1} - \sin \frac{\alpha}{k-1} = (\sin \alpha - 1) \sin \frac{\alpha}{k-1},$$

which gives a contradiction, because the right hand side is negative and the left hand side is positive. Similarly $\tanh r > 0$ implies that in ($\star\star$) we have to take into consideration only the sign plus. Hence we have that

$$\tanh r = \frac{-\sin \frac{(k-1)\pi}{2k-1} + \sqrt{\sin^2 \frac{(k-1)\pi}{2k-1} + 4 \sin \frac{k\pi}{2k-1} \sin \frac{\pi}{2k-1} \cos \frac{(k-1)\pi}{2k-1}}}{2 \sin \frac{k\pi}{2k-1} \cos \frac{(k-1)\pi}{2k-1}} = \frac{-1 + \sqrt{1 + 4 \sin \frac{\pi}{2k-1} \cot \frac{(k-1)\pi}{2k-1}}}{2 \cos \frac{(k-1)\pi}{2k-1}},$$

proving the last statement. \square

Remark 3. For $k = 2$ we have

$$\tanh r_{\min} := \begin{cases} \frac{-1 + \sqrt{1 + 4 \sin \frac{\pi}{3} \cot \frac{\pi}{3}}}{2 \cos \frac{\pi}{3}} = \sqrt{3} - 1 & \text{if } n = 3, \\ \frac{1}{\sqrt{\cos^2 \frac{\pi}{4} + \tan^2 \frac{\pi}{4}}} = \sqrt{\frac{2}{3}} & \text{if } n = 4, \end{cases}$$

and the corresponding values of d_{\min} are

$$\sinh d_{\min} = \begin{cases} \frac{2\sqrt{3}-2}{\sqrt{6\sqrt{3}-9}} = 1.2408 & \text{if } n = 3, \\ 2 & \text{if } n = 4. \end{cases}$$

Observe that the respective functions $\tanh r_{\min}(2k - 1)$ and $\tanh r_{\min}(2k)$ of k are strictly decreasing tends to zero in the variable k . The question is that there is or not a value of k when the difference of the two series change their sign or for every pairs of successive integers $2k - 1$ and $2k$ this difference is negative. This question can be answered by computer easily. The first six values of the two functions can be found in the table below showing that the merged series is monotone decreasing up to the index 9.

n	3	4	5	6	7	8	9	10	11	12
$\tanh r$	0.7321	0.8165	0.5309	0.5547	0.4080	0.4091	0.3286	0.3233	0.2739	0.2673

TABLE 1. The sequence of the radiuses.

An interesting phenomenon of constant width property that it depends also on the size of a body, not only on the combinatorial and symmetry properties of it. In spite of that there are bodies of constant width which size is non-essential in this point of view.

Statement 8. *The hyperbolic circle and the hyperbolic Reuleaux polygons are convex bodies of constant width independently on their sides.*

Proof. Consider the projective or Cayley-Klein disk model of the hyperbolic plane and consider a hyperbolic circle which center is the centre of the model disk. This is an Euclidean circle in the model. Every leading line YX is a chord of the model and the corresponding hypercycles are such half-ellipses which are tangent to the model circle at the points Y and X , respectively; and touching the given circle (see the left hand side of Fig. 10).

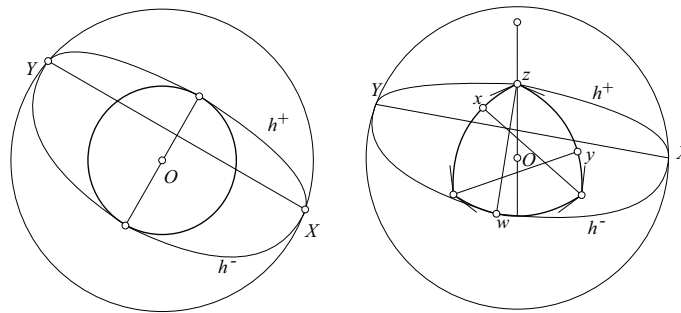

FIGURE 10. Hyperbolic circles and Reuleaux polygons are bodies of constant width

From the rotational symmetry of the figure we can see that for all line YX we get the same width $d_K(YX)$ which is equal to the hyperbolic diameter of the circle. From this the statement is obvious for the circle.

Consider the case of the Reuleaux polygons. From the definition (see e.g. [14] p.410) follows that the maximal distance d of its points reach at such a pair of points that one of them is a vertex of the polygon and the other lies on the opposite arc of the boundary. Let now YX a leading line and let be the corresponding hypercycles h^+ and h^- with the touching points z and w , respectively (see the right figure in Fig. 10). If z is a vertex and w lies on the opposite arc then there is a normal line at w which also perpendicular to YX and go through z . This means that $d_K(YX) = d$. On the other hand if x and y

are two smooth points of contact of a strip corresponding to a leading line ZW then the distinct normals at x and y are orthogonal to the line ZW . But in a Realeaux polygon every normal goes through the opposite vertex hence every two normals are intersect each other. This is a contradiction because there is no common perpendicular of intersecting lines. Hence $\text{width}_K(X) = d$ for all $X \in \mathcal{I}$ implying that Realeaux-polygons are bodies of constant width. \square

4. DIAMETRAL CHORDS AND THE BODIES OF CONSTANT DIAMETER.

On the usual way we define the *diameter* of a convex body K as the greater distance between its two points.

Statement 9. *The diameter of the compact, convex body K is*

$$\text{diam}(K) = \sup\{\text{width}_K(X) : X \in \mathcal{I}\}.$$

The supremum is a maximum, so there is at least one point $X^ \in \mathcal{I}$ such that $\text{diam}(K) = \text{width}_K(X^*)$.*

Proof. Let z, w be such points of the boundary of K for which $\text{diam}(K) = d(z, w)$. Clearly, those lines t^+ and t^- which are orthogonal to the chord $[z, w]$ at z and w are supporting lines of K . If YX^* a line which orthogonally intersects $[z, w]$ and h^+ and h^- are the distance curves corresponding to YX^* through z and w , respectively, then $d_K(YX^*) = d(z, w)$. Hence $\text{width}_K(X^*) \geq d_K(YX^*) = d(z, w) = \text{diam}(K)$. Assume now that $\text{width}_K(X^*) > \text{diam}(K)$. Then there is an $Y^* \in \mathcal{I}$ such that $\text{diam}(K) < d_K(Y^*X^*)$. Let $\{z^*, w^*\}$ be a touching pair of points in the intersection of the boundary of K and that strip which distance is $d_K(Y^*X^*)$. Obviously, $d(z^*, w^*) \geq d_K(Y^*X^*)$ yielding a contradiction. Hence in fact, $\text{diam}(K) = \sup\{\text{width}_K(X) : X \in \mathcal{I}\}$, as we stated. \square

The above proof shows that the endpoints of a diametral chord are such points of $\text{bd}K$ in which the normals are double-normals. This fact is trivial in all such spaces where orthogonality is defined by metric property. There are three papers of P.V.Araújo on *metric width* of the bodies of the hyperbolic plane (see [2],[3], [4]) in which the concept of curves of constant width was seriously investigated. The author said that a *plane-convex body is of constant width δ* if its diameter is equal to δ and each point of the boundary is an endpoint of such a chord which length is equal to δ . We call such a chord to *diametral chords* in this paper. In another terminology the *constant diameter* property was rather used. We use also this latter phrase. The most important properties of constant diameter property (was proved first by Araújo) we now collect in a statement:

Statement 10 ([2],[3]). *A body of constant diameter of the hyperbolic plane holds the properties:*

- *Every diametral chord is a double normal of the boundary of the body, cutting the boundary curve orthogonally at both ends (more precisely, the perpendicular line at each extremity of each diametral chord is a line of support of the body).*
- *Every chord of that is orthogonal to the boundary at one end is a diametral chord, and therefore it is a double normal.*
- *Any two distinct diametral chords must intersect each other.*

Araújo also introduced the concepts of *track function* and *intersection function*, respectively. He fixed a diametral chord and denoted by θ the oriented angle of another diametral chord with the fixed one (see the oriented angle CMB in Fig. 11).

When a point from the right end of the fixed chord goes along the boundary then the corresponding diametral chord change its position and angle, respectively. Using the notation of the figure we can see that the boundary curve can be determined by the distance of the point of intersection M to the right end C (which is the value $x(\theta)$ of the track function) and the distance MB which is the value of the intersection function $f(\theta)$. It was proven in [4] that the original chord AC can be chosen such a way that the following properties hold:

- Both the track function and the intersection function are continuous on each interval $(0; \pi)$ and $(\pi; 2\pi)$ and for $\theta \in (0, \pi)$ hold that $x(\theta + \pi) = x(\theta)$, $0 \leq f(\theta) \leq d$ and $f(\theta) + f(\theta + \pi) = d$.
- The diametral chord AC can be chosen in such away that the continuity property of these functions extended to the interval $(0, 2\pi)$ giving that they are can be extended periodically such that the above properties remain valid on \mathbb{R} .

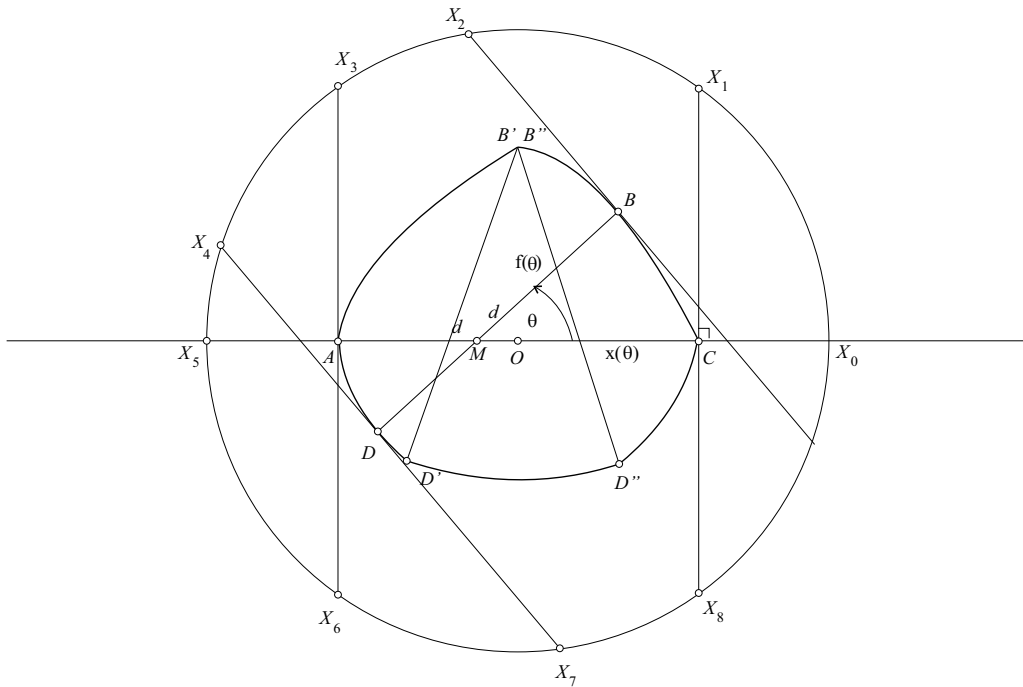

FIGURE 11. The properties of bodies with constant diameter

- For C^3 boundary between the track and intersection function there is the connection $f'(\theta) = -x'(\theta) \cos \theta$ implying that the intersection function determines the track function up to the choice of a constant.

There is a nice recent result of M. Lassak in [11] which connects the spherical concepts of constant width and constant diameter. He proved that a convex body on the two-dimensional sphere of diameter δ is less than $\pi/2$ is of constant diameter δ if and only if it is of constant width δ . As we saw in Remark 2 this is not true in the hyperbolic plane, the quadrangle of this remark is a body of constant width but it has only two diametral chords AC and BD , respectively. We now prove the reversal of this statement.

Theorem 1. *If the body K is a convex body of constant diameter d then it is a body of constant width d .*

Proof. Since the diameter is the maximum value of the width function of K we have to prove that there is no such direction from which the width of K is less than the diameter d . Let AC be a diametral chord with endpoints A, C and length d . Let YX be any line which intersects AC orthogonally. Since AC is a double normal $d \geq \text{width}_K(X) \geq \text{width}_{AC}(X) = d$. Let $\mathcal{X}(AC)$ be the set of ideal points from which the width of AC is equal to d . We should prove that $\cup\{\mathcal{X}(AC) : AC \text{ is a diametral chord}\} = \mathcal{I}$. Observe that the tangent lines at the smooth points of the boundary continuously change their position such that the function $\theta(s)$ parameterized by the arc-lengths is strictly increasing and at a corner points each support line determines a diametral chord which is orthogonal to it and one end is the given corner point. From this latter follows that for each θ there is a unique support line of the body such that the intersection points of the support line with a great circle containing the body produce a continuous bijection between them. This means that the union of the ideal points of the support lines already cover the whole \mathcal{X} implying that it is even more true for $\cup\{\mathcal{I}(AC) : AC \text{ is a diametral chord}\}$. \square

We saw that without further condition a body of constant width is not a body of constant diameter. To give a positive result in this a direction we introduce a new concept.

Definition 3. *We say that a convex, compact body has the constant shadow property if there is a positive number d such that $d_K(YX) = d$ for all line YX which intersects the body K .*

Of course a body which has the constant shadow property with the number d then it is a body of constant width with the same d . A circle is a body with this property, hence this class is not empty. We prove the following:

Theorem 2. *The convex, compact body K of the hyperbolic plane has the constant shadow property with the number d then it is a body of constant diameter d .*

Proof. We prove that a body of constant shadow property is a body of constant diameter. Let $d = d_K(YX)$, where $YX \cap K \neq \emptyset$. Then the diameter of K is less or equal to d . Really, if $\text{diam}K = d^* > d$ then there is a chord PQ for which $|PQ| = d^*$. Let YX is a line which orthogonally intersects the segment PQ . Obviously $d_K(YX) \geq d^* > d$ which is a contradiction.

Consider a point P on the boundary of K . Let t be the supporting line of K at P ; PQ be a chord of K which orthogonal to t and YX be an intersecting line of K perpendicular to PQ . Since $d_K(YX) = d$ we have two possibilities. If PQ is a double-normal (at Q it is orthogonal to a supporting line of K through Q) then its length is d and it is a chord from P with length d . If PQ isn't a double normal $d = d_K(YX) < |PQ^*|$, where Q^* is a common point of the another branch of the hypercycle domain of minimal width containing K with fundamental line YX . This is impossible because PQ^* is longest chord as the diameters of K . \square

Corollary 2. For a convex compact body of the plane equivalent the following two properties

- It has the constant shadow property with number d .
- All diameter of K is a double-normal of K in the general meaning. (We extend the concept of normal to a non-smooth point of the boundary such that it is a line which goes through the point and orthogonal to a supporting line of K at this point.)

Theorem 2 and the above equivalence implies the following theorem:

Theorem 3. *If K is a plane convex compact body of constant shadow property then every normal of K is a double-normal.*

Since by Theorem 3 in [6] the property that every normal of K is a double-normal is equivalent to the property that K is a body of constant width with respect to the function $\text{widht}_4(\cdot)$, we can deduce that the property of constant shadow knows this property of constant width of Jeronimo-Castro paper.

Further analogises of this theorem well-known in Euclidean geometry (see [15] and the references therein). in the hyperbolic plane this statement has been proved for the function $\text{widht}_3(\cdot)$ in [12] (Theorem 3.7), and without proof was used for $\text{widht}_1(\cdot)$ in [14] (Section 7).

5. THE THICKNESS (OR WIDTH) OF A HYPERBOLIC DOMAIN

Usual the width of a convex body K is the minimal width of it with respect to the directions of the plane. In the hyperbolic plane this property can be understood in two ways:

- In the first possibility we collect the possible values of the width function and from these values we create a common one for example taking their infimum (this leads to the usual definition of width of K ;
- in the second possibility we consider the intersecting lines to an independent "directions" (see the concept of constant shadow property), and from these values create the infimum.

These two methods lead to the same result, if in the first one we change the concept of width with respect to a direction to something-like thickness of the body changing the supremum to infimum in this definition.

Definition 4. *Let the thickness of the body K in the direction X is*

$$\text{thi}_K(X) := \inf\{d_K(YX) : YX \cap K \neq \emptyset\}$$

and let the thickness of K ($\text{thi}(K)$) be the infimum of the values $\text{thi}_K(X)$ take into consideration all direction $X \in \mathcal{I}$.

By compactness argument we can see easily that there is at least one $X^* \in \mathcal{I}$, such that $\text{thi}_K(X^*) = \text{thi}(K)$.

Note that the concept of the thickness for a convex hyperbolic body differs from the concept of the usual width. The quadrangle $ABCD$ in Fig. 7 is a body of constant width with $d = 2 \ln(\sqrt{2} + 1)$ but its thickness is less or equal to $2h = 2 \ln\left(\sqrt{\frac{3}{2}} + \sqrt{\frac{1}{2}}\right) < d$ (see Remark 2). Unfortunately, it is also possible that a chord which represents the thickness of the body isn't a double normal. Consider Fig. 12., where we can see a plane-convex body which is the union of two regular triangles (forming a quadrangle with equal sides), two quoters of circle and two quoters of an ellipse. We denoted by dotted lines the bounding hypercycles of the hypercycle domain. It can be seen easily that the thickness of this body is represented by a strip containing the points u, z , and v, w , respectively.

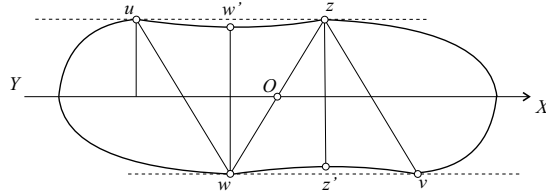

FIGURE 12. A chord which represents the smaller strip distance isn't a double-normal.

Now the respective chords joining the corresponding touching points are $[u, v]$, $[u, w]$, $[z, v]$ and $[z, w]$ but non of them could be double-normal. On the other hand if the ellipse and the hypercycle at w have a common tangent then the chords $[w, w']$ and $[z, z']$ are double-normals, respectively. This shows that there are chords which are double-normals and also are isometric diameters (their endpoints are opposite points in the meaning of [6]) but their lengths smaller than the thickness of K . This phenomenon is differ from the standard idea of the geometry of a convex body. From Statement 4 we can see that the reason is the definition of convexity and for h-convex bodies this phenomenon isn't perceptible. An interesting question that a shorter isometric diameter of a h-convex body is or isn't a double normal, and what is the connection with the thickness of the body. Presently we don't know the answer.

To verify that the definition was chosen appropriately we prove a version of Blaschke's theorem in the hyperbolic plane. This theorem says that every convex compact body in the Euclidean plane of thickness 1 contains a circle of radius $1/3$ (see example 17 in [5] or p.287 in [13]). For h-convex bodies we can prove an analogous of this result only . Since in hyperbolic plane there is no similarity, our result depends not only the thickness but also the diameter of the body.

Theorem 4. *Let K be a h-convex body of the hyperbolic plane with diameter d and thickness t . Then it contains a circle of radius r for which*

$$(8) \quad \tanh r = \frac{\sinh t \cosh t}{3 \cosh^2 d + \sinh^2 t}.$$

We note that if we use a first order approximation of the hyperbolic functions this formula leads to the Euclidean one, namely we get $r = t/3$.

Proof. Consider a boundary point P of K and a point $Q \in K$. The half-line \overrightarrow{PQ} intersects the boundary of K at the point Q^* . Let K_P be the set containing those points Q of K for which $\tanh |PQ| \leq (1 - \frac{1}{3 \cosh^2 d}) \tanh |PQ^*|$. We prove that K_P is a convex set. Observe that a shrinking map which any point X of the plane sends to that point X' of the half-line PX for which $\tanh |PX'| = \lambda \tanh |PX|$ ($0 < \lambda \leq 1$) is a collinearity which maps to a line to another line. In fact, if the line l given for which the point P doesn't belong to l , then we can consider that point T of it for which PT is perpendicular to l . Let another point of the line X , and consider the triangles PTX_Δ and $PT'X'_\Delta$, respectively. Let denote the angle TPX_Δ by α . Then $\cos \alpha = \tanh PT / \tanh PX$ since the first triangle is a right one. But $\tanh PT / \tanh PX = \tanh PT' / \tanh PX'$ so the second triangle is a right triangle. Hence the points X' are on the line through the point T' and orthogonal to the line PT . Hence this mapping takes a convex set into a convex set. Consider three points A, B, C on the boundary of K and the sets K_A, K_B and K_C , respectively. We prove that $K_A \cap K_B \cap K_C$ is non-empty. Consider the median point M of the triangle ABC_Δ . (If M_A, M_B and M_C are the middle point of the sides BC, AC and AB , respectively, then (by Menelaos theorem) the medians MM_A, MM_B and MM_C intersect each other in a point M .) Since the median point M holds the equality

$$\frac{\sinh AM}{\sinh MM_A} = 2 \cosh \frac{a}{2} = \frac{\cosh BM + \cosh CM}{\cosh MM_A}$$

(see Theorem 4.3 in [8], or Theorem 1.2 in [9] and the manuscript [10] containing the proofs of these statements), we get

$$\frac{\tanh AM}{\tanh MM_A} = \frac{\sinh AM \cosh MM_A}{\sinh MM_A \cosh AM} = \frac{\cosh BM + \cosh CM}{\cosh AM}$$

On the other hand we have that

$$\frac{\tanh AM}{\tanh AM_A} = \frac{\tanh AM + \tanh^2 AM \tanh MM_A}{\tanh AM + \tanh MM_A} = \frac{\frac{\tanh AM}{\tanh MM_A} + \tanh^2 AM}{\frac{\tanh AM}{\tanh MM_A} + 1} = 1 - \frac{1 - \tanh^2 AM}{\frac{\tanh AM}{\tanh MM_A} + 1} =$$

REFERENCES

- [1] Bolyai, J.: *Appendix, Scientiam Spatii, Absolute veram exhibens; A veritate aut falsitate axiomatis XI Euclidei (A priori haud unquam decideanda) independentem; Adjecta ad casum Falsitatis quadratura circuli geometrica.* (written in Latin, in Hungarian and in English) Polygon, Szeged, 2002.
- [2] Araújo, P.V.: Barbier's theorem for the sphere and the hyperbolic plane, *L'Enseignement Mathématique*, **42** (1996), 295–309.
- [3] Araújo, P.V.: Minimum area of a set of constant width in the hyperbolic plane, *Geometriae Dedicata*, **64** (1997), 41–53.
- [4] Araújo, P.V.: Representation of curves of constant width in the hyperbolic plane *Portugaliae Mathematica*, **55/3** (1998) 354–372.
- [5] Jaglom, I. M., Boltyansky, V. G.: *Convex figures* (written in Russian), Biblioteka Matematicheskogo kruzhka, vyp. 4, Gosudarstvennoye Izdatel'stvo Tekhniko-Teoreticheskoy Literatury, Moskva-Leningrad, 1951.
- [6] Jeronimo-Castro, J., Jimenez-Lopez, F. G.: A characterization of the hyperbolic disc among constant width bodies *Bull. Korean Math. Soc.* DOI: 10.4134/BKMS.b160709, **54/6** (2017), 2053–2063.
- [7] Fillmore, J.: Barbier's theorem in the Lobachevsky plane, *Proc. Amer. Math. Soc.* **24** (1970), 705–709.
- [8] G.Horváth, Á.: Hyperbolic plane geometry revisited. *Journal of Geometry* DOI: 10.1007/s00022-014-0252-0 (2014), **106/2** (2015), 341–362.
- [9] G.Horváth, Á.: On the hyperbolic triangle centers *Studies of the University of Zilina* **27/1** (2015) 11–34.
- [10] G.Horváth, Á., Addendum to the paper "Hyperbolic plane-geometry revisited". (2014) <http://www.math.bme.hu/~ghorvath/hyperbolicproofs.pdf>
- [11] Lassak, M.: When is a spherical body of constant diameter of constant width? *Aequationes Math.* **94** (2020), 393–400.
- [12] Leichtweiss, K.: Curves of Constant Width in the Non-Euclidean Geometry *Abh. Math. Sem. Univ. Hamburg* **75** (2005), 257–284.
- [13] Reiman, I.: *Geometry and related mathematical fields* (In Hungarian), Gondolat, Budapest, 1986.
- [14] Santaló, L. A.: Note on convex curves in the hyperbolic plane, *Bull. Amer. Math. Soc.* **51** (1945), 405–412.
- [15] Soltan, V.: Affine diameters of convex bodies—a survey *Expo. Math.* **23** (2005), 47–63.

Á. G.HORVÁTH, DEPARTMENT OF GEOMETRY, MATHEMATICAL INSTITUTE, BUDAPEST UNIVERSITY OF TECHNOLOGY AND ECONOMICS, H-1521 BUDAPEST, HUNGARY

Email address: ghorvath@math.bme.hu