

POLYNOMIAL INVARIANTS OF SINGULAR KNOTS AND LINKS

JOSE CENICEROS, INDU R. CHURCHILL, AND MOHAMED ELHAMDADI

ABSTRACT. We generalize the notion of the quandle polynomial to the case of singquandles. We show that the singquandle polynomial is an invariant of finite singquandles. We also construct a singular link invariant from the singquandle polynomial and show that this new singular link invariant generalizes the singquandle counting invariant. In particular, using the new polynomial invariant, we can distinguish singular links with the same singquandle counting invariant.

1. INTRODUCTION

Self-distributive algebraic structures $[(x * y) * z = (x * z) * (y * z)]$, in general, and quandles in particular are non-associative structures motivated by oriented Reidemeister moves in knot theory. Quandles were introduced independently in [12, 14] in the 1980s. In the past few decades, there have been many studies relating quandles to other areas of mathematics such as the study of the Yang-Baxter equation in [3, 5], quasigroups and Moufang loops in [7], ring theory in [8], representation theory in [9] and other areas. Recently, relations between these distributive structures and singular knot theory have been introduced with the purpose of constructing invariants of singular links in [1, 4, 6, 17]. A Jones-type invariant for singular links using a variation of the Hecke algebra was constructed and was shown to satisfy some skein relation in [13]. In 1993, connections between Jones type invariants in [11] and Vassiliev invariants of singular knots in [19] were established in [2].

In this article, we generalize the notion of the quandle polynomial to the case of singquandles. We also introduce the notion of the fundamental singquandle and use it to define a new polynomial invariant of oriented singular knots and links. Our invariant generalizes both the coloring invariant of singular links in [1, 6] and the polynomial invariant defined in [16]. We use the new polynomial invariant we construct to distinguish singular links with the same singquandle counting invariant and Jablan polynomial.

This article is organized as follows. In Section 2, we review the basics of quandles and give some examples. In Section 3, we recall the construction of the quandle polynomial in [10, 16]. In Section 4, we give a diagrammatic definition of singular knots and generalized Reidemeister moves leading to the definition of *oriented singquandles*. In Section 5, we define the fundamental singquandle of a singular link and we provide an example. In Section 6, we introduce a generalization of the quandle polynomial defined in [16] with the aim of defining a polynomial invariant of singular knots and links. In Section 7, we compute the invariant defined in Section 6 and use it to distinguish singular knots and links.

2020 *Mathematics Subject Classification*. Primary 57K12, 05C38; Secondary 05A15.

Key words and phrases. Quandle polynomial, Singular Knots and Links, Singquandle polynomial.

M.E. was partially supported by Simons Foundation collaboration grant 712462.

2. BASICS OF QUANDLES

In this section, we review the basics of quandles; more details on the topic can be found in [10, 12, 14].

Definition 2.1. A set $(X, *)$ is called a *quandle* if the following three identities are satisfied.

- (i) For all $x \in X$, $x * x = x$.
- (ii) For all $y, z \in X$, there is a unique $x \in X$ such that $x * y = z$.
- (iii) For all $x, y, z \in X$, we have $(x * y) * z = (x * z) * (y * z)$.

From Axiom (ii) of Definition 2.1, we can write the element x as $z\bar{*}y = x$. In other words, the equation $x * y = z$ is equivalent to $z\bar{*}y = x$. The axioms of a quandle correspond respectively to the three Reidemeister moves of types I, II and III (see [10] for example). In fact, one of the motivations of defining quandles came from knot diagrammatics.

A *quandle homomorphism* between two quandles $(X, *)$ and (Y, \triangleright) is a map $f : X \rightarrow Y$ such that $f(x * y) = f(x) \triangleright f(y)$, where $*$ and \triangleright denote respectively the quandle operations of X and Y . Furthermore if f is a bijection then it is called a *quandle isomorphism* between X and Y .

The following are some typical examples of quandles.

- Any non-empty set X with the operation $x * y = x$ for all $x, y \in X$ is a quandle called a *trivial quandle*.
- Any group $X = G$ with conjugation $x * y = y^{-1}xy$ is a quandle.
- Let G be an abelian group. For elements $x, y \in G$, define $x * y \equiv 2y - x$. Then $*$ defines a quandle structure on G called *Takasaki quandle*. In case $G = \mathbb{Z}_n$ (integers mod n) the quandle is called *dihedral quandle*. This quandle can be identified with the set of reflections of a regular n -gon with conjugation as the quandle operation.
- Any $\Lambda = (\mathbb{Z}[T^{\pm 1}])$ -module M is a quandle with $x * y = Tx + (1 - T)y$, $x, y \in M$, called an *Alexander quandle*.
- A *generalized Alexander quandle* is defined by a pair (G, f) where G is a group and $f \in \text{Aut}(G)$, and the quandle operation is defined by $x * y = f(xy^{-1})y$.

3. REVIEW OF THE QUANDLE POLYNOMIAL

In this section, we recall the definition of the quandle polynomial, the subquandle polynomial, and the link invariants obtained from the subquandle polynomial. For a detailed construction of these polynomials, see [10, 16].

Definition 3.1. Let $(Q, *)$ be a finite quandle. For any element $x \in Q$, let

$$C(x) = \{y \in Q : y * x = y\} \quad \text{and} \quad R(x) = \{y \in Q : x * y = x\}$$

and set $r(x) = |R(x)|$ and $c(x) = |C(x)|$. Then the *quandle polynomial* of Q , $qp_Q(s, t)$, is

$$qp_Q(s, t) = \sum_{x \in Q} s^{r(x)} t^{c(x)}.$$

In [16], the quandle polynomial was shown to be an effective invariant of finite quandles. In addition to being an invariant of finite quandles, the quandle polynomial was generalized to give information about how a subquandle is embedded in a larger quandle.

Definition 3.2. Let $S \subset Q$ be a subquandle of Q . The *subquandle polynomial* of S , $qp_{S \subset Q}(s, t)$, is

$$qp_{S \subset Q}(s, t) = \sum_{x \in S} s^{r(x)} t^{c(x)}$$

where $r(x)$ and $c(x)$ are defined above.

Note that for any knot or link K , there is an associated fundamental quandle, $Q(K)$, and for any given finite quandle T the set of quandle homomorphism, denoted by $\text{Hom}(Q(K), T)$, has been used to define computable link invariants, for example, the cardinality of the set is known as the *quandle counting invariant*. In [16], the subquandle polynomial of the image of each homomorphism was used to enhance the counting invariant.

Definition 3.3. Let K be a link and T be a finite quandle. Then for every $f \in \text{Hom}(Q(K), T)$, the image of f is a subquandle of T . The *subquandle polynomial invariant*, $\Phi_{qp}(K, T)$, is the set with multiplicities

$$\Phi_{qp}(K, T) = \{qp_{\text{Im}(f) \subset T}(s, t) \mid f \in \text{Hom}(Q(K), T)\}.$$

Alternatively, the multiset can be represented in polynomial form by

$$\phi_{qp}(K, T) = \sum_{f \in \text{Hom}(Q(K), T)} u^{qp_{\text{Im}(f) \subset T}(s, t)}.$$

4. ORIENTED SINGULAR KNOTS AND QUANDLES

In this section, we review the definition of a singquandle and we define the fundamental singquandle of a singular link. In [1], generating sets of the generalized Reidemeister moves were studied and were used to define oriented singquandles. An oriented singquandle can be thought of as an algebraic structure derived from a generating set of the oriented singular Reidemeister moves. We will follow the convention at classical crossings and singular crossings found in [1], see Figure 1.

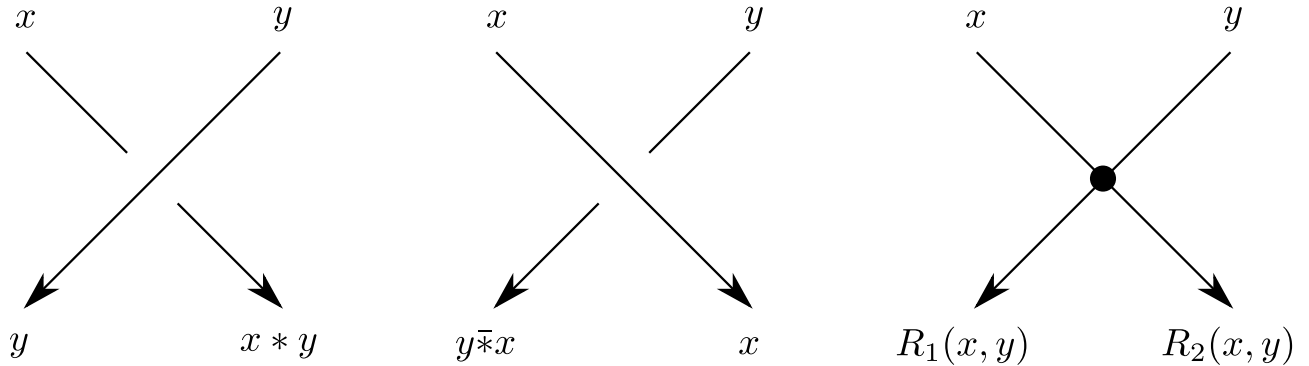

FIGURE 1. Colorings of classical and singular crossings.

The axioms of an oriented singquandle are derived by considering the moves in Figure 2 and writing the equations obtained using the above binary operations; see Figures 3, 4 and 5. Note that by letting $(X, *)$ be a quandle we can ignore the contributions from the classical Reidemeister moves.

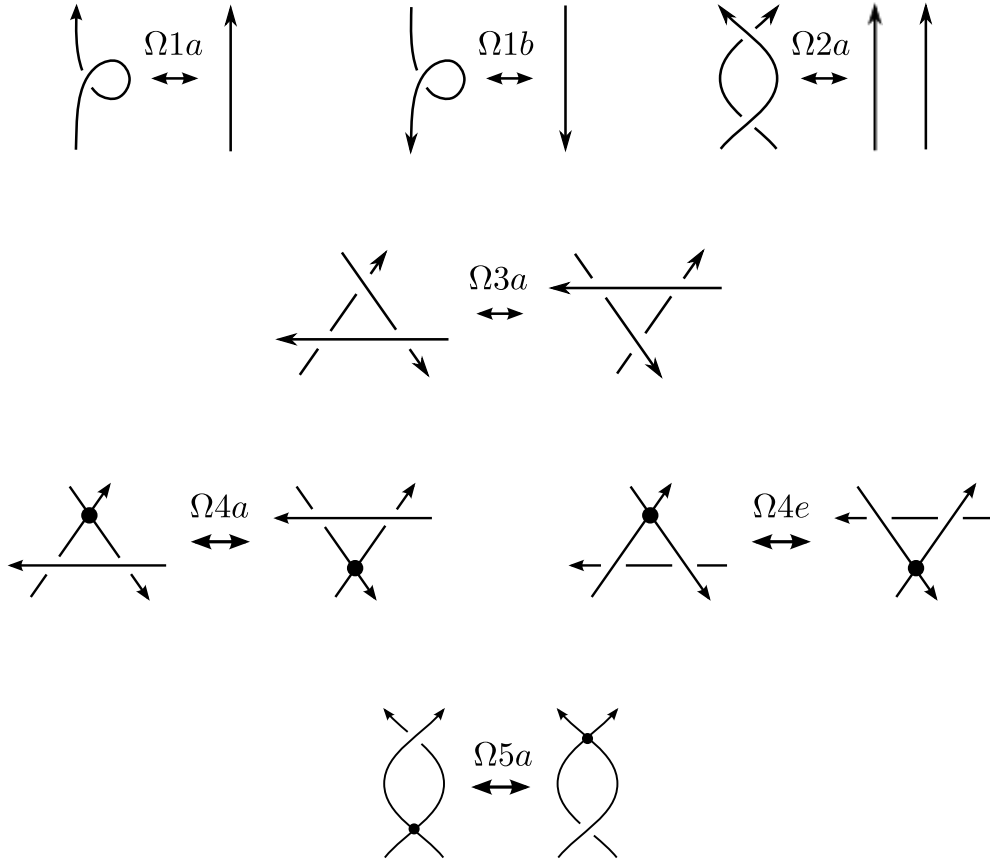

FIGURE 2. A generating set of singular Reidemeister moves

Definition 4.1. Let $(X, *)$ be a quandle. Let R_1 and R_2 be two maps from $X \times X$ to X . The quadruple $(X, *, R_1, R_2)$ is called an *oriented singquandle* if the following axioms are satisfied for all $a, b, c \in X$:

$$R_1(a\bar{*}b, c) * b = R_1(a, c * b) \tag{4.1}$$

$$R_2(a\bar{*}b, c) = R_2(a, c * b)\bar{*}b \tag{4.2}$$

$$(b\bar{*}R_1(a, c)) * a = (b * R_2(a, c))\bar{*}c \tag{4.3}$$

$$R_2(a, b) = R_1(b, a * b) \tag{4.4}$$

$$R_1(a, b) * R_2(a, b) = R_2(b, a * b). \tag{4.5}$$

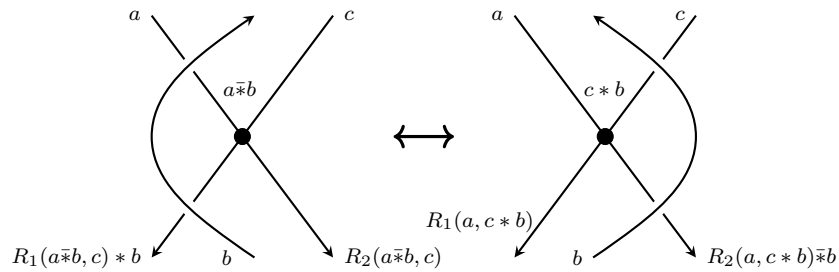

FIGURE 3. The Reidemeister move $\Omega 4a$ and colorings

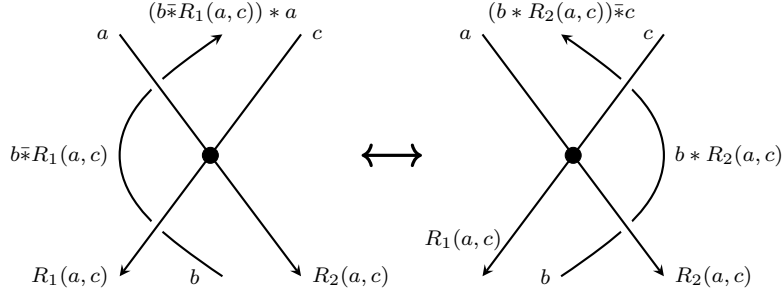

FIGURE 4. The Reidemeister move $\Omega 4e$ and colorings

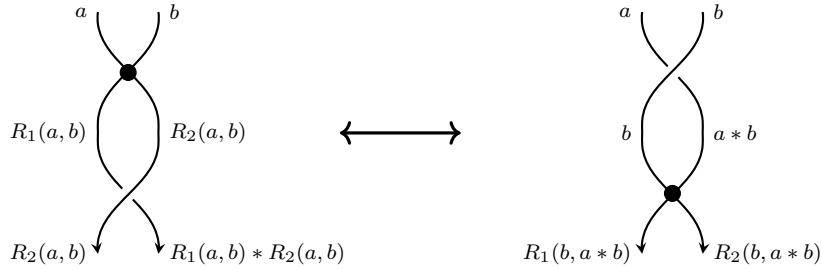

FIGURE 5. The Reidemeister move $\Omega 5a$ and colorings

Using affine functions for the maps $*$, R_1 and R_2 over the set \mathbb{Z}_n of integers mod n , the following example was obtained in [1].

Example 4.2. Take $X = \mathbb{Z}_n$. For an invertible element $t \in \mathbb{Z}_n$ and any $s \in \mathbb{Z}_n$, define $a * b = ta + (1 - t)b$, $R_1(a, b) = sa + (1 - s)b$ and $R_2(a, b) = t(1 - s)a + (1 - t + st)b$. Then $(\mathbb{Z}_n, *, R_1, R_2)$ is an oriented singquandle.

Now we define the notion of homomorphism and isomorphism of oriented singquandles. A map $f : X \rightarrow Y$ is called a *homomorphism* of oriented singquandles $(X, *, R_1, R_2)$ and $(Y, \triangleright, R'_1, R'_2)$ if the following conditions are satisfied for all $x, y \in X$

$$f(x * y) = f(x) \triangleright f(y) \tag{4.6}$$

$$f(R_1(x, y)) = R'_1(f(x), f(y)) \tag{4.7}$$

$$f(R_2(x, y)) = R'_2(f(x), f(y)). \tag{4.8}$$

An oriented singquandle *isomorphism* is a bijective oriented singquandle homomorphism, and two oriented singquandles are *isomorphic* if there exists an oriented singquandle isomorphism between them.

Definition 4.3. Let $(X, *, R_1, R_2)$ be a singquandle. A subset $M \subset X$ is called a subsingquandle if $(M, *, R_1, R_2)$ is itself a singquandle. In particular, M is closed under the operations $*$, R_1 and R_2 .

Example 4.4. The quadruple $(\mathbb{Z}, *, R_1, R_2)$ forms a singquandle with $x * y = 2y - x$, $R_1(x, y) = \alpha x + (1 - \alpha)y$ and $R_2(x, y) = (\alpha - 1)x + (2 - \alpha)y$, where $\alpha \in \mathbb{Z}$. For a fixed positive integer n , consider the subset $n\mathbb{Z} \subset \mathbb{Z}$. The linearity of the maps $*$, R_1 and R_2 immediately implies that $(n\mathbb{Z}, *, R_1, R_2)$ is a subsingquandle of $(\mathbb{Z}, *, R_1, R_2)$.

Given an oriented singquandle homomorphism, we obtain the following lemma.

Lemma 4.5. The image, $Im(f)$, of any oriented singquandle homomorphism $f : (X, *, R_1, R_2) \rightarrow (Y, \triangleright, R'_1, R'_2)$ is always a subsingquandle.

Proof. The equations (4.6), (4.7) and (4.8) imply that $Im(f)$ is closed under \triangleright, R'_1 and R'_2 . Since the identities of Definition 4.1 are satisfied in Y then they are automatically satisfied in $Im(f)$. This concludes the proof. \square

5. FUNDAMENTAL SINGQUANDLE OF A SINGULAR LINK

In this section, we define the fundamental singquandle of a singular link and we provide an example. Let D represent a diagram of an oriented singular link L . We define the *fundamental singquandle of D* , denoted by $\mathcal{SQ}(D)$, by proceeding as in classical knot theory with the fundamental quandle. That is, it is the quotient of the free singquandle on the set $S = \{a_1, \dots, a_m\}$ of arcs of D at regular crossings and semi-arcs at singular crossings of the diagram D modulo the equivalence relation generated by the regular and singular crossings in the diagram. In other words, if $x, y \in S$ then $x * y, x \bar{*} y, R_1(x, y), R_2(x, y) \in S$, thus making S a recursive set of generators and the set of relations come from the conditions at regular and singular crossings of D . The *fundamental singquandle of L* , denoted by $\mathcal{SQ}(L)$, is well defined since any two diagrams D_1 and D_2 of L are related by the generalized Reidemeister moves (as above) which correspond to making the equivalence relation representing the axioms of Definition 4.1. The following is an example for illustration.

Example 5.1. In this example, we present the fundamental singquandle of the following singular link. Consider the singular Hopf link with one singular crossing and one positive regular crossing represented by diagram D . Following the naming convention in [18], we will refer to this singular link as 1_1^l . We will label the arcs of the diagram D by x, y , and z . Then the

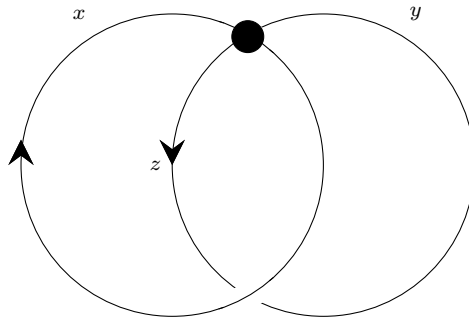

FIGURE 6. Diagram D of 1_1^l .

fundamental singquandle of 1_1^l is given by

$$\begin{aligned} \mathcal{SQ}(1_1^l) &= \langle x, y, z; x = R_2(x, y), z = R_1(x, y), z * x = y \rangle \\ &= \langle x, y; R_1(x, y) * R_2(x, y) = y \rangle. \end{aligned}$$

6. THE SINGQUANDLE POLYNOMIAL AND A SINGULAR LINK INVARIANT

We will define a generalization of the quandle polynomial, introduced in [16], to define a polynomial invariant of singular knots and links. We will first extend the definition of the quandle polynomial to obtain a singquandle polynomial. The quandle polynomial was extended to biquandles in [15]; we will similarly extend the quandle polynomial to singquandles. Since we are only considering oriented singquandles, we will refer to them as singquandles.

Definition 6.1. Let $(X, *, R_1, R_2)$ be a finite singquandle. For every $x \in X$, define

$$C^1(x) = \{y \in X \mid y * x = y\} \quad \text{and} \quad R^1(x) = \{y \in X \mid x * y = x\},$$

$$C^2(x) = \{y \in X \mid R_1(y, x) = y\} \quad \text{and} \quad R^2(x) = \{y \in X \mid R_1(x, y) = x\},$$

$$C^3(x) = \{y \in X \mid R_2(y, x) = y\} \quad \text{and} \quad R^3(x) = \{y \in X \mid R_2(x, y) = x\}.$$

Let $c^i(x) = |C^i(x)|$ and $r^i(x) = |R^i(x)|$ for $i = 1, 2, 3$. Then the *singquandle polynomial* of X is

$$sqp(X) = \sum_{x \in X} s_1^{r^1(x)} t_1^{c^1(x)} s_2^{r^2(x)} t_2^{c^2(x)} s_3^{r^3(x)} t_3^{c^3(x)}.$$

We note that the value $r^i(x)$ is the number of elements in X that act trivially on x , while $c^i(x)$ is the number of elements of X on which x acts trivially.

Proposition 6.2. If $(X, *, R_1, R_2)$ and $(Y, \triangleright, R'_1, R'_2)$ are isomorphic finite singquandles, then $sqp(X) = sqp(Y)$.

Proof. Suppose $f : X \rightarrow Y$ is a singquandle isomorphism and fix $x \in X$. For all $y \in C^1(x) = \{y \in X \mid y * x = y\}$, we have $f(y) \triangleright f(x) = f(y * x) = f(y)$, therefore, $f(y) \in C^1(f(x))$ and $|C^1(x)| \leq |C^1(f(x))|$. Applying the same argument to f^{-1} , we obtain the opposite inequality, and we have $c^1(x) = c^1(f(x))$. Note that by definition of a singquandle isomorphism we have, $R'_1(f(y), f(x)) = f(R_1(y, x)) = f(y)$ and $R'_2(f(y), f(x)) = f(R_2(y, x)) = f(y)$. Therefore, by applying a similar argument used to show $c^1(x) = c^1(f(x))$ we obtain $c^i(x) = c^i(f(x))$ for $i = 2, 3$. A similar argument also shows that $r^i(x) = r^i(f(x))$ for $i = 1, 2, 3$. Thus,

$$\begin{aligned} sqp(X) &= \sum_{x \in X} s_1^{r^1(x)} t_1^{c^1(x)} s_2^{r^2(x)} t_2^{c^2(x)} s_3^{r^3(x)} t_3^{c^3(x)} \\ &= \sum_{f(x) \in Y} s_1^{r^1(x)} t_1^{c^1(x)} s_2^{r^2(x)} t_2^{c^2(x)} s_3^{r^3(x)} t_3^{c^3(x)} \\ &= \sum_{f(x) \in Y} s_1^{r^1(f(x))} t_1^{c^1(f(x))} s_2^{r^2(f(x))} t_2^{c^2(f(x))} s_3^{r^3(f(x))} t_3^{c^3(f(x))} \\ &= sqp(Y). \end{aligned}$$

□

In the following example we will see that we can compute $r^i(x)$ (or $c^i(x)$) from each operation table by simply going through the rows (columns) and counting the occurrences of the row number.

Example 6.3. Let $X = \mathbb{Z}_4$ be the singquandle with operations $x * y = 3x + 2y$, $R_1(x, y) = 2x + 3y$, and $R_2(x, y) = x$. We obtain this singquandle from Example 4.2, by letting $n = 4$,

$t = 3$, and $s = 2$. These operations have the following operation tables,

$*$	1	2	3	0	R_1	1	2	3	0	R_2	1	2	3	0
1	1	3	1	3	1	1	0	3	2	1	1	1	1	1
2	0	2	0	2	2	3	2	1	0	2	2	2	2	2
3	3	1	3	1	3	1	0	3	2	3	3	3	3	3
0	2	0	2	0	0	3	2	1	0	0	0	0	0	0

and the operations have the following $r^i(x)$ and $c^i(x)$ values for $i = 1, 2, 3$:

x	$r^1(x)$	$c^1(x)$	x	$r^2(x)$	$c^2(x)$	x	$r^3(x)$	$c^3(x)$
1	2	2	1	1	1	1	4	4
2	2	2	2	1	1	2	4	4
3	2	2	3	1	1	3	4	4
0	2	2	0	1	1	0	4	4

Thus, the singquandle polynomial of X is

$$sqp(X) = 4s_1^2t_1^2s_2t_2s_3^4t_3^4.$$

Example 6.4. Let $Y = \mathbb{Z}_4$ be the singquandle with operations $x \triangleright y = 3x + 2xy$, $R'_1(x, y) = 3x + 2xy + 2y$, and $R'_2(x, y) = 2x + 2xy + 3y$. A direct computation shows that in fact the operations \triangleright, R'_1 and R'_2 satisfy the axioms of Definition 4.1. These operations have the following operation tables,

\triangleright	1	2	3	0	R'_1	1	2	3	0	R'_2	1	2	3	0
1	1	3	1	3	1	3	3	3	3	1	3	0	1	2
2	2	2	2	2	2	0	2	0	2	2	3	2	1	0
3	3	1	3	1	3	1	1	1	1	3	3	0	1	2
0	0	0	0	0	0	2	0	2	0	0	3	2	1	0

The operations \triangleright, R'_1 and R'_2 have respectively the following $r^i(x)$ and $c^i(x)$ values for $i = 1, 2, 3$:

x	$r^1(x)$	$c^1(x)$	x	$r^2(x)$	$c^2(x)$	x	$r^3(x)$	$c^3(x)$
1	2	4	1	0	0	1	1	1
2	4	2	2	2	2	2	1	1
3	2	4	3	0	0	3	1	1
0	4	2	0	2	2	0	1	1

Thus, the singquandle polynomial of Y is

$$sqp(Y) = 2s_1^2t_1^4s_3t_3 + 2s_1^4t_1^2s_2^2t_2^2s_3t_3.$$

Therefore, by Proposition 6.2 we can distinguish the singquandle $(Y, \triangleright, R'_1, R'_2)$ in this example and the singquandle $(X, *, R_1, R_2)$ in Example 6.3.

We will now extend the subquandle polynomial defined in [16] to the case of subsingquandles.

Definition 6.5. Let X be a finite singquandle and $S \subset Q$ a subsingquandle. Then the *subsingquandle polynomial* is

$$Ssqp(S \subset X) = \sum_{x \in S} s_1^{r^1(x)} t_1^{c^1(x)} s_2^{r^2(x)} t_2^{c^2(x)} s_3^{r^3(x)} t_3^{c^3(x)}.$$

Therefore, the subsingquandle polynomials are the contributions to the singquandle polynomial coming from the subsingquandles we are considering.

Example 6.6. Consider the subsingquandle $S_1 = \{1, 3\}$ of X defined in Example 6.3. Thus, the subsingquandle polynomial

$$Ssqp(S_1 \subset X) = 2s_1^2t_1^2s_2t_2s_3^4t_3^4.$$

For any singular link L , there is an associated fundamental singquandle $(\mathcal{SQ}(L), *, R_1, R_2)$, and for a finite singquandle $(T, \triangleright, R'_1, R'_2)$ the set of singquandle homomorphisms

$$\begin{aligned} \text{Hom}(\mathcal{SQ}(L), T) = \{f : \mathcal{SQ}(L) \rightarrow T \mid f(x * y) = f(x) \triangleright f(y), \\ f(R_1(x, y)) = R'_1(f(x), f(y)), f(R_2(x, y)) = R'_2(f(x), f(y))\} \end{aligned}$$

can be used to construct computable invariants for singular knots. For example, by computing the cardinality of this set we obtain the singquandle counting invariant defined in [6]. By Lemma 4.5, the image of a homomorphism from the fundamental singquandle of L to a singquandle T is a subsingquandle of T . Therefore, we can modify the singquandle counting invariant to obtain a multiset-valued link invariant by considering the subsingquandle polynomial of the image of f , for each $f \in \text{Hom}(\mathcal{SQ}(L), T)$. By computing the cardinality of this multiset we retrieve the singquandle counting invariant. Additionally, the subsingquandle polynomial is a generalization of the specialized subquandle polynomial invariant which was shown in [16] to distinguish some classical links which have the same quandle counting invariant.

Definition 6.7. Let L be a singular link, T be a finite singquandle. Then the multiset

$$\Phi_{Ssqp}(L, T) = \{Ssqp(\text{Im}(f) \subset T) \mid f \in \text{Hom}(\mathcal{SQ}(L), T)\}$$

is the *subsingquandle polynomial invariant* of L with respect to T . We can rewrite the multiset in a polynomial-style form by converting the multiset elements to exponents of a formal variable u and converting their multiplicities to coefficients:

$$\phi_{Ssqp}(L, T) = \sum_{f \in \text{Hom}(\mathcal{SQ}(L), T)} u^{Ssqp(\text{Im}(f) \subset T)}.$$

Remark 6.8. Let $t_i = s_i = 0$ for $i = 1, 2, 3$ in the subquandle polynomial invariant of L , then we obtain

$$\phi_{Ssqp}(L, T) = \sum_{f \in \text{Hom}(\mathcal{SQ}(L), T)} u^0 = |\text{Hom}(\mathcal{SQ}(L), T)|.$$

We will show that the subsingquandle polynomial invariant contains more data than just the singquandle counting invariant.

7. EXAMPLES

In this section, we distinguish singular knots and links by computing the subsingquandle polynomial invariant defined in the previous section.

Example 7.1. Consider the 2-bouquet graphs of type L listed as 1_1^l and 6_{11}^l in [18]. Let $(X, *, R_1, R_2)$ be the singquandle with $X = \mathbb{Z}_8$ and operations $x * y = 7x + 6y + 4xy = x \bar{*} y$, $R_1(x, y) = 2x + 7y + 4xy$ and $R_2(x, y) = 4x^2 + 5x + 4y$. A direct computation shows that the operations $*, R_1$ and R_2 satisfy the axioms of Definition 4.1. We can also represent these

operations by the following operation tables,

*	1	2	3	4	5	6	7	0	R_1	1	2	3	4	5	6	7	0	R_2	1	2	3	4	5	6	7	0
1	1	3	5	7	1	3	5	7	1	5	0	3	6	1	4	7	2	1	5	1	5	1	5	1	5	1
2	4	2	0	6	4	2	0	6	2	3	2	1	0	7	6	5	4	2	6	2	6	2	6	2	6	2
3	7	1	3	5	7	1	3	5	3	1	4	7	2	5	0	3	6	3	7	3	7	3	7	3	7	3
4	2	0	6	4	2	0	6	4	4	7	6	5	4	3	2	1	0	4	0	4	0	4	0	4	0	4
5	5	7	1	3	5	7	1	3	5	5	0	3	6	1	4	7	2	5	1	5	1	5	1	5	1	5
6	0	6	4	2	0	6	4	2	6	3	2	1	0	7	6	5	4	6	2	6	2	6	2	6	2	6
7	3	5	7	1	3	5	7	1	7	1	4	7	2	5	0	3	6	7	3	7	3	7	3	7	3	7
0	6	4	2	0	6	4	2	0	0	7	6	5	4	3	2	1	0	0	4	0	4	0	4	0	4	0

The following tables include $r^i(x)$ and $c^i(x)$ values for $i = 1, 2, 3$,

x	$r^1(x)$	$c^1(x)$	x	$r^2(x)$	$c^2(x)$	x	$r^3(x)$	$c^3(x)$
1	2	2	1	1	1	1	4	0
2	2	2	2	1	1	2	4	8
3	2	2	3	1	1	3	4	0
4	2	2	4	1	1	4	4	8
5	2	2	5	1	1	5	4	0
6	2	2	6	1	1	6	4	8
7	2	2	7	1	1	7	4	0
0	2	2	0	1	1	0	4	8

The singular link 1_1^l , Figure 7, has the system of coloring equations given by

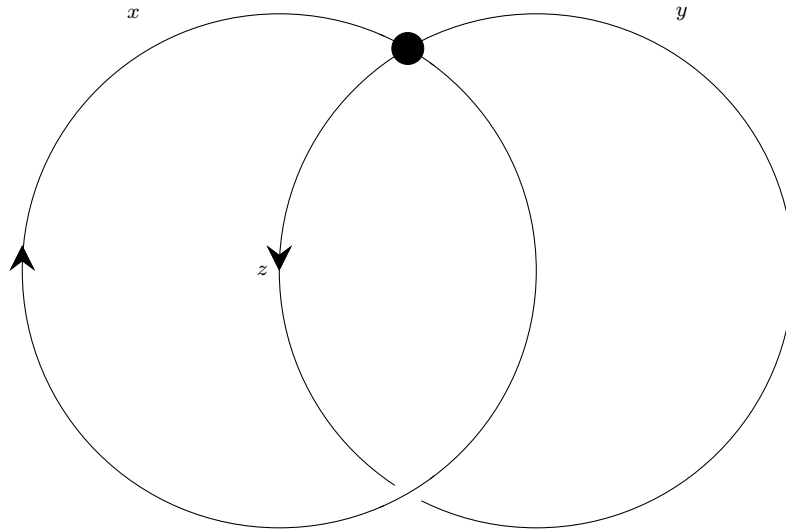

FIGURE 7. Diagram of 1_1^l .

$$\begin{aligned}
 4x^2 + 5x + 4y &= R_2(x, y) = x \\
 7z + 6x + 4xz &= z * x = y \\
 2x + 7y + 4xy &= R_1(x, y) = z.
 \end{aligned}$$

Thus, 1_1^l has 16 coloring by X . In Table 1, we list all coloring of 1_1^l by X with the corresponding subsingquandle.

x	y	z	subsingquandle
2	2	2	{2}
2	4	0	{2, 4, 6, 0}
2	6	6	{2, 6}
2	0	4	{2, 4, 6, 0}
4	2	6	{2, 4, 6, 0}
4	4	4	{4}
4	6	2	{2, 4, 6, 0}
4	0	0	{4, 0}
6	2	2	{2, 6}
6	4	0	{2, 4, 6, 0}
6	6	6	{6}
6	0	4	{2, 4, 6, 0}
0	2	6	{2, 4, 6, 0}
0	4	4	{4, 0}
0	6	2	{2, 4, 6, 0}
0	0	0	{0}

TABLE 1. List of colorings of 1_1^l by X and the corresponding subsingquandle.

The singular link 6_{11}^l , Figure 8, has the system of coloring equations given by

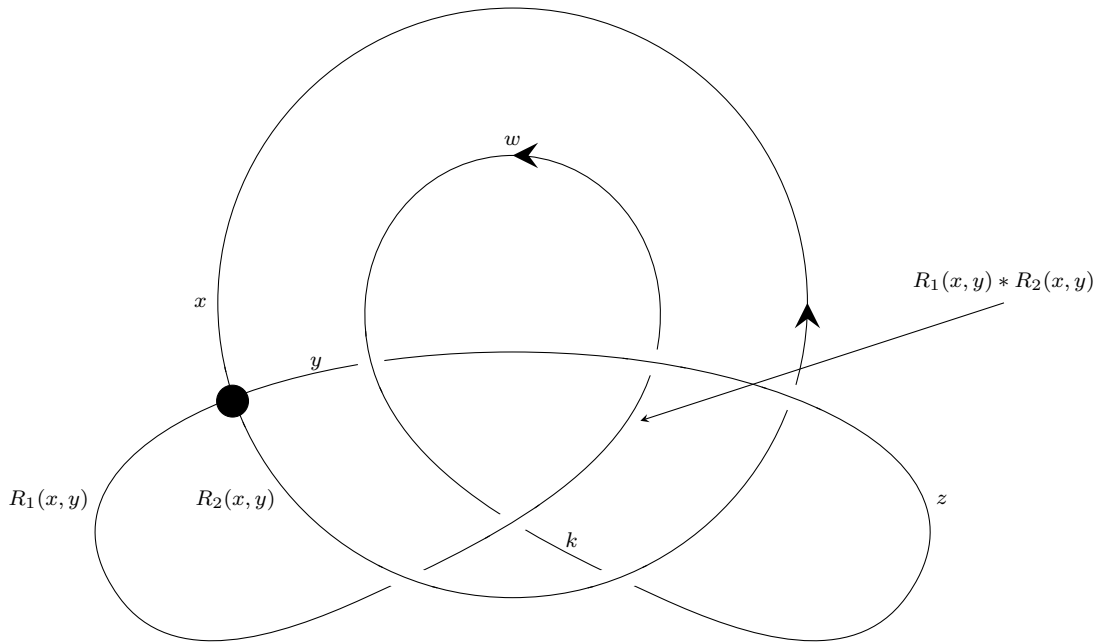

FIGURE 8. Diagram of 6_{11}^l .

$$\begin{aligned}
3x + 4x^2 + 4y + 6z + 4xz &= R_2(x, y)\bar{*}z = x \\
6w + 7z + 4wz &= z\bar{*}w = y \\
7k + 6x + 4kx &= k\bar{*}R_2(x, y) = z \\
4x + 7y + 6z + 4yz &= (R_1(x, y) * R_2(x, y))\bar{*}z = w \\
7w + 6y + 4wy &= w\bar{*}(R_1(x, y) * R_2(x, y)) = k.
\end{aligned}$$

Therefore, 6_{11}^l also has 16 coloring by X . In Table 2, we list all coloring of 1_1^l by X with the corresponding subsingquandle.

x	y	z	w	k	$R_1(x, y)$	$R_2(x, y)$	$R_1(x, y) * R_2(x, y)$	subsingquandle
1	3	3	7	7	3	5	7	{1, 3, 5, 7}
1	7	7	3	3	7	5	3	{1, 3, 5, 7}
2	2	2	2	2	2	2	2	{2}
2	6	6	6	6	6	2	6	{2, 6}
3	1	1	5	5	1	7	5	{1, 3, 5, 7}
3	5	5	1	1	5	7	1	{1, 3, 5, 7}
4	4	4	4	4	4	4	4	{4}
4	0	0	0	0	0	4	0	{4, 0}
5	3	3	7	7	3	1	7	{1, 3, 5, 7}
5	7	7	3	3	7	1	3	{1, 3, 5, 7}
6	2	2	2	2	2	6	2	{2, 6}
6	6	6	6	6	6	6	6	{6}
7	1	1	5	5	1	3	5	{1, 3, 5, 7}
7	5	5	1	1	5	3	1	{1, 3, 5, 7}
0	4	4	4	4	4	0	4	{4, 0}
0	0	0	0	0	0	0	0	{0}

TABLE 2. List of colorings of 6_{11}^l by X and the corresponding subsingquandle.

Furthermore, both 1_1^l and 6_{11}^l have the same Jablan polynomial, $\Delta_J(1_1^l) = s - t = \Delta_J(6_{11}^l)$ as computed in [17]. However, the subsingquandle polynomial invariants

$$\phi_{Ssqp}(1_1^l, X) = 8u^{4s_1^2t_1^2s_2t_2s_3^4t_3^8} + 4u^{2s_1^2t_1^2s_2t_2s_3^4t_3^8} + 4u^{s_1^2t_1^2s_2t_2s_3^4t_3^8}$$

and

$$\phi_{Ssqp}(6_{11}^l, X) = 8u^{4s_1^2t_1^2s_2t_2s_3^4} + 4u^{2s_1^2t_1^2s_2t_2s_3^4t_3^8} + 4u^{s_1^2t_1^2s_2t_2s_3^4t_3^8}$$

distinguish these singular links.

Example 7.2. Consider the singquandle $X = \mathbb{Z}_8$ with operations $x * y = 5x + 4y = x\bar{*}y$ and $R_1(x, y) = 6 + 5x + 6xy$, and $R_2(x, y) = 6 + 5y + 6xy$. A direct computation shows that the operations $*, R_1$ and R_2 satisfy the axioms of Definition 4.1. The following singular knot K_1 below has the following coloring equations

$$\begin{aligned}
6 + 5k + 6kl &= R_1(k, l) = x \\
6 + 5l + 6kl &= R_2(k, l) = y \\
6 + 5x + 6xy &= R_1(x, y) = z \\
6 + 5y + 6xy &= R_2(x, y) = w \\
6 + 5w + 6wz &= R_2(z, w) = l \\
6 + 5z + 6wz &= R_1(z, w) = k.
\end{aligned}$$

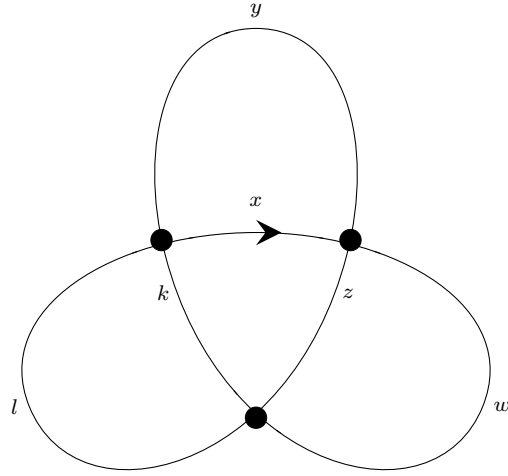

FIGURE 9. Diagram of K_1 .

Therefore, K_1 has 8 colorings by X . The singular knot K_2 below has the following coloring

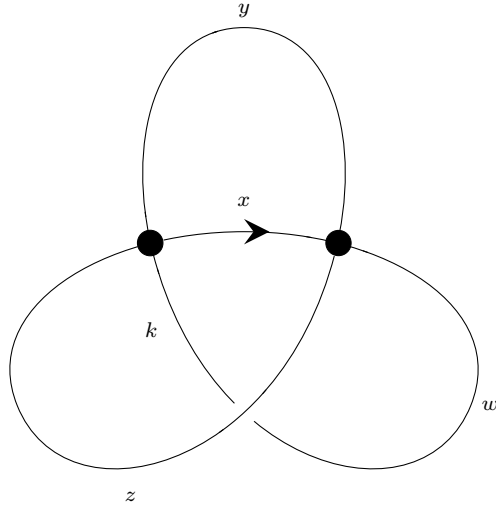

FIGURE 10. Diagram of K_2 .

equations

$$\begin{aligned}
 6 + 5k + 6kz &= R_1(k, z) = x \\
 6 + 5z + 6kz &= R_2(k, z) = y \\
 6 + 5x + 6xy &= R_1(x, y) = z \\
 6 + 5y + 6xy &= R_2(x, y) = w \\
 5w + 4z &= w\bar{z} = k.
 \end{aligned}$$

Therefore, K_2 also has 8 colorings by X . However, the subsingquandle polynomial invariants

$$\phi_{Ssqp}(K_1, X) = 4u^{s_1^4 t_1^4 s_2^2 t_2^2 s_3 t_3} + 4u^{2s_1^4 t_1^4 s_2^2 t_2^2 s_3 t_3}$$

and

$$\phi_{Ssqp}(K_2, X) = 4u^{4s_1^4 t_1^4 s_3 t_3} + 4u^{s_1^4 t_1^4 s_2^2 t_2^2 s_3 t_3}$$

distinguish the singular knots K_1 and K_2 .

Acknowledgement: The authors would like to thank the anonymous referee for fruitful comments which improved the paper.

REFERENCES

- [1] Khaled Bataineh, Mohamed Elhamdadi, Mustafa Hajij, and William Youmans, *Generating sets of Reidemeister moves of oriented singular links and quandles*, J. Knot Theory Ramifications **27** (2018), no. 14, 1850064, 15. MR3896310 [↑1, 3, 5](#)
- [2] Joan S. Birman and Xiao-Song Lin, *Knot polynomials and Vassiliev's invariants*, Invent. Math. **111** (1993), no. 2, 225–270. MR1198809 [↑1](#)
- [3] J. Scott Carter, Mohamed Elhamdadi, and Masahico Saito, *Homology theory for the set-theoretic Yang-Baxter equation and knot invariants from generalizations of quandles*, Fund. Math. **184** (2004), 31–54. MR2128041 [↑1](#)
- [4] Jose Cenicerós, Indu R. U. Churchill, Mohamed Elhamdadi, and Mustafa Hajij, *Cocycle Invariants and Oriented Singular Knots*, arXiv:2009.07950 (2020), 15 pp. [↑1](#)
- [5] Jose Cenicerós and Sam Nelson, *Virtual Yang-Baxter cocycle invariants*, Trans. Amer. Math. Soc. **361** (2009), no. 10, 5263–5283. MR2515811 [↑1](#)
- [6] Indu R. U. Churchill, Mohamed Elhamdadi, Mustafa Hajij, and Sam Nelson, *Singular Knots and Involutive Quandles*, J. Knot Theory Ramifications **26** (2017), no. 14, 1750099, 14 pp. MR1362791 (96i:57015) [↑1, 9](#)
- [7] Mohamed Elhamdadi, *Distributivity in quandles and quasigroups*, Algebra, geometry and mathematical physics, Springer Proc. Math. Stat., vol. 85, Springer, Heidelberg, 2014, pp. 325–340. MR3275946 [↑1](#)
- [8] Mohamed Elhamdadi, Neranga Fernando, and Boris Tsvetikhovskiy, *Ring theoretic aspects of quandles*, J. Algebra **526** (2019), 166–187. MR3915329 [↑1](#)
- [9] Mohamed Elhamdadi and El-kaïoum M. Moutouou, *Finitely stable racks and rack representations*, Comm. Algebra **46** (2018), no. 11, 4787–4802. MR3864263 [↑1](#)
- [10] Mohamed Elhamdadi and Sam Nelson, *Quandles—an introduction to the algebra of knots*, Student Mathematical Library, vol. 74, American Mathematical Society, Providence, RI, 2015. MR3379534 [↑1, 2](#)
- [11] V. F. R. Jones, *Hecke algebra representations of braid groups and link polynomials*, Ann. of Math. (2) **126** (1987), no. 2, 335–388. MR908150 [↑1](#)
- [12] David Joyce, *A classifying invariant of knots, the knot quandle*, J. Pure Appl. Algebra **23** (1982), no. 1, 37–65. MR638121 [↑1, 2](#)
- [13] Jesús Juyumaya and Sofia Lambropoulou, *An invariant for singular knots*, Journal of Knot Theory and Its Ramifications **18** (2009), no. 06, 825–840. [↑1](#)
- [14] S. V. Matveev, *Distributive groupoids in knot theory*, Mat. Sb. (N.S.) **119(161)** (1982), no. 1, 78–88, 160 (Russian). MR672410 [↑1, 2](#)
- [15] Sam Nelson, *Generalized quandle polynomials*, Canad. Math. Bull. **54** (2011), no. 1, 147–158. MR2797975 [↑7](#)
- [16] ———, *A polynomial invariant of finite quandles*, J. Algebra Appl. **7** (2008), no. 2, 263–273. MR2417045 [↑1, 2, 3, 7, 8, 9](#)
- [17] Sam Nelson, Natsumi Oyamaguchi, and Radmila Sazdanovic, *Psyquandles, singular knots and pseudoknots*, Tokyo J. Math. **42** (2019), no. 2, 405–429. MR4106586 [↑1, 12](#)
- [18] Natsumi Oyamaguchi, *Enumeration of spatial 2-bouquet graphs up to flat vertex isotopy*. part B, Topology Appl. **196** (2015), no. part B, 805–814. MR3431017 [↑6, 9](#)
- [19] V. A. Vassiliev, *Cohomology of knot spaces*, Theory of singularities and its applications, Adv. Soviet Math., vol. 1, Amer. Math. Soc., Providence, RI, 1990, pp. 23–69. MR1089670 [↑1](#)

HAMILTON COLLEGE, CLINTON, NY
Email address: jcenicer@hamilton.edu

STATE UNIVERSITY OF NEW YORK AT OSWEGO, OSWEGO, NY
Email address: indurasika.churchill@oswego.edu

UNIVERSITY OF SOUTH FLORIDA, TAMPA, FL
Email address: emohamed@math.usf.edu