

# DIAGONALS AND A-INFINITY TENSOR PRODUCTS

ROBERT LIPSHITZ, PETER OZSVÁTH, AND DYLAN P. THURSTON

ABSTRACT. Extending work of Saneblidze-Umble and others, we use diagonals for the associahedron and multiplihedron to define tensor products of  $A_\infty$ -algebras, modules, algebra homomorphisms, and module morphisms, as well as to define a bimodule analogue of twisted complexes (type  $DD$  structures, in the language of bordered Heegaard Floer homology) and their one- and two-sided tensor products. We then give analogous definitions for 1-parameter deformations of  $A_\infty$ -algebras; this involves another collection of complexes. These constructions are relevant to bordered Heegaard Floer homology.

## CONTENTS

List of Figures	3
1. Introduction	4
1.1. Context and motivation	4
1.2. Statement of results in the unweighted case	5
1.3. Statement of results in the weighted case	7
1.4. Additional topics	9
Acknowledgments.	10
2. Diagonals: definitions, existence	10
2.1. Trees and the associahedron	10
2.2. Algebra diagonals	12
2.3. Module diagonals	15
2.4. Module diagonal primitives	16
2.5. Multiplihedra and multiplihedron diagonals	21
2.6. Module-map diagonals	24
2.7. Module-map primitives and partial module-map diagonals	27
2.8. DADD diagonals	31
3. Applications of diagonals	33
3.1. The $dg$ category of chain complexes	33
3.2. Tensor products of $A_\infty$ -algebras	34
3.3. Tensor products of $A_\infty$ -modules	37
3.4. Type $D$ and $DD$ structures	42
3.5. Box products of type $DD$ structures	44
3.6. Further tensor products of modules and bimodules	56
3.7. Units in $A_\infty$ -algebras	61
4. Weighted $A_\infty$ algebras and weighted trees	70
4.1. Weighted $A_\infty$ algebras and the weighted trees complex	70
4.2. Weighted algebra maps and weighted transformation trees	74
4.3. Units in weighted $A_\infty$ -algebras	76

*Date:* September 15, 2023.

2020 *Mathematics Subject Classification.* Primary 18G70; Secondary 52B05, 55U05, 57R58.

RL was supported by NSF grant DMS-1810893.

PSO was supported by NSF grants DMS-1708284 and DMS-2104536.

DPT was supported by NSF grants DMS-1507244 and DMS-2110143.

4.4.	Weighted modules and weighted module trees	79
4.5.	Weighted module transformation trees and weighted module maps	80
4.6.	Units in weighted $A_\infty$ -modules	82
4.7.	Weighted type $D$ structures	85
4.8.	Box products	87
4.9.	Homotopy unital weighted algebras and modules	88
5.	The weighted trees complexes are contractible	99
5.1.	Signs on the weighted trees complex	99
5.2.	Contractibility of the weighted trees complex	99
5.3.	The weighted module trees complex is acyclic	103
5.4.	The weighted transformation trees complex is contractible	103
5.5.	The weighted module transformation trees complex is acyclic	104
5.6.	The homotopy unital complexes are contractible	104
6.	Weighted diagonals	105
6.1.	Dimension and weight	105
6.2.	Weighted algebra diagonals	105
6.3.	Weighted map diagonals	108
6.4.	Weighted module diagonals	111
6.5.	Weighted primitives	112
6.6.	Weighted module-map diagonals	116
6.7.	Weighted DADD diagonals	120
6.8.	Homotopy unital diagonals	121
7.	Algebraic applications of weighted diagonals	125
7.1.	Tensor products of weighted algebras	125
7.2.	Tensor products of weighted modules	127
7.3.	Type $DD$ structures and box products	129
7.4.	Tensor products of homotopy unital weighted algebras and associativity of the tensor product	137
7.5.	The category of type $D$ structures over a homotopy unital algebra and independence of the category of type $DD$ structures from the algebra diagonal	140
8.	The associaplex	148
9.	On boundedness	159
Appendix A.	Terms in diagonals	163
Appendix B.	A convention of tables	167
References		168

## LIST OF FIGURES

1	Some trees	10
2	Examples of composition of trees	12
3	From an associahedron tree diagonal to an associahedron diagonal	14
4	A profile tree	14
5	The first three terms in a module diagonal associated to a module diagonal primitive	16
6	Joining trees	16
7	The first three terms in a module diagonal primitive	17
8	The differential on the multiplihedron	22
9	Depth-first search	22
10	The first three terms in a multiplihedron diagonal	23
11	Module transformation trees	25
12	The first few terms in a module-map tree diagonal	26
13	The first few terms in a module-map diagonal primitive	28
14	The first few terms in a DADD diagonal	32
15	Module bi-transformation trees	40
16	The structure operation on the one-sided box tensor product	46
17	Box products of two $DA$ structure, and of an $A$ -infinity bimodule and a $DA$ structure.	57
18	Operation trees used to make a weakly unital algebra strictly unital	62
19	Cancellations of tree juxtapositions	63
20	Verifying the $A$ -infinity relation for a particular map	64
21	Trees of type $DH$ , for relating the unital and non-unital morphism complexes	67
22	Trees of type $HD$ , for relating the unital and non-unital morphism complexes	68
23	Trees appearing in a particular homomorphism $F$	69
24	Some weighted $A$ -infinity relations	71
25	A stably-weighted tree and two contractions of it	72
26	Some weighted $A$ -infinity module relations	80
27	A thorn tree and its differential	90
28	Notation for weighted corollas with thorns	90
29	Transformation thorn trees and their differentials	92
30	The collapsed composition of homotopy unital purple corollas	93
31	Composing homotopy unital weighted module morphisms	96
32	A case in the proof that the weighted trees complex is contractible	101
33	Another case in the proof that the weighted trees complex is contractible	101
34	Examples of leaf sequences, for contractibility of the weighted trees complex	102
35	Terms in a maximal weighted algebra diagonal	107
36	Differential of a purple corolla composed with a stump	109
37	Existence of weighted map diagonals	110
38	Terms in a weighted module diagonal compatible with Figure 35	112
39	Terms in a weighted module diagonal primitive	114

40	A weighted module-map diagonal	117
41	A weighted module-map primitive	118
42	Weighted DADD diagonals	120
43	Terms in a homotopy unital algebra diagonal	122
44	Terms in a homotopy unital module diagonal	123
45	Terms in a homotopy unital map diagonal	124
46	Terms in a homotopy module-map diagonal	124
47	Examples of homotopy unital compositions on the category of type $D$ structures	141
48	Generic case of the proof of Proposition 7.49	144
49	Convergence in the associaplex	149

## 1. INTRODUCTION

**1.1. Context and motivation.** This paper develops the homological algebra underpinning construction of bordered Floer homology for the full Heegaard Floer homology package [OSz04b]. While the paper is purely about homological algebra, we start with a brief discussion of the motivation from topology. This discussion is not needed for the rest of the paper.

Bordered Floer homology [LOT18] associates a  $dg$  algebra  $\mathcal{A}(F)$  to a surface  $F$ , an  $A_\infty$ -module  $\overline{CFA}(Y_1)$  over  $\mathcal{A}(F)$  to a three-manifold  $Y_1$  equipped with an identification  $\partial Y_1 = F$ , and a twisted complex, or type  $D$  structure,  $\overline{CFD}(Y_2)$  over  $\mathcal{A}(F)$  to a three-manifold  $Y_2$  with  $\partial Y_2 = -F$ . A pairing theorem then describes the  $U = 0$ -specialized Heegaard Floer complex of the closed three-manifold  $Y = Y_1 \cup_F Y_2$ , as a certain type of tensor product of  $\overline{CFA}(Y_1)$  with  $\overline{CFD}(Y_2)$ . Moreover, the modules  $\overline{CFA}(Y_2)$  and  $\overline{CFD}(Y_2)$  are related by tensoring with certain bimodules, called the type  $AA$  and  $DD$  bimodules of the identity map; see [LOT15].

The  $U = 0$  specialization of Heegaard Floer homology, denoted  $\widehat{HF}$ , is useful for certain three-dimensional applications, such as detecting the Thurston norm of the three-manifold [OSz04a, Ni13]; it is, however, insufficient to access many the four-dimensional aspects, which were the original motivation for the construction of the theory; see [OSz06]. To gain access to the full power of Heegaard Floer homology, one must use the  $U$ -unspecialized version of Heegaard Floer homology,  $HF^-$ .

Extending the bordered theory to  $HF^-$  presents new challenges, arising from the existence of holomorphic disks which are now allowed to cover the entire Heegaard surface. This phenomenon has both geometric and algebraic manifestations.

The aim of this work is to treat the algebraic aspects. In particular, the basic algebraic structures appearing in bordered Floer homology need to be generalized for the extension. Rather than associating a  $dg$  algebra to a surface, we associate a certain kind of curved  $A_\infty$ -algebra, which we call a *weighted  $A_\infty$ -algebra*. Similarly, the modules associated to three-manifolds with boundary have the form of weighted  $A_\infty$ -modules, and weighted type  $D$  structures. The definitions of these algebraic objects are fairly straightforward. By contrast, the notions of bimodules and the generalizations of the tensor product to them are more complicated to define. Specifically, they depend on a generalization of Stasheff’s associahedron which we call the *weighted associaplex* and various notions of “diagonals”, generalizing the ones used by Sanedlidze-Umble to construct tensor products of  $A_\infty$ -algebras [SU04] (see also [MS06, Lod11]).

Although bordered Heegaard Floer homology was our motivation for this work, we hope that some of the formal aspects explored here will be of independent interest. For example, it is quite likely that other gauge-theoretic invariants, such as instanton homology [Flo88] and Seiberg-Witten

theory [KM07] have bordered analogues, with similar algebraic structure; see especially [Wan20]. It is also conceivable that the algebraic structures may be of interest elsewhere in symplectic geometry (compare, for instance, [Sei02, Aur10, Amo16]).

**1.2. Statement of results in the unweighted case.** As a warm-up, we start with the now well understood case of tensor products of  $A_\infty$ -algebras. This operation was described by Sanedblidze and Umble; we review their construction, with a view towards subsequent generalizations.

Fix a commutative, unital  $\mathbb{F}_2$ -algebra  $R$  (possibly graded). Throughout, by a module (respectively chain complex) we mean a free or, more generally, projective  $R$ -module (respectively chain complex of projective  $R$ -modules). Unless otherwise specified, in this section undecorated tensor products are over  $R$ . (For example, in bordered Floer theory one might take  $R = \mathbb{F}_2$ .)

Let  $K_n$  denote the  $(n - 2)$ -dimensional *associahedron*, introduced by Stasheff in [Sta63]. Cells of  $K_n$  are in a natural one-to-one correspondence with planar, rooted trees with  $n$  inputs and no 2-valent vertices. An *associahedron diagonal* is a collection of chain maps

$$\Gamma = \{\Gamma_n : C_*^{cell}(K_n) \rightarrow C_*^{cell}(K_n \times K_n)\}_{n=2}^\infty$$

satisfying compatibility and non-degeneracy conditions (Definition 2.13).

Given  $A_\infty$ -algebras  $\mathcal{A}_1$  and  $\mathcal{A}_2$  over  $R$ , we use the associahedron diagonal to define a tensor product over  $R$ , denoted  $\mathcal{A}_1 \otimes_\Gamma \mathcal{A}_2$  (Definition 3.6), giving the following reformulation of results from Sanedblidze-Umble [SU04]:

**Theorem 1.1.** *There exist associahedron diagonals  $\Gamma$ , which can be used to define a tensor product  $\mathcal{A}_1 \otimes_\Gamma \mathcal{A}_2$  of  $A_\infty$ -algebras  $\mathcal{A}_1$  and  $\mathcal{A}_2$ , with the following properties:*

- (A1) *The underlying  $R$ -module of  $\mathcal{A}_1 \otimes_\Gamma \mathcal{A}_2$  is the tensor product (over  $R$ )  $\mathcal{A}_1 \otimes \mathcal{A}_2$  of the underlying  $R$ -modules of  $\mathcal{A}_1$  and  $\mathcal{A}_2$ .*
- (A2) *If  $\mathcal{A}_1$  and  $\mathcal{A}_2$  are differential graded algebras, then  $\mathcal{A}_1 \otimes_\Gamma \mathcal{A}_2$  is a dg algebra and there is an isomorphism of dg algebras*

$$\mathcal{A}_1 \otimes_\Gamma \mathcal{A}_2 \cong \mathcal{A}_1 \otimes \mathcal{A}_2,$$

*where the right-hand-side is the usual tensor product of dg algebras.*

- (A3) *If  $\mathcal{A}_1$  is quasi-isomorphic to  $\mathcal{A}'_1$  and  $\mathcal{A}_2$  is quasi-isomorphic to  $\mathcal{A}'_2$ , then  $\mathcal{A}_1 \otimes_\Gamma \mathcal{A}_2$  is quasi-isomorphic to  $\mathcal{A}'_1 \otimes_\Gamma \mathcal{A}'_2$ .*
- (A4) *The tensor product is associative up to isomorphism: if  $\mathcal{A}_1$ ,  $\mathcal{A}_2$ , and  $\mathcal{A}_3$  are  $A_\infty$ -algebras, there is an isomorphism of  $A_\infty$ -algebras*

$$\mathcal{A}_1 \otimes_\Gamma (\mathcal{A}_2 \otimes_\Gamma \mathcal{A}_3) \cong (\mathcal{A}_1 \otimes_\Gamma \mathcal{A}_2) \otimes_\Gamma \mathcal{A}_3.$$

- (A5) *If  $\Gamma$  and  $\Gamma'$  are both associahedron diagonals, then there is an isomorphism of  $A_\infty$ -algebras*

$$\mathcal{A}_1 \otimes_\Gamma \mathcal{A}_2 \cong \mathcal{A}_1 \otimes_{\Gamma'} \mathcal{A}_2.$$

Since any  $A_\infty$ -algebra is quasi-isomorphic to a dg algebra, the following corollary characterizes  $\mathcal{A}_1 \otimes_\Gamma \mathcal{A}_2$  up to quasi-isomorphism:

**Corollary 1.2.** *Let  $\mathcal{A}_1$  and  $\mathcal{A}_2$  be  $A_\infty$ -algebras and  $\mathcal{B}_1$  and  $\mathcal{B}_2$  dg algebras so that  $\mathcal{B}_i$  is quasi-isomorphic to  $\mathcal{A}_i$ . Then for any associahedron diagonal  $\Gamma$ ,  $\mathcal{A}_1 \otimes_\Gamma \mathcal{A}_2$  is quasi-isomorphic to  $\mathcal{B}_1 \otimes \mathcal{B}_2$ .*

*Remark 1.3.* Corollary 1.2 follows from Properties (A2) and (A3) of Theorem 1.1. Since any  $A_\infty$ -algebra is quasi-isomorphic to a dg algebra, we can view Properties (A4) and (A5) as easy consequences of Corollary 1.2. We have chosen instead the formulation from Theorem 1.1, as it generalizes more readily to the weighted context; see Remark 1.13.

Going beyond tensor products of  $A_\infty$ -algebras, we consider next the case of  $A_\infty$ -modules. Fix an associahedron diagonal  $\Gamma$ . A (right) *module diagonal*  $\mathbf{M}$  compatible with  $\Gamma$  is a collection of chain maps

$$\mathbf{M} = \{\mathbf{M}_n : C_*^{cell}(K_n) \rightarrow C_*^{cell}(K_n \times K_n)\}_{n=2}^\infty$$

that satisfy a compatibility condition with respect to  $\Gamma$  and a non-degeneracy condition (Definition 2.22).

Given  $A_\infty$ -algebras  $\mathcal{A}_1$  and  $\mathcal{A}_2$  and (right)  $A_\infty$ -modules  $\mathcal{M}_1$  and  $\mathcal{M}_2$  over  $\mathcal{A}_1$  and  $\mathcal{A}_2$ , we use  $\mathbf{M}$  to define a tensor product  $\mathcal{M}_1 \otimes_{\mathbf{M}} \mathcal{M}_2$  of  $\mathcal{M}_1$  and  $\mathcal{M}_2$  over  $R$  (Definition 3.21).

**Theorem 1.4.** *For any associahedron diagonal  $\Gamma$ , there is a compatible module diagonal  $\mathbf{M}$  which, given  $A_\infty$ -modules  $\mathcal{M}_1$  and  $\mathcal{M}_2$  over  $\mathcal{A}_1$  and  $\mathcal{A}_2$  respectively, can be used to define their tensor product  $\mathcal{M}_1 \otimes_{\mathbf{M}} \mathcal{M}_2$ . The tensor product  $\mathcal{M}_1 \otimes_{\mathbf{M}} \mathcal{M}_2$  is an  $A_\infty$ -module over  $\mathcal{A}_1 \otimes_{\Gamma} \mathcal{A}_2$ , and this construction has the following properties:*

(M1) *If  $\mathcal{M}_1$  and  $\mathcal{M}_2$  are differential graded modules over dg algebras  $\mathcal{A}_1$  and  $\mathcal{A}_2$ , then*

$$\mathcal{M}_1 \otimes_{\mathbf{M}} \mathcal{M}_2 \cong \mathcal{M}_1 \otimes \mathcal{M}_2,$$

*where the right-hand-side is the usual (external) tensor product of dg modules.*

(M2) *If  $\mathcal{M}_1$  is  $A_\infty$ -homotopy equivalent to  $\mathcal{N}_1$  and  $\mathcal{M}_2$  is  $A_\infty$ -homotopy equivalent to  $\mathcal{N}_2$ , then  $\mathcal{M}_1 \otimes_{\mathbf{M}} \mathcal{M}_2$  is  $A_\infty$ -homotopy equivalent to  $\mathcal{N}_1 \otimes_{\mathbf{M}} \mathcal{N}_2$ .*

(M3) *If  $\mathbf{M}$  and  $\mathbf{M}'$  are both module diagonals compatible with  $\Gamma$ , then  $\mathcal{M}_1 \otimes_{\mathbf{M}} \mathcal{M}_2$  is isomorphic to  $\mathcal{M}_1 \otimes_{\mathbf{M}'} \mathcal{M}_2$  as modules over  $\mathcal{A}_1 \otimes_{\Gamma} \mathcal{A}_2$ .*

The proofs of parts (A3) and (A5) of Theorem 1.1 involve another sort of diagonal, a *multiplihedron diagonal* (Definition 2.44), which more generally allows one to tensor  $A_\infty$ -algebra homomorphisms together; see Lemma 3.14. Similarly, the proofs of parts (M2) and (M3) of Theorem 1.4 involve module-map diagonals (Definition 2.48), which more generally allow one to tensor morphisms of modules together; see Lemma 3.28, Proposition 3.29, and Corollary 3.32.

Our interest in diagonals stems from the fact that they can be used to define a bimodule analogue of special types of modules, which we called type  $D$  structures [LOT18]. Type  $D$  structures are essentially the same as twisted complexes over  $\mathcal{A}$  (see [BK90, Kon95]) or comodules over the bar complex  $\text{Bar}(\mathcal{A})$  (compare [LH03, Kelb]); see also [LOT15, Remarks 2.2.36 and 2.2.37].

In more detail, let  $\mathbb{k}$  be a commutative  $R$ -algebra, possibly graded, but free (or projective) as an  $R$ -module. (For example,  $\mathbb{k}$  might be a finite direct sum of copies of  $R$  or  $R[Y]$ . See also Convention 3.1.) Fix an  $A_\infty$ -algebra  $\mathcal{A} = (A, \{\mu_n\})$  over  $\mathbb{k}$ , and let

$$\mathcal{T}^* A = \bigoplus_{n=0}^{\infty} A^{\otimes_{\mathbb{k}} n} \quad \text{and} \quad \overline{\mathcal{T}}^* A = \prod_{n=0}^{\infty} A^{\otimes_{\mathbb{k}} n}.$$

Let  $P$  be a projective, graded  $\mathbb{k}$ -module, equipped with a map  $\delta_P^1: P \rightarrow A \otimes_{\mathbb{k}} P \langle\langle 1 \rangle\rangle$ , where  $\langle\langle 1 \rangle\rangle$  denotes a grading shift (Convention 3.2). The map  $\delta_P^1$  can be iterated to construct a map  $\delta: P \rightarrow \overline{\mathcal{T}}^* A \otimes P$ , and the  $A_\infty$  operations on  $\mathcal{A}$  fit together to give a map  $\mu: \mathcal{T}^* A \rightarrow A$ . We say that the pair  $(P, \delta_P^1: P \rightarrow A \otimes P \langle\langle 1 \rangle\rangle)$  is a *type  $D$  structure* if the following compatibility condition holds:

$$(1.5) \quad (\mu \otimes \mathbb{I}_P) \circ \delta = 0.$$

This formula makes sense if either large enough iterates of  $\delta_P^1$  vanish or the  $\mu_i$  on  $\mathcal{A}$  vanish for  $i$  sufficiently large. There is a tensor product pairing right  $A_\infty$ -modules  $\mathcal{M}_{\mathcal{A}}$  with left type  $D$  structures, written  $\mathcal{M}_{\mathcal{A}} \boxtimes^{\mathcal{A}} P$ . (See [LOT18] or Section 3.5 below.)

Given a diagonal, there is a bimodule analogue of type  $D$  structures:

**Definition 1.6.** *Fix  $A_\infty$ -algebras  $\mathcal{A}$  and  $\mathcal{B}$ . A (left-left) type  $DD$  structure over  $\mathcal{A}$  and  $\mathcal{B}$  is a type  $D$  structure over  $\mathcal{A} \otimes_{\Gamma} \mathcal{B}$ .*

(We adopt the convention from our earlier papers [LOT15] that an algebra as a subscript, as in  $\mathcal{M}_{\mathcal{A}}$ , denotes an  $A_\infty$ -module, while an algebra as a superscript, as in  ${}^{\mathcal{A}}P$ , denotes a type  $D$  structure. An  $A_\infty$ -algebra  $\mathcal{A}$  has an *opposite algebra*  $\mathcal{A}^{\text{op}}$ , and a right  $A_\infty$ -module  $\mathcal{M}_{\mathcal{A}}$  over  $\mathcal{A}$  is the same as a left  $A_\infty$ -module  ${}_{\mathcal{A}^{\text{op}}} \mathcal{M}$  over  $\mathcal{A}^{\text{op}}$ ; and similarly for type  $D$  structures. In particular, a

left-right type  $DD$  structure  ${}^{\mathcal{A}}P^{\mathcal{B}}$  over  $\mathcal{A}$  and  $\mathcal{B}$  is the same as a left-left type  $DD$  structure  ${}^{\mathcal{A},\mathcal{B}^{\text{op}}}P$  over  $\mathcal{A}$  and  $\mathcal{B}^{\text{op}}$ .)

Fix an associahedron diagonal  $\Gamma$  and corresponding module diagonal  $\mathbf{M}$ . If  ${}^{\mathcal{A},\mathcal{B}}P$  is a type  $DD$  structure with respect to  $\Gamma$  and  $\mathcal{M}_{\mathcal{A}}, \mathcal{N}_{\mathcal{B}}$  are  $A_{\infty}$ -modules over  $\mathcal{A}$  and  $\mathcal{B}$ , we can define the triple tensor product  $[\mathcal{M}_{\mathcal{A}} \boxtimes {}^{\mathcal{A}}P^{\mathcal{B}^{\text{op}}} \boxtimes_{\mathcal{B}^{\text{op}}} \mathcal{N}]_{\mathbf{M}}$  to be the tensor product of the  $(\mathcal{A} \otimes_{\Gamma} \mathcal{B})$ -module  $\mathcal{M}_{\mathcal{A}} \otimes_{\mathbf{M}} \mathcal{N}_{\mathcal{B}}$  with the  $\mathcal{A} \otimes_{\Gamma} \mathcal{B}$  type  $D$  structure  ${}^{\mathcal{A},\mathcal{B}}P$ .

**Theorem 1.7.** *Assuming that either  $P$  is bounded or  $\mathcal{M}, \mathcal{N}, \mathcal{A}$  and  $\mathcal{B}$  are all bonsai (as defined in Section 3), the triple tensor product is a well-defined chain complex. Moreover, different choices of  $\mathbf{M}$  give rise to homotopy equivalent triple tensor products.*

Fix an associahedron diagonal. We will define the notion of a compatible *module diagonal primitive*,  $\mathbf{p}$  (Definition 2.29). The key results are the following:

**Proposition 1.8.** *Given an associahedron diagonal  $\Gamma$ , there is a module diagonal primitive  $\mathbf{p}$  compatible with  $\Gamma$ .*

**Lemma 1.9.** *Given an associahedron diagonal  $\Gamma$ , a module diagonal primitive  $\mathbf{p}$  compatible with  $\Gamma$  gives rise to an associated module diagonal  $\mathbf{M} = \mathbf{M}_{\mathbf{p}}$ .*

The utility of this construction is the following:

**Theorem 1.10.** *Under appropriate boundedness hypotheses, a module diagonal primitive gives a way to form a type  $D$  structure  ${}^{\mathcal{A}}P^{\mathcal{B}^{\text{op}}} \boxtimes_{\mathcal{B}^{\text{op}}} \mathcal{N}$  over  $\mathcal{A}$ . If  $\mathcal{M}_{\mathcal{A}}$  is an  $A_{\infty}$ -module over  $\mathcal{A}$ , then there is an isomorphism*

$$\mathcal{M}_{\mathcal{A}} \boxtimes ({}^{\mathcal{A}}P^{\mathcal{B}^{\text{op}}} \boxtimes_{\mathcal{B}^{\text{op}}} \mathcal{N}) \cong [\mathcal{M}_{\mathcal{A}} \boxtimes {}^{\mathcal{A}}P^{\mathcal{B}^{\text{op}}} \boxtimes_{\mathcal{B}^{\text{op}}} \mathcal{N}]_{\mathbf{M}_{\mathbf{p}}},$$

where here the right-hand-side denotes the triple tensor product of Theorem 1.7.

The operation  $\boxtimes^{\mathbf{p}}$  is functorial in an appropriate sense; see Proposition 3.58 and Lemma 3.62.

**1.3. Statement of results in the weighted case.** We start with some definitions. Let  $R$  and  $\mathbb{k}$  be as above.

**Definition 1.11.** *A weighted  $A_{\infty}$ -algebra or  $w$ -algebra over  $\mathbb{k}$  is a curved  $A_{\infty}$ -algebra  $\mathcal{A} = (A[[t]], \mu_n)$  over  $\mathbb{k}[[t]]$ , free over  $R[[t]]$ , with  $t$  central, and so that the curvature  $\mu_0$  lies in  $tA[[t]]$ . In particular,  $A = A[[t]]/tA[[t]]$  inherits the structure of an uncurved  $A_{\infty}$ -algebra, called the undeformed  $A_{\infty}$ -algebra of  $\mathcal{A}$ .*

*A homomorphism  $f: \mathcal{A} \rightarrow \mathcal{B}$  of weighted  $A_{\infty}$ -algebras is a homomorphism of curved  $A_{\infty}$ -algebras so that  $f_0 \in tB[[t]]$ . A homomorphism  $f$  is a quasi-isomorphism if the induced map of undeformed  $A_{\infty}$ -algebras is a quasi-isomorphism.*

*A weighted  $A_{\infty}$ -module or  $w$ -module  $\mathcal{M}$  over  $\mathcal{A}$  is a curved  $A_{\infty}$ -module  $\mathcal{M} = (M[[t]], m_n)$  over  $\mathbb{k}[[t]]$ , free over  $R[[t]]$ , so that the curvature  $m_0$  lies in  $tM[[t]]$ .*

See Definitions 4.1, 4.18, and 4.34 for equivalent, more explicit definitions. The variable  $t$  is allowed to have an arbitrary grading, and different gradings of  $t$  lead to different notions. (Again, see Section 4 for further discussion.) For the complex of morphisms between weighted  $A_{\infty}$ -modules, see Section 4.5.

An ordinary  $A_{\infty}$ -algebra  $\mathcal{A}$  can be viewed as a weighted  $A_{\infty}$ -algebra by extension of scalars. We call such algebras *weighted trivially*. (Equivalently, in the notation of Definition 4.1, an algebra is weighted trivially if the maps  $\mu_n^w$  vanish when  $w > 0$ .)

The analogue of the cellular chain complex of the associahedron in the weighted case is the *weighted trees complex*  $X_{*}^{*,*}$ , defined in Section 4.1, and a slight extension of it, the *extended weighted trees complex*  $\tilde{X}_{*}^{*,*}$  (Section 6.2). The weighted trees complex is the cellular chain complex of the *weighted associaplex*, a cell complex introduced in Section 8. Unlike the associahedron,



the associaplex is not a polyhedron; but like the associahedron, it is contractible (Theorems 5.2 and 8.32).

A *weighted algebra diagonal* is a map

$$\Gamma^{n,w}: X_*^{n,w} \rightarrow \bigoplus_{w_1, w_2 \leq w} Y_1^{w-w_1} Y_2^{w-w_2} \widetilde{X}_*^{n,w_1} \otimes \widetilde{X}_*^{n,w_2} \otimes R[Y_1, Y_2]$$

satisfying certain compatibility and non-degeneracy conditions (Definition 6.4). Unlike the unweighted case, not all weighted algebra diagonals are equivalent: rather, the homotopy class is determined by the *seed*  $\Gamma^{0,1}$ .

A weighted algebra  $\mathcal{A}$  is *strictly unital* if there is an element  $\mathbf{1} \in A$  so that for each  $a \in A$ ,  $\mu_2(\mathbf{1}, a) = \mu_2(a, \mathbf{1}) = a$  and for any  $n \neq 2$  and  $a_1, \dots, a_{n-1} \in A$ ,  $\mu_n(a_1, \dots, a_{i-1}, \mathbf{1}, a_i, \dots, a_{n-1}) = 0$ . Strict unitality for weighted modules over strictly unital algebras and homomorphisms of strictly unital algebras is defined similarly; see Section 4.3. Unlike in the unweighted case, we define tensor products only of strictly unital weighted algebras and modules (or, more generally, homotopy unital ones, in Section 7.4).

We can now state the weighted analogue of Theorem 1.1:

**Theorem 1.12.** *There is a weighted algebra diagonal  $\Gamma^{*,*}$  with any given seed. Further, given a weighted algebra diagonal  $\Gamma^{*,*}$ , there is an associated tensor product of strictly unital weighted algebras  $\mathcal{A}_1$  and  $\mathcal{A}_2$  over  $R$ ,  $\mathcal{A}_1 \otimes_{\Gamma} \mathcal{A}_2$ , satisfying the following properties:*

- (wA1) *If  $\mathcal{A}_1$  and  $\mathcal{A}_2$  are weighted trivially then  $\mathcal{A}_1 \otimes_{\Gamma} \mathcal{A}_2$  coincides with the tensor product of undeformed  $A_{\infty}$ -algebras (with respect to a diagonal obtained by restricting  $\Gamma^{*,*}$ ).*
- (wA2) *If  $\mathcal{A}_1$  is quasi-isomorphic to  $\mathcal{B}_1$  and  $\mathcal{A}_2$  is quasi-isomorphic to  $\mathcal{B}_2$ , then  $\mathcal{A}_1 \otimes_{\Gamma} \mathcal{A}_2$  is quasi-isomorphic to  $\mathcal{B}_1 \otimes_{\Gamma} \mathcal{B}_2$ .*
- (wA3) *If  $\Gamma_1^{*,*}$  and  $\Gamma_2^{*,*}$  are weighted algebra diagonals with the same seed, then  $\mathcal{A}_1 \otimes_{\Gamma_1} \mathcal{A}_2$  is isomorphic to  $\mathcal{A}_1 \otimes_{\Gamma_2} \mathcal{A}_2$ .*

The tensor product of strictly unital weighted algebras is not itself strictly unital, but only weakly unital (Definition 4.23). Any weakly unital weighted algebra is isomorphic to a strictly unital one (Theorem 4.25), but this extra isomorphism makes associativity of the tensor product in the weighted case more subtle than the unweighted case; see Section 7.4.

*Remark 1.13.* While every  $A_{\infty}$ -algebra over a field is quasi-isomorphic to a *dg* algebra, we are not aware of a completely analogous result for weighted  $A_{\infty}$ -algebras (but see [Amo16, Corollary 3.4]). So, while one can define the tensor product of two  $A_{\infty}$ -algebras by resolving and then taking the ordinary tensor product, we do not know a weighted analogue of this operation.

For a particular seed, Amorim has constructed a tensor product as in Theorem 1.12 by other methods [Amo16]; see also Remark 7.8.

Turning to modules, the weighted analogue of Theorem 1.4 is:

**Theorem 1.14.** *For any weighted algebra diagonal  $\Gamma^{*,*}$ , there is a corresponding weighted module diagonal  $\mathbf{M}^{*,*}$  which, given strictly unital weighted  $A_{\infty}$ -modules  $\mathcal{M}_1$  and  $\mathcal{M}_2$  over  $\mathcal{A}_1$  and  $\mathcal{A}_2$  respectively, can be used to define their tensor product  $\mathcal{M}_1 \otimes_{\mathbf{M}} \mathcal{M}_2$ , a weighted  $A_{\infty}$ -module over  $\mathcal{A}_1 \otimes_{\Gamma} \mathcal{A}_2$ . This tensor product has the following properties:*

- (M1) *If  $\mathcal{M}_1$  and  $\mathcal{M}_2$  are trivially weighted  $A_{\infty}$ -modules over trivially weighted  $A_{\infty}$ -algebras then their tensor product is the same as in Theorem 1.4.*
- (M2) *If  $\mathcal{M}_1$  is homotopy equivalent to  $\mathcal{N}_1$  and  $\mathcal{M}_2$  is homotopy equivalent to  $\mathcal{N}_2$ , then  $\mathcal{M}_1 \otimes_{\mathbf{M}} \mathcal{M}_2$  is homotopy equivalent to  $\mathcal{N}_1 \otimes_{\mathbf{M}} \mathcal{N}_2$ .*
- (M3) *If  $\mathbf{M}_1^{*,*}$  and  $\mathbf{M}_2^{*,*}$  are weighted module diagonals compatible with  $\Gamma^{*,*}$ , then  $\mathcal{M}_1 \otimes_{\mathbf{M}_1} \mathcal{M}_2$  is homotopy equivalent to  $\mathcal{M}_1 \otimes_{\mathbf{M}_2} \mathcal{M}_2$  as weighted  $A_{\infty}$ -modules over  $\mathcal{A}_1 \otimes_{\Gamma} \mathcal{A}_2$ .*

Again, the tensor product does not preserve strict unitality, though any weighted  $A_{\infty}$ -module is isomorphic to a strictly unital one (Theorem 4.50).



Similarly to the unweighted case, functoriality in Theorem 1.12 uses weighted map diagonals (Definition 6.14), the existence of which is guaranteed by Lemma 6.18. See Definition 7.6 for the definition of the tensor product of two weighted algebra homomorphisms. Similarly, functoriality in Theorem 1.14 uses weighted module-map diagonals (Definition 6.39), existence and uniqueness (up to homotopy) of which is Lemma 6.41. Functoriality properties of the tensor product of weighted modules are spelled out in Proposition 7.13 and Lemma 7.16.

We turn next to weighted type  $D$  and  $DD$  structures and their box tensor products. With  $R$  and  $\mathbb{k}$  as above, let  $\mathcal{A} = (A[[t]], \mu)$  be a weighted  $A_\infty$ -algebra over  $\mathbb{k}$  and  $X$  an element of  $\mathbb{k}$  which acts centrally on  $A$ , in the sense that  $aX = Xa$  for all  $a \in A$ . Write  $\mu_n = \sum \mu_n^w t^w$ . A *weighted type  $D$  structure with charge  $X$*  over  $\mathcal{A}$  is a projective  $\mathbb{k}$ -module  $P$  and a map  $\delta^1: P \rightarrow A \otimes P$  satisfying

$$(1.15) \quad \sum_{w=0}^{\infty} \sum_{n=0}^{\infty} X^w (\mu_n^w \otimes \mathbb{I}) \circ \delta^n = 0 \in A \otimes P.$$

Here,  $\delta^n: P \rightarrow A^{\otimes n} \otimes P$  is the result of iterating  $\delta^1$   $n$  times. This structure equation makes sense under suitable boundedness hypotheses on  $\mathcal{A}$  and/or  $P$ ; see Section 4.7. There is a box tensor product of a weighted type  $D$  structure and a weighted  $A_\infty$ -module,  $\mathcal{M} \boxtimes P$ , defined similarly to the unweighted case; see Equation (4.66) (Section 4.7). (One could also consider charges  $X \in \mathbb{k}[[t]]$ . Then, for charge  $X = t$ , Equation (1.15) is the usual type  $D$  structure relation over  $\mathcal{A}$  considered as a curved  $A_\infty$ -algebra.)

Parallel to the unweighted case, given weighted algebras  $\mathcal{A}$  and  $\mathcal{B}$  and a weighted algebra diagonal  $\Gamma^{*,*}$ , a weighted type  $DD$  structure over  $\mathcal{A}$  and  $\mathcal{B}$  with respect to  $\Gamma^{*,*}$  is a type  $D$  structure over  $\mathcal{A} \otimes_{\Gamma} \mathcal{B}$ . Given weighted modules  $\mathcal{M}$  and  $\mathcal{N}$  over  $\mathcal{A}$  and  $\mathcal{B}$ , under suitable boundedness hypotheses there is a corresponding triple tensor product (Definition 7.22)

$$[\mathcal{M}_{\mathcal{A}} \boxtimes^{\mathcal{A}} P^{\mathcal{B}^{\text{op}}} \boxtimes_{\mathcal{B}^{\text{op}}} \mathcal{N}]_{\mathbf{M}} := (\mathcal{M} \otimes_{\mathbf{M}} \mathcal{N})_{\mathcal{A} \otimes_{\Gamma} \mathcal{B}} \boxtimes^{\mathcal{A} \otimes_{\Gamma} \mathcal{B}} P.$$

**Theorem 1.16.** *Assume that either  ${}^{\mathcal{A}}P^{\mathcal{B}^{\text{op}}}$  is operationally bounded or  $\mathcal{A}$ ,  $\mathcal{B}$ ,  $\mathcal{M}$ , and  $\mathcal{N}$  are bonsai. Then the triple tensor product is a well-defined chain complex. Moreover, different choices of weighted module diagonal  $\mathbf{M}$  give rise to homotopy equivalent triple tensor products.*

Again, for one-sided box tensor products of type  $DD$  structures we use a *weighted module diagonal primitive*  $\mathbf{p}^{*,*}$  (Definition 6.29). Some key results are:

- Given any weighted algebra diagonal, there is a compatible weighted module diagonal primitive (Proposition 6.34).
- A weighted module diagonal primitive gives rise to a weighted module diagonal (Lemma 6.38).
- Weighted module diagonal primitives give a way of defining a one-sided box tensor product  $\mathcal{M} \boxtimes^{\mathbf{p}^{*,*}} P$  (Definition 7.23).
- The triple box tensor product agrees, up to homotopy, with taking the one-sided box tensor product twice (Proposition 7.24).

Functoriality of the one-sided box tensor product uses module-map diagonal primitives (Definition 6.42), and is spelled out in Section 7.3.4, particularly Proposition 7.28 and Lemma 7.29.

**1.4. Additional topics.** To prove associativity of the tensor product of weighted algebras and to prove that the category of type  $DD$  structures is independent of the choice of diagonal, we need to relax the unitality assumption, and work with homotopy unital weighted algebras. We generally give these generalizations at the end of each section.

As mentioned above, many of the algebraic constructions in this paper require some boundedness properties to make sense. In most of the paper, we work with boundedness properties which are easy to state and make sense quite generally, but are not, in fact, sufficiently general for the application to bordered Heegaard Floer homology. We relax these conditions, over particular ground rings, in Section 9, to conditions that are satisfied in bordered Floer theory.

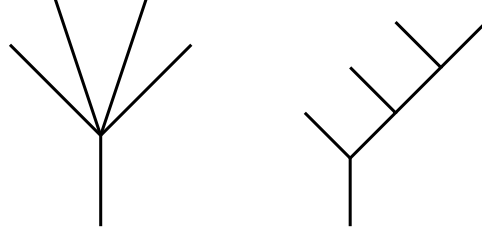

FIGURE 1. **Some trees.** At the left is the corolla  $\Psi_4$  with four inputs, which corresponds to the parenthesization  $(1, 2, 3, 4)$ . To its right is the right-associated binary tree with four inputs, which corresponds to the parenthesization  $(1, (2, (3, 4)))$ .

For the reader's convenience, Appendix A collects the first few terms in various kinds of diagonals, and Appendix B has a table of the various objects (Table 1) introduced in this paper and a table of conventions (Table 2).

**Acknowledgments.** We thank the referee for helpful comments.

## 2. DIAGONALS: DEFINITIONS, EXISTENCE

**Convention 2.1.** *Let  $R$  be a commutative ring (possibly graded). In this section, undecorated tensor products are over  $R$ .*

### 2.1. Trees and the associahedron.

**Convention 2.2.** *In this paper, all trees will be planar trees, with a distinguished root leaf, which we call the output (so our planar trees are rooted); we call the other leaves the inputs. (This will change in Section 4, where some leaves are neither inputs nor the output.) Non-leaf vertices are internal vertices.*

*We admit as a degenerate tree  $\downarrow$  a single edge with one input, one output, and no internal vertices, which we sometimes call the identity tree.*

*We draw our trees so that the inputs come in the top and the root exits through the bottom, and each edge points downward. Consequently, each internal vertex has a leftmost and a rightmost parent.*

Each vertex  $v$  of a tree  $T$  has a *valence*  $d(v)$ , the number of edges incident to the vertex. A tree is called *binary* if each internal vertex has two parents (a left parent and a right parent), or equivalently if each internal vertex has valence 3.

We denote the free  $R$ -module spanned by trees with  $n$  inputs and no 2-valent vertices by  $\mathcal{T}_n$ . Let  $\mathcal{T}$  be the graded  $R$ -module  $\bigoplus_{n=1}^{\infty} \mathcal{T}_n$ .

Note that the special case  $\mathcal{T}_1$  is 1-dimensional, spanned by the tree  $\downarrow$  with one input, one output, and no internal vertices. (The module  $\mathcal{T}_2$  is also 1-dimensional.)

**Definition 2.3.** *A rooted, planar tree with a single internal vertex is called a corolla. Let  $\Psi_n$  denote the corolla with  $n$  inputs (i.e.,  $n + 1$  leaves); see Figure 1.*

Given trees  $S$  and  $T$ , let  $T \circ_i S$  be the result of gluing the output leaf of  $S$  to the  $i^{\text{th}}$  input leaf of  $T$ . (Note that  $\circ_i$  is not associative, because of how the indexing behaves.) Extend  $\circ_i$  bilinearly to a map  $\mathcal{T}_n \otimes \mathcal{T}_m \rightarrow \mathcal{T}_{m+n-1}$ . Given  $S \in \mathcal{T}_m$ ,  $T \in \mathcal{T}_n$  let  $T \circ S = \sum_{i=1}^n T \circ_i S$ . It will also sometimes be convenient to use a multi-linear composition map  $\mathcal{T}_k \otimes \mathcal{T}_{m_1} \otimes \cdots \otimes \mathcal{T}_{m_k} \rightarrow \mathcal{T}_{m_1+\cdots+m_k}$ ,

$$(2.4) \quad (T, S_1, \dots, S_k) \mapsto T \circ (S_1, \dots, S_k),$$

obtained by gluing the output of  $S_i$  to the  $i^{\text{th}}$  input of  $T$ . That is,

$$T \circ (S_1, \dots, S_k) = (((T \circ_k S_k) \circ_{k-1} S_{k-1}) \circ_{k-2} \dots) \circ_1 S_1.$$

We will often be interested in pairs of trees with  $n$  inputs (or elements of  $\mathcal{T}_n \otimes \mathcal{T}_n$ ). Define  $(T_1, T_2) \circ_i (S_1, S_2) = (T_1 \circ_i S_1, T_2 \circ_i S_2)$  and

$$(2.5) \quad (T_1, T_2) \circ (S_1, S_2) = \sum_i (T_1, T_2) \circ_i (S_1, S_2) = \sum_i (T_1 \circ_i S_1, T_2 \circ_i S_2).$$

We also use a multi-composition for pairs of trees, analogous to Formula (2.4). Specifically, given a pair of trees  $(T, T')$  with  $k$  inputs and pairs of trees  $(S_1, S'_1), \dots, (S_k, S'_k)$ , let

$$(2.6) \quad (T, T') \circ ((S_1, S'_1), \dots, (S_k, S'_k)) = (T \circ (S_1, \dots, S_k), T' \circ (S'_1, \dots, S'_k)).$$

The similarity in notation between Formulas (2.5) and (2.6) should not cause confusion: the only overlap is when  $(T, T')$  are trees with a single input, in which case the two notations agree.

The *associahedron*  $K_n$ , introduced by Stasheff [Sta63], is a CW complex which is a natural compactification of the configuration space of  $n \geq 2$  distinct points in  $\mathbb{R}$  modulo translation and scaling [FO97, Dev99]. The cells in the associahedron are in a natural one-to-one correspondence with trees with  $n$  inputs and no 2-valent vertices. (We will sometimes call such trees *associahedron trees*.) In turn, cells correspond to parenthesizations of the inputs; see Figure 1. In particular, for each  $n \geq 2$ , the cellular chain complex  $C_*^{\text{cell}}(K_n; R)$  is identified with  $\mathcal{T}_n$ .

**Convention 2.7.** By  $C_*^{\text{cell}}(\cdot) = C_*^{\text{cell}}(\cdot; R)$  we mean the cellular chain complex with  $R$ -coefficients.

**Definition 2.8.** The dimension of a tree  $T \in \mathcal{T}_n$  with  $k$  internal vertices is the dimension of the corresponding cell in  $K_n$ ; namely,  $\dim(T) = n - k - 1$ .

*Remark 2.9.* We use the word *dimension* to refer to the grading on  $\mathcal{T}_n$ ,  $C_*^{\text{cell}}(K_n)$ , and so on, to distinguish it from another grading which appears in Section 7.

The differential in the cellular chain complex  $C_*^{\text{cell}}(X_n)$  of (the cell corresponding to) such a tree  $T$  is the sum over all the ways of inserting an edge into  $T$ , so as to preserve the property that no vertex has valence two. For example, if we write a tree as a bracketing of its inputs then

$$\partial(1, 2, 3, 4) = ((1, 2, 3), 4) + (1, (2, 3, 4)) + ((1, 2), 3, 4) + (1, (2, 3), 4) + (1, 2, (3, 4)).$$

The following fundamental result guides many of the results in this paper:

**Proposition 2.10.** [Sta63] The complex  $C_*^{\text{cell}}(K_n)$  is contractible; i.e.,

$$H_i(C_*^{\text{cell}}(K_n)) = \begin{cases} R & \text{if } i = 0 \\ 0 & \text{otherwise.} \end{cases}$$

(The proposition also follows from the fact that  $K_n$  can be realized as a convex polytope; see [CSZ15] for a discussion of various realizations of the associahedron and further citations.)

Given any  $1 \leq i < j \leq n$ , there is a codimension-1 face  $F_{i,j}^n$  such that

$$(2.11) \quad K_{j-i+1} \times K_{n+i-j} \cong F_{i,j}^n \subset K_n,$$

and these are all the codimension-1 faces. These face maps induce chain maps

$$(2.12) \quad \phi_{i,j}^n: C_*^{\text{cell}}(K_{j-i+1}) \otimes C_*^{\text{cell}}(K_{n+i-j}) \rightarrow C_*^{\text{cell}}(K_n),$$

which can be interpreted as compositions of trees:

$$\phi_{i,j}^n(S, T) = T \circ_i S.$$

See Figure 2.

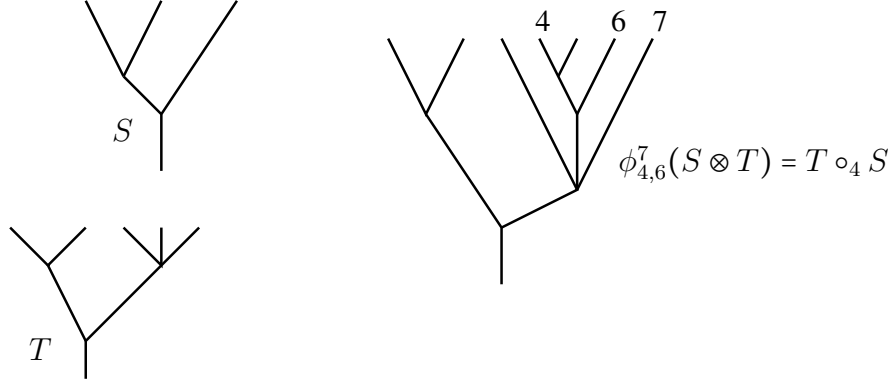

FIGURE 2. **Examples of compositions of trees.** An illustration of the stacking of trees  $S$  and  $T$ ,  $\phi_{4,6}^7(S \otimes T)$ .

**2.2. Algebra diagonals.** For any space  $X$ , the diagonal map  $X \rightarrow X \times X$  induces a chain map on the singular chain complexes

$$\Gamma_{\text{sing}}^X : C_*^{\text{sing}}(X) \rightarrow C_*^{\text{sing}}(X \times X).$$

Our first goal is to define an *associahedron diagonal*, which is a cellular approximation

$$\Gamma^n : C_*^{\text{cell}}(K_n) \rightarrow C_*^{\text{cell}}(K_n \times K_n)$$

to the diagonal and which is natural under the face maps, in a sense to be made precise presently.

**Definition 2.13.** An associahedron diagonal is a sequence of (degree-preserving) chain maps

$$\{\Gamma^n : C_*^{\text{cell}}(K_n) \rightarrow C_*^{\text{cell}}(K_n) \otimes C_*^{\text{cell}}(K_n)\}_{n=2}^{\infty}$$

satisfying the following conditions:

- **Compatibility under stacking:**

$$(2.14) \quad \Gamma^n \circ \phi_{i,j}^n = (\phi_{i,j}^n \otimes \phi_{i,j}^n) \circ (\Gamma^{j-i+1} \otimes \Gamma^{n+i-j}),$$

with the understanding that the composition on the right-hand side of Formula (2.14) involves a shuffling of tensor factors, i.e., it implicitly uses the identification

$$(2.15) \quad C_*^{\text{cell}}(K_{j-i+1}) \otimes C_*^{\text{cell}}(K_{n+i-j}) \otimes C_*^{\text{cell}}(K_{j-i+1}) \otimes C_*^{\text{cell}}(K_{n+i-j}) \\ \cong C_*^{\text{cell}}(K_{j-i+1}) \otimes C_*^{\text{cell}}(K_{j-i+1}) \otimes C_*^{\text{cell}}(K_{n+i-j}) \otimes C_*^{\text{cell}}(K_{n+i-j}).$$

- **Non-degeneracy:**  $\Gamma^2 : C_0^{\text{cell}}(K_2) \rightarrow C_0^{\text{cell}}(K_2) \otimes C_0^{\text{cell}}(K_2)$  is the standard isomorphism  $R \cong R \otimes_R R$ . (Note that  $K_2$  is a single point.)

The term *associahedron diagonal* is used to distinguish these maps from other diagonals (such as module diagonals and multiplihedron diagonals) defined below. An associahedron diagonal was constructed by Saneblidze and Umble [SU04] to define the tensor products of  $A_\infty$ -algebras; see also [MS06, Lod11].

An associahedron diagonal is encoded conveniently in the following:

**Definition 2.16.** An associahedron tree diagonal consists of  $(n-2)$ -chains  $\gamma_n \in C_*^{\text{cell}}(K_n) \otimes C_*^{\text{cell}}(K_n)$  for each  $n \geq 2$  satisfying:

- **Compatibility:**

$$(2.17) \quad \partial \gamma_n = \sum_{1 \leq i < j \leq n} (\phi_{i,j}^n \otimes \phi_{i,j}^n)(\gamma_{j-i+1} \otimes \gamma_{n+i-j}).$$

(Here, we have the same shuffling of factors as in Formula (2.14).)

- **Non-degeneracy:**  $\gamma_2 \in C_0(K_2) \otimes C_0(K_2)$  is the generator.

Equivalently, we can view an associahedron tree diagonal as elements  $\gamma_n \in \mathcal{T}_n \otimes \mathcal{T}_n$  of dimension  $n - 2$ , satisfying:

- **Compatibility:**

$$(2.18) \quad \partial\gamma_n = \sum_{i+j=n+1} \gamma_i \circ \gamma_j,$$

where  $\circ$  is the sum of all ways of composing, as in Equation (2.5).

- **Non-degeneracy:**  $\gamma_2 = \Psi_2 \otimes \Psi_2$ .

Schematically, the compatibility condition is:

$$\partial \left( \begin{array}{c} \Downarrow \\ \gamma \\ \Downarrow \end{array} \quad \begin{array}{c} \Downarrow \\ \gamma \\ \Downarrow \end{array} \right) = \begin{array}{c} \swarrow \quad \searrow \\ \gamma \\ \swarrow \quad \searrow \\ \gamma \\ \Downarrow \end{array} + \begin{array}{c} \swarrow \quad \searrow \\ \gamma \\ \swarrow \quad \searrow \\ \gamma \\ \Downarrow \end{array} .$$

The correspondence between associahedron diagonals and associahedron tree diagonals comes from the fact that associahedron diagonals are determined by their values on the corollas, which correspond to the top-dimensional cells of the associahedra.

**Lemma 2.19.** *There is a one-to-one correspondence between associahedron diagonals and associahedron tree diagonals, which associates to an associahedron diagonal  $\mathbf{\Gamma}$  the associahedron tree diagonal  $\mathbf{\Gamma}^n(\Psi_n)$ .*

*Proof.* First, we show that if  $\mathbf{\Gamma}^n$  is an associahedron diagonal, then the cells  $\gamma_n = \mathbf{\Gamma}^n(\Psi_n)$  form an associahedron tree diagonal, in the sense of Definition 2.16. Start from the identity from Equation (2.11)

$$\partial\Psi_n = \sum_{1 \leq i < j \leq n} \phi_{i,j}^n(\Psi_{j-i+1} \otimes \Psi_{n+i-j}).$$

Apply  $\mathbf{\Gamma}^n$  to both sides and use Equation (2.14) to conclude that Equation (2.17) holds.

Conversely, given an associahedron tree diagonal  $\gamma \in \mathcal{T}_n$  define  $\mathbf{\Gamma}^n: C_*^{cell}(K_n) \rightarrow C_*^{cell}(K_n) \otimes C_*^{cell}(K_n)$  as follows. Identifying  $C_*^{cell}(K_n)$  and  $\mathcal{T}_n$ , it suffices to define the value of  $\mathbf{\Gamma}^n$  on any tree  $T \in \mathcal{T}_n$ . We can write  $T$  as a composition of corollas,

$$T = \Psi_{n_k} \circ_{i_{k-1}} \Psi_{n_{k-1}} \circ_{i_{k-2}} \cdots \circ_{i_1} \Psi_{n_1}.$$

Define

$$\mathbf{\Gamma}(T) = \gamma_{n_k} \circ_{i_{k-1}} \gamma_{n_{k-1}} \circ_{i_{k-2}} \cdots \circ_{i_1} \gamma_{n_1}.$$

(See Figure 3.) It is clear that this definition is independent of the decomposition of  $T$  and, consequently, that  $\mathbf{\Gamma}$  satisfies Equation (2.14). The non-degeneracy conditions on  $\gamma$  and on  $\mathbf{\Gamma}$  also obviously correspond.

It remains to verify that the extension is a chain map. Given a tree  $T \in \mathcal{T}_n = C_*^{cell}(K_n)$ , the cellular boundary  $\partial(T)$  is the sum of all ways of inserting an edge at some internal vertex  $v$  in  $T$ . The terms in  $\mathbf{\Gamma}(\partial(T))$  coming from  $v$  correspond to breaking  $v$  into two vertices, with valences  $i, j > 2$ , and inserting  $\gamma_i$  and  $\gamma_j$  at these two vertices. This corresponds to the right-hand side of Formula (2.17). The terms in  $\partial(\mathbf{\Gamma}(T))$  coming from  $v$  correspond to inserting  $\partial\gamma_n$  (rather than  $\gamma_n$ ) at  $v$ . This corresponds to the left-hand side of Formula (2.17). The result follows.  $\square$

**Lemma 2.20.** *There is an associahedron diagonal.*

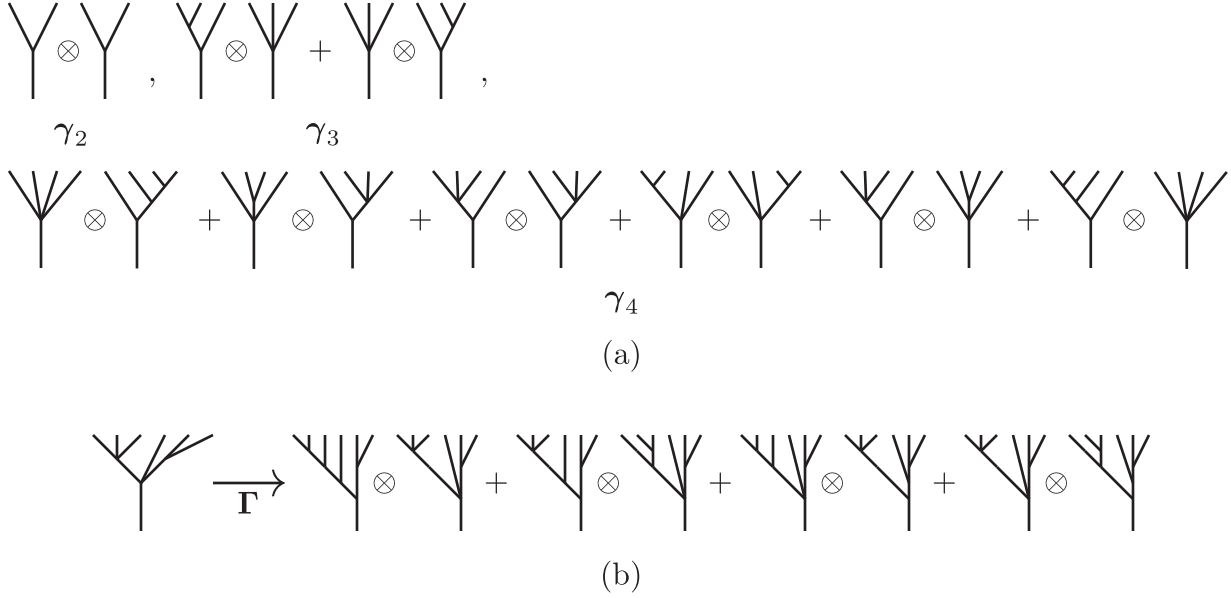

FIGURE 3. **From an associahedron tree diagonal to an associahedron diagonal.** (a) The first few terms in a particular associahedron tree diagonal. (b) Substituting these terms into a more complicated tree.

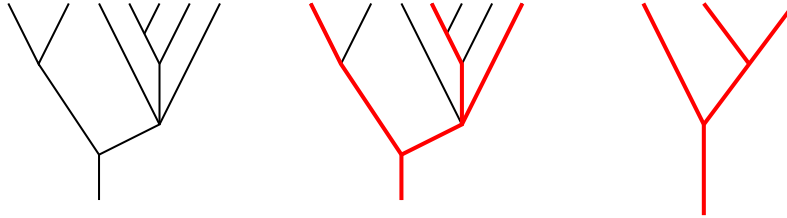

FIGURE 4. **A profile tree.** The tree on the left has  $n = 7$ . At the right we have drawn the profile tree corresponding to the triple of inputs 1, 4, and 7.

*Proof.* We describe the inductive procedure for constructing an associahedron tree diagonal. The base case  $n = 2$  is specified by the non-degeneracy condition, and a solution for  $n = 3$  is shown in Figure 3. For the inductive step, suppose we already have  $\gamma_n$  for  $n = 2, \dots, m$  satisfying Equation (2.17). To find  $\gamma_{m+1}$ ,  $m \geq 3$ , we observe that the right-hand-side of Equation (2.17) determines a cycle:

$$\partial \sum_{1 \leq i < j \leq m+1} (\phi_{i,j}^{m+1} \otimes \phi_{i,j}^{m+1})(\gamma_{j-i+1} \otimes \gamma_{m+1+i-j}) = 0.$$

This is a straightforward consequence of the facts that  $\phi_{i,j}^{m+1}$  are chain maps and the  $\gamma_n$  satisfy Equation (2.17) for  $n \leq m$ : the terms cancel in pairs. According to Stasheff,  $X$  is contractible [Sta63, Proposition 3]; in particular,  $H_*(X) = 0$  for  $* > 0$ . It follows that  $H_*(X \times X) = 0$  for  $* > 0$  as well. Since the right hand side of Equation (2.17) lies in dimension  $n - 3$  we can find some  $\gamma_{m+1}$  satisfying Equation (2.17) for  $n = m + 1 \geq 4$ , as needed.  $\square$

*Example 2.21.* Given a tree  $T$  with  $n$  inputs and a subset  $V \subset \{1, \dots, n\}$  of the inputs to  $T$ , the *profile tree* of  $T$  with profile  $V$ , denoted  $T(V)$ , is the result of deleting the inputs to  $T$  which are not in  $V$  and collapsing any resulting 2-valent vertices. See Figure 4.

Call a pair of three-input trees *right-moving* if it is one of the following five pairs:



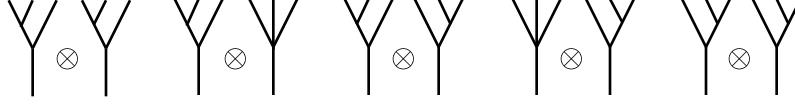

Call a pair  $(S, T)$  of  $n$ -input trees *right-moving* if for any triple  $v_1, v_2, v_3 \in \{1, \dots, n\}$ , the pair of three-input trees  $(S(v_1, v_2, v_3), T(v_1, v_2, v_3))$  is right-moving.

Masuda-Thomas-Tonks-Valette [MTTV19] have shown that the sum of all trees which are right-moving and in dimension  $n-2$  (where  $n$  is the number of inputs to each tree) forms an associahedron tree diagonal. This is the associahedron tree diagonal for which the first three terms are shown in Figure 3. (Their technique uses a geometric procedure which is applicable to more general convex polytopes.)

### 2.3. Module diagonals.

**Definition 2.22.** Fix an associahedron diagonal  $\Gamma$ . A right module diagonal compatible with  $\Gamma$  is a collection of chain maps  $\mathbf{M}^n: C_*^{\text{cell}}(K_n) \rightarrow C_*^{\text{cell}}(K_n) \otimes C_*^{\text{cell}}(K_n)$ ,  $n \geq 2$ , satisfying the following conditions:

- **Compatibility:**

$$(2.23) \quad \mathbf{M}^n \circ \phi_{i,j}^n = \begin{cases} (\phi_{1,j}^n \otimes \phi_{1,j}^n) \circ (\mathbf{M}^j \otimes \mathbf{M}^{n+1-j}) & \text{if } i = 1 \\ (\phi_{i,j}^n \otimes \phi_{i,j}^n) \circ (\Gamma^{j-i+1} \otimes \mathbf{M}^{n+i-j}) & \text{if } i > 1. \end{cases}$$

- **Non-degeneracy:**  $\mathbf{M}^2: C_0^{\text{cell}}(K_2) \rightarrow C_0^{\text{cell}}(K_2) \otimes C_0^{\text{cell}}(K_2)$  is the standard isomorphism  $R \cong R \otimes_R R$ .

Equivalently, we can view  $\mathbf{M}$  as a formal linear combination of pairs of trees  $\mathbf{m}_n \in \mathcal{T}_n \otimes \mathcal{T}_n$  in dimension  $n-2$ , corresponding to the cells  $\mathbf{M}_n(\Psi_n)$ . For module diagonals, the leftmost strands are distinguished. These trees must satisfy:

- **Compatibility:**

$$(2.24) \quad \partial \mathbf{m}_n = \sum_{k+\ell=n+1} (\mathbf{m}_k \circ_1 \mathbf{m}_\ell + \sum_{i=2}^k \mathbf{m}_k \circ_i \gamma_\ell).$$

- **Non-degeneracy:**  $\mathbf{m}_2 = \Psi_2 \otimes \Psi_2$ .

We will sometimes call the data  $\{\mathbf{m}_n\}$  a module tree diagonal.

Left module (tree) diagonals are defined similarly, except that the rightmost strands are distinguished. That is, the compatibility condition (2.24) is replaced by

$$\partial \mathbf{m}_n = \sum_{k+\ell=n+1} (\mathbf{m}_k \circ_k \mathbf{m}_\ell + \sum_{i=1}^{k-1} \mathbf{m}_k \circ_i \gamma_\ell).$$

By a module (tree) diagonal we will always mean a right module (tree) diagonal.

The proof of the equivalence of the above two definitions of module diagonals is similar to the proof of Lemma 2.19. Schematically, the compatibility condition for a right module diagonal is:

$$\partial \left( \begin{array}{c} \swarrow \\ \mathbf{m} \\ \downarrow \\ \downarrow \\ \downarrow \end{array} \quad \begin{array}{c} \swarrow \\ \mathbf{m} \\ \downarrow \\ \downarrow \\ \downarrow \end{array} \right) = \left( \begin{array}{c} \swarrow \quad \swarrow \\ \mathbf{m} \quad \mathbf{m} \\ \downarrow \quad \downarrow \\ \downarrow \quad \downarrow \\ \downarrow \quad \downarrow \end{array} \right) + \left( \begin{array}{c} \swarrow \quad \swarrow \\ \mathbf{m} \quad \mathbf{m} \\ \downarrow \quad \downarrow \\ \downarrow \quad \downarrow \\ \downarrow \quad \downarrow \end{array} \right)$$

(For a left module diagonal one reflects the pictures horizontally.)

The first few terms in a particular module tree diagonal are shown in Figure 5.

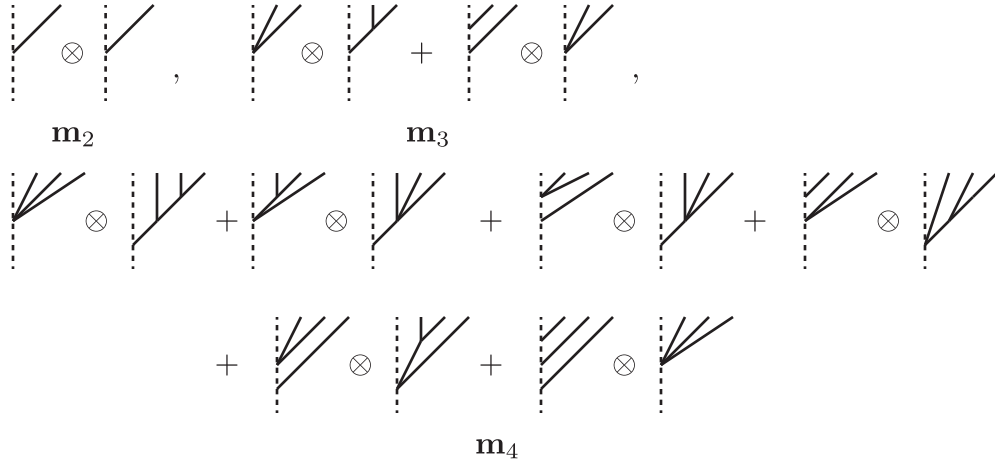

FIGURE 5. **The first three terms in a module diagonal associated to a module diagonal primitive.** This is the module diagonal associated to the primitive in Figure 7.

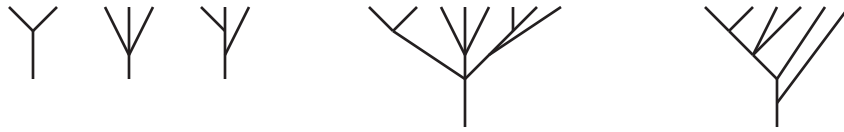

FIGURE 6. **Joining trees.** Left: trees  $T_1$ ,  $T_2$ , and  $T_3$ . Center: the root joining  $\text{RoJ}(T_1, T_2, T_3)$  of  $T_1, T_2, T_3$ . Right: the left joining  $\text{LeJ}(T_1, T_2, T_3)$  of  $T_1, T_2, T_3$ .

*Example 2.25.* Any associahedron diagonal can be viewed as a module diagonal; i.e., given an associahedron diagonal  $\mathbf{\Gamma}$ , the collection of chain maps  $\mathbf{M}^n = \mathbf{\Gamma}^n$  satisfies the hypotheses of Definition 2.22.

**2.4. Module diagonal primitives.** The goals of this section are to define module diagonal primitives and relate them to module diagonals.

**Definition 2.26.** *The leftmost strand of a rooted, planar tree is the path which is composed of a sequence of edges  $e_1, \dots, e_n$ , where  $e_n$  is the terminal edge (incident to the output leaf),  $e_i$  is the leftmost edge into the initial vertex of  $e_{i+1}$ , and  $e_1$  is edge incident to the leftmost input leaf.*

**Definition 2.27.** *Given a sequence  $S_1, \dots, S_n$  of trees, the root joining  $\text{RoJ}(S_1, \dots, S_n)$  of  $S_1, \dots, S_n$  is obtained by joining the outputs of  $S_1, \dots, S_n$  into a single new node. That is, the root joining is*

$$\text{RoJ}(S_1, \dots, S_n) = (((\Psi_n \circ_n S_n) \circ_{n-1} S_{n-1}) \circ_{n-2} \dots) \circ_1 S_1 = \Psi_n \circ (S_1, \dots, S_n).$$

See Figure 6.

*Given a sequence  $T_1, \dots, T_n$  of trees, the left joining  $\text{LeJ}(T_1, \dots, T_n)$  of  $T_1, \dots, T_n$  is given by attaching the output of  $T_i$  (for  $i = 1, \dots, n-1$ ) to the leftmost input of  $T_{i+1}$ . That is,*

$$\text{LeJ}(T_1, \dots, T_n) = T_n \circ_1 (T_{n-1} \circ_1 (\dots \circ_1 T_1)).$$

Again, see Figure 6.

When working with primitives, we will be interested in pairs of trees  $(T, S) \in \mathcal{T}_n \otimes \mathcal{T}_{n-1}$ .

**Definition 2.28.** *Given  $(T_1, S_1) \in \mathcal{T}_n \otimes \mathcal{T}_{n-1}$  and  $(T_2, S_2) \in \mathcal{T}_m \otimes \mathcal{T}_m$ , define a shifted version of composition by  $(T_1, S_1) \circ'_i (T_2, S_2) = (T_1 \circ_{i+1} T_2, S_1 \circ_i S_2)$ , and let  $(T_1, S_1) \circ' (T_2, S_2) = \sum_{i=1}^{n-1} (T_1, S_1) \circ'_i (T_2, S_2)$ .*



FIGURE 7. **The first three terms in a module diagonal primitive.** The terms  $\mathbf{p}_2$ ,  $\mathbf{p}_3$ , and  $\mathbf{p}_4$  are shown. This primitive is compatible with the associahedron diagonal from Figure 3.

For  $n \geq 2$ , given a sequence  $(T_1, S_1), (T_2, S_2), \dots, (T_n, S_n)$  of pairs of trees, with each  $T_i$  having one more input than  $S_i$ , define the left-root joining of the sequence to be

$$\text{LR}((T_1, S_1), \dots, (T_n, S_n)) = \text{LeJ}(T_1, \dots, T_n) \otimes \text{RoJ}(S_1, \dots, S_n),$$

where the left join  $\text{LeJ}$  and root join  $\text{RoJ}$  are defined in Definition 2.27. Extend  $\text{LR}$  multi-linearly to a function

$$\text{LR}: (\mathcal{T} \otimes \mathcal{T})^{\otimes n} \rightarrow (\mathcal{T} \otimes \mathcal{T})$$

for  $n \geq 2$ . We define  $\text{LR}$  to vanish on  $(\mathcal{T} \otimes \mathcal{T})^{\otimes 1}$  and on  $(\mathcal{T} \otimes \mathcal{T})^{\otimes 0}$ .

**Definition 2.29.** Fix an associahedron tree diagonal  $\gamma$ . A (right) module diagonal primitive compatible with  $\gamma$  consists of a linear combination of trees for  $n \geq 2$

$$(2.30) \quad \mathbf{p}_n = \sum_{(S,T)} n_{S,T} (S, T) \in \mathcal{T}_n \otimes \mathcal{T}_{n-1},$$

in dimension  $n - 2$ , satisfying the following conditions:

- **Compatibility:**

$$(2.31) \quad \partial \mathbf{p} = \text{LR}(\mathbf{p}^{\otimes \bullet}) + \mathbf{p} \circ' \gamma.$$

Here,  $\mathbf{p} = \sum_n \mathbf{p}_n \in \prod_n \mathcal{T}_n \otimes \mathcal{T}_{n-1}$  and  $\mathbf{p}^{\otimes \bullet} = \sum_{n \geq 0} \mathbf{p}^{\otimes n}$ .

- **Non-degeneracy:**  $\mathbf{p}_2 = \Psi_2 \otimes \downarrow$ .

(The reader familiar with  $DD$  bimodules may want to skip ahead to Definition 3.49 for the motivation for module diagonal primitives.)

Schematically, the module diagonal primitive compatibility condition is:

The first few terms in one module diagonal primitive, compatible with the associahedron diagonal from Figure 3, are shown in Figure 7.

*Example 2.32.* Given a tree  $S$ , a *left inflation* of  $S$  is a tree obtained from  $S$  by adding one more input, to the left of the other inputs of  $S$ , and connecting that input to some (existing) internal vertex on the left-most strand of  $S$ . Let  $\Delta = \{(S, T)\}$  be the set of pairs of trees appearing in the diagonal in Example 2.21. One can show that

$$\{(S', T) \mid \exists (S, T) \in \Delta \text{ such that } S' \text{ is a left inflation of } S\}$$

is a module diagonal primitive compatible with  $\Delta$ . This is the module diagonal primitive shown in Figure 7. (See also the proof of Lemma 2.37.)

**Lemma 2.33.** *Given  $x_1 \otimes \cdots \otimes x_n \in (\mathcal{T} \otimes \mathcal{T})^{\otimes n}$ , the operation LR satisfies*

$$\begin{aligned} \partial(\text{LR}(x_1 \otimes \cdots \otimes x_n)) &= \sum_{i=1}^n \text{LR}(x_1 \otimes \cdots \otimes \partial(x_i) \otimes \cdots \otimes x_n) \\ &\quad + \sum_{j=2}^{n-1} \sum_{i=0}^{n-j} \text{LR}(x_1 \otimes \cdots \otimes x_i \otimes \text{LR}(x_{i+1} \otimes \cdots \otimes x_{i+j}) \otimes x_{i+j+1} \otimes \cdots \otimes x_n). \end{aligned}$$

The operation  $\circ'$  satisfies  $\partial(x \circ' y) = \partial(x) \circ' y + x \circ' \partial(y)$ . Finally,

$$\text{LR}(x_1 \otimes \cdots \otimes x_n) \circ' y = \sum_{i=1}^n \text{LR}(x_1, \dots, x_{i-1}, x_i \circ' y, x_{i+1}, \dots, x_n).$$

*Proof.* The claim about  $\partial \circ \text{LR}$  is immediate from the definition: the second sum comes from differentiating the corolla in the root joining. The Leibniz rule for  $\circ'$  and distributivity of  $\circ'$  and LR are also immediate from the definitions.  $\square$

Recall that Proposition 1.8 asserts the existence of module diagonal primitives.

*Proof of Proposition 1.8.* As in Lemma 2.20, we proceed by induction on the number of inputs. The case  $n = 2$  is determined by the non-degeneracy condition. For the case  $n = 3$ , the compatibility condition is

$$\partial \mathbf{p}_3 = \begin{array}{c} \diagup \\ \downarrow \end{array} \otimes \begin{array}{c} \diagdown \\ \downarrow \end{array} + \begin{array}{c} \downarrow \\ \downarrow \end{array} \otimes \begin{array}{c} \diagdown \\ \downarrow \end{array}.$$

(The two terms come from the two terms on the right of Formula (2.31), respectively.) This is solved by

$$\mathbf{p}_3 = \begin{array}{c} \diagup \\ \downarrow \end{array} \otimes \begin{array}{c} \diagdown \\ \downarrow \end{array}.$$

If we have constructed primitives with fewer than  $n$  leaves,  $n > 3$ , it suffices to verify that the expression on the right of Formula (2.31) is a cycle: the fact that it is a boundary then follows from contractibility of  $K_n \times K_{n-1}$  and the fact that a primitive lies in dimension  $n-2$ . Using Lemma 2.33, we have

$$\begin{aligned} \partial(\text{LR}(\mathbf{p}^{\otimes \bullet}) + \mathbf{p} \circ' \gamma) &= \text{LR}(\mathbf{p}^{\otimes \bullet} \otimes \text{LR}(\mathbf{p}^{\otimes \bullet}) \otimes \mathbf{p}^{\otimes \bullet}) + \text{LR}(\mathbf{p}^{\otimes \bullet} \otimes \partial(\mathbf{p}) \otimes \mathbf{p}^{\otimes \bullet}) \\ &\quad + \partial(\mathbf{p}) \circ' \gamma + \mathbf{p} \circ' \partial(\gamma). \end{aligned}$$

Applying the primitive compatibility condition (Formula (2.31)) to the second and third terms and the associahedron diagonal compatibility condition (Formula (2.18)) to the fourth term gives

$$\begin{aligned} \text{LR}(\mathbf{p}^{\otimes \bullet} \otimes \text{LR}(\mathbf{p}^{\otimes \bullet}) \otimes \mathbf{p}^{\otimes \bullet}) + \text{LR}(\mathbf{p}^{\otimes \bullet} \otimes \text{LR}(\mathbf{p}^{\otimes \bullet}) \otimes \mathbf{p}^{\otimes \bullet}) + \text{LR}(\mathbf{p}^{\otimes \bullet} \otimes (\mathbf{p} \circ' \gamma) \otimes \mathbf{p}^{\otimes \bullet}) \\ + \text{LR}(\mathbf{p}^{\otimes \bullet}) \circ' \gamma + (\mathbf{p} \circ' \gamma) \circ' \gamma + \mathbf{p} \circ' (\gamma \circ \gamma). \end{aligned}$$

The first two terms cancel, the third and fourth terms cancel, and the fifth and sixth terms cancel. The result follows.  $\square$

We can construct a module diagonal from a primitive.

**Definition 2.34.** *Given a sequence  $(S_1, T_1), \dots, (S_k, T_k)$  of pairs of trees, define a modified left-root joining by*

$$\text{LR}'((S_1, T_1), \dots, (S_k, T_k)) = \text{LeJ}(S_1, \dots, S_k) \otimes \text{RoJ}(\downarrow, T_1, \dots, T_k).$$

*If each  $S_i$  has one more input than the corresponding  $T_i$ , then in the result of  $\text{LR}'$  the two trees have the same number of inputs. Extend  $\text{LR}'$  multi-linearly to a function*

$$\text{LR}': (\mathcal{T} \otimes \mathcal{T})^{\otimes n} \rightarrow (\mathcal{T} \otimes \mathcal{T})$$

for  $n \geq 1$ . Define  $\text{LR}'$  to vanish on  $(\mathcal{T} \otimes \mathcal{T})^{\otimes 0}$ . Then, if  $\mathbf{p} = \sum_n \mathbf{p}_n$  is a linear combination of trees as in Equation (2.30), the module tree diagonal associated to  $\mathbf{p}$  is

$$(2.35) \quad \mathbf{m}_{\mathbf{p}} := \text{LR}'(\mathbf{p}^{\otimes \bullet}).$$

Schematically, the associated module tree diagonal is:

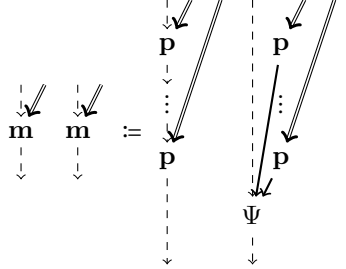

An example is shown in Figure 5. In that figure, the trees in each  $\mathbf{m}_n$  are listed in order of the number  $k$  of terms in  $\mathbf{p}^{\otimes k}$  which are joined together.

**Lemma 2.36.** *Given  $x_1 \otimes \cdots \otimes x_n \in (\mathcal{T} \otimes \mathcal{T})^{\otimes n}$ , the operation  $\text{LR}'$  satisfies*

$$\begin{aligned} \partial(\text{LR}'(x_1 \otimes \cdots \otimes x_n)) &= \sum_{i=1}^n \text{LR}'(x_1 \otimes \cdots \otimes \partial(x_i) \otimes \cdots \otimes x_n) \\ &+ \sum_{i=1}^{n-1} \text{LR}'(x_1 \otimes \cdots \otimes x_i) \circ_1 \text{LR}'(x_{i+1} \otimes \cdots \otimes x_n) \\ &+ \sum_{j=2}^n \sum_{i=0}^{n-j} \text{LR}'(x_1 \otimes \cdots \otimes \text{LR}(x_{i+1} \otimes \cdots \otimes x_{i+j}) \otimes \cdots \otimes x_n). \end{aligned}$$

*Proof.* This is immediate from the definitions. The second and third terms come from differentiating the corolla in the root joining, depending on whether the new edge is on the left or not.  $\square$

Lemma 1.9 asserts that the associated module tree diagonal is, in fact, a module tree diagonal.

*Proof of Lemma 1.9.* Let  $\mathbf{m}$  be the module tree diagonal associated to  $\mathbf{p}$ . Non-degeneracy of  $\mathbf{m}$  is immediate. From Lemma 2.36 and the module diagonal primitive compatibility Equation (2.31), we have

$$\begin{aligned} \partial \mathbf{m} &= \text{LR}'(\mathbf{p}^{\otimes \bullet} \otimes \partial \mathbf{p} \otimes \mathbf{p}^{\otimes \bullet}) + \text{LR}'(\mathbf{p}^{\otimes \bullet}) \circ_1 \text{LR}'(\mathbf{p}^{\otimes \bullet}) + \text{LR}'(\mathbf{p}^{\otimes \bullet} \otimes \text{LR}(\mathbf{p}^{\otimes \bullet}) \otimes \mathbf{p}^{\otimes \bullet}) \\ &= \text{LR}'(\mathbf{p}^{\otimes \bullet} \otimes (\mathbf{p} \circ' \gamma) \otimes \mathbf{p}^{\otimes \bullet}) + \text{LR}'(\mathbf{p}^{\otimes \bullet}) \circ_1 \text{LR}'(\mathbf{p}^{\otimes \bullet}) \\ &= \sum_{i \geq 2} \mathbf{m} \circ_i \gamma + \mathbf{m} \circ_1 \mathbf{m}, \end{aligned}$$

agreeing with the module diagonal compatibility Equation (2.24).  $\square$

Module diagonal primitives, if they exist, are unique, and satisfy the module primitive compatibility condition:

**Lemma 2.37.** *If  $\mathbf{p}$  and  $\mathbf{p}'$  are module diagonal primitives with  $\text{LR}'(\mathbf{p}) = \text{LR}'(\mathbf{p}')$  then  $\mathbf{p} = \mathbf{p}'$ . Further, if  $\mathbf{m}$  is a module tree diagonal so that  $\mathbf{m} = \text{LR}'(\mathbf{p})$  for some collection of pairs of trees  $\mathbf{p}$  then  $\mathbf{p}$  is a module diagonal primitive.*

*Proof.* For the first statement, note that there is a bijection between pairs of trees  $(S, T)$  in  $\mathbf{p}_n$  and pairs of trees  $(S', T')$  in  $\mathbf{m}_n$  for which the trunk vertex  $T'$  (the internal vertex closest to the root) has valence 3. Given  $(S', T')$ , the corresponding tree  $(S, T)$  has  $S = S'$  and  $T$  obtained from  $T'$  by deleting the left-most edge. (Compare Figures 7 and 5 and Example 2.32.)

For the second statement, if  $\mathbf{m}$  satisfies the module diagonal compatibility condition then, as in the proof of Lemma 1.9, we must have

$$\begin{aligned} \text{LR}'(\mathbf{p}^{\otimes \bullet} \otimes \partial \mathbf{p} \otimes \mathbf{p}^{\otimes \bullet}) + \text{LR}'(\mathbf{p}^{\otimes \bullet}) \circ_1 \text{LR}'(\mathbf{p}^{\otimes \bullet}) + \text{LR}'(\mathbf{p}^{\otimes \bullet} \otimes \text{LR}(\mathbf{p}^{\otimes \bullet}) \otimes \mathbf{p}^{\otimes \bullet}) \\ = \text{LR}'(\mathbf{p}^{\otimes \bullet} \otimes (\mathbf{p} \circ' \gamma) \otimes \mathbf{p}^{\otimes \bullet}) + \text{LR}'(\mathbf{p}^{\otimes \bullet}) \circ_1 \text{LR}'(\mathbf{p}^{\otimes \bullet}). \end{aligned}$$

Thus,

$$\text{LR}'(\mathbf{p}^{\otimes \bullet} \otimes \partial \mathbf{p} \otimes \mathbf{p}^{\otimes \bullet}) + \text{LR}'(\mathbf{p}^{\otimes \bullet} \otimes \text{LR}(\mathbf{p}^{\otimes \bullet}) \otimes \mathbf{p}^{\otimes \bullet}) + \text{LR}'(\mathbf{p}^{\otimes \bullet} \otimes (\mathbf{p} \circ' \gamma) \otimes \mathbf{p}^{\otimes \bullet}) = 0.$$

Restricting to the terms where the trunk vertex of the left tree has valence 3 then gives

$$\text{LR}'(\partial \mathbf{p}) + \text{LR}'(\text{LR}(\mathbf{p}^{\otimes \bullet})) + \text{LR}'(\mathbf{p} \circ' \gamma) = 0.$$

Considering the terms where the trunk vertex of the right tree also has valence 3 shows that

$$\partial \mathbf{p} + \text{LR}(\mathbf{p}^{\otimes \bullet}) + \mathbf{p} \circ' \gamma = 0,$$

as desired. Finally, non-degeneracy of  $\mathbf{m}$  implies non-degeneracy of  $\mathbf{p}$ .  $\square$

*Remark 2.38.* It would be nice to have a cellular definition of a module diagonal primitive, along the lines of the (non-tree versions of) Definitions 2.13 and 2.22.

*Remark 2.39.* Fix an associahedron tree diagonal  $\gamma$ . We can define a differential algebra  $\mathcal{A}$  as follows. Let  $\mathcal{A}_n$  be the free  $R$ -module spanned by the pairs of trees with  $n$  inputs (and no 2-valent vertices), and let  $\mathcal{A} = \prod_{n=1}^{\infty} \mathcal{A}_n$ . The multiplication on  $\mathcal{A}$  is given by  $(T_1, T_2) \cdot (S_1, S_2) = (T_1 \circ_1 S_1, T_2 \circ_1 S_2)$ . The differential on  $\mathcal{A}_n$  is given by

$$\partial(S, T) = (\partial(S), T) + (S, \partial(T)) + \sum_{i=2}^n (S, T) \circ_i \gamma$$

(where  $\partial(S)$  denotes the usual differential on trees, i.e., the sum of all ways of adding an edge to  $S$ ). It is straightforward to verify that  $\mathcal{A}$  is a differential algebra.

A module diagonal is a rank 1 type  $D$  structure (see Section 3.4) over  $\mathcal{A}$  satisfying the non-degeneracy condition that  $\delta^1$  of the generator contains  $\Psi_2 \otimes \Psi_2$ .

Similarly, define an  $A_{\infty}$ -algebra  $\mathcal{B}$  as follows. Let  $\mathcal{B}_n$  be the free  $R$ -module spanned by all pairs of trees  $(S, T)$  where  $S$  has  $n$  inputs,  $T$  has  $n - 1$  inputs, and neither  $S$  nor  $T$  has any 2-valent vertices. Let  $\mathcal{B} = \prod_{n=2}^{\infty} \mathcal{B}_n$ . Define products  $\mu_k$  on  $\mathcal{B}$ ,  $k \geq 2$ , by

$$\mu_k((S_1, T_1), \dots, (S_k, T_k)) = \text{LR}((S_1, T_1), \dots, (S_k, T_k)).$$

Define a differential on  $\mathcal{B}_n$  by

$$\partial(S, T) = (\partial(S), T) + (S, \partial(T)) + (S, T) \circ' \gamma.$$

It is straightforward to verify that  $\mathcal{B}$  is an  $A_{\infty}$ -algebra.

A module diagonal primitive is a rank 1 type  $D$  structure over  $\mathcal{B}$ .

There is an  $A_{\infty}$ -homomorphism  $F: \mathcal{B} \rightarrow \mathcal{A}$  defined by

$$F_k((S_1, T_1), \dots, (S_n, T_n)) = \text{LR}'((S_1, T_1), \dots, (S_k, T_k)).$$

Viewing  $F$  as a rank-one type  $DA$  structure  ${}^{\mathcal{A}}[F]_{\mathcal{B}}$  over  $\mathcal{A}$  and  $\mathcal{B}$  (see [LOT15, Definition 2.2.48]), the operation of turning a module diagonal primitive into a module tree diagonal is taking the  $\boxtimes$  product, over  $\mathcal{B}$ , with  ${}^{\mathcal{A}}[F]_{\mathcal{B}}$  (see [LOT15, Section 2.3.2]), i.e., applying the induction functor associated to  $F$  to the module diagonal primitive.



**2.5. Multiplihedra and multiplihedron diagonals.** The associahedron is relevant to the definition of an  $A_\infty$ -algebra. There is a different contractible CW complex, the *multiplihedron*  $J_n$ , which is relevant to morphisms of  $A_\infty$ -algebras [IM89]. (Like the associahedron, the multiplihedron can be understood in terms of disks with boundary marked points [MW10].)

**Definition 2.40.** *By a transformation tree we mean a tree whose edges are colored by one of two colors, red and blue, such that:*

- (1) *The edges adjacent to input leaves are red.*
- (2) *The edge adjacent to the output leaf is blue.*
- (3) *For each vertex  $v$ , all of the inputs of  $v$  have the same color (red or blue).*
- (4) *If a vertex  $v$  has a red output, then all of the inputs of  $v$  are red; if a vertex has blue inputs, then its output is also blue.*

*Call an internal vertex red (respectively blue) if all of its inputs and its output are red (respectively blue), and purple if its inputs are red but its output is blue. We also require that*

- (5) *every 2-valent vertex is purple.*

The cells in the multiplihedron are in natural correspondence with transformation trees. The differential on  $C_*^{cell}(J_n)$  is defined as follows. Given a blue (respectively red) corolla  $\mathbf{b}\Psi_n$  (respectively  $\mathbf{r}\Psi_n$ ), define the differential of  $\mathbf{b}\Psi_n$  (respectively  $\mathbf{r}\Psi_n$ ) as in Section 2.1, by summing over all ways of inserting an edge. To define the differential of a purple corolla  $\mathbf{p}\Psi_n$ , we use the *blue root joining*  $\mathbf{bRoJ}(S_1, \dots, S_n)$  of a collection of transformation trees, which is just their root joining at a vertex which is colored blue. Given a purple corolla  $\mathbf{p}\Psi_n$ , define  $\partial(\mathbf{p}\Psi_n)$  to be

$$(2.41) \quad \partial(\mathbf{p}\Psi_n) = \sum_{k+\ell=n+1} \mathbf{p}\Psi_k \circ \mathbf{r}\Psi_\ell + \sum_{k_1+\dots+k_\ell=n} \mathbf{bRoJ}(\mathbf{p}\Psi_{k_1}, \dots, \mathbf{p}\Psi_{k_\ell})$$

The differential of a transformation tree  $T$  is the sum over the internal vertices  $v$  of  $T$  of the result of replacing  $v$  by  $\partial(v)$ . See Figure 8.

The dimension of a transformation tree  $T$  with  $n$  inputs,  $r$  red internal vertices, and  $b$  blue internal vertices is

$$\dim(T) = n - r - b - 1.$$

The terms in Formula (2.41) correspond to the codimension-1 faces of  $J_n$ . In particular, for any  $1 \leq i < j \leq n$  and any  $0 = i_0 < i_1 < \dots < i_\ell = n$  there are codimension-1 faces  $G_{i,j}^n$  and  $H_{i_0, \dots, i_\ell}^n$  of  $J_n$ , identifications

$$\begin{aligned} K_{j-i+1} \times J_{n+i-j} &\cong G_{i,j}^n \subset J_n \\ J_{i_1-i_0} \times \dots \times J_{i_\ell-i_{\ell-1}} \times K_\ell &\cong H_{i_0, \dots, i_\ell}^n \subset J_n \end{aligned}$$

and corresponding maps

$$\begin{aligned} \psi_{i,j}^n &: C_*^{cell}(K_{j-i+1}) \otimes C_*^{cell}(J_{n+i-j}) \rightarrow C_*^{cell}(J_n) \\ \xi_{i_0, \dots, i_\ell}^n &: C_*^{cell}(J_{i_1-i_0}) \otimes \dots \otimes C_*^{cell}(J_{i_\ell-i_{\ell-1}}) \otimes C_*^{cell}(K_\ell) \rightarrow C_*^{cell}(J_n). \end{aligned}$$

In terms of trees, the map  $\psi_{i,j}^n$  corresponds to  $(S, T) \mapsto T \circ_i S$  (where  $T$  is a transformation tree and  $S$  is a (red) associahedron tree). The map  $\xi_{i_0, \dots, i_\ell}^n$  corresponds to

$$(T_1, \dots, T_\ell, S) \mapsto ((S \circ_\ell T_\ell) \circ_{\ell-1} \dots) \circ_1 T_1 = S \circ (T_1, \dots, T_\ell)$$

(where the  $T_i$  are transformation trees and  $S$  is a (blue) associahedron tree).

**Lemma 2.42.** *The multiplihedron  $J_n$  is contractible. In particular,  $H_0(J_n) = R$  and  $H_i(J_n) = 0$  for  $i \neq 0$ .*

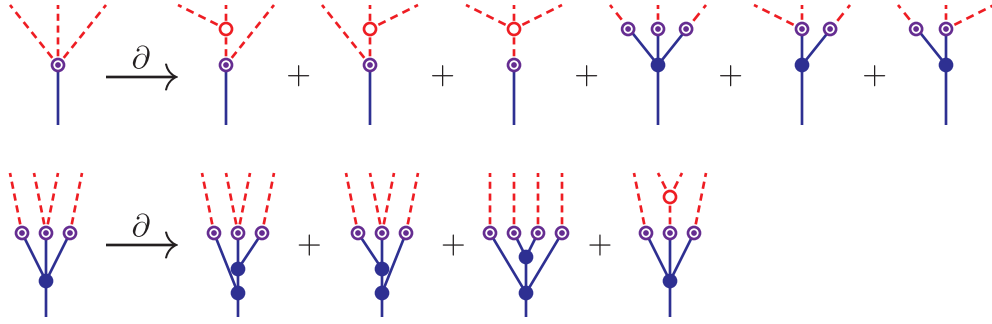

FIGURE 8. **The differential on  $C_*^{cell}(J_n)$ .** Top: the differential of a purple corolla. Bottom: the differential of a tree with four internal vertices. Blue segments are solid, red segments are dashed, blue vertices are solid, red vertices are hollow, and purple vertices are solid and hollow.

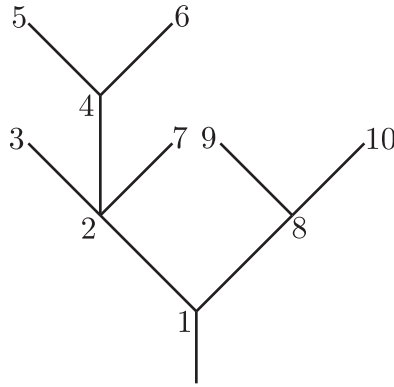

FIGURE 9. **Depth-first search.** The ordering of the vertices, not the weights of the vertices, is indicated by the numbering.

*Proof.* This is clear from the construction of  $J_n$  as a subspace of  $\mathbb{R}^{n-1}$  [IM89, Section 2]. Since it will be useful to us later, we also give a direct proof.

Given a (weighted) rooted, planar tree  $T$ , we can order the internal vertices of  $T$  by (*pre-order*) *depth-first search*. If  $v$  is the trunk vertex of  $T$  and the sub-trees feeding into  $v$  are  $T_1, \dots, T_k$  (so  $v$  has valence  $k + 1$ ) then the depth-first search is the sequence of internal vertices of  $T$

$$(2.43) \quad \text{dfs}(T) = (v, \text{dfs}(T_1), \text{dfs}(T_2), \dots, \text{dfs}(T_k)).$$

Given an internal vertex  $v'$  of  $T$ ,  $\text{dfsind}(v') \in \mathbb{N}$  denote the index (location) of  $v'$  in  $\text{dfs}(T)$ . See Figure 9.

Consider the operator  $H: J_n \rightarrow J_n$  defined as follows. Fix  $T \in J_n$ . Using depth-first search, look for the first purple vertex  $v$  in  $T$ , skipping 2-valent vertices whose input is an input to  $T$ . If  $v$  is 2-valent, contract the input edge into  $v$ , and call the result  $H(T)$ . If  $v$  is not 2-valent or if there is no such vertex, then  $H(T) = 0$ .

Consider the filtration  $F(T) = \sum_{\{u \in \text{Vert}(T) \mid u \text{ is not blue}\}} (\text{val}(u) - 2)$ , where  $\text{val}(u)$  denotes the valence of  $u$ . Clearly,  $F(T) \geq 0$  for all  $T$ , and the differential respects the filtration determined by  $F$ , i.e., if  $S$  appears in  $\partial(T)$  then  $F(S) \leq F(T)$ . We claim that if  $F(T) > 0$ , then the terms in

$$(\partial \circ H + H \circ \partial + \mathbb{I})(T)$$

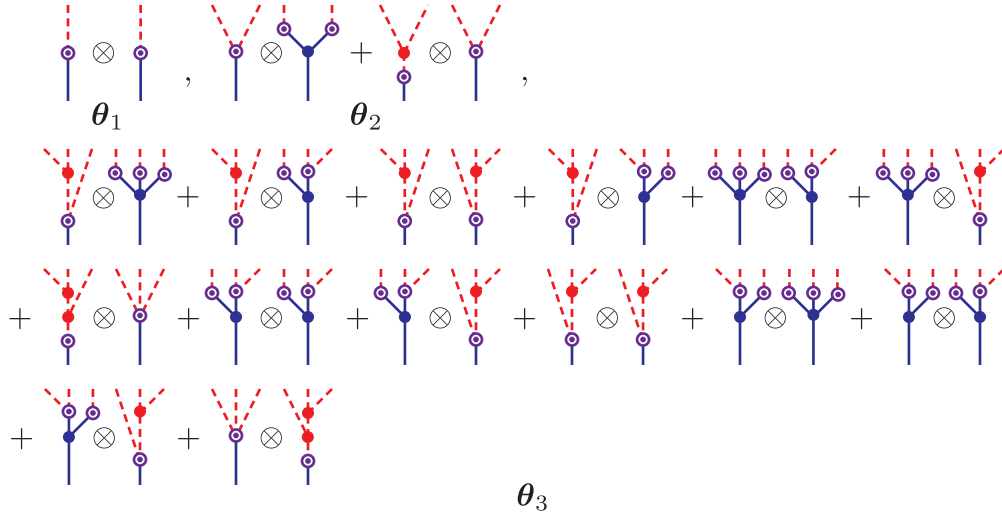

FIGURE 10. **The first three terms in a multiplihedron diagonal.** This multiplihedron diagonal is compatible with the associahedron diagonal from Figure 3 (on both sides).

are in filtration level strictly less than  $F(T)$ . Indeed, the terms in  $\partial(H(T))$  and  $H(\partial(T))$  clearly cancel in pairs except:

- Terms in  $\partial(H(T))$  where  $H$  contracts the input edge to a 2-valent vertex creating a new purple vertex  $w$ , and  $\partial$  splits the vertex  $w$ . These occur only if the vertex  $v$  in  $T$  found by depth-first search is 2-valent. All of the resulting terms in  $\partial(H(T))$  have filtration strictly less than  $F(T)$  (because they have more blue vertices) except the term  $T$  itself, which cancels against  $\mathbb{I}(T)$ .
- Terms in  $H(\partial(T))$  where  $\partial(T)$  creates a new 2-valent purple vertex  $v'$  which is the first vertex found by depth-first search. This occurs only if the first purple vertex  $v$  in  $T$  found by depth-first search has valence  $> 2$ , so  $H(T) = 0$ . All but one of the resulting terms in  $H(\partial(T))$  have filtration less than  $F(T)$  (because they have more blue vertices); the remaining term in  $H(\partial(T))$  is  $T$  itself, which cancels with  $\mathbb{I}(T)$ .

If  $F(T) = 0$ , all the non-blue nodes in the tree  $T$  are 2-valent (and hence they are purple, and all their inputs are inputs to  $T$ ). In that case,

$$(\partial \circ H + H \circ \partial)(T) = 0.$$

It follows that  $J_n$  is chain homotopy equivalent to the subcomplex in filtration level 0, which in turn is identified with the associahedron with  $n$  inputs. The result now follows from the corresponding fact for the associahedron.  $\square$

Tensoring maps of  $A_\infty$ -algebras will use multiplihedron diagonals:

**Definition 2.44.** Fix associahedron diagonals  $\Gamma_1$  and  $\Gamma_2$ . A multiplihedron diagonal compatible with  $\Gamma_1$  and  $\Gamma_2$  consists of a sequence of (degree-preserving) chain maps

$$\{\Theta^n: C_*^{cell}(J_n) \rightarrow C_*^{cell}(J_n) \otimes C_*^{cell}(J_n)\}_{n=1}^\infty$$

satisfying the following conditions:

- **Compatibility under stacking:**

$$\Theta^n \circ \psi_{i,j}^n = (\psi_{i,j}^n \otimes \psi_{i,j}^n) \circ (\Gamma_1^{j-i+1} \otimes \Theta^{n+i-j})$$

$$\Theta^n \circ \xi_{i_0, \dots, i_\ell}^n = (\xi_{i_0, \dots, i_\ell}^n \otimes \xi_{i_0, \dots, i_\ell}^n) \circ (\Theta^{i_1 - i_0} \otimes \dots \otimes \Theta^{i_\ell - i_{\ell-1}} \otimes \Gamma_2^\ell),$$

with the understanding that the compositions on the right-hand side involve shuffling of factors (compare Formula (2.15)).

- **Non-degeneracy:**  $\Theta^1: C_0^{\text{cell}}(J_1) \rightarrow C_0^{\text{cell}}(J_1) \otimes C_0^{\text{cell}}(J_1)$  is the standard isomorphism  $R \cong R \otimes_R R$ . (Note that  $J_1$  is a single point.)

In terms of trees, if  $\Gamma_1$  and  $\Gamma_2$  correspond to the associahedron tree diagonals  $\gamma^1$  and  $\gamma^2$ , a multiplihedron diagonal consists of elements  $\theta_n = \Theta^n(\text{p}\Psi_n) \in C_*^{\text{cell}}(J_n) \otimes C_*^{\text{cell}}(J_n)$  in dimension  $n - 1$  satisfying:

- **Compatibility under stacking:**

$$(2.45) \quad \partial(\theta_n) = \sum_{i+j=n+1} \theta_i \circ \gamma_j^1 + \sum_k \sum_{m_1 + \dots + m_k = n} \gamma_k^2 \circ (\theta_{m_1}, \dots, \theta_{m_k}).$$

- **Non-degeneracy:**  $\theta_1 \in C_*^{\text{cell}}(J_1) \otimes C_*^{\text{cell}}(J_1)$  is the (unique) pair of 1-input transformation trees (with 1 internal vertex each).

(The reader might find it helpful to compare Formulas (2.41) and (2.45). The first three terms in a multiplihedron diagonal are shown in Figure 10.)

**Lemma 2.46.** *Given any associahedron diagonals  $\Gamma_1$  and  $\Gamma_2$  there is a multiplihedron diagonal  $\Theta$  compatible with  $\Gamma_1$  and  $\Gamma_2$ .*

*Proof.* This follows from an inductive argument similar to the proof of Lemma 2.20.  $\square$

A particular multiplihedron diagonal was constructed by Saneblidze-Umble [SU04].

**2.6. Module-map diagonals.** To tensor maps of  $A_\infty$ -modules we will use module-map diagonals. By a *module transformation tree* we mean a tree  $T$  together with a distinguished internal vertex  $v$  on the leftmost strand of  $T$ . We require that no vertex of  $T$  except perhaps  $v$  have valence 2. (Alternately, we can think of a module transformation tree as a tree  $T$  together with a coloring of each internal vertex on the left-most strand of  $T$  by red, blue or purple, so that all of the red vertices come above the purple vertex and the purple vertex comes above the blue vertices.) Define the differential of a module transformation tree  $(T, v)$  to be the sum of all ways of inserting an edge in  $T$  so as to get a new module transformation tree. If the edge is inserted at a vertex other than  $v$  then  $v$  specifies the distinguished vertex in the new tree; if one inserts the new edge at  $v$  then there are sometimes two choices of distinguished vertex in the new tree, and if so we take the sum of both choices. See Figure 11. The *dimension* of a module transformation tree is the number of inputs minus the number of internal vertices (including  $v$ ). Let  $\mathcal{T}_n^{MT}$  be the free  $R$ -module generated by the module transformation trees with  $n$  inputs. The differential just defined makes  $\mathcal{T}_n^{MT} = \mathcal{T}_{n,*}^{MT}$  into a chain complex.

There is a correspondence between module transformation trees with  $n$  inputs and associahedron trees with  $n + 1$  inputs, as follows. Given a module transformation tree  $(T, v)$ , define a new tree  $T'$  by adding a new input leaf to the left of all inputs in  $T$  and connecting the new input to  $v$ . It is easy to see that this gives a bijection, and moreover that it respects the differentials. In particular, the set of module transformation trees with  $n$  inputs corresponds to the cells in  $K_{n+1}$ , and the differential on module transformation trees corresponds to the cellular differential on  $K_{n+1}$ . Thus:

**Corollary 2.47.** *For each  $n$ , the chain complex  $\mathcal{T}_{n,*}^{MT}$  has homology  $R$  in dimension 0 and trivial homology in all other dimensions.*

There are face inclusions

$$\begin{aligned} \phi_{i,j}^n: C_*^{\text{cell}}(K_{j-i+1}) \otimes \mathcal{T}_{n+i-j}^{MT} &\rightarrow \mathcal{T}_n^{MT} \\ \phi_{1,j}^n: \mathcal{T}_j^{MT} \otimes C_*^{\text{cell}}(K_{n+1-j}) &\rightarrow \mathcal{T}_n^{MT} \end{aligned}$$

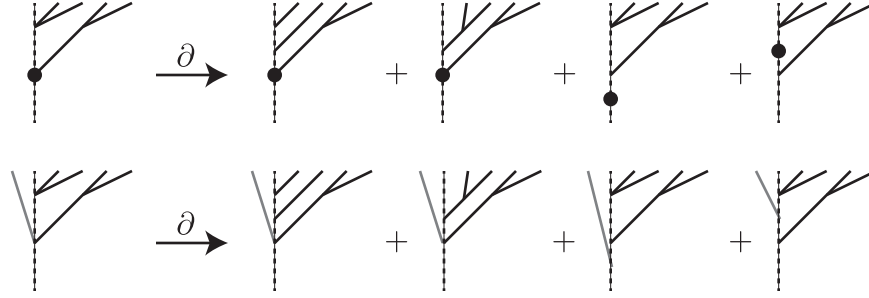

FIGURE 11. **Module transformation trees.** Top: a module transformation tree with five inputs and its differential, where the distinguished vertex in each tree is indicated by the dot. Bottom: the same trees, but viewed as associahedron trees with 6 inputs.

$$\phi_{1,j}^n: C_*^{\text{cell}}(K_j) \otimes \mathcal{T}_{n+1-j}^{MT} \rightarrow \mathcal{T}_n^{MT}$$

which, at the level of trees, are given by

$$\phi_{i,j}^n(S, T) = T \circ_i S.$$

(If we identify  $\mathcal{T}_n^{MT} \cong C_*^{\text{cell}}(K_{1+n})$  then these maps  $\phi$  undergo an indexing shift:  $\phi_{i,j}^n$  as defined here corresponds to  $\phi_{i+1,j+1}^{n+1}$  for the associahedron.)

**Definition 2.48.** Fix an associahedron diagonal  $\Gamma$  and module diagonals  $\mathbf{M}^1$  and  $\mathbf{M}^2$  compatible with  $\Gamma$ . A module-map diagonal compatible with  $\mathbf{M}^1$  and  $\mathbf{M}^2$  is a collection of (degree-preserving) chain maps  $\mathbf{L}_n: \mathcal{T}_{n,*}^{MT} \rightarrow \mathcal{T}_{n,*}^{MT} \otimes \mathcal{T}_{n,*}^{MT}$  satisfying the following conditions:

- **Compatibility:**

$$\mathbf{L}_n \circ \phi_{i,j}^n = \begin{cases} (\phi_{1,j}^n \otimes \phi_{1,j}^n) \circ (\mathbf{L}_j \otimes \mathbf{M}_{n-j+1}^2 + \mathbf{M}_j^1 \otimes \mathbf{L}_{n-j+1}) & i = 1 \\ (\phi_{i,j}^n \otimes \phi_{i,j}^n) \circ (\Gamma_{j-i+1} \otimes \mathbf{L}_{n+i-j}) & i \geq 2. \end{cases}$$

- **Non-degeneracy:**  $\mathbf{L}_1: \mathcal{T}_{1,*}^{MT} \rightarrow \mathcal{T}_{1,*}^{MT} \otimes \mathcal{T}_{1,*}^{MT}$  is the standard isomorphism  $R \cong R \otimes R$ .

Equivalently, we can view  $\mathbf{L}_n$  as a formal linear combination of pairs of module transformation trees

$$\ell_n \in \bigoplus_{i+j=n-1} \mathcal{T}_{n,i}^{MT} \otimes \mathcal{T}_{n,j}^{MT}$$

in dimension  $n-1$  (i.e., a module-map tree diagonal). These trees must satisfy:

- **Compatibility:**

$$\partial(\ell_n) = \sum_{k+\ell=n+1} \left( \ell_k \circ_1 \mathbf{m}_\ell^1 + \mathbf{m}_k^2 \circ_1 \ell_\ell + \sum_{i=2}^k \ell_k \circ_i \gamma_\ell \right).$$

- **Non-degeneracy:**  $\ell_1$  is the (unique) pair of module transformation trees with one input.

The first few terms in a module-map tree diagonal are shown in Figure 12.

**Lemma 2.49.** Given any associahedron diagonal  $\Gamma$  and module diagonals  $\mathbf{M}^1$  and  $\mathbf{M}^2$  there is a module-map diagonal  $\mathbf{L}$  compatible with  $\mathbf{M}^1$  and  $\mathbf{M}^2$ .

*Proof.* Again, this follows from an inductive argument similar to the proof of Lemma 2.20.  $\square$

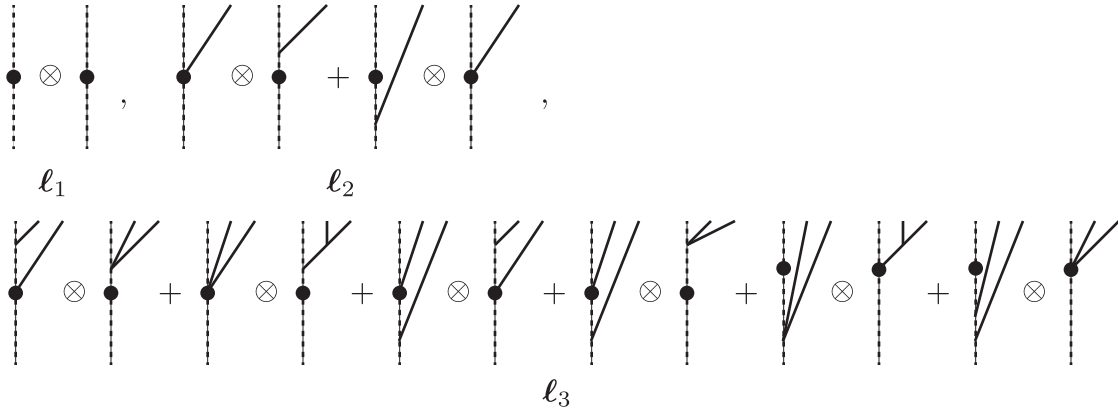

FIGURE 12. **The first few terms in a module-map tree diagonal.** This module-map tree diagonal is compatible with  $\mathbf{m}$  and  $\mathbf{m}$ , where  $\mathbf{m}$  is the module tree diagonal of Figure 5.

We turn next to uniqueness of module-map diagonals. Fix an associahedron tree diagonal  $\gamma$  and compatible module tree diagonals  $\mathbf{m}^1$  and  $\mathbf{m}^2$ . Given a formal linear combination of pairs of module transformation trees

$$\eta_n \in \bigoplus_{i+j=k+n-1} \mathcal{T}_{n,i}^{MT} \otimes \mathcal{T}_{n,j}^{MT},$$

for  $n \geq 1$  and some given  $k$ , we define  $d(\eta)$ , where  $\eta = \{\eta_n\}$ , to be the sequence whose  $n^{\text{th}}$  term is

$$(2.50) \quad d(\eta)_n = \partial(\eta_n) + \sum_{p+m=n+1} \left( \eta_p \circ_1 \mathbf{m}_m^1 + \mathbf{m}_p^2 \circ_1 \eta_m + \sum_{i=2}^p \eta_p \circ_i \gamma_m \right).$$

**Lemma 2.51.** *The operation  $d$  makes the space of sequences  $\eta_n$  into a chain complex, i.e., satisfies  $d^2 = 0$ . (Here, the grading on the chain complex is given by the parameter  $k$ .)*

*Proof.* The verification is a straightforward computation, using the compatibility conditions for the algebra diagonal  $\gamma$  (Equation (2.18)), the module diagonals  $\mathbf{M}^1$  and  $\mathbf{M}^2$  (Equation (2.24)), and the fact that  $\sum_{i>1} (\cdot \circ_i \gamma_q)$  is a derivation over  $\circ_1$  in the sense that, for any  $\eta$ ,

$$\sum_{i=2}^{p+m-1} (\mathbf{m}_p^2 \circ_1 \eta_m) \circ_i \gamma_q = \sum_{i=2}^p (\mathbf{m}_p^2 \circ_i \gamma_q) \circ_1 \eta_m + \sum_{i=2}^m \mathbf{m}_p^2 \circ_1 (\eta_m \circ_i \gamma_q). \quad \square$$

The Compatibility condition in Definition 2.48 is the statement that  $\ell$  is a cycle in this chain complex (with grading 0).

**Definition 2.52.** *Given module-map diagonals  $\ell$  and  $\ell'$ , a homotopy from  $\ell$  to  $\ell'$  is a chain  $\eta$  so that  $d(\eta) = \ell - \ell'$ .*

**Lemma 2.53.** *The chain complex from Lemma 2.51 has homology  $R$  in dimension 0 and trivial homology in all other dimensions.*

*Proof.* The number of inputs  $n$  gives a descending filtration on this chain complex. The associated graded object is

$$\prod_{n \geq 1} \mathcal{T}_{n,*}^{MT} \otimes \mathcal{T}_{n,*}^{MT},$$

with the usual differential  $\partial$ . By Corollary 2.47, the homology of the associated graded—i.e., the  $E^1$ -page of the associated spectral sequence—is

$$\prod_{n \geq 1} R \otimes R,$$



The  $i^{\text{th}}$  summand is generated by any pair of trees with  $i$  inputs so that the purple vertices are 2-valent and all other internal vertices are 3-valent; this lies in grading  $k = -n + 1$ . The  $d_1$ -differential in the spectral sequence comes from splicing in  $\Psi_2 \otimes \Psi_2$  at any of the  $i$  inputs or feeding the output into  $\Psi_2 \otimes \Psi_2$ . This has  $i + 1$  terms, so the  $E^1$ -page is

$$0 \longrightarrow R \xrightarrow{2} R \xrightarrow{3} R \xrightarrow{4} \dots$$

The resulting homology is  $R$ , in dimension 0 (corresponding to the pair of 1-input trees).  $\square$

**Proposition 2.54.** *All module-map diagonals are homotopic.*

*Proof.* Fix module-map diagonals  $\ell$  and  $\ell'$ ; we will construct a homotopy  $\eta = \{\eta_m\}$  inductively in  $n$ . From the non-degeneracy condition,  $\ell_1 = \ell'_1$ . So, we can define  $\eta_1 = 0$ . Suppose inductively that we have defined all  $\eta_i$  satisfying  $d(\eta)_i = \ell_i - \ell'_i$  for all  $i < n$ , for some  $n > 1$ . Then, using Lemma 2.51,

$$\partial \left( \ell'_n - \ell_n + \sum_{p+m=n+1} \left( \eta_p \circ_1 \mathbf{m}_m^1 + \mathbf{m}_p^2 \circ_1 \eta_m + \sum_{i=2}^p \eta_p \circ_i \gamma_m \right) \right) = 0.$$

Further, the terms in

$$\ell'_n - \ell_n + \sum_{p+m=n+1} \left( \eta_p \circ_1 \mathbf{m}_m^1 + \mathbf{m}_p^2 \circ_1 \eta_m + \sum_{i=2}^p \eta_p \circ_i \gamma_m \right)$$

are in dimension  $n - 1 > 0$  in  $\mathcal{T}_{n,*}^{MT} \otimes \mathcal{T}_{n,*}^{MT}$ . So the result follows from Corollary 2.47.  $\square$

**2.7. Module-map primitives and partial module-map diagonals.** To define primitives of module-map diagonals, we use two degenerate trees. One is the identity tree  $\downarrow$  with 1 input, 1 output, and 0 internal vertices; this eventually corresponds to the identity map from the algebra to itself. The other is the *stump*  $\top$ , which is a 0-input, 1-output tree with 0 internal vertices; this eventually corresponds to the unit element of the algebra. Composing  $\downarrow$  (in any way) is the identity map. Composing a corolla with the stump is 0 except for the following cases:

$$\downarrow \circ_1 \top = \top \qquad \Psi_2 \circ_1 \top = \downarrow \qquad \Psi_2 \circ_2 \top = \downarrow.$$

These composition maps are chain maps; see Lemma 6.2.

**Definition 2.55.** *Fix an associahedron diagonal  $\Gamma$  and two module diagonal primitives  $\mathbf{p}^1$  and  $\mathbf{p}^2$  compatible with  $\Gamma$ . A module-map primitive compatible with  $\mathbf{p}^1$  and  $\mathbf{p}^2$  is a linear combination*

$$(2.56) \quad \mathbf{q}_n = \sum_{(S,T)} n_{S,T} (S,T) \in \bigoplus_{i+j=n-1} \mathcal{T}_{n,i}^{MT} \otimes C_j^{\text{cell}}(K_{n-1})$$

of pairs of trees for each  $n \geq 1$ . Here, the tree  $S$  is viewed as a module transformation tree with  $n$  inputs, and the tree  $T$  is an ordinary associahedron tree with  $n-1$  inputs. In the case  $n = 1$ ,  $C_j^{\text{cell}}(K_0)$  is interpreted as one-dimensional, generated by  $\top$ , while for  $n = 2$ ,  $C_j^{\text{cell}}(K_1)$  is interpreted as one-dimensional, generated by  $\downarrow$ . These elements  $\mathbf{q}_n$  are required to satisfy the following conditions:

- **Compatibility:**

$$(2.57) \quad \partial \mathbf{q} = \text{LR}((\mathbf{p}^1)^{\otimes \bullet} \otimes \mathbf{q} \otimes (\mathbf{p}^2)^{\otimes \bullet}) + \mathbf{q} \circ' \gamma.$$

Here, LR from Definition 2.28 is extended in the obvious way to module transformation trees, i.e.,

$$\text{LR}((S_1, T_1), \dots, (S_k, T_k)) = \text{LeJ}(S_1, \dots, S_k) \otimes \text{RoJ}(T_1, \dots, T_k)$$

(which is the tensor product of a module transformation tree and an associahedron tree). We have also invoked the usual convention that  $\mathbf{q} = \sum_n \mathbf{q}_n \in \prod_n \mathcal{T}_{n,*}^{MT} \otimes C_*^{\text{cell}}(K_{n-1})$ .

- **Non-degeneracy:**  $\mathbf{q}_1 = \mathbf{p}\Psi_1 \otimes \top$ .

Note that the operation LR used in Definition 2.55 satisfies the formulas for LR in Lemma 2.33.

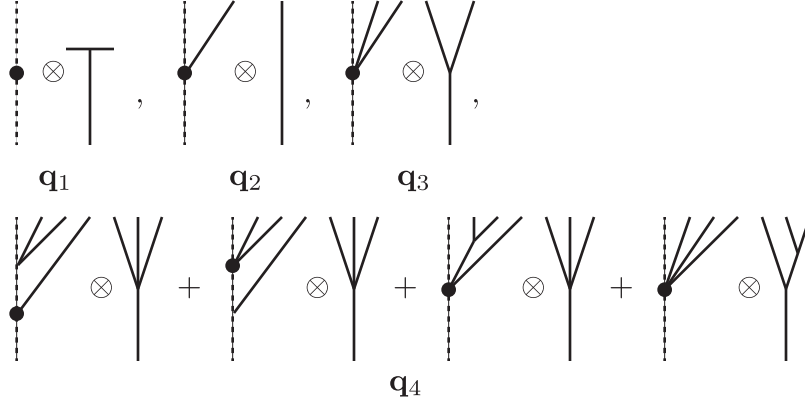

FIGURE 13. **The first few terms in a module-map primitive.** This module-map primitive is compatible with  $\mathbf{p}$  and  $\mathbf{p}$ , where  $\mathbf{p}$  is the module diagonal primitive of Figure 7.

**Lemma 2.58.** *Given any associahedron diagonal  $\Gamma$  and module diagonal primitives  $\mathbf{p}^1$  and  $\mathbf{p}^2$ , there is a module-map primitive  $\mathbf{q}$  compatible with  $\mathbf{p}^1$  and  $\mathbf{p}^2$ .*

*Proof.* This follows as in the proof of Proposition 1.8.  $\square$

**Definition 2.59.** *Given an associahedron tree diagonal, compatible module diagonal primitives  $\mathbf{p}^1$  and  $\mathbf{p}^2$ , and compatible module-map primitives  $\mathbf{q}^1$  and  $\mathbf{q}^2$ , a homotopy of module-map primitives is a linear combination of trees*

$$\xi_n \in \bigoplus_{i+j=n-1} \mathcal{T}_{n,i}^{MT} \otimes C_j^{\text{cell}}(K_n)$$

so that

$$\partial \xi_n + \text{LR}((\mathbf{p}^1)^{\otimes \bullet} \otimes \xi \otimes (\mathbf{p}^2)^{\otimes \bullet}) + \xi \circ' \gamma = \mathbf{q}^1 - \mathbf{q}^2.$$

Two module-map primitives are called homotopic if there exists a homotopy between them.

**Proposition 2.60.** *All module-map primitives compatible with  $\mathbf{p}^1$  and  $\mathbf{p}^2$  are homotopic.*

*Proof.* Construct the homotopy via the same inductive procedure used to prove Proposition 2.54, using Corollary 2.47 and contractibility of the associahedron (Proposition 2.10) to guarantee that the relevant homology groups vanish.  $\square$

In a special case, we can explicitly describe a module-map primitive in terms of a module diagonal primitive:

**Lemma 2.61.** *Let  $\mathbf{p}$  be a module diagonal primitive. Let  $\mathbf{q}_1 = \Psi_1 \otimes \top$  and for  $n \geq 2$ , let  $\mathbf{q}_n$  be the sum over  $(S, T)$  in  $\mathbf{p}_n$  of all pairs  $(S', T)$  where  $S'$  is obtained from  $S$  by making one internal vertex on the leftmost strand of  $S$  distinguished (purple). Then  $\mathbf{q}$  is a module-map primitive compatible with  $\mathbf{p}$  and  $\mathbf{p}$ .*

*Proof.* The differential  $\partial \mathbf{q}$  has four kinds of terms, based on the distinguished vertex in the left tree:

- (1) Terms appearing in  $\partial \mathbf{p}$  but with one internal vertex on the leftmost strand (of the left tree) distinguished.
- (2) Terms where there is a 2-valent distinguished vertex at the top or the bottom of the leftmost strand (of the left tree).
- (3) Terms where there is a 2-valent distinguished vertex on the leftmost strand (of the left tree), but not at the top or bottom.

The third kind of terms cancel in pairs. By the compatibility condition for  $\mathbf{p}$  (i.e., the right hand side of Equation (2.31)), the first and second types of terms are of the form on the right side of compatibility condition for  $\mathbf{q}$ , Equation (2.57). The other possible terms on the right of Equation (2.57) are of the form

$$\text{LR}((\mathbf{p})^{\otimes k} \otimes \mathbf{q}_1 \otimes (\mathbf{p})^{\otimes \ell})$$

where  $k$  and  $\ell$  are each  $\geq 1$ . Since the right tree of  $\mathbf{q}_1$  is a stump, however, these terms vanish.  $\square$

The relationship between module-map primitives and module-map diagonals is more complicated than the relationship between module diagonal primitives and module diagonals. To state it, we need an auxiliary notion:

**Definition 2.62.** Let  $\mathcal{F}_{\geq 3}\mathcal{T}_{n,*}^{MT} \subset \mathcal{T}_{n,*}^{MT}$  be the subspace spanned by module transformation trees in which the purple vertex has valence  $\geq 3$  (i.e., is not 2-valent). This is not a subcomplex of  $\mathcal{T}_{n,*}^{MT}$ . Let

$$g\mathcal{T}_{n,*}^{MT} = \mathcal{T}_{n,*}^{MT} / (\mathcal{F}_{\geq 3}\mathcal{T}_{n,*}^{MT} + \partial(\mathcal{F}_{\geq 3}\mathcal{T}_{n,*+1}^{MT})).$$

A partial module-map diagonal consists of elements

$$\mathbf{k}_n \in \bigoplus_{i+j=n-1} \mathcal{T}_{n,i}^{MT} \otimes g\mathcal{T}_{n,j}^{MT}$$

satisfying:

- **Compatibility:**

$$(2.63) \quad \partial(\mathbf{k}_n) - \sum_{k+\ell=n+1} \left( \mathbf{k}_k \circ_1 \mathbf{m}_\ell^1 + \mathbf{m}_k^2 \circ_1 \mathbf{k}_\ell + \sum_{i=2}^k \mathbf{k}_k \circ_i \gamma_\ell \right) = 0 \in \mathcal{T}_{n,*}^{MT} \otimes g\mathcal{T}_{n,*}^{MT}.$$

- **Non-degeneracy:**  $\mathbf{k}_1$  is the (unique) pair of module transformation trees with one input.

Partial module-map diagonals  $\mathbf{k}^1$  and  $\mathbf{k}^2$  are homotopic if there is a collection of elements  $\zeta_n \in \bigoplus_{i+j=n} \mathcal{T}_{n,i}^{MT} \otimes g\mathcal{T}_{n,j}^{MT}$  satisfying

$$(2.64) \quad \partial(\zeta_n) - \sum_{k+\ell=n+1} \left( \zeta_k \circ_1 \mathbf{m}_\ell^1 + \mathbf{m}_k^2 \circ_1 \zeta_\ell + \sum_{i=2}^k \zeta_k \circ_i \gamma_\ell \right) + \mathbf{k}_n^1 - \mathbf{k}_n^2 = 0 \in \mathcal{T}_{n,*}^{MT} \otimes g\mathcal{T}_{n,*}^{MT}.$$

Explicitly, elements of  $g\mathcal{T}_{n,*}^{MT}$  are module transformation trees where the purple vertex is 2-valent, and if two trees differ only in the location of the purple vertex they are equivalent in  $g\mathcal{T}_{n,*}^{MT}$ .

Given a module-map diagonal  $\ell$ , the image  $\mathbf{k}$  of  $\ell$  under the quotient map

$$\mathcal{T}^{MT} \otimes \mathcal{T}^{MT} \rightarrow \mathcal{T}^{MT} \otimes g\mathcal{T}^{MT}$$

is a partial module-map diagonal. In this case, we say that  $\ell$  is a module-map diagonal *extending*  $\mathbf{k}$ .

*Remark 2.65.* As we will see in Section 3.5, a partial module-map diagonal is the data needed to define  $\mathbb{I} \otimes g$ , the tensor product of the identity map of  $M$  and an arbitrary  $A_\infty$ -module map  $g: N \rightarrow N'$ .

**Lemma 2.66.** The complex  $g\mathcal{T}_{n,*}^{MT}$  is contractible, i.e., has homology  $R$  in dimension 0 and homology 0 in all other dimensions.

*Proof.* Forgetting the purple vertex gives an isomorphism between  $g\mathcal{T}_{n,*}^{MT}$  and  $C_*^{\text{cell}}(K_n)$ .  $\square$

**Lemma 2.67.** All partial module-map diagonals compatible with  $\mathbf{m}^1$  and  $\mathbf{m}^2$  are homotopic.

*Proof.* We build the maps  $\zeta_n$  satisfying Equation (2.64) inductively. Existence for  $n = 1$  is immediate from the non-degeneracy condition for partial module-map diagonals. For the inductive step, we claim that the element

$$(2.68) \quad \sum_{k+\ell=n+1} \left( \zeta_k \circ_1 \mathbf{m}_\ell^1 + \mathbf{m}_k^2 \circ_1 \zeta_\ell + \sum_{i=2}^k \zeta_k \circ_i \gamma_\ell \right) + \mathbf{k}_n^1 - \mathbf{k}_n^2$$

in  $\bigoplus_{i+j=n-1} \mathcal{T}_{n,i}^{MT} \otimes g\mathcal{T}_{n,j}^{MT}$  is a cycle. Indeed,

$$\begin{aligned} & \partial \left[ \sum_{k+\ell=n+1} \left( \zeta_k \circ_1 \mathbf{m}_\ell^1 + \mathbf{m}_k^2 \circ_1 \zeta_\ell + \sum_{i=2}^k \zeta_k \circ_i \gamma_\ell \right) + \mathbf{k}_n^1 - \mathbf{k}_n^2 \right] \\ &= \sum_{k+\ell=n+1} \left( (\alpha_k^1 + \partial\beta_k^1) \circ_1 \mathbf{m}_\ell^1 + \mathbf{m}_k^2 \circ_1 (\alpha_\ell^1 + \partial\beta_\ell^1) + \sum_{i=2}^k (\alpha_k^1 + \partial\beta_k^1) \circ_i \gamma_\ell \right) + \alpha_n^2 + \partial\beta_n^2 \end{aligned}$$

for some  $\alpha^1, \alpha^2, \beta^1, \beta^2 \in \mathcal{T}^{MT} \otimes \mathcal{F}_{\geq 3} \mathcal{T}^{MT}$ . The terms involving  $\alpha^1$  and  $\alpha^2$  are in  $\mathcal{F}_{\geq 3} \mathcal{T}_{n,*}^{MT}$ , and  $\partial\beta_n^2 \in \partial\mathcal{F}_{\geq 3} \mathcal{T}_{n,*+1}^{MT}$ . Further,

$$\left[ \sum_{k+\ell=n+1} \left( (\partial\beta_k^1) \circ_1 \mathbf{m}_\ell^1 + \mathbf{m}_k^2 \circ_1 (\partial\beta_\ell^1) + \sum_{i=2}^k (\partial\beta_k^1) \circ_i \gamma_\ell \right) \right] - \partial \left[ \sum_{k+\ell=n+1} \left( \beta_k^1 \circ_1 \mathbf{m}_\ell^1 + \mathbf{m}_k^2 \circ_1 \beta_\ell^1 + \sum_{i=2}^k \beta_k^1 \circ_i \gamma_\ell \right) \right]$$

lies in  $\mathcal{F}_{\geq 3} \mathcal{T}_{n,*}^{MT}$ , so

$$\left[ \sum_{k+\ell=n+1} \left( (\partial\beta_k^1) \circ_1 \mathbf{m}_\ell^1 + \mathbf{m}_k^2 \circ_1 (\partial\beta_\ell^1) + \sum_{i=2}^k (\partial\beta_k^1) \circ_i \gamma_\ell \right) \right] \in \mathcal{F}_{\geq 3} \mathcal{T}_{n,*}^{MT} + \partial\mathcal{F}_{\geq 3} \mathcal{T}_{n,*+1}^{MT}.$$

Thus, the element (2.68) is a cycle in  $\mathcal{T}_{n,*}^{MT} \otimes g\mathcal{T}_{n,*}^{MT}$ .

Since the element (2.68) is a cycle, from Corollary 2.47 and Lemma 2.66, it is therefore a boundary unless  $i = 0$  and  $j = 0$ , which only occurs for the base case  $n = 1$ . Define  $\zeta_n$  to be an element with boundary (2.68) and continue the induction.  $\square$

Next we use an analogue of the operation  $\text{LR}'$  from Definition 2.34 to build a partial module-map diagonal from a module-map primitive. Specifically, given a sequence  $(S_1, T_1), \dots, (S_k, T_k)$  of pairs of trees, with  $(S_i, T_i) \in \mathcal{T}_{n_i+1} \otimes \mathcal{T}_{n_i}$  for  $i \neq j$  and  $(S_j, T_j) \in \mathcal{T}_{n_j+1}^{MT} \otimes \mathcal{T}_{n_j}$  define

$$(2.69) \quad \text{LR}'((S_1, T_1), \dots, (S_k, T_k)) = \text{LeJ}(S_1, \dots, S_k) \otimes \text{RoJ}(\downarrow, T_1, \dots, T_k),$$

i.e., the obvious analogue of the definition of  $\text{LR}'$  used for module trees. Then  $\text{LR}'((S_1, T_1), \dots, (S_k, T_k))$  is the tensor product of a module transformation tree and an ordinary tree.

Note that this extension of  $\text{LR}'$  still satisfies Lemma 2.36.

We can turn  $\text{LR}'((S_1, T_1), \dots, (S_k, T_k))$  into a tensor product of two module transformation trees by adding a 2-valent purple vertex at the bottom of the right tree. When the inputs are module diagonal primitives and a module-map primitive, this gives a partial module diagonal:

**Lemma 2.70.** *Given an associahedron tree diagonal, compatible module diagonal primitives  $\mathbf{p}^1$  and  $\mathbf{p}^2$ , and a compatible module-map primitive  $\mathbf{q}$ ,*

$$(2.71) \quad \mathbf{k} = [\downarrow \otimes \mathbf{p}\Psi_1] \circ \text{LR}'((\mathbf{p}^1)^{\otimes \bullet} \otimes \mathbf{q} \otimes (\mathbf{p}^2)^{\otimes \bullet})$$

*is a partial module-map diagonal compatible with  $\mathbf{m}^1 = \text{LR}'((\mathbf{p}^1)^{\otimes \bullet})$  and  $\mathbf{m}^2 = \text{LR}'((\mathbf{p}^2)^{\otimes \bullet})$ .*

*Proof.* We have

$$\begin{aligned} & \partial([\downarrow \otimes \mathbf{p}\Psi_1] \circ \text{LR}'((\mathbf{p}^1)^{\otimes \bullet} \otimes \mathbf{q} \otimes (\mathbf{p}^2)^{\otimes \bullet})) \\ &= [\downarrow \otimes \mathbf{p}\Psi_1] \circ \left( \text{LR}'((\mathbf{p}^1)^{\otimes \bullet} \otimes (\partial\mathbf{p}^1) \otimes (\mathbf{p}^1)^{\otimes \bullet} \otimes \mathbf{q} \otimes (\mathbf{p}^2)^{\otimes \bullet}) + \text{LR}'((\mathbf{p}^1)^{\otimes \bullet} \otimes (\partial\mathbf{q}) \otimes (\mathbf{p}^2)^{\otimes \bullet}) \right. \\ & \quad + \text{LR}'((\mathbf{p}^1)^{\otimes \bullet} \otimes \mathbf{q} \otimes (\mathbf{p}^2)^{\otimes \bullet} \otimes (\partial\mathbf{p}^2) \otimes (\mathbf{p}^2)^{\otimes \bullet}) + \text{LR}'((\mathbf{p}^2)^{\otimes \bullet}) \circ_1 \text{LR}'((\mathbf{p}^1)^{\otimes \bullet} \otimes \mathbf{q} \otimes (\mathbf{p}^2)^{\otimes \bullet}) \\ & \quad + \text{LR}'((\mathbf{p}^1)^{\otimes \bullet} \otimes \mathbf{q} \otimes (\mathbf{p}^2)^{\otimes \bullet}) \circ_1 \text{LR}'((\mathbf{p}^1)^{\otimes \bullet}) + \text{LR}'((\mathbf{p}^1)^{\otimes \bullet} \otimes \text{LR}'((\mathbf{p}^1)^{\otimes \bullet} \otimes \mathbf{q} \otimes (\mathbf{p}^2)^{\otimes \bullet}) \otimes (\mathbf{p}^2)^{\otimes \bullet}) \\ & \quad + \text{LR}'((\mathbf{p}^1)^{\otimes \bullet} \otimes \text{LR}'((\mathbf{p}^1)^{\otimes \bullet}) \otimes (\mathbf{p}^1)^{\otimes \bullet} \otimes \mathbf{q} \otimes (\mathbf{p}^2)^{\otimes \bullet}) \\ & \quad \left. + \text{LR}'((\mathbf{p}^1)^{\otimes \bullet} \otimes \mathbf{q} \otimes (\mathbf{p}^2)^{\otimes \bullet} \otimes \text{LR}'((\mathbf{p}^2)^{\otimes \bullet}) \otimes (\mathbf{p}^2)^{\otimes \bullet}) \right) \\ &= [\downarrow \otimes \mathbf{p}\Psi_1] \circ \left( \text{LR}'((\mathbf{p}^1)^{\otimes \bullet} \otimes (\mathbf{p}^1 \circ \gamma) \otimes (\mathbf{p}^1)^{\otimes \bullet} \otimes \mathbf{q} \otimes (\mathbf{p}^2)^{\otimes \bullet}) + \text{LR}'((\mathbf{p}^1)^{\otimes \bullet} \otimes (\mathbf{q} \circ \gamma) \otimes (\mathbf{p}^2)^{\otimes \bullet}) \right) \end{aligned}$$

$$\begin{aligned}
& + \text{LR}'((\mathbf{p}^1)^{\otimes \bullet} \otimes \mathbf{q} \otimes (\mathbf{p}^2)^{\otimes \bullet} \otimes (\mathbf{p}^2 \circ \gamma) \otimes (\mathbf{p}^2)^{\otimes \bullet}) + \text{LR}'((\mathbf{p}^2)^{\otimes \bullet}) \circ_1 \text{LR}'((\mathbf{p}^1)^{\otimes \bullet} \otimes \mathbf{q} \otimes (\mathbf{p}^2)^{\otimes \bullet}) \\
& + \text{LR}'((\mathbf{p}^1)^{\otimes \bullet} \otimes \mathbf{q} \otimes (\mathbf{p}^2)^{\otimes \bullet}) \circ_1 \text{LR}'((\mathbf{p}^1)^{\otimes \bullet}) \\
& = \left( \sum_{i=2}^{\infty} \mathbf{k} \circ_i \gamma \right) + \mathbf{k} \circ_1 \mathbf{m}^1 + [\downarrow \otimes \mathbf{p}\Psi_1] \circ \mathbf{m}^2 \circ_1 \text{LR}'((\mathbf{p}^1)^{\otimes \bullet} \otimes \mathbf{q} \otimes (\mathbf{p}^2)^{\otimes \bullet})
\end{aligned}$$

where the first equality uses Lemma 2.36, the second uses the structure equations, and the third uses the definitions. So, we want to show that

$$[\downarrow \otimes \mathbf{p}\Psi_1] \circ_1 \mathbf{m}^2 \circ_1 \text{LR}'((\mathbf{p}^1)^{\otimes \bullet} \otimes \mathbf{q} \otimes (\mathbf{p}^2)^{\otimes \bullet}) - \mathbf{m}^2 \circ_1 [\downarrow \otimes \mathbf{p}\Psi_1] \circ_1 \text{LR}'((\mathbf{p}^1)^{\otimes \bullet} \otimes \mathbf{q} \otimes (\mathbf{p}^2)^{\otimes \bullet})$$

is of the form  $\partial \mathbf{s} + \mathbf{t}$  for some elements  $\mathbf{s}, \mathbf{t} \in \mathcal{T}_n^{MT} \otimes \mathcal{F}_{\geq 3} \mathcal{T}_n^{MT}$ . This is clear: the element  $\mathbf{s}$  is the sum of all ways of declaring one of the internal vertices in  $\mathbf{m}^2$  in  $\mathbf{m}^2 \circ_1 \text{LR}'((\mathbf{p}^1)^{\otimes \bullet} \otimes \mathbf{q} \otimes (\mathbf{p}^2)^{\otimes \bullet})$  to be purple.  $\square$

*Remark 2.72.* It is not clear whether the partial module-map diagonals constructed by Equation (2.71) can be extended to a full module-map diagonal. However, by Lemma 2.67, that partial module-map diagonal is homotopic to an extendible partial module-map diagonal.

## 2.8. DADD diagonals.

**Definition 2.73.** Fix associahedron diagonals  $\gamma^1$  and  $\gamma^2$ . A DADD diagonal compatible with  $\gamma^1$  and  $\gamma^2$  is a collection of chains

$$\mathbf{r}_n = \sum_{(S,T)} n_{S,T} (S,T) \in C_*^{\text{cell}}(J_n) \otimes \mathcal{T}_n$$

in dimension  $n-1$ , satisfying the following conditions:

- **Compatibility:**

$$(2.74) \quad \partial(\mathbf{r}_n) = \sum_{k+\ell=n+1} \mathbf{r}_k \circ \gamma_\ell^1 + \sum_{j_1+\dots+j_k=n} \gamma_k^2 \circ (\mathbf{r}_{j_1}, \dots, \mathbf{r}_{j_k}).$$

(The second term on the right hand side is the result of feeding the outputs of  $\mathbf{r}_{j_1}, \dots, \mathbf{r}_{j_k}$  into  $\gamma_k^2$ , analogous to Equation (2.6).)

- **Non-degeneracy:**  $\mathbf{r}_1 = \mathbf{p}\Psi_1 \otimes \downarrow$ , the tensor product of a 1-input purple corolla and the identity tree.

Schematically, the compatibility condition is:

$$(2.75) \quad \partial \left( \begin{array}{c} \downarrow \\ \mathbf{r} \\ \downarrow \\ \mathbf{r} \end{array} \right) = \left( \begin{array}{c} \downarrow \downarrow \\ \downarrow \downarrow \\ \downarrow \downarrow \\ \mathbf{r} \\ \downarrow \downarrow \\ \mathbf{r} \\ \downarrow \downarrow \\ \mathbf{r} \end{array} \right) + \left( \begin{array}{c} \downarrow \downarrow \\ \mathbf{r} \dots \mathbf{r} \\ \downarrow \downarrow \\ \gamma^2 \\ \downarrow \downarrow \\ \mathbf{r} \dots \mathbf{r} \\ \downarrow \downarrow \\ \gamma^2 \\ \downarrow \downarrow \\ \mathbf{r} \dots \mathbf{r} \\ \downarrow \downarrow \\ \mathbf{r} \dots \mathbf{r} \end{array} \right).$$

The first few terms in a particular DADD diagonal are shown in Figure 14.

**Lemma 2.76.** Given any pair of associahedron diagonals, there is a compatible DADD diagonal.

*Proof.* As usual, since the associahedron and multiplihedron are contractible, it suffices to verify:

- (1) The right hand side of the compatibility equation is a cycle.
- (2) Solutions to the compatibility equation exist when the right side is in dimension 0 (with respect to the usual grading on the tensor product  $C_*^{\text{cell}}(J_n) \otimes \mathcal{T}_n$ ).

The first statement is clear, particularly from the schematic version of the compatibility condition. The second corresponds to the cases  $\mathbf{r}_1$  and  $\mathbf{r}_2$ , which are shown in Figure 14.  $\square$

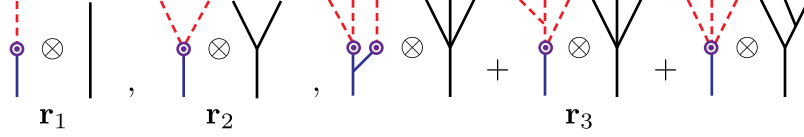

FIGURE 14. **The first few terms in a DADD diagonal.** This diagonal is compatible with the associahedron diagonal from Figure 3. The cases  $\mathbf{r}_1$ ,  $\mathbf{r}_2$ , and  $\mathbf{r}_3$  are shown.

The reader might notice a similarity between Figure 14 and the module diagonal primitive in Figure 7. This similarity is not coincidental, though a module diagonal primitive involves only one associahedron diagonal. Nonetheless, we have:

**Proposition 2.77.** *Fix a DADD diagonal  $\mathbf{r}_n$  compatible with  $\gamma^1$  and  $\gamma^2$ . Given a pair of trees  $(S, T) \in \mathbf{r}_n$ , call  $S$  unital if every blue vertex of  $S$  has valence 3. Given  $(S, T) \in \mathbf{r}_n$  with  $S$  unital, let  $S' \in \mathcal{T}_{n+1}$  be the result of deleting all of the blue edges and vertices from  $S$  and then running a new strand on the left through all of the purple vertices. Then*

$$\mathbf{p}_n := \sum_{\substack{(S, T) \in \mathbf{r}_n \\ S \text{ unital}}} (S', T)$$

is a module diagonal primitive compatible with  $\gamma^1$ .

The proof of Proposition 2.77 will use the following lemma:

**Lemma 2.78.** *Let  $\gamma$  be an associahedron diagonal. Then for each  $n \geq 2$  there are an odd number of pairs of trees  $(S, T)$  in  $\gamma$  where  $S$  is a binary tree. For each of these pairs of trees,  $T$  is the corolla  $\Psi_n$ .*

*Proof.* We will give an indirect argument, relying on material from Section 3.

Note that if  $S$  is binary then  $T$  must be a corolla for grading reasons. Observe that the diagonal from Example 2.21 has exactly one pair of trees  $(S, T)$  with  $S$  binary.

Now, consider the  $A_\infty$ -algebra  $\mathcal{A} = R\langle 1, a_1, \dots, a_n, b \rangle$  with the following nontrivial products:

$$\begin{aligned} \forall x \in \mathcal{A} : \mu_2(1, x) &= \mu_2(x, 1) = x \\ \mu_n(a_1, \dots, a_n) &= b. \end{aligned}$$

(All other products are 0.) Consider also the ordinary algebra  $\mathcal{B}$  generated by elements  $x_1, \dots, x_n$  with the relations  $x_i x_j = 0$  if  $j \neq i + 1$ . So, a basis for  $\mathcal{B}$  is in bijection with the set of intervals  $[k, \ell] \subset \{1, \dots, n\}$ , via  $[k, \ell] \leftrightarrow x_{[k, \ell]} = x_k x_{k+1} \dots x_\ell$ .

By Theorem 1.1, up to isomorphism, the  $A_\infty$ -algebra  $\mathcal{A} \otimes_\Gamma \mathcal{B}$  is independent of the choice of diagonal  $\Gamma$ . By nondegeneracy of  $\Gamma$ , the algebra  $\mathcal{A} \otimes_\Gamma \mathcal{B}$  has operations

$$\mu_2((1 \otimes x_{[k, \ell]}), (1 \otimes x_{[\ell, m]})) = 1 \otimes x_{[k, m]}.$$

If  $\gamma$  has an odd number of pairs  $(S, T)$  as in the statement of the lemma then  $\mathcal{A} \otimes_\Gamma \mathcal{B}$  has an  $A_\infty$  operation

$$\mu_n((a_1 \otimes x_1), \dots, (a_n \otimes x_n)) = b \otimes (x_1 \dots x_n).$$

Otherwise,  $\mathcal{A} \otimes_\Gamma \mathcal{B}$  has no higher  $A_\infty$  operations at all. In either case, these are the only nontrivial  $A_\infty$  operations. It is clear that there is no quasi-isomorphism between the two cases. This implies the result.  $\square$

*Proof of Proposition 2.77.* Given a pair of trees  $(S, T) \in C_*^{cell}(J_n) \otimes \mathcal{T}_n$ , let  $\Phi(S, T) = 0$  if  $S$  is not unital and let  $\Phi(S, T)$  be the result of deleting the blue vertices of  $S$  and running a new strand



through the purple vertices of the result if  $S$  is unital. Our goal is to show that the pairs of trees  $\Phi(\mathbf{r}_n)$  form a module diagonal primitive.

From the nondegeneracy condition for a DADD diagonal, we have that  $\mathbf{p}_2 = \Psi_2 \otimes \downarrow$ . It remains to verify that  $\mathbf{p}$  satisfies the compatibility condition for a module diagonal primitive, i.e., that

$$\partial \mathbf{p} = \text{LR}(\mathbf{p}^{\otimes \bullet}) + \mathbf{p} \circ' \gamma^1.$$

Of course, we will deduce this from the compatibility condition for  $\mathbf{r}$ .

First, we claim that  $\Phi(\partial(\mathbf{r}_n)) = \partial(\Phi(\mathbf{r}_n))$ . Consider first the pairs of trees  $(S, T)$  in  $\partial(\mathbf{r}_n)$  where  $S$  is unital. Such trees can arise either as the boundary of a pair  $(S', T')$  where  $S'$  is unital or from a pair  $(S', T')$  where  $S'$  has a single blue vertex with valence 4. The second kinds of terms occur in pairs, and the result of deleting the blue vertices from the two terms in the pair is the same. Also, taking the differential of a tree  $S$  at a purple vertex and then applying  $\Phi$  is the same as applying  $\Phi$  and then taking the differential at the corresponding vertex. These two observations prove that  $\Phi(\partial(\mathbf{r}_n)) = \partial(\Phi(\mathbf{r}_n))$ .

Next, observe that applying  $\Phi$  to the first term on the right of the DADD compatibility equation (Equation (2.74)) gives the second term on the right of the primitive compatibility equation (Equation (2.31)).

Finally, we claim that applying  $\Phi$  to the second term on the right of Equation (2.74) gives the first term on the right of Equation (2.31). Note that for  $(S, T) \in \gamma_k^2$ ,

$$\Phi((S, T) \circ (\mathbf{r}_{j_1}, \dots, \mathbf{r}_{j_k})) = 0$$

unless  $S$  is a binary tree. In this case, by Lemma 2.78, there are an odd number of such pairs of trees and  $T$  is a corolla. Given such a pair of trees,

$$\Phi((S, T) \circ (\mathbf{r}_{j_1}, \dots, \mathbf{r}_{j_k})) = \text{LR}(\mathbf{r}_{j_1}, \dots, \mathbf{r}_{j_k}).$$

This finishes the proof. □

### 3. APPLICATIONS OF DIAGONALS

**Convention 3.1.** *Throughout this section,  $R$  is a commutative  $\mathbb{F}_2$ -algebra (possibly graded) and  $\mathbb{k}$  (or  $\mathbb{k}_1, \mathbb{k}_2$ , etc.) is a free or, more generally, flat commutative  $R$ -algebra (again, possibly graded). All modules are assumed to be free or, more generally, projective over  $R$ . Further, the action of  $R$  on algebras and bimodules is central: if  $r \in R$  and  $a$  is an element of a  $R$ -algebra or bimodule, we assume that  $ra = ar$ .*

*In this section, undecorated tensor products are over whichever ring  $\mathbb{k}$  (or  $\mathbb{k}_i$ ) is relevant, and not over  $R$  or  $\mathbb{F}_2$ .*

**3.1. The  $dg$  category of chain complexes.** When talking about  $A_\infty$ -modules or type  $D$  structures, we find it convenient to use the language of  $dg$  categories (or more generally  $A_\infty$ -categories), so we spell out some of this terminology now. (See, for instance, Keller [Kel06] for a more extensive introduction.) Briefly, a  $dg$  category is a category enriched over chain complexes. That is, given objects  $M$  and  $N$  in a  $dg$  category  $\mathcal{C}$ , the space of morphisms  $\text{Mor}(M, N)$  between  $M$  and  $N$  is a chain complex, and composition is a chain map  $\text{Mor}(N, P) \otimes \text{Mor}(M, N) \rightarrow \text{Mor}(M, P)$ .

The first example of a  $dg$  category is the category of chain complexes itself, where the  $i^{\text{th}}$  graded part  $\text{Mor}_i(M, N)$  of  $\text{Mor}(M, N)$  consists of tuples of maps of abelian groups

$$\{f_k: M_k \rightarrow N_{k+i}\}_{k \in \mathbb{Z}},$$

and the differential is

$$d(f) = \partial \circ f + f \circ \partial.$$

In particular, the (degree 0) cycles in  $\text{Mor}(M, N)$  are the (degree 0) chain maps, and the boundaries are the nullhomotopic chain maps.

Below, we will work with the *dg* category of  $A_\infty$ -modules. The definition of this category is standard; see [LOT15, Section 2.2.2] for a brief review. We will also work with the  $A_\infty$ -category of type  $D$  structures; see [LOT15, Section 2.2.3] for the definition of this  $A_\infty$ -category and, for instance, Seidel [Sei02] for a discussion of  $A_\infty$ -categories in general.

We will typically use  $\text{Mor}$  to denote a chain complex of maps of  $\mathbb{k}$ -modules or bimodules; so, for instance, if  $\mathcal{A}$  is an  $A_\infty$ -algebra over  $\mathbb{k}$  then  $\text{Mor}(\mathcal{A}^{\otimes n}, \mathcal{A})$  is the chain complex of maps of (graded)  $\mathbb{k}$ -bimodules  $\mathcal{A}^{\otimes n} \rightarrow \mathcal{A}$ , with differential induced from  $\mu_1$  on  $\mathcal{A}$ . The complex  $\text{Mor}(\mathcal{A}^{\otimes n}, \mathcal{A})$  is an  $R$ -module.

**Convention 3.2.** *If  $C = \{C_d\}$  is a graded module then  $C\langle\langle n \rangle\rangle$  is the graded module*

$$C\langle\langle n \rangle\rangle_d = C_{d-n}.$$

*Thus the degree  $n$  part of  $\text{Mor}(M, N)$ , i.e., the morphisms sending  $M_d$  to  $N_{d+n}$ , is the same as degree 0 morphisms  $M \rightarrow N\langle\langle -n \rangle\rangle$  or  $M\langle\langle n \rangle\rangle \rightarrow N$ .*

**3.2. Tensor products of  $A_\infty$ -algebras.** Let  $A$  be a  $\mathbb{k}$ -bimodule, equipped with a differential  $\mu_1: A \rightarrow A\langle\langle 1 \rangle\rangle$ . A collection of functions  $\{\mu_d: A^{\otimes d} \rightarrow A\langle\langle 2-d \rangle\rangle\}_{d=2}^\infty$  can be extended to a collection of functions  $\{C_*^{\text{cell}}(K_n) \rightarrow \text{Mor}(A^{\otimes n}, A)\}$  by the following procedure. Given a tree  $T$  with  $n$  inputs (thought of as a cell of  $K_n$ ), replace each vertex with  $d > 0$  inputs by the operation  $\mu_d$ , and compose these operations as specified by the edges in  $T$ . Denote the induced function  $\mu(T): A^{\otimes n} \rightarrow A\langle\langle -\dim(T) \rangle\rangle$ . Extend linearly to linear combinations of trees to get a map  $\mu: C_d^{\text{cell}}(K_n) \rightarrow \text{Mor}_d(A^{\otimes n}, A)$ .

As above,  $\mu_1$  induces a differential on  $\text{Mor}(A^{\otimes n}, A)$ .

We say the operations  $\{\mu_d\}$  satisfy the  $A_\infty$ -algebra relations if for any  $n \geq 1$  and any  $a_1, \dots, a_n \in A$ ,

$$(3.3) \quad \sum_{k=0}^{n-1} \sum_{i=1}^{n-k} \mu_{n-k}(a_1 \otimes \dots \otimes a_{i-1} \otimes \mu_{k+1}(a_i \otimes \dots \otimes a_{i+k}) \otimes a_{i+k+1} \otimes \dots \otimes a_n) = 0.$$

The following reformulation of this condition is well known.

**Lemma 3.4.** *The collection  $\{\mu_n\}$  satisfies the  $A_\infty$ -algebra relations (3.3) if and only if for each  $n$  the map  $\mu: C_*^{\text{cell}}(K_n) \rightarrow \text{Mor}(A^{\otimes n}, A)$  is a chain map.*

*Proof.* The statement that  $\partial\mu(\Psi_n) = \mu(\partial\Psi_n)$  is exactly the  $A_\infty$ -algebra relation (3.3). To see that this implies that  $\mu$  is a chain map in general, observe that if  $\partial[\mu(S)] = \mu(\partial(S))$  and  $\partial[\mu(T)] = \mu(\partial(T))$  then

$$\begin{aligned} \partial[\mu(T \circ_i S)] &= \partial[\mu(T) \circ (\mathbb{I} \otimes \mu(S) \otimes \mathbb{I})] \\ &= (\partial[\mu(T)]) \circ (\mathbb{I} \otimes \mu(S) \otimes \mathbb{I}) + \mu(T) \circ (\mathbb{I} \otimes \partial[\mu(S)] \otimes \mathbb{I}) \\ &= (\mu(\partial(T))) \circ (\mathbb{I} \otimes \mu(S) \otimes \mathbb{I}) + \mu(T) \circ (\mathbb{I} \otimes \mu(\partial(S)) \otimes \mathbb{I}) \\ &= \mu(\partial(T) \circ_i S) + \mu(T \circ_i \partial(S)) = \mu(\partial(T \circ_i S)). \end{aligned}$$

Since any tree can be written as a composition of corollas, the result follows.  $\square$

A collection of chain maps  $\mu: C_*^{\text{cell}}(K_n) \rightarrow \text{Mor}(A^{\otimes n}, A)$  specifies an  $A_\infty$ -algebra homomorphism if and only if it is compatible with composition (stacking of trees). In other words, an  $A_\infty$ -algebra is a module over the associahedron operad.

**Definition 3.5.** *An  $A_\infty$ -algebra over  $\mathbb{k}$  is a *dg*  $\mathbb{k}$ -bimodule  $(A, \mu_1)$  together with operations  $\mu_n: A^{\otimes n} \rightarrow A$ ,  $n \geq 2$ , satisfying the  $A_\infty$ -algebra relations.*

When studying type  $DD$  structures below, we will find it convenient to equip our  $A_\infty$ -algebras with a unit. An  $A_\infty$ -algebra  $\mathcal{A} = (A, \{\mu_n\})$  is *strictly unital* if there is an element  $\mathbf{1} \in A$  so that  $\mu_2(\mathbf{1}, a) = \mu_2(a, \mathbf{1}) = a$  for all  $a \in A$  and  $\mu_n(a_1, \dots, a_n) = 0$  if  $n \neq 2$  and some  $a_i = \mathbf{1}$ . See also Definition 3.78. There is further discussion of units in Section 3.7.

The following is a rephrasing of a definition of Sanedlidze-Umble [SU04, Definition 30].

**Definition 3.6.** Fix an associahedron diagonal  $\Gamma$ . Given  $A_\infty$ -algebras  $\mathcal{A}_1 = (A_1, \{\mu_n^1\})$  and  $\mathcal{A}_2 = (A_2, \{\mu_n^2\})$  over  $\mathbb{k}_1$  and  $\mathbb{k}_2$ , let  $\mathcal{A}_1 \otimes_\Gamma \mathcal{A}_2$  be the dg bimodule  $A_1 \otimes_R A_2$  over  $\mathbb{k} = \mathbb{k}_1 \otimes_R \mathbb{k}_2$ , which we endow with an  $A_\infty$ -algebra structure over  $\mathbb{k}$  via the maps

$$\begin{aligned} C_*^{\text{cell}}(K_n) &\xrightarrow{\Gamma_n} C_*^{\text{cell}}(K_n) \otimes_R C_*^{\text{cell}}(K_n) \\ &\xrightarrow{\mu_n^1 \otimes \mu_n^2} \text{Mor}(A_1^{\otimes n}, A_1) \otimes_R \text{Mor}(A_2^{\otimes n}, A_2) \hookrightarrow \text{Mor}((A_1 \otimes_R A_2)^{\otimes n}, A_1 \otimes_R A_2) \end{aligned}$$

(compare Lemma 3.4). The compatibility of the diagonal  $\Gamma$  under stacking implies that this map  $C_*^{\text{cell}}(K_n) \rightarrow \text{Mor}((A_1 \otimes_R A_2)^{\otimes n}, A_1 \otimes_R A_2)$  is induced by its values on corollas.

Explicitly, if  $\gamma = \sum n_i(S_i, T_i)$  is the associahedron tree diagonal corresponding to  $\Gamma$  then the operation  $(\mu^1 \otimes_\Gamma \mu^2)_n$  on  $\mathcal{A}_1 \otimes_\Gamma \mathcal{A}_2$  is defined by

$$(3.7) \quad (\mu^1 \otimes_\Gamma \mu^2)_n((a_1 \otimes b_1) \otimes \cdots \otimes (a_n \otimes b_n)) = \sum_i n_i [\mu^1(S_i)(a_1 \otimes \cdots \otimes a_n)] \otimes [\mu^2(T_i)(b_1 \otimes \cdots \otimes b_n)].$$

**Lemma 3.8.** With notation as above, the maps  $\mu^1 \otimes_\Gamma \mu^2$  form an  $A_\infty$ -algebra.

*Proof.* The map  $\mu^1 \otimes_\Gamma \mu^2$  is defined as a composition of chain maps, and so is a chain map. So, it follows from compatibility of  $\Gamma$  under stacking that  $\mu^1 \otimes_\Gamma \mu^2$  specifies an  $A_\infty$ -algebra.  $\square$

Later, we will shorthand the right side of Formula (3.7) as

$$(3.9) \quad \begin{array}{cc} \Downarrow & \Downarrow \\ \gamma & \gamma \\ \Downarrow & \Downarrow \end{array}$$

We turn next to maps of  $A_\infty$ -algebras.

**Definition 3.10.** Fix  $A_\infty$ -algebras  $\mathcal{A}$  and  $\mathcal{B}$  over  $\mathbb{k}$ . We say that a collection of degree 0  $\mathbb{k}$ -bimodule maps  $f = \{f_n: A^{\otimes n} \rightarrow B\langle\langle 1-n \rangle\rangle\}_{n=1}^\infty$  is an  $A_\infty$ -algebra homomorphism if for each  $n$  and each sequence of elements  $a_1, \dots, a_n \in A$ , the maps  $f_k$  satisfy

$$(3.11) \quad \begin{aligned} \sum_{k=1}^{n-1} \sum_{i=1}^{n-k} f_{n-k}(a_1 \otimes \cdots \otimes a_{i-1} \otimes \mu_{k+1}^A(a_1 \otimes \cdots \otimes a_{k+i}) \otimes a_{k+i+1} \otimes \cdots \otimes a_n) \\ + \sum_{n=m_1+\cdots+m_k} \mu_k^B(f_{m_1}(a_1 \otimes \cdots \otimes a_{m_1}) \otimes \cdots \otimes f_{m_k}(a_{m_1+\cdots+m_{k-1}+1} \otimes \cdots \otimes a_n)) = 0. \end{aligned}$$

Given  $A_\infty$ -algebra homomorphisms  $f: \mathcal{A} \rightarrow \mathcal{B}$  and  $g: \mathcal{B} \rightarrow \mathcal{C}$ , their composition is a map  $g \circ f$ , defined by

$$(g \circ f)_n(a_1, \dots, a_n) = \sum_{k=1}^n \sum_{i_1+\cdots+i_k=n} g_k(f_{i_1}(a_1, \dots, a_{i_1}), f_{i_2}(a_{i_1+1}, \dots, a_{i_1+i_2}), \dots, f_{i_k}(a_{i_1+\cdots+i_{k-1}+1}, \dots, a_n)).$$

The identity map of  $\mathcal{A}$  is defined by  $(\mathbb{I}_A)_1 = \mathbb{I}_A$  and  $(\mathbb{I}_A)_n = 0$  for  $n \neq 1$ . A homomorphism  $f: \mathcal{A} \rightarrow \mathcal{B}$  is an isomorphism if there is a homomorphism  $g: \mathcal{B} \rightarrow \mathcal{A}$  so that  $g \circ f = \mathbb{I}_A$  and  $f \circ g = \mathbb{I}_B$ .

An  $A_\infty$ -algebra homomorphism  $f$  is a quasi-isomorphism if the chain map  $f_1$  is a quasi-isomorphism.

Recall from Section 2.5 that  $J_n$  denotes the multiplihedron, a CW complex whose cells correspond to transformation trees. A collection of maps  $\{f_n: A^{\otimes n} \rightarrow B\langle\langle 1-n \rangle\rangle\}_{n=1}^\infty$  can be extended to a give a map

$$\phi: C_d^{\text{cell}}(J_n) \rightarrow \text{Mor}_d(A^{\otimes n}, B)$$

as follows. Given a transformation tree  $T$ , replace each red vertex of  $T$  with  $k$  inputs by the operation  $\mu_k^A$ , each blue vertex of  $T$  with  $k$  inputs by the operation  $\mu_k^B$  and each purple vertex of  $T$  with  $k$  inputs by the function  $f_k$ . Compose these operations as specified by the edges of  $T$ . We denote the induced function by  $f(T): A^{\otimes n} \rightarrow B$ . The analogue of Lemma 3.4 is:

**Lemma 3.12.** *The collection  $\{f_n\}$  satisfies the  $A_\infty$ -algebra homomorphism relations (3.11) if and only if for each  $n$ , the map  $f: C_*^{\text{cell}}(J_n) \rightarrow \text{Mor}(A^{\otimes n}, B)$  is a chain map.*

The proof is similar to the proof of Lemma 3.4, and is left to the reader.

The following is the analogue of Definition 3.6:

**Definition 3.13.** *Fix associahedron diagonals  $\Gamma_1$  and  $\Gamma_2$  and a multiplihedron diagonal  $\Theta$  compatible with  $\Gamma_1$  and  $\Gamma_2$ . Let  $\mathcal{A}_1 = (A_1, \{\mu_n^{A_1}\})$  and  $\mathcal{B}_1 = (B_1, \{\mu_n^{B_1}\})$  be  $A_\infty$ -algebras over  $\mathbb{k}_1$ ,  $\mathcal{A}_2 = (A_2, \{\mu_n^{A_2}\})$  and  $\mathcal{B}_2 = (B_2, \{\mu_n^{B_2}\})$  be  $A_\infty$ -algebras over  $\mathbb{k}_2$ , and  $f^1 = \{f_n^1: A_1^{\otimes n} \rightarrow B_1\}$  and  $f^2 = \{f_n^2: A_2^{\otimes n} \rightarrow B_2\}$  be  $A_\infty$ -algebra homomorphisms. Define a map*

$$(f^1 \otimes_{\Theta} f^2): C_*^{\text{cell}}(J_n) \rightarrow \text{Mor}((A_1 \otimes_R A_2)^{\otimes n}, (B_1 \otimes_R B_2))$$

to be the composition

$$\begin{aligned} C_*^{\text{cell}}(J_n) &\xrightarrow{\Theta} C_*^{\text{cell}}(J_n) \otimes_R C_*^{\text{cell}}(J_n) \\ &\xrightarrow{f^1 \otimes_{\Theta} f^2} \text{Mor}(A_1^{\otimes n}, B_1) \otimes_R \text{Mor}(A_2^{\otimes n}, B_2) \hookrightarrow \text{Mor}(A_1^{\otimes n} \otimes A_2^{\otimes n}, B_1 \otimes B_2). \end{aligned}$$

Explicitly, in terms of trees, if we write  $\theta = \sum_i n_i(S_i, T_i)$  (where  $n_i \in R$  and  $S_i$  and  $T_i$  are transformation trees) then

$$(f^1 \otimes_{\Theta} f^2)_n((a_1 \otimes a'_1) \otimes \cdots \otimes (a_n \otimes a'_n)) = \sum_i n_i [f_n^1(S_i)(a_1 \otimes \cdots \otimes a_n)] \otimes [f_n^2(T_i)(a'_1 \otimes \cdots \otimes a'_n)].$$

**Lemma 3.14.** *With notation as above, the maps  $f_1 \otimes_{\Theta} f_2$  form an  $A_\infty$ -algebra homomorphism from  $\mathcal{A}_1 \otimes_{\Gamma_1} \mathcal{A}_2$  to  $\mathcal{B}_1 \otimes_{\Gamma_2} \mathcal{B}_2$ .*

*Proof.* This follows from Lemma 3.12. The map  $f_1 \otimes_{\Theta} f_2$  is defined as a composition of chain maps, and so is a chain map. Compatibility with stacking (composition of trees) is immediate from the definition and the fact that  $\Theta$  is compatible with  $\Gamma_1$  and  $\Gamma_2$ .  $\square$

Before proving Theorem 1.1, we recall an equivalent definition of isomorphisms of  $A_\infty$ -algebras:

**Lemma 3.15.** *[LOT15, Lemma 2.1.14] A homomorphism  $f: \mathcal{A} \rightarrow \mathcal{B}$  of  $A_\infty$ -algebras is an isomorphism (i.e., has an inverse  $g: \mathcal{B} \rightarrow \mathcal{A}$  so that  $f \circ g = \mathbb{I}_{\mathcal{B}}$  and  $g \circ f = \mathbb{I}_{\mathcal{A}}$ ) if and only if  $f_1: A \rightarrow B$  is an isomorphism of  $\mathbb{k}$ -bimodules.*

(The proof is to use invertibility of  $f_1$  to inductively construct the inverse  $g$ .)

*Proof of Theorem 1.1.* Existence of associahedron diagonals was verified in Lemma 2.20. It remains to verify the rest of the theorem.

Lemma 3.8 states that  $\mathcal{A}_1 \otimes_{\Gamma} \mathcal{A}_2$  is an  $A_\infty$ -algebra. By definition, the underlying  $R$ -module of  $\mathcal{A}_1 \otimes_{\Gamma} \mathcal{A}_2$  is  $A_1 \otimes A_2$  (point (A1)).

For point (A2), note that the non-degeneracy condition implies that  $\mu_2$  is the usual multiplication on  $\mathcal{A}_1 \otimes \mathcal{A}_2$ . For  $n > 2$ , if  $(S, T)$  corresponds to an  $(n-2)$ -cell of  $K_n \times K_n$  then one of  $S$  or  $T$  has a vertex with 3 or more inputs. It follows that, if  $\mathcal{A}_1$  and  $\mathcal{A}_2$  are  $dg$  algebras, the higher multiplications on  $\mathcal{A}_1 \otimes_{\Gamma} \mathcal{A}_2$  vanish.

We will prove points (A3) and (A5) together. So, fix  $A_\infty$ -algebras  $\mathcal{A}_1, \mathcal{A}_2, \mathcal{A}'_1$  and  $\mathcal{A}'_2$  and associahedron diagonals  $\Gamma_1$  and  $\Gamma_2$ . Suppose that  $f^1: \mathcal{A}_1 \rightarrow \mathcal{A}'_1$  and  $f^2: \mathcal{A}_2 \rightarrow \mathcal{A}'_2$  are  $A_\infty$ -quasi-isomorphisms. Fix a multiplihedron diagonal  $\Theta$  compatible with  $\Gamma_1$  and  $\Gamma_2$ ; such a  $\Theta$  exists by Lemma 2.46. Lemma 3.14 then gives an  $A_\infty$ -algebra homomorphism

$$f^1 \otimes_{\Theta} f^2: \mathcal{A}_1 \otimes_{\Gamma_1} \mathcal{A}_2 \rightarrow \mathcal{A}'_1 \otimes_{\Gamma_2} \mathcal{A}'_2.$$

To see that this is a quasi-isomorphism, note that the non-degeneracy condition on  $\Theta$  implies that

$$(f^1 \otimes_{\Theta} f^2)_1 = (f^1_1 \otimes f^2_1): A_1 \otimes_R A_2 \rightarrow A'_1 \otimes_R A'_2,$$

and since  $f_1^1$  and  $f_1^2$  induce isomorphisms on homology, and the  $A_i$  and  $A'_i$  are flat over  $R$ , so does  $f_1^1 \otimes f_1^2$ . Point (A3) corresponds to the special case that  $\Gamma_1 = \Gamma_2$  and Point (A5) corresponds to the special case that  $\mathcal{A}_1 = \mathcal{A}'_1$  and  $\mathcal{A}_2 = \mathcal{A}'_2$  and the  $f_i$  are the identity maps. For Point (A5), it follows from the non-degeneracy condition for multiplihedron diagonals and Lemma 3.15 that  $(f^1 \otimes_{\Theta} f^2)$  is not just a quasi-isomorphism but an isomorphism.

Finally, to prove point (A4) (associativity), one defines an *associahedron double-diagonal* to be a collection of maps

$$\mathbf{\Gamma}\Gamma_n: C_*^{cell}(K_n) \rightarrow C_*^{cell}(K_n) \otimes_R C_*^{cell}(K_n) \otimes_R C_*^{cell}(K_n)$$

satisfying

$$\mathbf{\Gamma}\Gamma_n \circ \phi_{i,j}^n = (\phi_{i,j}^n \otimes \phi_{i,j}^n \otimes \phi_{i,j}^n) \circ (\mathbf{\Gamma}\Gamma_{j-i+1} \otimes \mathbf{\Gamma}\Gamma_{n+i-j}),$$

and with  $\mathbf{\Gamma}\Gamma_2$  the standard isomorphism from  $C_*^{cell}(pt) \cong C_*^{cell}(pt) \otimes_R C_*^{cell}(pt) \otimes_R C_*^{cell}(pt)$ . (Recall that  $\phi_{i,j}^n$  is the face inclusion of the associahedron; see Formula (2.12).) Then:

- (1) Both  $(\mathbf{\Gamma} \otimes \mathbb{I}) \circ \mathbf{\Gamma}$  and  $(\mathbb{I} \otimes \mathbf{\Gamma}) \circ \mathbf{\Gamma}$  are associahedron double-diagonals.
- (2) An associahedron double-diagonal is exactly what one needs to define the triple tensor product  $(\mathcal{A}_1 \otimes \mathcal{A}_2 \otimes \mathcal{A}_3)_{\mathbf{\Gamma}\Gamma}$ . For the two associahedron diagonals in point (1), the triple tensor products are  $(\mathcal{A}_1 \otimes_{\mathbf{\Gamma}} \mathcal{A}_2) \otimes_{\mathbf{\Gamma}} \mathcal{A}_3$  and  $\mathcal{A}_1 \otimes_{\mathbf{\Gamma}} (\mathcal{A}_2 \otimes_{\mathbf{\Gamma}} \mathcal{A}_3)$ , respectively.
- (3) Any two associahedron double-diagonals are related by a *multiplihedron double-diagonal*. This is the analogue of Lemma 2.46, and uses the obvious analogue of Definition 2.44.

Given this, the proof of associativity follows along the same lines as the proof of independence from the associahedron diagonals.  $\square$

*Remark 3.16.* Associativity of the tensor product can hold only up to isomorphism, in general, according to a result of Markl and Shnider [MS06, Theorem 6.1].

In Section 3.4, some boundedness properties of our algebra  $\mathcal{A}$  will be relevant. In previous papers [LOT18, LOT15], we called an  $A_\infty$ -algebra  $(A, \{\mu_i\})$  *operationally bounded* if there exists an  $N$  so that  $\mu_i = 0$  for all  $i > N$ . This property seems not to be preserved by tensor products, but the following stronger property is.

**Definition 3.17.** *An  $A_\infty$ -algebra  $\mathcal{A} = (A, \{\mu_i\})$  is *bonsai* if there is an integer  $N$  so that for any associahedron tree  $T$  with  $\dim(T) > N$ , we have  $\mu(T) = 0$ . An  $A_\infty$ -algebra homomorphism  $f: \mathcal{A} \rightarrow \mathcal{B}$  is *bonsai* if there is an integer  $N$  so that for any multiplihedron tree  $T$  with  $\dim(T) > N$ , we have  $f(T) = 0$ . We will sometimes call such an  $N$  a *bonsai constant* of  $\mathcal{A}$ .*

Since  $\Psi_n$  has dimension  $n - 2$ , being bonsai implies being operationally bounded.

**Lemma 3.18.** *For any associahedron diagonal  $\mathbf{\Gamma}$ , if  $\mathcal{A}_1$  and  $\mathcal{A}_2$  are bonsai then so is  $\mathcal{A}_1 \otimes_{\mathbf{\Gamma}} \mathcal{A}_2$ . Similarly, for any associahedron diagonals  $\mathbf{\Gamma}_1$  and  $\mathbf{\Gamma}_2$  and compatible multiplihedron diagonal  $\Theta$ , if  $\mathcal{A}_i, \mathcal{B}_i$ , and  $f^i: \mathcal{A}_i \rightarrow \mathcal{B}_i$  are bonsai for  $i = 1, 2$  then  $f^1 \otimes_{\Theta} f^2$  is bonsai.*

*Proof.* This is immediate from the fact that  $\mathbf{\Gamma}$  (respectively  $\Theta$ ) preserves the grading (dimension).  $\square$

(We will relax this and other boundedness assumptions in Section 9.)

**3.3. Tensor products of  $A_\infty$ -modules.** We turn next to modules. Throughout this section we will focus on right modules; analogous statements hold for left modules, using left module diagonals.

Let  $\mathcal{A} = (A, \{\mu_d\})$  be an  $A_\infty$ -algebra over  $\mathbb{k}$ , and let  $(M, m_1: M \rightarrow M\langle\langle 1 \rangle\rangle)$  be a right  $dg$  module over  $\mathbb{k}$ . A collection of functions  $\{m_{d+1}: M \otimes A^{\otimes d} \rightarrow M\langle\langle 1 - d \rangle\rangle\}_{d=1}^\infty$  can be extended to a collection of functions  $C_d^{cell}(K_{n+1}) \rightarrow \text{Mor}_d(M \otimes A^{\otimes n}, M)$  by the following procedure. Given a tree  $T$  with  $n$  inputs (thought of as a cell of  $K_n$ ), we replace each vertex on the leftmost strand of  $T$  with  $d > 1$  inputs by  $m_d$  and each vertex not on the leftmost strand of  $T$  with  $d > 1$  inputs by  $\mu_d$ ,

and compose these operations as specified by the edges in  $T$ . We denote the induced function  $m(T): M \otimes A^{\otimes n} \rightarrow M\langle\langle -\dim(T) \rangle\rangle$ . Extending linearly to linear combinations of trees we get a map  $m: C_*^{\text{cell}}(K_{n+1}) \rightarrow \text{Mor}(M \otimes A^{\otimes n}, M)$ .

If  $(M, m_1)$  is a differential  $\mathbb{k}$ -module then there is an induced differential on  $\text{Mor}(M \otimes A^{\otimes n}, M)$ , incorporating both the differential on  $M$  and on  $A$ .

We say the operations  $\{m_d\}$  satisfy the  $A_\infty$ -module relations if for any  $n \geq 0$ , any  $x \in M$  and any  $a_1, \dots, a_n \in A$ ,

$$(3.19) \quad 0 = \sum_{k=0}^n m_{n-k+1}(m_{k+1}(x \otimes a_1 \otimes \cdots \otimes a_k) \otimes a_{k+1} \otimes \cdots \otimes a_n) \\ + \sum_{k=0}^n \sum_{i=1}^{n-k} m_{n-k+1}(x \otimes \cdots \otimes a_{i-1} \otimes \mu_{k+1}(a_i \otimes \cdots \otimes a_{i+k}) \otimes a_{i+k+1} \otimes \cdots \otimes a_n).$$

**Lemma 3.20.** *The collection  $\{m_d\}$  satisfies the  $A_\infty$ -module relations if and only if the map  $m: C_*^{\text{cell}}(K_{n+1}) \rightarrow \text{Mor}(M \otimes A^{\otimes n}, M)$  is a chain map.*

*Proof.* The proof is similar to the proof of Lemma 3.4 and is left to the reader.  $\square$

**Definition 3.21.** *Let  $\mathcal{A}_i$ ,  $i = 1, 2$ , be an  $A_\infty$ -algebra over  $\mathbb{k}_i$  and let  $\mathcal{M}_i = (M_i, \{m_{n+1}^i\})$ ,  $i = 1, 2$ , be a right  $A_\infty$ -module over  $\mathcal{A}_i$ . Fix an associahedron diagonal  $\mathbf{\Gamma}$  and a module diagonal  $\mathbf{M}$  compatible with  $\mathbf{\Gamma}$ . Then we can endow  $M_1 \otimes_R M_2$  with the structure of a right  $A_\infty$ -module over  $\mathcal{A}_1 \otimes_{\mathbf{\Gamma}} \mathcal{A}_2$  via the maps*

$$C_*^{\text{cell}}(K_{n+1}) \xrightarrow{\mathbf{M}_{n+1}} C_*^{\text{cell}}(K_{n+1}) \otimes_R C_*^{\text{cell}}(K_{n+1}) \\ \xrightarrow{m_{n+1}^1 \otimes m_{n+1}^2} \text{Mor}(M_1 \otimes \mathcal{A}_1^{\otimes n}, M_1) \otimes_R \text{Mor}(M_2 \otimes \mathcal{A}_2^{\otimes n}, M_2) \\ \hookrightarrow \text{Mor}((M_1 \otimes_R M_2) \otimes (\mathcal{A}_1 \otimes_R \mathcal{A}_2)^{\otimes n}, M_1 \otimes_R M_2)$$

(compare Definition 3.6). Let  $\mathcal{M}_1 \otimes_{\mathbf{M}} \mathcal{M}_2$  denote this  $A_\infty$ -module.

Explicitly, if  $\mathbf{m} = \sum n_i(S_i, T_i)$  is the linear combination of trees corresponding to  $\mathbf{M}$  then the operation  $m_{n+1}$  on  $\mathcal{M}_1 \otimes_{\mathbf{M}} \mathcal{M}_2$  is given by

$$m_{n+1}((x \otimes y) \otimes (a_1 \otimes b_1) \otimes \cdots \otimes (a_n \otimes b_n)) \\ = \sum_i n_i [m^1(S_i)(x \otimes a_1 \otimes \cdots \otimes a_n)] \otimes [m^2(T_i)(y \otimes b_1 \otimes \cdots \otimes b_n)].$$

Similarly, we can use module-map diagonals to define tensor products of  $A_\infty$ -module homomorphisms. We start by recalling some definitions, and an analogue of Lemma 3.12. Fix an  $A_\infty$ -algebra  $\mathcal{A}$  and  $A_\infty$ -modules  $\mathcal{M}$  and  $\mathcal{N}$  over  $\mathcal{A}$ . An  $A_\infty$ -morphism from  $\mathcal{M}$  to  $\mathcal{N}$  is a collection of maps

$$f_{1+n}: M \otimes A^{\otimes n} \rightarrow N\langle\langle -n \rangle\rangle.$$

Let  $\text{Mor}(\mathcal{M}, \mathcal{N})$  denote the set of  $A_\infty$ -morphisms from  $\mathcal{M}$  to  $\mathcal{N}$ . We define a differential on  $\text{Mor}(\mathcal{M}, \mathcal{N})$  by

$$(3.22) \quad d(f)(x \otimes a_1 \otimes \cdots \otimes a_n) \\ = \sum_{j=0}^n f_{1+n-j}(m_{1+j}^M(x \otimes a_1 \otimes \cdots \otimes a_j) \otimes a_{j+1} \otimes \cdots \otimes a_n) \\ + \sum_{j=0}^n m_{1+j}^N(f_{1+n-j}(x \otimes a_1 \otimes \cdots \otimes a_{n-j}) \otimes a_{n-j+1} \otimes \cdots \otimes a_n) \\ + \sum_{1 \leq i \leq j \leq n} f_{1+n-j+i}(x \otimes a_1 \otimes \cdots \otimes a_{i-1} \otimes \mu_{j-i+1}(a_i \otimes \cdots \otimes a_j) \otimes a_{j+1} \otimes \cdots \otimes a_n)$$

(where  $f = \{f_{1+n}\}$ ).



Recall that  $\mathcal{T}_n^{MT}$  denotes the chain complex of module transformation trees with 1 module input and  $n-1$  algebra inputs. (The complex  $\mathcal{T}_n^{MT}$  is isomorphic to  $C_*^{cell}(K_{n+1})$ .) We get an induced map  $F_f: \mathcal{T}_{n+1,d}^{MT} \rightarrow \text{Mor}_d(M \otimes A^{\otimes n}, M)$  by replacing the distinguished vertex in each module transformation tree by  $f$ , replacing the other internal vertices on the left-most strand by  $m^M$  or  $m^N$  depending on whether they come above or below the distinguished vertex, replacing all other internal vertices by  $\mu$ , and composing these maps according to the tree.

**Lemma 3.23.** *The association  $f \mapsto F_f$  is a chain map. That is,*

$$(3.24) \quad F_{d(f)} = d(F_f) = F_f \circ \partial_{\mathcal{T}_{n+1}^{MT}}^{cell} + \partial^{\text{Mor}} \circ F_f.$$

*Proof.* As in the proof of Lemma 3.4, it suffices to verify that

$$(3.25) \quad F_{d(f)}(\Psi_{n+2})(x \otimes a_1 \otimes \cdots \otimes a_n) = d(F_f)(\Psi_{n+2})(x \otimes a_1 \otimes \cdots \otimes a_n).$$

The left side of Formula (3.25) is given by Formula (3.22). After expanding the right side of Formula (3.25) by Formula (3.24), the second term contributes the terms in Formula (3.22) involving  $m_1^M$ ,  $m_1^N$  or  $\mu_1$ , and the first term contributes the remaining terms in Formula (3.22).  $\square$

**Definition 3.26.** *Fix an associahedron diagonal  $\Gamma$ , module diagonals  $\mathbf{M}^1$  and  $\mathbf{M}^2$  compatible with  $\Gamma$ , and a module-map diagonal  $\mathbf{L}$  compatible with  $\mathbf{M}^1$  and  $\mathbf{M}^2$ . Suppose that  $\mathcal{M}_1$  and  $\mathcal{M}_2$  are  $A_\infty$ -modules over an  $A_\infty$ -algebra  $\mathcal{A}$  and  $\mathcal{N}_1$  and  $\mathcal{N}_2$  are  $A_\infty$ -modules over an  $A_\infty$ -algebra  $\mathcal{B}$ , and  $f \in \text{Mor}(\mathcal{M}_1, \mathcal{M}_2)$  and  $g \in \text{Mor}(\mathcal{N}_1, \mathcal{N}_2)$  are morphisms in the dg category of  $A_\infty$ -modules. Then there is a corresponding morphism  $(f \otimes_{\mathbf{L}} g) \in \text{Mor}(\mathcal{M}_1 \otimes_{\mathbf{M}^1} \mathcal{N}_1, \mathcal{M}_2 \otimes_{\mathbf{M}^2} \mathcal{N}_2)$  so that  $F_{f \otimes_{\mathbf{L}} g}$  is the composition*

$$(3.27) \quad \begin{aligned} \mathcal{T}_{n+1}^{MT} &\xrightarrow{\mathbf{L}} \mathcal{T}_{n+1}^{MT} \otimes_R \mathcal{T}_{n+1}^{MT} \\ &\xrightarrow{F_f \otimes F_g} \text{Mor}(M_1 \otimes A^{\otimes n}, M_2) \otimes_R \text{Mor}(N_1 \otimes B^{\otimes n}, N_2) \\ &\hookrightarrow \text{Mor}(M_1 \otimes_R N_1 \otimes (A \otimes_R B)^{\otimes n}, M_2 \otimes_R N_2). \end{aligned}$$

*Explicitly, if  $\ell = \sum n_i(S_i, T_i)$  is the linear combination of module transformation trees corresponding to  $\mathbf{L}$  then the operation  $(f \otimes_{\mathbf{L}} g)_{1+n}$  is given by*

$$\begin{aligned} (f \otimes_{\mathbf{L}} g)_{1+n} &((x \otimes y) \otimes (a_1 \otimes b_1) \otimes \cdots \otimes (a_n \otimes b_n)) \\ &= \sum_i n_i [F_f(S_i)(x \otimes a_1 \otimes \cdots \otimes a_n)] \otimes [F_g(T_i)(y \otimes b_1 \otimes \cdots \otimes b_n)]. \end{aligned}$$

**Lemma 3.28.** *Definition 3.26 defines a chain map*

$$\text{Mor}(\mathcal{M}_1, \mathcal{M}_2) \otimes_R \text{Mor}(\mathcal{N}_1, \mathcal{N}_2) \rightarrow \text{Mor}(\mathcal{M}_1 \otimes_{\mathbf{M}^1} \mathcal{N}_1, \mathcal{M}_2 \otimes_{\mathbf{M}^2} \mathcal{N}_2).$$

*Moreover, homotopic module-map diagonals give homotopic chain maps.*

*Proof.* This is immediate from the definition and Lemma 3.23.  $\square$

**Proposition 3.29.** *Fix an associahedron diagonal  $\Gamma$ , module diagonals  $\mathbf{M}^1$ ,  $\mathbf{M}^2$ , and  $\mathbf{M}^3$  compatible with  $\Gamma$ , and for  $1 \leq i < j \leq 3$  module-map diagonals  $\mathbf{L}^{ij}$  compatible with  $\mathbf{M}^i$  and  $\mathbf{M}^j$ . Then for any  $A_\infty$ -algebras  $\mathcal{A}$  and  $\mathcal{B}$ ,  $A_\infty$ -modules  $\mathcal{M}_1$ ,  $\mathcal{M}_2$ , and  $\mathcal{M}_3$  over  $\mathcal{A}$ ,  $A_\infty$ -modules  $\mathcal{N}_1$ ,  $\mathcal{N}_2$ , and  $\mathcal{N}_3$  over  $\mathcal{B}$ , and morphisms*

$$\mathcal{M}_1 \xrightarrow{f_1} \mathcal{M}_2 \xrightarrow{f_2} \mathcal{M}_3 \quad \mathcal{N}_1 \xrightarrow{g_1} \mathcal{N}_2 \xrightarrow{g_2} \mathcal{N}_3,$$

*we have a chain homotopy*

$$(3.30) \quad (f_2 \circ f_1) \otimes_{\mathbf{L}^{13}} (g_2 \circ g_1) \sim (f_2 \otimes_{\mathbf{L}^{23}} g_2) \circ (f_1 \otimes_{\mathbf{L}^{12}} g_1).$$



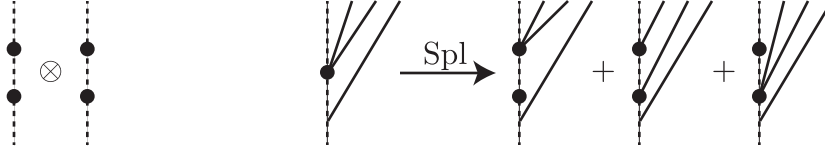

FIGURE 15. **Module bi-transformation trees.** Left: the pair of trees in  $\ell_1$ . Right: an example of the splitting operation  $\text{Spl}$ .

*Proof.* We introduce yet another type of trees to encode the two sides of Equation (3.30). A *module bi-transformation tree* is a tree  $T$  together with *two* distinguished internal vertices  $v_1, v_2$  on the left-most strand. As before, we require that all internal vertices except for the  $v_i$  have valence 3 or more. We think of the  $v_i$  as dividing the left-most strand into three sections, corresponding to three modules involved (e.g.,  $\mathcal{M}_1, \mathcal{M}_2$ , and  $\mathcal{M}_3$ ). The differential of a module bi-transformation tree  $T$  is the sum over all ways of inserting an edge in  $T$  so as to get a new module bi-transformation tree.

The module bi-transformation trees complex with  $n$  inputs can be viewed as a subcomplex of the associahedron trees complex with  $n + 2$  inputs: given a bi-transformation tree, the corresponding associahedron tree is obtained by adding two inputs on the far left and routing them to the two distinguished vertices. The corresponding quotient complex is spanned by trees where the two leftmost inputs go to the same internal vertex. This quotient complex is clearly acyclic so the module bi-transformation trees complex, like the associahedron trees complex, is contractible.

Given a sequence of maps  $\mathcal{M}_1 \xrightarrow{f_1} \mathcal{M}_2 \xrightarrow{f_2} \mathcal{M}_3$  between  $A_\infty$ -modules over  $\mathcal{A}$ , a module bi-transformation tree  $T$  with  $n$  inputs can be turned into a map  $M_1 \otimes A^{\otimes(n-1)} \rightarrow M_3$  by turning each internal vertex of valence  $d$  into  $\mu_d$  if it is not on the leftmost strand or  $(m_1)_d, (f_1)_d, (m_2)_d, (f_2)_d$ , or  $(m_3)_d$  if it is on the leftmost strand and above  $v_1$ , at  $v_1$ , between  $v_1$  and  $v_2$ , at  $v_2$ , or below  $v_2$ , respectively.

A *module-bi-map tree diagonal*  $\ell$  compatible with  $\mathbf{m}^1$  and  $\mathbf{m}^3$  is a sum of pairs of module bi-transformation trees satisfying the compatibility and non-degeneracy conditions of Definition 2.48, but with module bi-transformation trees in place of module transformation trees. (For instance,  $\ell_1$  is still the unique pair of module bi-transformation trees with one input; see Figure 15.)

Both sides of Equation (3.30) give module-bi-map tree diagonals, as follows. Let  $\ell^{ij}$  be the module-bi-map tree diagonal corresponding to the module-bi-map diagonal  $\mathbf{L}^{ij}$ . For a module transformation tree  $T$ , define  $\text{Spl}(T)$  to be the sum of module bi-transformation trees obtained by splitting the distinguished vertex of  $T$  into two distinguished vertices in all possible ways; see Figure 15. For a pair of trees  $T_1 \otimes T_2$ , define  $\text{Spl}(T_1 \otimes T_2) = \text{Spl}(T_1) \otimes \text{Spl}(T_2)$ . Then the left side of Equation (3.30) is the map corresponding to  $\text{Spl}(\ell^{13})$ , by the definition of composition of  $A_\infty$ -module maps.

Given two module transformation trees  $T_1$  and  $T_2$ , the composition  $T_1 \circ_1 T_2$  is naturally a module bi-transformation tree. Similarly, given two pairs of module transformation trees  $(S_1, T_1)$  and  $(S_2, T_2)$ ,  $(S_2 \circ S_1, T_2 \circ T_1)$  is a pair of module bi-transformation trees. Then the right side of Equation (3.30) is the map corresponding to  $\ell^{23} \circ_1 \ell^{12}$ .

Let us check that  $\text{Spl}(\ell^{13})$  and  $\ell^{12} \circ_1 \ell^{23}$  are both module-bi-map tree diagonals. Normalization is immediate in both cases. Compatibility follows easily from

$$\begin{aligned} \partial \text{Spl}(\ell) &= \text{Spl}(\partial \ell) \\ \partial(\ell^1 \circ_1 \ell^2) &= (\partial \ell^1) \circ_1 \ell^2 + \ell^1 \circ_1 (\partial \ell^2). \end{aligned}$$

Just as for Proposition 2.54, any two module-bi-map tree diagonals are homotopic: we can make a chain complex out of linear combinations of pairs of module bi-transformation trees so that the diagonals are cycles, and then inductively build up a homotopy between any two diagonals. The

homotopy between  $\text{Spl}(\ell^{13})$  and  $\ell^{12} \circ_1 \ell^{23}$  gives the desired homotopy between the two sides of Equation (3.30).  $\square$

**Lemma 3.31.** *Let  $\mathcal{M}$  and  $\mathcal{N}$  be  $A_\infty$ -modules over  $\mathcal{A}$  and  $f: \mathcal{M} \rightarrow \mathcal{N}$  a homomorphism. Then  $f$  is an isomorphism if and only if  $f_1$  is an isomorphism.*

(See also Lemma 3.15.)

*Proof.* Certainly if  $f$  is an isomorphism then  $f_1$  is an isomorphism. To prove the converse, it suffices to construct left and right inverses to  $f$ . We will construct the left inverse  $g$  to  $f$ ; construction of the right inverse is similar. Let  $g_1$  be the inverse to  $f_1$ . Suppose we have defined  $g_i$  for  $i \leq n$  so that  $(g \circ f)_i = 0$  for  $1 < i \leq n$ . We have

$$(g \circ f)_{n+1}(x, a_1, \dots, a_n) = \sum_{k=0}^n g_{n-k+1}(f_{k+1}(x, a_1, \dots, a_k), a_{k+1}, \dots, a_n).$$

So, define

$$g_{n+1}(y, a_1, \dots, a_n) = \sum_{k=1}^n g_{n-k+1}(f_{k+1}(g_1(y), a_1, \dots, a_k), a_{k+1}, \dots, a_n).$$

It is clear that the  $g$  constructed this way is a left inverse to  $f$ . As noted above, a similar argument shows that  $f$  has a right inverse  $h$ , and it follows that  $g = h$ . It remains to verify that  $g$  is an  $A_\infty$ -homomorphism, rather than just a morphism. But

$$0 = d(\mathbb{I}) = d(g \circ f) = d(g) \circ f + g \circ d(f) = d(g) \circ f.$$

Composing on the right by  $g$  gives that  $d(g) = 0$ , as desired.  $\square$

**Corollary 3.32.** *Given  $A_\infty$ -modules  $\mathcal{M}$  and  $\mathcal{N}$ , module diagonals  $\mathbf{M}^1$  and  $\mathbf{M}^2$ , and a module-map diagonal  $\mathbf{L}$  compatible with  $\mathbf{M}^1$  and  $\mathbf{M}^2$ , the map*

$$\mathbb{I}_{\mathcal{M}} \otimes_{\mathbf{L}} \mathbb{I}_{\mathcal{N}}: \mathcal{M} \otimes_{\mathbf{M}^1} \mathcal{N} \rightarrow \mathcal{M} \otimes_{\mathbf{M}^2} \mathcal{N}$$

*is an isomorphism.*

*Proof.* The fact that  $(\mathbb{I}_{\mathcal{M}} \otimes_{\mathbf{L}} \mathbb{I}_{\mathcal{N}})_1$  is an isomorphism is immediate from the non-degeneracy condition for  $\mathbf{L}$ . The corollary now follows from Lemma 3.31.  $\square$

**Corollary 3.33.** *Given a  $A_\infty$ -modules  $\mathcal{M}$  and  $\mathcal{N}$ , a module diagonal  $\mathbf{M}$ , and a module-map diagonal  $\mathbf{L}$  compatible with  $\mathbf{M}$  and  $\mathbf{M}$ , the map*

$$\mathbb{I}_{\mathcal{M}} \otimes_{\mathbf{L}} \mathbb{I}_{\mathcal{N}}: \mathcal{M} \otimes_{\mathbf{M}} \mathcal{N} \rightarrow \mathcal{M} \otimes_{\mathbf{M}} \mathcal{N}$$

*is homotopic to the identity map.*

*Proof.* By Proposition 3.29,

$$(\mathbb{I}_{\mathcal{M}} \otimes_{\mathbf{L}} \mathbb{I}_{\mathcal{N}}) \circ (\mathbb{I}_{\mathcal{M}} \otimes_{\mathbf{L}} \mathbb{I}_{\mathcal{N}}) \sim (\mathbb{I}_{\mathcal{M}} \otimes_{\mathbf{L}} \mathbb{I}_{\mathcal{N}}).$$

By Corollary 3.32,  $(\mathbb{I}_{\mathcal{M}} \otimes_{\mathbf{L}} \mathbb{I}_{\mathcal{N}})$  is an isomorphism. Composing both sides with  $(\mathbb{I}_{\mathcal{M}} \otimes_{\mathbf{L}} \mathbb{I}_{\mathcal{N}})^{-1}$  gives the result.  $\square$

*Remark 3.34.* Even when  $\mathbf{M}^1 = \mathbf{M}^2$ ,  $\mathbb{I}_{\mathcal{M}} \otimes_{\mathbf{L}} \mathbb{I}_{\mathcal{N}}$  may not be the identity map unless  $\mathbf{L}$ , and perhaps the  $\mathbf{M}^i$ , are chosen carefully. Specifically, the differential of the pair of trees

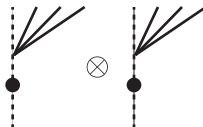

is in the same grading as  $\ell_4$ . If  $\ell$  has the property that  $\mathbb{I}_{\mathcal{M}} \otimes_{\mathbf{L}} \mathbb{I}_{\mathcal{N}}$  is necessarily the identity map then the new module multiplihedron diagonal obtained by adding the differential of this pair of trees to  $\ell_4$  no longer has this property.

*Proof of Theorem 1.4.* Existence of a compatible module diagonal is trivial: we can take  $\mathbf{M} = \mathbf{\Gamma}$  (compare Example 2.25). It remains to verify the rest of the theorem.

The fact that the tensor product is an  $A_\infty$ -module is immediate from the definition and Lemma 3.20.

Part (M1) follows from the non-degeneracy condition for module diagonals. Part (M2) follows from Proposition 3.29 and Corollary 3.32. The homotopy equivalence for Part (M3) is obtained by tensoring the identity maps  $\mathbb{I}_{\mathcal{M}_1}$  and  $\mathbb{I}_{\mathcal{M}_2}$  using any module-map diagonal compatible with  $\mathbf{M}_1$  and  $\mathbf{M}_2$ ; existence of such a module-map diagonal is guaranteed by Lemma 2.49.  $\square$

Again, in Section 3.4, some boundedness properties of our modules will be relevant.

**Definition 3.35.** An  $A_\infty$ -module  $\mathcal{M}$  is *bonsai* if there is an integer  $N$  so that for any associahedron tree  $T$  with dimension  $\dim(T) > N$ ,  $m^{\mathcal{M}}(T) = 0$ . An  $A_\infty$ -module map  $f: \mathcal{M} \rightarrow \mathcal{N}$  is *bonsai* if there is an integer  $N$  so that for any module transformation tree  $T$  with  $\dim(T) > N$ ,  $f(T) = 0$ .

It is immediate from the definition that the bonsai morphisms form a subcomplex of  $\text{Mor}(\mathcal{M}, \mathcal{N})$ .

**Lemma 3.36.** Fix an associahedron diagonal  $\mathbf{\Gamma}$ , module diagonals  $\mathbf{M}^1$  and  $\mathbf{M}^2$  compatible with  $\mathbf{\Gamma}$ , and module-map diagonal  $\mathbf{L}$  compatible with  $\mathbf{M}^1$  and  $\mathbf{M}^2$ . If  $\mathcal{A}_1$  and  $\mathcal{A}_2$  are bonsai  $A_\infty$ -algebras and  $\mathcal{M}_1$  and  $\mathcal{M}_2$  are bonsai  $A_\infty$ -modules over  $\mathcal{A}_1$  and  $\mathcal{A}_2$  then  $\mathcal{M}_1 \otimes_{\mathbf{M}^1} \mathcal{M}_2$  is also bonsai. Similarly, if  $\mathcal{M}_i, \mathcal{N}_i$ , and  $f^i: \mathcal{M}_i \rightarrow \mathcal{N}_i$  are bonsai for  $i = 1, 2$  then so is  $f^1 \otimes_{\mathbf{L}} f^2$ .

*Proof.* As was the case for Lemma 3.18, this is immediate from the fact that  $\mathbf{M}$  (respectively  $\mathbf{L}$ ) is grading-preserving.  $\square$

**3.4. Type  $D$  and  $DD$  structures.** Next we turn to type  $D$  structures and their bimodule analogue, type  $DD$  structures. We will focus on left type  $D$  structures and left-left type  $DD$  structures.

Fix an  $A_\infty$ -algebra  $\mathcal{A}$  over  $\mathbb{k}$ . Recall from the introduction that a (left) type  $D$  structure over  $\mathcal{A}$  consists of a projective  $\mathbb{k}$ -module  $P$  together with a  $\mathbb{k}$ -module map  $\delta_P^1: P \rightarrow (A \otimes P)\langle\langle 1 \rangle\rangle$  satisfying Equation (1.5). We need to make sure the sums involved are finite.

**Definition 3.37.** A type  $D$  structure is *bounded* if all sufficiently large iterates of the structure map  $\delta^1$  vanish.

*Remark 3.38.* Sometimes (e.g., in [LOT15]), we refer to our notion of being “bounded” as being *operationally bounded*, since a bounded type  $D$  structure need not be supported in finitely many gradings.

**Convention 3.39.** When talking about a type  $D$  structure  $P$  over  $\mathcal{A}$ , we assume that either  $P$  is bounded or  $\mathcal{A}$  is bonsai.

(We will weaken this restriction somewhat in Section 9.)

**Definition 3.40.** Given type  $D$  structures  ${}^{\mathcal{A}}P$  and  ${}^{\mathcal{A}}Q$  over  $\mathcal{A}$ , the morphism complex  $\text{Mor}({}^{\mathcal{A}}P, {}^{\mathcal{A}}Q)$  consists of all  $\mathbb{k}$ -module maps  $f^1: P \rightarrow A \otimes Q$ . The differential on this complex is defined by

$$d(f^1) = \sum_{m,n=0}^{\infty} (\mu_{m+1+n} \otimes \mathbb{I}) \circ (\mathbb{I}_{A^{\otimes m+1}} \otimes \delta_Q^n) \circ (\mathbb{I}_{A^{\otimes m}} \otimes f^1) \circ \delta_P^m$$

or, graphically,

$$d(f^1) = \begin{array}{c} \downarrow \\ \delta_P \\ \downarrow \\ \swarrow f^1 \quad \searrow \delta_Q \\ \downarrow \\ \mu \\ \downarrow \end{array} .$$

We will sometimes write  $f: {}^A P \rightarrow {}^A Q$  to indicate a morphism  $f^1: P \rightarrow A \otimes Q$ .

These morphism complexes make the category of type  $D$  structures into a (non-unital)  $A_\infty$ -category, with (higher) composition of a string  ${}^A P_0 \xrightarrow{f_1} {}^A P_1 \xrightarrow{f_2} \dots \xrightarrow{f_n} {}^A P_n$  given by

$$\circ_n(f_n, \dots, f_1) = \begin{array}{c} \downarrow \\ \delta_{P_0} \\ \downarrow \\ \swarrow f_1^1 \quad \searrow \delta_{P_1} \\ \downarrow \\ \swarrow f_2^1 \quad \searrow \vdots \\ \downarrow \\ \swarrow f_n^1 \quad \searrow \delta_{P_n} \\ \downarrow \\ \mu \\ \downarrow \end{array}$$

[LOT15, Lemma 2.2.27].

In the case that  $\mathcal{A}$  is strictly unital (see Section 3.7 below), the category of type  $D$  structures over  $\mathcal{A}$  is also strictly unital, with strict unit

$$\mathbb{I}_P^1(x) = \mathbf{1} \otimes x.$$

Recall that a type  $DD$  structure over  $dg$  algebras  $\mathcal{A}$  and  $\mathcal{B}$  is a type  $D$  structure over  $\mathcal{A} \otimes_R \mathcal{B}$ .

**Definition 3.41.** Let  $\mathcal{A}$  and  $\mathcal{B}$  be  $A_\infty$ -algebras over  $\mathbb{k}_1$  and  $\mathbb{k}_2$ , respectively. Fix an associahedron diagonal  $\Gamma$ . Then a left-left type  $DD$  structure over  $\mathcal{A}$  and  $\mathcal{B}$  with respect to  $\Gamma$  is a (left) type  $D$  structure over  $\mathcal{A} \otimes_\Gamma \mathcal{B}$ . So, the category of left-left type  $DD$  structures inherits the structure of a non-unital  $A_\infty$ -category from Definition 3.40.

Working with left-left modules is awkward, so we will often think of a left-left module over  $\mathcal{A}$  and  $\mathcal{B}$  as a left-right module over  $\mathcal{A}$  and  $\mathcal{B}^{\text{op}}$ , with a structure operation

$$\delta^1: P \rightarrow A \otimes P \otimes B^{\text{op}}\langle\langle 1 \rangle\rangle$$

obtained from  $\delta^1$  by switching the factors. Graphically, we can denote the operation  $\delta^1: P \rightarrow A \otimes P \otimes B^{\text{op}}\langle\langle 1 \rangle\rangle$  on a left-right type  $D$  structure as

$$\begin{array}{c} \downarrow \\ \delta^1 \\ \swarrow \quad \searrow \\ \downarrow \end{array} .$$

To get the order of operations correct, the portion of the diagrams to the right of the dotted line should be folded over to put it on the left. In particular, the inputs to the algebra operations appear in the opposite order, and the trees on that side of the diagonal  $\Gamma$  will appear reversed. In other words, the diagrams respect the notions of closer to / farther from the factor  $P$ , not the notion of left / right.

Similarly to type  $D$  structures, the map  $\delta^1$  induces a map

$$\delta: P \rightarrow \overline{\mathcal{T}}^*(A\langle\langle 1 \rangle\rangle) \otimes P \otimes \overline{\mathcal{T}}^*(B^{\text{op}})$$

by

$$\begin{array}{c} \downarrow \\ \delta \\ \swarrow \downarrow \searrow \end{array} = \begin{array}{c} \downarrow \\ \delta^1 \\ \swarrow \downarrow \searrow \end{array} + \begin{array}{c} \downarrow \\ \delta^1 \\ \swarrow \downarrow \searrow \\ \delta^1 \\ \swarrow \downarrow \searrow \end{array} + \dots$$

The type  $DD$  structure is *bounded* if the image of  $\delta$  is contained in  $\mathcal{T}^*(A\langle\langle 1 \rangle\rangle) \otimes P \otimes \mathcal{T}^*(B^{\text{op}})$ . If our associahedron tree diagonal is

$$\gamma_n = \sum_{(S,T) \in \mathcal{T}_n \otimes \mathcal{T}_n} n_{(S,T)}(S \otimes T) \in \mathcal{T}_n \otimes \mathcal{T}_n,$$

then the structure equation for a type  $DD$  structure can be encoded as

$$\sum_n \sum_{(S,T) \in \mathcal{T}_n \otimes \mathcal{T}_n} n_{(S,T)} \begin{array}{c} \downarrow \\ \delta \\ \swarrow \downarrow \searrow \\ \mu(S) \quad \mu(T^{\text{op}}) \\ \downarrow \quad \downarrow \end{array} = d \left( \begin{array}{c} \downarrow \\ \delta^1 \\ \swarrow \downarrow \searrow \end{array} \right)$$

or even more succinctly

$$(3.42) \quad \begin{array}{c} \downarrow \\ \delta \\ \swarrow \downarrow \searrow \\ \gamma \quad \gamma^{\text{op}} \\ \downarrow \quad \downarrow \end{array} = d \left( \begin{array}{c} \downarrow \\ \delta^1 \\ \swarrow \downarrow \searrow \end{array} \right).$$

(See Equation (3.9) for this notation. On the right-hand side, the operation  $d$  is induced by  $\mu_1$  on the tensor product algebra  $A \otimes B$ .) As in Convention 3.39, for these structure equations to make sense we must require either that  $\mathcal{A}$  and  $\mathcal{B}$  are bonsai, or that  $P$  is bounded.

*Warning 3.43.* Non-unital categories lack a notion of isomorphism, not to mention equivalences of categories. This makes it difficult to prove that changing the diagonal gives an equivalent category of type  $DD$  structures. One way to handle this issue is to consider homotopy unital algebras. See Section 7.5 and, in particular, Theorem 7.62 for independence of the category of type  $DD$  structures from the choice of diagonal.

**3.5. Box products of type  $DD$  structures.** In Section 3.3, we considered external tensor products of  $A_\infty$ -modules, i.e., tensor products over the ground ring  $R$ . We turn now to internal tensor products, i.e., tensor products over an  $A_\infty$ -algebra  $\mathcal{A}$ . Recall that the  $A_\infty$ -tensor product of  $A_\infty$ -modules  $\mathcal{M}_{\mathcal{A}}$  and  ${}_{\mathcal{A}}\mathcal{N}$  is defined to be the  $R$ -module

$$M \otimes \text{Bar}(\mathcal{A}) \otimes N,$$

where  $\text{Bar}(\mathcal{A}) = \mathcal{T}^*(A\langle\langle 1 \rangle\rangle)$  denotes the bar complex of  $\mathcal{A}$  (see, e.g., [Kel01, Section 6.3] or [Kela, Section 3]). This tensor product is equipped with a differential involving (all of) the operations

$m_i$  on  $\mathcal{M}$  and  $\mathcal{N}$  and  $\mu_i$  on  $\mathcal{A}$ . This  $A_\infty$ -tensor product is a generalization of the derived tensor product of ordinary modules (or chain complexes of modules, or  $dg$  modules).

If we replace  ${}_{\mathcal{A}}\mathcal{N}$  with a type  $D$  structure  ${}^{\mathcal{A}}P$ , we can form another kind of tensor product, denoted  $\boxtimes$  in [LOT18, LOT15], which is closer to the classical tensor product of ordinary modules. If  $\mathcal{M}$  is bonsai or  $P$  is bounded then we can define a differential  $\partial^{\boxtimes}$  on  $M \otimes P$  by the composition

$$M \otimes P \xrightarrow{\mathbb{I} \otimes \delta} M \otimes \overline{\mathcal{T}}^*(A) \otimes P \xrightarrow{m \otimes \mathbb{I}} M \otimes P,$$

i.e.,

$$\partial^{\boxtimes} = \begin{array}{ccc} & \downarrow & \downarrow \\ & \delta_P & \\ \downarrow & \swarrow & \downarrow \\ m_M & & \end{array} .$$

Let  $\mathcal{M} \boxtimes P$  denote the complex  $(M \otimes P, \partial^{\boxtimes})$ . Further, given  $\phi \in \text{Mor}(\mathcal{M}_1, \mathcal{M}_2)$  and a sequence of maps  $f_i^1 \in \text{Mor}(P_i, P_{i+1})$ ,  $i = 1, \dots, n$  (for any  $n \geq 1$ ) define

$$\boxtimes_{0,n} (; f_1^1, \dots, f_n^1) = \begin{array}{ccc} & \downarrow & \downarrow \\ & \delta_{P_1} & \\ & \downarrow f_1^1 & \\ & \delta_{P_2} & \\ & \vdots & \\ & \downarrow f_n^1 & \\ & \delta_{P_{n+1}} & \\ \downarrow & \swarrow & \downarrow \\ m_{M_1} & & \end{array} .$$

$$\boxtimes_{1,n} (\phi; f_1^1, \dots, f_n^1) = \begin{array}{ccc} & \downarrow & \downarrow \\ & \delta_{P_1} & \\ & \downarrow f_1^1 & \\ & \delta_{P_2} & \\ & \vdots & \\ & \downarrow f_n^1 & \\ & \delta_{P_{n+1}} & \\ \downarrow & \swarrow & \downarrow \\ \phi & & \end{array} .$$

Define  $\boxtimes_{i,j}$  to vanish if  $i > 1$ .

The following is a slight strengthening of [LOT18, Lemma 2.30] and [LOT15, Lemma 2.3.3], the proof of which is left to the reader:

**Lemma 3.44.** *If  $\mathcal{M}$  is bonsai or  $P$  is bounded then  $\mathcal{M} \boxtimes P$  is a chain complex. Moreover, the operation  $\boxtimes$  is a (non-unital)  $A_\infty$ -bifunctor, i.e., the operations  $\boxtimes_{i,j}$  satisfy the  $A_\infty$ -bimodule relations.*

*Remark 3.45.* If  $\mathcal{A}$  and  $\mathcal{M}$  are strictly unital and we restrict to the strictly unital morphism complex then  $\boxtimes$  is a strictly unital bifunctor.

*Remark 3.46.* Note that  $\boxtimes_{1,1}$  is a higher composition of  $\phi$  and  $f_1^1$ : the ordinary composition is defined to be either  $\boxtimes_{0,1} (; f_1^1) \circ \boxtimes_{1,0} (\phi; )$  or  $\boxtimes_{1,0} (\phi; ) \circ \boxtimes_{0,1} (; f_1^1)$ , a global choice.

We turn now to the generalizations of  $\boxtimes$  to bimodules. The most obvious generalization is a triple tensor product of a  $DD$  structure with two  $A_\infty$ -modules.

**Definition 3.47.** *Fix an associahedron diagonal  $\Gamma$  and a module diagonal  $\mathbf{M}$  compatible with  $\Gamma$ . Let  ${}^{\mathcal{A}, \mathcal{B}}P$  be a left-left type  $DD$  structure over  $\mathcal{A}$  and  $\mathcal{B}$ , and let  $\mathcal{M}_{\mathcal{A}}, \mathcal{N}_{\mathcal{B}}$  be  $A_\infty$ -modules over  $\mathcal{A}$  and  $\mathcal{B}$ . Assume that either  $P$  is bounded or  $\mathcal{M}, \mathcal{N}, \mathcal{A}$ , and  $\mathcal{B}$  are all bonsai. Define*

$$[\mathcal{M}_{\mathcal{A}} \boxtimes {}^{\mathcal{A}}P^{\mathcal{B}^{\text{op}}} \boxtimes {}_{\mathcal{B}^{\text{op}}} \mathcal{N}]_{\mathbf{M}} := (\mathcal{M} \otimes_{\mathbf{M}} \mathcal{N})_{\mathcal{A} \otimes_{\Gamma} \mathcal{B}} \boxtimes {}^{\mathcal{A} \otimes_{\Gamma} \mathcal{B}} P.$$

Recall that Theorem 1.7 asserts that the triple box product is a chain complex and, up to homotopy equivalence, is independent of the choice of module diagonal.

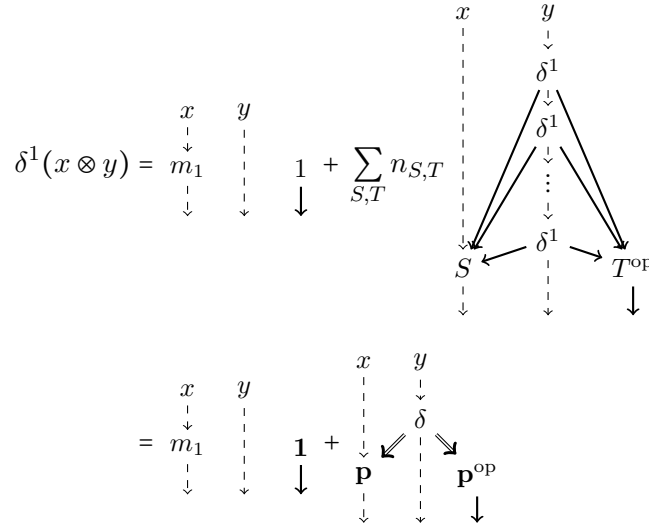

FIGURE 16. The structure operation on  $\mathcal{M} \boxtimes^{\mathbf{P}} P$ , shown graphically with two different notations. We will prefer the second notation.

*Proof of Theorem 1.7.* The fact that the triple box product is a well-defined chain complex is immediate from its definition, together with Lemmas 3.44 and 3.36. Next, if  $\mathbf{M}$  and  $\mathbf{M}'$  are different module diagonals, it follows from Part (M3) of Theorem 1.4 that  $\mathcal{M} \otimes_{\mathbf{M}} \mathcal{N}$  and  $\mathcal{M} \otimes_{\mathbf{M}'} \mathcal{N}$  are homotopy equivalent. If  $\mathcal{A}$ ,  $\mathcal{B}$ ,  $\mathcal{M}$ , and  $\mathcal{N}$  are bonsai, Lemma 3.36 implies that the homotopy equivalence is also bonsai. So, invariance of the box product under homotopy equivalence, [LOT15, Corollary 2.3.5], implies that the triple box products are homotopy equivalent as well.  $\square$

*Remark 3.48.* There is also a sense in which the triple box product is independent of the associahedron diagonal  $\Gamma$ , but since the structure equation for a type  $DD$  structure uses an associahedron diagonal, this is rather cumbersome to spell out, and is left to the reader.

Our next goal is to interpret this triple box product as tensoring of  $\mathcal{M}$  with  $P$  and then tensoring the result with  $\mathcal{N}$ . This interpretation uses the following notion, which requires  $\mathcal{B}$  to be strictly unital.

**Definition 3.49.** Fix a module diagonal primitive

$$\mathbf{p}_n = \sum_{(S,T)} n_{S,T}(S,T) \in \mathcal{T}_n \otimes_R \mathcal{T}_{n-1}$$

compatible with an associahedron diagonal  $\Gamma$ . Let  $\mathcal{A}$ ,  $\mathcal{B}$  be  $A_\infty$ -algebras over  $\mathbb{k}_1$ ,  $\mathbb{k}_2$  respectively, and assume that  $\mathcal{B}$  is strictly unital with unit  $\mathbf{1}$ . Let  ${}^{\mathcal{A},\mathcal{B}}P$  be a type  $DD$  structure with respect to  $\Gamma$  and let  $\mathcal{M}_{\mathcal{A}}$  be an  $A_\infty$ -module over  $\mathcal{A}$ . Assume that either  $P$  is bounded or  $\mathcal{M}$ ,  $\mathcal{A}$ , and  $\mathcal{B}$  are bonsai. Define  $\mathcal{M} \boxtimes^{\mathbf{P}} P$  to be the vector space  $M \otimes P$  equipped with the operation

$$\delta^1: M \boxtimes^{\mathbf{P}} P \rightarrow (M \boxtimes^{\mathbf{P}} P) \otimes B^{\text{op}}$$

given by

$$\delta^1(x \otimes y) = m_1^M(x) \otimes y \otimes \mathbf{1} + \sum_{(S,T)} n_{S,T}(m^M(S) \otimes \mathbb{I}_P \otimes \mu^{B^{\text{op}}}(T^{\text{op}})) \circ (\mathbb{I}_M \otimes \delta_P).$$

This is shown graphically in Figure 16.

**Lemma 3.50.** The object  $(\mathcal{M} \boxtimes^{\mathbf{P}} P, \delta^1)$  from Definition 3.49 is a right type  $D$  structure over  $B^{\text{op}}$ , or equivalently a left type  $D$  structure over  $\mathcal{B}$ .



*Proof.* The boundedness assumptions imply that the sum involved in defining  $\delta^1$  is finite. It remains to verify that  $\partial^2 = 0$  or, more precisely, that Equation (1.5) holds for  $P \boxtimes^{\mathbf{P}} \mathcal{M}$ . We will give the proof in compact graphical notation. Using the fact that  $\mathcal{B}$  is strictly unital, Equation (1.5) is equivalent to

$$\begin{array}{c} \vdots \\ \downarrow \\ \mathbf{p} \\ \vdots \\ \mathbf{p} \\ \vdots \\ \downarrow \end{array} \begin{array}{c} \delta \\ \swarrow \\ \vdots \\ \delta \\ \searrow \\ \mathbf{p}^{\text{op}} \\ \downarrow \\ \mu \end{array} + \begin{array}{c} \vdots \\ \downarrow \\ m_1 \\ \vdots \\ \mathbf{p} \\ \vdots \\ \downarrow \end{array} \begin{array}{c} \delta \\ \swarrow \\ \delta \\ \searrow \\ \mathbf{p}^{\text{op}} \\ \downarrow \end{array} + \begin{array}{c} \vdots \\ \downarrow \\ \mathbf{p} \\ \vdots \\ m_1 \\ \vdots \\ \downarrow \end{array} \begin{array}{c} \delta \\ \swarrow \\ \delta \\ \searrow \\ \mathbf{p}^{\text{op}} \\ \downarrow \end{array} = 0.$$

The module diagonal primitive structure equation, Equation (2.31), together Lemmas 3.4 and 3.20, implies that the sum of these three terms is equal to

$$\begin{array}{c} \vdots \\ \downarrow \\ \delta \\ \swarrow \\ \mathbf{p} \\ \searrow \\ \mathbf{p}^{\text{op}} \\ \downarrow \end{array} \begin{array}{c} \delta \\ \swarrow \\ \delta \\ \searrow \\ \mathbf{p}^{\text{op}} \\ \downarrow \end{array} + \begin{array}{c} \vdots \\ \downarrow \\ \delta \\ \swarrow \\ \mathbf{p} \\ \searrow \\ \mathbf{p}^{\text{op}} \\ \downarrow \end{array} \begin{array}{c} \delta \\ \swarrow \\ \delta^1 \\ \searrow \\ \mathbf{p}^{\text{op}} \\ \downarrow \end{array} + \begin{array}{c} \vdots \\ \downarrow \\ \delta \\ \swarrow \\ \mathbf{p} \\ \searrow \\ \mathbf{p}^{\text{op}} \\ \downarrow \end{array} \begin{array}{c} \delta \\ \swarrow \\ \delta^1 \\ \searrow \\ \mathbf{p}^{\text{op}} \\ \downarrow \end{array}$$

These terms cancel by the structure equation for a type  $DD$  structure (Equation (3.42)).  $\square$

**Lemma 3.51.** *Fix an associahedron diagonal  $\Gamma$  and a module diagonal primitive  $\mathbf{p}$  compatible with  $\Gamma$ . Let  $\mathbf{M}$  be the module diagonal associated to  $\mathbf{p}$  (Definition 2.34). Let  ${}^{\mathcal{A}, \mathcal{B}}P$  be a type  $DD$  structure over  $\mathcal{A}$  and  $\mathcal{B}$  and let  $\mathcal{M}_{\mathcal{A}}, \mathcal{N}_{\mathcal{B}}$  be  $A_{\infty}$ -modules over  $\mathcal{A}$  and  $\mathcal{B}$ , respectively. Assume that either  $P$  is bounded or  $\mathcal{M}, \mathcal{N}, \mathcal{A}$ , and  $\mathcal{B}$  are bonsai. Assume also that  $\mathcal{B}$  and  $\mathcal{N}$  are strictly unital. Then*

$$(3.52) \quad [\mathcal{M}_{\mathcal{A}} \boxtimes^{\mathcal{A}} P^{\mathcal{B}^{\text{op}}} \boxtimes_{\mathcal{B}^{\text{op}}} \mathcal{N}]_{\mathbf{M}} \cong (\mathcal{M} \boxtimes_{\mathcal{A}}^{\mathbf{P}} P) \boxtimes_{\mathcal{B}^{\text{op}}} \mathcal{N}.$$

*Proof.* Graphically, both sides of Equation (3.52) are given by

$$\left( \begin{array}{c} \vdots \\ \downarrow \\ \mathbf{p} \\ \vdots \\ \mathbf{p} \\ \vdots \\ \downarrow \end{array} \begin{array}{c} \delta \\ \swarrow \\ \vdots \\ \delta \\ \searrow \\ \mathbf{p}^{\text{op}} \\ \downarrow \\ m \end{array} \right) + \left( \begin{array}{c} \vdots \\ \downarrow \\ m_1 \\ \vdots \\ \downarrow \end{array} \right).$$

$\square$

*Proof of Theorem 1.10.* This is a restatement of Lemmas 3.50 and 3.51.  $\square$

3.5.1. *Functoriality of one-sided box tensor products.* We turn next to functoriality of  $\boxtimes^{\mathbf{P}}$ . Let  $P$  and  $Q$  be type  $DD$  structures over  $\mathcal{A}$  and  $\mathcal{B}$ , with  $\mathcal{B}$  strictly unital, and let  $f: P \rightarrow Q$  be a morphism. That is,  $f$  is a map  $P \rightarrow A \otimes Q \otimes B^{\text{op}}$ . Given an  $A_\infty$ -module  $\mathcal{M}$  over  $\mathcal{A}$ , we can consider the morphism of right type  $D$  structures over  $\mathcal{B}$

$$\mathbb{I}_{\mathcal{M}} \boxtimes^{\mathbf{P}} f: \mathcal{M} \boxtimes^{\mathbf{P}} P \rightarrow \mathcal{M} \boxtimes^{\mathbf{P}} Q$$

defined graphically by

$$(3.53) \quad \mathbb{I}_{\mathcal{M}} \boxtimes^{\mathbf{P}} f = \begin{array}{c} \begin{array}{c} \downarrow \\ \delta \\ \downarrow \\ f \\ \downarrow \\ \delta \\ \downarrow \\ \mathbf{p} \quad \mathbf{p}^{\text{op}} \\ \downarrow \end{array} \end{array}$$

Similarly, fix a module-map primitive  $\mathbf{q}$  compatible with module diagonal primitives  $\mathbf{p}^1$  and  $\mathbf{p}^2$ . Given another  $A_\infty$ -module  $\mathcal{N}$  over  $\mathcal{A}$  and a morphism  $g: \mathcal{M} \rightarrow \mathcal{N}$  we can consider the map

$$g \boxtimes^{\mathbf{q}} \mathbb{I}_P: \mathcal{M} \boxtimes^{\mathbf{P}^1} P \rightarrow \mathcal{N} \boxtimes^{\mathbf{P}^2} P$$

defined graphically by

$$(3.54) \quad \begin{array}{c} \begin{array}{c} \downarrow \\ \delta \\ \downarrow \\ \mathbf{q}g \quad \mathbf{q}^{\text{op}} \\ \downarrow \end{array} \end{array}$$

where  $\mathbf{q}g$  means that we apply  $g$  at the distinguished vertex of  $\mathbf{q}$ . There is a special case corresponding to  $\delta^0$ , which is the term

$$\begin{array}{c} \downarrow \\ g_1 \\ \downarrow \end{array} \quad \begin{array}{c} \downarrow \\ \mathbf{1} \\ \downarrow \end{array},$$

making use of the fact that  $\mathcal{B}$  is strictly unital. As usual, for these operations to be defined requires some boundedness: either  $P$  and  $Q$  should be bounded or  $\mathcal{A}$ ,  $\mathcal{B}$ ,  $\mathcal{M}$ ,  $\mathcal{N}$ , and  $g$  should be bonsai.

*Remark 3.55.* A module-map primitive has a first term  $\mathbf{q}_1 = \mathbf{p}\Psi_1 \otimes \top$ , giving the special case above, while a module diagonal primitive does not have a corresponding term, instead starting with  $\mathbf{p}_2 = \Psi_2 \otimes \downarrow$ . As a result there is an extra term in Figure (16) compared to Equation (3.54).

**Lemma 3.56.** *Suppose that either  $P$  and  $Q$  are bounded or  $\mathcal{A}$ ,  $\mathcal{B}$ ,  $\mathcal{M}$ ,  $\mathcal{N}$ , and  $g$  are bonsai. Assume also that  $\mathcal{B}$  is strictly unital. Then the maps  $\mathbb{I}_{\mathcal{M}} \boxtimes^{\mathbf{P}} \cdot$  and  $\cdot \boxtimes^{\mathbf{q}} \mathbb{I}_P$  are chain maps*

$$\begin{aligned} \mathbb{I}_{\mathcal{M}} \boxtimes^{\mathbf{P}} \cdot &: \text{Mor}(P, Q) \rightarrow \text{Mor}(\mathcal{M} \boxtimes^{\mathbf{P}} P, \mathcal{M} \boxtimes^{\mathbf{P}} Q) \\ \cdot \boxtimes^{\mathbf{q}} \mathbb{I}_P &: \text{Mor}(\mathcal{M}, \mathcal{N}) \rightarrow \text{Mor}(\mathcal{M} \boxtimes^{\mathbf{P}^1} P, \mathcal{N} \boxtimes^{\mathbf{P}^2} P). \end{aligned}$$

Moreover, for  $\cdot \boxtimes^{\mathbf{q}} \mathbb{I}_P$ , homotopic module-map primitives give homotopic chain maps.

*Proof.* For the first statement,

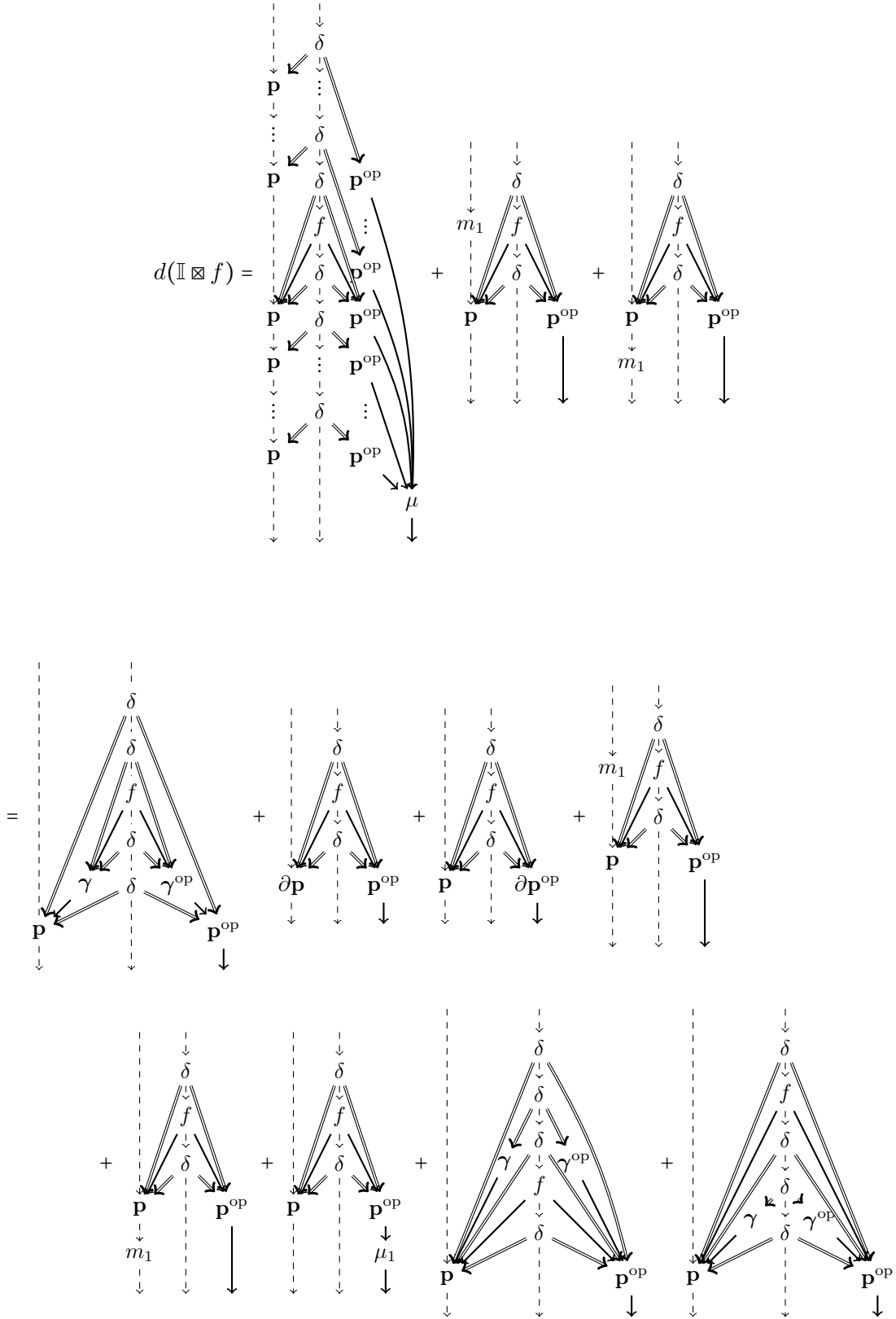

$$\begin{aligned}
 &= \text{Diagram 1} + \text{Diagram 2} + \text{Diagram 3} \\
 &= \mathbb{I} \boxtimes (d(f)).
 \end{aligned}$$

Here, the second equality uses the module diagonal primitive relation. The third uses the type *DD* structure relation and an analogue of Lemma 3.23.

Turning to  $\cdot \boxtimes^{\mathfrak{q}} \mathbb{I}_P$ , we have

$$\begin{aligned}
 d(g \boxtimes^{\mathfrak{q}} \mathbb{I}_P) &= \text{Diagram A} + \text{Diagram B} + \text{Diagram C} \\
 &= (\partial \mathfrak{q})g + \mathfrak{q}g + \partial \mathfrak{q}^{\text{op}} + \text{Diagram D} + \text{Diagram E} \\
 &+ \text{Diagram F} + \text{Diagram G}
 \end{aligned}$$

$$\begin{array}{c}
 = \begin{array}{ccc} \downarrow & \downarrow \delta & \downarrow \\ \mathbf{q}(dg) & \swarrow & \mathbf{q}^{\text{op}} \\ \downarrow & \downarrow & \downarrow \end{array} + \begin{array}{ccc} \downarrow & \downarrow \delta & \downarrow \\ \mathbf{q}g & \swarrow \gamma & \mathbf{q}^{\text{op}} \\ \downarrow & \downarrow \delta & \downarrow \end{array} + \begin{array}{ccc} \downarrow & \downarrow \delta & \downarrow \\ \mathbf{q}g & \swarrow \mu_1 & \mathbf{q}^{\text{op}} \\ \downarrow & \downarrow \delta & \downarrow \end{array} + \begin{array}{ccc} \downarrow & \downarrow \delta & \downarrow \\ \mathbf{q}g & \swarrow \mu_1 & \mathbf{q}^{\text{op}} \\ \downarrow & \downarrow \delta & \downarrow \end{array} \\
 \\
 = \begin{array}{ccc} \downarrow & \downarrow \delta & \downarrow \\ \mathbf{q}(dg) & \swarrow & \mathbf{q}^{\text{op}} \\ \downarrow & \downarrow & \downarrow \end{array} .
 \end{array}$$

Here, the second equality uses the structure relation for module-map primitives, the third uses Lemma 3.23, and the fourth uses the structure relation for a type  $DD$  structure. This proves that  $\cdot \boxtimes^{\mathbf{q}} \mathbb{I}_P$  is a chain map. The proof that homotopic module-map primitives give homotopic chain maps is similar, and is left to the reader.  $\square$

*Warning 3.57.* In the expression  $g \boxtimes^{\mathbf{q}} \mathbb{I}_P$ ,  $\mathbb{I}_P$  is just notation. Indeed, to define the identity map of  $P$  requires that  $\mathcal{A} \otimes_{\Gamma} \mathcal{B}$  be strictly unital (Definition 3.78), which is not guaranteed, even if  $\mathcal{A}$  and  $\mathcal{B}$  are.

For the sake of simplicity, we only give a partial analogue of Lemma 3.44:

**Proposition 3.58.** *Fix:*

- An associahedron tree diagonal  $\gamma$ .
- Module diagonal primitives  $\mathbf{p}^1$ ,  $\mathbf{p}^2$ , and  $\mathbf{p}^3$  compatible with  $\gamma$ .
- Module-map primitives  $\mathbf{q}^{12}$  compatible with  $\mathbf{p}^1$  and  $\mathbf{p}^2$ ;  $\mathbf{q}^{23}$  compatible with  $\mathbf{p}^2$  and  $\mathbf{p}^3$ ; and  $\mathbf{q}^{13}$  compatible with  $\mathbf{p}^1$  and  $\mathbf{p}^3$ .
- $A_{\infty}$ -algebras  $\mathcal{A}$  and  $\mathcal{B}$  with  $\mathcal{B}$  strictly unital.
- $A_{\infty}$ -modules  $\mathcal{M}_1$ ,  $\mathcal{M}_2$ , and  $\mathcal{M}_3$  over  $\mathcal{A}$ .
- Type  $DD$  structures  $P_1$ ,  $P_2$ , and  $P_3$  over  $\mathcal{A}$  and  $\mathcal{B}$ .

Then the following diagrams commute up to homotopy:

(3.59)

$$\begin{array}{ccc}
 \text{Mor}_{\mathcal{A}}(\mathcal{M}_1, \mathcal{M}_2) \otimes_R \text{Mor}_{\mathcal{A}}(\mathcal{M}_2, \mathcal{M}_3) & \xrightarrow{f \otimes g \mapsto (f \boxtimes^{\mathbf{p}^{12}} \mathbb{I}_{P_1}) \otimes (g \boxtimes^{\mathbf{q}^{23}} \mathbb{I}_{P_1})} & \text{Mor}^{\mathcal{B}}(\mathcal{M}_1 \boxtimes^{\mathbf{p}^1} P_1, \mathcal{M}_2 \boxtimes^{\mathbf{p}^2} P_1) \\
 \downarrow (f \otimes g) \mapsto g \circ f & & \otimes_R \text{Mor}^{\mathcal{B}}(\mathcal{M}_2 \boxtimes^{\mathbf{p}^2} P_1, \mathcal{M}_3 \boxtimes^{\mathbf{p}^3} P_1) \\
 \text{Mor}_{\mathcal{A}}(\mathcal{M}_1, \mathcal{M}_3) & \xrightarrow{h \mapsto (h \boxtimes^{\mathbf{q}^{13}} \mathbb{I}_{P_1})} & \text{Mor}^{\mathcal{B}}(\mathcal{M}_1 \boxtimes^{\mathbf{p}^1} P_1, \mathcal{M}_3 \boxtimes^{\mathbf{p}^3} P_1); \\
 & & \downarrow (k^1 \otimes l^1) \mapsto l^1 \circ k^1
 \end{array}$$

(3.60)

$$\begin{array}{ccc}
 \text{Mor}^{\mathcal{A}}(P_1, P_2) \otimes_R \text{Mor}^{\mathcal{A}}(P_2, P_3) & \xrightarrow{f^1 \otimes g^1 \mapsto (\mathbb{I}_M \boxtimes^{\mathbf{p}^1} f^1) \otimes (\mathbb{I}_M \boxtimes^{\mathbf{p}^1} g^1)} & \text{Mor}_{\mathbf{k}}(M \boxtimes^{\mathbf{p}^1} P_1, M \boxtimes^{\mathbf{p}^1} P_2) \\
 \downarrow (f^1 \otimes g^1) \mapsto g^1 \circ f^1 & & \otimes_R \text{Mor}_{\mathbf{k}}(M \boxtimes^{\mathbf{p}^1} P_2, M \boxtimes^{\mathbf{p}^1} P_3) \\
 \text{Mor}^{\mathcal{A}}(P_1, P_3) & \xrightarrow{h^1 \mapsto (\mathbb{I}_M \boxtimes^{\mathbf{p}^1} h^1)} & \text{Mor}_{\mathbf{k}}(M \boxtimes^{\mathbf{p}^1} P_1, M \boxtimes^{\mathbf{p}^1} P_3). \\
 & & \downarrow (k^1 \otimes l^1) \mapsto l \circ k
 \end{array}$$

(3.61)

$$\begin{array}{ccc}
\text{Mor}_{\mathcal{A}}(\mathcal{M}_1, \mathcal{M}_2) \otimes_R \text{Mor}^{\mathcal{A}}(P_1, P_2) & \xrightarrow{(f \otimes g^1) \mapsto (\mathbb{I}_{\mathcal{M}_1} \boxtimes^{\mathbf{P}^1} g^1) \otimes (f \boxtimes^{\mathbf{q}^{12}} \mathbb{I}_{P_2})} & \text{Mor}_{\mathbb{k}}(\mathcal{M}_1 \boxtimes^{\mathbf{P}^1} P_1, \mathcal{M}_1 \boxtimes^{\mathbf{P}^1} P_2) \\
\downarrow (f \otimes g^1) \mapsto (f \boxtimes^{\mathbf{q}^{12}} \mathbb{I}_{P_1}) \otimes (\mathbb{I}_{\mathcal{M}_2} \boxtimes^{\mathbf{P}^2} g^1) & & \downarrow (k^1 \otimes l^1) \mapsto l^1 \circ k^1 \\
\text{Mor}_{\mathbb{k}}(\mathcal{M}_1 \boxtimes^{\mathbf{P}^1} P_1, \mathcal{M}_2 \boxtimes^{\mathbf{P}^2} P_1) & \xrightarrow{(k^1 \otimes l^1) \mapsto l^1 \circ k^1} & \text{Mor}_{\mathbb{k}}(\mathcal{M}_1 \boxtimes^{\mathbf{P}^1} P_1, \mathcal{M}_2 \boxtimes^{\mathbf{P}^2} P_2) \\
\otimes_R \text{Mor}_{\mathbb{k}}(\mathcal{M}_2 \boxtimes^{\mathbf{P}^2} P_1, \mathcal{M}_2 \boxtimes^{\mathbf{P}^2} P_2) & & 
\end{array}$$

(Here, we either assume that the  $P_i$  are all bounded, or else that  $\mathcal{A}$ ,  $\mathcal{B}$ , and the  $\mathcal{M}_i$  are bonsai and that the morphism complexes denote the complexes of bonsai morphisms.)

*Proof.* To construct the homotopy for the square (3.59) one uses the notion of a module bi-map diagonal primitive (the definition of which is left to the reader). The square (3.60) follows from the definitions and the module primitive structure equation. The homotopy for square (3.60) is the map

Further details are left to the reader.  $\square$

Recall that for  $\mathcal{B}$  a strictly unital  $A_\infty$ -algebra and  ${}^{\mathcal{B}}Q$  a type  $D$  structure over  $\mathcal{B}$ , the identity map of  $Q$  is defined by

$$\mathbb{I}_Q^1(x) = \mathbf{1} \otimes x.$$

This identity map gives rise to the notion of isomorphic or homotopy equivalent type  $D$  structures. (See also Warnings 3.43 and 3.57.)

**Lemma 3.62.** *Fix module diagonal primitives  $\mathbf{p}_1$  and  $\mathbf{p}_2$  and a module-map primitive  $\mathbf{q}$  compatible with  $\mathbf{p}_1$  and  $\mathbf{p}_2$ . Given  $A_\infty$ -algebras  $\mathcal{A}$  and  $\mathcal{B}$  with  $\mathcal{B}$  strictly unital, an  $A_\infty$ -module  $\mathcal{M}_{\mathcal{A}}$  and a type  $DD$  structure  ${}^{\mathcal{A}, \mathcal{B}}P$ , with  $P$  bounded or  $\mathcal{A}$ ,  $\mathcal{B}$ , and  $\mathcal{M}$  bonsai, the map*

$$\mathbb{I}_{\mathcal{M}} \boxtimes^{\mathbf{q}} \mathbb{I}_P: \mathcal{M} \boxtimes^{\mathbf{P}^1} P \rightarrow \mathcal{M} \boxtimes^{\mathbf{P}^2} P$$

*is a homotopy equivalence.*

*Proof.* First, consider the special case that  $\mathbf{p}_1 = \mathbf{p}_2$  and  $\mathbf{q}$  is the module-map primitive from Lemma 2.61. The term

$$\begin{array}{ccc}
\vdots & & \vdots \\
\downarrow & & \downarrow \\
\mathbb{I} & & \mathbf{1} \\
\downarrow & & \downarrow \\
\vdots & & \vdots
\end{array}$$

contributes the identity map to  $\mathbb{I}_{\mathcal{M}} \boxtimes^{\mathbf{q}} \mathbb{I}_P$ , so it suffices to show that no other terms contribute. This is immediate from the facts that  $(\mathbb{I}_{\mathcal{M}})_n = 0$  for  $n > 1$  and the distinguished vertex in  $\mathbf{q}_n$  has valence  $\geq 3$  if  $n > 1$ .

Now, for any other module-map primitive  $\mathbf{q}'$  compatible with  $\mathbf{p}_1 = \mathbf{p}_2$ , the result follows from the fact that  $\mathbf{q}$  and  $\mathbf{q}'$  are homotopic (Proposition 2.60) and Lemma 3.56. Finally, the case of general module diagonal primitives follows from Equation (3.59) in Proposition 3.58, with  $f = g = \mathbb{I}_{\mathcal{M}}$ .  $\square$

**Corollary 3.63.** *Fix a module diagonal primitive  $\mathbf{p}$  and a module-map primitive  $\mathbf{q}$  compatible with  $\mathbf{p}$  and  $\mathbf{p}$ . Given  $A_\infty$ -algebras  $\mathcal{A}$  and  $\mathcal{B}$  with  $\mathcal{B}$  strictly unital, an  $A_\infty$ -module  $\mathcal{M}_{\mathcal{A}}$  and a type DD structure  ${}^{\mathcal{A},\mathcal{B}}P$ , the map*

$$\mathbb{I}_{\mathcal{M}} \boxtimes^{\mathbf{q}} \mathbb{I}_P: \mathcal{M} \boxtimes^{\mathbf{p}} P \rightarrow \mathcal{M} \boxtimes^{\mathbf{p}} P$$

*is homotopic to the identity map.*

*Proof.* By Equation (3.59) in Proposition 3.58,

$$(\mathbb{I}_{\mathcal{M}} \boxtimes^{\mathbf{q}} \mathbb{I}_P) \circ (\mathbb{I}_{\mathcal{M}} \boxtimes^{\mathbf{q}} \mathbb{I}_P) \sim (\mathbb{I}_{\mathcal{M}} \circ \mathbb{I}_{\mathcal{M}}) \boxtimes^{\mathbf{q}} \mathbb{I}_P = \mathbb{I}_{\mathcal{M}} \boxtimes^{\mathbf{q}} \mathbb{I}_P.$$

Composing with the homotopy inverse of  $\mathbb{I}_{\mathcal{M}} \boxtimes^{\mathbf{q}} \mathbb{I}_P$  (from Lemma 3.62) gives the result.  $\square$

**Corollary 3.64.** *Fix  $A_\infty$ -modules  $\mathcal{M}$  and  $\mathcal{N}$ , a homotopy equivalence  $f: \mathcal{M} \rightarrow \mathcal{N}$ , and a type DD structure  $P$  such that either  $P$  is bounded or  $\mathcal{M}$ ,  $\mathcal{N}$ , and  $f$  are bonsai. Then for any choice of module diagonal primitives and module-map primitive,*

$$f \boxtimes^{\mathbf{q}} \mathbb{I}_P: \mathcal{M} \boxtimes^{\mathbf{p}^1} P \rightarrow \mathcal{N} \boxtimes^{\mathbf{p}^2} P$$

*is a homotopy equivalence.*

*Proof.* This is immediate from Lemma 3.62 and Proposition 3.58.  $\square$

3.5.2. *Associativity of the box tensor product of morphisms.* Given a type DD structure  $P$ , modules  $\mathcal{M}_1, \mathcal{M}_2, \mathcal{N}_1$ , and  $\mathcal{N}_2$ , and morphisms  $f: \mathcal{M}_1 \rightarrow \mathcal{M}_2$  and  $g: \mathcal{N}_1 \rightarrow \mathcal{N}_2$ , as well as an associahedron diagonal  $\Gamma$ , module diagonals  $\mathbf{M}^1$  and  $\mathbf{M}^2$  compatible with  $\Gamma$ , and a module-map diagonal  $\mathbf{L}$  compatible with  $\mathbf{M}^1$  and  $\mathbf{M}^2$ , Definition 3.26 gives a triple box product

$$[f \boxtimes \mathbb{I}_P \boxtimes g]_{\mathbf{L}} = (f \otimes_{\mathbf{L}} g) \boxtimes \mathbb{I}_P$$

(under appropriate boundedness assumptions). This is a little trickier than it looks, since  $\mathcal{A} \otimes_{\Gamma} \mathcal{B}$  is a non-unital algebra, so the category of type  $D$  structures over it is a non-unital category. Nonetheless, for  $f: \mathcal{M} \rightarrow \mathcal{N}$  a map of modules over a non-unital algebra  $\mathcal{C}$  and  ${}^{\mathcal{C}}P$  a type  $D$  structure over  $\mathcal{C}$ , it still makes sense to define

$$f \boxtimes \mathbb{I}_P = \begin{array}{ccc} & & \downarrow \\ & & \delta_P \\ & \swarrow & \downarrow \\ f \boxtimes \mathbb{I}_P = & & \downarrow \\ & \searrow & \downarrow \\ & & \downarrow \end{array}.$$

In the case of interest,  $\mathcal{C} = \mathcal{A} \otimes_{\Gamma} \mathcal{B}$  and this reduces to

$$[f \boxtimes \mathbb{I}_P \boxtimes g]_{\mathbf{L}} = \begin{array}{ccc} & \downarrow & \downarrow \\ & \delta & \downarrow \\ & \swarrow & \searrow \\ \ell f & & \ell^{\text{op}} g \\ & \downarrow & \downarrow \\ & \downarrow & \downarrow \end{array},$$

where  $\ell f$  means we apply  $f$  at the distinguished vertex on the left tree in  $\ell$  and  $\ell^{\text{op}} g$  means we apply  $g$  at the distinguished vertex of the right tree in  $\ell$ .

In the special case that  $g$  is the identity map,  $[f \boxtimes \mathbb{I}_P \boxtimes g]_{\mathbf{L}}$  depends only on the partial module-map diagonal induced by  $\mathbf{L}$ . That is, given a partial module-map diagonal  $\mathbf{k}$  compatible with  $\mathbf{M}^1$  and  $\mathbf{M}^2$  we can define

$$(3.65) \quad [f \boxtimes \mathbb{I}_P \boxtimes \mathbb{I}_{\mathcal{N}}]_{\mathbf{k}} = \begin{array}{ccc} & \downarrow & \downarrow \\ & \delta & \downarrow \\ & \swarrow & \searrow \\ \mathbf{k}f & & \mathbf{k}^{\text{op}}\mathbb{I} \\ & \downarrow & \downarrow \\ & \downarrow & \downarrow \end{array}$$







Finally, if  $\mathbf{k}$  comes from a primitive  $\mathbf{q}$  (and  $\mathbf{p}^i$  comes from a primitive  $\mathbf{p}^i$ ) then

$$[f \boxtimes \mathbb{I}_P \boxtimes \mathbb{I}_N]_{\mathbf{k}} = \begin{array}{ccc} & \downarrow & \\ & \delta & \\ \mathbf{p}^1 & \begin{array}{c} \swarrow \downarrow \searrow \\ \vdots \end{array} & \mathbf{p}^{1,\text{op}} \\ & \delta & \\ \mathbf{p}^1 & \begin{array}{c} \swarrow \downarrow \searrow \\ \vdots \end{array} & \mathbf{p}^{1,\text{op}} \\ & \delta & \\ \mathbf{q}f & \begin{array}{c} \swarrow \downarrow \searrow \\ \vdots \end{array} & \mathbf{q}^{\text{op}} \\ & \delta & \\ \mathbf{p}^2 & \begin{array}{c} \swarrow \downarrow \searrow \\ \vdots \end{array} & \mathbf{p}^{2,\text{op}} \\ & \delta & \\ \mathbf{p}^2 & \begin{array}{c} \swarrow \downarrow \searrow \\ \vdots \end{array} & \mathbf{p}^{2,\text{op}} \\ & & \\ & & m \\ & & \mathbb{I} \end{array} = (f \boxtimes_{\mathbf{q}} \mathbb{I}_P) \boxtimes \mathbb{I}_N,$$

as claimed.

The boundedness assumptions imply that all the sums considered above are finite.  $\square$

**Corollary 3.67.** *Fix a module-map primitive  $\mathbf{q}$  compatible with module diagonal primitives  $\mathbf{p}^1$  and  $\mathbf{p}^2$ . Let  $\mathbf{m}^i$  be the module diagonal induced by  $\mathbf{p}^i$  and let  $\ell$  be any module-map diagonal compatible with  $\mathbf{m}^1$  and  $\mathbf{m}^2$ . Then for any  $A_\infty$ -modules  $\mathcal{M}_1$ ,  $\mathcal{M}_2$ , and  $\mathcal{N}$ , type  $DD$  structure  $P$ , and  $A_\infty$ -module homomorphism  $f: \mathcal{M}_1 \rightarrow \mathcal{M}_2$  (with either  $P$  bounded or all the other objects *bonsai*), the chain maps*

$$[f \boxtimes \mathbb{I}_P \boxtimes \mathbb{I}_N]_{\ell}$$

and

$$(f \boxtimes_{\mathbf{q}} \mathbb{I}_P) \boxtimes \mathbb{I}_N$$

are chain homotopic.

*Proof.* This is immediate from Lemma 3.66 and the fact that all partial module-map diagonals are homotopic (Lemma 2.67).  $\square$

**3.6. Further tensor products of modules and bimodules.** We collect here a few other tensor products of bimodules, generalizing the earlier constructions. We subdivide these into two types: internal tensor products and external tensor products.

Examples of internal tensor products that we have already defined are:

- The box product of an  $A_\infty$ -module and a type  $D$  structure, as recalled in Section 3.5.
- Given  $DA$  structures  ${}^A P_{\mathcal{B}}$  and  ${}^B Q_{\mathcal{C}}$  (see Definition 3.68 or [LOT15, Definition 2.2.43]), the  $DA$  structure  ${}^A P_{\mathcal{B}} \boxtimes {}^B Q_{\mathcal{C}}$  [LOT15, Figure 4] (see also Figure 17).
- Given an  $A_\infty$ -bimodule  ${}_{\mathcal{A}} \mathcal{M}_{\mathcal{B}}$  and a  $DA$  structure  ${}^B Q_{\mathcal{C}}$ , the  $A_\infty$ -bimodule  ${}_{\mathcal{A}} \mathcal{M}_{\mathcal{B}} \boxtimes {}^B Q_{\mathcal{C}}$  [LOT15, Figure 4] (see also Figure 17).
- The triple box product of a type  $DD$  structure and two  $A_\infty$ -modules (Section 3.5), using a module diagonal.
- The one-sided box tensor product of a type  $DD$  structure and an  $A_\infty$ -module (Section 3.5), using a module diagonal primitive.



FIGURE 17. **Box products of two  $DA$  structure, and of an  $A_\infty$ -bimodule and a  $DA$  structure.** Left: the structure map for a box tensor product  ${}^{\mathcal{A}}P_{\mathcal{B}} \boxtimes {}^{\mathcal{B}}Q_{\mathcal{C}}$  of two  $DA$  structure. Right: the structure map of a box tensor product  ${}_{\mathcal{A}}\mathcal{M}_{\mathcal{B}} \boxtimes {}^{\mathcal{B}}Q_{\mathcal{C}}$  of an  $A_\infty$ -bimodule and a  $DA$  structure. In each case, boundedness criteria must be satisfied for the definition to make sense. See [LOT15] for more details.

Given  $A_\infty$ -modules  $\mathcal{M}_{\mathcal{A}}$  and  $\mathcal{N}_{\mathcal{B}}$ , the tensor product  $(\mathcal{M} \otimes_{\mathcal{M}} \mathcal{N})_{\mathcal{A} \otimes_{\Gamma} \mathcal{B}}$  from Section 3.3 is an example of an external tensor product. An even simpler example of an external tensor product occurs if  $\mathcal{A}$  and  $\mathcal{B}$  are  $A_\infty$ -algebras over  $\mathbb{k}$  with  $\mathcal{B}$  strictly unital, and  ${}^{\mathcal{B}}P$  and  $\mathcal{M}_{\mathcal{A}}$  are a type  $D$  structure and an  $A_\infty$ -module, respectively. In this case,  $P \otimes M$  can be endowed with the structure of a type  $DA$  structure (in the sense recalled below), with operations

$$\begin{aligned} \delta_1^1(x \otimes y) &= \mathbf{1} \otimes x \otimes m_1(y) + \delta^1(x) \otimes y \\ \delta_{\ell+1}^1(x \otimes y, a_1, \dots, a_\ell) &= \mathbf{1} \otimes x \otimes m_{\ell+1}(y, a_1, \dots, a_\ell). \end{aligned}$$

In the next sections we handle a few more cases.

3.6.1. *Box product of an  $A_\infty$ -bimodule and a type  $DD$  structure.* Fix  $A_\infty$ -algebras  $\mathcal{A}$ ,  $\mathcal{B}$ , and  $\mathcal{C}$ , over  $\mathbb{k}_1$ ,  $\mathbb{k}_2$ , and  $\mathbb{k}_3$ , respectively, with  $\mathcal{C}$  strictly unital with unit  $\mathbf{1}$ . Fix also an  $A_\infty$ -bimodule  ${}_{\mathcal{A}}\mathcal{M}_{\mathcal{B}}$  and a type  $DD$  structure  ${}^{\mathcal{B}, \mathcal{C}}P$ . The goal of this section is to use a primitive to construct a type  $DA$  structure  ${}_{\mathcal{A}}\mathcal{M}_{\mathcal{B}} \boxtimes {}^{\mathcal{B}}P^{\mathcal{C}^{\text{op}}}$ .

We start by recalling the definition of a type  $DA$  structure.

**Definition 3.68.** *Let  $\mathcal{A}$  and  $\mathcal{B}$  be algebras over  $\mathbb{k}_1$  and  $\mathbb{k}_2$  respectively, and let  $Q = {}_{\mathbb{k}_1}Q_{\mathbb{k}_2}$  be a  $(\mathbb{k}_1, \mathbb{k}_2)$ -bimodule. Given a collection of bimodule homomorphisms*

$$\{\delta_{1+n}^1: Q \otimes B^{\otimes n} \rightarrow A \otimes Q \langle\langle 1-n \rangle\rangle\}_{n=1}^\infty,$$

*we say that  $(Q, \{\delta_{1+n}^1\})$  is a type  $DA$  structure if the following condition holds. Define  $\delta^1 = \sum_j \delta_j^1: Q \otimes \mathcal{T}^*(B \langle\langle 1 \rangle\rangle) \rightarrow A \langle\langle 1 \rangle\rangle \otimes Q$ , and inductively define*

$$\delta^n = (\mathbb{I}_{A \otimes (n-1)} \otimes \delta^1) \circ (\delta^{n-1} \otimes \mathbb{I}_{\mathcal{T}^*B}) \circ (\mathbb{I}_Q \otimes \Delta)$$

*where  $\Delta: \mathcal{T}^*B \rightarrow \mathcal{T}^*B \otimes \mathcal{T}^*B$  is the comultiplication. Let*

$$\delta = \sum_n \delta^n: Q \otimes \mathcal{T}^*(B \langle\langle 1 \rangle\rangle) \rightarrow \overline{\mathcal{T}^*}(A \langle\langle 1 \rangle\rangle) \otimes Q.$$

*Then the structure equation is:*

$$\begin{array}{c} \downarrow \\ \delta \\ \swarrow \mu^{\mathcal{A}} \\ \downarrow \end{array} + \begin{array}{c} \downarrow \\ \delta \\ \swarrow \mu^{\mathcal{B}} \\ \swarrow \end{array} = 0.$$

*This makes sense if either  $\mathcal{A}$  is bonsai, or for each  $k$  there is an  $N$  so that  $\delta_k^n = 0$  for all  $n > N$ . (Here,  $\delta_k^n$  is the component of  $\delta^n$  taking  $k$  total inputs.) When talking about a type  $DA$  structure, we always assume one of these conditions holds. If the second condition holds, we say that  $P$  is left bounded. We say that  $P$  is bounded if there is an  $N$  so that  $\delta_k^n = 0$  whenever  $n + k > N$ .*

Note that left boundedness is automatic if  $\delta_1^1 = 0$  (cf. Section 3.6.2).

To define  ${}_{\mathcal{A}}\mathcal{M}_{\mathcal{B}} \boxtimes {}^{\mathcal{B}}P^{\mathcal{C}^{\text{op}}}$  we need one further kind of tree. A *bimodule tree* is a pair of an element  $T \in \mathcal{T}_n$  and an integer  $1 \leq i \leq n$ . The integer  $i$  corresponds to a distinguished input of  $T$ , which we think of as the module input. Call vertices between the  $i^{\text{th}}$  input of  $T$  and the output of  $T$  *bimodule vertices*, and call vertices to the left (respectively right) of the bimodule vertices *left algebra* (respectively *right algebra*) vertices. Given an  $A_{\infty}$ -bimodule  ${}_{\mathcal{A}}\mathcal{M}_{\mathcal{B}}$  and a bimodule tree  $(T, i)$  there is an induced map  $m(T, i): A^{\otimes i-1} \otimes M \otimes B^{\otimes n-i} \rightarrow M$ , by applying the operation  $m$  on  $M$  at the bimodule vertices of  $T$  and the operation  $\mu^{\mathcal{A}}$  (respectively  $\mu^{\mathcal{B}}$ ) at the left (respectively right) algebra vertices. We will typically suppress the integer  $i$  and refer to a bimodule tree  $T$ .

The operation LeJ of left joining extends to an operation on bimodule trees by composing at the distinguished inputs. The original case of LeJ is the case that all of the distinguished inputs were left-most.

Let  $S$  be a tree with  $1 + \ell$  inputs. Given an integer  $k \geq 0$ , a *k-left enlargement* of  $S$  is a tree  $S'$  with  $k + 1 + \ell$  inputs and the same number of internal vertices, with the property that if we remove the edges adjacent to the first  $k$  inputs of  $S'$  the resulting tree is  $S$ . We view  $S'$  as a bimodule tree where the  $(k + 1)^{\text{st}}$  vertex is distinguished. There is a corresponding map

$${}_k E: C_*^{\text{cell}}(K_{\ell+1}) \rightarrow C_{**k}^{\text{cell}}(K_{k+\ell+1})$$

that sends a tree  $S$  to the sum of all of its  $k$ -enlargements. The operation  ${}_k E$  satisfies

(3.69)

$$\partial({}_k E(T)) + {}_k E(\partial(T)) = \sum_{\ell=0}^{k-1} \ell E(T) \circ_{\ell+1} \Psi_{k-\ell+1} + \sum_{\ell=0}^{k-1} \Psi_{k-\ell+1} \circ_{k-\ell+1} \ell E(T) + \sum_{\ell=1}^{k-1} \sum_{j=1}^{\ell} \ell E(T) \circ_j \Psi_{k-\ell+1}$$

(3.70)

$$*_E(\text{LeJ}(T_1, \dots, T_n)) = \text{LeJ}(*_E(T_1), \dots, *_E(T_n))$$

where, in Equation (3.70),  $*_E(T) = \sum_k {}_k E(T)$  and LeJ is the usual left joining on the left side of the equation, and the operation LeJ on bimodule trees on the right side of the equation. The terms on the right side Equation (3.69) correspond to gluing a corolla at the top of  $T$ , and at the bottom of  $T$ , and to the left of  $T$ , respectively.

Fix a module diagonal primitive

$$\mathbf{p}_n = \sum_{(S,T)} n_{S,T}(S, T) \in \mathcal{T}_n \otimes_R \mathcal{T}_{n-1}.$$

Generalizing Lemma 3.20, the bimodule  ${}_{\mathcal{A}}\mathcal{M}_{\mathcal{B}}$  gives a chain map  $m: C_*^{\text{cell}}(K_{k+1+\ell}) \rightarrow \text{Mor}(A^{\otimes k} \otimes M \otimes B^{\otimes \ell}, M)$ . We define operations

$$\delta^1: \mathcal{T}^*(A) \otimes M \otimes P \rightarrow M \otimes P \otimes C^{\text{op}}$$

by

$$\delta_{k+1}^1((a_1 \otimes \dots \otimes a_k) \otimes x \otimes y) = m^{\mathcal{M}}(\underline{a} \otimes x) \otimes y \otimes \mathbf{1} + \sum_{(S,T)} n_{S,T}(m^{\mathcal{M}}({}_k E(S)) \otimes \mathbb{I}_P \otimes \mu^{\mathcal{C}^{\text{op}}}(T^{\text{op}})) \circ (\mathbb{I}_{A^{\otimes k}} \otimes \mathbb{I}_M \otimes \delta_P)$$

or, graphically:

$$\delta^1(\underline{a} \otimes x \otimes y) = \begin{array}{c} \underline{a} \quad x \quad y \\ \searrow \quad \downarrow \quad \downarrow \\ m_{k,1,0} \quad \downarrow \quad \downarrow \\ \downarrow \quad \downarrow \quad \downarrow \end{array} \mathbf{1} + \begin{array}{c} \underline{a} \quad x \quad y \\ \searrow \quad \downarrow \quad \downarrow \\ \downarrow \quad \swarrow \quad \downarrow \\ \downarrow \quad \downarrow \quad \downarrow \\ \downarrow \quad \downarrow \quad \downarrow \end{array} \mathbf{p}^{\text{op}},$$

where  $\underline{a} = a_1 \otimes \dots \otimes a_k$ .

Let

$${}_{\mathcal{A}}\mathcal{M}_{\mathcal{B}} \boxtimes_{\mathbf{p}} {}^{\mathcal{B}}P^{\mathcal{C}^{\text{op}}} = (M \otimes P, \delta_{1+n}^1).$$

**Proposition 3.71.** *If  ${}^{\mathcal{A}}\mathcal{M}_{\mathcal{B}}$  is bonsai or  ${}^{\mathcal{B},\mathcal{C}}P$  is bounded, then the operation  $\delta_{1+n}^1$  on  ${}^{\mathcal{A}}\mathcal{M}_{\mathcal{B}} \boxtimes_{\mathbf{P}} {}^{\mathcal{B}}P^{C^{\text{op}}}$  satisfies the type DA structure relation.*

*Proof.* This is a straightforward generalization of the proof of Lemma 3.50, using Equations (3.69) and (3.70) when needed.  $\square$

3.6.2. *Box product of a DA structure and a DD structure.* We can use DADD diagonals to define a tensor product of a type DA structure with a type DD structure, under a simplifying assumption. Specifically, suppose that the DA structure  ${}^{\mathcal{A}}Q_{\mathcal{B}}$  satisfies the condition that the operation  $\delta_1^1$  vanishes identically. (For instance, this assumption holds for the type DA structure associated to an  $A_{\infty}$ -algebra homomorphism [LOT15, Definition 2.2.48] or the type DA structures associated to arcslides in bordered Floer theory [LOT14].) In this case, the operations  $\delta_{1+n}^1$  give rise to an action

$$\lambda^Q: C_*^{\text{cell}}(J_n) \rightarrow \text{Mor}(Q \otimes B^{\otimes n}, A \otimes Q)$$

as follows. Given a multiplihedron tree  $S$  representing a generator of  $C_*^{\text{cell}}(J_n)$ , the action of  $\lambda^Q(S)$  is obtained by running an additional strand labelled by  $Q$  through all purple vertices, and thinking of the purple vertices as corresponding to  $\delta_{1+n}^1$  operations, red vertices correspond to  $\mu_n^{\mathcal{A}}$  operations, and blue vertices correspond to  $\mu_n^{\mathcal{B}}$  operations. (Note that this agrees with the standard multiplihedron action in the case the DA structure is associated to an  $A_{\infty}$ -algebra homomorphism.)

**Lemma 3.72.** *For each  $n$ , the map  $\lambda^Q: C_*^{\text{cell}}(J_n) \rightarrow \text{Mor}(Q \otimes B^{\otimes n}, A \otimes Q)$  defined above is a chain map.*

*Proof.* This follows from the DA structure relation for  ${}^{\mathcal{A}}Q_{\mathcal{B}}$  and the fact that the operation  $\delta_1^1$  vanishes identically.  $\square$

We can now specify the DD operations on  ${}^{\mathcal{A}}Q_{\mathcal{B}} \otimes {}^{\mathcal{B}}P^{\mathcal{C}}$ , as follows. Fix a DADD diagonal

$$\mathbf{r}_n = \sum_{(S,T)} n_{S,T}(S,T) \in C_*^{\text{cell}}(J_n) \otimes_R \mathcal{T}_n$$

compatible with associahedron diagonals  $\gamma^1$  and  $\gamma^2$  (Definition 2.73) and a type DD structure  ${}^{\mathcal{B},\mathcal{C}}P$  with respect to  $\gamma^1$ . Define

$$\delta^1: Q \otimes P \rightarrow A \otimes Q \otimes P \otimes C^{\text{op}}$$

by

$$\delta^1(q \otimes p) = \sum_{(S,T)} n_{S,T}(\lambda^Q(S) \otimes \mathbb{I}_P \otimes \mu^{\mathcal{C}}(T^{\text{op}})) \circ (\mathbb{I}_Q \otimes \delta_P),$$

or, graphically:

$$\delta^1 = \begin{array}{ccc} & \begin{array}{c} \vdots \\ \downarrow \\ \delta \\ \downarrow \\ \vdots \end{array} & \\ & \swarrow \quad \searrow & \\ \mathbf{r} & & \mathbf{r}^{\text{op}} \\ \swarrow \quad \downarrow & & \downarrow \end{array} .$$

This formula and the corresponding type DD structure relation make sense so long as either:

- ${}^{\mathcal{B},\mathcal{C}}P$  is bounded or
- ${}^{\mathcal{A}}Q_{\mathcal{B}}$  is bounded and  $\mathcal{B}$  and  $\mathcal{C}$  are bonsai.

**Proposition 3.73.** *Let  ${}^{\mathcal{A}}Q_{\mathcal{B}}$  be a type DA structure with  $\delta_1^1 = 0$  and  ${}^{\mathcal{B},\mathcal{C}}P$  a type DD structure with respect to  $\gamma^1$ . If  ${}^{\mathcal{A}}Q_{\mathcal{B}}$  is bounded and  $\mathcal{B}$  and  $\mathcal{C}$  bonsai, or  ${}^{\mathcal{B},\mathcal{C}}P$  is bounded and  $\mathcal{A}$  is bonsai, then the operation*

$$\delta^1: Q \otimes P \rightarrow A \otimes Q \otimes P \otimes C^{\text{op}}$$

*defined above gives  $Q \otimes P$  the structure of a type DD structure  ${}^{\mathcal{A}}Q_{\mathcal{B}} \boxtimes_{\mathbf{r}} {}^{\mathcal{B}}P^{C^{\text{op}}}$  over  $\mathcal{A}$  and  $\mathcal{C}$  with respect to  $\gamma^2$ .*

*Proof.* We have:

Here, the first equation follows from the definition of a DADD diagonal and Lemma 3.72, while the second follows from the *DD* structure relation.  $\square$

Finally, we relate these tensor products with the one-sided box tensor product of a  $A_\infty$ -module and a type *DD* structure. Let  $\mathcal{A}$  be a strictly unital  $A_\infty$ -algebra and  $\mathcal{M}_{\mathcal{A}}$  an  $A_\infty$ -module over  $\mathcal{A}$ . We can view  $\mathcal{M}_{\mathcal{A}}$  as a type *DA* structure  ${}^R\mathcal{M}_{\mathcal{A}}$  over  $R$  and  $\mathcal{A}$  by declaring that

$$\delta_{1+n}^1(x, a_1, \dots, a_n) = \mathbf{1} \otimes m_{1+n}(x, a_1, \dots, a_n).$$

So, a DADD diagonal also induces a tensor product of an  $A_\infty$ -module with a type *DD* structure. We relate this tensor product to the one coming from a module diagonal primitive:

**Proposition 3.74.** *Fix a strictly unital  $A_\infty$ -algebras  $\mathcal{A}$  and  $\mathcal{B}$ . Fix also a DADD diagonal  $\mathbf{r}$  and let  $\mathbf{p}$  be the induced module diagonal primitive, as in Proposition 2.77. Let  $\mathcal{M}_{\mathcal{A}}$  be an  $A_\infty$ -module over  $\mathcal{A}$  and  ${}^A P^{\mathcal{B}}$  a type *DD* structure over  $\mathcal{A}$  and  $\mathcal{B}$ . Assume that  $P$  is bounded or  $\mathcal{M}$ ,  $\mathcal{A}$ , and  $\mathcal{B}$  are bonsai. Then there is an isomorphism of type *DA* structures over  $R$  and  $\mathcal{B}$*

$$({}^R\mathcal{M}_{\mathcal{A}}) \boxtimes_{\mathbf{r}} {}^A P^{\mathcal{B}} \cong {}^R(\mathcal{M}_{\mathcal{A}} \boxtimes_{\mathbf{p}} {}^A P^{\mathcal{B}}).$$

*Proof.* This is immediate from the definitions.  $\square$

3.6.3. *External tensor product of a DA structure and an  $A_\infty$ -module.* Given a type *DA* structure  ${}_{\mathcal{B}}X^{\mathcal{C}}$ , an  $A_\infty$ -module  ${}_{\mathcal{A}}\mathcal{M}$ , and a module diagonal primitive, we can form the *DA* structure  ${}_{\mathcal{A}^{\text{op}} \otimes \mathcal{B}}(\mathcal{M}^{\text{op}} \otimes X)^{\mathcal{C}}$ . Diagrams depicting the structure map on  $\mathcal{M}^{\text{op}} \otimes X$  are reminiscent of the proof



of Lemma 3.52. We draw the algebra elements  $\underline{a} = (a_1 \otimes b_1) \otimes \dots \otimes (a_\ell \otimes b_\ell)$  in the middle:

$$(3.75) \quad \delta^1(x, \underline{a}, y) = \left( \begin{array}{ccc} x & \emptyset & y \\ \downarrow & & \downarrow \\ m_1 & & \mathbf{1} \\ \downarrow & & \downarrow \end{array} \right) + \left( \begin{array}{ccc} x & \underline{a} & y \\ \downarrow & \Delta & \downarrow \\ \mathbf{p} & \vdots & \mathbf{p}^{\text{op}} \\ \downarrow & \Delta & \downarrow \\ \mathbf{p} & \vdots & \mathbf{p}^{\text{op}} \\ \downarrow & & \downarrow \\ & & \delta^1 \end{array} \right),$$

Here,

$$\Delta: \mathcal{T}^*(A \otimes B) \rightarrow \mathcal{T}^*(A \otimes B) \otimes \mathcal{T}^*(A \otimes B) \otimes \mathcal{T}^*(A \otimes B)$$

denotes all ways of splitting up the sequence  $\underline{a}$  into three (or, at the bottom, two) sequences (without breaking up any individual factor  $a_i \otimes b_i$ ). The first term contributes only when the incoming sequence of algebra elements is empty (i.e.,  $\ell = 0$ ).

**Proposition 3.76.** *Let  $\mathcal{A}$  and  $\mathcal{B}$  be  $A_\infty$ -algebras over  $\mathbb{k}_1$  and  $\mathbb{k}_2$  and  $\mathcal{C}$  a strictly unital  $A_\infty$ -algebra over  $\mathbb{k}_3$ , and assume that  $\mathcal{M}_{\mathcal{A}}$  and  ${}_{\mathcal{B}}N^{\mathcal{C}}$  are a bonsai module and bounded DA structure, respectively. Then  $M \otimes_R N$  can be given the structure of a DA structure, with input algebra  $\mathcal{A} \otimes_R \mathcal{B}^{\text{op}}$  on the right and output algebra  $\mathcal{C}$  (on the left), with operations specified in Equation (3.75)*

*Proof.* The proof is a minor adaptation of the proof of Lemma 3.50. □

**3.7. Units in  $A_\infty$ -algebras.** In this section we recall that a weaker notion of a unit an  $A_\infty$ -algebra can be strictified to a strict unit, and discuss corresponding notions for modules and morphisms.

**Definition 3.77.** *An  $A_\infty$ -algebra  $\mathcal{A}$  is weakly unital if there is an element  $\mathbf{1} \in A$  so that  $\mu_1(\mathbf{1}) = 0$  and for all  $a \in A$ ,  $\mu_2(a, \mathbf{1}) = \mu_2(\mathbf{1}, a) = a$ .*

**Definition 3.78.** *A weakly unital  $A_\infty$ -algebra  $\mathcal{A}$  is strictly unital if for all  $n \geq 3$  and  $a_1, \dots, a_n \in \mathcal{A}$ , if some  $a_i = \mathbf{1}$  then  $\mu_n(a_1, \dots, a_n) = 0$ .*

If  $\mathcal{A}$  and  $\mathcal{B}$  are weakly unital  $A_\infty$ -algebras, it follows from the non-degeneracy condition of an associahedron diagonal that  $\mathcal{A} \otimes_{\mathbf{\Gamma}} \mathcal{B}$  is weakly unital. By contrast, even if  $\mathcal{A}$  and  $\mathcal{B}$  are strictly unital,  $\mathcal{A} \otimes_{\mathbf{\Gamma}} \mathcal{B}$  may not be (unless  $\mathbf{\Gamma}$  satisfies an extra condition). Thus, if one prefers to work with strictly unital algebras, one needs a procedure to turn a weakly unital one into a strictly unital one (or to work with special diagonals).

There is an analogous notion for homomorphisms:

**Definition 3.79.** *Let  $\mathcal{A}$  and  $\mathcal{B}$  be two weakly unital  $A_\infty$ -algebras over  $\mathbb{k}$ . A homomorphism  $f: \mathcal{A} \rightarrow \mathcal{B}$  (in the sense of Definition 3.10) is weakly unital if  $f_1$  carries the unit  $\mathbf{1}_{\mathcal{A}}$  in  $\mathcal{A}$  to the unit  $\mathbf{1}_{\mathcal{B}}$  in  $\mathcal{B}$ . A homomorphism  $f$  is strictly unital if  $f_1(\mathbf{1}_{\mathcal{A}}) = \mathbf{1}_{\mathcal{B}}$  and for each  $n > 1$ ,  $f_n(a_1, \dots, a_n) = 0$  if some  $a_i = \mathbf{1}_{\mathcal{A}}$ .*

The following is a special case of the well-known result that homologically unital  $A_\infty$ -algebras (a notion we will not use) are quasi-isomorphic to strictly unital ones [Laz03, LH03, Sei08]; our proof follows Seidel [Sei08]:

**Theorem 3.80.** *Every weakly unital  $A_\infty$ -algebra  $\mathcal{A}$  over  $\mathbb{k}$  is isomorphic to a strictly unital  $A_\infty$ -algebra  $\mathcal{A}'$ , and the isomorphism can be chosen to be weakly unital. If  $\mathcal{A}$  is bonsai then  $\mathcal{A}'$  and the isomorphism can both be chosen to be bonsai as well.*

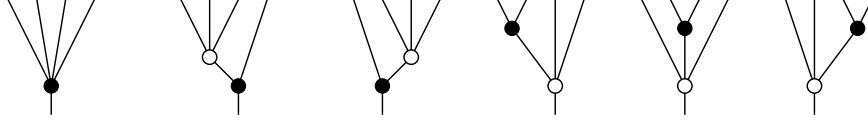

FIGURE 18. **The  $\overline{\mathcal{A}}$ -operation trees with  $n = 3$  and  $j = 4$  inputs.** The white vertices are labelled by  $\phi_3$ , and the black vertex by a  $\mu$ -operation.

We sketch a proof of Theorem 3.80, after some preliminary discussion. To set it up, let

$$\phi_n: \overbrace{A \otimes \dots \otimes A}^n \rightarrow B$$

be a map of  $\mathbb{k}$ -bimodules. Define

$$d\phi_n = \mu_1 \circ \phi_n + \sum_{i=1}^n \phi_n \circ (\mathbb{I}_{A^{\otimes i-1}} \otimes \mu_1 \otimes \mathbb{I}_{A^{\otimes n-i}}).$$

(This is the differential of  $\phi_n$  thought of as an element of  $\text{Mor}(A^{\otimes n}, B)$ , the morphism complex of chain complexes.)

**Lemma 3.81.** [LH03, Lemme 3.2.2.2] *Suppose that  $\mathcal{A}$  is an  $A_\infty$ -algebra over  $\mathbb{k}$ , and  $\phi_n: A^{\otimes n} \rightarrow A$  is any  $\mathbb{k}$ -bimodule map of degree  $n-1$  with  $n > 1$  (where the tensor products are taken over  $\mathbb{k}$ ). Then there is an  $A_\infty$ -algebra  $\overline{\mathcal{A}}$  isomorphic to  $\mathcal{A}$  so that  $\overline{\mu}_i = \mu_i$  for  $i < n$  and*

$$\overline{\mu}_n = \mu_n + d\phi_n.$$

Moreover, if  $n > 2$  or  $n = 2$  and  $d\phi_2 = 0$  then

$$\overline{\mu}_{n+1} = \mu_{n+1} + \mu_2 \circ (\mathbb{I}_A \otimes \phi_n) + \mu_2 \circ (\phi_n \otimes \mathbb{I}_A) + \sum_{i=1}^{n-1} \phi_n (\mathbb{I}_{A^{\otimes i-1}} \otimes \mu_2 \otimes \mathbb{I}_{A^{\otimes n-i-1}}).$$

*Proof.* By the *trunk vertex* of a rooted, planar tree we mean the internal vertex adjacent to the root.

We will express the operations on  $\overline{\mathcal{A}}$  graphically, as follows. An  $\overline{\mathcal{A}}$ -operation tree is a planar, rooted tree  $T$  with internal vertices labelled as follows:

- There is one distinguished vertex, labelled by the operation  $\mu_k$  with  $k \geq 1$ , with  $k$  inputs.
- All other vertices have  $n$  inputs, and are labelled by  $\phi$ .
- The distinguished vertex is either the trunk vertex, or it is one of the parents of the trunk vertex.

Let  $\mathcal{T}'$  denote the set of  $\overline{\mathcal{A}}$ -operation trees. For example, if  $j < n$ , then there is a unique  $\overline{\mathcal{A}}$ -operation tree with  $j$  inputs: the corolla  $\Psi_j$  marked by  $\mu_j$ . There are  $n+2$   $\overline{\mathcal{A}}$ -operation trees with  $n$  inputs (a distinguished corolla, or a distinguished 2-valent vertex attached to an undistinguished vertex), and for  $n > 2$ , there are  $n+3$  different  $\overline{\mathcal{A}}$ -operation trees with  $n+1$  inputs, as in Figure 18.

Summing over all  $\overline{\mathcal{A}}$ -operation trees with  $j$  inputs induces a map

$$\overline{\mu}_j: A^{\otimes j} \rightarrow A.$$

We assert that the operations  $\overline{\mu}_j$  satisfy the  $A_\infty$  relations

$$\sum_{k=0}^{m-1} \sum_{i=1}^{m-k} \overline{\mu}_{m-k} \circ (\mathbb{I}_{A^{\otimes i-1}} \otimes \overline{\mu}_{k+1} \otimes \mathbb{I}_{A^{\otimes (m-i-k)}}) = 0.$$

This amounts to proving that the sum over all trees  $T_1, T_2 \in \mathcal{T}'$  of the operation obtained by composing  $T_1$  and  $T_2$  vanishes.

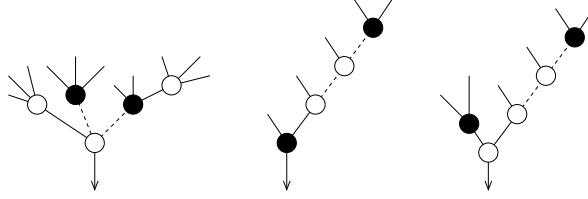

FIGURE 19. **Cancellations of tree juxtapositions.** We have drawn trees  $S \in \mathcal{S}'$ , with distinguished vertices black. (In the first case, the valence  $n$  of the undistinguished vertices is 3; while in the second two  $n = 2$ .) In each case, cutting either of the two dotted edges gives juxtapositions of pairs of trees in  $\mathcal{T}'$ .

To this end, let  $\mathcal{S}'$  be the set of trees  $S$  that can be obtained by composing  $T_1, T_2 \in \mathcal{T}'$ . This means that  $S$  has exactly two distinguished vertices that are marked by operations in  $\mathcal{A}$ , at least one of them has distance  $\leq 1$  from the trunk vertex, and all other vertices are marked by  $\phi_n$ .

Suppose that  $S \in \mathcal{S}'$  has two consecutive distinguished vertices. Such trees  $S$  can be uniquely decomposed as the juxtaposition of  $T_1$  and  $T_2$ : the trees  $T_1$  and  $T_2$  are obtained by cutting along the edge connecting the two distinguished vertices in  $S$ . The set of such trees can be alternatively obtained from the set  $\mathcal{T}'$  by inserting an edge at the distinguished vertex. From this description, it is clear that the  $A_\infty$  relation on  $\mathcal{A}$  ensures that the sum of the contributions of  $S \in \mathcal{S}'$  with two consecutive distinguished vertices vanishes.

To complete the argument we claim that if  $S \in \mathcal{S}'$  can be written as a juxtaposition of  $T_1, T_2 \in \mathcal{T}'$  so that the distinguished vertices are not consecutive, then  $S$  has exactly two such decompositions. So, suppose that  $S$  is of this form, and let  $d_1$  and  $d_2$  denote the distances of the two distinguished vertices  $v_1$  and  $v_2$  to the root, chosen so that  $d_1 \leq d_2$ . Since we assumed that the distinguished vertices are not consecutive, there are two cases: either  $d_1 = d_2 = 1$  or  $d_2 > 1$ . If  $d_1 = d_2 = 1$ , the two decompositions are obtained by cutting the edge immediately below  $v_1$  or  $v_2$ . If  $d_2 > 1$ , then we can either cut the edge immediately below  $v_2$  or two below  $v_2$  to obtain the two decompositions of  $S$  into trees in  $\mathcal{T}'$ . See Figure 19.

Next, we argue that  $\mathcal{A}$  and  $\overline{\mathcal{A}}$  are isomorphic. We construct a morphism  $\phi: \mathcal{A} \rightarrow \overline{\mathcal{A}}$  that has  $\phi_1$  the identity map,  $\phi_n$  as specified in the lemma, and  $\phi_i = 0$  for  $i \neq 1, n$ . Since any  $A_\infty$ -algebra homomorphism  $\phi$  with  $\phi_1$  an isomorphism is an  $A_\infty$ -algebra isomorphism [LOT15, Lemma 2.1.14], all that remains is to verify the  $A_\infty$  relations for  $\phi$ .

To this end, consider one of the  $A_\infty$  relations and all the trees that appear in it, once the purple vertices have been replaced by either the identity (and erased) or  $\phi$ , the red vertices have been replaced by a  $\mu_k$ , and the blue vertices have been replaced by an  $\overline{\mathcal{A}}$ -operation tree as above. These trees all have a single distinguished vertex, and, in fact, are all in  $\mathcal{T}'$ . We must verify that each tree  $T \in \mathcal{T}'$  appears an even number of times in the  $A_\infty$  relation. Call a vertex  $v$  of  $T$  *highest* if all parents of  $v$  are leaves of  $T$ . Suppose that  $T$  has  $k$  highest, undistinguished vertices. Then  $T$  appears with multiplicity  $2^k$  in part of the  $A_\infty$  relation corresponding to  $\overline{\mu} \circ \phi$ . (The case  $k = 2$  is shown in Figure 20.) When  $k = 0$ , the tree also appears once in  $\phi \circ \mu$ ; and indeed, those are precisely the trees that appear in  $\phi \circ \mu$ .

The statement about the form of  $\overline{\mu}_{n+1}$  follows from our more general description of  $\overline{\mu}_j$ .  $\square$

*Remark 3.82.* A shorter, but less explicit proof of Lemma 3.81 is the following (cf. [LH03, Lemme 3.2.2.2], [Sei08, Section (1c)]). Given an  $A_\infty$ -algebra  $\mathcal{A}$  and a collection of maps  $f_n: A^{\otimes n} \rightarrow B$  with  $f_1$  an isomorphism, one can inductively solve the  $A_\infty$ -homomorphism relations to define operations  $\mu_n^{\mathcal{B}}: B^{\otimes n} \rightarrow B$  satisfying Equation (3.11). It follows from the fact that  $\mathcal{B} = (B, \{\mu_n^{\mathcal{B}}\})$  is isomorphic to  $\mathcal{A}$  (via  $\{f_n\}$ ) that the  $\mu_n^{\mathcal{B}}$  satisfy the  $A_\infty$ -algebra relations. Lemma 3.81 is the special case  $f_1 = \mathbb{I}$ ,  $f_n = \phi_n$  given, and  $f_i = 0$  for  $i \notin \{1, n\}$ .

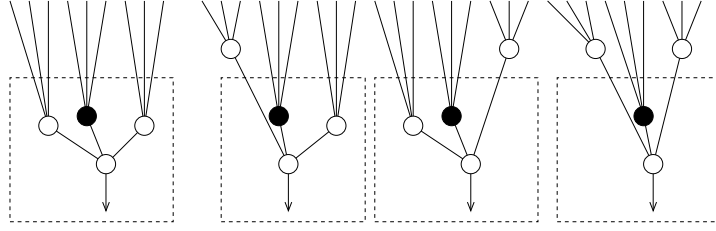

FIGURE 20. **Verifying the  $A_\infty$  relation for the map.** The tree pictured here has  $k = 2$ , and it has 4 contributions to the  $A_\infty$  relation for the morphism determined by  $\phi$ . The portions of the trees corresponding to the differential  $\mu'$  are contained in the dashed boxes.

We will also use the following property of bonsai-ness. Suppose that  $T$  is a planar, rooted tree with  $n$  input leaves, but which is allowed to have 2-valent vertices, and  $\mathcal{A} = (A, \mu)$  is an  $A_\infty$ -algebra. There is still an induced map  $\mu(T): A^{\otimes n} \rightarrow A$ . Define the dimension of  $T$  as in Definition 2.8; note that each 2-valent vertex decreases the dimension of  $T$  by 1.

**Lemma 3.83.** *If  $\mathcal{A}$  is a bonsai  $A_\infty$ -algebra with bonsai constant  $N$  and  $T$  is a planar, rooted tree possibly with 2-valent vertices with  $\dim(T) > N$  then  $\mu(T) = 0$ . Similar statements hold for modules, algebra homomorphisms, and module morphisms.*

*Proof.* Fix a tree  $T$  with  $\dim(T) > N$ . Inductively applying the  $A_\infty$  relation at each  $n > 2$  valent vertex which is followed by a 2-valent vertex,  $\mu(T)$  is equal to a linear combination of operations  $\mu(T')$  where all of the 2-valent vertices of  $T'$  are adjacent to the input leaves, with  $\dim(T') = \dim(T)$ . So, it suffices to prove the result for such trees  $T'$ . Suppose that  $T'$  has  $k$  2-valent vertices. Let  $S$  be the result of forgetting the 2-valent vertices of  $T'$ . Then  $\dim(S) = \dim(T') + k > N + k$ . So,  $\mu(S)$  vanishes; but this implies that  $\mu(T')$  vanishes, as well.  $\square$

*Proof of Theorem 3.80.* We wish to find an isomorphic model for  $\mathcal{A}$  satisfying

$$(3.84) \quad \mu_{m+1}(a_1, \dots, a_{j-1}, \mathbf{1}, a_j, \dots, a_m) = 0$$

for all  $m > 1$  and  $j = 1, \dots, m+1$ . We will inductively modify the actions  $\mu_n$  on  $\mathcal{A}$ , for  $n = 3, 4, \dots$ , to obtain Equation (3.84).

So, suppose there are  $n \geq 2$  and  $k$  so that Equation (3.84) holds for all  $1 < m < n$  and for  $m = n$  and  $j < k$ . We will construct an isomorphic algebra  $\mathcal{A}$  which has the same underlying  $\mathbb{k}$ -bimodule and  $\mu_i$  actions for  $i < n+1$ , and a new  $\mu_{n+1}$  action satisfying Equation (3.84) for all  $j < k+1$ , provided that  $k+1 < n+1$ ; the case  $k = n$  is dealt with separately at the end.

Let

$$\phi_n(a_1, \dots, a_n) = \mu_{n+1}(a_1, \dots, a_k, \mathbf{1}, a_{k+1}, \dots, a_n).$$

The  $A_\infty$  relation with input  $(a_1, \dots, a_k, \mathbf{1}, a_{k+1}, \dots, a_n)$  and the inductive hypothesis shows that  $d\phi_n = 0$ . Thus, we can apply Lemma 3.81, to construct a new action with

$$\bar{\mu}_{n+1} = \mu_{n+1} + \mu_2 \circ (\mathbb{I}_A \otimes \phi_n) + \mu_2 \circ (\phi_n \otimes \mathbb{I}_A) + \sum_{i=1}^{n-1} \phi_n(\mathbb{I}_{A^{\otimes i-1}} \otimes \mu_2 \otimes \mathbb{I}_{A^{\otimes n-i}}).$$

The  $A_\infty$  relation with input  $(a_1, \dots, a_k, \mathbf{1}, \mathbf{1}, a_{k+1}, \dots, a_n)$  proves that

$$\bar{\mu}_{n+1}(a_1, \dots, a_k, \mathbf{1}, a_{k+1}, \dots, a_n) + (d\psi_{n+1})(a_1, \dots, a_k, \mathbf{1}, a_{k+1}, \dots, a_n) = 0,$$

where  $\psi_{n+1} = \psi_{n+1}^k: A^{\otimes n+1} \rightarrow A$  is the function defined by

$$\psi_{n+1}(a_1, \dots, a_{n+1}) = \mu_{n+2}(a_1, \dots, a_k, \mathbf{1}, a_{k+1}, \dots, a_{n+1}).$$

Further, it follows from the  $A_\infty$  relation with input  $(a_1, \dots, a_{i-1}, \mathbf{1}, a_{i+1}, \dots, a_k, \mathbf{1}, a_{k+1}, \dots, a_{n+1})$  that

$$(d\psi_{n+1})(a_1, \dots, a_{i-1}, \mathbf{1}, a_{i+1}, \dots, a_{n+1}) = 0$$

if  $i \leq k$ . Applying Lemma 3.81 once again, this time using  $\psi_{n+1}$ , we find a new algebra  $\overline{\mathcal{A}}$  isomorphic to  $\mathcal{A}$  whose operations satisfy Equation (3.84) with the following possible pairs  $(m, j)$ :

- for all  $1 < m < n$  and  $j = 1, \dots, m+1$  and
- for  $m = n$  and  $j < k+1$ .

Thus, by induction on  $k$ , we can arrange for

$$\mu_{m+1}(a_1, \dots, a_j, \mathbf{1}, a_{j+1}, \dots, a_m) = 0$$

if  $m < n$  or  $m = n$  and  $j < n$ . We can extend to the case where  $m = n$  and  $j = n$  by another application of Lemma 3.81. Specifically, for  $\psi_{n+1} = \mu_{n+1}(a_1, \dots, a_n, a_{n+1}, \mathbf{1})$  Lemma 3.81 gives a new  $A_\infty$  structure with  $\overline{\mu}_{n+1} = \mu_{n+1} + d\psi_{n+1}$ . The  $A_\infty$  relation with input  $(a_1, \dots, a_n, \mathbf{1}, \mathbf{1})$  ensures that

$$\mu_{n+1}(a_1, \dots, a_n, \mathbf{1}) + d\psi_{n+1}(a_1, \dots, a_n, \mathbf{1}) = 0.$$

The above inductive procedure constructs a sequence of isomorphic algebras  $\mathcal{A}_{n,k}$ , where the algebra operations  $\mu_i$  on  $\mathcal{A}_{n,k}$  and  $\mathcal{A}_{m,\ell}$  coincide as long as  $i \leq \min\{m, n\}$ . The desired algebra  $\mathcal{A}_{\infty, \infty}$  has the same  $\mu_i$  as  $\mathcal{A}_{n,k}$  for any  $n \geq i$ .

Observe that at each stage of the induction, the isomorphism  $f$  given by Lemma 3.81 has  $f_1 = \mathbb{I}$ . In particular,  $f$  is weakly unital.

Finally, we must show that if  $\mathcal{A}$  is bonsai then so is  $\mathcal{A}_{\infty, \infty}$ . Observe that, from the proof of Lemma 3.81 applied to the  $\psi_{n+1}^k$  defined above, each  $A_\infty$  operation  $\mu_n$  on  $\mathcal{A}_{\infty, \infty}$  is a finite sum of operations of the form  $\mu^A(T)$ , with  $\mathbf{1}$  fed into some of the inputs and some 2-valent vertices allowed. In particular, any  $A_\infty$  operation tree for  $\mathcal{A}_{\infty, \infty}$  is a linear combination of  $A_\infty$  operation trees  $\mu(T)$  for  $\mathcal{A}$ , of the same grading (dimension), with  $\mathbf{1}$  as some of the inputs. Thus, if the  $\mu^A(T)$  vanish for  $T$  of sufficiently large dimension, by Lemma 3.83, the same is true for  $\mathcal{A}_{\infty, \infty}$ . The isomorphism from  $\mathcal{A}$  to  $\mathcal{A}_{\infty, \infty}$  is also bonsai, by the same reasoning.  $\square$

This discussion has the following adaptation to modules.

**Definition 3.85.** *An  $A_\infty$ -module  $\mathcal{M}$  over a weakly unital  $A_\infty$ -algebra is called weakly unital if  $m_2(x, \mathbf{1}) = x$  for all  $x \in M$ . A weakly unital  $A_\infty$ -module over a strictly unital  $A_\infty$ -algebra is called strictly unital if for all  $n \geq 2$ ,  $x \in M$ , and  $a_1, \dots, a_n \in \mathcal{A}$ , we have that  $m_{1+n}(x, a_1, \dots, a_n) = 0$  if some  $a_i = \mathbf{1}$ .*

We have the following analogue of Theorem 3.80:

**Theorem 3.86.** *Every weakly unital  $A_\infty$ -module  $\mathcal{M}$  over a strictly unital  $A_\infty$ -algebra is isomorphic to a strictly unital module  $\mathcal{M}'$ . If  $\mathcal{M}$  is bonsai we may arrange that  $\mathcal{M}'$  and the isomorphism from  $\mathcal{M}$  to  $\mathcal{M}'$  are also bonsai.*

The proof rests on the following analogue of Lemma 3.81:

**Lemma 3.87.** *Suppose that  $\mathcal{M}$  is an  $A_\infty$ -module and*

$$\phi_n: M \otimes A \otimes \dots \otimes A \rightarrow M$$

*is any  $\mathbb{k}$ -module map of degree  $n-1$ . There is an  $A_\infty$ -module  $\overline{\mathcal{M}}$  isomorphic to  $\mathcal{M}$  so that  $\overline{m}_i = m_i$  for  $i < n$  and*

$$\overline{m}_n = m_n + d\phi_n.$$

*Proof.* The proof is similar to the proof of Lemma 3.81, with the following modifications. The  $\overline{\mathcal{M}}$ -operation trees are planar, rooted trees with the following properties:

- There is a distinguished internal vertex, which is labelled  $m_k$  if it is contained along the leftmost path, and  $\mu_k$  otherwise.
- All other vertices occur along the leftmost path, and are labelled  $\phi_n$ .
- The distinguished vertex is either the trunk vertex (in which case it is labelled  $m_k$ ), or it is a parent of the trunk vertex (in which case it can be either  $m_k$  or  $\mu_k$ ).

These trees induce the operations

$$\overline{m}_k: M \otimes A^{\otimes(k-1)} \rightarrow M.$$

The proof that they satisfy the  $A_\infty$  relations is as before. The  $A_\infty$ -map  $\phi: \mathcal{M} \rightarrow \overline{\mathcal{M}}$  is once again given by  $\phi_1 = \mathbb{I}$  and  $\phi_n$  as specified. It is straightforward to verify that  $\phi$  is a homomorphism, and it then follows from Lemma 3.31 that  $\phi$  is an isomorphism.  $\square$

*Proof of Theorem 3.86.* This is similar to the proof of Theorem 3.80. Again, we assume that  $m_{m+1}(x, a_1, \dots, \mathbf{1}, a_{i+1}, \dots, a_m) = 0$  if  $1 < m < n$  or  $m = n$  and  $i < k$ . Applying the  $A_\infty$  relation to  $(x, a_1, \dots, a_{k-1}, \mathbf{1}, \mathbf{1}, a_{k+1}, \dots, a_n)$ , we find that if we choose

$$\phi_{n+1}(x, a_1, \dots, a_n) = m_{n+1}(x, a_1, \dots, a_{k-1}, \mathbf{1}, a_k, a_{k+1}, \dots, a_n),$$

then

$$m_{n+1}(x, a_1, \dots, a_{k-1}, \mathbf{1}, a_{k+1}, \dots, a_n) + d\phi_{n+1}(x, a_1, \dots, a_{k-1}, \mathbf{1}, a_{k+1}, \dots, a_n) = 0.$$

Further, applying the  $A_\infty$  relation with input  $(a_1, \dots, \mathbf{1}, a_i, \dots, \mathbf{1}, a_k, \dots, a_n)$ ,  $i < k$ , implies that

$$(d\phi_{n+1})(x, a_1, \dots, a_{i-1}, \mathbf{1}, a_i, \dots, a_n) = 0$$

if  $i < k$ . Applying Lemma 3.87 and induction gives the desired module  $\mathcal{M}'$ . The fact that  $\mathcal{M}'$  and the isomorphism are bonsai if  $\mathcal{M}$  is bonsai follows by the same reasoning as in Theorem 3.80.  $\square$

**Definition 3.88.** Let  $\mathcal{A}$  be a strictly unital  $A_\infty$ -algebra over  $\mathbb{k}$ , and fix strictly unital  $A_\infty$ -modules  $\mathcal{M}$  and  $\mathcal{N}$  over  $\mathcal{A}$ . The strictly unital morphism complex  $\text{Mor}^u(\mathcal{M}, \mathcal{N})$  is the subcomplex of

$$\text{Mor}(\mathcal{M}, \mathcal{N}) = \prod_{i=0}^{\infty} \text{Mor}(M \otimes A^{\otimes i}, N)$$

(equipped with the differential specified in Equation (3.22)) consisting of those  $f_n$  with the property that  $f_{1+n}(x, a_1, \dots, a_{i-1}, \mathbf{1}, a_{i+1}, \dots, a_{n-1}) = 0$  for all  $n \geq 2$  and  $1 \leq i < n$ .

(To see that the strictly unital morphisms form a subcomplex note that the two terms in the differential there  $\mathbf{1}$  is fed into a  $\mu_2$  or  $m_2$  cancel.)

**Proposition 3.89.** Given strictly unital  $A_\infty$ -modules  $\mathcal{M}$  and  $\mathcal{N}$  over a strictly unital  $A_\infty$ -algebra  $\mathcal{A}$ , the inclusion of the strictly unital morphism complex  $\text{Mor}^u(\mathcal{M}, \mathcal{N})$  into the full morphism complex  $\text{Mor}(\mathcal{M}, \mathcal{N})$  is a chain homotopy equivalence. If  $\mathcal{M}$  and  $\mathcal{N}$  are bonsai then the statement also holds if we let  $\text{Mor}(\mathcal{M}, \mathcal{N})$  denote the complex of bonsai morphisms and  $\text{Mor}^u(\mathcal{M}, \mathcal{N})$  the subcomplex of strictly unital bonsai morphisms.

*Proof.* Let  $\mathcal{F}_i \subset \text{Mor}(\mathcal{M}, \mathcal{N})$  consist of those morphisms so that for all  $n$  and all  $1 \leq j \leq i$ ,

$$f_n(x, a_1, \dots, a_{j-1}, \mathbf{1}, a_{j+1}, \dots, a_{n-1}) = 0.$$

(This condition is vacuous when  $j \geq n-1$ , of course.) It is straightforward to check that  $\mathcal{F}_i$  is indeed a subcomplex.

Consider the map

$$(3.90) \quad H_i: \text{Mor}(\mathcal{M}, \mathcal{N}) \rightarrow \text{Mor}(\mathcal{M}, \mathcal{N})$$

defined by

$$H_i(f)(x, a_1, \dots, a_{n-2}) = \begin{cases} 0 & \text{if } n-1 < i \\ f_n(x, a_1, \dots, a_{i-1}, \mathbf{1}, a_i, \dots, a_{n-2}) & \text{otherwise.} \end{cases}$$

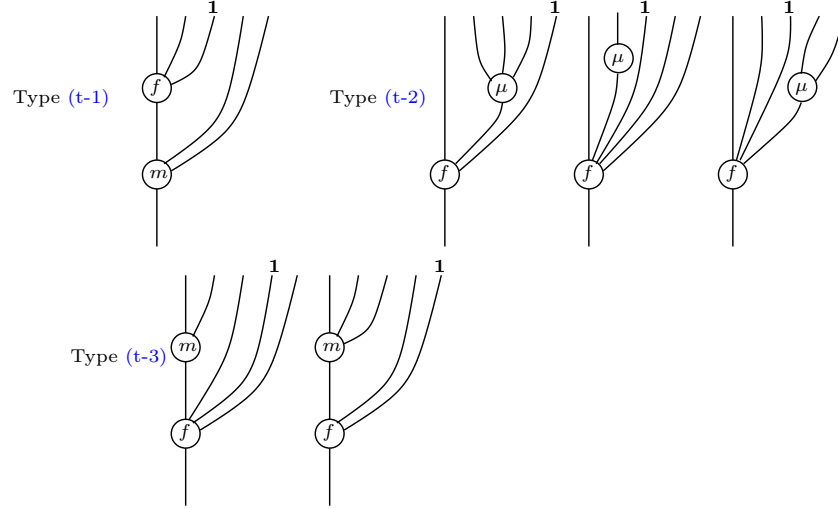

FIGURE 21. **Trees of type  $DH$ .** We have drawn various trees of type  $DH$  (as in the proof of Proposition 3.89), with  $i = 2$ , that correspond to trees in Figure 22.

It is easy to see that  $H_i$  maps the subcomplex  $\mathcal{F}_i$  to itself.

Let  $\Pi_i: \text{Mor}(\mathcal{M}, \mathcal{N}) \rightarrow \text{Mor}(\mathcal{M}, \mathcal{N})$  be the map  $\Pi_i = \mathbb{I} + \partial \circ H_i + H_i \circ \partial$ . The map  $\Pi_i$  clearly preserves the subcomplex of bonsai morphisms and, in fact, the bonsai constant is unchanged by  $\Pi_i$ . Most of the rest of the proof is to check that  $\Pi_i(\mathcal{F}_i) \subset \mathcal{F}_{i+1}$ .

Note that  $\partial \circ H_i(f)$  consists of operations associated to trees with two internal vertices, of the following kinds:

- (t-1) A vertex labelled  $f_k$  that feeds into another vertex labelled  $m_\ell^{\mathcal{N}}$ , and the  $i^{\text{th}}$  algebra input to the  $f_k$ -vertex is  $\mathbf{1}$ .
- (t-2) A vertex labelled  $\mu_k^{\mathcal{A}}$  that feeds into another vertex labelled by  $f_\ell$ , and the  $i^{\text{th}}$  input of the  $f_\ell$  is  $\mathbf{1}$ .
- (t-3) A vertex labelled by  $m_k^{\mathcal{M}}$  that feeds into another vertex labelled by  $f_\ell$ , and the  $i^{\text{th}}$  input of the  $f_\ell$  is  $\mathbf{1}$ .

We call these contributions  $DH$ -trees. Terms in  $H_i \circ \partial$  have the same three kinds of vertices, except that instead of the  $i^{\text{th}}$  algebra input of the  $f_k$  vertex being  $\mathbf{1}$ , the  $i^{\text{th}}$  algebra input to the whole configuration is  $\mathbf{1}$ . We call these trees  $HD$ -trees. See Figures 22 and 21.

In view of the strict unitality of  $\mathcal{M}$ , the  $HD$  trees of Type (t-1) with more than  $i + 1$  inputs and where the  $f_k$  vertex has  $k < i$  have zero contribution. In the special case where the total number of inputs is exactly  $i + 1$ , there is an  $HD$  tree of Type (t-1), where the vertex labelled  $m_\ell^{\mathcal{N}}$  has  $\ell = 2$ ; this corresponds to the operation

$$(x, a_1, \dots, a_{i-1}) \mapsto m_2^{\mathcal{N}}(f_i(x, a_1, \dots, a_{i-1}), \mathbf{1}).$$

This map is vacuously in  $\mathcal{F}_{i+1}$ , since  $f \in \mathcal{F}_i$  and this tree has only  $i$  inputs. All the other  $DH$ -trees and  $HD$ -trees of Type (t-1) cancel against each other.

Similarly, the  $DH$ -trees of Type (t-2) cancel against the corresponding  $HD$ -trees, provided that the  $\mu_k^{\mathcal{A}}$  feeds into some input after the  $i^{\text{th}}$  input. We call the remaining terms *Type (t-2) leftovers*.

The  $DH$ -trees of Type (t-3) where the  $m_k^{\mathcal{M}}$ -labelled vertex has  $k = 1$  cancel against the corresponding  $HD$ -trees of Type (t-3). The remaining trees of Type (t-3) are in  $\mathcal{F}_{i+1}$ : for some trees, this follows from the fact that  $\mathcal{M}$  is strictly unital; for others, it follows from the fact that  $f \in \mathcal{F}_i$ . Similarly, the Type (t-2)-leftovers are typically in  $\mathcal{F}_{i+1}$ , again either because  $\mathcal{A}$  is strictly unital (provided that the  $\mu_k$ -labelled vertex has  $k > 2$ ) or because  $f \in \mathcal{F}_i$  (when the  $i^{\text{th}}$  input is channelled



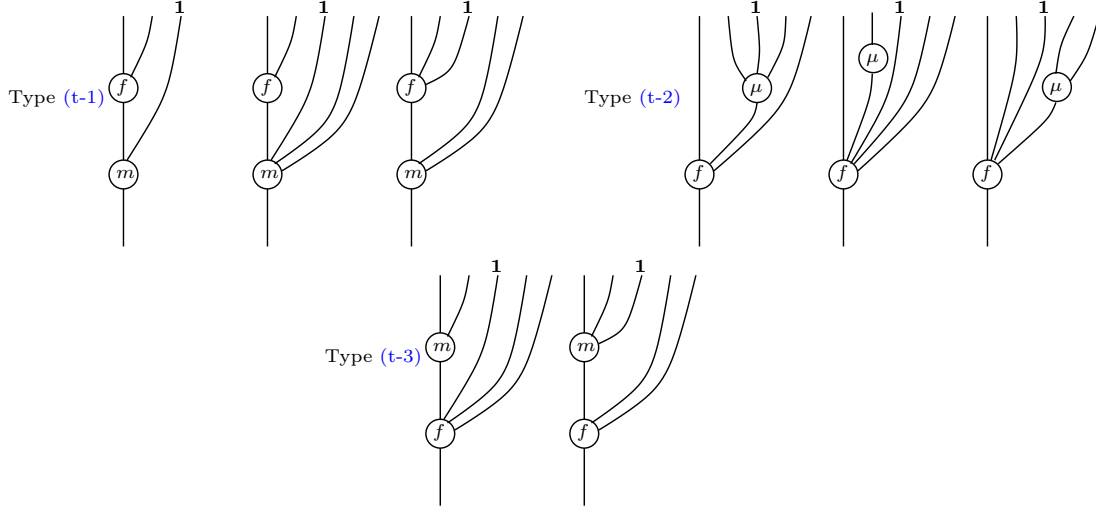

FIGURE 22. **Trees of type  $HD$ .** We have drawn various trees of type  $HD$  (as in the proof of Proposition 3.89), with  $i = 2$ . The first Type (t-1) tree does not have a corresponding  $DH$  pair; but it is clearly in  $\mathcal{F}_2$ . The first of the type (t-2) trees is a leftover (it does not cancel with the corresponding  $HD$  tree).

directly into the  $f_\ell$  vertex). There are three remaining Type (t-2)-leftovers which have been unaccounted for: the two  $HD$  trees where the  $i^{\text{th}}$  vertex is channeled into a  $\mu_2$ -operation, and the  $DH$  tree where the  $i^{\text{th}}$  vertex is channeled into a  $\mu_2$ -operation. The first two terms correspond to

$$\begin{aligned} (x, a_1, \dots, a_{n-1}) &\rightarrow f_n(x, a_1, \dots, a_{i-1}, \mu_2(\mathbf{1}, a_i), a_{i+1}, \dots, a_n) \\ (x, a_1, \dots, a_{n-1}) &\rightarrow f_n(x, a_1, \dots, a_{i-2}, \mu_2(a_{i-1}, \mathbf{1}), a_i, \dots, a_n) \end{aligned}$$

and their contributions cancel. The  $DH$  tree where the  $i^{\text{th}}$  input is fed into a  $\mu_2$  corresponds to the operation

$$(x, a_1, \dots, a_{n-1}) \mapsto f_n(x, a_1, \dots, \mu_2(a_{i-1}, a_i), \mathbf{1}, a_{i+1}, \dots, a_{n-1}).$$

When we set  $a_i = \mathbf{1}$ , though, the contribution of this tree is the same as the contribution of the identity map, i.e.,

$$(x, a_1, \dots, a_{n-1}) \mapsto f_n(x, a_1, \dots, a_{n-1}),$$

when we set  $a_i = \mathbf{1}$ . This completes the verification that  $(\mathbb{1} + \partial \circ H_i + H_i \circ \partial)(\mathcal{F}_i) \subset \mathcal{F}_{i+1}$ .

Clearly,  $\text{Mor}^u(\mathcal{M}, \mathcal{N}) = \bigcap_{i=1}^{\infty} \mathcal{F}_i$ . Observe that  $\partial \circ H_i + H_i \circ \partial$  annihilates all  $f_k$  with  $k < i$ . (This once again uses strict unitality of the modules and the algebras.) Thus, we can form the infinite composite

$$(3.91) \quad \Pi = \cdots \circ \Pi_i \circ \Pi_{i-1} \circ \cdots \circ \Pi_1.$$

The map  $\Pi: \text{Mor}(\mathcal{M}, \mathcal{N}) \rightarrow \text{Mor}^u(\mathcal{M}, \mathcal{N})$  is the homotopy inverse to the inclusion map. Finally, the fact that  $\Pi_i$  respects bonsai morphisms and does not change the bonsai constant implies that  $\Pi$  takes bonsai morphisms to bonsai morphisms.  $\square$

Proposition 3.89 implies, for example, that every  $A_\infty$ -homomorphism between strictly unital  $A_\infty$ -modules  $\mathcal{M}$  and  $\mathcal{N}$  is homotopic to a strictly unital  $A_\infty$ -homomorphism.

We now turn to strictly unital algebra homomorphisms.

**Proposition 3.92.** *If  $\mathcal{A}$  and  $\mathcal{B}$  are strictly unital  $A_\infty$ -algebras and  $f: \mathcal{A} \rightarrow \mathcal{B}$  is a weakly unital quasi-isomorphism then there is a strictly unital quasi-isomorphism  $g: \mathcal{A} \rightarrow \mathcal{B}$ . If  $\mathcal{A}$ ,  $\mathcal{B}$ , and  $f$  are bonsai then  $g$  may be chosen to be bonsai as well.*



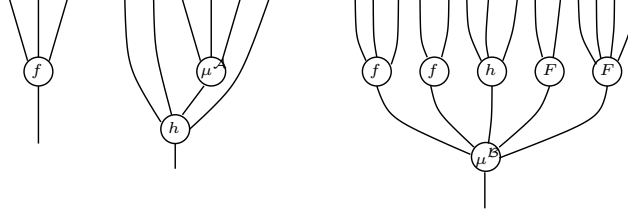

FIGURE 23. **Trees appearing in the homomorphism  $F$ .** We have drawn a tree of Type (Ft-1), (Ft-2), and (Ft-3), respectively.

The proof rests on the following:

**Lemma 3.93.** *Let  $\mathcal{A}$  and  $\mathcal{B}$  be  $A_\infty$ -algebras over  $\mathbb{k}$ , and let  $f: \mathcal{A} \rightarrow \mathcal{B}$  be an  $A_\infty$ -algebra homomorphism. Let  $h: A^{\otimes n} \rightarrow B$  be a map of degree  $n - 1$ . Then, there is a new homomorphism  $F: \mathcal{A} \rightarrow \mathcal{B}$  with  $F_\ell = f_\ell$  for all  $\ell < n$ , and*

$$(3.94) \quad F_n = f_n + dh,$$

where  $dh: A^{\otimes n} \rightarrow B$  is given by

$$dh(a_1, \dots, a_n) = \mu_1^B \circ h(a_1, \dots, a_n) + \sum_{i=1}^n h(a_1, \dots, a_{i-1}, \mu_1^A(a_i), a_{i+1}, \dots, a_n).$$

If moreover  $dh = 0$ , so  $F_n = f_n$ , then

$$(3.95) \quad \begin{aligned} F_{n+1}(a_1, \dots, a_{n+1}) &= f_{n+1}(a_1, \dots, a_{n+1}) \\ &+ \sum_{i=1}^n h(a_1, \dots, a_{i-1}, \mu_2^A(a_i, a_{i+1}), a_{i+2}, \dots, a_{n+1}) \\ &+ \mu_2^B(f_1(a_1), h(a_2, \dots, a_{n+1})) + \mu_2^B(h(a_1, \dots, a_n), f_1(a_{n+1})). \end{aligned}$$

Note that in all cases,  $f_1$  and  $F_1$  induce the same maps on homology  $H(A) \rightarrow H(B)$ .

*Proof.* The map  $F_\ell: A^{\otimes \ell} \rightarrow B$  is a sum of contributions of trees of three types. (Note that the third type is described inductively.)

(Ft-1) A corolla with operation  $f$ .

(Ft-2) A tree with exactly two internal vertices, where the trunk vertex is labelled by  $h$  and the other vertex is labelled by some  $\mu_{\ell-n+1}^A$ .

(Ft-3) A tree with a trunk vertex labelled by  $\mu^B$ , with a distinguished parent vertex labelled by  $h$ ; all  $x \geq 0$  parent vertices to the left of the distinguished parent are labelled by  $f$ ; and all  $y \geq 0$  parent vertices to the right of the distinguished parent, are labelled by  $F$ .

See Figure 23 for some examples.

We claim that  $F$  satisfies the  $A_\infty$  relation. This is proved by induction on the number  $n$  of inputs in the  $A_\infty$  relation. The base case where this number is 1 is straightforward.

For the inductive step, consider the  $A_\infty$  relation with  $n$  inputs. This involves two kinds of trees, which we call  $\mathcal{A}$ -trees and  $\mathcal{B}$ -trees. The  $\mathcal{A}$ -trees have two internal vertices, one of which is labelled  $\mu^A$ , which feeds into a vertex labelled  $F$ ; the type  $\mathcal{B}$  trees consist of a number of vertices labelled  $F$  channeled into a  $\mu^B$ .

The  $\mathcal{A}$ -trees are classified into the three above types, according to the type of the  $F$ -labelled vertex. Similarly, we classify the  $\mathcal{B}$ -trees into three types, as follows. If all the  $F$ -labelled vertices are of Type (Ft-1), we say that the  $\mathcal{B}$ -tree is of Type (Ft-1). Otherwise, the  $\mathcal{B}$ -tree has the type of the leftmost  $F$ -labelled parent of the  $\mu^B$  that is not of Type (Ft-1).

The  $\mathcal{A}$ -trees of Type (Ft-1) cancel against the  $\mathcal{B}$ -trees of Type (Ft-1) by the  $A_\infty$  relation for  $f$ .

The  $\mathcal{A}$ -trees of Type (Ft-2) cancel each other. (When one  $\mu_{\mathcal{A}}$  vertex feeds into the other, the cancellation follows from the  $A_{\infty}$  relation on  $\mathcal{A}$ ; the other kinds of terms come in canceling pairs.)

The  $\mathcal{A}$ -trees of type (Ft-3) where the  $\mu^{\mathcal{A}}$ -labelled vertex feeds in to the  $h$ -labelled vertex cancel against the  $\mathcal{B}$ -trees of Type (Ft-2).

For the remaining cancellations, we apply the  $A_{\infty}$  relation on  $\mathcal{B}$ , to find a relation between the various  $\mathcal{B}$ -trees of Type (Ft-3) and two further types of trees: (1) ones that cancel with the  $\mathcal{A}$ -trees of Type (Ft-3) where the  $\mu^{\mathcal{A}}$  vertex feeds into an  $f$ -labelled vertex (this cancellation follows from the  $A_{\infty}$  relation for  $f$ ) and (2) ones that cancel with the  $\mathcal{A}$ -trees of Type (Ft-3) where the  $\mu^{\mathcal{A}}$  vertex feeds into an  $F$ -labelled vertex (this cancellation follows from the  $A_{\infty}$  relation for  $F$ , which holds by the inductive hypothesis).  $\square$

*Proof of Proposition 3.92.* This is an inductive argument as in the proof of Theorem 3.80. Suppose that there are  $n$  and  $k$  so that  $f: \mathcal{A} \rightarrow \mathcal{B}$  satisfies

$$(3.96) \quad f_{m+1}(a_1, \dots, a_{j-1}, \mathbf{1}, a_j, \dots, a_m) = 0$$

for all  $1 < m \leq n$  and for  $m = n + 1$  and  $j \leq k$ . When  $k = n + 1$ , we will modify  $f$  to construct a new  $A_{\infty}$ -homomorphism  $F$  with  $F_m = f_m$  for  $m \leq n + 1$ , and so that Equation (3.96) holds for  $m = n + 2$  and  $j = 1$ . When  $k < n + 1$ , we will modify  $f$  to construct a new  $A_{\infty}$ -homomorphism  $F$  with  $F_m = f_m$  for  $m < n + 1$ , and so that Equation (3.96) holds for  $n + 1$  and  $k + 1$ .

Start with the first step. Let  $h(a_1, \dots, a_n) = f_{n+1}(\mathbf{1}, a_1, \dots, a_n)$ . Apply the  $A_{\infty}$ -homomorphism relation for  $f$  with inputs  $(\mathbf{1}, a_1, \dots, a_n)$ . By the inductive hypothesis, the only non-vanishing terms are  $\mu_2^{\mathcal{B}}(f_1(\mathbf{1}), f_n(a_1, \dots, a_n))$  and  $f_n(\mu_2(\mathbf{1}, a_1), a_2, \dots, a_n)$ , which cancel against each other, and the terms  $dh$ ; i.e., we have verified that  $dh = 0$ . Thus, we can modify  $f$  as in Lemma 3.93. The  $A_{\infty}$ -homomorphism relation with inputs  $(\mathbf{1}, \mathbf{1}, a_2, \dots, a_{n+1})$ , together with the inductive hypothesis on  $n$  implies that, for  $F_{n+1}$  as given in Equation (3.95),

$$F_{n+1}(\mathbf{1}, a_2, \dots, a_{n+1}) = 0.$$

Similarly, for the second step, assume that Equation (3.96) holds for all  $m \leq n$  and for  $m = n + 1$  for all  $2 \leq j \leq k$ . Define

$$h(a_1, \dots, a_n) = f(a_1, \dots, a_{k-1}, \mathbf{1}, a_k, \dots, a_n).$$

The  $A_{\infty}$  relation with inputs  $a_1, \dots, a_{k-1}, \mathbf{1}, a_k, \dots, a_n$  implies that  $dh = 0$ . Modifying  $f$  as in Lemma 3.93, it is straightforward to check that the new map  $F_{n+1}$  as specified in Equation (3.95) satisfies  $F_{n+1}(a_1, \dots, a_{k-1}, \mathbf{1}, a_{k+1}, \dots, a_{n+1}) = 0$ .

The statement about the bonsai case follows by the same reasoning as in the proof of Theorem 3.80.  $\square$

*Remark 3.97.* There is a notion in between weak and strict unitality, called *homotopy unitality*. We will need this notion only in the weighted case, so we spell it out there, in Section 4.9.

#### 4. WEIGHTED $A_{\infty}$ ALGEBRAS AND WEIGHTED TREES

4.1. **Weighted  $A_{\infty}$  algebras and the weighted trees complex.** Convention 3.1 regarding ground rings continues to be in force in this section.

**Definition 4.1.** A weighted  $A_{\infty}$ -algebra or  $w$ -algebra  $\mathcal{A}$  over  $\mathbb{k}$  consists of:

- a graded  $\mathbb{k}$ -bimodule  $A$ , and
- for each pair of integers  $n, w \geq 0$  a linear map

$$\mu_n^w: \overbrace{A \otimes \dots \otimes A}^n \rightarrow A \langle\langle 2 - n - w\kappa \rangle\rangle$$

of  $\mathbb{k}$ -bimodules

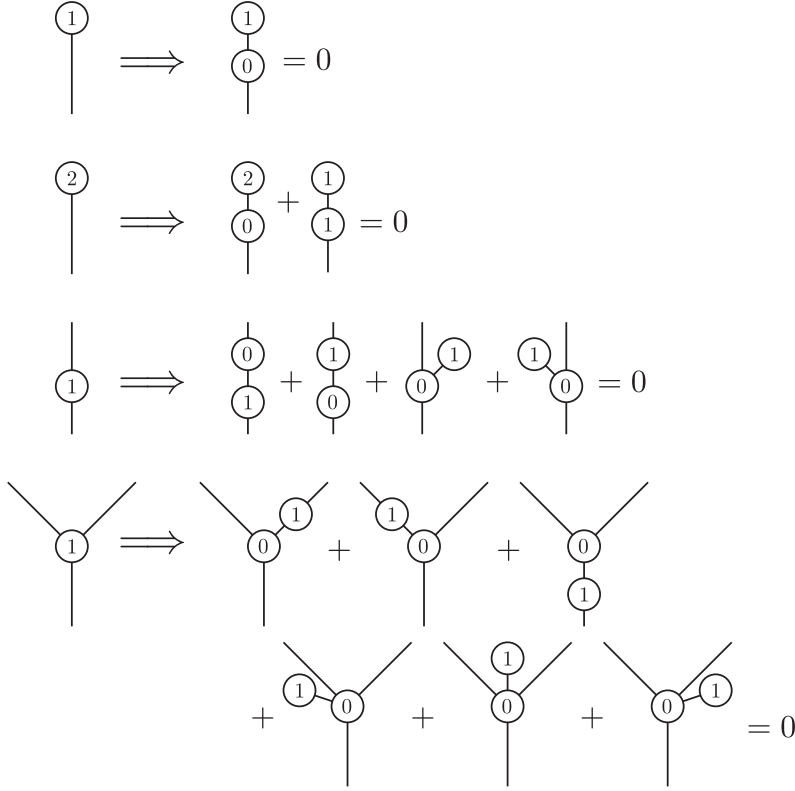

FIGURE 24. **Uncurved weighted  $A_\infty$  relations.** The cases  $(n, w) = (0, 1)$ ,  $(0, 2)$ ,  $(1, 1)$ , and  $(2, 1)$  are shown. This is the uncurved case, i.e.,  $\mu_0^0 = 0$ .

satisfying the structure equation

$$(4.2) \quad \sum_{\substack{1 \leq i \leq j \leq n+1 \\ u+v=w}} \mu_{n-j+i+1}^u(a_1, \dots, a_{i-1}, \mu_{j-i}^v(a_i, \dots, a_{j-1}), a_j, \dots, a_n) = 0$$

for each pair of non-negative integers  $(n, w)$ .

The index  $w$  is called the weight of the operation  $\mu_n^w$ . The integer  $\kappa$  is called the weight grading.

The  $w$ -algebra is uncurved if  $\mu_0^0 = 0$ .

Recall that the grading shift in Definition 4.1 means that  $\mu_n^w$  decreases the grading by  $2 - n - w\kappa$ .

The maps  $\mu_n^0$  give  $A$  the structure of an  $A_\infty$ -algebra, which we call the *undeformed  $A_\infty$ -algebra of  $\mathcal{A}$* . The undeformed  $A_\infty$ -algebra of  $\mathcal{A}$  is uncurved exactly when  $\mathcal{A}$  is uncurved.

**Convention 4.3.** We will henceforth consider only uncurved  $w$ -algebras.

A  $w$ -algebra gives rise to a curved  $A_\infty$ -algebra structure on  $A[[t]] = A \otimes_R R[[t]]$ , the formal power series in  $t$  with coefficients in  $A$ , with operations

$$(4.4) \quad \mu_n(a_1, \dots, a_n) = \sum_{w=0}^{\infty} \mu_n^w(a_1, \dots, a_n) t^w.$$

(The variable  $t$  has grading  $-\kappa$ .) The condition that a  $w$ -algebra is uncurved is the condition that the associated curved algebra has curvature in  $t \cdot A[[t]]$ .

The operations  $\mu_n^w$  in a  $w$ -algebra are conveniently expressed as planar trees with one internal vertex,  $n$  inputs, one output, and a label by the integer  $w$ . The structure equations can be thought of as indexed by such trees; their terms consist of all the ways of inserting an edge in tree and splitting the weight. See Figure 24.



FIGURE 25. **A stably-weighted tree and two contractions of it.** Left: a stably-weighted tree. Right: the result of contracting either of the internal edges in the tree.

*Remark 4.5.* A weighted  $A_\infty$ -algebra  $\mathcal{A} = (A, \{\mu_n^w\})$  is the same as a one-parameter deformation of  $(A, \{\mu_n^0\})$ , in the sense, for instance, of Seidel [Sei15, Section 3b], except that Seidel focuses on uncurved deformations ( $\mu_0^w = 0$ ) and only considers the case  $\kappa \neq 0$ .

Weighted  $A_\infty$ -algebras are also a special case of the weakly curved  $A_\infty$ -algebras studied by Positselski [Pos18] and of the gapped, filtered  $A_\infty$ -algebras introduced by Fukaya-Oh-Ohta-Ono [FOOO09, Chapter 3].

By a *marked tree* we mean a planar, rooted tree  $T$  together with a subset of the leaves of  $T$ , which we call the *inputs* of  $T$  and another leaf of  $T$ , the *output* of  $T$ . Leaves of  $T$  which are not inputs or outputs are *popsicles*. We call a vertex  $v$  of  $T$  *internal* if  $v$  is not an input or output (i.e., is a popsicle or has valence  $> 1$ ).

Given a vertex  $v$  in a tree  $T$  and a non-negative integer  $w(v)$ , we call  $(v, w(v))$  *stable* if either  $v$  has valence 3 or larger or  $w(v) > 0$  (or both). A *weighted tree* is a marked tree  $T$  together with a weight function  $w$  from the internal vertices of  $T$  to the non-negative integers. A *stably-weighted tree* is a weighted tree  $T$  with the property that for all internal vertices  $v$  of  $T$ ,  $(v, w(v))$  is stable. The *total weight* of a weighted tree is the sum of the weights  $w(v)$  of all the internal vertices  $v$  of  $T$ . Let  $\mathcal{T}_{n,w}$  denote the set of stably-weighted trees with  $n$  inputs and total weight  $w$ .

Let  $(S, e)$  be a pair consisting of a stably-weighted tree  $S$  and an edge  $e$  connecting two internal vertices in  $S$ . We can contract the edge to form a new stably-weighted tree  $T$  with one fewer internal vertex than  $S$ . The contracted edge gives rise to a new vertex in  $T$  whose weight is the sum of the weights of the two vertices of  $e$ . In this case, we say that  $S$  is obtained from  $T$  by *inserting an edge*, and we call the pair  $(S, e)$  an *edge expansion* of  $T$ . Note that if  $(S, e)$  is an edge expansion of  $T$ , then  $e$  is typically, but not always, uniquely determined by  $(S, T)$ ; see, for example, Figure 25.

Fix a stably-weighted tree  $T$  with  $n$  inputs, total weight  $w$ , and  $v$  internal vertices. The *dimension* of  $T$  is given by

$$(4.6) \quad \dim(T) = n + 2w - v - 1.$$

(See Section 8 for justification of the term “dimension”.) Note that

$$0 \leq \dim(T) \leq n + 2w - 2.$$

**Definition 4.7.** Fix non-negative integers  $n$  and  $w$ . The  $n$ -input, weight  $w$  weighted trees complex  $X_*^{n,w}$  is the chain complex with basis  $\mathcal{T}_{n,w}$  the set of stably-weighted trees with  $n$  inputs and total weight  $w$ , equipped with a grading induced by the dimension  $\dim(T)$ , i.e.,

$$X_k^{n,w} = R\langle \{T \mid \dim(T) = k\} \rangle.$$

The differential is specified by declaring that for a stably-weighted tree  $T$ ,

$$\partial T = \sum_{(S,e) \text{ an edge expansion of } T} S.$$

**Lemma 4.8.** The  $n$ -input, weight  $w$  weighted trees complex  $X_*^{n,w}$  is a chain complex, and the differential decreases the grading by one. Further, the composition map  $\circ_i: X_*^{n_1, w_1} \otimes_R X_*^{n_2, w_2} \rightarrow X_*^{n_1+n_2-1, w_1+w_2}$  is a chain map.

*Proof.* To see that  $\partial^2 = 0$ , it is easier to consider the dual complex  $(X_*^{n,w})^*$ , whose basis is the stably-weighted trees and whose (co)differential  $\delta(T)$  is the sum of all ways of contracting an internal edge (edge not adjacent to an input or the output) in  $T$ . Then  $\delta^2(T)$  is the sum of all ways of contracting two edges, and since the contractions can be performed in either order,  $\delta^2 = 0$ . Next, it is immediate that the differential decrease the grading by one, since it preserves the total weight, and increases the number of internal vertices by one. The fact that the composition maps are chain maps is also immediate from the definitions.  $\square$

*Example 4.9.* The  $n$ -input weight 0 weighted trees complex is  $C_*^{cell}(K_n)$ , the cellular chain complex of the associahedron  $K_n$ .

*Example 4.10.* The chain complex  $X_*^{0,1}$  is one-dimensional, with vanishing differential.

*Example 4.11.* The chain complex  $X_*^{0,2}$  is generated by three trees, in dimensions 2, 1, and 0. The differential of the 2-dimensional tree is the one-dimensional tree, and the differential of the one-dimensional tree is zero, because the 0-dimensional tree occurs twice in the boundary of the one-dimensional tree. (See Figure 25.) It follows that the stably-weighted trees complex is not the chain complex associated to any polyhedral complex.

Just as with unweighted trees, there are stacking operations for weighted trees: given  $S \in \mathcal{T}_{m,v}$  and  $T \in \mathcal{T}_{n,w}$  and an integer  $1 \leq i \leq n$  let  $T \circ_i S$  be the result of gluing the output (root) of  $S$  to the  $i^{\text{th}}$  input of  $T$  (and forgetting the resulting 2-valent vertex). The operation  $\circ_i$  induces a chain map

$$\begin{aligned} \phi_{i,j,n;v,w}: X_*^{j-i+1,v} \otimes_R X_*^{n+i-j,w} &\rightarrow X_*^{n,v+w} \\ S \otimes T &\mapsto T \circ_i S \end{aligned}$$

for any  $1 \leq i \leq n$  and  $i-1 \leq j \leq n$ . (These are the same as the composition operations from Section 2.1, and in particular Figure 2 except that  $S$  and  $T \circ S$  are allowed to be 0 or 1 input trees.)

A *weighted corolla* is a tree with  $n$  inputs and one internal vertex, of some weight  $w$ , denoted  $\Psi_w^n$ . (The corolla  $\Psi_n$  from Section 2.1 is  $\Psi_n^0$ .) All weighted trees can be built by stacking weighted corollas.

Turning to the connection with weighted  $A_\infty$ -algebras, suppose  $A$  is a dg  $k$ -bimodule with differential  $\mu_1^0$  and that we are also given maps  $\mu_n^w: A^{\otimes n} \rightarrow A\langle\langle 2-n-w\kappa \rangle\rangle$  for  $n \geq 0$ ,  $w \geq 0$ ,  $(n,w) \notin \{(0,0), (1,0)\}$ . Given a stably-weighted tree  $T$  with  $n$  inputs and total weight  $W$  there is an associated map  $\mu(T): A^{\otimes n} \rightarrow A\langle\langle -\dim(T) + (2-\kappa)W \rangle\rangle$  obtained by replacing each vertex with weight  $w$  and valence  $n+1$  (including the popsicles) with  $\mu_n^w$  and composing according to the edges of the tree. Extending linearly, we obtain an  $R$ -module map  $\mu: X_*^{n,W} \rightarrow \text{Mor}(A^{\otimes n}, A\langle\langle (2-\kappa)W \rangle\rangle)$ .

**Lemma 4.12.** *The collection  $\{\mu_n^w\}$  satisfies the weighted  $A_\infty$  relations if and only if for each  $(n,w)$  the map  $\mu: X_*^{n,w} \rightarrow \text{Mor}(A^{\otimes n}, A\langle\langle (2-\kappa)w \rangle\rangle)$  is a chain map.*

*Proof.* First, suppose the  $\mu_n^w$  satisfy the weighted  $A_\infty$  relations; we will verify that  $\mu$  is a chain map. Since  $\mu(T \circ_i S) = \mu(T) \circ_i \mu(S)$  and composition of trees and composition in the morphism complex are both chain maps, it suffices to verify that for any corolla  $\Psi_n^w$ ,

$$\partial \circ (\mu(\Psi_n^w)) + \mu(\Psi_n^w) \circ \partial + \mu(\partial(\Psi_n^w)) = 0.$$

The first term corresponds to the term in Equation (4.2) with  $u = 0$ ,  $j = n+1$ , and  $i = 1$ . The second term corresponds to the terms in Equation (4.2) with  $v = 0$  and  $j = i+1$ . The third term corresponds to the terms in Equation (4.2) in which both multiplications are stable, i.e., with  $(r > 0$  or  $j-i > 1)$  and  $(v > 0$  or  $n-j+i+1 > 1)$ ; these are all the remaining terms.

Conversely, if  $\mu$  is a chain map then considering  $\partial(\mu(\Psi_n^w))$  and  $\mu(\partial(\Psi_n^w))$  and making the same identification of terms gives Equation (4.2).  $\square$

We also have a notion of boundedness for  $w$ -algebras.

**Definition 4.13.** A  $w$ -algebra  $\mathcal{A} = (A, \{\mu_n^w\})$  is *bonsai* if there is an integer  $N$  so that for any stably-weighted tree  $T$  with  $\dim(T) > N$ , we have  $\mu(T) = 0$ .

#### 4.2. Weighted algebra maps and weighted transformation trees.

**Definition 4.14.** A weighted transformation tree consists of a weighted tree  $T$  and a coloring of each edge of  $T$  as either red or blue, so that:

- (1) The edges adjacent to input leaves are red.
- (2) The edge adjacent to the output leaf is blue.
- (3) For each vertex  $v$ , all of the inputs of  $v$  have the same color (red or blue).
- (4) If a vertex  $v$  has a red output, then all of the inputs of  $v$  are red; if a vertex has blue inputs, then its output is also blue.
- (5) Call a vertex red (respectively blue) if all of its inputs and its output are red (respectively blue), and purple if its inputs are red but its output is blue. We require that tree be stable in the sense that for each vertex  $v$ , either:
  - (a) the weight of  $v$  is strictly positive, or
  - (b)  $v$  has valence at least 3 (i.e., at least two inputs), or
  - (c)  $v$  is purple and has valence 2.

(Cf. Definition 2.40.)

Given a (red) weighted tree  $S$ , an  $n$ -input weighted transformation tree  $T$ , and an integer  $i$ ,  $1 \leq i \leq n$ , we can form a new weighted transformation tree  $T \circ_i S$  by connecting the output of  $S$  to the  $i^{\text{th}}$  input of  $T$ . Also, given an  $n$ -input (blue) weighted tree  $S$  and weighted transformation trees  $T_1, \dots, T_n$ , we can form a new weighted transformation tree  $S \circ (T_1, \dots, T_n)$  by connecting the output of each  $T_i$  to the  $i^{\text{th}}$  input of  $S$ . These operations induce composition maps

$$(4.15) \quad \circ_i: J_*^{n_1, w_1} \otimes_R X_*^{n_2, w_2} \rightarrow J_*^{n_1+n_2-1, w_1+w_2},$$

$$(4.16) \quad \circ: X_*^{n, w} \otimes_R J_*^{m_1, v_1} \otimes_R \cdots \otimes_R J_*^{m_n, v_n} \rightarrow J_*^{m_1+\cdots+m_n, v_1+\cdots+v_n+w}.$$

As usual, given  $T \in J_*^{n_1, w_1}$  and  $S \in X_*^{n_2, w_2}$ , we define

$$T \circ S = \sum_{i=1}^{n_1} T \circ_i S.$$

The weighted multiplex  $J_*^{n, w}$  is the chain complex spanned by weighted transformation trees with  $n$  inputs and total weight  $w$ , with the following differential. As usual, the differential satisfies the Leibniz rule with respect to composition, so it suffices to define the differential of a red, purple, or blue corolla. The differential of a red corolla  $\mathbf{r}\Psi_n^w$  or blue corolla  $\mathbf{b}\Psi_n^w$  is as in the weighted trees complex. The differential of a purple corolla  $\mathbf{p}\Psi_n^w$  is given by

$$\partial(\mathbf{p}\Psi_n^w) = \sum_{\substack{k+\ell=n+1 \\ w_1+w_2=w}} \mathbf{p}\Psi_k^{w_1} \circ \mathbf{r}\Psi_\ell^{w_2} + \sum_{\substack{k_1+\cdots+k_\ell=n \\ v+w_1+\cdots+w_\ell=w}} \mathbf{b}\Psi_\ell^v \circ (\mathbf{p}\Psi_{k_1}^{w_1}, \dots, \mathbf{p}\Psi_{k_\ell}^{w_\ell}).$$

Note that in the special case  $n = 0$ , there is a term in the second sum of the form  $\mathbf{b}\Psi_0^w$ , corresponding to  $\ell = 0$ .

Define the dimension to be  $\dim(T) = n + 2w - r - b - 1$ , where  $r$  and  $b$  are the number of red and blue vertices respectively.

**Lemma 4.17.** The  $n$ -input, weight  $w$  multiplex  $J_*^{n, w}$  is a chain complex, and the differential decreases the grading by one. Further, the composition maps (4.15) and (4.16) are chain maps.

*Proof.* As in Lemma 4.8, to see that  $\partial^2 = 0$  it is easier to consider the dual complex, which has the same basis as  $J_*^{n, w}$  but where the differential is the sum of all ways of:

- (1) contracting an edge between two red vertices,
- (2) contracting an edge between two blue vertices,

- (3) contracting an edge between a purple vertex and a red vertex, or
- (4) contracting all the edges into a blue vertex  $v$  if all of the vertices above  $v$  are purple.

Terms in  $\delta^2$  coming from two contractions of the first three kinds cancel in pairs, corresponding to the two possible orders. It remains to understand terms where one or both are of the fourth type. Several of these cases commute, so cancel in pairs:

- Contractions of type (1) and (4).
- Contractions of type (3) and (4).
- Pairs of a contraction of type (2) and a contraction of type (4) corresponding to three distinct blue vertices.
- Pairs of contractions of type (4) corresponding to a pair of blue vertices  $v_1, v_2$  where  $v_1$  is neither above nor below  $v_2$ .

The remaining terms are:

- Contraction of an edge connecting two blue vertices  $v_1$  and  $v_2$ , giving a new vertex  $v$ , and then all of the edges above  $v$  (which must lead to purple vertices). For this to be sensible, all of the edges into  $v_1$  come from purple vertices, as do all of the edges into  $v_2$  except the edge from  $v_1$ .
- Contraction of all the edges above a vertex  $v_1$  and then all the edges above a vertex  $v_2$  below  $v_1$ . For this to be sensible, again, all of the edges into  $v_1$  come from purple vertices, as do all of the edges into  $v_2$  except the edge from  $v_1$ .

These terms, again, cancel in pairs.

The facts that the differential decreases the grading by 1 and the composition maps are chain maps are immediate from the definitions.  $\square$

**Definition 4.18.** Fix weighted  $A_\infty$ -algebras  $\mathcal{A}$  and  $\mathcal{B}$  over  $\mathbb{k}$  with the same weight grading  $\kappa$ . A homomorphism of weighted  $A_\infty$ -algebras  $f: \mathcal{A} \rightarrow \mathcal{B}$  is a homomorphism of curved  $A_\infty$ -algebras whose 0-input component  $f_0$  lies in  $tB[[t]] \subset B[[t]]$ . Equivalently, a homomorphism is a sequence of maps  $f_n^w: A^{\otimes n} \rightarrow B\langle\langle 1 - n - \kappa w \rangle\rangle$ ,  $n, w = 0, \dots, \infty$ ,  $(n, w) \neq (0, 0)$ , satisfying the structure equation

$$\begin{aligned} & \sum_{\substack{1 \leq i \leq j \leq n+1 \\ u+v=w \\ 2v+j-i \geq 2}} f_{n-j+i+1}^u(a_1, \dots, a_{i-1}, \mu_{j-i}^v(a_i, \dots, a_{j-1}), a_j, \dots, a_n) \\ & + \sum_{\substack{0=i_0 \leq i_1 \leq \dots \leq i_{k+1}=n \\ u_1 + \dots + u_k + v = w \\ 2u_j + i_j - i_{j-1} \geq 1, 2v+k \geq 2}} \mu_k^v(f_{i_1-i_0}^{u_1}(a_1, \dots, a_{i_1}), f_{i_2-i_1}^{u_2}(a_{i_1+1}, \dots, a_{i_2}), \dots, f_{n-i_k}^{u_k}(a_{i_k+1}, \dots, a_n)) = 0 \end{aligned}$$

for each  $(n, w)$ .

Homomorphisms compose in the obvious way, generalizing the case of  $A_\infty$ -algebra homomorphisms. It is clear that the composition of two weighted  $A_\infty$ -algebra homomorphisms is again a homomorphism. The identity homomorphism of  $\mathcal{A}$ ,  $\mathbb{I}$ , is defined by

$$\mathbb{I}_n^w = \begin{cases} \mathbb{I}_A & (n, w) = (1, 0) \\ 0 & \text{else.} \end{cases}$$

An invertible homomorphism is an isomorphism.

Given a weighted  $A_\infty$ -algebra  $\mathcal{A}$ , the homology  $H_*(\mathcal{A})$  is the homology of  $A$  with respect to  $\mu_1^0$ . A homomorphism is a quasi-isomorphism if the induced map  $H_*(\mathcal{A}) \rightarrow H_*(\mathcal{B})$  is an isomorphism or, equivalently, if the induced map of undeformed  $A_\infty$ -algebras is a quasi-isomorphism.

**Lemma 4.19.** A weighted algebra homomorphism  $f: \mathcal{A} \rightarrow \mathcal{B}$  is an isomorphism if and only if  $f_1^0$  is an isomorphism.



*Proof.* From the same proof as in the unweighted case [LOT15, Lemma 2.1.14, *inter alia*], but inducting first on the weight and then on the number of inputs, we get a left inverse  $g_L$  to  $f$ , and a right inverse  $g_R$  to  $f$ . *A priori*, these maps may not be homomorphisms; however, associativity of the formula for composition shows that  $g_L = g_L \circ f \circ g_R = g_R$ , so  $g = g_L = g_R$  is a two-sided inverse.

The map  $g$  is a homomorphism if

$$(4.20) \quad \sum_{u_1 + \dots + u_n + v = w} \begin{array}{c} \downarrow \quad \quad \downarrow \\ g^{u_1} \quad \dots \quad g^{u_k} \\ \searrow \quad \quad \swarrow \\ \mu^v \\ \downarrow \end{array} + \sum_{u+v=w} \begin{array}{c} \downarrow \quad \downarrow \\ \mu^u \\ \swarrow \quad \searrow \\ g^v \\ \downarrow \end{array} = 0$$

(as maps from the tensor algebra on  $A$  to  $B$ ). To keep notation simple, we will suppress the weights in the rest of the proof. Pre-composing the left side by  $f$  gives

$$\begin{array}{c} \downarrow \quad \quad \downarrow \quad \quad \downarrow \quad \quad \downarrow \\ f \quad \dots \quad f \quad \quad f \quad \dots \quad f \quad \quad f \quad \dots \quad f \\ \searrow \quad \quad \swarrow \quad \quad \searrow \quad \quad \swarrow \\ g \quad \quad \quad \quad \quad g \quad \quad \quad \quad \quad g \\ \searrow \quad \quad \swarrow \\ \mu \\ \downarrow \end{array} + \begin{array}{c} \downarrow \quad \quad \downarrow \quad \quad \downarrow \quad \quad \downarrow \\ f \quad \dots \quad f \quad \dots \quad f \quad \dots \quad f \\ \searrow \quad \quad \swarrow \\ \mu \\ \downarrow \end{array} = \begin{array}{c} \downarrow \quad \downarrow \\ \mu \\ \downarrow \end{array} + \begin{array}{c} \downarrow \quad \downarrow \\ f \quad f \\ \swarrow \quad \searrow \\ \mu \\ \downarrow \end{array} + \begin{array}{c} \downarrow \quad \downarrow \\ f \quad f \\ \swarrow \quad \searrow \\ \mu \\ \downarrow \end{array} = \begin{array}{c} \downarrow \quad \downarrow \\ \mu \\ \downarrow \end{array} + \begin{array}{c} \downarrow \quad \downarrow \\ \mu \\ \downarrow \end{array} = 0.$$

Since pre-composition with  $f$  is an isomorphism with inverse pre-composition by  $g$ , this implies Equation (4.20), as desired.  $\square$

Given a homomorphism of weighted  $A_\infty$ -algebras  $f: \mathcal{A} \rightarrow \mathcal{B}$  and a weighted transformation tree  $T$  with  $n$  inputs and total weight  $W$  there is an induced map  $F(T): A^{\otimes n} \rightarrow B\langle\langle -\dim(T) + (2 - \kappa)W \rangle\rangle$ . Thus, we have a map

$$F: J_*^{n,w} \rightarrow \text{Mor}(A^{\otimes n}, B\langle\langle (2 - \kappa)w \rangle\rangle).$$

**Lemma 4.21.** *The collection  $\{f_n^w\}$  satisfy the weighted  $A_\infty$ -homomorphism relations if and only if for each  $(n, w)$  the induced map  $F$  is a chain map.*

*Proof.* The proof is similar to the proof of Lemma 4.12 or 3.12 and is left to the reader.  $\square$

**Definition 4.22.** *A homomorphism  $f: \mathcal{A} \rightarrow \mathcal{B}$  between  $w$ -algebras is *bonsai* if there is a number  $N$  so that for any weighted transformation tree  $T$  with  $\dim(T) > N$ , we have  $F(T) = 0$ .*

**4.3. Units in weighted  $A_\infty$ -algebras.** Just as in the unweighted case, there are several notions of unitality one can consider for weighted algebras. We will discuss two.

**Definition 4.23.** *A  $w$ -algebra  $\mathcal{A}$  is *weakly unital* if there is an element  $\mathbf{1} \in A$  so that:*

- (1)  $\mu_1^0(\mathbf{1}) = 0$ .
- (2) For all  $a \in A$ ,  $\mu_2^0(a, \mathbf{1}) = m_2^0(\mathbf{1}, a) = a$ .

**Definition 4.24.** *A  $w$ -algebra is called *strictly unital* if there is an element  $\mathbf{1} \in A$  with the following properties:*

- (1) For any  $a \in A$ ,  $\mu_2^0(\mathbf{1}, a) = \mu_2^0(a, \mathbf{1}) = a$ .
- (2) For any sequence of elements  $a_1, \dots, a_n \in A$  with the property that  $a_i = \mathbf{1}$  for some  $i$ , and any weight  $w$ ,  $\mu_n^w(a_1, \dots, a_n) = 0$ , except in the special case where  $w = 0$  and  $n = 2$  described above.

*A strictly unital  $w$ -algebra  $A$  is *split unital* if there is a  $R$ -module splitting  $A = R\langle\mathbf{1}\rangle \oplus A'$ .*



When taking tensor products in Section 7, we will require that the weighted  $A_\infty$ -algebras and modules be strictly unital. (There was no analogous requirement in the unweighted case.) The results of these tensor products, however, are in general only weakly unital. Fortunately, Theorem 3.80 has the following adaptation to the weighted case:

**Theorem 4.25.** *Every weakly unital  $w$ -algebra  $\mathcal{A}$  is isomorphic to a strictly unital one  $\mathcal{A}'$ . Further, if  $\mathcal{A}$  is bonsai then  $\mathcal{A}'$  and the isomorphism can be chosen to be bonsai as well.*

The proof rests on the following generalization of Lemma 3.81. To set it up, let

$$\phi_n^w: \overbrace{A \otimes \dots \otimes A}^n \rightarrow A$$

be a map of  $\mathbb{k}$ -bimodules. Define

$$d\phi_n^w = \mu_1^0 \circ \phi_n^w + \sum_{i=1}^n \phi_n^w \circ (\mathbb{I}_{A^{\otimes i-1}} \otimes \mu_1^0 \otimes \mathbb{I}_{A^{\otimes n-i+1}}).$$

(This is the differential of  $\phi_n^w$  thought of as an element of  $\text{Mor}(A^{\otimes n}, A)$ .)

**Lemma 4.26.** *Suppose that  $\mathcal{A}$  is a  $w$ -algebra. Fix integers  $n, v \geq 0$  with  $n + 2v \geq 2$ , and let  $\phi_n^v: A^{\otimes n} \rightarrow A$  be any map of degree  $(2 - \kappa)v + n - 1$ . There is a  $w$ -algebra  $\mathcal{A}' = (A, \bar{\mu}_n^w)$  isomorphic to  $\mathcal{A}$ , so that  $\bar{\mu}_i^w = \mu_i^w$  for  $i < n$  or  $w < v$  and*

$$\bar{\mu}_n^v = \mu_n^v + d\phi_n^v.$$

Moreover if  $d\phi_n^v = 0$  or  $n > 2$  or  $v > 0$  then

$$\bar{\mu}_{n+1}^v = \mu_{n+1}^v + \mu_2^0 \circ (\mathbb{I}_A \otimes \phi_n^v) + \mu_2^0 \circ (\phi_n^v \otimes \mathbb{I}_A) + \sum_{i=1}^{n-1} \phi_n^v \circ (\mathbb{I}_{A^{\otimes i-1}} \otimes \mu_2^0 \otimes \mathbb{I}_{A^{\otimes n+1-i}}).$$

*Proof.* The proof of Lemma 3.81 applies (with Lemma 4.19 in place of [LOT15, Lemma 2.1.14]).  $\square$

The following is an easy modification of the proof of Theorem 3.80:

*Proof of Theorem 4.25.* The proof is a triple induction, on the weight  $v$ , the number of inputs  $n$ , and the first input  $k$  at which the operation  $\mu_n^v$  is not strictly unital. For the case  $v = 0$ , the same proof as for Theorem 3.80, with Lemma 4.26 in place of Lemma 3.81, gives a weighted  $A_\infty$ -algebra whose undeformed honest  $A_\infty$ -algebra is strictly unital.

Next, if  $\mu_n^w$  is strictly unital for all  $w < v$  (i.e.,  $\mu_n^w(a_1, \dots, \mathbf{1}, \dots, a_n) = 0$  if  $w < v$  and  $(n, w) \neq (2, 0)$ ) then it follows from the weight  $v$   $A_\infty$  relation with input  $(\mathbf{1}, \mathbf{1})$  that  $\mu_1^v(\mathbf{1}) = \mu_1^0(\mu_2^v(\mathbf{1}, \mathbf{1}))$ . So, applying Lemma 4.26 with  $\phi_1^v(a) = \mu_2^v(\mathbf{1}, a)$  gives an isomorphic weighted algebra with  $\bar{\mu}_1^v(\mathbf{1}) = 0$ .

Now, suppose that there is a constant  $v \geq 0$  so that  $\mathcal{A}$  is strictly unital for all operations with weight less than  $v$ . Suppose also that there are integers  $n \geq 1$  and  $k \geq 1$  so that  $\mathcal{A}$  is strictly unital for all weight  $v$  operations fewer than  $n + 1$  inputs, and moreover

$$(4.27) \quad \mu_{n+1}^v(a_1, \dots, a_{j-1}, \mathbf{1}, a_j, \dots, a_n) = 0$$

holds for all  $j < k$ .

Suppose that  $k + 1 < n + 1$ . We construct an isomorphic model for  $\mathcal{A}$  by modifying only those actions with weight at least  $v$  and at least  $n + 1$  inputs, so that Equation (4.27) holds for all  $j < k + 1$ . When  $k < n$ , let  $\phi_n^v(a_1, \dots, a_n) = \mu_{n+1}^v(a_1, \dots, a_i, \mathbf{1}, a_{i+1}, \dots, a_n)$ . Apply Lemma 4.26 to construct a new action with

$$\bar{\mu}_{n+1}^v = \mu_{n+1}^v + \mu_2^0 \circ (\mathbb{I}_A \otimes \phi_n^v) + \mu_2^0 \circ (\phi_n^v \otimes \mathbb{I}_A) + \sum_{i=1}^{n-1} \phi_n^v \circ (\mathbb{I}_{A^{\otimes i-1}} \otimes \mu_2^0 \otimes \mathbb{I}_{A^{\otimes i+1, n}}).$$

The weighted  $A_\infty$  relation on  $\mathcal{A}$  with input  $(a_1, \dots, a_k, \mathbf{1}, \mathbf{1}, a_{k+1}, \dots, a_n)$  proves that

$$\bar{\mu}_{n+1}^v(a_1, \dots, a_k, \mathbf{1}, a_{k+1}, \dots, a_n) + d\psi_{n+1}^v(a_1, \dots, a_k, \mathbf{1}, a_{k+1}, \dots, a_n) = 0,$$

where

$$\psi_{n+1}^v(a_1, \dots, a_{n+1}) = \mu_{n+2}^v(a_1, \dots, a_k, \mathbf{1}, a_{k+1}, \dots, a_{n+1}).$$

This uses the hypothesis that lower weight actions with an arbitrary number of inputs are strictly unital. Applying Lemma 4.26 once again, this time using  $\psi_{n+1}^v$ , we obtain the improved algebra for which Equation (4.27) holds with  $k+1$  in place of  $k$ .

By induction, we can now assume that Equation (4.27) holds for all  $k < n+1$ . We arrange for Equation (4.27) to hold for  $k = n+1$  by applying Lemma 3.81 once again, this time using  $\psi_{n+1}^v$  with  $k = n$ .

Successively increasing  $n$  and  $v$ , we obtain the claimed result. The fact that  $\mathcal{A}'$  and the isomorphism are bonsai if  $\mathcal{A}$  is bonsai follows by the same argument as in the unweighted case.  $\square$

**Definition 4.28.** A homomorphism  $f$  between weakly unital  $w$ -algebras  $\mathcal{A}$  and  $\mathcal{B}$  is weakly unital if  $f_1^0(\mathbf{1}_{\mathcal{A}}) = \mathbf{1}_{\mathcal{B}}$ . A homomorphism between strictly unital  $w$ -algebras  $\mathcal{A}$  and  $\mathcal{B}$  is strictly unital if it is weakly unital and  $f_n^w(a_1, \dots, a_n) = 0$  if some  $a_i = \mathbf{1}_{\mathcal{A}}$  and  $(n, w) \neq (1, 0)$ .

**Proposition 4.29.** If  $\mathcal{A}$  and  $\mathcal{B}$  are strictly unital  $w$ -algebras and  $f: \mathcal{A} \rightarrow \mathcal{B}$  is a weakly unital quasi-isomorphism then there is a strictly unital quasi-isomorphism  $g: \mathcal{A} \rightarrow \mathcal{B}$ . If  $\mathcal{A}$ ,  $\mathcal{B}$ , and  $f$  are bonsai then  $g$  can be chosen to be bonsai, as well.

The proof rests on the following weighted analogue of Lemma 3.93 (in the spirit of Lemma 4.49):

**Lemma 4.30.** Let  $\mathcal{A}$  and  $\mathcal{B}$  be weighted  $A_\infty$ -algebras, and  $f: \mathcal{A} \rightarrow \mathcal{B}$  be a weighted  $A_\infty$ -algebra homomorphism. Let  $h^v: A^{\otimes n} \rightarrow B$  be a map of degree  $(2-\kappa)v+n-1$ , for some  $(n, v) \neq (0, 0)$ . Then, there is a new weighted  $A_\infty$ -algebra homomorphism  $F: \mathcal{A} \rightarrow \mathcal{B}$  with  $F_\ell^w = f_\ell^w$  for all  $\ell < n$  or  $w < v$ , and

$$(4.31) \quad F_n^v = f_n^v + dh^v,$$

where

$$dh^v(a_1, \dots, a_n) = \mu_1^0 \circ h^v(a_1, \dots, a_n) + \sum_{i=1}^n h(a_1, \dots, a_{i-1}, \mu_1^0(a_i), a_{i+1}, \dots, a_n).$$

(Here, the two terms labelled  $\mu_1^0$  denote the weight zero differential on  $\mathcal{B}$  and  $\mathcal{A}$  respectively.) If moreover  $dh^v = 0$ , so  $F_n^v = f_n^v$ , then

$$(4.32) \quad \begin{aligned} F_{n+1}^v(a_1, \dots, a_{n+1}) &= f_{n+1}^v(a_1, \dots, a_{n+1}) \\ &+ \sum_{i=1}^n h^v(a_1, \dots, a_{i-1}, \mu_2^0(a_i, a_{i+1}), a_{i+2}, \dots, a_{n+1}) \\ &+ \mu_2^0(f_1^0(a_1), h^v(a_2, \dots, a_{n+1})) + \mu_2^0(h^v(a_1, \dots, a_n), f_1^0(a_{n+1})). \end{aligned}$$

*Proof.* We adapt the proof of Lemma 3.93, with the following changes. In the present case, we are attempting to define components of a weighted homomorphism  $F_\ell^w: A^{\otimes \ell} \rightarrow B$ . Again, we allow trees of the three Types (Ft-1)-(Ft-3) as in the proof of that lemma, with the understanding that each vertex is now also decorated by some weight, and the sum of the weights in each tree must be  $w$ . The same inductive argument then shows that the maps  $F_\ell^w$  described above give a weighted homomorphism.  $\square$

*Proof of Proposition 4.29.* This is an inductive argument, like the proof of Proposition 3.92. Suppose there are  $w$ ,  $n$ , and  $k$  so that the map  $f: \mathcal{A} \rightarrow \mathcal{B}$  satisfies

$$(4.33) \quad f_{m+1}^v(a_1, \dots, a_{j-1}, \mathbf{1}, a_j, \dots, a_m) = 0$$

in the following cases:

- when  $v < w$
- when  $v = w$  and  $1 \leq m \leq n$
- when  $v = w$ ,  $w = n+1$ , and  $j \leq k$ .

We construct the modification of  $f$  by an outer induction on  $w$ , and then induction on  $k$  and then  $n$ .

The base case  $(w, n) = (0, 1)$  is the definition of weak unitality. For fixed  $w$ , the inductive steps on  $k$  and  $n$  follow as in the proof of Proposition 3.92, using Lemma 4.30 in place of Lemma 3.93. The base case for this induction is  $f_1^w(\mathbf{1}) = 0$  if  $w > 0$ , and is  $f_1^0(\mathbf{1}) = \mathbf{1}$ .

For the inductive step on the weight, suppose that Equation (4.33) holds for all  $v < w$ . Then, the weighted  $A_\infty$  relation with inputs  $(\mathbf{1}, \mathbf{1})$  implies that  $f_1^w(\mathbf{1}) = \mu_1^0(f_2^w(\mathbf{1}, \mathbf{1}))$ . So, applying Lemma 4.30 with  $h_0^w = f_2^w(\mathbf{1}, \mathbf{1})$  gives a new homomorphism  $F$  with  $F_1^w(\mathbf{1}) = 0$ , as desired. This completes the induction.

The bonsai statement follows as in the unweighted case.  $\square$

#### 4.4. Weighted modules and weighted module trees.

**Definition 4.34.** Fix a weighted  $A_\infty$ -algebra  $\mathcal{A}$  over  $\mathbb{k}$  with weight grading  $\kappa$ . A (right) weighted  $A_\infty$ -module or  $w$ -module  $\mathcal{M}$  over  $\mathcal{A}$  consists of:

- a right  $\mathbb{k}$ -module  $M$  and
- for each pair of integers  $n, w \geq 0$  a linear map

$$m_{1+n}^w: M \otimes \overbrace{A \otimes \dots \otimes A}^n \rightarrow M \langle\langle 1 - n - \kappa w \rangle\rangle$$

of right  $\mathbb{k}$ -modules

satisfying the structure equation

$$(4.35) \quad \sum_{\substack{1 \leq i \leq j \leq n \\ u+v=w}} m_{2+n-j+i}^u(x, a_1, \dots, a_{i-1}, \mu_{j-i}^v(a_i, \dots, a_{j-1}), a_j, \dots, a_n) \\ + \sum_{\substack{0 \leq i \leq n \\ u+v=w}} m_{1+n-i}^u(m_{1+i}^v(x, a_1, \dots, a_i), a_{i+1}, \dots, a_n) = 0$$

for each pair of non-negative integers  $(n, w)$ .

Again,  $w$  is called the weight of  $m_n^w$ .

The first few terms in the structure equation (4.35) are shown in Figure 26.

A weighted  $A_\infty$ -module  $\mathcal{M}$  over  $\mathcal{A}$  gives rise to an  $A_\infty$ -module  $M[[t]] = M \otimes_R R[[t]]$  over  $A[[t]]$  with operations

$$m_{1+n}(x, a_1, \dots, a_n) = \sum_{w=0}^{\infty} m_{1+n}^w(x, a_1, \dots, a_n) t^w.$$

Equation (4.35) is equivalent to the  $A_\infty$ -module structure equation for  $M[[t]]$ .

Next we turn to the analogue of stably-weighted trees. A *stably-weighted module tree* is a stably-weighted tree for which the left-most leaf is an input. Let  $\mathcal{TM}_{1+n,w}$  denote the set of stably-weighted module trees with total weight  $w$  and  $1+n$  inputs. Call a stably-weighted tree which is not a stably-weighted module tree (i.e., for which the left-most leaf is a popsicle) a *left-popsicle tree*. Note that if  $T$  is a left-popsicle tree then so is every tree  $S$  in  $\partial T$ , so the left-popsicle trees form a subcomplex  $L_*^{n,w}$  of the weighted trees complex  $X_*^{n,w}$ . The *weighted module trees complex* with  $1+n$  inputs and weight  $w$ ,  $XM_*^{1+n,w}$  is the quotient complex of  $X_*^{1+n,w}$  by the subcomplex of left-popsicle trees.

The weighted module trees complex inherits a grading from the weighted trees complex.

As in the case of stably-weighted trees, there are stacking operations for stably-weighted module trees: given  $S \in \mathcal{TM}_{1+m,v}$  and  $T \in \mathcal{TM}_{1+n,w}$  we can glue the output of  $S$  to the first input of  $T$  to obtain  $T \circ_1 S \in \mathcal{TM}_{1+m+n,v+w}$ , and given  $S \in \mathcal{T}_{m,v}$  and  $T \in \mathcal{TM}_{1+n,w}$  and  $1 < i \leq n+1$  we can glue the output of  $S$  to the  $i^{\text{th}}$  input of  $T$  to obtain  $T \circ_i S \in \mathcal{TM}_{m+n,v+w}$ . The operation  $\circ_i$  induces a

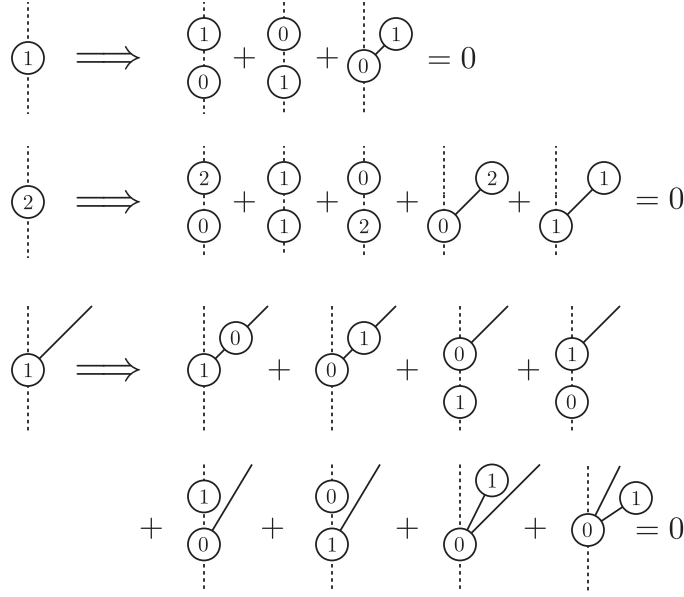
FIGURE 26. **Weighted  $A_\infty$ -module relations.**

chain map

$$\phi_{i,j,n;v,w}: \begin{cases} X_*^{j-i+1,v} \otimes_R XM_*^{n+i-j,w} \rightarrow XM_*^{n,v+w} & i > 1 \\ XM_*^{j,v} \otimes_R XM_*^{n+1-j,w} \rightarrow XM_*^{n,v+w} & i = 1 \end{cases}$$

$$\phi_{i,j,n;v,w}(S, T) = T \circ_i S$$

for any  $1 \leq i \leq n$  and  $i-1 \leq j \leq n$ .

The connection with weighted modules is as follows. Given a weighted  $A_\infty$ -algebra  $\mathcal{A}$ , a chain complex  $(M, m_1^0)$ , and maps  $m_{1+n}^w: M \otimes A^{\otimes n} \rightarrow M \langle\langle 1 - n - \kappa w \rangle\rangle$ ,  $n \geq 0$ ,  $w \geq 0$ ,  $(n, w) \neq (0, 0)$ , for any stably-weighted module tree  $T$  with  $1+n$  inputs and total weight  $W$  there is an induced map  $m(T): M \otimes A^{\otimes n} \rightarrow M \langle\langle -\dim(T) + (2 - \kappa)W \rangle\rangle$  as follows: replace each internal vertex  $v$  on the left-most strand of  $T$  by  $m_{1+n}^w$  (where  $w$  is the weight of  $v$  and  $n+2$  is the valence of  $v$ ) and each internal vertex  $v$  not on the left-most strand by  $\mu_n^w$  (where  $w$  is the weight of  $v$  and  $n+1$  is the valence of  $v$ ) and compose these maps along the edges of  $T$ . Extending linearly we obtain a map  $XM_*^{1+n,w} \rightarrow \text{Mor}(M \otimes A^{\otimes n}, M \langle\langle (2 - \kappa)w \rangle\rangle)$ .

**Lemma 4.36.** *The collection  $\{m_{1+n}^w\}$  satisfy the weighted  $A_\infty$ -module relations if and only if for each  $(n, w)$  the map  $m: XM_*^{1+n,w} \rightarrow \text{Mor}(M \otimes A^{\otimes n}, M \langle\langle (2 - \kappa)w \rangle\rangle)$  is a chain map.*

*Proof.* The proof is similar to the proof of Lemma 4.12, and is left to the reader.  $\square$

**Definition 4.37.** *A  $w$ -module  $\mathcal{M}$  is bonsai if there is an integer  $N$  so that for any stably-weighted module tree  $T$  with  $\dim(T) > N$ , we have  $m(T) = 0$ .*

#### 4.5. Weighted module transformation trees and weighted module maps.

**Definition 4.38.** *A weighted module transformation tree is a weighted tree  $T$  whose leftmost leaf is an input, together with a distinguished internal vertex  $v$  on the leftmost strand of  $T$ , subject to the condition that every internal vertex of  $T$  except  $v$  must be stable. (Compare Section 2.5; we will sometimes call the distinguished vertex purple.) Let  $JM_*^{n,w}$  be the free  $R$ -module with basis the weighted module transformation trees with  $n$  inputs and total weight  $w$ . There is a grading on*

$JM_*^{n,w}$  defined by

$$\dim(T) = n + 2w - v$$

where  $v$  is the number of internal vertices. The differential of a weighted module transformation  $T$  is the sum of all ways of inserting an edge into  $T$  to obtain a new weighted module transformation tree.

There are obvious composition maps

$$(4.39) \quad \circ_1: JM_*^{n,w} \otimes_R XM_*^{m,v} \rightarrow JM_*^{m+n-1,v+w}$$

$$(4.40) \quad \circ_1: XM_*^{n,w} \otimes_R JM_*^{m,v} \rightarrow JM_*^{m+n-1,v+w}$$

$$(4.41) \quad \circ_i: JM_*^{n,w} \otimes_R X_*^{m,v} \rightarrow JM_*^{m+n-1,v+w} \quad 1 < i \leq n.$$

**Lemma 4.42.** *The  $n$ -input, weight  $w$  module transformation trees complex  $JM_*^{n,w}$  is a chain complex, and the differential decreases the grading by one. Further, the composition maps (4.39), (4.40), and (4.41) are chain maps.*

*Proof.* The proof that the differential satisfies  $\partial^2 = 0$  is similar to Lemma 4.8. The facts that the differential decreases the grading by 1 and the composition maps are chain maps are immediate from the definitions.  $\square$

Given weighted  $A_\infty$ -modules  $\mathcal{M}$  and  $\mathcal{N}$  over  $\mathcal{A}$  and integers  $w \geq 0$  and  $d \in \mathbb{Z}$ , a *morphism of degree  $d$  and weight  $w$*  is a collection of  $\mathbf{k}$ -module maps  $f_{1+n}^w: M \otimes A^{\otimes n} \rightarrow N \langle\langle -n - d - \kappa w \rangle\rangle$ . Thus, the space of morphisms of weight  $w$  is the direct product  $\text{Mor}^w(\mathcal{M}, \mathcal{N}) = \prod_{n=0}^{\infty} \text{Mor}(M \otimes A^{\otimes n}, N)$ . The *morphism space* from  $\mathcal{M}$  to  $\mathcal{N}$  is the direct product

$$\text{wMor}(\mathcal{M}, \mathcal{N}) = \prod_{w=0}^{\infty} \text{Mor}^w(\mathcal{M}, \mathcal{N}).$$

This is a chain complex with

$$d: \text{Mor}(\mathcal{M}, \mathcal{N}) \rightarrow \text{Mor}(\mathcal{M}, \mathcal{N})$$

given by

$$(4.43) \quad \begin{aligned} (df)_{1+n}^v(x, a_1, \dots, a_n) &= \sum_{w=0}^v \sum_{k=0}^n (f_{1+n-k}^{v-w}(m_{\mathcal{M}, 1+k}^w(x, a_1, \dots, a_k), a_{k+1}, \dots, a_n) \\ &\quad + m_{\mathcal{N}, 1+n-k}^w(f_{1+k}^{v-w}(x, a_1, \dots, a_k), a_{k+1}, \dots, a_n)) \\ &\quad + \sum_{w=0}^v \sum_{2 \leq i \leq j \leq n} f_{1+n+i-j}^{v-w}(x, a_1, \dots, \mu_{j-i}^w(a_i, \dots, a_{j-1}), \dots, a_n). \end{aligned}$$

(We adhere to the following notational convention: if  $g \in \text{wMor}(\mathcal{M}, \mathcal{N})$ , then  $g^w$  denotes weight  $w$  component, in  $\text{Mor}^w(\mathcal{M}, \mathcal{N})$ .) The kernel of  $d$  is the  *$w$ -module homomorphisms*, and if two morphisms differ by a boundary then they are *chain homotopic*.

*Example 4.44.* The *identity morphism*  $\mathbb{I}_{\mathcal{M}}$  of  $\mathcal{M}$  is defined by

$$\mathbb{I}_{1+n}^w = \begin{cases} \mathbb{I}_M & n = 0 \text{ and } w = 0 \\ 0 & \text{otherwise.} \end{cases}$$

It is straightforward to check that  $\mathbb{I}_{\mathcal{M}}$  is a homomorphism.

Given a degree 0 morphism  $f: \mathcal{M} \rightarrow \mathcal{N}$  and a weighted module transformation tree  $T$  with  $n+1$  inputs and total weight  $w$  there is an induced map

$$F(T): M \otimes A^{\otimes n} \rightarrow N \langle\langle -\dim(T) + (2 - \kappa)w \rangle\rangle$$

This gives a map

$$F: JM_*^{n+1,w} \rightarrow \text{Mor}(M \otimes A^{\otimes n}, N \langle\langle (2 - \kappa)w \rangle\rangle).$$

**Lemma 4.45.** *A morphism  $\{f_n^w\}$  is a homomorphism if and only if for each  $(n, w)$  the induced map  $F$  is a chain map. More generally, the map*

$$\text{Mor}(\mathcal{M}, \mathcal{N}) \rightarrow \prod_{n,w} \text{Mor}(M \otimes A^{\otimes n}, N \langle\langle -\dim(T) + (2 - \kappa)w \rangle\rangle)$$

given by  $f \mapsto F$  is a chain map.

(Compare Lemma 3.23.)

*Proof.* Again, the proof is straightforward and is left to the reader.  $\square$

**Lemma 4.46.** *Let  $\mathcal{M}$  and  $\mathcal{N}$  be  $w$ -modules over  $\mathcal{A}$  and let  $f: \mathcal{M} \rightarrow \mathcal{N}$  be a homomorphism. Then  $f$  is an isomorphism if and only if  $f_1^0$  is an isomorphism.*

*Proof.* As in the proof of Lemma 4.46, it suffices to construct left and right inverses to  $f$ , and we will focus on the left inverse. We construct the left inverse  $g_n^w$  inductively in  $w$  and then  $n$ . Suppose  $g_m^v$  has been defined for all  $v < w$  and for  $v = w$  and  $m \leq n$ , satisfying the condition that  $(g \circ f)_m^v = 0$  for  $v < w$  or  $v = w$  and  $m \leq n$  (except for  $(g \circ f)_1^0 = \mathbb{I}$ ). We have

$$(g \circ f)_{n+1}^w(x, a_1, \dots, a_n) = \sum_{\substack{m \leq n \\ v \leq w}} g_{n-m+1}^{w-v}(f_{m+1}^v(x, a_1, \dots, a_m), a_{m+1}, \dots, a_n).$$

All of these terms have been defined except

$$g_{n+1}^w(f_1^0(x), a_1, \dots, a_n).$$

So, define

$$g_{n+1}^w(f_1^0(x), a_1, \dots, a_n) = \sum_{\substack{m \leq n \\ v \leq w \\ (m,v) \neq (0,0)}} g_{n-m+1}^{w-v}(f_{m+1}^v(x, a_1, \dots, a_m), a_{m+1}, \dots, a_n),$$

using the fact that  $f_1^0$  is an isomorphism, and continue the induction.  $\square$

**Definition 4.47.** *Let  $\mathcal{M}$  and  $\mathcal{N}$  be bonsai  $w$ -modules over a bonsai  $w$ -algebra  $\mathcal{A}$ . A morphism  $f \in \text{Mor}(\mathcal{M}, \mathcal{N})$  is bonsai if there is an integer  $N$  so that for any module transformation tree  $T$  with  $\dim(T) > N$ ,  $f(T) = 0$ .*

As in the unweighted case, it is clear that the bonsai morphisms form a subcomplex of  $\text{Mor}(\mathcal{M}, \mathcal{N})$ .

**4.6. Units in weighted  $A_\infty$ -modules.** The discussion from Section 4.3 adapts to weighted modules as follows.

**Definition 4.48.** *A  $w$ -module  $\mathcal{M}$  over a weakly unital  $w$ -algebra  $\mathcal{A}$  is weakly unital if  $m_2^0(x, \mathbf{1}) = x$  for all  $x \in M$ . A weakly unital  $w$ -module  $\mathcal{M}$  over a strictly unital  $w$ -algebra  $\mathcal{A}$  is strictly unital if for any sequence of elements  $a_1, \dots, a_n \in A$  with the property that  $a_i = \mathbf{1}$  for some  $i$ , any  $x \in M$ , and any weight  $w$ ,  $m_{1+n}^w(x, a_1, \dots, a_n) = 0$ , except in the special case where  $w = 0$  and  $n = 1$  (in which case  $m_2^0(x, \mathbf{1}) = x$ ).*

The proofs of the following lemma and theorem are essentially the same as the proofs of Lemma 3.87 and Theorem 3.86 respectively, with an extra induction on the weight.

**Lemma 4.49.** *Suppose that  $\mathcal{M}$  is a weakly unital  $A_\infty$ -module and*

$$\phi_n^v: M \otimes A \otimes \dots \otimes A \rightarrow M$$

is any  $\mathbb{k}$ -module map of degree  $(2 - \kappa)v + n - 1$ . There is an  $A_\infty$ -module  $\overline{\mathcal{M}}$  isomorphic to  $\mathcal{M}$  so that  $\overline{m}_i^w = m_i^w$  for  $i < n$  or  $w < v$ ; and

$$\overline{m}_n^v = m_n^v + d\phi_n^v$$

(where  $d$  is the differential on the morphism complex  $\text{Mor}(M \otimes A^{\otimes(n-1)}, A)$ ).

**Theorem 4.50.** *Every weakly unital  $w$ -module  $\mathcal{M}$  over a strictly unital  $w$ -algebra is isomorphic to a strictly unital  $w$ -module  $\mathcal{N}$ . If  $\mathcal{M}$  is bonsai then  $\mathcal{N}$  and the isomorphism can be taken to be bonsai, as well.*

**Convention 4.51.** *Unless otherwise noted, when we are over strictly unital  $w$ -algebras we will only consider strictly unital  $w$ -modules.*

If  $\mathcal{M}$  and  $\mathcal{N}$  are strictly unital then a morphism  $f: \mathcal{M} \rightarrow \mathcal{N}$  is *strictly unital* if  $f_{n+1}^w(m, a_1, \dots, a_n) = 0$  if some  $a_i = \mathbf{1}$ . The strictly unital morphisms form a subcomplex  $\text{uMor}(\mathcal{M}, \mathcal{N})$  of the complex  $\text{Mor}(\mathcal{M}, \mathcal{N})$  of all  $w$ -module morphisms.

**Proposition 4.52.** *Given strictly unital  $w$ -modules  $\mathcal{M}$  and  $\mathcal{N}$  over a strictly unital  $w$ -algebra  $\mathcal{A}$ , the inclusion of chain complexes  $\text{uMor}(\mathcal{M}, \mathcal{N}) \rightarrow \text{Mor}(\mathcal{M}, \mathcal{N})$  is a chain homotopy equivalence. If  $\mathcal{A}$ ,  $\mathcal{M}$ , and  $\mathcal{N}$  are bonsai, the same statement holds for the subcomplexes of bonsai strictly unital and non-unital morphisms.*

*Proof.* As a notational preliminary, recall that in the proof of Proposition 3.89, there was an inclusion map  $\text{Mor}^{\text{u}}(\mathcal{M}, \mathcal{N}) \rightarrow \text{Mor}(\mathcal{M}, \mathcal{N})$ . Let

$$(4.53) \quad \begin{aligned} H = & \sum_{i_1 < \dots < i_k} H_{i_k} \circ \partial \circ H_{i_{k-1}} \circ \dots \circ \partial \circ H_{i_1} \\ & + \sum_{i_1 < \dots < i_k, 1 \leq j < k} H_{i_k} \circ \partial \circ H_{i_{k-1}} \circ \partial \circ \dots \circ \partial \circ H_{i_{j+1}} \circ H_{i_j} \circ \partial \circ \dots \circ H_{i_1} \circ \partial. \end{aligned}$$

where  $H_i$  are as in Equation (3.90). It is straightforward to see that the homotopy inverse  $\Pi$  (as in Equation 3.91) to the inclusion map  $\text{Mor}^{\text{u}}(\mathcal{M}, \mathcal{N}) \rightarrow \text{Mor}(\mathcal{M}, \mathcal{N})$  is given by  $\mathbb{I} + \partial \circ H + H \circ \partial$ . We now upgrade these maps to the weighted context.

Given  $f \in \text{wMor}(\mathcal{M}, \mathcal{N})$ , let  $\mathcal{H}_i(f) \in \text{wMor}(\mathcal{M}, \mathcal{N})$  be the map with

$$\mathcal{H}_i(f)^w(x, a_1, \dots, a_{n-2}) = \begin{cases} 0 & \text{if } n-1 < i \\ f_n^w(x, a_1, \dots, a_{i-1}, \mathbf{1}, a_{i+1}, \dots, a_{n-2}) & \text{otherwise.} \end{cases}$$

Define  $\mathcal{H}: \text{wMor}(\mathcal{M}, \mathcal{N}) \rightarrow \text{wMor}(\mathcal{M}, \mathcal{N})$  by

$$\begin{aligned} \mathcal{H} = & \sum_{i_1 < \dots < i_k} \mathcal{H}_{i_k} \circ \partial \circ \mathcal{H}_{i_{k-1}} \circ \dots \circ \partial \circ \mathcal{H}_{i_1} \\ & + \sum_{i_1 < \dots < i_k, 1 \leq j < k} \mathcal{H}_{i_k} \circ \partial \circ \mathcal{H}_{i_{k-1}} \circ \partial \circ \dots \circ \partial \circ \mathcal{H}_{i_{j+1}} \circ \mathcal{H}_{i_j} \circ \partial \circ \dots \circ \mathcal{H}_{i_1} \circ \partial. \end{aligned}$$

For a fixed integer  $v \geq 0$ , let  $\text{uMor}_v(\mathcal{M}, \mathcal{N}) \subset \text{Mor}(\mathcal{M}, \mathcal{N})$  consist of those morphisms  $f$  with

$$f^w(x, a_1, \dots, a_{i-1}, \mathbf{1}, a_{i+1}, \dots, a_n) = 0$$

for all  $w < v$  and  $1 \leq i < n+1$ . This specifies a filtration of the chain complex  $\text{Mor}(\mathcal{M}, \mathcal{N})$ , with the following properties:

- $\text{uMor}_{v_1}(\mathcal{M}, \mathcal{N}) \supset \text{uMor}_{v_2}(\mathcal{M}, \mathcal{N})$  if  $v_1 < v_2$ ,
- $\text{uMor}_0(\mathcal{M}, \mathcal{N}) = \text{Mor}(\mathcal{M}, \mathcal{N})$ , and
- $\text{uMor}(\mathcal{M}, \mathcal{N}) = \bigcap_{v=0}^{\infty} \text{uMor}_v(\mathcal{M}, \mathcal{N})$ .

Let

$$(4.54) \quad F = \mathbb{I} + \partial \circ \mathcal{H} + \mathcal{H} \circ \partial.$$

We claim that

$$(4.55) \quad F(\text{uMor}_v(\mathcal{M}, \mathcal{N})) \subseteq \text{uMor}_{v+1}(\mathcal{M}, \mathcal{N}).$$



To see this, observe that for  $f \in \text{uMor}_v(\mathcal{M}, \mathcal{N})$ , the terms in the weight  $v+1$  part of  $(\mathbb{I} + \partial \circ \mathcal{H} + \mathcal{H} \circ \partial)(f)$  involving components of  $f^w$  with weight  $w < v+1$  vanish after we specialize to  $a_i = \mathbf{1}$ . Thus,

$$\begin{aligned} [(\mathbb{I} + \partial \circ \mathcal{H} + \mathcal{H} \circ \partial)(f)]^{v+1}(a_1, \dots, a_{i-1}, \mathbf{1}, a_{i+1}, \dots, a_n) = \\ [(\mathbb{I} + \partial \circ H + H \circ \partial)(f^{v+1})](a_1, \dots, a_{i-1}, \mathbf{1}, a_{i+1}, \dots, a_n), \end{aligned}$$

which vanishes by Proposition 3.89, verifying Equation (4.55). (We are actually applying the proof of Proposition 3.89, where it is shown that  $\Pi = \partial \circ H + H \circ \partial$  is a projection to the strictly unital morphism space.)

Let  $P_{\leq v}: \text{Mor}(\mathcal{M}, \mathcal{N}) \rightarrow \bigoplus_{w \leq v} \text{Mor}^w(\mathcal{M}, \mathcal{N})$  denote the projection to the weight less than  $v$  portion. If  $\xi \in \text{uMor}_v(\mathcal{M}, \mathcal{N})$ , then  $P_{\leq v} \circ F(\xi) = P_{\leq v}(\xi)$ . Let  $F^{(ok)}$  denote the  $k^{\text{th}}$  iterate of  $F$  applied to  $\xi$ . It follows that for any pair of integers  $0 \leq w \leq i$ ,

$$(4.56) \quad P_{\leq w} \circ F^{(oi)} = P_{\leq w} \circ F^{(ow)}.$$

Consider the function  $\Phi: \text{Mor}(\mathcal{M}, \mathcal{N}) \rightarrow \text{Mor}^u(\mathcal{M}, \mathcal{N})$ , characterized by  $P_{\leq w} \circ \Phi = P_{\leq w} \circ F^{(ow)}$ . We think of this as the infinite composition of  $F$  with itself, since  $F \circ \Phi = \Phi$ . Moreover,  $\Phi$  is the identity map on  $\text{uMor}(\mathcal{M}, \mathcal{N}) \subset \text{Mor}(\mathcal{M}, \mathcal{N})$ .

The map  $F$  is chain homotopic to the identity. This homotopy can be used to construct a chain homotopy of  $\Phi$  to the identity. In detail, the chain homotopy is given by

$$\mathcal{K} = \sum_{i=0}^{\infty} \mathcal{H} \circ F^{(oi)}.$$

To see that  $\mathcal{K}$  is well-defined, we show that for any  $w$ ,  $P_{\leq w} \circ \mathcal{K}$  is a finite sum. Specifically,

$$(4.57) \quad P_{\leq w} \left( \sum_{i=0}^{\infty} \mathcal{H} \circ F^{(oi)} \right) = \sum_{i=0}^{\infty} P_{\leq w} \circ \mathcal{H} \circ F^{(oi)} = \sum_{i=0}^w P_{\leq w} \circ \mathcal{H} \circ F^{(oi)},$$

since for all  $i \geq w$ , the image of  $F^{(oi)}$  is in  $\text{uMor}_{w+1}(\mathcal{M}, \mathcal{N})$  (by Equation (4.55)) and

$$P_{\leq w} \circ \mathcal{H}|_{\text{uMor}_{w+1}(\mathcal{M}, \mathcal{N})} = 0$$

(which in turn is clear from the definition of  $\mathcal{H}$ ).

To see that  $\Phi = \mathbb{I} + \partial \circ \mathcal{K} + \mathcal{K} \circ \partial$ , it suffices to verify that

$$(4.58) \quad P_{\leq w} \circ (\mathbb{I} + \partial \circ \mathcal{K} + \mathcal{K} \circ \partial) = P \circ F^{ow}.$$

To this end, abbreviate, for any fixed  $w$ ,  $P = P_{\leq w}$ . Using the fact that  $P$  is a chain map, the definition of  $\mathcal{K}$ , Equation (4.57),  $P$  is a chain map (again),  $F$  is a chain map, Equation (4.54), and Equation (4.56), in succession, we see that

$$\begin{aligned} P \circ (\mathbb{I} + \partial \circ \mathcal{K} + \mathcal{K} \circ \partial) &= P + \partial \circ P \circ \mathcal{K} + P \circ \mathcal{K} \circ \partial \\ &= P + \partial \circ P \circ \mathcal{H} \circ \left( \sum_{i=0}^{\infty} F^{(oi)} \right) + P \circ \mathcal{H} \circ \left( \sum_{i=0}^{\infty} F^{(oi)} \right) \circ \partial \\ &= P + \partial \circ P \circ \mathcal{H} \circ \left( \sum_{i=0}^w F^{(oi)} \right) + P \circ \mathcal{H} \circ \left( \sum_{i=0}^w F^{(oi)} \right) \circ \partial \\ &= P + P \circ \partial \circ \mathcal{H} \circ \left( \sum_{i=0}^w F^{(oi)} \right) + P \circ \mathcal{H} \circ \left( \sum_{i=0}^w F^{(oi)} \right) \circ \partial \\ &= P + P \circ (\partial \circ \mathcal{H} + \mathcal{H} \circ \partial) \circ \left( \sum_{i=0}^w F^{(oi)} \right) \end{aligned}$$



$$\begin{aligned}
&= P + P \circ (\mathbb{I} + F) \circ \left( \sum_{i=0}^w F^{(oi)} \right) \\
&= P + P \circ (\mathbb{I} + F^{o(w+1)}) = P \circ F^{o(w+1)} = P \circ F^{ow},
\end{aligned}$$

verifying Equation (4.58).

Clearly, now,  $\Phi = \mathbb{I} + \partial \circ \mathcal{K} + \mathcal{K} \circ \partial$  is the homotopy inverse to the inclusion  $\text{uMor}(\mathcal{M}, \mathcal{N}) \subset \text{Mor}(\mathcal{M}, \mathcal{N})$ . The fact that  $\Phi$  preserves the property of being bonsai follows as in the unweighted case.  $\square$

**4.7. Weighted type  $D$  structures.** Let  $\mathcal{A}$  be a  $w$ -algebra over  $\mathbb{k}$  and fix an element  $X \in \mathbb{k}$  with grading  $-\kappa$ . Assume that  $X$  acts centrally on  $A$ , in the sense that  $Xa = aX$  for all  $a \in A$ .

**Definition 4.59.** Let  $P$  be a graded left  $\mathbb{k}$ -module and  $\delta^1: P \rightarrow A \otimes P\langle\langle 1 \rangle\rangle$  a left  $\mathbb{k}$ -module map. Define  $\delta^n: P \rightarrow A^{\otimes n} \otimes P\langle\langle n \rangle\rangle$  to be the result of iterating  $\delta^1$   $n$  times. (In the special case  $n = 0$ ,  $\delta^0$  is the identity map  $P \rightarrow P$ .) We say that  $\delta^1$  (or  $(P, \delta^1)$ ) is operationally bounded (or just bounded) if

- $\delta^n$  vanishes identically for  $n$  sufficiently large and
- the action of  $X$  on  $A$  is nilpotent, i.e., for  $n$  sufficiently large and all  $a \in A$ ,  $X^n \cdot a = 0$ .

**Definition 4.60.** With notation as in Definition 4.59, suppose that either  $\delta^1$  is bounded or  $\mathcal{A}$  is bonsai. We say that  $(P, \delta^1)$  is a (left) type  $D$  structure over  $\mathcal{A}$  with charge  $X$  if

$$(4.61) \quad \sum_{w=0}^{\infty} \sum_{n=0}^{\infty} X^w (\mu_n^w \otimes \mathbb{I}) \circ \delta^n = 0 \in A \otimes P.$$

Sometimes we abbreviate a type  $D$  structure as  ${}^{\mathcal{A}}P = (P, \delta: P \rightarrow A \otimes P\langle\langle 1 \rangle\rangle)$ .

Letting

$$\delta = \sum_{i=0}^{\infty} \delta^i: P \rightarrow \overline{\mathcal{T}}^*(A\langle\langle 1 \rangle\rangle) \otimes P \quad \mu_{\bullet} = \sum_{n,w} X^w \cdot \mu_n^w: \mathcal{T}^*(A\langle\langle 1 \rangle\rangle) \rightarrow A\langle\langle 2 \rangle\rangle$$

then we can represent Equation (4.61) graphically by

$$\begin{array}{c}
\vdots \\
\downarrow \\
\delta \\
\swarrow \\
\mu_{\bullet} \\
\downarrow \\
\vdots
\end{array} = 0.$$

The structure equation (4.61) includes the terms  $\mu_0^w \otimes \mathbb{I}$ .

If  $\kappa = 0$ , we can consider cases where  $X = \mathbf{1}$ , the unit in  $\mathbb{k}$ , when the type  $D$  structure relation takes the simpler form

$$(4.62) \quad \sum_{w=0}^{\infty} \sum_{n=0}^{\infty} (\mu_n^w \otimes \mathbb{I}) \circ \delta^n = 0 \in A \otimes P.$$

Let  $\mathcal{A}$  be a weighted algebra, and suppose that  ${}^{\mathcal{A}}P$  and  ${}^{\mathcal{A}}Q$  are weighted type  $D$  structures (with either  $\mathcal{A}$  bonsai or  ${}^{\mathcal{A}}P$  and  ${}^{\mathcal{A}}Q$  operationally bounded). Endow the space  $\text{Hom}_{\mathbb{k}}(P, A \otimes Q)$  with the endomorphism  $d$  given by

$$d(\phi) = (\mu_{\bullet} \otimes \mathbb{I}_Q) \circ (\mathbb{I}_{\overline{\mathcal{T}}^* A} \otimes \delta_Q) \circ (\mathbb{I}_{\overline{\mathcal{T}}^* A} \otimes \phi) \circ \delta_P$$

or, graphically,

$$d(\phi) = \begin{array}{c} \downarrow \\ \delta_P \\ \downarrow \\ \phi \\ \downarrow \\ \delta_Q \\ \downarrow \\ \mu \bullet \\ \downarrow \end{array} = \sum_{i,j,w \geq 0} X^w \begin{array}{c} \downarrow \\ \delta_P^i \\ \downarrow \\ \phi \\ \downarrow \\ \delta_Q^j \\ \downarrow \\ \mu_{i+j+1}^w \\ \downarrow \end{array}.$$

Let  $\text{Mor}^{\mathcal{A}}(\mathcal{A}P, \mathcal{A}Q)$  denote the graded  $R$ -module  $\text{Hom}_{\mathbb{k}}(P, A \otimes Q)$ , endowed with the endomorphism  $d$ . We call this the space of *weighted morphisms* from  $\mathcal{A}P$  to  $\mathcal{A}Q$ .

**Lemma 4.63.** *Fix a weighted algebra  $\mathcal{A}$  and type  $D$  structures  $\mathcal{A}P$  and  $\mathcal{A}Q$  over  $\mathcal{A}$  with charge  $X$ . If either  $\mathcal{A}$  is bonsai or  $\mathcal{A}P$  and  $\mathcal{A}Q$  are both operationally bounded then the morphism space  $\text{Mor}(\mathcal{A}P, \mathcal{A}Q)$  is a chain complex.*

*Proof.* This is an easy consequence of the weighted  $A_\infty$  relation on  $\mathcal{A}$ , and the type  $D$  structure relations on  $\mathcal{A}P$  and  $\mathcal{A}Q$ . That is,

$$d^2(\phi) = \begin{array}{c} \downarrow \\ \delta_P \\ \downarrow \\ \delta_P \\ \downarrow \\ \phi \\ \downarrow \\ \delta_Q \\ \downarrow \\ \delta_Q \\ \downarrow \\ \mu \bullet \\ \downarrow \end{array} = \begin{array}{c} \downarrow \\ \delta_P \\ \downarrow \\ \delta_P \\ \downarrow \\ \delta_P \\ \downarrow \\ \phi \\ \downarrow \\ \delta_Q \\ \downarrow \\ \delta_Q \\ \downarrow \\ \mu \bullet \\ \downarrow \end{array} + \begin{array}{c} \downarrow \\ \delta_P \\ \downarrow \\ \phi \\ \downarrow \\ \delta_Q \\ \downarrow \\ \delta_Q \\ \downarrow \\ \mu \bullet \\ \downarrow \end{array} = 0.$$

Note that each term

$$X^w(\mu_{i+j+1}^w \otimes \mathbb{I}_Q) \circ (\mathbb{I} \otimes \delta_Q^j) \circ (\mathbb{I} \otimes \phi) \circ \delta_P^i$$

in  $d(\phi)$  has grading

$$\text{gr}(\phi) - i - j + (-1 + i + j + \kappa w) - \kappa w = \text{gr}(\phi) - 1. \quad \square$$

Given a sequence of weighted type  $D$  structures  $\mathcal{A}P_0, \dots, \mathcal{A}P_\ell$  (with  $\ell \geq 1$ ), there are composition maps

$$\underline{\mu}_\ell: \text{Mor}(\mathcal{A}P_{\ell-1}, \mathcal{A}P_\ell) \otimes_R \dots \otimes_R \text{Mor}(\mathcal{A}P_0, \mathcal{A}P_1) \rightarrow \text{Mor}(\mathcal{A}P_0, \mathcal{A}P_\ell)\langle\langle 2 - \ell \rangle\rangle,$$

defined by

$$\underline{\mu}_\ell(\phi_\ell \otimes \dots \otimes \phi_1) = \sum_w X^w (\mu^w \otimes \mathbb{I}_{M_\ell}) \circ (\mathbb{I}_{\mathcal{T}^*(A)} \otimes \delta_{P_\ell}) \circ (\mathbb{I}_{\mathcal{T}^*(A)} \otimes \phi_\ell) \circ \dots \circ (\mathbb{I}_{\mathcal{T}^*(A)} \otimes \delta_{P_2}) \circ (\mathbb{I}_{\mathcal{T}^*(A)} \otimes \phi_1) \circ (\delta_{P_1}).$$

That is, graphically:

$$\underline{\mu}_\ell(\phi_\ell \otimes \cdots \otimes \phi_1) = \sum_w X^w$$

The diagram illustrates the graphical representation of the composition map  $\underline{\mu}_\ell$ . On the left, a tree structure is shown with inputs  $\delta_{P_0}, \phi_1, \delta_{P_1}, \dots, \phi_\ell, \delta_{P_\ell}$  and two output vertices  $\mu_\bullet$  and  $\mu_\bullet^w$ . On the right, the same tree structure is shown, but the output vertex is  $\mu_\bullet^w$ , and the entire expression is equated to a sum over  $w$  of  $X^w$ .

If  $\mathcal{A}$  is strictly unital with unit  $\mathbf{1}$ , we can define the identity map of the type  $D$  structure  ${}^{\mathcal{A}}P$  by  $\mathbb{I}(x) = \mathbf{1} \otimes x$ .

**Proposition 4.64.** *Given a bonsai weighted  $A_\infty$ -algebra  $\mathcal{A}$ , the set of weighted type  $D$  structures, with morphism spaces given by  $\text{Mor}$ , and composition maps defined by  $\underline{\mu}_\ell$ , forms a (nonunital)  $A_\infty$ -category. That is, the composition maps  $\underline{\mu}_\ell$  have grading  $2 - \ell$  and satisfy the  $A_\infty$  relations. If  $\mathcal{A}$  is strictly unital then the category of type  $D$  structures is also unital. The statements also hold for the category of operationally bounded type  $D$  structures over a non-bonsai algebra.*

*Proof.* The proof is essentially the same as in the unweighted case [LOT15, Lemma 2.2.27]. The statement about gradings is arithmetic. The  $A_\infty$  relation counts contributions of trees which consist of a sequence of operations on the  $P_i$ , for  $i = 1, \dots, \ell$  starting with  $\delta_{P_i}$ , alternating between  $\delta_{P_i}, \phi_i$ , and ending with  $\delta_{P_\ell}$ ; some consecutive sequence of the algebra outputs are channeled into a vertex labelled by  $\mu_\bullet$ , and then that output, and all others, are channeled into a second vertex labelled by  $\mu_\bullet^w$ . For the  $A_\infty$  relation on the category, we consider only those trees for which the first  $\mu_\bullet^w$ -vertex has an input from at least one  $\phi_i$ . Trees which do not have this property have all the inputs channeled into the first  $\mu_\bullet^w$  which come from a single  $\delta_{P_i}$ ; their contribution vanishes by the type  $D$  structure relation on  $P_i$ . The sum of all the trees is zero by the weighted  $A_\infty$  relation on the algebra. It is immediate from the definition of strict unitality of a weighted algebra that, in the strictly unital case, the identity maps are strict units for composition.  $\square$

*Remark 4.65.* There is also a notion of homotopy unital weighted  $A_\infty$ -algebras, and the category of type  $D$  structures over a homotopy unital weighted  $A_\infty$ -algebra is a homotopy unital  $A_\infty$ -category. See Sections 4.9 and 7.5.

**4.8. Box products.** Given  $X \in \mathbb{k}$ , a  $w$ -algebra  $\mathcal{A}$  over  $\mathbb{k}$  so that  $X$  acts centrally on  $A$ , a type  $D$  structure  $P$  over  $\mathcal{A}$  with charge  $X$ , and a  $w$ -module  $\mathcal{M}$  over  $\mathcal{A}$ , we define  $\mathcal{M} \boxtimes P$  to be the graded  $R$ -module  $M \otimes P$  with differential

$$(4.66) \quad \partial = \sum_{n=0}^{\infty} \sum_{w=0}^{\infty} X^w (m_{1+n}^w \otimes \mathbb{I}) \circ (\mathbb{I} \otimes \delta^n).$$

This sum makes sense if either:

- $\mathcal{M}$  and  $\mathcal{A}$  are bonsai or
- $P$  is operationally bounded.

We may represent Equation (4.66) graphically as

$$\begin{array}{c} \vdots \\ \downarrow \\ \delta \\ \swarrow \\ m \bullet \\ \downarrow \\ \vdots \end{array} = \sum_{n,w \geq 0} X^w \begin{array}{c} \vdots \\ \downarrow \\ \delta^n \\ \swarrow \\ m_{n+1}^w \\ \downarrow \\ \vdots \end{array} .$$

**Lemma 4.67.** *Let  $\mathcal{A}$  be a weighted  $A_\infty$ -algebra,  $\mathcal{M}_{\mathcal{A}}$  a weighted  $A_\infty$ -module, and  ${}^{\mathcal{A}}P$  a weighted type  $D$  structure with some charge  $X$ . Assume that either  $\mathcal{M}$  and  $\mathcal{A}$  are bonsai or  $P$  is operationally bounded. Then the map  $\partial$  on  $\mathcal{M} \boxtimes P$  has degree  $-1$  and satisfies  $\partial^2 = 0$ .*

*Proof.* The proof is the same as in the unweighted case [LOT18, Lemma 2.30].  $\square$

We have the following analogue of the functoriality part of Lemma 3.44:

**Lemma 4.68.** *The operation  $\boxtimes$  extends to a (non-unital)  $A_\infty$ -bifunctor from the categories of weighted  $A_\infty$ -modules and operationally bounded type  $D$  structures with charge  $X$  to the category of chain complexes. It also defines an  $A_\infty$ -bifunctor from the categories of bonsai weighted  $A_\infty$ -modules and bonsai maps and arbitrary type  $D$  structures with charge  $X$  to the category of chain complexes. For strictly unital weighted algebras and modules,  $\boxtimes$  is a strictly unital functor, i.e.,  $\mathbb{I} \boxtimes \mathbb{I} = \mathbb{I}$ . In particular, in the strictly unital case, the operation  $\boxtimes$  respects homotopy equivalences of  $\mathcal{M}$  and  $P$ .*

*Proof.* The proof of the first statement is the same as in the unweighted case [LOT15, Lemmas 2.3.3 and 2.3.7]. The second statement is immediate from the definitions. The third statement follows immediately from the other two.  $\square$

**4.9. Homotopy unital weighted algebras and modules.** Unlike the unweighted case, the tensor product of weighted algebras makes use of a unit. In Sections 6 and 7 we will focus mainly on the case that the weighted algebras are strictly unital, but in order to prove associativity of the tensor product we need to relax this to allow homotopy unital weighted algebras. This is a weighted extension of (a simple variant) of a well-known notion for  $A_\infty$ -algebras [FOOO09, Section 3.3]. As usual, we will define the notion using a complex of decorated trees; in the unweighted case, this is essentially the cellular chains on Muro-Tonks's unital associahedra [MT14] (see also [Lyu11]).

**Definition 4.69.** *A thorn tree consists of:*

- A planar, rooted tree  $T$ .
- A partition of the leaves of  $T$  into the following five sets: The output, which is the root, the inputs, the thorns, the stumps, and the popsicles. Of these, we regard only popsicles as internal vertices.
- A weight function from the internal vertices of  $T$  to  $\mathbb{Z}_{\geq 0}$ .

*These are required to satisfy the conditions that:*

- Each internal vertex either has valence at least 3 or weight  $> 0$ .
- The tree has at least one vertex which is not a thorn or the output. (This disallows exactly one tree.)

*Composition of thorn trees is defined in the obvious way.*

*The differential of a thorn tree  $T$  is the sum of the following terms:*

- all ways of splitting a single internal vertex in  $T$  into two vertices to obtain a new thorn tree,

- all ways of replacing a single thorn in  $T$  with a stump, and
- all ways of deleting a single thorn in  $T$  which is connected to a 2-input (3-valent), weight 0 vertex.

The dimension of a thorn tree  $T$  is

$$\dim(T) = n + 2w + t - v - 1$$

where  $n$  is the number of inputs,  $w$  is the total weight,  $t$  is the number of thorns, and  $v$  is the number of internal vertices.

The homotopy unital weighted trees complex  $uX_*^{*,*}$  is the free chain complex over  $R$  generated by the thorn trees. There is a tri-grading on the homotopy unital weighted trees complex by the grading, the number of inputs, and the total weight. The summand with  $n$  inputs and weight  $w$  is denoted  $uX_*^{n,w}$ .

See Figure 27. Note that there is a weight 0 thorn tree with no one input and no internal vertices, the *identity tree*  $\downarrow$ , which is the identity for composition of trees. Abusing terminology, we will often call the 0-input tree with no internal vertices or thorns and a single stump the *stump*. Composing a tree with the stump adds a stump to the tree.

**Lemma 4.70.** *The  $n$ -input, weight  $w$  homotopy unital weighted trees complex  $uX_*^{n,w}$  is a chain complex, and the differential decreases the grading (by the dimension  $\dim(T)$ ) by one. Further, the composition map  $\circ_i: uX_*^{n_1,w_1} \times uX_*^{n_2,w_2} \rightarrow uX_*^{n_1+n_2-1,w_1+w_2}$  is a chain map.*

*Proof.* As in Lemma 4.8, to prove that  $\partial^2 = 0$  we consider the dual complex. In the dual complex, the differential is the sum of all ways of contracting an edge, turning a stump into a thorn, or adding a thorn to an edge. Each of the following kinds of terms in  $\delta^2$  cancels in pairs:

- Contracting two edges.
- Turning a stump into a thorn and contracting an edge.
- Turning two stumps into thorns.
- Turning a stump into a thorn and adding a thorn to an edge.
- Adding two thorns.
- Contracting an edge and adding a thorn to a different edge.

The remaining terms correspond to adding a thorn to an edge  $e$ , which splits  $e$  into two edges  $e_1$  and  $e_2$  and then contracting one of  $e_1$  or  $e_2$ . This has the same effect as adding a thorn at one of the vertices adjacent to  $e$ . Further, each way of adding a thorn at a vertex occurs twice, corresponding to the two edges adjacent to the thorn. Thus, terms in  $\delta^2$  of this form also cancel in pairs.

The facts that the differential decreases the grading by 1 and that composition is a chain map are immediate from the definitions.  $\square$

**Definition 4.71.** *A homotopy unital weighted algebra  $\mathcal{A}$  over  $\mathbb{k}$  consists of a dg  $\mathbb{k}$ -bimodule  $A$  and a chain map  $\mu: uX_*^{n,w} \rightarrow \text{Mor}(A^{\otimes n}, A\langle\langle(2-\kappa)w\rangle\rangle)$  for each  $n, w$ , so that  $\mu(S \circ_i T) = \mu(S) \circ_i \mu(T)$ .*

*Given a homotopy unital weighted algebra  $\mathcal{A}$ , the image of the stump  $\top$  is the homotopy unit in  $\mathcal{A}$ , and is denoted  $\mathbf{1}$ .*

*A homotopy unital weighted algebra  $\mathcal{A}$  is split homotopy unital if there is a  $R$ -module splitting  $A = R(\mathbf{1}) \oplus A'$ .*

There is an inclusion from the weighted trees complex into the homotopy unital weighted trees complex, so we can regard any homotopy unital weighted algebra as an ordinary weighted algebra. In other words, a homotopy unital weighted algebra has an *underlying weighted algebra*. Conversely, given a strictly unital weighted algebra  $\mathcal{A}$  there is an induced homotopy unital weighted algebra as follows. Given a thorn tree  $T$ , with  $> 0$  thorns,  $\mu(T) = 0$ . For a thorn tree  $T$  with no thorns,  $\mu(T)$  is obtained by inserting the unit  $\mathbf{1}$  at each stump of  $T$ , and then applying the  $k$ -input, weight  $w$

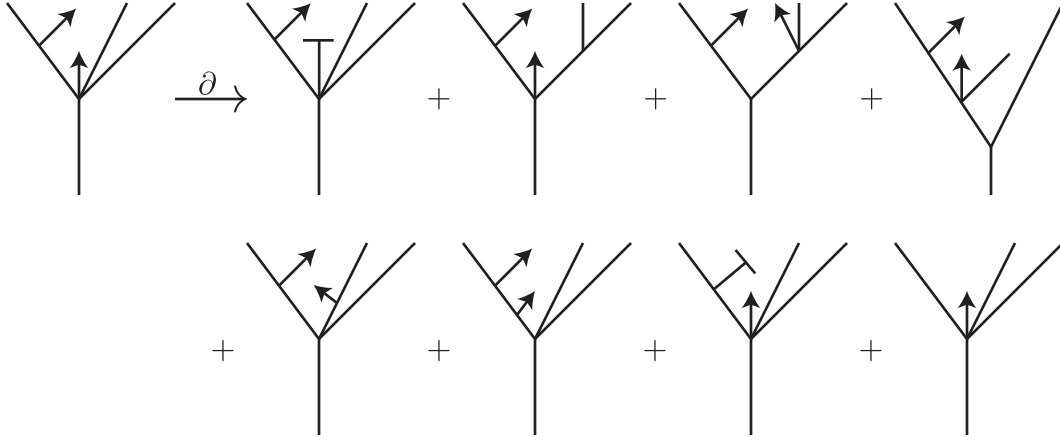

FIGURE 27. **A thorn tree and its differential.** The thorn tree on the left has 3 inputs, no stumps, and two thorns. We have drawn an example in which all vertices have weight 0, so we have suppressed the weights.

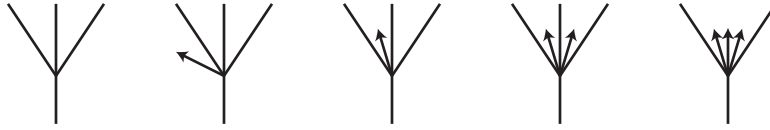

FIGURE 28. **Notation for weighted corollas with thorns.** From left to right,  $\Psi_3^0$ ,  $\Psi_{0\uparrow 3}^0$ ,  $\Psi_{1\uparrow 2}^0$ ,  $\Psi_{1\uparrow 1\uparrow 1}^0$ ,  $\Psi_{1\uparrow 0\uparrow 0\uparrow 1}^0$ .

operation from  $\mathcal{A}$  at each  $k$ -input, weight  $w$  vertex of  $T$ . It is straightforward to verify that this defines a chain map.

A homotopy unital weighted algebra is determined by the unit  $\mathbf{1}$  and the operations corresponding to a corolla with some thorns coming out. That is, given a sequence of non-negative integers  $n_1, \dots, n_k$  there is a tree  $\Psi_{n_1\uparrow n_2\uparrow \dots \uparrow n_k}^w$  with one internal vertex with weight  $w$ , with  $n_1$  inputs followed by a thorn followed by  $n_2$  inputs, another thorn, and so on. See Figure 28. (The operations on the underlying weighted algebra correspond to the case  $k = 1$ .) The operations

$$\mu_{n_1\uparrow \dots \uparrow n_k}^w = \mu(\Psi_{n_1\uparrow n_2\uparrow \dots \uparrow n_k}^w): A^{\otimes(n_1+\dots+n_k)} \rightarrow A,$$

together with the unit  $\mathbf{1}$ , determine the homotopy unital weighted algebra. (We have suppressed the grading shift in this formula.) It is not hard to rephrase the structure relations for a homotopy unital weighted algebra in terms of the unit  $\mathbf{1}$  and the operations  $\mu_{n_1\uparrow \dots \uparrow n_k}^w$ .

Given a corolla  $\Psi_{n_1\uparrow n_2\uparrow \dots \uparrow n_k}^w$  with  $n = n_1 + \dots + n_k$ , there is a monotone injection  $\sigma_{n_1\uparrow \dots \uparrow n_k}: \{1, \dots, n\} \hookrightarrow \{1, \dots, n+k-1\}$  with image  $\{1, \dots, n+k-1\} \setminus \{n_1+1, n_1+n_2+2, \dots, n_1+\dots+n_{k-1}+k-1\}$ . For the operation  $\mu_{n_1\uparrow \dots \uparrow n_k}^w(a_1, \dots, a_n)$  we call  $\sigma_{n_1\uparrow \dots \uparrow n_k}(i)$  the *apparent position* of  $a_i$ .

**Definition 4.72.** *The homotopy unital weighted module trees complex is the subquotient of  $uX_*^{*,*}$  obtained by requiring that there are no stumps, popsicles, or thorns to the left of the leftmost input.*

A homotopy unital weighted module  $\mathcal{M}$  over a homotopy unital weighted algebra  $\mathcal{A}$  consists of a chain complex  $M$  over  $\mathbb{k}$  and grading-preserving chain maps  $m: uXM_*^{n,w} \rightarrow \text{Mor}(M \otimes A^{\otimes n-1}, M \langle (2-\kappa)w \rangle)$  which respect composition in the obvious sense.

Similarly to algebras, homotopy unital weighted modules are determined by the operations

$$\mu_{1+n_1 \uparrow \dots \uparrow n_k}^w : M \otimes A^{\otimes(n_1+\dots+n_k)} \rightarrow A$$

corresponding to a corolla with valence  $n_1 + \dots + n_k + k$  with a mix of thorn and input leaves, where the thorns are at the positions  $n_1 + 2, n_1 + n_2 + 3, \dots$ . (Again, we have suppressed the grading in this formula.)

As in the case of algebras, there is a forgetful map from homotopy unital weighted modules to weighted modules. Further, given a strictly unital weighted module over a strictly unital weighted algebra, there is an induced homotopy unital weighted module, by feeding the unit  $\mathbf{1}$  in at the stumps and declaring trees with thorns to act by zero.

**Definition 4.73.** *A transformation thorn tree consists of:*

- *A planar, rooted tree  $T$ .*
- *A partition of the leaves of  $T$  into the following five sets: The output, which is the root, the inputs, the thorns, the stumps, and the popsicles. Of these, we regard only popsicles as internal vertices.*
- *A coloring of each edge of  $T$  not incident to a thorn as either red or blue, subject to the following conditions:*
  - (1) *The edges adjacent to input leaves are red.*
  - (2) *The edge adjacent to the output leaf is blue.*
  - (3) *For each vertex  $v$ , all of the colored inputs of  $v$  have the same color (red or blue).*
  - (4) *If a vertex  $v$  has a red output, then all of the colored inputs of  $v$  are red; if a vertex has blue inputs, then its output is also blue.**(Compare Definition 2.40.)*
- *A coloring of the non-thorn vertices of  $T$  as red, blue, or purple, subject to the conditions that*
  - (1) *if a vertex has any red inputs then it is red or purple,*
  - (2) *if a vertex has a blue output then it is blue or purple,*
  - (3) *if a vertex has a red output then it is red,*
  - (4) *if a vertex has a blue input then it is blue, and*
  - (5) *no purple vertex is above another purple vertex.**(These conditions determine the color of every vertex whose inputs are not all thorns.)*
- *A weight function from the internal vertices of  $T$  to  $\mathbb{Z}_{\geq 0}$ .*

*These are required to satisfy the condition that each internal vertex either has valence at least 3 or has weight  $> 0$  or is colored purple.*

*The differential of a transformation thorn tree is the sum of all ways of obtaining a new transformation thorn tree by doing one of the following:*

- *splitting a blue (respectively red) vertex into two blue (respectively red) vertices,*
- *splitting a purple vertex into a red vertex feeding into a purple vertex,*
- *splitting a purple vertex into a layer of purple vertices feeding into a blue vertex, with each thorn ending up coming from either the blue vertex or one of the purple vertices,*
- *replacing a thorn by a stump,*
- *deleting a thorn adjacent to a 2-input (3-valent), weight 0 blue or red vertex, or*
- *replacing a 2-valent, weight 0 purple vertex whose input is a thorn by a blue stump.*

*See Figure 29.*

*The dimension (grading) of a weighted thorn tree  $T$  with  $n$  inputs, total weight  $w$ ,  $t$  thorns,  $r$  internal red vertices, and  $b$  internal blue vertices is*

$$\dim(T) = n + 2w + t - r - b - 1.$$

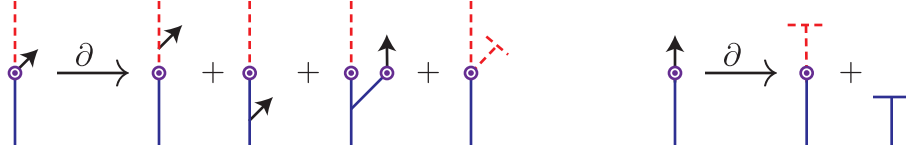

FIGURE 29. **Transformation thorn trees and their differentials.** Two examples are shown.

The homotopy unital weighted transformation trees complex  $uJ_*^{n,w}$  is the complex generated by all transformation thorn trees with  $n$  inputs and total weight  $w$ .

As in the non-unital setting, there are composition maps

$$(4.74) \quad \circ_i: uJ_*^{n_1, w_1} \otimes_R uX_*^{n_2, w_2} \rightarrow uJ_*^{n_1+n_2-1, w_1+w_2},$$

$$(4.75) \quad \circ: uX_*^{n,w} \otimes_R uJ_*^{m_1, v_1} \otimes_R \cdots \otimes_R uJ_*^{m_n, v_n} \rightarrow uJ_*^{m_1+\cdots+m_n, v_1+\cdots+v_n+w}.$$

**Lemma 4.76.** *The  $n$ -input, weight  $w$  homotopy unital weighted transformation trees complex  $uJ_*^{n,w}$  is a chain complex, and the differential decreases the grading by one. Further, the composition maps (4.74) and (4.75) are chain maps.*

*Proof.* The proof is similar to, but more complicated than, the proof of Lemma 4.17. In the dual complex to  $uJ_*^{n,w}$ , the differential  $\delta$  is the sum of all ways of:

- (1) contracting an edge between two red vertices,
- (2) contracting an edge between two blue vertices,
- (3) contracting an edge between a purple vertex and a red vertex,
- (4) contracting all the colored edges into a blue vertex  $v$  if all of the vertices above  $v$  are purple or un-colored (thorns),
- (5) inserting a new 3-valent, weight 0 vertex on an edge, with one of its inputs a new thorn,
- (6) replacing a (red or blue) stump with a thorn, or
- (7) replacing a blue stump with a thorn feeding into a 2-valent, weight 0 purple vertex.

Terms in  $\delta^2$  involving only operations (1), (2), (3), and (4) cancel as in the proof of Lemma 4.17. Terms coming from two operations of types (5), (6), or (7) cancel in pairs in an obvious way. Similarly, terms in  $\delta^2$  coming from a pair of operations in  $\{(1),(2),(3),(6),(7)\}$  cancel in pairs in an obvious way. This leaves terms coming from the following pairs:

- ((1),(5)) and ((2),(5)). These cancel in pairs as in the proof of Lemma 4.70.
- ((3),(5)). When the red vertex in the type (3) operation is the 3-valent vertex created by the type (5) operation, these cancel against terms of type ((4),(5)). The rest of these terms cancel in pairs.
- ((4),(5)). When the blue vertex in the type (4) operation is the 3-valent vertex created by the type (5) operation, these cancel against terms of type ((3),(5)). The rest of these terms cancel in pairs.
- ((4),(6)). When the stump in the type (6) operation is incident to the blue vertex in the type (4) operation, these cancel against terms of type ((4),(7)). The rest of these terms cancel in pairs.
- ((4),(7)). When the purple vertex in the type (7) operation feeds into the blue vertex in the type (4) operation, these cancel against terms of type ((4),(6)). The rest of these terms cancel in pairs.

This completes the proof that  $\delta^2 = 0$ . The facts that the differential decreases the grading by 1 and that the composition maps are chain maps are immediate from the definitions.  $\square$



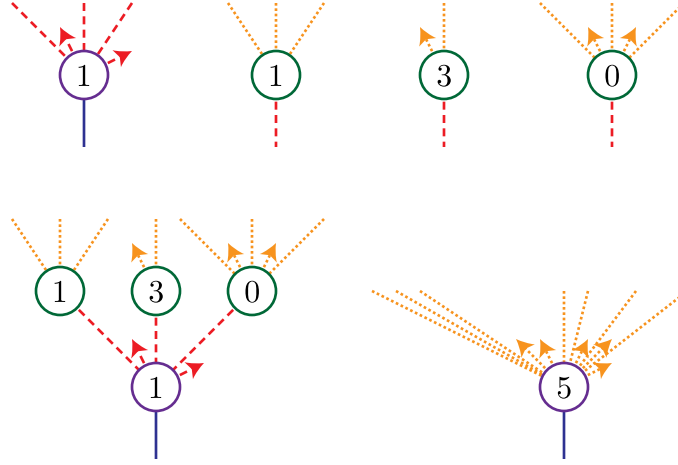

FIGURE 30. **The collapsed composition of homotopy unital purple corollas.** Top: four homotopy unital purple corollas. In order, these are  $\mathfrak{p}\Psi_{1\uparrow 2\uparrow 0}^1$ ,  $\mathfrak{p}\Psi_3^1$ ,  $\mathfrak{p}\Psi_{0\uparrow 1}^3$ , and  $\mathfrak{p}\Psi_{1\uparrow 1\uparrow 1}^0$ . Bottom: their composition (left) and collapsed composition (right), which is  $\mathfrak{p}\Psi_{3\uparrow 0\uparrow 2\uparrow 1\uparrow 1\uparrow 0}^5$ .

**Definition 4.77.** Given homotopy unital weighted algebras  $\mathcal{A}$  and  $\mathcal{B}$ , a homotopy unital homomorphism from  $\mathcal{A}$  to  $\mathcal{B}$  consists of chain maps

$$uJ_*^{n,w} \rightarrow \text{Mor}(A^{\otimes n}, B\langle(2-\kappa)w\rangle)$$

for each  $n$  and  $w$  which are compatible with composition in the obvious sense.

A homotopy unital homomorphism  $f$  is determined by maps

$$f_{n_1\uparrow \dots \uparrow n_k}^w : A^{\otimes n_1 + \dots + n_k} \rightarrow B$$

corresponding to a purple corolla  $\mathfrak{p}\Psi_{n_1\uparrow \dots \uparrow n_k}^w$  with valence  $n + t + 1$  with a mix of thorn and input leaves; see Figure 30. (We have suppressed the grading.) Again, there is a forgetful map from homotopy unital homomorphisms to homomorphisms of underlying non-unital weighted algebras. A homomorphism is a *quasi-isomorphism* if the induced map of non-unital weighted algebras is a quasi-isomorphism.

*Example 4.78.* The *identity homomorphism* of a homotopy unital algebra  $\mathcal{A}$  is the map  $\mathbb{I}_{\mathcal{A}}$  with  $(\mathbb{I}_{\mathcal{A}})_1^0 = \mathbb{I}_A$  and  $(\mathbb{I}_{\mathcal{A}})_{n_1\uparrow \dots \uparrow n_k}^w = 0$  otherwise (i.e., if  $w > 0$  or  $k > 1$  or  $n_1 > 1$ ). It is immediate from the definitions that this defines a homotopy unital homomorphism.

Given non-negative integers  $n_1, \dots, n_k$ ,  $m_{i,1}, \dots, m_{i,\ell_i}$  (for  $i = 1, \dots, n := n_1 + \dots + n_k$ ),  $w$ , and  $v_1, \dots, v_n$ , there is a *collapsed composition* of  $\mathfrak{p}\Psi_{n_1\uparrow \dots \uparrow n_k}^w$  with  $(\mathfrak{p}\Psi_{m_{1,1}\uparrow \dots \uparrow m_{i,\ell_i}}^{v_1}, \dots, \mathfrak{p}\Psi_{m_{n,1}\uparrow \dots \uparrow m_{n,\ell_n}}^{v_n})$  by composing  $\mathfrak{p}\Psi_{n_1\uparrow \dots \uparrow n_k}^w$  with  $(\mathfrak{p}\Psi_{m_{1,1}\uparrow \dots \uparrow m_{i,\ell_i}}^{v_1}, \dots, \mathfrak{p}\Psi_{m_{n,1}\uparrow \dots \uparrow m_{n,\ell_n}}^{v_n})$  and then collapsing all of the internal edges to obtain a new corolla. In formulas, the collapsed composition is

$$\mathfrak{p}\Psi_{m_{1,1}\uparrow m_{1,2}\uparrow \dots \uparrow m_{1,\ell_1} + m_{2,1}\uparrow m_{2,2}\uparrow \dots \uparrow m_{2,\ell_2} + m_{3,1}\uparrow \dots \uparrow m_{n_1,\ell_{n_1}} \uparrow m_{n_1+1,1}\uparrow m_{n_1+1,2}\uparrow \dots}^{v_1 + \dots + v_n + w}$$

See Figure 30.

**Definition 4.79.** Given homotopy unital homomorphisms  $f$  and  $g$ , their composition is defined by

$$(g \circ f)_{p_1\uparrow \dots \uparrow p_\ell}^w = \sum g_{n_1\uparrow \dots \uparrow n_k}^v \circ (f_{m_{1,1}\uparrow \dots \uparrow m_{1,j_1}}^{u_1} \otimes \dots \otimes f_{m_{n,1}\uparrow \dots \uparrow m_{n,j_n}}^{u_n}),$$

where the sum is over data  $n_1, \dots, n_k, m_{1,1}, \dots, m_{n,j_n}, v, u_1, \dots, u_n$  whose collapsed composition is  $\mathfrak{p}\Psi_{p_1\uparrow \dots \uparrow p_\ell}^w$ . (Here,  $n = n_1 + \dots + n_k$ .)

Compare Definition 3.10.

**Lemma 4.80.** *The composition of two homotopy unital algebra homomorphisms is a homotopy unital algebra homomorphism.*

*Proof.* The proof is left to the reader. □

A homotopy unital homomorphism  $f: \mathcal{A} \rightarrow \mathcal{B}$  is an *isomorphism* if there is a homotopy unital homomorphism  $g: \mathcal{B} \rightarrow \mathcal{A}$  so that  $g \circ f = \mathbb{I}_{\mathcal{A}}$  and  $f \circ g = \mathbb{I}_{\mathcal{B}}$ . We have the following analogue of Lemma 4.19:

**Lemma 4.81.** *A homotopy unital algebra homomorphism  $f: \mathcal{A} \rightarrow \mathcal{B}$  is an isomorphism if and only if  $f_1^0$  is an isomorphism.*

*Proof.* As in the proof of Lemma 4.19, we construct left and right inverses of  $f$  inductively, and then verify that they are homomorphisms afterwards. So, we first construct maps  $g_{n_1 \uparrow \dots \uparrow n_k}^w$  formally satisfying  $g \circ f = \mathbb{I}$ . Let  $g_1^0 = (f_1^0)^{-1}$ , which exists by hypothesis. Construct the rest of  $g$  by induction on the weight  $w$ , number of thorns  $(k-1)$ , and the number of non-thorn inputs  $\sum n_i$ , in that order. Inspecting the terms that contribute to  $(g \circ f)_{n_1 \uparrow \dots \uparrow n_k}^w$ , there is one maximal term, namely  $g_{n_1 \uparrow \dots \uparrow n_k}^w \circ (f_1^0 \otimes \dots \otimes f_1^0)$ , and other terms that involve previously-defined values of  $g$ . Since  $f_1^0$  is invertible, we thus determine the new term uniquely.

We can similarly construct maps  $h_{n_1 \uparrow \dots \uparrow n_k}^w$  so that  $f \circ h = \mathbb{I}$ . Then the usual argument (reducing  $g \circ f \circ h$  in two ways) shows that  $g = h$ .

To see  $g$  is a homomorphism, we modify the proof of Lemma 4.19. The relation in the case that the input is a single thorn is easily seen to be satisfied. To verify the remaining cases, we adopt the following notation. Given a map  $h: \bigoplus_n A^{\otimes n} \rightarrow B$ , let

$$\underline{h} = \sum_{m=1}^{\infty} \overbrace{(h \otimes \dots \otimes h)}^m: \bigoplus_n A^{\otimes n} \rightarrow B^{\otimes m}.$$

Let

$$\begin{array}{c} \downarrow \\ f^* \\ \downarrow \end{array}$$

denote feeding an element of the tensor algebra on  $A$  into  $f(\text{p}\Psi_{k_1 \uparrow k_2 \uparrow \dots \uparrow k_\ell}^w)$  for some  $\ell$ ,  $w$ , and sequence  $k_1, \dots, k_\ell$ . Extend the notation  $\underline{f}^*$  and  $\mu^*$  similarly, by again interspersing thorns in an arbitrary way. Then the homotopy unital homomorphism relation for  $g$  (except for the case with a single thorn as input) is

$$\begin{array}{c} \downarrow \\ \underline{g}^* \\ \downarrow \\ \mu^* \\ \downarrow \end{array} + \begin{array}{c} \downarrow \quad \downarrow \\ \mu^* \\ \downarrow \\ g^* \\ \downarrow \end{array} + \begin{array}{c} \swarrow \quad \downarrow \quad \searrow \\ g^* \\ \downarrow \end{array} = 0.$$

Since composition with  $f$  is an isomorphism (with inverse given by composition by  $g$ , though  $g$  is not known yet to be a homomorphism), it suffices to show that pre-composing the left side by  $f$

vanishes. This is

$$\begin{aligned}
 & \begin{array}{c} \Downarrow \\ \underline{f^*} \\ \Downarrow \\ \underline{g^*} \\ \Downarrow \\ \underline{\mu^*} \\ \Downarrow \end{array} + \begin{array}{c} \Downarrow \quad \Downarrow \quad \Downarrow \quad \Downarrow \\ \underline{f^*} \quad \underline{f^*} \quad \underline{f^*} \quad \underline{f^*} \\ \searrow \quad \downarrow \quad \swarrow \\ \underline{\mu^*} \\ \downarrow \\ \underline{g^*} \\ \downarrow \end{array} + \begin{array}{c} \Downarrow \quad \Downarrow \\ \underline{f^*} \quad \underline{f^*} \\ \searrow \quad \downarrow \quad \swarrow \\ \underline{g^*} \\ \downarrow \end{array} = \begin{array}{c} \Downarrow \\ \underline{\mu^*} \\ \downarrow \end{array} + \begin{array}{c} \Downarrow \quad \Downarrow \quad \Downarrow \\ \underline{f^*} \quad \underline{\mu} \quad \underline{f^*} \\ \searrow \quad \downarrow \quad \swarrow \\ \underline{f^*} \\ \downarrow \\ \underline{g^*} \\ \downarrow \end{array} + \begin{array}{c} \Downarrow \quad \Downarrow \\ \underline{f^*} \quad \underline{f^*} \\ \searrow \quad \downarrow \quad \swarrow \\ \underline{f^*} \\ \downarrow \\ \underline{g^*} \\ \downarrow \end{array} \\
 & = \begin{array}{c} \Downarrow \\ \underline{\mu^*} \\ \downarrow \end{array} + \begin{array}{c} \Downarrow \\ \underline{\mu^*} \\ \downarrow \end{array} + \begin{array}{c} \searrow \quad \downarrow \quad \swarrow \\ \underline{\mathbb{I}} \\ \downarrow \end{array} = 0.
 \end{aligned}$$

Here, the last term vanishes because  $\mathbb{I}$  vanishes if there is more than one input, and we checked the homotopy unital  $A_\infty$  relation in the case that the input is a single thorn separately. This completes the proof.  $\square$

**Definition 4.82.** A module transformation thorn tree is the same as a module thorn tree except that there is a distinguished (purple) internal vertex which is allowed to have one input and weight 0.

If  $S$  is a module thorn tree and  $T$  is a module transformation thorn tree then  $T \circ_1 S$  and  $S \circ_1 T$  are defined in the obvious way. Similarly, if  $S$  is an (algebra) thorn tree then  $T \circ_i S$ ,  $i > 1$ , is defined in the obvious way.

The differential of a module transformation thorn tree is defined in the same way as for a module thorn tree, with the understanding that the purple vertex is allowed to split into a 2-valent, weight 0 purple vertex and another (allowed) vertex. Also, for a 3-valent, weight 0 purple vertex with one input a thorn, there is not a term in the differential corresponding to erasing that thorn.

Let  $uJM_*^{n,w}$  be the complex of module transformation thorn trees with  $n$  inputs and total weight  $w$ . We call  $uJM_*^{n,w}$  the homotopy unital weighted module transformation trees complex.

As in the non-unital case, there are obvious composition maps

$$(4.83) \quad \circ_1: uJM_*^{n,w} \otimes_R uXM_*^{m,v} \rightarrow uJM_*^{m+n-1,v+w}$$

$$(4.84) \quad \circ_1: uXM_*^{n,w} \otimes_R uJM_*^{m,v} \rightarrow uJM_*^{m+n-1,v+w}$$

$$(4.85) \quad \circ_i: uJM_*^{n,w} \otimes_R uX_*^{m,v} \rightarrow uJM_*^{m+n-1,v+w} \quad 1 < i \leq n.$$

**Lemma 4.86.** The  $n$ -input, weight  $w$  homotopy unital weighted module transformation trees complex  $uJM_*^{n,w}$  is a chain complex, and the differential decreases the grading by one. Further, the composition maps (4.83), (4.84), and (4.85) are chain maps.

*Proof.* The proof is essentially the same as the proof of Lemma 4.70, and is left to the reader.  $\square$

**Definition 4.87.** Given homotopy unital modules  $\mathcal{M}$  and  $\mathcal{N}$ , a homotopy unital weighted module map from  $\mathcal{M}$  to  $\mathcal{N}$  consists of maps

$$uJM_*^{n,w} \rightarrow \text{Mor}(M \otimes A^{\otimes n-1}, N \langle\langle (2-\kappa)w \rangle\rangle)$$

which are compatible with composition in the obvious sense.

A homotopy unital module map  $f$  is determined by maps

$$f_{1+n_1 \uparrow \dots \uparrow n_k}^w: M \otimes A^{\otimes n} \rightarrow N$$

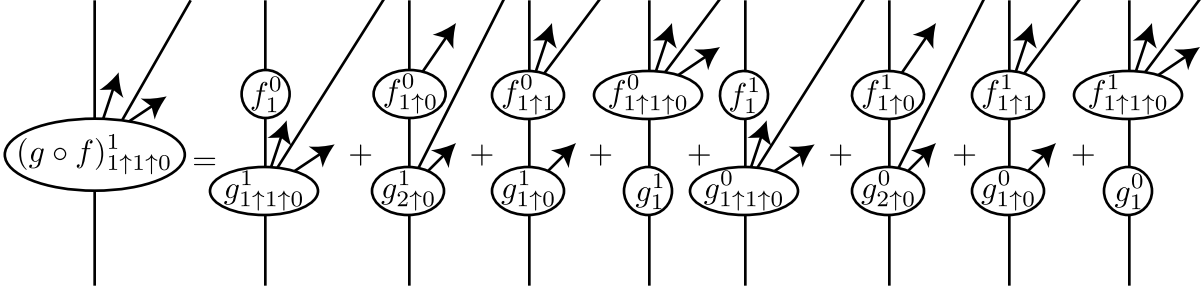

FIGURE 31. **Composing homotopy unital weighted module morphisms.** The arrows are the thorns.

corresponding to a purple corolla with weight  $w$  and valence  $n_1 + \dots + n_k + k - 1$  with a mix of thorn and input leaves, where the thorns are at the positions  $n_1 + 2, n_1 + n_2 + 3, \dots$ . (The grading has been suppressed here.)

**Definition 4.88.** Given two homotopy unital weighted module maps  $f: \mathcal{M}_1 \rightarrow \mathcal{M}_2$  and  $g: \mathcal{M}_2 \rightarrow \mathcal{M}_3$ , the composition  $g \circ f$  is defined by setting  $(g \circ f)(S)$  to be the sum of all ways of splitting the purple vertex in  $S$  into two adjacent purple vertices and applying  $f$  at the first of these purple vertices and  $g$  at the second. Equivalently,

$$\begin{aligned} & (g \circ f)_{1+n_1 \uparrow n_2 \uparrow \dots \uparrow n_k}(x, a_1, \dots, a_n) \\ &= \sum_{\ell=1}^k \sum_{n'_\ell=0}^{n_\ell} g_{1+n_\ell-n'_\ell \uparrow n_{\ell+1} \uparrow \dots \uparrow n_k}(f_{1+n_1 \uparrow \dots \uparrow n_{\ell-1} \uparrow n'_\ell}(x, a_1, \dots, a_{n_1+\dots+n_{\ell-1}+n'_\ell}), a_{n_1+\dots+n'_\ell+1}, \dots, a_n). \end{aligned}$$

*Example 4.89.* The identity map of  $\mathcal{M}$  is the map  $\mathbb{I}_{\mathcal{M}}$  with

$$(\mathbb{I}_{\mathcal{M}})_{1+n_1 \uparrow \dots \uparrow n_k}^w = \begin{cases} \mathbb{I}_M & k=1, w=0, \text{ and } n_1=0 \\ 0 & \text{otherwise.} \end{cases}$$

**Lemma 4.90.** The homotopy unital module maps from  $\mathcal{M}$  to  $\mathcal{N}$  form a subcomplex of the morphism complex

$$\prod_{n,w} \text{Mor}(uJM_*^{n,w} \otimes_R M \otimes A^{\otimes n-1}, N\langle\langle(2-\kappa)w\rangle\rangle).$$

Further, the identity map is a cycle,  $f \circ \mathbb{I}_{\mathcal{M}} = \mathbb{I}_{\mathcal{N}} \circ f = f$ , and composition is a chain map. Thus, homotopy unital modules and homotopy unital module maps forms a (strictly unital) dg category.

*Proof.* For the first statement, we need to check that if  $\phi$  respects composition then  $d(\phi)$  also respects composition. We spell out the case that  $T = T_1 \circ_i T_2$ , with the purple vertex on  $T_1$  and  $i > 1$ ; the other cases are similar. Let  $k$  be the number of inputs of  $T_2$ . Then

$$\begin{aligned} & (d\phi)(T_1 \circ_i T_2)(m, a_1, \dots, a_n) \\ &= \phi((\partial T_1) \circ_i T_2)(m, a_1, \dots, a_n) + \phi(T_1 \circ_i (\partial T_2))(m, a_1, \dots, a_n) + \partial(\phi(T_1 \circ_i T_2)(m, a_1, \dots, a_n)) \\ & \quad + \phi(T_1 \circ_i T_2)(\partial m, a_1, \dots, a_n) + \sum_{j=1}^n \phi(T_1 \circ_i T_2)(m, a_1, \dots, \partial a_j, \dots, a_n) \\ &= (\phi(\partial T_1) \circ_i \mu(T_2))(m, a_1, \dots, a_n) + (\phi(T_1) \circ_i \mu(\partial T_2))(m, a_1, \dots, a_n) \\ & \quad + \partial(\phi(T_1)(m, a_1, \dots, a_{i-1}, \mu(T_2)(a_i, \dots, a_{i+k-1}), a_{i+k}, \dots, a_n)) \\ & \quad + \phi(T_1)(\partial m, a_1, \dots, a_{i-1}, \mu(T_2)(a_i, \dots, a_{i+k-1}), a_{i+k}, \dots, a_n) \end{aligned}$$

$$\begin{aligned}
& + \sum_{j=1}^{i-1} \phi(T_1)(m, a_1, \dots, \partial(a_j), \dots, a_{i-1}, \mu(T_2)(a_i, \dots, a_{i+k-1}), a_{i+k}, \dots, a_n) \\
& + \sum_{j=i}^{i+k-1} \phi(T_1)(m, a_1, \dots, a_{i-1}, \mu(T_2)(a_i, \dots, \partial(a_j), \dots, a_{i+k-1}), a_{i+k}, \dots, a_n) \\
& + \sum_{j=i+k}^n \phi(T_1)(m, a_1, \dots, a_{i-1}, \mu(T_2)(a_i, \dots, a_{i+k-1}), a_{i+k}, \dots, \partial(a_j), \dots, a_n) \\
= & (\phi(\partial T_1) \circ_i \mu(T_2))(m, a_1, \dots, a_n) + \partial(\phi(T_1)(m, a_1, \dots, a_{i-1}, \mu(T_2)(a_i, \dots, a_{i+k-1}), a_{i+k}, \dots, a_n)) \\
& + \phi(T_1)(\partial m, a_1, \dots, a_{i-1}, \mu(T_2)(a_i, \dots, a_{i+k-1}), a_{i+k}, \dots, a_n) \\
& + \sum_{j=1}^{i-1} \phi(T_1)(m, a_1, \dots, \partial(a_j), \dots, a_{i-1}, \mu(T_2)(a_i, \dots, a_{i+k-1}), a_{i+k}, \dots, a_n) \\
& + \phi(T_1)(m, a_1, \dots, a_{i-1}, \partial(\mu(T_2)(a_i, \dots, a_{i+k-1})), a_{i+k}, \dots, a_n) \\
& + \sum_{j=i+k}^n \phi(T_1)(m, a_1, \dots, a_{i-1}, \mu(T_2)(a_i, \dots, a_{i+k-1}), a_{i+k}, \dots, \partial(a_j), \dots, a_n) \\
= & (d\phi)(T_1)(m, a_1, \dots, a_{i-1}, \mu(T_2)(a_i, \dots, a_{i+k-1}), a_{i+k}, \dots, a_n),
\end{aligned}$$

as desired.

Turning to the remaining statements, it is clear that  $\mathbb{L}_{\mathcal{M}}$  is a cycle and that  $f \circ \mathbb{L}_{\mathcal{M}} = \mathbb{L}_{\mathcal{N}} \circ f = f$ . To verify that composition is a chain map, it suffices to check that  $d(g \circ f)$  and  $(dg \circ f) + (g \circ df)$  take the same value on each corolla (with thorns). This is straightforward from the definitions, and is left to the reader.  $\square$

**Definition 4.91.** *A homotopy unital weighted algebra  $\mathcal{A}$  is bonsai if there is an integer  $N$  so that  $\mu(T) = 0$  whenever  $T$  is a thorn tree with  $\dim(T) > N$ . Bonsai weighted algebra homomorphisms, weighted modules, and weighted module morphisms are defined similarly.*

Finally, we have a rectification result:

**Theorem 4.92.** *Given a split homotopy unital weighted algebra  $\mathcal{A}$  there is a strictly unital weighted algebra  $\mathcal{B}$  and a homotopy unital isomorphism  $f: \mathcal{A} \rightarrow \mathcal{B}$ . Further, if  $\mathcal{A}$  is bonsai then  $\mathcal{B}$  and  $f$  can be chosen to be bonsai as well.*

The proof uses a version of Lemma 4.26:

**Lemma 4.93.** *Suppose that  $\mathcal{A}$  is a homotopy unital  $w$ -algebra. Fix integers  $v, j, m_1, \dots, m_j \geq 0$ , with  $m_1 + \dots + m_j + j - 1 + 2v > 1$ . Let  $m = m_1 + \dots + m_j$ , and let  $\phi_{m_1 \uparrow \dots \uparrow m_j}^v: A^{\otimes m} \rightarrow A$  be any map of degree  $(2 - \kappa)v + m + j - 2$ . There is a homotopy unital  $w$ -algebra  $\mathcal{A}' = (A, \bar{\mu}_{n_1 \uparrow \dots \uparrow n_k}^w)$  isomorphic to  $\mathcal{A}$ , so that  $\bar{\mu}_{n_1 \uparrow \dots \uparrow n_k}^w = \mu_{n_1 \uparrow \dots \uparrow n_k}^w$  if*

- $w < v$ , or
- $w = v$  and  $n + k < m + j$ .

Further, the only cases with  $w = v$  and  $n + k = m + j$  for which  $\bar{\mu}_{n_1 \uparrow \dots \uparrow n_k}^w \neq \mu_{n_1 \uparrow \dots \uparrow n_k}^w$  are

$$\begin{aligned}
\bar{\mu}_{m_1 \uparrow \dots \uparrow m_j}^v & = \mu_{m_1 \uparrow \dots \uparrow m_j}^v + d\phi_{m_1 \uparrow \dots \uparrow m_j}^v \\
\bar{\mu}_{m_1 \uparrow \dots \uparrow m_{i-1} \uparrow m'_i \uparrow m''_i \uparrow m_{i+1} \uparrow \dots \uparrow m_j}^v(a_1, \dots, a_{m-1}) & = \mu_{m_1 \uparrow \dots \uparrow m_{i-1} \uparrow m'_i \uparrow m''_i \uparrow m_{i+1} \uparrow \dots \uparrow m_j}^v(a_1, \dots, a_{m-1}) \\
& + \phi_{m_1 \uparrow \dots \uparrow m_j}^v(a_1, \dots, a_{m_1 + \dots + m_{i-1} + m'_i}, \mathbf{1}, a_{m_1 + \dots + m_{i-1} + m'_i + 1}, \dots, a_{m-1}),
\end{aligned}$$

where  $m'_i + m''_i = m_i - 1$ .

*Proof sketch.* As in Lemma 3.81, we construct the modified algebra  $\mathcal{A}'$ , with operations coming from trees as follows:

- There is one distinguished vertex labelled by either a stump or some  $\mu_{n_1 \uparrow \dots \uparrow n_k}^w$ .
- All other vertices have  $m$  inputs and weight  $v$  and are labelled by  $\phi$ .
- The distinguished vertex is either the trunk vertex or a parent of the trunk vertex. If the distinguished vertex is a stump, it must be a parent of the trunk vertex.

The tree contributes to the operation on  $\mathcal{A}'$  with the given inputs, with arrows interpolated at the positions of the thorns. Additionally, if the distinguished vertex is a stump, it contributes an extra arrow at its position.

The proof of Lemma 3.81 applies almost without change to show that these operations form a homotopy unital  $w$ -algebra, except that some decompositions are disallowed because the stump cannot be the root of the modified action trees. These disallowed terms correspond instead to terms in the homotopy unital  $w$ -algebra relations that turn a thorn into a stump.

We can similarly see that  $\mathcal{A}'$  is isomorphic to  $\mathcal{A}$  by constructing a map that is a perturbation of the identity by  $\phi$ .

The terms in the last part of the lemma statement come from trees with one undistinguished vertex and either a distinguished 2-valent vertex or a distinguished stump.  $\square$

*Remark 4.94.* One can also prove Lemma 4.93 by following the strategy of Remark 3.82.

*Proof of Theorem 4.92.* We prove the unweighted case; the weighted case is obtained by wrapping the argument below in an induction on the weight  $w$ .

We will modify the algebra so that  $\mu_{n_1 \uparrow \dots \uparrow n_k} = 0$  for  $k > 1$ . The construction is inductive on:

- (1)  $n_1 + \dots + n_k + k$  (outer induction),
- (2)  $n_1$  (middle induction), and
- (3)  $k$  (inner induction).

We will use the following lemma, which gives a precise relationship between vanishing of operations with thorns and strict unitality.

**Lemma 4.95.** *Suppose, in a homotopy unital algebra, that  $\mu_{n_1 \uparrow \dots \uparrow n_k} = 0$  whenever  $n_1 + \dots + n_k + k \leq T$  and  $n_1 < N$ . Then, if  $m = \sum m_i > 2$ ,  $m + \ell \leq T$ , and  $i < N$ , we have*

$$\mu_{m_1 \uparrow \dots \uparrow m_\ell}(a_1, \dots, a_{i-1}, \mathbf{1}, a_{i+1}, \dots, a_m) = 0.$$

*Proof.* If  $m_1 < N$  then  $\mu_{m_1 \uparrow \dots \uparrow m_\ell}$  vanishes by assumption. Otherwise, consider the  $A_\infty$  relation corresponding to  $\Psi_{i-1 \uparrow m_1 - i \uparrow m_2 \uparrow \dots \uparrow m_\ell}$  with inputs  $(a_1, \dots, a_{i-1}, a_{i+1}, \dots, a_m)$ . One term is

$$\mu_{m_1 \uparrow \dots \uparrow m_\ell}(a_1, \dots, a_{i-1}, \mathbf{1}, a_{i+1}, \dots, a_m)$$

and the other terms vanish by hypothesis.  $\square$

Now, fix an  $R$ -module splitting  $A = \mathbb{F}_2\langle \mathbf{1} \rangle \oplus A_0$ . Assume that  $\mu_{m_1 \uparrow \dots \uparrow m_\ell} = 0$  if  $\ell > 1$  and either

- $m_1 + \dots + m_\ell + \ell < T$ ; or
- $m_1 + \dots + m_\ell + \ell = T$  and  $m_1 < N$ ; or
- $m_1 + \dots + m_\ell + \ell = T$  and  $m_1 = N$  and  $\ell < K$ .

Suppose that the first non-vanishing homotopy-unital operation is  $\mu_{N \uparrow n_2 \uparrow \dots \uparrow n_t} \neq 0$ . Define

$$\phi_{N+1+n_2 \uparrow n_3 \uparrow \dots \uparrow n_t}(a_1, \dots, a_{n+1}) = \begin{cases} \mu_{N \uparrow \dots \uparrow n_t}(a_1, \dots, a_N, a_{N+2}, \dots, a_{n+1}) & a_{N+1} = \mathbf{1} \\ 0 & a_{N+1} \in A_0. \end{cases}$$

Let  $\bar{\mu}$  be the operations on the induced homotopy unital  $A_\infty$ -algebra from Lemma 4.93. By that lemma,  $\bar{\mu}_{m_1 \uparrow \dots \uparrow m_j} = \mu_{m_1 \uparrow \dots \uparrow m_j}$  if  $m_1 + \dots + m_j + j < N + n_2 + \dots + n_t + t$ , and

$$\bar{\mu}_{N \uparrow \dots \uparrow n_t}(a_1, \dots, a_n) = \mu_{N \uparrow \dots \uparrow n_t}(a_1, \dots, a_n) + \phi_{N+1+n_2 \uparrow \dots \uparrow n_t}(a_1, \dots, a_N, \mathbf{1}, a_{N+1}, \dots, a_n) = 0.$$

Although not needed for the induction, note that the operation  $\mu_{N+1+n_2 \uparrow n_3 \uparrow \dots \uparrow n_t}$  with  $(N+1)^{\text{st}}$  input the unit changes to

$$\begin{aligned} \bar{\mu}_{N+1+n_2 \uparrow n_3 \uparrow \dots \uparrow n_t}(a_1, \dots, a_N, \mathbf{1}, a_{N+2}, \dots, a_{n+1}) &= \mu_{N+1+n_2 \uparrow n_3 \uparrow \dots \uparrow n_t}(a_1, \dots, a_N, \mathbf{1}, a_{N+2}, \dots, a_{n+1}) \\ &\quad + (d\mu_{N \uparrow n_2 \uparrow \dots \uparrow n_t})(a_1, \dots, a_N, a_{N+2}, \dots, a_{n+1}). \end{aligned}$$

Applying the  $A_\infty$  relation to the  $d\mu$  term on the right side, the inductive hypothesis implies that almost all terms vanish, except for one term that cancels the first term on the right side. So, if  $t = 2$ , the operation  $\mu_{n+1}$  has just become strictly unital in the  $(N + 1)^{\text{st}}$  place.

According to Lemma 4.93, the remaining cases with  $m_1 + \dots + m_\ell + \ell = T$  for which we may have  $\bar{\mu} \neq \mu$  are operations obtained from  $N + 1 + n_2 \uparrow n_3 \uparrow \dots \uparrow n_t$  by replacing  $N$  or some  $n_i$  by  $n' \uparrow n''$ . The cases corresponding to some  $n_i$  with  $i > 1$  are later in the induction, hence irrelevant. For the case of replacing  $N$ , by Lemma 4.95, this operation is, in fact, unchanged.

Thus, we have eliminated the operation  $\mu_{N \uparrow n_2 \uparrow \dots \uparrow n_t}$  without changing any operation earlier or in the same step in the induction. Repeat this for each operation at this stage of the induction and continue with the induction.

The bonsai statement follows from the fact that the new multiplications and maps are defined via trees of the old multiplications and maps (possibly with 2-valent, weight 0 vertices) with the same dimension.  $\square$

## 5. THE WEIGHTED TREES COMPLEXES ARE CONTRACTIBLE

In this section, we compute the homology of the various complexes of weighted trees introduced in Section 4.

**5.1. Signs on the weighted trees complex.** In Section 8 we construct a CW complex whose cellular chain complex agrees with the weighted trees complex. Even though the rest of this paper is in characteristic 2, it seems natural to prove this identification of chain complexes over the integers. So, in this section we define a signed refinement of the weighted trees complex; we prove this signed version is contractible in Section 5.2. Of course, this also implies contractibility in characteristic 2. In Section 5.3 we revert to working in characteristic 2. Our construction of signs is a trivial adaptation of Markl-Schneider [MS06, Section 3].

Fix a commutative ring  $R$ .

An *orientation* for a weighted tree  $T$  is an equivalence class of total orderings of the internal edges of  $T$  (i.e., the edges not adjacent to the inputs or output), where total orderings  $\omega$  and  $\omega'$  are equivalent if they differ by an even permutation. We use Markl-Schneider's suggestive notation  $e_{i_1} \wedge \dots \wedge e_{i_k}$  for the ordering  $e_{i_1} < \dots < e_{i_k}$ . Let  $X_*^{n,w}$  be the free  $R$ -module generated by pairs  $(T, \omega)$  of stably-weighted trees and orientations for them, modulo the relation  $(T, \omega) \sim -(T, \omega')$  if  $\omega$  and  $\omega'$  differ by an odd permutation. The boundary map is defined by

$$(5.1) \quad \partial(T, \omega) = \sum (T', e \wedge \omega)$$

where  $T$  is obtained from  $T'$  by collapsing the edge  $e$  (cf. [MS06, Equation (3.2)]). It is immediate from the definition and the relation  $e \wedge f \wedge \omega = -f \wedge e \wedge \omega$  that  $\partial^2 = 0$ . If  $R$  has characteristic 2, this complex is exactly the weighted trees complex from Section 4.1.

Composition with signs can also be defined following Markl-Schneider [MS06, Equation (3.1)]: for  $(S, \eta) \in X_*^{m,v}$  and  $(T, \omega) \in X_*^{n,w}$  let

$$(T, \omega) \circ_i (S, \eta) = (-1)^{n \dim(S) + mi} (T \circ_i S, \omega \wedge \eta \wedge e)$$

where  $e$  is the new internal edge of  $T \circ_i S$ . It is straightforward to verify that composition is a chain map and satisfies the usual operad associativity law.

## 5.2. Contractibility of the weighted trees complex.

**Theorem 5.2.** *The homology of the  $n$ -input, weight  $w$  weighted trees complex  $X_*^{n,w}$  is isomorphic to  $R$ , supported in dimension zero. A generator for the homology is represented by the right-associated*

planar weighted tree, such that all of its inputs are to the left of all its popsicles, all of its valence  $> 1$  vertices have weight 0, and all of its popsicles have weight 1.

Define a map  $K: X_*^{n,w} \rightarrow X_*^{n,w}$  as follows. Call a vertex  $v$  of a weighted tree  $T$  *potentially movable* if

- its weight  $w(v) > 1$  or
- its weight  $w(v) = 1$  and its valence  $d(v) > 2$  or
- its weight  $w(v) = 1$ , its valence  $d(v) = 2$ , and the parent of  $v$  is not an input.

Find the first potentially movable vertex  $v$  in  $T$  using a depth-first search. If  $w(v) = 1$ ,  $d(v) = 2$ , and the parent of  $v$  is not an input, let  $e$  be the edge pointing into  $v$ , let  $T' = T/e$  be the result of collapsing  $e$ , and define  $K(T, e \wedge \omega) = -(T', \omega)$ . Otherwise (if  $w(v) > 1$  or  $d(v) > 2$ ), let  $K(T) = 0$ .

Let  $Y$  be the subcomplex of  $X_*^{n,w}$  with the property that all vertices with positive weight have  $w(v) = 1$  and either  $d(v) = 1$  or  $d(v) = 2$  and the parent of  $v$  is an input.

**Lemma 5.3.** *For any tree  $T$  and any sufficiently large  $m$ ,*

$$(\mathbb{I} + \partial \circ K + K \circ \partial)^m(T) \in Y.$$

Further, if  $T$  is in  $Y$  then

$$(\mathbb{I} + \partial \circ K + K \circ \partial)(T) = T.$$

*Proof.* Recall depth first search, as defined in Equation (2.43); and note that  $\text{dfsind}$  satisfies the following monotonicity property under edge insertions. Suppose  $S$  is obtained from  $T$  by inserting an edge at  $v$ , and let  $u$  be any vertex in  $T$  other than  $v$ . Then the vertex  $u'$  in  $S$  corresponding to  $u$  has  $\text{dfsind}(u') \geq \text{dfsind}(u)$ .

Let  $\text{dpm}(T)$  denote the depth  $\text{dfsind}(v)$  of first potentially movable vertex  $v$  in  $T$  with respect to the depth-first search ordering. We set  $\text{dpm}(T) = \infty$  if there are no such vertices, i.e., if the tree is a generator of  $Y$ . We also abuse notation and write  $\text{dpm}(T, \omega) = \text{dpm}(T)$ . By the monotonicity property of  $\text{dfsind}$ , it follows that  $\text{dpm}$  induces a filtration on the chain complex. Moreover, it is clear from the construction of  $K$  that if  $K(T, \omega) \neq 0$ , then  $\text{dpm}(K(T, \omega)) = \text{dpm}(T)$ .

It follows that for any tree  $S$  that appears with non-zero multiplicity in  $(\mathbb{I} + \partial \circ K + K \circ \partial)(T, \omega)$ ,  $\text{dpm}(T) \leq \text{dpm}(S)$ . We claim in fact that  $\text{dpm}(T) < \text{dpm}(S)$ , unless  $\text{dpm}(T) = \infty$ . This follows from a case analysis:

- (1) Suppose that the first potentially movable vertex  $v$  in  $T$  has  $w(v) > 1$  or that  $w(v) = 1$  and  $d(v) > 2$ ; so that (in either case)  $K(T, \omega) = 0$ . The differential  $\partial(T, \omega)$  is a sum over trees  $S$  obtained by inserting edges at the various vertices of  $T$ . If  $K(S, \omega') \neq 0$ , then  $S$  must be obtained by inserting an edge  $e$  in  $T$  at  $v$ , and  $\omega' = e \wedge \omega$ . There are the following two subcases:
  - (a) The vertex  $v$  is replaced by two vertices  $v_1$  and  $v_2$ , so that  $d(v_1) = 2$ ,  $w(v_1) = 1$ , and  $w(v_2) = w(v) - 1$ ; and  $v_2$  is the parent of  $v_1$  (so that  $v_1$  is the first potentially movable vertex in  $S$ ). In this case,  $K(S, e \wedge \omega) = -(T, \omega)$  (which cancels with  $\mathbb{I}(T, \omega) = (T, \omega)$ ).
  - (b) The vertex  $v$  is replaced by two vertices  $v_1$  and  $v_2$  so that  $w(v_1) = 0$  and  $w(v_2) = w(v)$ , and  $v_2$  is a parent of  $v_1$ . Clearly,  $v_1$  is not potentially movable, so it follows that  $\text{dpm}(S) > \text{dpm}(T)$ .
- (2) Suppose that the first potentially movable vertex  $v$  in  $T$  has  $w(v) = 1$  and  $d(v) = 2$ , so that the parent is not one of the inputs, and  $K(T, \omega) \neq 0$ . In this case,  $K(T, \omega)$  is obtained by contracting the parent edge  $e$  of  $v$ , to form a new vertex  $v'$ . Consider the terms in  $\partial(K(T, \omega))$ , which come in the following types:
  - (a) Trees obtained by inserting an edge at  $v'$ , connecting vertices  $v_1$  and  $v_2$  (so that  $v_2$  is the parent of  $v_1$ ). Such trees  $S$  can be of three basic types:
    - (i) Trees with  $w(v_1) > 1$  or  $w(v_1) = 1$  and  $d(v_1) > 2$ ; in such cases, there are corresponding canceling trees contained in  $K(\partial(T, \omega))$ , obtained by inserting edges  $e'$



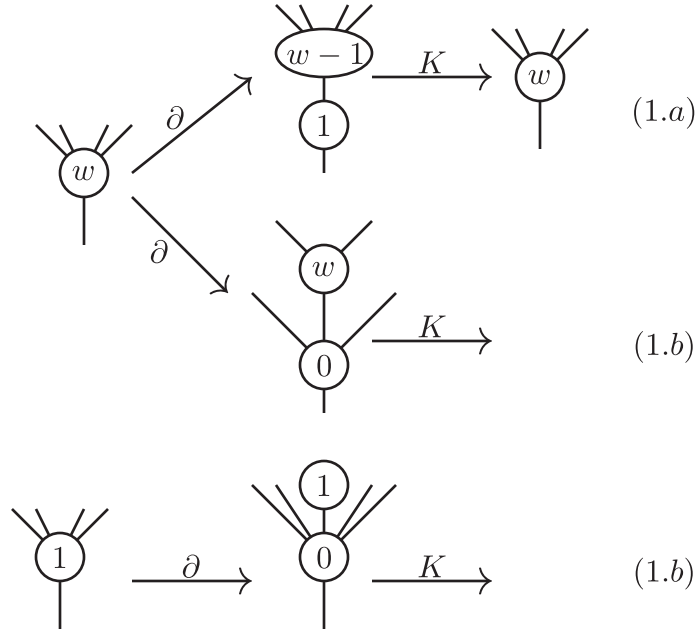

FIGURE 32. Case (1) of the proof of Lemma 5.3.

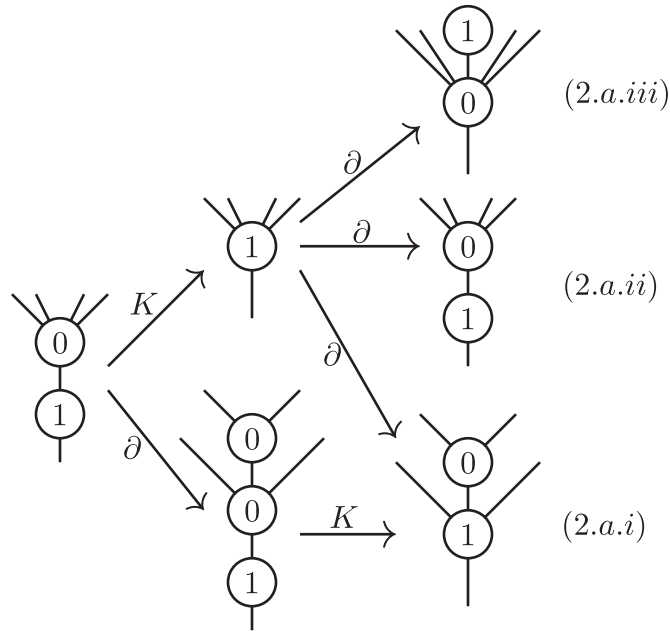

FIGURE 33. Case (2) of the proof of Lemma 5.3.

in the parent of  $v$ . Given an orientation  $e \wedge \omega$  of  $T$ , this term in  $\partial K(T, e \wedge \omega)$  has orientation  $-e' \wedge \omega$ , while the corresponding term in  $K(\partial(T, e \wedge \omega))$  is  $K(T', e' \wedge e \wedge \omega) = (T'', e' \wedge \omega)$ , so the terms indeed appear with opposite signs.

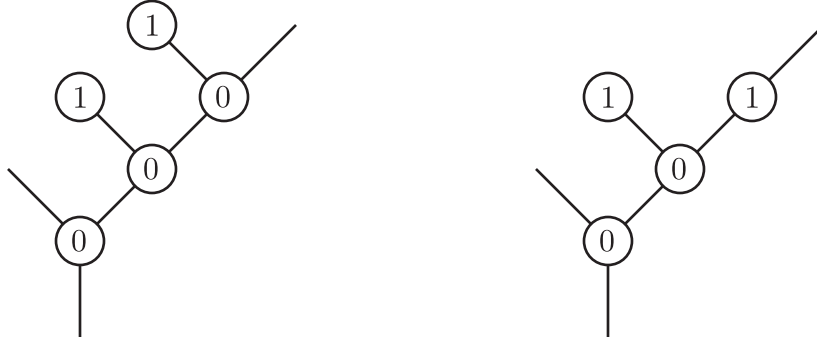

FIGURE 34. **Leaf sequences.** Left: the sequence  $(i, p, p, i)$ . Right: the sequence  $(i, p, s)$ .

- (ii) Trees with  $w(v_1) = 1$  and  $d(v_1) = 2$ , in which case  $S = T$ . Keeping track of signs, given an orientation  $e \wedge \omega$  for  $T$ , this term in  $\partial(K(T, e \wedge \omega)) = -\partial(T', \omega)$  is  $-(T, e \wedge \omega)$ , so this cancels with  $\mathbb{I}(T, e \wedge \omega)$ .
- (iii) Trees with  $w(v_1) = 0$ . Since  $v_1$  is not potentially movable, it follows that  $\text{dpm}(S) > \text{dpm}(T)$ .
- (b) Trees obtained by inserting an edge at some vertex in  $K(T)$  other than  $v'$ . These trees cancel with trees appearing in  $K(\partial T)$ . (As in case (2(a)i), skew-commutativity of the orientation implies that the signs work out in this cancellation.)

There are potentially two remaining trees in  $K(\partial T)$  not canceling with trees in  $\partial K(T)$ : the trees corresponding to inserting an edge at  $v$ . Both of those trees  $S$  have  $\text{dpm}(S) > \text{dpm}(T)$ , for the following reason. The vertex  $v$  is the first potentially movable vertex in  $T$ . Inserting an edge at  $T$  gives a new tree  $T'$  (with  $K(T') = S$ ), whose first potentially movable vertex  $u'$  corresponds to the second potentially movable vertex of  $T$ . (If there is no such second potentially movable vertex, then  $K(T') = 0$ .) Thus,

$$\text{dpm}(T) < \text{dfsind}(u) \leq \text{dfsind}(u') = \text{dpm}(T') = \text{dpm}(K(T')),$$

as claimed.

Since there are finitely many trees of weight  $w$  and  $n$  inputs,  $\text{dpm}$  takes values in a finite set. Thus, for  $m$  sufficiently large,  $(\mathbb{I} + \partial \circ K + K \circ \partial)^m(T) = \infty$ , i.e.,  $(\mathbb{I} + \partial \circ K + K \circ \partial)^m(T) \in Y$ .

The last part of the statement follows from the fact that  $K$  vanishes on the subcomplex  $Y$ .  $\square$

Since there are finitely many trees in  $X_*^{n,w}$ , we may choose a single  $m$  so that for any  $T$ ,  $(\mathbb{I} + \partial \circ K + K \circ \partial)^m(T) \in Y$ . Then,  $(\mathbb{I} + \partial \circ K + K \circ \partial)^m$  is a homotopy equivalence from  $X_*^{n,w}$  to  $Y$ .

*Proof of Theorem 5.2.* There is a filtration of  $Y$  by

$$\mathcal{F}(T) = \#\{v \in \text{Vert}(T) \mid v = \Psi_0^1\},$$

i.e., by the number of (weight 1) popsicles in  $T$ . Consider the spectral sequence associated to the filtration  $\mathcal{F}$ . The  $E^0$ -page is identified with many copies of the associahedron. More precisely, consider the set of sequences of symbols  $i, p, s$  (for “input”, “popsicle”, and “stick”), so that the number of occurrences of  $p$  plus the number of occurrences of  $s$  is  $w$  and the number of occurrences of  $i$  plus the number of occurrences of  $s$  is  $n$ . Call such a sequence a *leaf sequence*. The  $E^0$ -page consists of a copy of the unweighted trees complex  $\mathcal{T}_{\#i+\#p+\#s}$  for each leaf sequence (with  $\#i$   $i$ 's, etc.). (See Figure 34.)

Thus, the  $E^1$ -page has a single copy of  $R$  for each leaf sequence. Of course, the isomorphism with  $R$  depends on a choice of orientation. Given a leaf sequence  $L$  and an orientation  $\omega$  for  $L$ , the  $d^1$

differential of a leaf sequence is the sum of all ways of replacing a copy of  $s$  with  $(p, i) + (i, p)$  and replacing  $\omega$  with  $e \wedge \omega$ , where  $e$  is the new edge.

Define a map  $H: E^1 \rightarrow E^1$ , the *popsicle-stick homotopy*, as follows. Given a leaf sequence  $L$ , consider the left-most instance of  $p$  or  $s$  in the sequence. If it is  $s$  then  $H(L, \omega) = 0$ . If  $p$  is the first term in the sequence then let  $L'$  be the rest of the sequence and define  $H(L, \omega) = ((p, H(L')), \omega)$ . Finally, if the first  $p$  or  $s$  is  $p$  and the previous term is  $i$ , and  $e$  is the edge into this popsicle  $p$ , let  $L'$  be the result of replacing this pair  $(p, i)$  by  $s$  and define  $H(L, e \wedge \omega) = -(L', \omega)$ . Then for  $m$  sufficiently large,

$$(\mathbb{I} + \partial \circ H + H \circ \partial)^m$$

is a chain homotopy equivalence to the copy of  $R$  spanned by the leaf sequence  $(p, p, \dots, p, i, i, \dots, i)$ .  $\square$

**5.3. The weighted module trees complex is acyclic.** In this section and subsequent ones, we again fix a ring  $R$  of characteristic 2. For the weighted module trees complex we have the following analogue of Theorem 5.2:

**Theorem 5.4.** *The homology of the  $n$ -input, weight  $w$  weighted module trees complex  $XM_*^{n,w}$  is:*

- Isomorphic to  $R$  if  $w = 0$ .
- Trivial if  $w > 0$ .

*Proof.* The weight-zero part of  $XM_*^{n,0}$  is isomorphic to the cellular chain complex of the associahedron,  $C_*^{cell}(K_n)$ , so the weight-zero case of Theorem 5.4 follows from the fact that the associahedron is a polyhedron. So, we will focus on the positive-weight case.

Recall that  $L_*^{n,w} \subset X_*^{n,w}$  denotes the subcomplex of left-unmarked trees. We will show that the inclusion map  $L_*^{n,w} \hookrightarrow X_*^{n,w}$  induces an isomorphism on homology. Consider the three steps in the proof that  $X_*^{n,w}$  is contractible:

- (1) First, we applied a homotopy  $K$  to retract to a subcomplex  $Y \subset X_*^{n,w}$ . Note that  $K$  preserves  $L_*^{n,w}$ , and hence gives a contraction of  $L_*^{n,w}$  to  $L_*^{n,w} \cap Y$ .
- (2) We then filtered the complex  $Y$  and observed that the  $E^0$ -page of the associated spectral sequence is a direct sum of copies of unweighted trees complexes. Each of these complexes is contractible. Further, each of these summands either lies in  $L_*^{n,w}$  or intersects  $L_*^{n,w}$  trivially, so these contractions again preserve  $L_*^{n,w}$ .
- (3) Finally, we define a retraction of the  $E^1$ -page to a particular tree  $T_0$  in  $L_*^{n,w}$ . The homotopy  $H$  used to define this retraction again preserves  $L_*^{n,w}$ .

Thus, as claimed, the inclusion  $L_*^{n,w} \hookrightarrow X_*^{n,w}$  induces an isomorphism in homology, so  $XM_*^{n,w} = X_*^{n,w}/L_*^{n,w}$  is acyclic.  $\square$

**5.4. The weighted transformation trees complex is contractible.** In this section we show that the weighted transformation trees complex is contractible:

**Proposition 5.5.** *The weighted transformation trees complex  $J_*^{n,w}$  has homology  $H_0(J_*^{n,w}) = R$  and  $H_i(J_*^{n,w}) = 0$  for all  $i > 0$ .*

*Proof.* Define a homotopy operator  $H$  as follows. Given a weighted transformation tree  $T$ , find via depth first search the first purple vertex which is not a 2-valent weight 0 vertex  $v$  whose predecessor is an input. If  $v$  is 2-valent with weight 0, let  $H(T)$  be the weighted transformation tree obtained by contracting the edge into  $v$ ; otherwise, let  $H(T) = 0$ .

Consider the function

$$F(T) = \sum_{\{u \in \text{Vert}(T) \mid u \text{ is not blue}\}} (\text{val}(u) + 2w(u) - 2).$$

Clearly,  $F(T) \geq 0$  for all  $T$ , and the differential respects the filtration determined by  $F$ . Finally, if  $F(T) > 0$ , then all terms in

$$(\partial \circ H + H \circ \partial + \mathbb{I})(T)$$

are in filtration level strictly less than  $F(T)$ ; while if  $F(T) = 0$ , then  $(\partial \circ H + H \circ \partial)(T) = 0$ . It follows that  $J_*^{n,w}$  is chain homotopy equivalent to the subcomplex generated by  $T$  where  $F(T) = 0$ . If  $F(T) = 0$  then  $T$  consists of a valence 2, weight 0 purple vertex and a tree of blue vertices. Thus, this subcomplex is identified with the associaplex with  $n$  inputs and weight  $w$ . The result now follows from the corresponding fact for the associaplex.  $\square$

**5.5. The weighted module transformation trees complex is acyclic.** Finally we show that the weighted module transformation trees complex is acyclic:

**Proposition 5.6.** *The weighted module transformation trees complex  $JM_*^{n,w}$  has homology  $H_0(JM_*^{n,0}) = R$ ,  $H_i(JM_*^{n,0}) = 0$  for  $i > 0$ , and  $H_*(JM_*^{n,w}) = 0$  if  $w > 0$ .*

*Proof.* Define a homotopy  $K$  of the module transformation trees complex by declaring that  $K(T) = 0$  if the distinguished vertex  $v$  of  $T$  has weight  $w(v) > 0$  or valence  $\text{val}(v) > 2$  or if  $w(v) = 0$  and  $\text{val}(v) = 2$  but the predecessor to  $v$  is an input of  $T$ ; and if  $w(v) = 0$  and  $\text{val}(v) = 2$  and the predecessor to  $v$  is not an input of  $T$  then  $K(T)$  is the result of contracting the edge into  $v$ . Then for  $N$  sufficiently large,  $(K \circ \partial + \partial \circ K + \mathbb{I})^N$  sends any tree  $T$  to a transformation tree  $T'$  where  $v$  is 2-valent, weight 0, and at the top of  $T'$ . The resulting complex is identified with the weighted module trees complex. The proposition follows.  $\square$

**5.6. The homotopy unital complexes are contractible.**

**Definition 5.7.** *For  $n + 2w \geq 2$  there is a chain map  $\pi: uX_*^{n,w} \rightarrow X_*^{n,w}$  which erases all stumps adjacent to 2-input, weight 0 vertices and forgets the vertex adjacent to the stump, and then sends the tree to zero if there are any thorns or any remaining stumps. There are similar projections for the module trees complexes, the transformation trees complexes, and the module transformation trees complexes.*

**Theorem 5.8.** *For  $n + 2w \geq 2$  the projection  $\pi: uX_*^{n,w} \rightarrow X_*^{n,w}$  induces an isomorphism on homology. The homology of  $uX_*^{0,0}$  is generated by  $\top$ , while the homology of  $uX_*^{1,0}$  is generated by  $\downarrow$ . In particular, for each  $n, w$ , the homology of  $uX_*^{n,w}$  is one-dimensional, supported in dimension 0.*

(In the unweighted case, this is immediate from [MT14, Corollary 4.5].)

*Proof.* There is a filtration on  $uX_*^{n,w}$  by the number of thorns. The associated graded complex is a direct sum of copies of  $X_*^{n+s+t,w}$ , corresponding to trees with  $s$  stumps and  $t$  thorns. There is one copy of  $X_*^{n+s+t,w}$  for each pair of subsets  $S, T \subset \{1, \dots, n + s + t\}$  with  $|S| = s$ ,  $|T| = t$ , and  $S \cap T = \emptyset$  (where  $S$  and  $T$  correspond to the locations of the stumps and thorns, respectively). Thus, by Theorem 5.2, the  $E^1$ -page is 1-dimensional for each pair  $S, T$  as above, represented by the left-associated, binary trees with all weight in weight-1 popsicles, where some inputs are thorns or stumps, and the popsicles are to the right of all other inputs.

The  $d^1$ -differential corresponds to the sum of all ways of deleting a thorn or replacing a thorn by a stump. Filter the  $E^1$ -page by the number of internal vertices. The associated graded complex is acyclic unless  $s = t = 0$ . At this point, the homology is entirely supported in dimension 0, so the spectral sequences collapse.

We have shown that, for each  $n, w$ , the homology of  $uX_*^{n,w}$  is isomorphic to  $\mathbb{F}_2$  and, moreover, the homology is represented by the left-associated binary tree with all the weight in weight-1 popsicles. The map  $\pi$  takes this binary tree to a generator for the homology of  $X_*^{n,w}$ . It follows that  $\pi$  is a quasi-isomorphism.  $\square$

**Theorem 5.9.** *For  $n + 2w \geq 2$ , the projection  $uXM_*^{n,w} \rightarrow XM_*^{n,w}$  induces an isomorphism on homology. For  $(n, w) = (1, 0)$  the homology of  $uXM_*^{n,w}$  is generated by the identity tree. In particular, the homology of  $uXM_*^{n,w}$  is one-dimensional, supported in dimension 0, if  $w = 0$  and is trivial otherwise.*

*Proof.* The proof is essentially the same as the proof of Theorem 5.8. □

**Theorem 5.10.** *The projection of the homotopy unital weighted transformation trees complex to the weighted transformation trees complex induces an isomorphism on homology.*

*Proof.* Again, the proof is essentially the same as the proof of Theorem 5.8. □

**Theorem 5.11.** *The projection of the homotopy unital weighted module transformation trees complex to the weighted module transformation trees complex induces an isomorphism on homology.*

*Proof.* Again, the proof is essentially the same as the proof of Theorem 5.8. □

## 6. WEIGHTED DIAGONALS

**Convention 6.1.** *Fix a commutative  $\mathbb{F}_2$ -algebra  $R$ . In this section, undecorated tensor products are over  $R$ . (The rings  $\mathbb{k}$  will not appear.)*

**6.1. Dimension and weight.** In this section, we work over the polynomial ring  $R[Y_1, Y_2]$ . We extend the notion of the dimension

$$\dim(T) = n + 2w - v - 1$$

(Equation (4.6)) of a weighted tree to  $X_*^{n,w} \otimes R[Y_1, Y_2]$  by declaring that the dimension  $\dim(Y_i) = 0$ ; and similarly for weighted transformation trees, weighted module trees, and so on. (Another grading will be used in Section 7, so we use the word dimension here to avoid a conflict of terminology.) Extend  $\dim$  additively to tensor products.

Given a weighted tree  $T \in X_*^{n,w}$ , let  $\text{wt}(T) = w$  be the total weight of  $T$ , i.e., the sum of the weights of the vertices of  $T$ . Given an element

$$Y_1^a Y_2^b (S \otimes T) \in R[Y_1, Y_2] \otimes X_*^{m,v} \otimes X_*^{n,w}$$

let

$$\begin{aligned} \text{wt}_1(Y_1^a Y_2^b (S \otimes T)) &= a + v = a + \text{wt}(S) \\ \text{wt}_2(Y_1^a Y_2^b (S \otimes T)) &= b + w = b + \text{wt}(T). \end{aligned}$$

Again, we make the analogous definitions for weighted transformation trees, weighted module trees, and so on.

**6.2. Weighted algebra diagonals.** In order to define a notion of weighted diagonals general enough for our applications, it is convenient to consider a slightly larger complex of trees. Specifically, we include the following *generalized weighted trees*:

- The tree  $\downarrow$  with one input and no internal vertices. We define  $\widetilde{\mathcal{T}}_{1,0}$  to consist of this tree. Formula (4.6) gives  $\dim(\downarrow) = 0$ .
- A *stump*  $\tau$  with no inputs and no internal vertices. We define  $\widetilde{\mathcal{T}}_{0,0}$  to consist of this stump. (The tree  $\tau$  represents feeding in the identity in a weighted  $A_\infty$ -algebra.) We think of  $\tau$  as having  $-1$  internal vertices, so Formula (4.6) gives  $\dim(\tau) = 0$  for the stump.

Neither of these is stable in the sense of Section 4.1. Let  $\widetilde{X}_*^{n,w}$  denote  $X_*^{n,w}$  if  $w > 0$  or  $w = 0$  and  $n > 1$ ,  $\widetilde{X}_*^{1,0} = R\langle \widetilde{\mathcal{T}}_{1,0} \rangle$ , and  $\widetilde{X}_*^{0,0} = R\langle \widetilde{\mathcal{T}}_{0,0} \rangle$ .

We extend the composition map  $\circ_i$  to  $\downarrow$  and  $\tau$  as follows:

- Composing with  $\downarrow$  (in any way) is the identity map  $\widetilde{X}_*^{n,w} \rightarrow \widetilde{X}_*^{n,w}$ .

- If  $T$  is a stable weighted tree then the composition  $T \circ_i \top = 0$  unless the  $i^{\text{th}}$  input of  $T$  feeds immediately into a valence 3 (2-input, 1-output) vertex with weight 0. If the successor of the  $i^{\text{th}}$  input of  $T$  has valence 3 and weight 0 then  $T \circ_i \top$  is the result of erasing the  $i^{\text{th}}$  input of  $T$  and forgetting the successor of the  $i^{\text{th}}$  input of  $T$ , so that  $T \circ_i \top$  is an element of  $\widetilde{\mathcal{T}}_{n-1,w}$  with one fewer internal vertex than  $T$ .

The differential on  $\widetilde{X}_*^{n,w}$  is induced from the differential on  $X_*^{n,w}$  and, in particular, vanishes on  $\widetilde{X}_*^{1,0}$  and  $\widetilde{X}_*^{0,0}$ .

**Lemma 6.2.** *This extension of  $\circ_i$  is a chain map.*

*Proof.* The fact that composing with  $\downarrow$  (which is the identity map) is a chain map is obvious. To see that  $\circ_i \top$  is a chain map, suppose that the  $i^{\text{th}}$  input of  $T$  feeds into a vertex  $v$  of valence  $n$  and weight  $w$ . We have the following cases:

- (1) If  $n > 3$  then  $T \circ_i \top = 0$ . There are exactly two terms  $S_1, S_2$  in  $\partial T$  so that  $S_j \circ_i \top \neq 0$ :  $S_1$  and  $S_2$  are the two ways of splitting  $v$  so that the  $i^{\text{th}}$  input feeds into a valence 3, weight 0 input. Further,  $S_1 \circ_i \top = S_2 \circ_i \top$ , so  $(\partial T) \circ_i \top = 0$ .
- (2) If  $n = 2$  or  $n = 3$  and  $w > 0$  then again  $T \circ_i \top = 0$  and there are exactly two terms  $S_1, S_2$  in  $\partial T$  so that  $S_j \circ_i \top \neq 0$ . For  $n = 3$ ,  $S_1$  and  $S_2$  are the result of pushing all of the weight of  $v$  onto either of the two edges incident to  $v$  not coming from the  $i^{\text{th}}$  input. For  $n = 2$ ,  $S_1$  and  $S_2$  come from pushing all of  $v$ 's weight into a popsicle feeding into  $v$  from either the left or the right.
- (3) If  $n = 3$  and  $w = 0$  then  $T \circ_i \top$  is the result of deleting the  $i^{\text{th}}$  input and forgetting the vertex  $v$ . Further for every term  $S$  in  $\partial T$ , the  $i^{\text{th}}$  input of  $S$  feeds into a valence 3 vertex, so  $S \circ_i \top$  is the result of deleting the  $i^{\text{th}}$  input of  $S$  and forgetting this valence 3 vertex. In particular,  $\partial(T \circ_i \top) = (\partial T) \circ_i \top$ .

This completes the proof.  $\square$

**Definition 6.3.** *A seed for a weighted algebra diagonal is an  $R[Y_1, Y_2]$ -linear combination  $\mathcal{S}$  of the following terms:*

$$\Psi_0^1 \otimes \Psi_0^1, \quad Y_1 \top \otimes \Psi_0^1, \quad Y_2 \Psi_0^1 \otimes \top.$$

(This linear combination is to be interpreted as an element of  $[(\widetilde{X}_*^{0,1} \otimes \widetilde{X}_*^{0,1}) \oplus (\widetilde{X}_*^{0,0} \otimes \widetilde{X}_*^{0,1}) \oplus (\widetilde{X}_*^{0,1} \otimes \widetilde{X}_*^{0,0})] \otimes R[Y_1, Y_2]$ .)

**Definition 6.4.** *A weighted algebra diagonal with seed  $\mathcal{S}$  is a collection of chain maps*

$$(6.5) \quad \mathbf{\Gamma}^{n,w}: X_*^{n,w} \rightarrow \bigoplus_{w_1, w_2 \leq w} \widetilde{X}_*^{n,w_1} \otimes \widetilde{X}_*^{n,w_2} \otimes R[Y_1, Y_2]$$

with the following properties:

- **Dimension homogeneity:** *The map  $\mathbf{\Gamma}^{n,w}$  is dimension-preserving, i.e.,*

$$\dim(\mathbf{\Gamma}^{n,w}(T)) = \dim(T).$$

(Recall that  $\dim(Y_i) = 0$ .)

- **Weight homogeneity:** *The projection of the image of  $\mathbf{\Gamma}^{n,w}$  to  $\widetilde{X}_*^{n,w_1} \otimes \widetilde{X}_*^{n,w_2} \otimes R[Y_1, Y_2]$  is contained in  $Y_1^{w-w_1} Y_2^{w-w_2} \widetilde{X}_*^{n,w_1} \otimes \widetilde{X}_*^{n,w_2}$ . In other words,*

$$\text{wt}_1(\mathbf{\Gamma}^{n,w}(T)) = \text{wt}_2(\mathbf{\Gamma}^{n,w}(T)) = \text{wt}(T) = w.$$

- **Compatibility under stacking:**

$$\mathbf{\Gamma}^{n,v+w} \circ \phi_{i,j,n;v,w} = \sum_{\substack{v_1+v_2 \leq v \\ w_1+w_2 \leq w}} (\phi_{i,j,n;v_1,w_1} \otimes \phi_{i,j,n;v_2,w_2}) \circ (\mathbf{\Gamma}^{j-i+1,v} \otimes \mathbf{\Gamma}^{n+i-j,w}).$$

- **Non-degeneracy:**

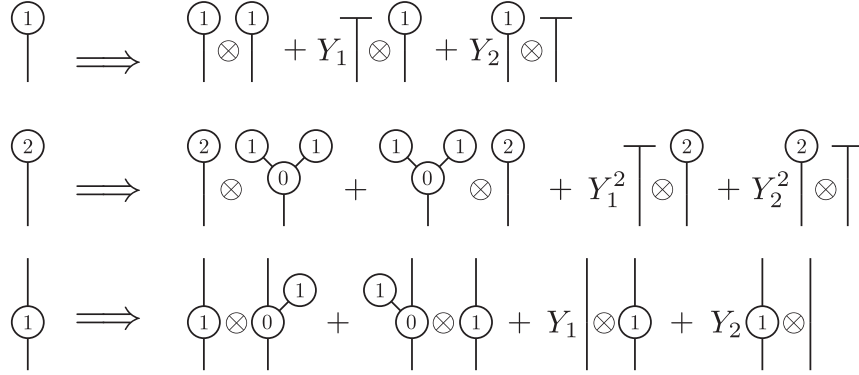

FIGURE 35. **Terms in a maximal weighted algebra diagonal.** The images of  $\Psi_0^1$ ,  $\Psi_0^2$ , and  $\Psi_1^1$  are shown. The tree  $\top$  is denoted as a vertical line with horizontal line on top. For the image of weight 0 corollas see Figure 3. We have drawn one of the two possible choices for  $\Gamma^{1,1}$ .

- (1) By the weight homogeneity condition,  $\Gamma^{2,0}$  is a map  $R = X_*^{2,0} \rightarrow R \otimes_R R = X_*^{2,0} \otimes X_*^{2,0}$ . We require that this map is the canonical isomorphism. (This is the same as non-degeneracy in Definition 2.13.)
- (2) The image under  $\Gamma^{0,1}$  of  $\Psi_0^1 \in X_*^{0,1}$  is the seed  $\mathcal{S}$ .
- (3) The image of  $\Gamma^{n,w}$  is contained in

$$\bigoplus_{w_1, w_2 \leq w} (\tilde{X}_*^{n, w_1} \otimes X_*^{n, w_2} \otimes R[Y_1, Y_2] + X_*^{n, w_1} \otimes \tilde{X}_*^{n, w_2} \otimes R[Y_1, Y_2]),$$

i.e., at most one of each pair of trees in the diagonal is a generalized tree.

In particular, restricting to the diagonals  $\Gamma^{n,0}$  gives an associahedron diagonal. In the applications, we will be most interested in the *maximal seed*

$$\mathcal{S} = \Psi_0^1 \otimes \Psi_0^1 + Y_1 \top \otimes \Psi_0^1 + Y_2 \Psi_0^1 \otimes \top.$$

The first few terms in a diagonal with this seed are shown in Figure 35.

**Definition 6.6.** A collection of weighted diagonal cells consists of a chain

$$\gamma^{n,w} \in \bigoplus_{w_1, w_2 \leq w} Y_1^{w-w_1} Y_2^{w-w_2} \tilde{X}_*^{n, w_1} \otimes \tilde{X}_*^{n, w_2} \subset \bigoplus_{w_1, w_2 \leq w} \tilde{X}_*^{n, w_1} \otimes \tilde{X}_*^{n, w_2} \otimes R[Y_1, Y_2]$$

of dimension  $\dim(\Psi_n^w) = n + 2w - 2$ , for each  $n, w \geq 0$  with  $n + 2w \geq 2$ , satisfying the following properties:

- **Compatibility:**

$$(6.7) \quad \partial \gamma^{n,x} = \sum_{\substack{v+w=x \\ 1 \leq i \leq n \\ i-1 \leq j \leq n}} \gamma^{n+i-j,v} \circ_i \gamma^{j-i+1,w}.$$

- **Non-degeneracy:**

- $\gamma^{2,0} = \Psi_2^0 \otimes \Psi_2^0$ .
- $\gamma^{n,w}$  is contained in

$$\bigoplus_{w_1, w_2 \leq w} (\tilde{X}_*^{n, w_1} \otimes X_*^{n, w_2} \otimes R[Y_1, Y_2] + X_*^{n, w_1} \otimes \tilde{X}_*^{n, w_2} \otimes R[Y_1, Y_2]),$$

i.e., at most one of each pair of trees in the diagonal is a generalized tree.

The seed of the collection of weighted diagonal cells is  $\gamma^{0,1}$ .

The compatibility condition can also be written

$$(6.8) \quad \partial \gamma^{n,x} = \sum_{\substack{v+w=x \\ 0 \leq j \leq n \\ 1 \leq i \leq n-j+1}} \gamma^{n-j+1,v} \circ_i \gamma^{j,w} = \sum_{\substack{v+w=x \\ j+k=n+1}} \gamma^{k,v} \circ \gamma^{j,w}.$$

with the understanding that  $\gamma^{1,0} = \gamma^{0,0} = 0$ . (For the abuse of notation  $\circ$  used here, see Section 2.1.)

**Construction 6.9.** Given a collection of diagonal cells  $\{\gamma^{n,w}\}$  define a collection of maps  $\mathbf{\Gamma}^{n,w}$  of the form (6.5) inductively by the following two rules:

- $\mathbf{\Gamma}^{n,w}(\Psi_n^w) = \gamma^{n,w}$ .
- $\mathbf{\Gamma}^{n,w}(T_1 \circ_i T_2) = \mathbf{\Gamma}^{n_1,w_1}(T_1) \circ_i \mathbf{\Gamma}^{n_2,w_2}(T_2)$ . (Here,  $T_i$  has weight  $w_i$  and  $n_i$  inputs.)

**Lemma 6.10.** Given a weighted algebra diagonal  $\{\mathbf{\Gamma}^{n,w}\}$  with seed  $\mathcal{S} = \mathbf{\Gamma}^{0,1}(\Psi_0^1)$ , the chains  $\{\gamma^{n,w} = \mathbf{\Gamma}^{n,w}(\Psi_n^w)\}$  form a collection of weighted diagonal cells with seed  $\mathcal{S}$ .

Conversely, given a collection of weighted diagonal cells  $\{\gamma^{n,w}\}$ , Construction 6.9 defines a weighted algebra diagonal with the same seed.

*Proof.* This is immediate from the definitions.  $\square$

**Theorem 6.11.** Given any seed  $\mathcal{S}$  there is a weighted algebra diagonal with seed  $\mathcal{S}$ .

*Proof.* We must check that the right hand side of Equation (6.8) is a cycle. Then, for  $(n,w) \notin \{(2,0), (0,1), (3,0), (1,1)\}$  the dimension of the right hand side of Equation (6.7) is greater than 0, so it follows from Theorem 5.2 that the right hand side is also a boundary. For the base cases,  $(2,0)$  and  $(0,1)$  are specified by the non-degeneracy condition, a solution for  $\gamma^{3,0}$  is shown in Figure 3 and a solution for  $\gamma^{1,1}$  is shown in Figure 35 (third line) for the maximal seed. Given another seed

$$r_1 \Psi_0^1 \otimes \Psi_0^1 + r_2 Y_1 \top \otimes \Psi_0^1 + r_3 Y_2 \Psi_0^1 \otimes \top,$$

this base case is obtained by multiplying the first two pairs of trees in Figure 35 by  $r_1$ , the third pair by  $r_2$ , and the fourth pair by  $r_3$ .

To see that the right hand side of Equation (6.8) is a cycle, note that inductively

$$\begin{aligned} \partial \sum_{\substack{v+w=x \\ j+k=n+1}} \gamma^{k,v} \circ \gamma^{j,w} &= \sum_{\substack{v+w=x \\ j+k=n+1}} (\partial \gamma^{k,v}) \circ \gamma^{j,w} + \gamma^{k,v} \circ (\partial \gamma^{j,w}) \\ &= 2 \sum_{\substack{u+v+w=x \\ j+k+\ell=n+2}} \gamma^{k,u} \circ \gamma^{j,v} \circ \gamma^{\ell,w} = 0. \end{aligned} \quad \square$$

*Remark 6.12.* The proof of Theorem 6.11 shows that for any  $W_0$ , if we are given chains  $\gamma^{n,w}$  for all  $w < W_0$ , satisfying Condition (6.7) for all  $x < W_0$ , we can extend  $\gamma^{n,w}$  to a weighted algebra diagonal. In particular, any associahedron diagonal can be extended to a weighted algebra diagonal.

**6.3. Weighted map diagonals.** For any  $1 \leq i \leq j \leq n$ ,  $v, w \geq 0$ ;  $0 = i_1 \leq i_2 < \dots < i_\ell = n$ , and  $w_1, \dots, w_\ell \geq 0$ , there are chain maps

$$\begin{aligned} \psi_{i,j;v,w}^n &: X_*^{j-i,v} \otimes J_*^{n+i-j+1,w} \rightarrow J_*^{n,v+w} \\ \xi_{i_1, \dots, i_\ell}^n &: J_*^{i_2-i_1, w_1} \otimes \dots \otimes J_*^{i_\ell-i_{\ell-1}, w_{\ell-1}} \otimes X_*^{\ell-1, w_\ell} \rightarrow J_*^{n, w_1+\dots+w_\ell}. \end{aligned}$$

In terms of trees, the map  $\psi_{i,j}^n$  corresponds to  $(S, T) \mapsto T \circ_i S$  (where  $T$  is a weighted transformation tree and  $S$  is a (red) weighted algebra tree). The map  $\xi_{i_1, \dots, i_\ell}^n$  corresponds to

$$(T_1, \dots, T_\ell, S) \mapsto S \circ (T_1, \dots, T_\ell) = ((S \circ_\ell T_\ell) \circ_{\ell-1} \dots) \circ_1 T_1$$

(where the  $T_i$  are weighted transformation trees and  $S$  is a (blue) weighted algebra tree).

We extend these maps to the generalized weighted trees complex, by declaring that:

- Composing a purple vertex  $v$  with a red or blue identity  $\downarrow$ , in any valid way, gives the same purple vertex  $v$ .



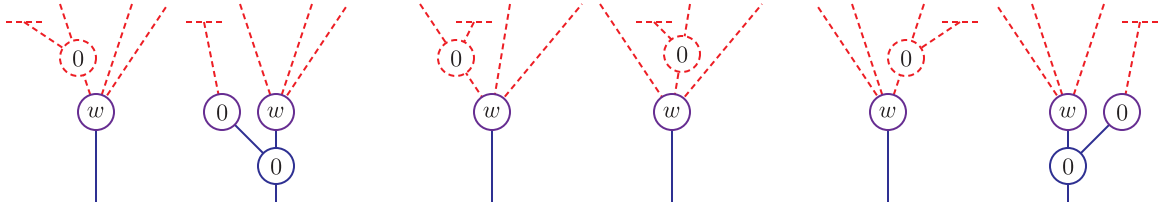

FIGURE 36. **Differential of a purple corolla composed with a stump.** The two non-zero terms in each of the three cases are shown.

- Composing a purple vertex  $v$  with a red stump  $\top$  gives a blue stump  $\top$  if the purple vertex has 1 input and weight 0, and 0 otherwise.

In particular, the second composition lands in the *extended weighted transformation trees complex*  $\tilde{\mathcal{J}}_*^{\ell,w}$ , which agrees with  $J_*^{\ell,w}$  if  $(\ell, w) \neq (0, 0)$  and is generated by the blue stump  $\top$  if  $(\ell, w) = (0, 0)$ .

**Lemma 6.13.** *These extensions make  $(S, T_1, \dots, T_\ell) \mapsto S \circ (T_1, \dots, T_\ell)$  and  $(S, T) \mapsto S \circ_i T$  into chain maps*

$$\tilde{X}_*^{k,v} \otimes \tilde{\mathcal{J}}_*^{\ell_1, w_1} \otimes \dots \otimes \tilde{\mathcal{J}}_*^{\ell_k, w_k} \rightarrow \tilde{\mathcal{J}}_*^{\ell_1 + \dots + \ell_k, v + w_1 + \dots + w_k}$$

and

$$\tilde{\mathcal{J}}_*^{k,v} \otimes \tilde{X}_*^{\ell,w} \rightarrow \tilde{\mathcal{J}}_*^{k+\ell-1, v+w}$$

and hence make the extensions of  $\psi$  and  $\xi$  to generalized weighted trees into chain maps.

*Proof.* The fact that composing with  $\downarrow$  is a chain map is obvious. For  $\top$ , there is one interesting case: the composition of an  $n$ -input, weight  $w$  purple corolla,  $n + 2w \geq 2$ , and a stump. There are three sub-cases, depending on whether  $i = 1$ ,  $1 < i < n$ , or  $i = n$ ; these are shown in Figure 36. In all cases, both nonzero terms give an  $(n - 1)$ -input, weight  $w$  purple corolla.  $\square$

**Definition 6.14.** *Fix a weighted algebra diagonals  $\Gamma_1^{*,*}$  and  $\Gamma_2^{*,*}$ . A weighted map diagonal compatible with  $\Gamma_1^{*,*}$  and  $\Gamma_2^{*,*}$  consists of a sequence of chain maps*

$$(6.15) \quad \Theta^{n,w} : J_*^{n,w} \rightarrow \bigoplus_{w_1, w_2 \leq w} \left( (J_*^{n, w_1} \otimes \tilde{\mathcal{J}}_*^{n, w_2}) + (\tilde{\mathcal{J}}_*^{n, w_1} \otimes J_*^{n, w_2}) \right) \otimes (R[Y_1, Y_2]) \\ \subset \bigoplus_{w_1, w_2 \leq w} \tilde{\mathcal{J}}_*^{n, w_1} \otimes \tilde{\mathcal{J}}_*^{n, w_2} \otimes R[Y_1, Y_2]$$

for  $w \geq 0$  and  $n \geq 0$ ,  $(w, n) \neq (0, 0)$ , satisfying the following conditions:

- **Dimension homogeneity:** The map  $\Theta^{n,w}$  is dimension-preserving, i.e.,

$$\dim(\Theta^{n,w}(T)) = \dim(T).$$

- **Weight homogeneity:** The image of  $\Theta^{n,w}$  is contained in  $Y_1^{w-w_1} Y_2^{w-w_2} \tilde{\mathcal{J}}_*^{n, w_1} \otimes \tilde{\mathcal{J}}_*^{n, w_2}$  or, equivalently,

$$\text{wt}_1(\Theta^{n,w}(T)) = \text{wt}_2(\Theta^{n,w}(T)) = \text{wt}(T) = w.$$

- **Compatibility under stacking:**

$$\Theta^{n, v+w} \circ \psi_{i, j; v, w}^n = \sum_{\substack{v_1 + v_2 \leq v \\ w_1 + w_2 \leq w}} (\psi_{i, j; v_1, w_1}^n \otimes \psi_{i, j; v_2, w_2}^n) \circ (\Gamma_1^{j-i, v} \otimes \Theta^{n+i-j+1, w})$$

$$\Theta^{n, w} \circ \xi_{i_1, \dots, i_\ell}^n = \sum_{w_1 + \dots + w_\ell = w} (\xi_{i_1, \dots, i_\ell}^n \otimes \xi_{i_1, \dots, i_\ell}^n) \circ (\Theta^{i_2 - i_1, w_1} \otimes \dots \otimes \Theta^{i_\ell - i_{\ell-1}, w_{\ell-1}} \otimes \Gamma_2^{\ell, w_\ell}),$$

with the understanding that the compositions on the right-hand side involve shuffling of factors (compare Formula (2.15)).

- **Non-degeneracy:**  $\Theta^{1,0}(\mathfrak{p}\Psi_1^0) = \mathfrak{p}\Psi_1^0 \otimes \mathfrak{p}\Psi_1^0$ . (Note that  $J_*^{1,0} \cong R\langle \mathfrak{p}\Psi_1^0 \rangle$ .)

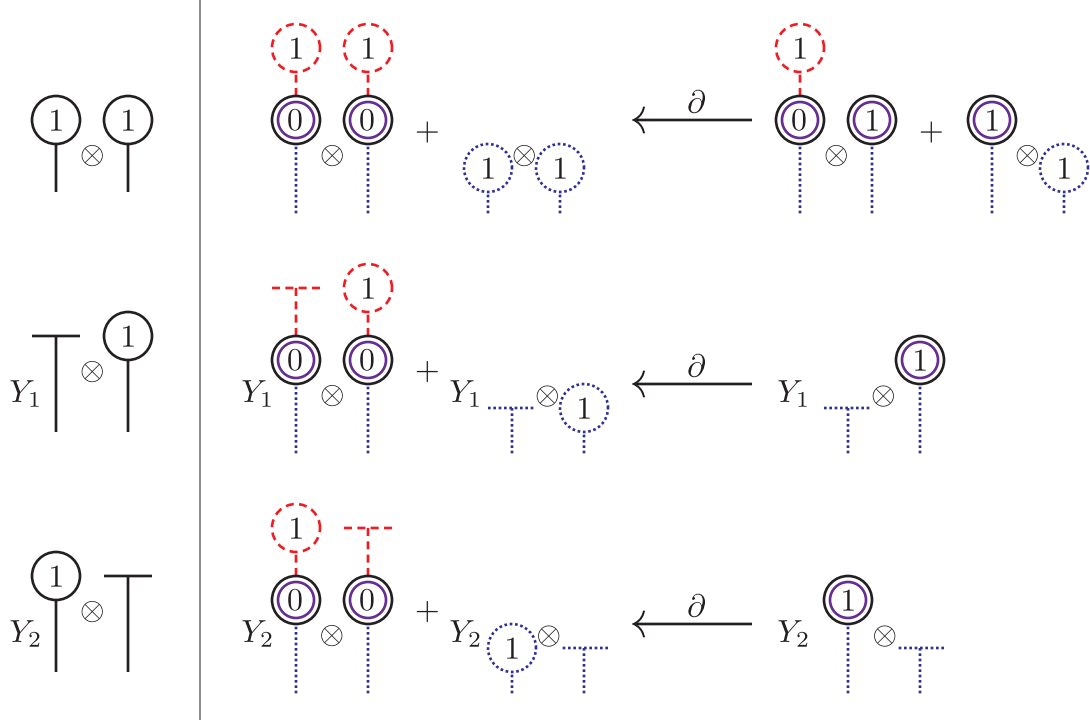

FIGURE 37. **Existence of weighted map diagonals.** The base case for each possible term in the seed is shown. On the left is the term in the seed, in the center are the corresponding terms on the right side of Equation (6.17), and on the right is an option for the weighted map diagonal.

Weighted map diagonals can be phrased in terms of trees as follows:

**Definition 6.16.** *In terms of trees, if  $\Gamma_1^{*,*}$  and  $\Gamma_2^{*,*}$  correspond to collections of weighted diagonal cells  $\gamma_1^{*,*}$  and  $\gamma_2^{*,*}$ , a weighted map diagonal is specified by a sequence of weighted map cells, which are elements*

$$\theta^{n,w} = \Theta^{n,w}(\Psi_n^w) \in \bigoplus_{w_1, w_2 \leq w} Y_1^{w-w_1} Y_2^{w-w_2} (\tilde{J}_*^{n,w_1} \otimes J_*^{n,w_2} + J_*^{n,w_1} \otimes \tilde{J}_*^{n,w_2}) \subset \tilde{J}_*^{n,w_1} \otimes \tilde{J}_*^{n,w_2} \otimes R[Y_1, Y_2]$$

in dimension  $n + 2w - 1$  satisfying:

- **Compatibility:**

$$(6.17) \quad \partial(\theta^{n,w}) = \sum_{\substack{i+j=n+1 \\ u+v=w}} \theta^{i,u} \circ \gamma_1^{j,v} + \sum_{k=0}^{\infty} \sum_{\substack{m_1+\dots+m_k=n \\ v+w_1+\dots+w_k=w}} \gamma_2^{k,v} \circ (\theta^{m_1,w_1}, \dots, \theta^{m_k,w_k}).$$

(Note that in the second sum,  $k = 0$  only occurs if  $n = 0$ .)

- **Non-degeneracy:**  $\theta^{1,0} = \mathbf{p}\Psi_1^0 \otimes \mathbf{p}\Psi_1^0 \in X_*^{1,0} \otimes X_*^{1,0}$  is the (unique) pair of 1-input, weight 0 transformation trees (with 1 internal vertex each).

**Lemma 6.18.** *Given any two weighted algebra diagonals  $\Gamma_1^{*,*}$  and  $\Gamma_2^{*,*}$  with the same seeds, there exists a weighted map diagonal  $\Theta^{*,*}$  compatible with  $\Gamma_1^{*,*}$  and  $\Gamma_2^{*,*}$ .*

*Proof.* By Proposition 5.5, the weighted transformation trees complex is contractible. So, as usual, it suffices to verify that the right-hand side of the weighted map diagonal equation (6.17) is a cycle

and that when the right-hand side lies in dimension 0, it is a boundary. We leave the first statement, that the right-hand side is a cycle, to the reader. For the second, note that

$$\begin{aligned} \dim(\boldsymbol{\theta}^{i,u} \circ \gamma_1^{j,v}) &= i + j + 2u + 2v - 3 \\ \dim(\gamma_2^{k,v} \circ (\boldsymbol{\theta}^{m_1,w_1}, \dots, \boldsymbol{\theta}^{m_k,w_k})) &= 2(v + w_1 + \dots + w_k) - 2 + m_1 + \dots + m_k. \end{aligned}$$

Thus, the dimension 0 part consists of  $\boldsymbol{\theta}^{1,0} \circ \gamma_1^{2,0}$  and  $(\gamma_2^{2,0} \circ_2 \boldsymbol{\theta}^{1,0}) \circ_1 \boldsymbol{\theta}^{1,0}$ , which lie in the classical multiplihedron, and  $\boldsymbol{\theta}^{1,0} \circ \gamma_1^{0,1}$  and  $\gamma_2^{0,1}$ . This reduces to a case check, depending on the seed of the weighted algebra diagonals; see Figure 37.  $\square$

**6.4. Weighted module diagonals.** Like we did with  $X_*^{n,w}$ , we extend  $XM_*^{n,w}$  by allowing the 1-input, 0-internal vertex tree  $\downarrow$ . Specifically, let  $\widehat{XM}_*^{n,w} = XM_*^{n,w}$  except that  $\widehat{XM}_*^{1,0}$  is generated by  $\downarrow$  (rather than being trivial).

**Definition 6.19.** Fix a seed  $\mathcal{S}$  and a weighted algebra diagonal  $\Gamma^{n,w}$  with seed  $\mathcal{S}$ . A weighted (right) module diagonal compatible with  $\Gamma^{n,w}$  is a collection of chain maps

$$(6.20) \quad \mathbf{M}^{n,w} : XM_*^{n,w} \rightarrow \bigoplus_{w_1, w_2 \leq w} (XM_*^{n,w_1} \otimes \widehat{XM}_*^{n,w_2} + \widehat{XM}_*^{n,w_1} \otimes XM_*^{n,w_2}) \otimes R[Y_1, Y_2] \\ \subset \bigoplus_{w_1, w_2 \leq w} \widehat{XM}_*^{n,w_1} \otimes \widehat{XM}_*^{n,w_2} \otimes R[Y_1, Y_2]$$

with the following properties:

- **Dimension homogeneity:** The map  $\mathbf{M}^{n,w}$  is grading-preserving, i.e.,

$$\dim(\mathbf{M}^{n,w}(T)) = \dim(T).$$

- **Weight homogeneity:** The projection of the image of  $\mathbf{M}^{n,w}$  to  $\widehat{XM}_*^{n,w_1} \otimes \widehat{XM}_*^{n,w_2} \otimes R[Y_1, Y_2]$  is contained in  $Y_1^{w-w_1} Y_2^{w-w_2} \widehat{XM}_*^{n,w_1} \otimes \widehat{XM}_*^{n,w_2}$ . In other words,

$$\text{wt}_1(\mathbf{M}^{n,w}(T)) = \text{wt}_2(\mathbf{M}^{n,w}(T)) = \text{wt}(T) = w.$$

- **Compatibility under stacking:**

$$\mathbf{M}^{n,v+w} \circ \phi_{i,j,n;v,w} = \begin{cases} \sum_{\substack{v_1+v_2 \leq v \\ w_1+w_2 \leq w}} (\phi_{1,j,n;v_1,w_1} \otimes \phi_{1,j,n;v_2,w_2}) \circ (\mathbf{M}^{j,v} \otimes \mathbf{M}^{n+1-j,w}) & i = 1 \\ \sum_{\substack{v_1+v_2 \leq v \\ w_1+w_2 \leq w}} (\phi_{i,j,n;v_1,w_1} \otimes \phi_{i,j,n;v_2,w_2}) \circ (\Gamma^{j-i+1,v} \otimes \mathbf{M}^{n+i-j,w}) & i > 1 \end{cases}$$

- **Non-degeneracy:**

(1) By the weight homogeneity condition, the map  $\mathbf{M}^{2,0}$  is a map  $R = XM_*^{2,0} \rightarrow R \otimes_R R = XM_*^{2,0} \otimes XM_*^{2,0}$ . We require that  $\mathbf{M}^{2,0}$  is the canonical isomorphism, i.e.,  $\mathbf{M}^{2,0}(\Psi_2^0) = \Psi_2^0 \otimes \Psi_2^0$ . (This is the same as non-degeneracy in Definition 2.22.)

Equivalently, we can view  $\mathbf{M}^{n,w}$  as a formal linear combination of pairs of trees

$$(6.21) \quad \mathbf{m}^{n,w} \in \bigoplus_{w_1, w_2 \leq w} Y_1^{w-w_1} Y_2^{w-w_2} (\widehat{XM}_*^{n,w_1} \otimes XM_*^{n,w_2} + XM_*^{n,w_1} \otimes \widehat{XM}_*^{n,w_2}) \\ \subset \bigoplus_{w_1, w_2 \leq w} \widehat{XM}_*^{n,w_1} \otimes \widehat{XM}_*^{n,w_2} \otimes R[Y_1, Y_2]$$

of grading  $\dim(\Psi_n^w) = n + 2w - 2$ , satisfying the following conditions:

- **Compatibility:**

$$(6.22) \quad \partial \mathbf{m}^{n,x} = \sum_{v+w=x} \left( \sum_{j=1}^n \mathbf{m}^{n-j+1,v} \circ_1 \mathbf{m}^{j,w} + \sum_{2 \leq i \leq j \leq n} \mathbf{m}^{n+1+i-j,v} \circ_i \gamma^{j-i,w} \right).$$

- **Non-degeneracy:**  $\mathbf{m}^{2,0} = \Psi_2^0 \otimes \Psi_2^0$ .

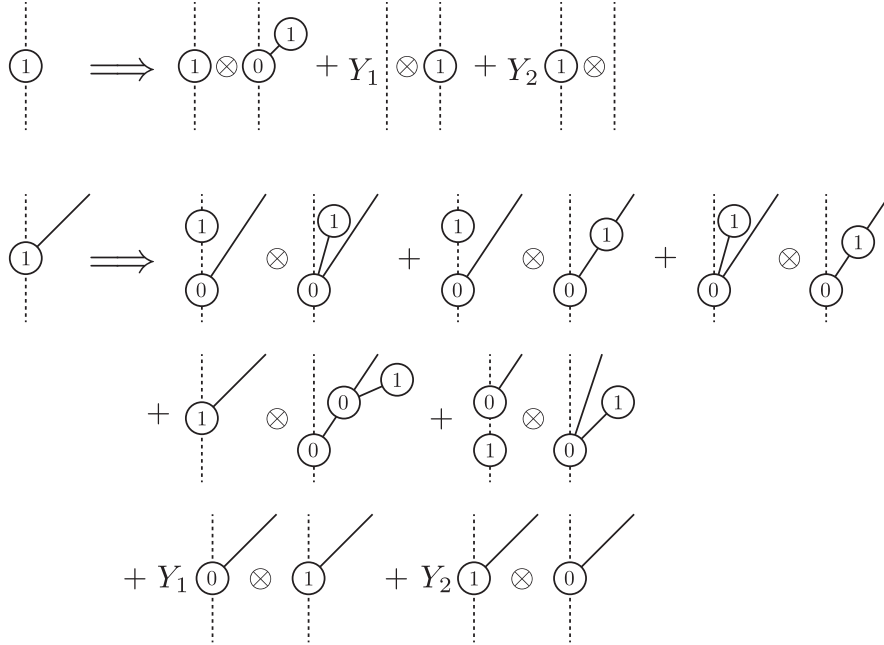

FIGURE 38. Terms in a weighted module diagonal compatible with Figure 35. We have shown  $\mathbf{m}^{1,1}$  and  $\mathbf{m}^{2,1}$ .

The first few terms in a particular weighted module diagonal are shown in Figure 38.

A module diagonal can be expressed alternatively as a formal power series, in the following sense. Let  $\mathbf{M}^{*,*}[[Y_1, Y_2]] = \mathbf{M}^{*,*} \otimes R[[Y_1, Y_2]]$ , a module over the ring of formal power series  $R[[Y_1, Y_2]]$ . A module diagonal forms an element

$$\mathbf{m}^{*,*} = \prod_{n,w=0}^{\infty} \mathbf{m}^{n,w} \in \mathbf{M}^{*,*}[[Y_1, Y_2]].$$

**Theorem 6.23.** *Given any weighted algebra diagonal  $\gamma^{n,w}$  there is a weighted module diagonal  $\mathbf{m}^{n,w}$  compatible with  $\gamma^{n,w}$ .*

*Proof.* The image of  $\gamma^{n,w}$  in

$$\bigoplus_{w_1, w_2 \leq w} \widetilde{XM}_*^{n, w_1} \otimes \widetilde{XM}_*^{n, w_2} \otimes R[[Y_1, Y_2]] = \bigoplus_{w_1, w_2 \leq w} (\widetilde{X}_*^{n, w_1} / L_*) \otimes (\widetilde{X}_*^{n, w_2} / L_*) \otimes R[[Y_1, Y_2]]$$

is a weighted module diagonal. □

*Remark 6.24.* As in the case of weighted algebra diagonals (Remark 6.12), given terms  $\mathbf{m}^{1+n,w}$  for all  $w < W_0$  satisfying Equation 6.22 for all  $x < W_0$ , these terms can be extended to a weighted module diagonal.

**6.5. Weighted primitives.** In this section, we define primitives for weighted module diagonals. We work over a weighted algebra diagonal with maximal seed. Module diagonal primitives with respect to certain other seeds can be obtained (and defined) by setting  $Y_1 = 0$  and/or  $Y_2 = 0$ , and the more general case is left to the reader.

Before defining weighted module diagonal primitives, we extend the definitions of root joining and left-root joining to the weighted case. Given weighted trees  $S_1, \dots, S_n$  the *root joining* of  $S_1, \dots, S_n$  is the sum over all non-negative weights  $w$  of the result of joining the outputs of  $S_1, \dots, S_n$  into a single new vertex of weight  $w$ , multiplied by  $Y_1^w$ . In the case  $n = 1$ , we require that the new

vertex have positive weight. In the case  $n = 0$  we define the root joining of zero trees to be  $\sum_{w \geq 1} Y_1^w \Psi_0^w \in X_*^{0,w}[[Y_1]]$ . In formulas, given  $n \geq 0$  and weighted trees  $S_1, \dots, S_n$ , define

$$(6.25) \quad \text{RoJ}^w(S_1, \dots, S_n) = Y_1^w \Psi_n^w \circ (S_1, \dots, S_n)$$

and

$$(6.26) \quad \text{RoJ}^*(S_1, \dots, S_n) = \sum_{w=0}^{\infty} \text{RoJ}^w(S_1, \dots, S_n).$$

For weighted trees, left joining is defined exactly as it was in the unweighted case. Define the left joining of the empty list of trees (the case  $n = 0$ ) to be the generalized tree  $\downarrow$ .

Given a sequence  $(T_1, S_1), (T_2, S_2), \dots, (T_n, S_n)$  of pairs of trees, with each  $T_i$  having one more input than the corresponding  $S_i$ , define the *left-root joining* of the sequence to be

$$(6.27) \quad \text{LR}^w((T_1, S_1), \dots, (T_n, S_n)) = \text{LeJ}(T_1, \dots, T_n) \otimes \text{RoJ}^w(S_1, \dots, S_n)$$

$$(6.28) \quad \begin{aligned} \text{LR}^*((T_1, S_1), \dots, (T_n, S_n)) &= \text{LeJ}(T_1, \dots, T_n) \otimes \text{RoJ}^*(S_1, \dots, S_n) \\ &= \sum_w \text{LR}^w((T_1, S_1), \dots, (T_n, S_n)). \end{aligned}$$

Extend  $\text{LR}^*$  multi-linearly to a function

$$\text{LR}^*: (\widehat{XM}_*^{*,*} \otimes \widetilde{X}_*^{*,*})^{\otimes n}[[Y_1, Y_2]] \rightarrow (\widehat{XM}_*^{*,*} \otimes \widetilde{X}_*^{*,*})[[Y_1, Y_2]].$$

for  $n \geq 0$ .

It follows from the definitions that

$$\text{LR}^*(\downarrow) = \sum_{w=1}^{\infty} Y_1^w (\downarrow \otimes \Psi_w^0) \in (\widehat{XM}_*^{*,*} \otimes X_*^{*,*})[[Y_1]].$$

**Definition 6.29.** Fix a weighted algebra diagonal  $\gamma^{n,w}$ . A (right) weighted module diagonal primitive compatible with  $\gamma^{*,*}$  consists of a linear combination of trees

$$(6.30) \quad \mathbf{p}^{n,w} = \sum_{(S,T)} (S, T) \in \bigoplus_{w_1, w_2 \leq w} Y_1^{w-w_1} Y_2^{w-w_2} (XM_*^{n, w_1} \otimes \widetilde{X}_*^{n-1, w_2}),$$

of dimension  $n+2w-2$ , for each  $n \geq 1$  and  $w \geq 0$ ,  $(n, w) \neq (1, 0)$ , satisfying the following conditions:

- **Compatibility:**

$$(6.31) \quad \partial \mathbf{p}^{n,w} = \sum_{\substack{v+w_1+\dots+w_k=w \\ n_1+\dots+n_k=n+k-1}} \text{LR}^v(\mathbf{p}^{n_1, w_1} \otimes \dots \otimes \mathbf{p}^{n_k, w_k}) + \sum_{\substack{w_1+w_2=w \\ n_1+n_2=n+1}} \mathbf{p}^{n_1, w_1} \circ' \gamma^{n_2, w_2}$$

or, more succinctly,

$$(6.32) \quad \partial \mathbf{p}^{*,*} = \text{LR}^*((\mathbf{p}^{*,*})^{\otimes \bullet}) + \mathbf{p}^{*,*} \circ' \gamma^{*,*}.$$

Here,  $\mathbf{p}^{*,*} = \sum_{n,w} \mathbf{p}^{n,w}$  and  $(\mathbf{p}^{*,*})^{\otimes \bullet} = \sum_{n \geq 0} (\mathbf{p}^{*,*})^{\otimes n}$ .

- **Non-degeneracy:**  $\mathbf{p}^{2,0} = \Psi_2^0 \otimes \downarrow$ .

The weight-zero piece of a weighted module diagonal primitive  $\mathbf{p}^{n,0}$  is a module diagonal primitive (Definition 2.29). Note also that while the definition of  $\text{LR}^*$  uses a power series ring, the coefficients of  $\mathbf{p}^{n,w}$  are polynomials in  $Y_1$  and  $Y_2$ , not power series.

See Figure 35 for some positive-weight terms in a weighted module diagonal primitive (and Figure 7 for some weight-zero terms).

The construction of primitives hinges on the following identities (cf. Lemma 2.33):

**Lemma 6.33.** Given  $x_1 \otimes \dots \otimes x_n \in (\mathcal{T} \otimes \mathcal{T})^{\otimes n}$ , the operation  $\text{LR}^*$  satisfies

$$\partial(\text{LR}^*(x_1 \otimes \dots \otimes x_n)) = \sum_{i=1}^n \text{LR}^*(x_1 \otimes \dots \otimes \partial(x_i) \otimes \dots \otimes x_n)$$

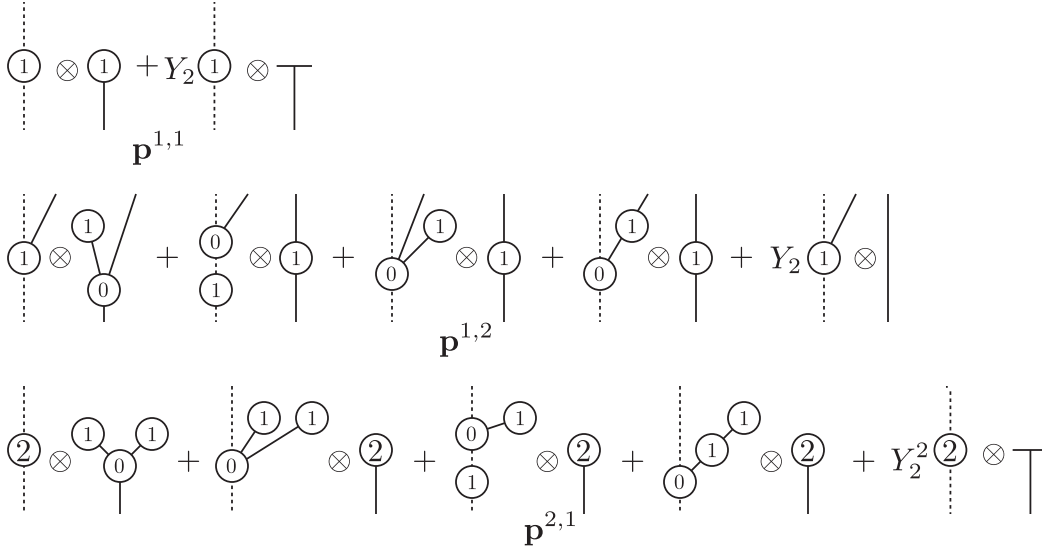

FIGURE 39. **Terms in a weighted module diagonal primitive.** The module diagonal primitive shown is compatible with  $\gamma^{n,w}$  from Figure 35 and the weight-0 module diagonal primitive in Figure 7. Top:  $\mathbf{p}^{1,1}$ . Middle:  $\mathbf{p}^{1,2}$ . Bottom:  $\mathbf{p}^{2,1}$ .

$$+ \sum_{j=0}^{n-1} \sum_{i=0}^{n-j} \text{LR}^*(x_1 \otimes \cdots \otimes x_i \otimes \text{LR}^*(x_{i+1} \otimes \cdots \otimes x_{i+j}) \otimes x_{i+j+1} \otimes \cdots \otimes x_n).$$

The operation  $\circ'$  satisfies  $\partial(x \circ' y) = \partial(x) \circ' y + x \circ' \partial(y)$ . Finally,

$$\text{LR}^*(x_1 \otimes \cdots \otimes x_n) \circ' y = \sum_{i=1}^n \text{LR}^*(x_1, \dots, x_{i-1}, x_i \circ' y, x_{i+1}, \dots, x_n).$$

*Proof.* The proof is straightforward. □

Note that, by definition,  $\text{LR}^*(\ ) \circ' y = 0$ .

Proposition 1.8 has the following generalization to the weighted case.

**Proposition 6.34.** *For any weighted algebra diagonal,  $\gamma^{*,*}$ , there exists a compatible weighted module diagonal primitive  $\mathbf{p}^{*,*}$ .*

*Proof.* For fixed  $w$  and  $n$ , Equation (6.32) expresses  $\partial \mathbf{p}^{n,w}$  in terms of elements  $\mathbf{p}^{n',w'}$  with  $w' < w$  or  $w = w'$  and  $n' < n$ . Moreover, if each  $\mathbf{p}^{n',w'}$  with  $w' < w$  or  $w = w'$  and  $n' < n$  is contained in grading  $n' + 2w' - 2$ , then the right hand side of Equation (6.32) is contained in grading  $n + 2w - 3$ . This is true because if  $x_1, \dots, x_m$  is a sequence of pairs of trees with  $x_i \in Y_1^{w_i - u_i} Y_2^{w_i - v_i} X M_*^{n_i, u_i} \otimes X_*^{n_i - 1, v_i}$  with grading  $n_i + 2w_i - 2$ , then

$$\text{LR}^*(x_1, \dots, x_m) \in \prod_{s=0}^{\infty} Y_1^{w-u+s} Y_2^{w-v} X M_*^{n,u} \otimes X_*^{n-1, v+s},$$

where  $n = 1 - m + \sum_{i=1}^m n_i$ ,  $u = \sum_{i=1}^m u_i$ , and  $v = \sum_{i=1}^m v_i$ , and the grading of  $\text{LR}^*(x_1, \dots, x_m)$  is

$$2s + m - 2 + \sum_{i=1}^m (n_i + 2w_i - 2) = n - 3 + 2s + 2 \sum_{i=1}^m w_i = \text{gr}(\mathbf{p}^{n,w}) - 1$$

(where  $w = s + \sum w_i$ ).

Thus, we can prove the existence of  $\mathbf{p}^{n,w}$  by induction first on  $w$  and then, for each  $w$ , on  $n$ .

The base case  $w = 0$  is an unweighted module diagonal primitive, which was shown to exist in Proposition 1.8. Now, fix  $w > 0$  and suppose that  $\mathbf{p}^{n,w}$  has been constructed for all  $w' < w$ . Consider

first the base cases when  $n + 2w - 2 \in \{0, 1\}$ , i.e.,  $(n, w) \in \{(2, 0), (3, 0), (1, 1)\}$ ; the first is specified in the non-degeneracy condition, the second in Figure 7, and the third in Figure 39.

For the inductive step on  $n$ , the structure equation for  $\mathbf{p}^{n,w}$  and Lemma 6.33 ensure that

$$\partial(\mathrm{LR}^*((\mathbf{p}^{*,*})^{\otimes \bullet}) + \mathbf{p}^{*,*} \circ' \gamma^{*,*})^{n,w} = 0.$$

Since this cycle has dimension  $n + 2w - 2$  with  $n, w \geq 1$ , Theorems 5.2 and 5.4 guarantees that there is an element  $\mathbf{p}^{n,w}$  with

$$\partial \mathbf{p}^{n,w} = (\mathrm{LR}^*((\mathbf{p}^{*,*})^{\otimes \bullet}) + \mathbf{p}^{*,*} \circ' \gamma^{*,*})^{w,n},$$

as needed.  $\square$

To construct weighted module diagonals from primitives, we use the following generalization of  $\mathrm{LR}'$  to the weighted case. For all  $k \geq 0$ , define

(6.35)

$$\mathrm{LR}'^w((S_1, T_1), \dots, (S_k, T_k)) = \mathrm{LeJ}(S_1, \dots, S_k) \otimes \mathrm{RoJ}^w(\downarrow, T_1, \dots, T_k)$$

(6.36)

$$\begin{aligned} \mathrm{LR}'^*(((S_1, T_1), \dots, (S_k, T_k))) &= \mathrm{LeJ}(S_1, \dots, S_k) \otimes \mathrm{RoJ}^*(\downarrow, T_1, \dots, T_k) \\ &= \sum_w \mathrm{LR}'^w((S_1, T_1), \dots, (S_k, T_k)) \in \widehat{XM}_*^{*,*} \otimes \widehat{XM}_*^{*,*} \otimes R[[Y_1, Y_2]], \end{aligned}$$

with the understanding that, for the case  $k = 0$ ,

$$\mathrm{RoJ}^*(\downarrow) = \sum_{w=1}^{\infty} Y_1^w \Psi_1^w \in XM_*^{*,*} \otimes R[[Y_1]],$$

and therefore

$$\mathrm{LR}'^*(\downarrow) = \sum_{w=1}^{\infty} Y_1^w (\downarrow \otimes \Psi_1^w) \in \widehat{XM}_*^{*,*} \otimes XM_*^{*,*} \otimes R[[Y_2]].$$

We generalize Lemma 2.36.

**Lemma 6.37.** *Given  $x_1 \otimes \dots \otimes x_n \in (XM_*^{*,*} \otimes X_*^{*,*})^{\otimes n}$ , the operation  $\mathrm{LR}'^*$  satisfies*

$$\begin{aligned} \partial(\mathrm{LR}'^*(x_1 \otimes \dots \otimes x_n)) &= \sum_{i=1}^n \mathrm{LR}'^*(x_1 \otimes \dots \otimes \partial(x_i) \otimes \dots \otimes x_n) \\ &\quad + \sum_{i=0}^n \mathrm{LR}'^*(x_1 \otimes \dots \otimes x_i) \circ_1 \mathrm{LR}'^*(x_{i+1} \otimes \dots \otimes x_n) \\ &\quad + \sum_{j=0}^n \sum_{i=0}^{n-j} \mathrm{LR}'^*(x_1 \otimes \dots \otimes \mathrm{LR}^*(x_{i+1} \otimes \dots \otimes x_{i+j}) \otimes \dots \otimes x_n). \end{aligned}$$

*Proof.* The proof is straightforward.  $\square$

The above formulas give the recipe for constructing weighted module diagrams from their primitives:

**Lemma 6.38.** *Given a collection of weighted diagonal cells  $\gamma^{n,w}$ , a compatible module diagonal primitive  $\mathbf{p}^{*,*}$  gives rise to a module diagonal compatible with  $\mathbf{\Gamma}^{*,*}$  by the formula*

$$\mathbf{m}^{n,w} = \sum_{\substack{v+w_1+\dots+w_k=w \\ n_1+\dots+n_k=n+k-1}} \mathrm{LR}'^v(\mathbf{p}^{n_1,w_1} \otimes \dots \otimes \mathbf{p}^{n_k,w_k})$$

or, more succinctly,

$$\mathbf{m}^{*,*} = \mathrm{LR}'^*((\mathbf{p}^{*,*})^{\otimes \bullet}).$$

*Proof.* This is an immediate consequence of the structure equations and Lemma 6.37.  $\square$

**6.6. Weighted module-map diagonals.** Consider the weighted module transformation trees complex  $JM_*^{n,w}$ . There are chain maps

$$\begin{aligned} \chi_{i,j,n;v,w}: X_*^{n+i-j,w} \otimes JM_*^{j-i+1,v} &\rightarrow JM_*^{n,v+w} & i > 1 \\ \chi_{i,j,n;v,w}: XM_*^{n+i-j,w} \otimes JM_*^{j-i+1,v} &\rightarrow JM_*^{n,v+w} & i = 1 \end{aligned}$$

given in both cases by  $(S, T) \mapsto T \circ_i S$ , and a map

$$\zeta_{j,n;v,w}: JM_*^{j,v} \otimes XM_*^{n+1-j,w} \rightarrow JM_*^{n,v+w}$$

given by  $(S, T) \mapsto T \circ_1 S$ . We extend these maps to the identity tree in  $\tilde{X}_*^{1,0}$  by declaring that the composition of a purple vertex with the identity tree (in any way) is the original purple vertex, and to stumps in  $\tilde{X}_*^{0,0}$  by declaring that the composition of a purple vertex with a stump is 0.

**Definition 6.39.** Fix a weighted algebra diagonal  $\Gamma^{*,*}$  and weighted module diagonals  $\mathbf{M}_1^{*,*}$  and  $\mathbf{M}_2^{*,*}$  compatible with  $\Gamma^{*,*}$ . A weighted module-map diagonal compatible with  $\mathbf{M}_1^{*,*}$  and  $\mathbf{M}_2^{*,*}$  is a collection of chain maps

$$\mathbf{L}^{n,w}: JM_*^{n,w} \rightarrow \bigoplus_{w_1, w_2 \leq w} JM_*^{n, w_1} \otimes JM_*^{n, w_2} \otimes R[Y_1, Y_2]$$

satisfying the following conditions:

- **Dimension homogeneity:** The map  $\mathbf{L}^{n,w}$  is dimension-preserving, i.e.,

$$\dim(\mathbf{L}^{n,w}(T)) = \dim(T).$$

- **Weight homogeneity:** The image of  $\mathbf{L}^{n,w}$  is contained in  $Y_1^{w-w_1} Y_2^{w-w_2} JM_*^{n, w_1} \otimes JM_*^{n, w_2}$ . In other words,

$$\text{wt}_1(\mathbf{L}^{n,w}(T)) = \text{wt}_2(\mathbf{L}^{n,w}(T)) = \text{wt}(T) = w.$$

- **Compatibility:**

$$\mathbf{L}^{n,v+w} \circ \chi_{i,j,n;v,w} = \begin{cases} \sum_{\substack{v_1+v_2 \leq v \\ w_1+w_2 \leq w}} (\chi_{1,j,n;v_1,w_1} \otimes \chi_{1,j,n;v_2,w_2}) \circ (\mathbf{M}_1^{j,v} \otimes \mathbf{L}^{n+1-j,w}) & i = 1 \\ \sum_{\substack{v_1+v_2 \leq v \\ w_1+w_2 \leq w}} (\chi_{i,j,n;v_1,w_1} \otimes \chi_{i,j,n;v_2,w_2}) \circ (\Gamma^{j-i+1,v} \otimes \mathbf{L}^{n+i-j,w}) & i > 1 \end{cases}$$

and

$$\mathbf{L}^{n,v+w} \circ \zeta_{j,n;v,w} = \sum_{\substack{v_1+v_2 \leq v \\ w_1+w_2 \leq w}} (\zeta_{j,n;v_1,w_1} \otimes \zeta_{j,n;v_2,w_2}) \circ (\mathbf{L}^{n+1-j,w} \otimes \mathbf{M}_2^{j,v}).$$

- **Non-degeneracy:**  $\mathbf{L}^{1,0}(\mathfrak{p}\Psi_1^0) = \mathfrak{p}\Psi_1^0 \otimes \mathfrak{p}\Psi_1^0$ .

Equivalently, we can view  $\mathbf{L}^{n,w}$  as a formal linear combination of pairs of weighted module transformation trees  $\ell^{n,w}$  of dimension  $n-1+2w$  (i.e., a weighted module-map tree diagonal)

$$\ell^{n,w} = \mathbf{L}^{n,w}(\Psi_n^w) \in \bigoplus_{w_1, w_2 \leq w} Y_1^{w-w_1} Y_2^{w-w_2} JM_*^{n, w_1} \otimes JM_*^{n, w_2}.$$

These trees must satisfy:

- **Compatibility:**

$$\partial(\ell^{n,w}) = \sum_{w_1+w_2=w} \sum_{k+\ell=n+1} \left( \ell^{k,w_1} \circ_1 \mathbf{m}_1^{\ell,w_2} + \mathbf{m}_2^{k,w_1} \circ_1 \ell^{\ell,w_2} + \sum_{i=2}^{k+1} \ell^{k,w_1} \circ_i \gamma^{\ell,w_2} \right).$$

- **Non-degeneracy:**  $\ell^{1,0}$  is the (unique) pair of module transformation trees with one input.

See Figure 40 for the first weight-1 term in a particular weighted module-map diagonal.



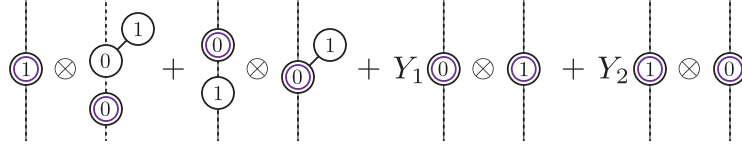

FIGURE 40. **A weighted module-map diagonal.** The figure shows a choice for  $\ell^{1,1}$  compatible with the weighted module diagonal from Figure 38, and extending the weight-0 case from Figure 12.

**Definition 6.40.** Given weighted module-map tree diagonals  $\ell_1^{n,w}$  and  $\ell_2^{n,w}$ , a homotopy from  $\ell_1^{n,w}$  to  $\ell_2^{n,w}$  is a collection of chains

$$\eta^{n,w} \in \bigoplus_{w_1, w_2 \leq w} Y_1^{w-w_1} Y_2^{w-w_2} JM_*^{n,w_1} \otimes JM_*^{n,w_2},$$

$n \geq 1$ ,  $w \geq 0$ , satisfying

$$\ell_2^{n,w} - \ell_1^{n,w} = \partial(\eta^{n,w}) + \sum_{\substack{n_1+n_2=n+1 \\ w_1+w_2=w}} \left( \eta^{n_1,w_1} \circ_1 \mathbf{m}_1^{n_2,w_2} + \mathbf{m}_2^{n_1,w_1} \circ_1 \eta^{n_2,w_2} + \sum_{i=2}^{n_1} \eta^{n_1,w_1} \circ_i \gamma^{n_2,w_2} \right)$$

for each  $n, w$ .

We have the following analogue of Lemma 2.49 and Proposition 2.54:

**Lemma 6.41.** Given any weighted algebra diagonal  $\gamma^{*,*}$  and weighted module diagonals  $\mathbf{m}_1^{*,*}$  and  $\mathbf{m}_2^{*,*}$  compatible with  $\gamma^{*,*}$  there is a weighted module-map diagonal  $\mathbf{L}^{*,*}$  compatible with  $\mathbf{m}_1^{*,*}$  and  $\mathbf{m}_2^{*,*}$ . Further, all weighted module-map diagonals compatible with  $\mathbf{m}_1^{*,*}$  and  $\mathbf{m}_2^{*,*}$  are homotopic.

*Proof.* The inductive step in the proof is essentially the same as in the proofs of Lemma 2.49 and Proposition 2.54, using Proposition 5.6. Further, the base case is the same as in the unweighted case, since  $JM_*^{n,w}$  has trivial homology if  $w > 0$ .  $\square$

Note that the maps  $\text{LR}^*$  and  $\text{LR}'^*$  from Formulas (6.28) and (6.35) extend by the same formulas to give maps

$$\begin{aligned} \text{LR}^* &: (\widetilde{XM}_*^{*,*} \otimes \widetilde{X}_*^{*,*})^{\otimes \bullet} \otimes (JM_*^{*,*} \otimes \widetilde{X}_*^{*,*}) \otimes (\widetilde{XM}_*^{*,*} \otimes \widetilde{X}_*^{*,*})^{\otimes \bullet} [Y_1, Y_2] \rightarrow (JM_*^{*,*} \otimes \widetilde{X}_*^{*,*}) [Y_1, Y_2] \\ \text{LR}'^* &: (\widetilde{XM}_*^{*,*} \otimes \widetilde{X}_*^{*,*})^{\otimes \bullet} \otimes (JM_*^{*,*} \otimes \widetilde{X}_*^{*,*}) \otimes (\widetilde{XM}_*^{*,*} \otimes \widetilde{X}_*^{*,*})^{\otimes \bullet} [Y_1, Y_2] \rightarrow (JM_*^{*,*} \otimes \widetilde{XM}_*^{*,*}) [Y_1, Y_2]. \end{aligned}$$

We can compose  $\text{LR}'^*((S_1, T_1), \dots, (S_k, T_k))$  with  $\downarrow \otimes \mathbf{p}\Psi_1^0$  to obtain a tensor product of two weighted module transformation trees; see Lemma 6.53.

**Definition 6.42.** Fix a weighted algebra diagonal  $\gamma^{*,*}$  and two weighted module diagonal primitives  $\mathbf{p}_1^{*,*}$  and  $\mathbf{p}_2^{*,*}$  compatible with  $\gamma^{*,*}$ . A weighted module-map primitive compatible with  $\mathbf{p}_1^{*,*}$  and  $\mathbf{p}_2^{*,*}$  consists of chains

$$(6.43) \quad \mathbf{q}^{n,w} \in \bigoplus_{w_1, w_2 \leq w} Y_1^{w-w_1} Y_2^{w-w_2} (JM_*^{n,w_1} \otimes \widetilde{X}_*^{n,w_2})$$

of dimension  $n + 2w - 1$ , for each  $n \geq 1$ ,  $w \geq 0$ . These chains are required to satisfy the following conditions:

• **Compatibility:**

$$(6.44) \quad \partial \mathbf{q}^{n,w} = \sum_{\substack{v+w_1+\dots+w_k=w \\ n_1+\dots+n_k=n+k-1 \\ i,k}} \text{LR}^*(\mathbf{p}^{n_1,w_1} \otimes \dots \otimes \mathbf{p}^{n_{i-1},w_{i-1}} \otimes \mathbf{q}^{n_i,w_i} \otimes \mathbf{p}^{n_{i+1},w_{i+1}} \otimes \dots \otimes \mathbf{p}^{n_k,w_k}) + \sum_{\substack{w_1+w_2=w \\ n_1+n_2=n+1}} \mathbf{q}^{n_1,w_1} \circ' \gamma^{n_2,w_2}$$

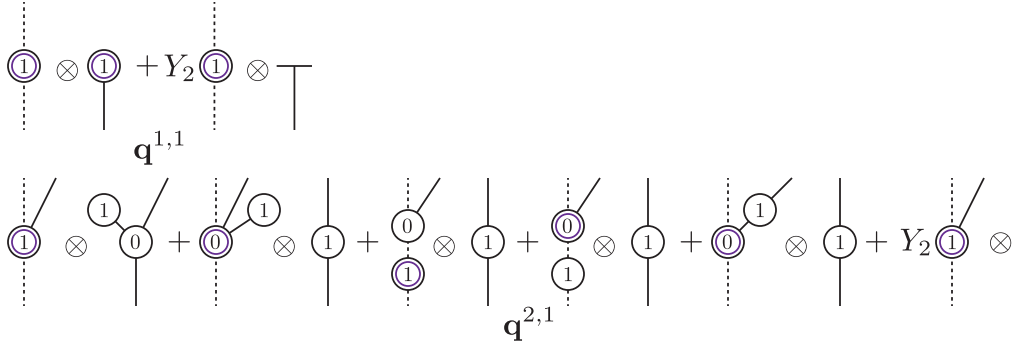

FIGURE 41. **A weighted module-map primitive.** The terms  $\mathbf{q}^{1,1}$  and  $\mathbf{q}^{2,1}$  are shown; the weight-0 terms are as in Figure 13. This weighted module-map primitive is compatible with the weighted module primitive in Figure 39 (on both sides).

or, more succinctly,

$$(6.45) \quad \partial \mathbf{q}^{*,*} = \text{LR}^*((\mathbf{p}_1^{*,*})^{\otimes \bullet} \otimes \mathbf{q}^{*,*} \otimes (\mathbf{p}_2^{*,*})^{\otimes \bullet}) + \mathbf{q}^{*,*} \circ' \gamma^{*,*}.$$

- **Non-degeneracy:**  $\mathbf{q}^{1,0}$  is the tensor product of the 1-input, weight 0 module transformation tree (with one internal vertex) and the stump, i.e.,

$$\mathbf{q}^{1,0} = \mathbf{p}\Psi_1^0 \otimes \top.$$

The first few terms in a particular weighted module-map primitive are shown in Figure 41.

**Definition 6.46.** Weighted module-map primitives  $\mathbf{q}_a^{n,w}$  and  $\mathbf{q}_b^{n,w}$  compatible with weighted module diagonal primitives  $\mathbf{p}_1^{*,*}$  and  $\mathbf{p}_2^{*,*}$  are homotopic if there is a collection of pairs of trees

$$\xi^{n,w} \in \bigoplus_{w_1, w_2 \leq w} Y_1^{w-w_1} Y_2^{w-w_2} (JM_*^{n,w_1} \otimes \tilde{X}_*^{n,w_2})$$

so that

$$\partial \xi^{*,*} + \text{LR}^*((\mathbf{p}_1^{*,*})^{\otimes \bullet} \otimes \xi^{*,*} \otimes (\mathbf{p}_2^{*,*})^{\otimes \bullet}) + \xi^{*,*} \circ' \gamma^{*,*} = \mathbf{q}_1^{*,*} - \mathbf{q}_2^{*,*}.$$

We have the following analogue of Lemmas 2.58 Proposition 2.60:

**Lemma 6.47.** Given any weighted algebra diagonal  $\Gamma^{n,w}$  and module diagonal primitives  $\mathbf{p}_1^{n,w}$  and  $\mathbf{p}_2^{n,w}$  compatible with  $\Gamma^{n,w}$  there is a weighted module-map primitive  $\mathbf{q}^{n,w}$  compatible with  $\mathbf{p}_1^{n,w}$  and  $\mathbf{p}_2^{n,w}$ , and all weighted module-map primitives compatible with  $\mathbf{p}_1^{n,w}$  and  $\mathbf{p}_2^{n,w}$  are homotopic.

*Proof.* The proof is similar to the proofs of Lemma 2.58 and Proposition 2.60 and is left to the reader.  $\square$

As in the unweighted case, it will be useful to describe one particular class of weighted module-map primitives:

**Lemma 6.48.** Let  $\mathbf{p}^{*,*}$  be a weighted module diagonal primitive. Let  $\mathbf{q}^{1,0} = \Psi_1^0 \otimes \top$  and for  $n \geq 2$  or  $w \geq 1$ , let  $\mathbf{q}^{n,w}$  be the sum over  $(S, T)$  in  $\mathbf{p}^{n,w}$  of all pairs  $(S', T)$  where  $S'$  is obtained from  $S$  by making one vertex on the leftmost strand of  $S$  distinguished (purple). Then  $\mathbf{q}^{*,*}$  is a module-map primitive compatible with  $\mathbf{p}^{*,*}$  and  $\mathbf{p}^{*,*}$ .

*Proof.* This is the same as the proof of Lemma 2.61, with the amendment that in cases (2) and (3) in that proof, the distinguished vertex is 2-valent and has weight 0.  $\square$

Next we discuss the relationship between weighted module-map primitives and weighted module-map diagonals. As in the unweighted case, this relationship is through partial module-map diagonals.

**Definition 6.49.** Let  $\mathcal{F}_{\neq(2,0)} JM_*^{n,w} \subset JM_*^{n,w}$  denote the subspace spanned by trees where the distinguished (purple) vertex has either weight  $> 0$  or valence  $> 2$ . Let

$$gJM_*^{n,w} = JM_*^{n,w} / (\mathcal{F}_{\neq(2,0)} JM_*^{n,w} + \partial(\mathcal{F}_{\neq(2,0)} JM_{*+1}^{n,w})).$$

A partial weighted module-map diagonal consists of elements

$$\mathbf{k}^{n,w} \in \bigoplus_{w_1, w_2 \leq w} Y_1^{w-w_1} Y_2^{w-w_2} JM_*^{n,w_1} \otimes gJM_*^{n,w_2}$$

of dimension  $n - 1 + 2w$  satisfying

- **Compatibility:**

$$\begin{aligned} \partial(\mathbf{k}^{n,w}) - \sum_{\substack{w_1+w_2=w \\ k+\ell=n+1}} \left( \mathbf{k}^{k,w_1} \circ_1 \mathbf{m}_1^{\ell,w_2} + \mathbf{m}_2^{k,w_1} \circ_1 \mathbf{k}^{\ell,w_2} + \sum_{i=2}^{k+1} \mathbf{k}^{k,w_1} \circ_i \gamma^{\ell,w_2} \right) &= 0 \\ &\in \bigoplus_{w_1, w_2 \leq w} Y_1^{w-w_1} Y_2^{w-w_2} JM_*^{n,w_1} \otimes gJM_*^{n,w_2}. \end{aligned}$$

- **Non-degeneracy:**  $\mathbf{k}^{1,0}$  is the (unique) pair of module transformation trees with one input and weight 0.

Partial weighted module-map diagonals  $\mathbf{k}_1^{*,*}$  and  $\mathbf{k}_2^{*,*}$  are homotopic if there is a collection of elements  $\zeta^{n,w} \in \bigoplus_{i+j=n-1} JM_*^{n,w} \otimes \mathcal{F}_{\leq 2} JM_*^{n,w}$  satisfying

$$\begin{aligned} (6.50) \quad \partial(\zeta^{n,w}) - \sum_{\substack{w_1+w_2=w \\ k+\ell=n+1}} \left( \zeta^{k,w_1} \circ_1 \mathbf{m}_1^{\ell,w_2} + \mathbf{m}_2^{k,w_1} \circ_1 \zeta^{\ell,w_2} + \sum_{i=2}^{k+1} \zeta^{k,w_1} \circ_i \gamma^{\ell,w_2} \right) + \mathbf{k}_1^{n,w} - \mathbf{k}_2^{n,w} &= 0 \\ &\in \bigoplus_{w_1, w_2 \leq w} Y_1^{w-w_1} Y_2^{w-w_2} JM_*^{n,w_1} \otimes gJM_*^{n,w_2}. \end{aligned}$$

Explicitly,  $gJM_*^{n,w}$  is spanned by weighted module transformation trees where the purple vertex is 2-valent and has weight 0, and if two trees differ only in the location of the purple vertex they are equivalent in  $gJM_*^{n,w}$ .

As in the unweighted case, given a module-map diagonal  $\ell^{*,*}$ , the image  $\mathbf{k}^{*,*}$  of  $\ell^{*,*}$  under the quotient map

$$JM_*^{*,*} \otimes JM_*^{*,*} \rightarrow JM_*^{*,*} \otimes gJM_*^{*,*}$$

is a partial weighted module-map diagonal. In this case, we say that  $\ell^{*,*}$  is a module-map diagonal extending  $\mathbf{k}^{*,*}$ .

**Lemma 6.51.** *The complex  $gJM_*^{n,w}$  is contractible if  $w = 0$  (i.e., has homology  $R$  in dimension 0 and 0 in all other dimensions) and is acyclic if  $w > 0$  (i.e., has trivial homology).*

*Proof.* Forgetting the purple vertex gives an isomorphism between  $gJM_*^{n,w}$  and the module trees complex  $XM_*^{n,w}$ , so the result follows from Theorem 5.4.  $\square$

**Lemma 6.52.** *All partial weighted module-map diagonals compatible with  $\mathbf{m}_1^{*,*}$  and  $\mathbf{m}_2^{*,*}$  are homotopic.*

*Proof.* The proof is essentially the same as the proof of Lemma 2.67. As there, we build the maps  $\zeta^{n,w}$  inductively, now inducting on  $w$  first and then  $n$ . By the non-degeneracy condition, we can take  $\zeta^{1,0} = 0$ . For the inductive step one verifies that

$$\sum_{\substack{w_1+w_2=w \\ k+\ell=n+1}} \left( \zeta^{k,w_1} \circ_1 \mathbf{m}_1^{\ell,w_2} + \mathbf{m}_2^{k,w_1} \circ_1 \zeta^{\ell,w_2} + \sum_{i=2}^{k+1} \zeta^{k,w_1} \circ_i \gamma^{\ell,w_2} \right) + \mathbf{k}_1^{n,w} - \mathbf{k}_2^{n,w}$$

is a cycle in  $\bigoplus_{w_1, w_2 \leq w} Y_1^{w-w_1} Y_2^{w-w_2} JM_*^{n,w_1} \otimes gJM_*^{n,w_2}$  so, by Lemma 6.51, is also the boundary of some  $\zeta^{n,w}$ .  $\square$

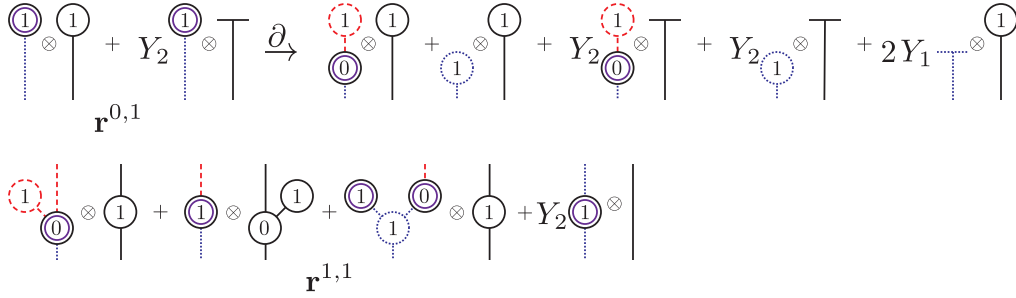

FIGURE 42. **Weighted DADD diagonals.** Top: the element  $\mathbf{r}^{0,1}$  and its differential, which is the base case in Lemma 6.56. (Recall that we are working in characteristic 2.) Bottom: one option for the element  $\mathbf{r}^{1,1}$ , compatible with the weighted diagonal from Figure 35.

**Lemma 6.53.** *Given an associahedron tree diagonal, compatible module diagonal primitives  $\mathbf{p}_1^{*,*}$  and  $\mathbf{p}_2^{*,*}$ , and a compatible module-map primitive  $\mathbf{q}^{*,*}$ ,*

$$(6.54) \quad \mathbf{k}^{*,*} = [\downarrow \otimes \mathbf{p}\Psi_1^0] \circ \text{LR}'((\mathbf{p}_1^{*,*})^{\otimes \bullet} \otimes \mathbf{q}^{*,*} \otimes (\mathbf{p}_2^{*,*})^{\otimes \bullet})$$

*is a partial weighted module-map diagonal compatible with  $\mathbf{m}_1^{*,*} = \text{LR}'((\mathbf{p}_1^{*,*})^{\otimes \bullet})$  and  $\mathbf{m}_2^{*,*} = \text{LR}'((\mathbf{p}_2^{*,*})^{\otimes \bullet})$ .*

*Proof.* The proof is the same as the proof of Lemma 2.70.  $\square$

**6.7. Weighted DADD diagonals.** In this section, we define the weighted analogue of DADD diagonals (Section 2.8). In this paper, we do not discuss weighted type *DA* structures, so this section does not have an algebraic application in this paper, but we include it for completeness.

**Definition 6.55.** *Fix weighted algebra diagonals  $\gamma_1^{*,*}$  and  $\gamma_2^{*,*}$ . A DADD diagonal compatible with  $\gamma_1^{*,*}$  and  $\gamma_2^{*,*}$  is a collection of elements*

$$\mathbf{r}^{n,w} \in \bigoplus_{w_1+w_2 \leq w} Y_1^{w-w_1} Y_2^{w-w_2} (J_*^{n,w_1} \otimes \tilde{X}_*^{n,w_2})$$

*in dimension  $n-1+2w$ , satisfying the following conditions:*

- **Compatibility:**

$$\partial(\mathbf{r}^{n,w}) = \sum_{\substack{k+\ell=n+1 \\ u+v=w}} \mathbf{r}^{k,u} \circ \gamma_1^{\ell,v} + \sum_{\substack{j_1+\dots+j_k=n \\ u+v_1+\dots+v_k=w}} \gamma_2^{u,k} \circ (\mathbf{r}^{j_1,v_1}, \dots, \mathbf{r}^{j_k,v_k}).$$

- **Non-degeneracy:**  $\mathbf{r}^{1,0} = \mathbf{p}\Psi_1^0 \otimes \downarrow$ , the tensor product of a 1-input purple corolla and the identity tree.

Schematically, the compatibility condition is the same as Equation (2.75), except that the weight is distributed among all the vertices.

**Lemma 6.56.** *Given any weighted algebra diagonals there is a compatible weighted DADD diagonal.*

*Proof.* As in the unweighted case (Lemma 2.76), since the associahedron and multiplihedron are contractible, it suffices to verify:

- (1) The right hand side of the compatibility equation is a cycle.
- (2) Solutions to the compatibility equation exist when the right side is in dimension 0.

The first statement is clear. For the second, we need to check the cases  $(n, w) \in \{(1, 0), (2, 0), (0, 1)\}$ . The first two cases are the same as the unweighted case. The third case is shown in Figure 42 (along with the next term in a particular weighted DADD diagonal).  $\square$

### 6.8. Homotopy unital diagonals.

**Definition 6.57.** A homotopy unital algebra diagonal consists of chain maps

$$u\Gamma^{n,w}: uX_*^{n,w} \rightarrow \bigoplus_{w_1, w_2 \leq w} uX_*^{n,w_1} \otimes uX_*^{n,w_2} \otimes R[Y_1, Y_2]$$

satisfying the dimension homogeneity, weight homogeneity, and compatibility under stacking conditions from Definition 6.4 and the non-degeneracy conditions:

$$\begin{aligned} u\Gamma^{0,0}(\top) &= \top \otimes \top \\ u\Gamma^{1,0}(\downarrow) &= \downarrow \otimes \downarrow \\ u\Gamma^{2,0}(\Psi_2^0) &= \Psi_2^0 \otimes \Psi_2^0. \end{aligned}$$

The seed of  $u\Gamma^{n,w}$  is  $u\Gamma^{0,1}(\Psi_0^1)$ , the image of the weight 1, 0-input corolla.

Let  $\Gamma^{n,w}$  be a weighted algebra diagonal. We say that  $u\Gamma^{n,w}$  extends  $\Gamma^{n,w}$  if  $\pi(u\Gamma^{n,w}(\Psi_n^w)) = \Gamma^{n,w}(\Psi_n^w)$  for each  $n, w$  with  $n + 2w \geq 2$ . (The map  $\pi: uX_*^{n,w} \rightarrow X_*^{n,w}$  is from Definition 5.7.)

Define a homotopy unital module diagonal  $u\mathbf{M}^{n,w}$  extending a weighted module diagonal similarly, using  $uXM_*^{n,w}$  in place of  $uX_*^{n,w}$  and Definition 6.19 in place of Definition 6.4, and the non-degeneracy conditions

$$\begin{aligned} u\Gamma^{1,0}(\downarrow) &= \downarrow \otimes \downarrow \\ u\Gamma^{2,0}(\Psi_2^0) &= \Psi_2^0 \otimes \Psi_2^0. \end{aligned}$$

We say that  $u\mathbf{M}^{n,w}$  extends  $\mathbf{M}^{n,w}$  if  $\pi(u\mathbf{M}^{n,w}(\Psi_n^w)) = \mathbf{M}^{n,w}(\Psi_n^w)$  for each  $n, w$  with  $n + 2w \geq 2$ .

Define a homotopy unital map diagonal  $u\Theta^{n,w}$  using  $uJ_*^{n,w}$  in place of  $uX_*^{n,w}$ , Definition 6.14 in place of Definition 6.4, and the non-degeneracy condition

$$u\Theta^{1,0}(\mathfrak{p}\Psi_1^0) = \mathfrak{p}\Psi_1^0 \otimes \mathfrak{p}\Psi_1^0.$$

The notion of a homotopy unital map diagonal extending an algebra map diagonal is defined similarly to the previous cases.

Define a homotopy unital module-map diagonal  $u\mathbf{L}^{n,w}$  similarly, using  $uJM_*^{n,w}$  in place of  $uX_*^{n,w}$ , Definition 6.39 in place of Definition 6.4, and the non-degeneracy condition

$$u\mathbf{L}^{1,0}(\mathfrak{p}\Psi_1^0) = \mathfrak{p}\Psi_1^0 \otimes \mathfrak{p}\Psi_1^0.$$

The notion of a homotopy unital module-map diagonal extending a module-map diagonal is defined similarly to the previous cases.

See Figures 43, 44, 45, and 46 for some terms in a homotopy unital algebra diagonal, homotopy unital module diagonal, homotopy unital map diagonal, and homotopy unital module map diagonal, respectively.

*Remark 6.58.* Notice that  $u\Gamma^{1,1}(\Psi_1^1)$  in Figure 43 includes trees with thorns, even though  $\Psi_1^1$  has no thorns. In particular, this suggests that, unlike the unweighted case, there is no sensible tensor product of non-unital weighted algebras (with maximal seed).

**Lemma 6.59.** Given a weighted algebra diagonal  $\Gamma^{n,w}$  there is a homotopy unital algebra diagonal  $u\Gamma^{n,w}$  extending  $\Gamma^{n,w}$ . Similar statements hold for module diagonals, map diagonals, and module-map diagonals.

*Proof.* To define  $u\Gamma^{n,w}$  we need to define the elements  $u\Gamma^{n,w}(\Psi_{n_1 \uparrow \dots \uparrow n_k}^w)$ . The non-degeneracy condition dictates the values  $u\Gamma^{0,0}(\top)$ ,  $u\Gamma^{1,0}(\downarrow)$ , and  $u\Gamma^{2,0}(\Psi_2^0)$ . Define the image of the weight 1, 0-input corolla to be

$$u\Gamma^{0,1}(\Psi_0^1) = \Gamma^{0,1}(\Psi_0^1),$$

viewed as a linear combination of pairs of thorn trees in the obvious way.

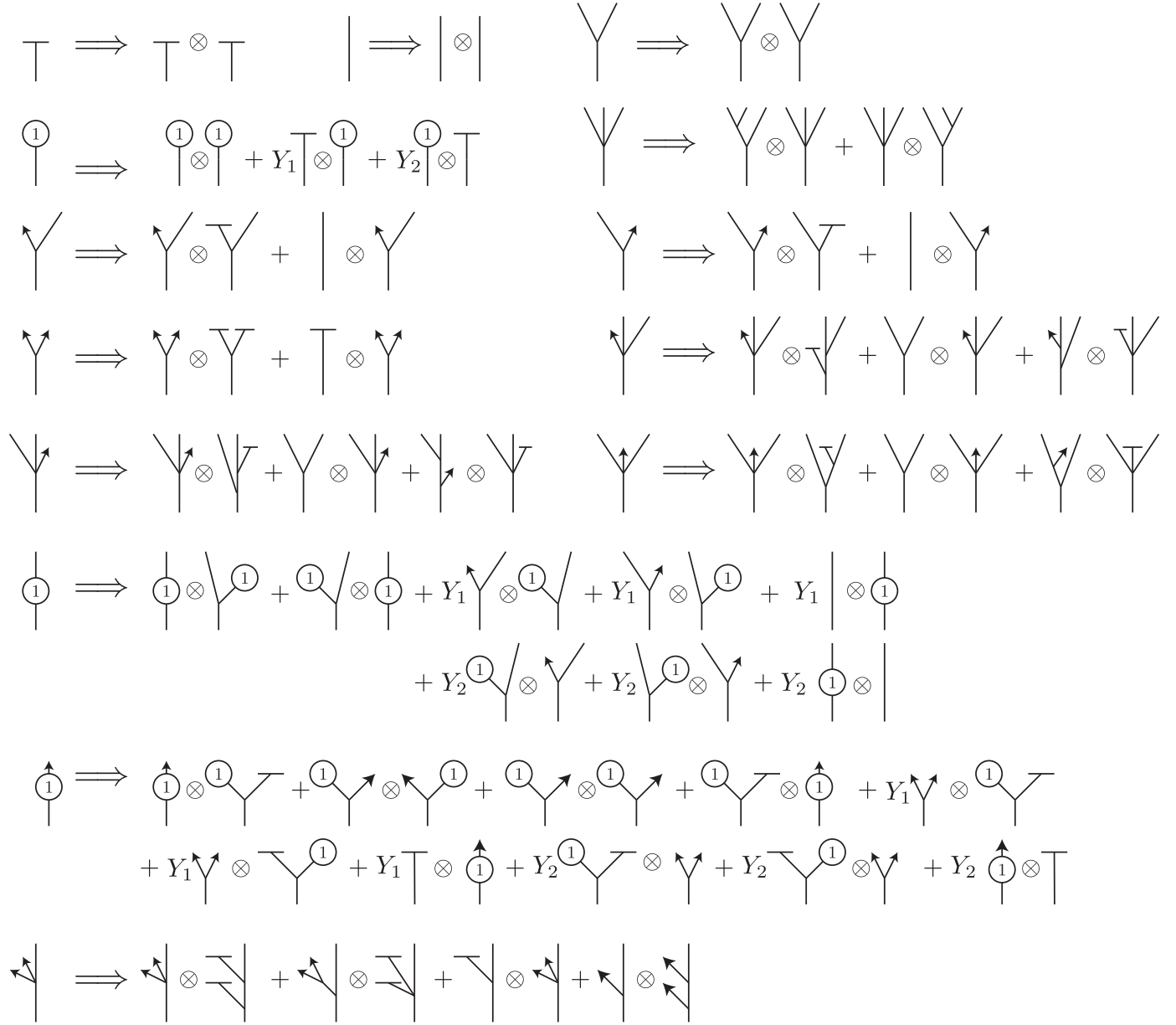

FIGURE 43. **Terms in a homotopy unital algebra diagonal.** Top row: the non-degeneracy conditions. Second row: (maximal) seed for the diagonal and base case for the inductive construction. Remaining rows: a few other terms in the diagonal. Throughout, unlabelled vertices have weight 0. This diagonal extends the diagonal  $\Gamma^{n,w}$  from Figures 3 and 35.

Next, we define  $u\Gamma^{n,w}(\Psi_n^w)$  by induction on  $(n, w)$ , as in the proof of Theorem 6.11. The base cases  $u\Gamma^{0,0}(\Psi_0^0)$ ,  $u\Gamma^{1,0}(\Psi_1^1)$ ,  $u\Gamma^{2,0}(\Psi_2^2)$  and  $u\Gamma^{0,1}(\Psi_0^1)$  have already been defined. The base cases  $u\Gamma^{3,0}(\Psi_3^0)$  and  $u\Gamma^{1,1}(\Psi_1^1)$  are shown in Figure 35. Now, suppose  $u\Gamma^{n,w}(\Psi_n^w)$  for  $w < W$  and for  $w = W$  and  $n < N$ , satisfying the compatibility condition  $\partial u\Gamma^{n,w}(\Psi_n^w) = u\Gamma^{n,w}(\partial\Psi_{n,\emptyset}^w)$  and the condition that  $\pi(u\Gamma^{n,w}(\Psi_n^w)) = \Gamma^{n,w}(\Psi_n^w)$  for  $w < W$  and for  $w = W$  and  $n < N$ . Observe that  $u\Gamma^{N,W}(\partial\Psi_N^W)$  is a cycle in dimension  $N + 2W - 3 > 0$ , and  $\pi(u\Gamma^{N,W}(\partial\Psi_N^W)) = \Gamma^{N,W}(\partial\Psi_N^W)$ .

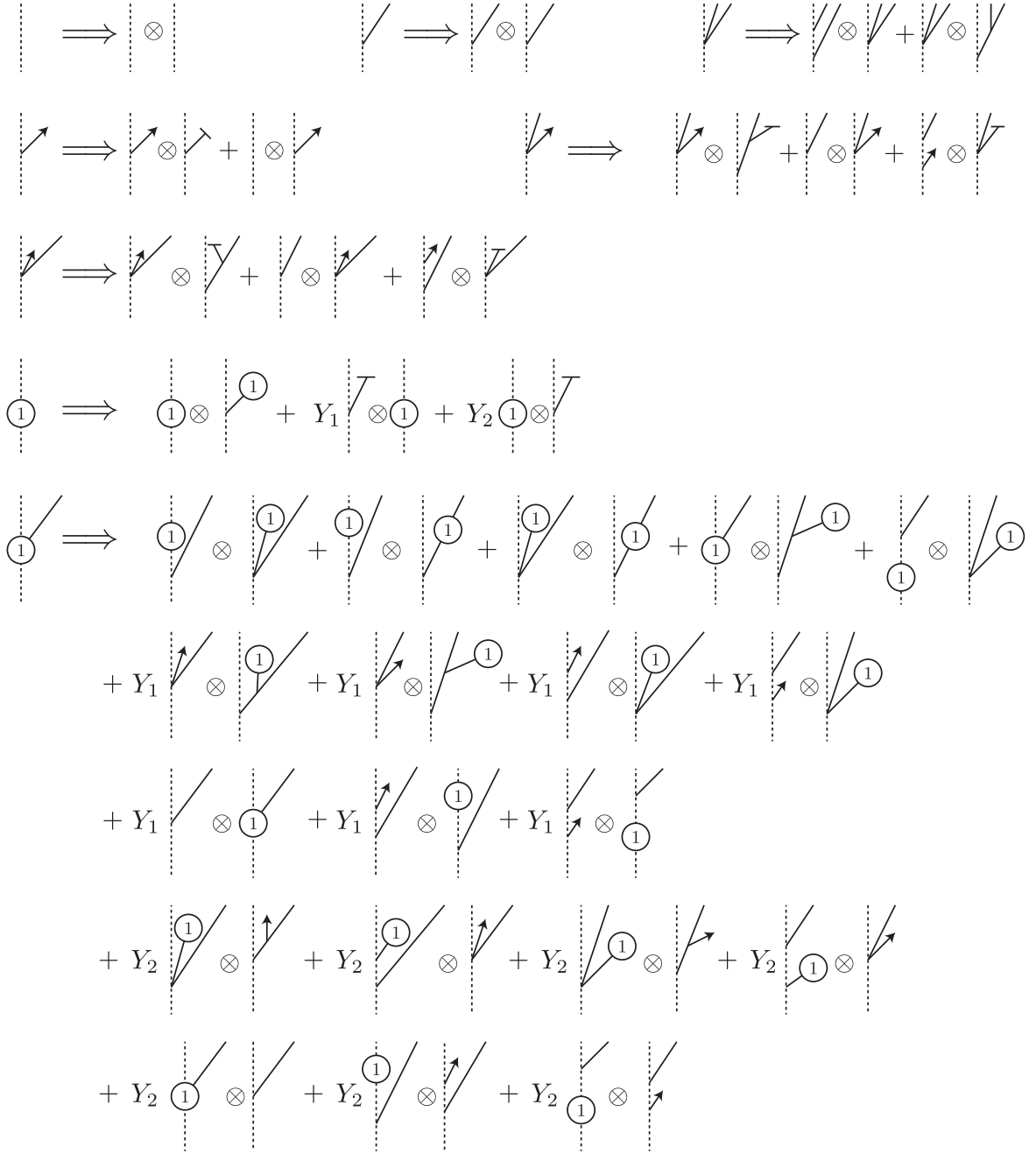

FIGURE 44. **Terms in a homotopy unital module diagonal.** Unlabelled vertices have weight 0. This diagonal extends the diagonal in Figures 3 and 38.

Since  $\pi$  is surjective, we can choose an element  $x \in \bigoplus_{w_1, w_2 \leq W} uX_*^{N, w_1} \otimes uX_*^{N, w_2} \otimes R[Y_1, Y_2]$  with  $\pi(x) = \mathbf{\Gamma}^{N, W}(\Psi_N^W)$ . Thus,

$$\pi(\partial x + u\mathbf{\Gamma}^{N, W}(\partial\Psi_N^W)) = 0$$

so, since  $\pi$  induces an isomorphism on homology,  $\partial x + u\mathbf{\Gamma}^{N, W}(\partial\Psi_N^W) = \partial y$  where  $\pi(y) = 0$ . Let  $u\mathbf{\Gamma}^{N, W}(\Psi_N^W) = x + y$  and continue the induction.

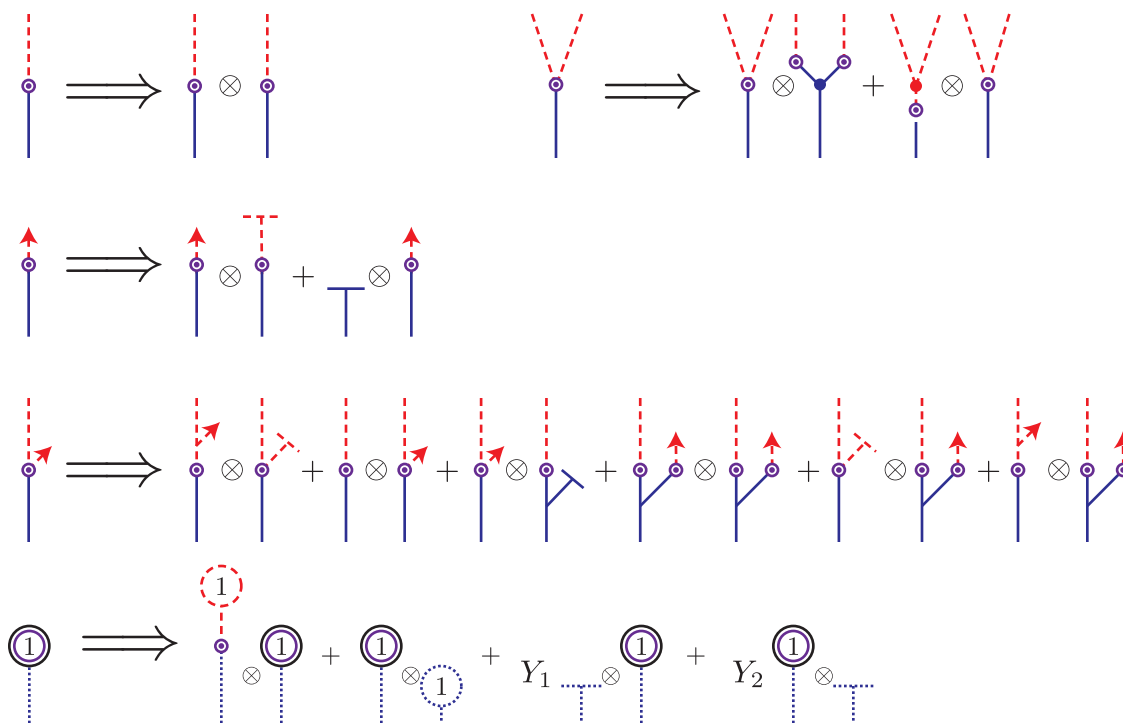

FIGURE 45. **Terms in a homotopy unital map diagonal.** Vertices not labelled by integers have weight 0. This diagonal extends the diagonal in Figures 10 and 37.

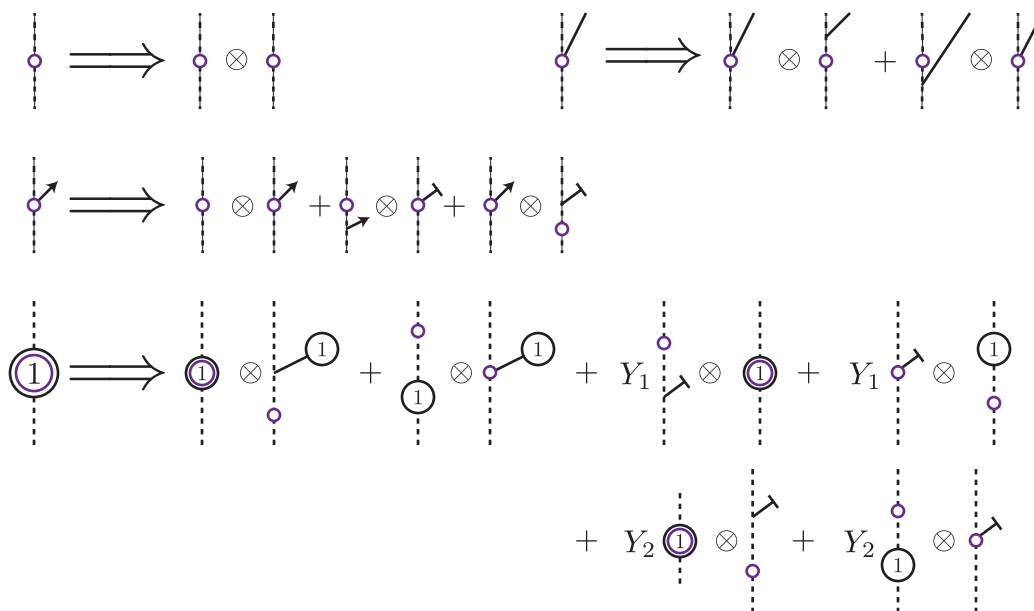

FIGURE 46. **Terms in a homotopy module-map diagonal.** The diagonal shown extends the diagonal from Figure 12. Vertices not labelled by integers have weight 0.



Finally, we perform induction on the number  $k - 1$  of thorns to define  $u\Gamma^{n,w}(\Psi_{n_1 \uparrow \dots \uparrow n_k}^w)$  for  $k > 1$ . Suppose we have defined  $u\Gamma^{n,w}(\Psi_{n_1 \uparrow \dots \uparrow n_k}^w)$  for  $k < K$  and for  $k = K$  if  $w < W$  or  $w = W$  and  $n < N$ . Then we have already defined  $u\Gamma^{n,w}(\partial\Psi_{n_1 \uparrow \dots \uparrow n_k}^w)$ . It is clear that  $u\Gamma^{n,w}(\partial\Psi_{n_1 \uparrow \dots \uparrow n_k}^w)$  is a cycle. There are several cases:

- $N = 2$ ,  $W = 0$ , and  $K = 2$ .
- $N = 0$ ,  $W = 1$ , and  $K = 2$ .
- $N + 2W = 0$  and  $K \geq 3$ .
- $N + 2W > 3$ .

In the first two cases, by inspection the class  $u\Gamma^{n,w}(\partial\Psi_{n_1 \uparrow \dots \uparrow n_K}^w)$  is a boundary; see Figure 43. In the last two cases, it follows from Theorem 5.8 that  $u\Gamma^{n,w}(\partial\Psi_{n_1 \uparrow \dots \uparrow n_K}^w)$  is a boundary. So, in any case, choose  $u\Gamma^{n,w}(\Psi_{n_1 \uparrow \dots \uparrow n_K}^w)$  so that  $\partial u\Gamma^{n,w}(\Psi_{n_1 \uparrow \dots \uparrow n_K}^w) = u\Gamma^{n,w}(\partial\Psi_{n_1 \uparrow \dots \uparrow n_K}^w)$  and continue the induction.

This completes the construction of  $u\Gamma^{n,w}$ . The constructions of module diagonals, map diagonals, and module-map diagonals are similar. See Figures 44, 45, and 46 for some low-dimensional cases (including the base cases for the inductions).  $\square$

**Lemma 6.60.** *Given a homotopy unital algebra diagonal  $u\Gamma^{*,*}$  and two homotopy unital module diagonals  $u\mathbf{M}_1^{*,*}$  and  $u\mathbf{M}_2^{*,*}$  compatible with  $u\Gamma^{*,*}$ , all homotopy unital module-map diagonals with  $u\mathbf{M}_1^{*,*}$  and  $u\mathbf{M}_2^{*,*}$  are homotopic.*

*Proof.* The proof is the usual inductive argument, using Theorem 5.11, and is left to the reader.  $\square$

## 7. ALGEBRAIC APPLICATIONS OF WEIGHTED DIAGONALS

Weighted diagonals can be used to construct various tensor products.

**Convention 7.1.** *As in Sections 3 and 4 (Convention 3.1), fix a commutative  $\mathbb{F}_2$ -algebra  $R$  and commutative  $R$ -algebras  $\mathbb{k}_1$  and  $\mathbb{k}_2$  (and occasionally  $\mathbb{k}_3$ ). Throughout, we assume that the action of  $R$  on bimodules is central, i.e., if  $r \in R$  and  $a$  is an element of an  $R$ -bimodule then  $ra = ar$ .*

*Fix also elements  $Y_i \in \mathbb{k}_i$ . The elements  $Y_i$  make  $\mathbb{k}_i$  into a  $R[Y_i]$ -algebra. We assume that the elements  $Y_i$  also act centrally on  $\mathbb{k}_i$ -bimodules, i.e., if  $a$  is an element of a  $\mathbb{k}_i$ -bimodule then  $Y_i a = a Y_i$ .*

*We will typically let  $\mathbb{k} = \mathbb{k}_1 \otimes_R \mathbb{k}_2$ . Undecorated tensor products are over the appropriate ring  $\mathbb{k}_i$  or  $\mathbb{k}$ .*

The convention that the  $Y_i$  acts centrally implies that for a  $w$ -algebra  $\mathcal{A}$  over  $\mathbb{k}_1$ , say,

$$\mu_n^w(a_1, \dots, Y_1 a_k, \dots, a_n) = Y_1 \mu_n^w(a_1, \dots, a_k, \dots, a_n),$$

by repeatedly using the relation  $a_j Y_1 = Y_1 a_j$  and multi-linearity of the operation over  $\mathbb{k}_1$ . It does not imply that

$$\mu_2^0(a, Y_1) = \mu_2^0(Y_1, a)$$

unless  $\mathcal{A}$  is weakly unital.

**7.1. Tensor products of weighted algebras.** Fix ground rings  $\mathbb{k}_1$  and  $\mathbb{k}_2$  and let  $\mathbb{k} = \mathbb{k}_1 \otimes_R \mathbb{k}_2$ . Fix also integers  $\kappa_1, \kappa_2$ . Assume that the  $Y_i \in \mathbb{k}_i$  satisfy

$$\text{gr}(Y_i) = \kappa_i - 2.$$

(The grading  $\text{gr}(Y_i)$  should not be confused with the dimension  $\dim(Y_i) = 0$  or the weight  $\text{wt}_j(Y_i) = \delta_{i,j}$  from Section 6.)

Fix strictly unital weighted  $A_\infty$ -algebras  $\mathcal{A} = (A, \{\mu_n^w\})$  and  $\mathcal{B} = (B, \{\nu_n^w\})$  over  $\mathbb{k}_1$  and  $\mathbb{k}_2$ , with weight gradings  $\kappa_1$  and  $\kappa_2$ , respectively. Given a weighted algebra diagonal  $\Gamma^{*,*}$ , we will associate a weighted  $A_\infty$ -algebra  $\mathcal{A} \otimes_\Gamma \mathcal{B}$  over  $\mathbb{k}$  with weight grading  $\kappa_1 + \kappa_2 - 2$ .

By Lemma 4.12, the operations on  $\mathcal{A}$  (respectively  $\mathcal{B}$ ) induce chain maps  $\mu: X_*^{n,w} \rightarrow \text{Mor}(A^{\otimes n}, A\langle\langle(2-\kappa_1)w\rangle\rangle)$  (respectively  $\nu: X_*^{n,w} \rightarrow \text{Mor}(B^{\otimes n}, B\langle\langle(2-\kappa_2)w\rangle\rangle)$ ). We can extend these maps to  $\tilde{X}_*^{n,w}$  by declaring that  $\mu(\downarrow) = \mathbb{I}: A \rightarrow A$  and  $\mu(\tau) = 1 \in A$  (and similarly for  $\nu$ ).

**Lemma 7.2.** *If the algebra  $\mathcal{A}$  is strictly unital then the extension of  $\mu$  to  $\tilde{X}_*^{n,w}$  is a chain map and intertwines stacking of trees and composition of operations.*

*Proof.* The fact that the extension is a chain map follows from the fact that  $d(1) = 0$ . The fact that the extension to  $\downarrow$  is compatible under stacking is trivial. The fact that the extension to  $\tau$  is compatible with stacking follows from the fact that  $\mu_2^w(\mathbf{1}, a) = \mu_2^w(a, \mathbf{1}) = a$  and  $\mu_n^w(a_1, \dots, a_i, \mathbf{1}, a_{i+2}, \dots, a_n) = 0$  if  $(n, w) \neq (2, 0)$ .  $\square$

**Definition 7.3.** *Fix a weighted algebra diagonal*

$$\mathbf{\Gamma}^{n,w}: X_*^{n,w} \rightarrow \bigoplus_{w_1+w_2 \leq 2w} \tilde{X}_*^{n,w_1} \otimes_R \tilde{X}_*^{n,w_2} \otimes_R R[Y_1, Y_2].$$

*Fix also strictly unital weighted  $A_\infty$ -algebras  $\mathcal{A}$  and  $\mathcal{B}$  over  $\mathbb{k}_1$  and  $\mathbb{k}_2$ , respectively. Define maps*

$$(7.4) \quad (\mu \otimes_{\mathbf{\Gamma}} \nu): X_*^{n,w} \rightarrow \text{Mor}((A \otimes_R B)^{\otimes n}, A \otimes_R B\langle\langle(4-\kappa_1-\kappa_2)w\rangle\rangle)$$

*to be the composition  $(\mu \otimes \nu) \circ \mathbf{\Gamma}^{*,*}$ . Since  $\mathbf{\Gamma}^{*,*}$  is a collection of chain maps and is compatible under stacking, by Lemma 4.12 the operations induce a weighted  $A_\infty$ -algebra structure on  $\mathcal{A} \otimes_{\mathbf{\Gamma}} \mathcal{B}$  over  $\mathbb{k}$ . The induced weighted algebra is called the weighted tensor product via the diagonal  $\mathbf{\Gamma}^{*,*}$  of  $\mathcal{A}$  and  $\mathcal{B}$ . It is denoted  $\mathcal{A} \otimes_{\mathbf{\Gamma}} \mathcal{B}$ .*

**Lemma 7.5.** *The map  $\mu \otimes_{\mathbf{\Gamma}} \nu$  in Definition 7.3 does, in fact, shift the grading by  $(4-\kappa_1-\kappa_2)w$ , so  $\mathcal{A} \otimes_{\mathbf{\Gamma}} \mathcal{B}$  is a  $w$ -algebra with weight grading  $\kappa_{12} := \kappa_1 + \kappa_2 - 2$ . Further, if  $\mathcal{A}$  and  $\mathcal{B}$  are bonsai, so is  $\mathcal{A} \otimes_{\mathbf{\Gamma}} \mathcal{B}$ .*

*Proof.* Define three new gradings on  $X_*^{n,w}$  by:

$$\begin{aligned} \text{gr}_1(T) &= \dim(T) + (\kappa_1 - 2)w \\ \text{gr}_2(T) &= \dim(T) + (\kappa_2 - 2)w \\ \text{gr}_{12}(T) &= \dim(T) + (\kappa_1 + \kappa_2 - 4)w = \dim(T) + (\kappa_{12} - 2)w. \end{aligned}$$

If we grade  $X_*^{n,w}$  by  $\text{gr}_1$  then  $\mu: X_*^{n,w} \rightarrow \text{Mor}(A^{\otimes n}, A)$  is grading-preserving. Similarly, grading  $X_*^{n,w}$  by  $\text{gr}_2$ ,  $\nu$  is grading-preserving. We must check that, with respect to  $\text{gr}_{12}$ ,  $(\mu \otimes_{\mathbf{\Gamma}} \nu)$  is grading-preserving.

Since  $\mu \otimes_{\mathbf{\Gamma}} \nu$  is grading-preserving with respect to the grading  $\text{gr}_1 \otimes \text{gr}_2$  on  $\tilde{X}_*^{*,*} \otimes_R \tilde{X}_*^{*,*}$ , it suffices to show that  $\mathbf{\Gamma}^{*,*}$  is grading-preserving with respect to the grading  $\text{gr}_{12}$  on the source and  $\text{gr}_1 \otimes \text{gr}_2$  on the target. This is straightforward: given a term  $Y_1^a Y_2^b(T_1, T_2)$  in  $\mathbf{\Gamma}^{n,w}(S)$  we have

$$\begin{aligned} \text{gr}_{12}(\mathbf{\Gamma}^{n,w}(S)) &= \dim(\mathbf{\Gamma}^{n,w}(S)) + (\kappa_1 + \kappa_2 - 4)w \\ &= \dim(T_1) + \dim(T_2) + (\kappa_1 - 2) \text{wt}_1(Y_1^a T_1) + (\kappa_2 - 2) \text{wt}_2(Y_2^b T_2) \\ &= \text{gr}_1(Y_1^a T_1) + \text{gr}_2(Y_2^b T_2), \end{aligned}$$

as desired.

The statement about bonsai-ness follows from dimension homogeneity of the diagonal.  $\square$

The weight 1, 0-input operation on  $\mathcal{A} \otimes_{\mathbf{\Gamma}} \mathcal{B}$  depends on the seed  $\mathcal{S}$ . A term  $\Psi_0^1 \otimes \Psi_0^1$  in  $\mathcal{S}$  contributes  $\mu_0^1 \otimes \mu_0^1$  to  $(\mu \otimes_{\mathbf{\Gamma}} \nu)_0^1$ , and a term  $Y_1 \tau \otimes \Psi_0^1$  (respectively  $Y_2 \Psi_0^1 \otimes \tau$ ) contributes a copy of  $Y_1 \otimes \nu_0^1$  (respectively  $\mu_0^1 \otimes Y_2$ ).

**Definition 7.6.** *Fix:*

- Weighted algebra diagonals  $\mathbf{\Gamma}_1^{*,*}$  and  $\mathbf{\Gamma}_2^{*,*}$ ,
- A weighted map diagonal  $\Theta^{*,*}$  compatible with  $\mathbf{\Gamma}_1^{*,*}$  and  $\mathbf{\Gamma}_2^{*,*}$ ,

- Strictly unital weighted  $A_\infty$ -algebras  $\mathcal{A}_1, \mathcal{A}_2$  over  $\mathbb{k}_1$  with weight gradings  $\kappa_1,$
- Strictly unital weighted  $A_\infty$ -algebras  $\mathcal{B}_1, \mathcal{B}_2$  over  $\mathbb{k}_2$  with weight gradings  $\kappa_2,$  and
- Strictly unital weighted algebra homomorphisms  $f: \mathcal{A}_1 \rightarrow \mathcal{A}_2$  and  $g: \mathcal{B}_1 \rightarrow \mathcal{B}_2.$

The composition

$$\begin{aligned} J_*^{n,w} &\xrightarrow{\Theta^{n,w}} \bigoplus_{w_1, w_2 \leq w} R[Y_1, Y_2] \otimes_R \widetilde{J}_*^{n, w_1} \otimes_R \widetilde{J}_*^{n, w_2} \\ &\xrightarrow{f \otimes g} \text{Mor}(A_1^{\otimes n}, A_2 \langle\langle (2 - \kappa_1)w \rangle\rangle) \otimes_R \text{Mor}(B_1^{\otimes n}, B_2 \langle\langle (2 - \kappa_2)w \rangle\rangle) \\ &\rightarrow \text{Mor}((A_1 \otimes_R B_1)^{\otimes n}, A_2 \otimes_R B_2 \langle\langle (4 - \kappa_1 - \kappa_2)w \rangle\rangle) \end{aligned}$$

specifies a weighted algebra homomorphism  $f \otimes_{\Theta} g$ , the tensor product via the diagonal  $\Theta^{*,*}$  of  $f$  and  $g$ .

(The proof that the grading shifts are as specified is similar to the proof of Lemma 7.5, and it is clear that if  $f$  and  $g$  are bonsai then so is  $f \otimes_{\Theta} g$ .)

*Proof of Theorem 1.12.* Existence of weighted algebra diagonals is Theorem 6.11. Part (wA1) is clear from the definition. For Parts (wA2) and (wA3), we use weighted map diagonals, whose existence is ensured by Lemma 6.18. With these remarks in place, the proof of Theorem 1.1 applies with little change to establish the weighted version.  $\square$

*Warning 7.7.* As in the unweighted case, even though we are assuming  $\mathcal{A}$  and  $\mathcal{B}$  are strictly unital,  $\mathcal{A} \otimes_{\Gamma} \mathcal{B}$  is not necessarily strictly unital. See Sections 7.4 for further discussion.

*Remark 7.8.* By using homological perturbation theory, Amorim constructed tensor products of gapped, filtered  $A_\infty$ -algebras, which includes weighted  $A_\infty$ -algebras as a special case [Amo16]. In our language, his construction does not include the term  $\mu_0^1 \otimes \mu_0^1$  in the seed. It seems reasonable to expect that the tensor product he constructs is quasi-isomorphic to the tensor product arising from any weighted algebra diagonal with seed  $\tau \otimes \Psi_0^1 + \Psi_0^1 \otimes \tau$ , but we have not verified this. His techniques do not seem to adapt easily to seeds including the term  $\mu_0^1 \otimes \mu_0^1$ ; perhaps correspondingly, note that many of the terms in Figure 35 do not arise for seeds without this term. (In particular, with the terms coming from  $\mu_0^1 \otimes \mu_0^1$  there is not a naive tensor product of what Amorim calls filtered  $dg$  algebras.)

**7.2. Tensor products of weighted modules.** Let  $\mathcal{A} = (A, \{\mu_n^w\})$  be a strictly unital  $w$ -algebra over  $\mathbb{k}_1$ , say, with weight grading  $\kappa$  and let  $\mathcal{M}_{\mathcal{A}} = (M, \{m_n^w\})$  be a strictly unital  $w$ -module over  $\mathcal{A}$ . Lemma 4.36 gives a corresponding map

$$m: XM_*^{1+n,w} \rightarrow \text{Mor}(M \otimes A^{\otimes n}, M \langle\langle (2 - \kappa)w \rangle\rangle)$$

These maps can be extended to

$$m: \widetilde{XM}_*^{1+n,w} \rightarrow \text{Mor}(M \otimes A^{\otimes n}, M \langle\langle (2 - \kappa)w \rangle\rangle)$$

by the convention that  $m(\downarrow) = \mathbb{I}: M \rightarrow M$ . As in Lemma 7.2, it follows from strict unitality of  $\mathcal{M}$  and  $\mathcal{A}$  that this extension is compatible with stacking.

**Definition 7.9.** Let  $\mathcal{A}$  and  $\mathcal{B}$  be strictly unital  $w$ -algebras with weight gradings  $\kappa_1$  and  $\kappa_2$ , respectively, and let  $\mathcal{M}_{\mathcal{A}}$  and  $\mathcal{N}_{\mathcal{B}}$  be strictly unital  $w$ -modules over  $\mathcal{A}$  and  $\mathcal{B}$ , respectively. Fix a weighted algebra diagonal  $\Gamma^{*,*}$  and a weighted module diagonal  $\mathbf{M}^{*,*}$  compatible with  $\Gamma^{*,*}$ . Define chain maps

$$\begin{aligned} XM_*^{n+1,w} &\xrightarrow{\mathbf{M}^{n+1,w}} \bigoplus_{w_1, w_2 \leq w} R[Y_1, Y_2] \otimes_R \widetilde{XM}_*^{n+1, w_1} \otimes_R \widetilde{XM}_*^{n+1, w_2} \\ &\xrightarrow{m^M \otimes m^N} \text{Mor}(M \otimes A^{\otimes n}, M \langle\langle (2 - \kappa_1)w \rangle\rangle) \otimes_R \text{Mor}(N \otimes B^{\otimes n}, N \langle\langle (2 - \kappa_2)w \rangle\rangle) \end{aligned}$$

$$\hookrightarrow \text{Mor}((M \otimes_R N) \otimes (A \otimes_R B)^{\otimes n}, M \otimes_R N \langle\langle (4 - \kappa_1 - \kappa_2)w \rangle\rangle).$$

By Lemma 4.36, these operations endow  $M \otimes_R N$  with the structure of a  $w$ -module, the tensor product of  $\mathcal{M}_{\mathcal{B}}$  and  $\mathcal{N}_{\mathcal{A}}$ . We will denote this tensor product  $\mathcal{M}_{\mathcal{A}} \otimes_{\mathbf{M}} \mathcal{N}_{\mathcal{B}}$ .

**Lemma 7.10.** *The grading shifts in Definition 7.9 are as stated, so Definition 7.9 does define a  $w$ -module over  $\mathcal{A} \otimes_{\Gamma} \mathcal{B}$ . Further, if  $\mathcal{A}$  and  $\mathcal{B}$  are bonsai, so is  $\mathcal{A} \otimes_{\Gamma} \mathcal{B}$ .*

*Proof.* The proof is the same as the proof of Lemma 7.5.  $\square$

Next we define tensor products of morphisms of  $w$ -modules.

**Definition 7.11.** *Fix:*

- A weighted algebra diagonal  $\Gamma^{*,*}$ ,
- Weighted module diagonals  $\mathbf{M}_1^{*,*}$  and  $\mathbf{M}_2^{*,*}$  compatible with  $\Gamma^{*,*}$ ,
- A weighted module-map diagonal  $\mathbf{L}^{*,*}$  compatible with  $\mathbf{M}_1^{*,*}$  and  $\mathbf{M}_2^{*,*}$ ,
- a strictly unital  $w$ -algebra  $\mathcal{A}$  with weight grading  $\kappa_1$ ,
- a strictly unital  $w$ -algebra  $\mathcal{B}$  with weight grading  $\kappa_2$ ,
- strictly unital  $w$ -modules  $\mathcal{M}^1$  and  $\mathcal{M}^2$  over  $\mathcal{A}$ ,
- strictly unital  $w$ -modules  $\mathcal{N}^1$  and  $\mathcal{N}^2$  over  $\mathcal{B}$ ,
- and morphisms  $f \in \text{Mor}(\mathcal{M}^1, \mathcal{M}^2)$  and  $g \in \text{Mor}(\mathcal{N}^1, \mathcal{N}^2)$  in the dg category of strictly unital  $w$ -modules.

Then there is a corresponding morphism  $(f \otimes_{\mathbf{L}} g) \in \text{Mor}(\mathcal{M}^1 \otimes_{\mathbf{M}_1} \mathcal{N}^1, \mathcal{M}^2 \otimes_{\mathbf{M}_2} \mathcal{N}^2)$  so that  $F_{f \otimes_{\mathbf{L}} g}$  is the composition

$$(7.12) \quad \begin{aligned} JM_*^{n,w} &\xrightarrow{\mathbf{L}} \bigoplus_{w_1+w_2 \leq w} R[Y_1, Y_2] \otimes_R JM_*^{n,w_1} \otimes_R JM_*^{n,w_2} \\ &\xrightarrow{F_f \otimes F_g} \text{Mor}(M^1 \otimes A^{\otimes n}, M^2 \langle\langle (2 - \kappa_1)w \rangle\rangle) \otimes_R \text{Mor}(N^1 \otimes B^{\otimes n}, N^2 \langle\langle (2 - \kappa_2)w \rangle\rangle) \\ &\hookrightarrow \text{Mor}((M^1 \otimes_R N^1) \otimes (A \otimes_R B)^{\otimes n}, M^2 \otimes_R N^2 \langle\langle (2 - \kappa)w \rangle\rangle). \end{aligned}$$

(As usual, the proof that the grading shifts are as specified is similar to the proof of Lemma 7.5, and it is clear that this operation takes a pair of bonsai morphisms to a bonsai morphism.)

We have the following analogue of Proposition 3.29:

**Proposition 7.13.** *Fix a weighted algebra diagonal  $\Gamma^{*,*}$ , weighted module diagonals  $\mathbf{M}_1^{*,*}$ ,  $\mathbf{M}_2^{*,*}$ , and  $\mathbf{M}_3^{*,*}$  compatible with  $\Gamma^{*,*}$ , and for  $1 \leq i < j \leq 3$  weighted module-map diagonals  $\mathbf{L}_{i,j}^{*,*}$  compatible with  $\mathbf{M}_i^{*,*}$  and  $\mathbf{M}_j^{*,*}$ . Then for any  $w$ -algebras  $\mathcal{A}$  and  $\mathcal{B}$ ,  $w$ -modules  $\mathcal{M}^1$ ,  $\mathcal{M}^2$ , and  $\mathcal{M}^3$  over  $\mathcal{A}$ ,  $w$ -modules  $\mathcal{N}^1$ ,  $\mathcal{N}^2$ , and  $\mathcal{N}^3$  over  $\mathcal{B}$ , and morphisms*

$$\mathcal{M}^1 \xrightarrow{f_1} \mathcal{M}^2 \xrightarrow{f_2} \mathcal{M}^3 \quad \mathcal{N}^1 \xrightarrow{g_1} \mathcal{N}^2 \xrightarrow{g_2} \mathcal{N}^3,$$

we have

$$(7.14) \quad (f_2 \circ f_1) \otimes_{\mathbf{L}_{13}} (g_2 \circ g_1) \sim (f_2 \otimes_{\mathbf{L}_{23}} g_2) \circ (f_1 \otimes_{\mathbf{L}_{12}} g_1)$$

$$(7.15) \quad d(f_1 \otimes_{\mathbf{L}_{12}} g_1) = (df_1) \otimes_{\mathbf{L}_{12}} g_1 + f_1 \otimes_{\mathbf{L}_{12}} (dg_1)$$

where in (7.14) the notation  $\sim$  indicates that the two sides are homotopic morphisms.

*Proof.* The proof is similar to the proof of Lemma 3.28 and Proposition 3.29, and is left to the reader.  $\square$

**Lemma 7.16.** *Given  $w$ -modules  $\mathcal{M}$  and  $\mathcal{N}$ , weighted module diagonals  $\mathbf{M}_1^{*,*}$  and  $\mathbf{M}_2^{*,*}$ , and a weighted module-map diagonal  $\mathbf{L}^{*,*}$  compatible with  $\mathbf{M}_1^{*,*}$  and  $\mathbf{M}_2^{*,*}$ , the map*

$$\mathbb{I}_{\mathcal{M}} \otimes_{\mathbf{L}} \mathbb{I}_{\mathcal{N}}: \mathcal{M} \otimes_{\mathbf{M}_1} \mathcal{N} \rightarrow \mathcal{M} \otimes_{\mathbf{M}_2} \mathcal{N}$$

is an isomorphism.

*Proof.* The fact that  $(\mathbb{I}_{\mathcal{M}} \otimes_{\mathbf{L}} \mathbb{I}_{\mathcal{N}})_1^0$  is an isomorphism is immediate from the non-degeneracy condition for  $\mathbf{L}^{*,*}$ , so this follows from Lemma 4.46.  $\square$

**Corollary 7.17.** *Given  $w$ -modules  $\mathcal{M}$  and  $\mathcal{N}$ , a weighted module diagonal  $\mathbf{M}^{*,*}$ , and a weighted module-map diagonal  $\mathbf{L}^{*,*}$  compatible with  $\mathbf{M}^{*,*}$  and  $\mathbf{M}^{*,*}$ , the map*

$$\mathbb{I}_{\mathcal{M}} \otimes_{\mathbf{L}} \mathbb{I}_{\mathcal{N}}: \mathcal{M} \otimes_{\mathbf{M}} \mathcal{N} \rightarrow \mathcal{M} \otimes_{\mathbf{M}} \mathcal{N}$$

*is homotopic to the identity map.*

*Proof.* This follows from Proposition 7.13 and Lemma 7.16 (cf. Corollary 3.33).  $\square$

**Corollary 7.18.** *Fix a weighted algebra diagonal  $\mathbf{\Gamma}^{*,*}$ , weighted module diagonals  $\mathbf{M}_1^{*,*}$ ,  $\mathbf{M}_2^{*,*}$  compatible with  $\mathbf{\Gamma}^{*,*}$ , and  $w$ -modules  $\mathcal{M}$  and  $\mathcal{N}$  over  $w$ -algebras  $\mathcal{A}$  and  $\mathcal{B}$ . Then  $\mathcal{M} \otimes_{\mathbf{M}_1} \mathcal{N}$  and  $\mathcal{M} \otimes_{\mathbf{M}_2} \mathcal{N}$  are homotopy equivalent  $w$ -modules.*

*Proof.* By Lemma 6.41, there is a weighted module-map diagonal  $\mathbf{L}_{12}^{*,*}$  compatible with  $\mathbf{M}_1^{*,*}$  and  $\mathbf{M}_2^{*,*}$ . So, the result is immediate from Proposition 7.13 and Lemma 7.16.  $\square$

*Proof of Theorem 1.14.* Both the fact that  $\mathcal{M}_1 \otimes_{\mathbf{M}} \mathcal{M}_2$  is a weighted module and the fact that this tensor product reduces to the tensor product of  $A_\infty$ -modules in the trivially weighted case (part (M1) of the theorem) are immediate from the definitions. Invariance under homotopy equivalences (part (M2)) is Corollary 7.18. Invariance under changing the diagonal (part (M3)) is Lemma 7.16.  $\square$

### 7.3. Type DD structures and box products.

7.3.1. *The category of weighted type DD bimodules.* The following is the weighted analogue of Definition 3.41:

**Definition 7.19.** *Let  $\mathcal{A}$  and  $\mathcal{B}$  be  $w$ -algebras over  $\mathbb{k}_1$  and  $\mathbb{k}_2$ , respectively. Let  $\kappa = \kappa_1 + \kappa_2 - 2$  and fix an element  $X_{12} \in \mathbb{k}$  of grading  $-\kappa$ , such that  $X_{12}$  acts centrally on all  $\mathbb{k}$ -bimodules under consideration. Fix also a weighted algebra diagonal  $\mathbf{\Gamma}^{n,w}$  with some seed  $\mathcal{S}$ . A left-left type DD structure over  $\mathcal{A}$  and  $\mathcal{B}$  with respect to  $\mathbf{\Gamma}^{n,w}$  with charge  $X_{12}$  is a (left) type D structure over  $\mathcal{A} \otimes_{\mathbf{\Gamma}} \mathcal{B}$  with charge  $X_{12}$  (Definition 4.60). Similarly, the morphism complex  $\text{Mor}(\mathcal{A}, \mathcal{B}P, \mathcal{A}, \mathcal{B}Q)$  between weighted type DD structures is defined to be the morphism complex between the corresponding type D structure over  $\mathcal{A} \otimes_{\mathbf{\Gamma}} \mathcal{B}$  and, more generally, the  $A_\infty$ -category of type DD structures over  $\mathcal{A}$  and  $\mathcal{B}$  with charge  $X_{12}$  is the category of type D structures over  $\mathcal{A} \otimes_{\mathbf{\Gamma}} \mathcal{B}$ .*

Explicitly, the structure map of a weighted type DD structure  $\mathcal{A}, \mathcal{B}P$  is a map

$$\delta^1: P \rightarrow (A \otimes_R B) \otimes_{\mathbb{k}} P \langle\langle 1 \rangle\rangle \cong A \otimes_{\mathbb{k}_1} P \otimes_{\mathbb{k}_2} B^{\text{op}} \langle\langle 1 \rangle\rangle.$$

(Here, for a change, we have not suppressed the ground rings from the tensor product notation.) We can iterate  $\delta^1$  to get maps

$$\begin{aligned} \delta^i: P &\rightarrow (A \otimes_R B)^{\otimes i} \otimes P \langle\langle i \rangle\rangle \\ \delta: P &\rightarrow \prod_{i \geq 0} (A \otimes_R B)^{\otimes i} \otimes P \langle\langle i \rangle\rangle. \end{aligned}$$

The structure equation for a weighted type DD structure is given graphically by

$$(7.20) \quad \sum_{w=0}^{\infty} \sum_{i=0}^{\infty} X_{12}^w \begin{array}{ccc} & \downarrow & \\ & \delta^i & \\ \swarrow & \vdots & \searrow \\ \gamma^{i,w} & (\gamma^{i,w})^{\text{op}} & \\ \downarrow & \downarrow & \downarrow \end{array} = 0.$$

This makes sense as long as  $\mathcal{A}$  and  $\mathcal{B}$  are bonsai (so  $\mathcal{A} \otimes_{\mathbf{\Gamma}} \mathcal{B}$  is) or  $\mathcal{A}, \mathcal{B}P$  is operationally bounded, in the sense that:

- (1)  $\delta^n = 0$  for  $n$  sufficiently large and
- (2)  $X_{12}$  is nilpotent, i.e., for sufficiently large  $n$ ,  $X_{12}^n \cdot (a \otimes b) = 0$  for all  $a \otimes b \in A \otimes B$ .

Similarly, given type  $DD$  structures  ${}^{\mathcal{A}, \mathcal{B}}P$ ,  ${}^{\mathcal{A}, \mathcal{B}}Q$  over  $\mathcal{A}$  and  $\mathcal{B}$  with the same charge  $X_{12}$ , the differential of a morphism  $f^1: P \rightarrow (A \otimes_R B) \otimes Q$  is given by

$$d(f^1) = \sum_{w=0}^{\infty} \sum_{i,j=0}^{\infty} X_{12}^w$$

*Warning 7.21.* As in the unweighted case, the category of type  $DD$  structures over  $\mathcal{A}$  and  $\mathcal{B}$  is a non-unital category, since  $\mathcal{A} \otimes_{\Gamma} \mathcal{B}$  is a non-unital weighted algebra. This can be rectified by considering homotopy unital weighted algebras. See Section 7.5 and, in particular, Theorem 7.62 for independence of the category of type  $DD$  structures from the choice of diagonal.

7.3.2. *The triple box product.* The following is the weighted analogue of Definition 3.47:

**Definition 7.22.** Fix a weighted algebra diagonal  $\Gamma^{*,*}$  and a compatible weighted module diagonal  $\mathbf{M}^{*,*}$ . Let  $\mathcal{A}$  and  $\mathcal{B}$  be strictly unital  $w$ -algebras,  $\mathcal{M}_{\mathcal{A}}$  and  $\mathcal{N}_{\mathcal{B}}$  strictly unital  $w$ -modules, and  ${}^{\mathcal{A}, \mathcal{B}}P$  a type  $DD$  structure with charge  $X_{12}$ . Assume that either

- $\mathcal{M}$ ,  $\mathcal{N}$ ,  $\mathcal{A}$ , and  $\mathcal{B}$  are bonsai or
- $P$  is operationally bounded.

Then define

$$[\mathcal{M}_{\mathcal{A}} \boxtimes {}^{\mathcal{A}}P^{\mathcal{B}^{\text{op}}} \boxtimes {}_{\mathcal{B}^{\text{op}}} \mathcal{N}]_{\mathbf{M}} := (\mathcal{M} \otimes_{\mathbf{M}} \mathcal{N})_{\mathcal{A} \otimes_{\Gamma} \mathcal{B}} \boxtimes {}^{\mathcal{A} \otimes_{\Gamma} \mathcal{B}}P.$$

Explicitly, the differential on the triple box product is

$$\sum_{n,w \geq 0} X_{12}^w$$

Recall that Theorem 1.16 asserts that the weighted triple box product is well-defined and, up to homotopy equivalence, independent of  $\mathbf{M}^{*,*}$ :

*Proof of Theorem 1.16.* The first statement follows from the facts that tensor product of two weighted modules is a weighted module (see Definition 7.9) and the box product of a weighted module and a weighted type  $D$  structure is a chain complex (Lemma 4.67). The second statement follows from the facts that different module diagonals give homotopy equivalent tensor products of weighted modules (Corollary 7.18) and the box tensor product respects homotopy equivalence (Lemma 4.68).  $\square$

7.3.3. *The one-sided box tensor product.* Next we turn to the weighted analogue of the one-sided box product (Definition 3.49). Recall from Section 4.1 that given a  $w$ -algebra  $(\mathcal{A}, \mu^A)$  and a weighted (algebra) tree  $T$  with  $n$  inputs and weight  $w$  there is a corresponding map

$$\mu^A(T): A^{\otimes n} \rightarrow A \langle\langle -\dim(T) + (2 - \kappa)w \rangle\rangle.$$

Similarly, as described in Section 4.4, given a  $w$ -module  $(\mathcal{M}, m^M)$  over  $\mathcal{A}$  and a weighted module tree  $T$  with  $1 + n$  inputs there is a corresponding map

$$m^M(T): M \otimes A^{\otimes n} \rightarrow M \langle\langle -\dim(T) + (2 - \kappa)w \rangle\rangle.$$

**Definition 7.23.** Fix a weighted algebra diagonal  $\gamma^{*,*}$  and a weighted module diagonal primitive  $\mathbf{p}^{*,*}$  compatible with  $\gamma^{*,*}$ . Let  $\mathcal{A}$ ,  $\mathcal{B}$  be strictly unital  $w$ -algebras over  $\mathbb{k}_1$  and  $\mathbb{k}_2$ , respectively,  ${}^{\mathcal{A},\mathcal{B}}P$  a type DD structure with respect to  $\gamma^{*,*}$ , with charge  $X_{12}$ , and  $\mathcal{M}_{\mathcal{A}}$  a strictly unital  $w$ -module over  $\mathcal{A}$ . Assume that either  ${}^{\mathcal{A},\mathcal{B}}P$  is operationally bounded or  $\mathcal{M}$ ,  $\mathcal{A}$ , and  $\mathcal{B}$  are bonsai. Define  $\mathcal{M} \boxtimes^{\mathbf{P}} P$  to be the type D structure  $M \otimes_{\mathbb{k}_1} P$  with structure map

$$\delta^1: M \otimes_{\mathbb{k}_1} P \rightarrow B \otimes_{\mathbb{k}_2} (M \otimes_{\mathbb{k}_1} P) \langle\langle 1 \rangle\rangle = (M \otimes_{\mathbb{k}_1} P) \otimes_{\mathbb{k}_2} B^{\text{op}} \langle\langle 1 \rangle\rangle$$

defined by

$$\delta^1(x \otimes y) = m_1^0(x) \otimes y \otimes 1 + \sum_{n,w \geq 0} \sum_{(S,T) \in \mathbf{p}^{n+1,w}} X_{12}^w (m^M(S) \otimes \mathbb{I}_P \otimes \mu^{\mathcal{B}^{\text{op}}}(T^{\text{op}})) \circ (\mathbb{I}_M \otimes \delta_P^n),$$

and charge

$$X_2 = X_{12} Y_1.$$

(Unlike our usual convention, we have not suppressed the ground rings for the tensor products here.)

Graphically, the differential on  $\mathcal{M} \boxtimes^{\mathbf{P}} P$  is

$$\begin{array}{c} \downarrow \\ m_1^0 \\ \downarrow \end{array} \begin{array}{c} \downarrow \\ \mathbf{1} \\ \downarrow \end{array} + \sum_{n,w \neq (0,0)} X_{12}^w \begin{array}{c} \downarrow \\ \mathbf{p}^{n+1,w} \\ \downarrow \end{array} \begin{array}{c} \downarrow \\ \delta^n \\ \downarrow \end{array} \begin{array}{c} \downarrow \\ (\mathbf{p}^{n+1,w})^{\text{op}} \\ \downarrow \end{array}.$$

**Proposition 7.24.** Assuming that either  ${}^{\mathcal{A},\mathcal{B}}P$  is operationally bounded or  $\mathcal{M}$ ,  $\mathcal{A}$ , and  $\mathcal{B}$  are bonsai, the operation  $\delta^1$  from Definition 7.23 respects the gradings and makes  $\mathcal{M} \boxtimes^{\mathbf{P}} P$  into a weighted type D structure with charge  $X_{12} Y_1$ . If  ${}^{\mathcal{A},\mathcal{B}}P$  is operationally bounded then so is  $\mathcal{M} \boxtimes^{\mathbf{P}} P$ .

Further, if  $N_{\mathcal{B}}$  is a  $w$ -module (bonsai if  ${}^{\mathcal{A},\mathcal{B}}P$  is not operationally bounded) and  $\mathbf{m}^{*,*}$  is the weighted module diagonal induced by  $\mathbf{p}^{*,*}$  then there is an isomorphism

$$(\mathcal{M} \boxtimes^{\mathbf{P}} P) \boxtimes \mathcal{N} \cong [\mathcal{M} \boxtimes P \boxtimes \mathcal{N}]_{\mathbf{M}},$$

where the right-hand-side denotes the weighted triple box product of Definition 7.22.

*Proof.* First, we check the gradings. The first term in the definition of  $\delta^1$  decreases the grading by 1. For the second term, we have

$$\begin{aligned} \text{gr}(X_{12}^w) &= -(\kappa_1 + \kappa_2 - 2)w \\ \text{gr}(\delta_P^n) &= -n \\ \text{gr}(m^M(S) \otimes \mathbb{I}_P \otimes \mu^{\mathcal{B}^{\text{op}}}(T^{\text{op}})) &= \dim(S) - (2 - \kappa_1)w + \dim(T) - (2 - \kappa_2)w \\ &= (n + 1 + 2w - 2) - (4 - \kappa_1 - \kappa_2)w \\ &= n - 1 + (\kappa_1 + \kappa_2 - 2)w. \end{aligned}$$

Summing these, the operation  $\delta^1$  has grading  $-1$ , as claimed.



Next, we check the type  $D$  structure relation (Equation (4.61)). The left side of the type  $D$  structure relation is

$$\sum_{\substack{k \geq 1 \\ n_1, \dots, n_k, w_1, \dots, w_k, w \geq 0}} (X_{12}Y_1)^w (X_{12}^{w_1+\dots+w_k})$$

(where in the case  $(n_i, w_i) = (0, 0)$  we let  $(\mathbf{p}^{n_1+1, w_1}) \otimes (\mathbf{p}^{n_1+1, w_1})^{\text{op}}$  denote  $m_1^0 \otimes \mathbb{I}$ ). From the primitive structure equation, this is

$$\sum_{\substack{u+v=w+w_1+\dots+w_k \\ m_1, m_3, u, v \geq 0}} X_{12}^{w+w_1+\dots+w_k}$$

(where in the case  $(m_2, u) = (0, 0)$  we let  $(\gamma^{m_2, u}) \otimes (\gamma^{m_2, u})^{\text{op}}$  denote  $\mu_1^0 \otimes \mathbb{I}$ ). So, the result follows from the type  $DD$  structure equation (Equation (7.20)). Note, in particular, that this computation explains the (perhaps surprising) charge  $X_{12}Y_1$ .

For the statement about boundedness, if  $X_{12}$  is nilpotent then so is  $X_{12}Y_1$ . Since  $(m_1^0)^2 = 0$ , every term in the operation  $\delta^{2n+2}$  on  $\mathcal{M} \boxtimes^{\mathbf{P}} P$  involves  $\delta^u$  and a coefficient of  $X_{12}^v$  where  $u + v \geq n$ . Consequently,  $\delta^m$  on  $\mathcal{M} \boxtimes^{\mathbf{P}} P$  vanishes for  $m$  sufficiently large.

The proof of associativity of  $\boxtimes$  is similar but easier, and is left to the reader.  $\square$

**7.3.4. Functoriality of the one-sided box tensor product.** Next, we turn to functoriality of the one-sided box product. Given weighted type  $DD$  structures  $P$  and  $Q$  over  $\mathcal{A}_1$  and  $\mathcal{A}_2$  with respect to a weighted algebra diagonal  $\mathbf{\Gamma}^{*,*}$ , with the same charge  $X_{12}$ ; a morphism  $f: P \rightarrow Q$ ; a  $w$ -module  $\mathcal{M}$  over  $\mathcal{A}_1$ ; and a weighted module diagonal primitive  $\mathbf{p}^{*,*}$ , under suitable boundedness hypotheses (see Lemma 7.27) there is a type  $D$  structure morphism

$$\mathbb{I}_{\mathcal{M}} \boxtimes^{\mathbf{P}} f^1: \mathcal{M} \boxtimes^{\mathbf{P}} P \rightarrow \mathcal{M} \boxtimes^{\mathbf{P}} Q$$



defined by

$$(7.25) \quad \mathbb{I}_{\mathcal{M}} \boxtimes^{\mathbf{P}} f^1 = \sum_{n,w \geq 0} X_{12}^w$$

(cf. Formula (3.53)).

Similarly, given a weighted module-map primitive  $\mathbf{q}^{*,*}$  compatible with weighted module diagonal primitives  $\mathbf{p}_1^{*,*}$  and  $\mathbf{p}_2^{*,*}$ , another  $w$ -module  $\mathcal{N}$  over  $\mathcal{A}_1$  and a morphism  $g: \mathcal{M} \rightarrow \mathcal{N}$ , if either  $P$  is operationally bounded or  $\mathcal{A}_1, \mathcal{A}_2, \mathcal{M}$ , and  $\mathcal{N}$  are bonsai, there is a type  $D$  structure morphism

$$g \boxtimes^{\mathbf{Q}} \mathbb{I}_P: \mathcal{M} \boxtimes^{\mathbf{P}^1} P \rightarrow \mathcal{N} \boxtimes^{\mathbf{P}^2} P$$

defined by

$$(7.26) \quad \sum_{n,w \geq 0} X_{12}^w$$

(cf. Formula (3.54)).

**Lemma 7.27.** *Suppose that either  $P$  is operationally bounded or  $\mathcal{A}, \mathcal{B}, \mathcal{M}, \mathcal{N}$ , and  $g$  are bonsai. Then the maps  $\mathbb{I}_{\mathcal{M}} \boxtimes^{\mathbf{P}} \cdot$  and  $\cdot \boxtimes^{\mathbf{Q}} \mathbb{I}_P$  are grading-preserving chain maps*

$$\begin{aligned} \mathbb{I}_{\mathcal{M}} \boxtimes^{\mathbf{P}} \cdot &: \text{Mor}(P, Q) \rightarrow \text{Mor}(\mathcal{M} \boxtimes^{\mathbf{P}} P, \mathcal{M} \boxtimes^{\mathbf{P}} Q) \\ \cdot \boxtimes^{\mathbf{Q}} \mathbb{I}_P &: \text{Mor}(\mathcal{M}, \mathcal{N}) \rightarrow \text{Mor}(\mathcal{M} \boxtimes^{\mathbf{P}^1} P, \mathcal{N} \boxtimes^{\mathbf{P}^2} P). \end{aligned}$$

Moreover, for  $\cdot \boxtimes^{\mathbf{Q}} \mathbb{I}_P$ , homotopic module-map primitives give homotopic chain maps.

*Proof.* This follows from the same argument as Lemma 3.56.  $\square$

**Proposition 7.28.** *Fix a weighted algebra diagonal  $\Gamma^{*,*}$ ; weighted module diagonal primitives  $\mathbf{p}_1^{*,*}$ ,  $\mathbf{p}_2^{*,*}$ , and  $\mathbf{p}_3^{*,*}$  compatible with  $\gamma^{*,*}$ ; and weighted module-map primitives  $\mathbf{q}_{12}^{*,*}$  compatible with  $\mathbf{p}_1^{*,*}$  and  $\mathbf{p}_2^{*,*}$ ,  $\mathbf{q}_{23}^{*,*}$  compatible with  $\mathbf{p}_2^{*,*}$  and  $\mathbf{p}_3^{*,*}$ , and  $\mathbf{q}_{13}^{*,*}$  compatible with  $\mathbf{p}_1^{*,*}$  and  $\mathbf{p}_3^{*,*}$ . Let  $\mathcal{A}$  and  $\mathcal{B}$  be  $w$ -algebras,  $\mathcal{M}_1, \mathcal{M}_2$ , and  $\mathcal{M}_3$   $w$ -modules over  $\mathcal{A}$ , and  $P_1, P_2$ , and  $P_3$  type  $DD$  structures over  $\mathcal{A}$  and  $\mathcal{B}$  with the same charge  $X_{12}$ . Assume that either the  $P_i$  are operationally bounded or  $\mathcal{A}, \mathcal{B}$ , and the  $\mathcal{M}_i$  are bonsai. Then the analogues of Diagrams (3.59), (3.60), and (3.61) commute up to homotopy where, in the case that the  $\mathcal{M}_i$  are bonsai, we consider the bonsai morphism complexes.*

*Proof.* The proof is similar to the proof of Proposition 7.28, and is left to the reader.  $\square$

**Lemma 7.29.** *Fix weighted module diagonal primitives  $\mathbf{p}_1^{*,*}$  and  $\mathbf{p}_2^{*,*}$  and a weighted module-map primitive  $\mathbf{q}^{*,*}$  compatible with  $\mathbf{p}_1^{*,*}$  and  $\mathbf{p}_2^{*,*}$ . Given  $w$ -algebras  $\mathcal{A}$  and  $\mathcal{B}$ , a  $w$ -module  $\mathcal{M}_{\mathcal{A}}$  and a type  $DD$  structure  ${}^{\mathcal{A}, \mathcal{B}}P$ , the map*

$$\mathbb{I}_{\mathcal{M}} \boxtimes^{\mathbf{Q}} \mathbb{I}_P: \mathcal{M} \boxtimes^{\mathbf{P}^1} P \rightarrow \mathcal{M} \boxtimes^{\mathbf{P}^2} P$$

*is a homotopy equivalence. Further, if  $\mathbf{p}_1^{*,*} = \mathbf{p}_2^{*,*}$  then  $\mathbb{I}_{\mathcal{M}} \boxtimes^{\mathbf{Q}} \mathbb{I}_P$  is homotopic to the identity map.*

*Proof.* The proof is essentially the same as the proofs Lemma 3.62 and Corollary 3.63. First, in the special case that  $\mathbf{p}_1^{*,*} = \mathbf{p}_2^{*,*}$  and  $\mathbf{q}^{*,*}$  is the weighted module-map primitive from Lemma 6.48,  $\mathbb{I}_{\mathcal{M}} \boxtimes^{\mathbf{q}} \mathbb{I}_P$  is the identity map. The fact that  $\mathbb{I}_{\mathcal{M}} \boxtimes^{\mathbf{q}} \mathbb{I}_P$  is homotopic to the identity map for any weighted module-map primitive compatible with  $\mathbf{p}_1^{*,*}$  and  $\mathbf{p}_1^{*,*}$  follows from the facts that all weighted module-map primitives are homotopic (Lemma 6.41) and homotopic primitives give homotopic maps (Lemma 7.27). The case that  $\mathbf{p}_1^{*,*} \neq \mathbf{p}_2^{*,*}$  then follows from Proposition 7.28.  $\square$

**Corollary 7.30.** *Fix strictly unital  $w$ -modules  $\mathcal{M}$  and  $\mathcal{N}$ , a homomorphism  $f: \mathcal{M} \rightarrow \mathcal{N}$ , and a type DD structure  $P$  such that either  $P$  is operationally bounded or  $\mathcal{M}$ ,  $\mathcal{N}$ , and  $f$  are bonsai. If  $f$  is a homotopy equivalence then for any choice of module diagonal primitives and module-map primitive,*

$$f \boxtimes^{\mathbf{q}} \mathbb{I}_P: \mathcal{M} \boxtimes^{\mathbf{P}^1} P \rightarrow \mathcal{N} \boxtimes^{\mathbf{P}^2} P$$

is a homotopy equivalence.

*Proof.* This is immediate from Lemma 7.29 and Proposition 7.28.  $\square$

7.3.5. *Associativity of the box tensor product of weighted morphisms.* Similarly to the unweighted case, given a weighted type DD structure  $P$ , strictly unital  $w$ -modules  $\mathcal{M}_1, \mathcal{M}_2, \mathcal{N}_1$ , and  $\mathcal{N}_2$ , and morphisms  $f: \mathcal{M}_1 \rightarrow \mathcal{M}_2$  and  $g: \mathcal{N}_1 \rightarrow \mathcal{N}_2$ , as well as a weighted algebra diagonal  $\mathbf{\Gamma}^{*,*}$ , weighted module diagonals  $\mathbf{M}_1^{*,*}$  and  $\mathbf{M}_2^{*,*}$  compatible with  $\mathbf{\Gamma}^{*,*}$ , and a weighted module-map diagonal  $\mathbf{L}^{*,*}$  compatible with  $\mathbf{M}_1^{*,*}$  and  $\mathbf{M}_2^{*,*}$ , Definition 7.11 gives a triple box product

$$[f \boxtimes \mathbb{I}_P \boxtimes g]_{\mathbf{L}} = (f \otimes_{\mathbf{L}} g) \boxtimes \mathbb{I}_P$$

(under appropriate boundedness assumptions). In the special case that  $g$  is the identity map,  $[f \boxtimes \mathbb{I}_P \boxtimes g]_{\mathbf{L}}$  depends only on the partial weighted module-map diagonal induced by  $\mathbf{L}^{*,*}$ . That is, given a partial weighted module-map diagonal  $\mathbf{k}^{*,*}$  compatible with  $\mathbf{M}_1^{*,*}$  and  $\mathbf{M}_2^{*,*}$  we can define

$$(7.31) \quad [f \boxtimes \mathbb{I}_P \boxtimes \mathbb{I}_{\mathcal{N}}]_{\mathbf{k}} = \begin{array}{c} \begin{array}{ccc} \downarrow & \downarrow \delta & \downarrow \\ \downarrow \swarrow & \downarrow & \downarrow \searrow \\ \mathbf{k}f & & \mathbf{k}^{\text{op}\mathbb{I}} \end{array} \\ \downarrow \quad \downarrow \quad \downarrow \end{array} = \sum_{n,w \geq 0} X_{12}^w \begin{array}{ccc} \downarrow & \downarrow \delta^n & \downarrow \\ \downarrow \swarrow & \downarrow & \downarrow \searrow \\ \mathbf{k}^{n+1,w} & & (\mathbf{k}^{n+1,w})^{\text{op}\mathbb{I}} \end{array} \\ \downarrow \quad \downarrow \quad \downarrow \end{array}$$

where  $\mathbf{k}f$  means that we apply  $f$  at the distinguished vertex of (the left tree in)  $\mathbf{k}^{*,*}$  and  $\mathbf{k}\mathbb{I}$  means we apply  $\mathbb{I}$  at the distinguished vertex of (the right tree in)  $\mathbf{k}^{*,*}$ , and we multiply by  $X_{12}$  to the weight.

**Lemma 7.32.** *If either  $P$  is operationally bounded or  $\mathcal{A}, \mathcal{B}, \mathcal{M}_i, \mathcal{N}_i, i = 1, 2$ , and  $f$  are bonsai then Formula (7.31) defines a chain map*

$$\text{Mor}(\mathcal{M}_1, \mathcal{M}_2) \rightarrow \text{Mor}([\mathcal{M}_1 \boxtimes P \boxtimes \mathcal{N}]_{\mathbf{M}_1}, [\mathcal{M}_2 \boxtimes P \boxtimes \mathcal{N}]_{\mathbf{M}_2}).$$

Moreover, homotopic partial weighted module-map diagonals induce homotopic chain maps. Finally, if  $\mathbf{k}^{*,*}$  is induced by a weighted module-map primitive  $\mathbf{q}$  then  $[f \boxtimes \mathbb{I}_P \boxtimes \mathbb{I}_{\mathcal{N}}]_{\mathbf{k}}$  is homotopic to  $(f \boxtimes^{\mathbf{q}} \mathbb{I}_P) \boxtimes \mathbb{I}_{\mathcal{N}}$ .

*Proof.* This is a straightforward adaptation of the proof of Lemma 3.66 to the weighted case, but we repeat the proof keeping track of the weights and variables. (Nothing surprising happens with them, either.)

To keep the notation from getting out of hand, we will not indicate which module an  $m^{1,0}$  or  $\mathbf{m}^{n,w}$  comes from, as it is determined by whether the operation comes before or after the copy of  $\mathbf{k}^{*,*}$ . We will also suppress the ops from the notation.

For the first statement,  $d[f \boxtimes \mathbb{I}_P \boxtimes \mathbb{I}_{\mathcal{N}}]_{\mathbf{k}}$  is given by

$$\begin{aligned} & \sum_{u,v} X_{12}^{u+v} \begin{array}{ccc} \downarrow & \delta & \downarrow \\ \swarrow & & \searrow \\ \mathbf{m}^{*,u} & & \mathbf{m}^{*,u} \\ \downarrow & \delta & \downarrow \\ \swarrow & & \searrow \\ \mathbf{k}^{*,v}f & & \mathbf{k}^{*,v}\mathbb{I} \end{array} + \begin{array}{ccc} \downarrow & \delta & \downarrow \\ \swarrow & & \searrow \\ \mathbf{k}^{*,v}f & & \mathbf{k}^{*,v}\mathbb{I} \\ \downarrow & \delta & \downarrow \\ \swarrow & & \searrow \\ \mathbf{m}^{*,u} & & \mathbf{m}^{*,u} \end{array} \\ & + \sum_w X_{12}^w \begin{array}{ccc} \downarrow & \delta & \downarrow \\ \swarrow & & \searrow \\ \mathbf{m}^{1,0} & & \mathbf{m}^{1,0} \\ \downarrow & \delta & \downarrow \\ \swarrow & & \searrow \\ \mathbf{k}^{*,w}f & & \mathbf{k}^{*,w}\mathbb{I} \end{array} + \begin{array}{ccc} \downarrow & \delta & \downarrow \\ \swarrow & & \searrow \\ \mathbf{m}^{1,0} & & \mathbf{m}^{1,0} \\ \downarrow & \delta & \downarrow \\ \swarrow & & \searrow \\ \mathbf{k}^{*,w}f & & \mathbf{k}^{*,w}\mathbb{I} \end{array} + \begin{array}{ccc} \downarrow & \delta & \downarrow \\ \swarrow & & \searrow \\ \mathbf{k}^{*,w}f & & \mathbf{k}^{*,w}\mathbb{I} \\ \downarrow & \delta & \downarrow \\ \swarrow & & \searrow \\ \mathbf{k}^{*,w}\mathbb{I} & & \mathbf{k}^{*,w}\mathbb{I} \end{array} + \begin{array}{ccc} \downarrow & \delta & \downarrow \\ \swarrow & & \searrow \\ \mathbf{k}^{*,w}f & & \mathbf{k}^{*,w}\mathbb{I} \\ \downarrow & \delta & \downarrow \\ \swarrow & & \searrow \\ \mathbf{k}^{*,w}\mathbb{I} & & \mathbf{k}^{*,w}\mathbb{I} \end{array} . \end{aligned}$$

From the definition of a partial module-map diagonal, this sum is equal to

$$\begin{aligned} & \sum_w X_{12}^w \begin{array}{ccc} \downarrow & \delta & \downarrow \\ \swarrow & & \searrow \\ (\partial\mathbf{k}^{*,w})f & & \mathbf{k}^{*,w}\mathbb{I} \\ \downarrow & \delta & \downarrow \\ \swarrow & & \searrow \\ \mathbf{k}^{*,w}f & & (\partial\mathbf{k}^{*,w})\mathbb{I} \end{array} + \begin{array}{ccc} \downarrow & \delta & \downarrow \\ \swarrow & & \searrow \\ \mathbf{k}^{*,w}f & & \mathbf{k}^{*,w}\mathbb{I} \\ \downarrow & \delta & \downarrow \\ \swarrow & & \searrow \\ \mathbf{k}^{*,w}f & & \mathbf{k}^{*,w}\mathbb{I} \end{array} + \begin{array}{ccc} \downarrow & \delta & \downarrow \\ \swarrow & & \searrow \\ \mathbf{m}^{1,0} & & \mathbf{m}^{1,0} \\ \downarrow & \delta & \downarrow \\ \swarrow & & \searrow \\ \mathbf{k}^{*,w}f & & \mathbf{k}^{*,w}\mathbb{I} \end{array} + \begin{array}{ccc} \downarrow & \delta & \downarrow \\ \swarrow & & \searrow \\ \mathbf{m}^{1,0} & & \mathbf{m}^{1,0} \\ \downarrow & \delta & \downarrow \\ \swarrow & & \searrow \\ \mathbf{k}^{*,w}f & & \mathbf{k}^{*,w}\mathbb{I} \end{array} + \begin{array}{ccc} \downarrow & \delta & \downarrow \\ \swarrow & & \searrow \\ \mathbf{k}^{*,w}f & & \mathbf{k}^{*,w}\mathbb{I} \\ \downarrow & \delta & \downarrow \\ \swarrow & & \searrow \\ \mathbf{m}^{1,0} & & \mathbf{m}^{1,0} \end{array} \\ & + \begin{array}{ccc} \downarrow & \delta & \downarrow \\ \swarrow & & \searrow \\ \mathbf{k}^{*,w}f & & \mathbf{k}^{*,w}\mathbb{I} \\ \downarrow & \delta & \downarrow \\ \swarrow & & \searrow \\ \mathbf{k}^{*,w}\mathbb{I} & & \mathbf{k}^{*,w}\mathbb{I} \end{array} + \sum_{u,v} X_{12}^{u+v} \begin{array}{ccc} \downarrow & \delta & \downarrow \\ \swarrow & & \searrow \\ \mathbf{k}^{*,v}f & & \mathbf{k}^{*,v}\mathbb{I} \\ \downarrow & \delta & \downarrow \\ \swarrow & & \searrow \\ \mathbf{k}^{*,v}f & & \mathbf{k}^{*,v}\mathbb{I} \end{array} + \begin{array}{ccc} \downarrow & \delta & \downarrow \\ \swarrow & & \searrow \\ \alpha f & & (\partial\alpha)\mathbb{I} \\ \downarrow & \delta & \downarrow \\ \swarrow & & \searrow \\ \beta f & & \beta\mathbb{I} \end{array} \end{aligned}$$

where  $\alpha, \beta \in JM_{*}^{*,*} \otimes_R \mathcal{F}_{\neq 2} JM_{*}^{*,*} \otimes_R R[Y_1, Y_2]$ .  
Applying Lemma 4.45, this sum is equal to

$$\begin{aligned} & \sum_w X_{12}^w \begin{array}{ccc} \downarrow & \delta & \downarrow \\ \swarrow & & \searrow \\ \mathbf{k}^{*,w}(df) & & \mathbf{k}^{*,w}\mathbb{I} \\ \downarrow & \delta & \downarrow \\ \swarrow & & \searrow \\ \mathbf{k}^{*,w}f & & \mathbf{k}^{*,w}(d\mathbb{I}) \end{array} + \begin{array}{ccc} \downarrow & \delta & \downarrow \\ \swarrow & & \searrow \\ \mathbf{k}^{*,w}f & & \mathbf{k}^{*,w}\mathbb{I} \\ \downarrow & \delta & \downarrow \\ \swarrow & & \searrow \\ \mathbf{k}^{*,w}f & & \mathbf{k}^{*,w}\mathbb{I} \end{array} + \begin{array}{ccc} \downarrow & \delta & \downarrow \\ \swarrow & & \searrow \\ \mathbf{k}^{*,w}f & & \mathbf{k}^{*,w}\mathbb{I} \\ \downarrow & \delta^1 & \downarrow \\ \swarrow & & \searrow \\ \mathbf{k}^{*,w}f & & \mathbf{k}^{*,w}\mathbb{I} \end{array} + \begin{array}{ccc} \downarrow & \delta & \downarrow \\ \swarrow & & \searrow \\ \mathbf{k}^{*,w}f & & \mathbf{k}^{*,w}\mathbb{I} \\ \downarrow & \delta^1 & \downarrow \\ \swarrow & & \searrow \\ \mathbf{k}^{*,w}f & & \mathbf{k}^{*,w}\mathbb{I} \end{array} \end{aligned}$$

$$\begin{array}{c}
 + \sum_{u,v} X_{12}^{u+v} \\
 \begin{array}{c}
 \downarrow \delta \\
 \downarrow \delta \\
 \downarrow \delta \\
 \begin{array}{ccc}
 \swarrow \gamma^{*,u} & \searrow \gamma^{*,v} \\
 \mathbf{k}^{*,v} f & \mathbf{k}^{*,v} \mathbb{I}
 \end{array}
 \end{array}
 \end{array}
 + \begin{array}{c}
 \downarrow \delta \\
 \downarrow \delta \\
 \downarrow \delta \\
 \begin{array}{ccc}
 \swarrow \alpha f & \searrow (\partial \alpha) \mathbb{I} \\
 \downarrow & \downarrow
 \end{array}
 \end{array}
 + \begin{array}{c}
 \downarrow \delta \\
 \downarrow \delta \\
 \downarrow \delta \\
 \begin{array}{ccc}
 \swarrow \beta f & \searrow \beta \mathbb{I} \\
 \downarrow & \downarrow
 \end{array}
 \end{array}
 .
 \end{array}$$

The second term vanishes because  $d(\mathbb{I}) = 0$ . The third, fourth, and fifth terms cancel by the type  $DD$  structure relation. (The cancellation happens after factoring out  $X_{12}^v$  from the fifth term. The third and fourth terms are like special cases where  $v = 0$ , if one views  $\gamma^{1,0}$  as  $\mu^{1,0} \otimes \mathbb{I} + \mathbb{I} \otimes \mu^{1,0}$ .) The last term vanishes because the identity map  $\mathbb{I}$  has  $\mathbb{I}_n = 0$  for  $n > 1$ . So, applying Lemma 4.45 to the second-to-last term we are left with

$$\begin{array}{c}
 \sum_w X_{12}^w \\
 \begin{array}{c}
 \downarrow \delta \\
 \downarrow \delta \\
 \downarrow \delta \\
 \begin{array}{ccc}
 \swarrow \mathbf{k}^{*,w}(df) & \searrow \mathbf{k}^{*,w} \mathbb{I} \\
 \downarrow & \downarrow
 \end{array}
 \end{array}
 + \begin{array}{c}
 \downarrow \delta \\
 \downarrow \delta \\
 \downarrow \delta \\
 \begin{array}{ccc}
 \swarrow \alpha f & \searrow \alpha(d\mathbb{I}) \\
 \downarrow & \downarrow
 \end{array}
 \end{array}
 + \begin{array}{c}
 \downarrow \delta \\
 \downarrow \delta^1 \\
 \downarrow \delta \\
 \begin{array}{ccc}
 \swarrow \mu^{1,0} & \searrow \mu^{1,0} \\
 \alpha f & \alpha \mathbb{I}
 \end{array}
 \end{array}
 .
 \end{array}$$

Again, the second term vanishes because  $d(\mathbb{I}) = 0$  and the third term vanishes because  $\mathbb{I}_n = 0$  for  $n \geq 2$ . Thus, we are left  $[(df) \boxtimes \mathbb{I}_P \boxtimes \mathbb{I}_{\mathcal{N}}]_{\mathbf{k}}$ , as desired.

For the second statement, applying the argument above but with a homotopy  $\zeta$  of partial module-map diagonals in place of  $\mathbf{k}$  gives

$$\sum_w X_{12}^w d \left( \begin{array}{c} \downarrow \delta \\ \downarrow \delta \\ \downarrow \delta \\ \zeta^{*,w} f \quad \zeta^{*,w} \mathbb{I} \end{array} \right) = \sum_w X_{12}^w \left( \begin{array}{c} \downarrow \delta \\ \downarrow \delta \\ \downarrow \delta \\ \zeta^{*,w}(df) \quad \zeta^{*,w} \mathbb{I} \end{array} \right) + [f \boxtimes \mathbb{I}_P \boxtimes \mathbb{I}_{\mathcal{N}}]_{\mathbf{k}^1} - [f \boxtimes \mathbb{I}_P \boxtimes \mathbb{I}_{\mathcal{N}}]_{\mathbf{k}^2},$$

as desired.

Finally, if  $\mathbf{k}$  comes from a primitive  $\mathbf{q}$  (and  $\mathbf{m}^i$  comes from a primitive  $\mathbf{p}^i$ ) then

$$[f \boxtimes \mathbb{I}_P \boxtimes \mathbb{I}_N]_{\mathbf{k}} = \sum_{k, \ell, u_1, \dots, u_\ell, v} X_{12}^{u_1 + \dots + u_\ell + v} Y_1^v$$

$$= (f \boxtimes_{\mathbf{q}} \mathbb{I}_P) \boxtimes \mathbb{I}_N,$$

as claimed. (This uses the fact that  $X_2 = X_{12}Y_1$ .)

The boundedness assumptions imply that all the sums considered above are finite.  $\square$

**Corollary 7.33.** *Fix a module-map primitive  $\mathbf{q}$  compatible with module diagonal primitives  $\mathbf{p}^1$  and  $\mathbf{p}^2$ . Let  $\mathbf{m}^i$  be the module diagonal induced by  $\mathbf{p}^i$  and let  $\ell$  be any module-map diagonal compatible with  $\mathbf{m}^1$  and  $\mathbf{m}^2$ . Then for any  $A_\infty$ -modules  $\mathcal{M}_1$ ,  $\mathcal{M}_2$ , and  $\mathcal{N}$ , type DD structure  $P$ , and  $A_\infty$ -module homomorphism  $f: \mathcal{M}_1 \rightarrow \mathcal{M}_2$  (with either  $P$  operationally bounded or all the other objects bonsai), the chain maps*

$$[f \boxtimes \mathbb{I}_P \boxtimes \mathbb{I}_N]_{\ell}$$

and

$$(f \boxtimes_{\mathbf{q}} \mathbb{I}_P) \boxtimes \mathbb{I}_N$$

are chain homotopic.

*Proof.* As in the unweighted case, this is immediate from Lemma 7.32 and the fact that all partial weighted module-map diagonals are homotopic (Lemma 6.52).  $\square$

**7.4. Tensor products of homotopy unital weighted algebras and associativity of the tensor product.** Homotopy unital diagonals allow us to define various tensor products:

- Given a homotopy unital algebra diagonal  $u\Gamma^{*,*}$  and homotopy unital  $w$ -algebras  $\mathcal{A}$  and  $\mathcal{B}$  over  $\mathbb{k}_1$  and  $\mathbb{k}_2$ , respectively, the tensor product  $A \otimes_R B$  inherits the structure of a homotopy unital  $w$ -algebra  $\mathcal{A} \otimes_{u\Gamma} \mathcal{B}$  over  $\mathbb{k}$  via the composition

$$\begin{aligned} uX_*^{n,w} &\xrightarrow{u\Gamma^{*,*}} \bigoplus_{w_1+w_2 \leq w} uX_*^{n,w_1} \otimes_R uX_*^{n,w_2} \otimes_R R[Y_1, Y_2] \\ &\xrightarrow{\mu_{\mathcal{A}} \otimes \mu_{\mathcal{B}}} \text{Mor}(A^{\otimes n}, A) \otimes_R \text{Mor}(B^{\otimes n}, B) \rightarrow \text{Mor}((A \otimes B)^{\otimes n}, A \otimes B \langle\langle (4 - \kappa_1 - \kappa_2)w \rangle\rangle). \end{aligned}$$

- Similarly, given a homotopy unital module diagonal  $u\mathbf{M}^{*,*}$  compatible with  $u\Gamma^{*,*}$ , and homotopy unital  $w$ -modules  $\mathcal{M}$  and  $\mathcal{N}$  over  $\mathcal{A}$  and  $\mathcal{B}$ , the tensor product  $M \otimes_R N$  inherits the structure of a homotopy unital  $w$ -module  $\mathcal{M} \otimes_{u\mathbf{M}} \mathcal{N}$  over  $\mathcal{A} \otimes_{u\Gamma} \mathcal{B}$  via the composition

$$uXM_*^{1+n,w} \xrightarrow{u\mathbf{M}^{*,*}} \bigoplus_{w_1+w_2 \leq w} uXM_*^{1+n,w_1} \otimes_R uXM_*^{1+n,w_2} \otimes_R R[Y_1, Y_2]$$

$$\xrightarrow{m_{\mathcal{M}} \otimes m_{\mathcal{N}}} \text{Mor}((M \otimes_R N) \otimes (A \otimes_R B)^{\otimes n}, M \otimes_N \langle\langle (4 - \kappa_1 - \kappa_2)w \rangle\rangle).$$

- Similarly, given a homotopy unital map diagonal  $u\Theta^{n,w}$  compatible with  $u\Gamma_1^{*,*}$  and  $u\Gamma_2^{*,*}$ , as well as homotopy unital algebra maps  $f: \mathcal{A}_1 \rightarrow \mathcal{A}_2$  and  $g: \mathcal{B}_1 \rightarrow \mathcal{B}_2$  there is an induced tensor product

$$f \otimes_{u\Theta} g: \mathcal{A}_1 \otimes_{u\Gamma_1} \mathcal{B}_1 \rightarrow \mathcal{A}_2 \otimes_{u\Gamma_2} \mathcal{B}_2.$$

- Similarly, given a homotopy unital module-map diagonal  $u\mathbf{L}^{n,w}$  compatible with  $u\mathbf{M}_1^{*,*}$  and  $u\mathbf{M}_2^{*,*}$ , as well as homotopy unital module maps  $f: \mathcal{M}_1 \rightarrow \mathcal{M}_2$  and  $g: \mathcal{N}_1 \rightarrow \mathcal{N}_2$  there is an induced tensor product

$$f \otimes_{u\mathbf{L}} g: \mathcal{M}_1 \otimes_{u\mathbf{M}_1} \mathcal{N}_1 \rightarrow \mathcal{M}_2 \otimes_{u\mathbf{M}_2} \mathcal{N}_2.$$

These homotopy unital tensor product have similar properties to the cases spelled out above:

**Theorem 7.34.** *These tensor products have the following properties:*

- (1) *If  $f: \mathcal{A}_1 \rightarrow \mathcal{A}_2$  and  $g: \mathcal{B}_1 \rightarrow \mathcal{B}_2$  are quasi-isomorphisms then*

$$f \otimes_{u\Theta} g: \mathcal{A}_1 \otimes_{u\Gamma_1} \mathcal{B}_1 \rightarrow \mathcal{A}_2 \otimes_{u\Gamma_2} \mathcal{B}_2.$$

*is a quasi-isomorphism. In particular:*

- (a) *If  $\mathcal{A}_1$  is quasi-isomorphic to  $\mathcal{B}_1$  and  $\mathcal{A}_2$  is quasi-isomorphic to  $\mathcal{B}_2$ , then  $\mathcal{A}_1 \otimes_{u\Gamma} \mathcal{A}_2$  is quasi-isomorphic to  $\mathcal{B}_1 \otimes_{u\Gamma} \mathcal{B}_2$ .*  
 (b) *If  $u\Gamma_1^{*,*}$  and  $u\Gamma_2^{*,*}$  are homotopy unital weighted algebra diagonals with the same seed, then  $\mathcal{A}_1 \otimes_{u\Gamma_1} \mathcal{A}_2$  is isomorphic to  $\mathcal{A}_1 \otimes_{u\Gamma_2} \mathcal{A}_2$ .*  
 (2) *If  $\mathcal{A}$  and  $\mathcal{B}$  are strictly unital weighted algebras and  $u\Gamma^{*,*}$  is a homotopy unital algebra diagonal extending  $\Gamma^{*,*}$  then the (weakly unital) weighted algebra  $\mathcal{A} \otimes_{\Gamma} \mathcal{B}$  is the image of the homotopy unital weighted algebra  $\mathcal{A} \otimes_{u\Gamma} \mathcal{B}$  under the forgetful map. Similar statements hold for modules, algebra maps, and module maps.*  
 (3) *Given homotopy unital module morphisms*

$$\mathcal{M}^1 \xrightarrow{f_1} \mathcal{M}^2 \xrightarrow{f_2} \mathcal{M}^3 \quad \mathcal{N}^1 \xrightarrow{g_1} \mathcal{N}^2 \xrightarrow{g_2} \mathcal{N}^3,$$

*we have*

$$(7.35) \quad (f_2 \circ f_1) \otimes_{u\mathbf{L}_{13}} (g_2 \circ g_1) \sim (f_2 \otimes_{u\mathbf{L}_{23}} g_2) \circ (f_1 \otimes_{u\mathbf{L}_{12}} g_1)$$

$$(7.36) \quad d(f_1 \otimes_{u\mathbf{L}_{12}} g_1) = (df_1) \otimes_{u\mathbf{L}_{12}} g_1 + f_1 \otimes_{u\mathbf{L}_{12}} (dg_1).$$

- (4) *If  $u\mathbf{L}_1^{*,*}$  and  $u\mathbf{L}_2^{*,*}$  are homotopic homotopy unital module-map diagonals then  $f \otimes_{u\mathbf{L}_{12}} g$  and  $f \otimes_{u\mathbf{L}_{12}} g$  are homotopic homotopy unital module-maps.*  
 (5) *If  $\mathcal{M}$  and  $\mathcal{N}$  are homotopy unital weighted modules then the tensor product of their identity maps*

$$\mathbb{I}_{\mathcal{M}} \otimes_{u\mathbf{L}} \mathbb{I}_{\mathcal{N}}: \mathcal{M} \otimes_{u\mathbf{M}_1} \mathcal{N} \rightarrow \mathcal{M} \otimes_{u\mathbf{M}_2} \mathcal{N}$$

*is an isomorphism. Consequently, the tensor product of two homotopy equivalences is a homotopy equivalence.*

*Proof.* The proof Part (1) is analogous to the proof of Theorem 1.1 or 1.12. Part (2) is immediate from the definitions. The proofs of Parts (3) and (4) are similar to the proof of Proposition 7.13 (or Proposition 3.29) and Lemma 3.28. The proof of Part (5) is similar to the proof of Lemma 7.16.  $\square$

**Theorem 7.37.** *Let  $\mathcal{A}_1$ ,  $\mathcal{A}_2$ , and  $\mathcal{A}_3$  be homotopy unital  $w$ -algebras over  $\mathbb{k}_1$ ,  $\mathbb{k}_2$  and  $\mathbb{k}_3$ , respectively. Fix homotopy unital algebra diagonals  $u\Gamma_1^{*,*}$  and  $u\Gamma_2^{*,*}$ . View  $\mathcal{A}_1 \otimes_{u\Gamma_1} \mathcal{A}_2$  as a homotopy unital weighted algebra over  $\mathbb{k}_{12} := \mathbb{k}_1 \otimes_R \mathbb{k}_2$ , and view  $\mathcal{A}_2 \otimes_{u\Gamma_2} \mathcal{A}_3$  as a homotopy unital weighted algebra over  $\mathbb{k}_{23} := \mathbb{k}_2 \otimes_R \mathbb{k}_3$ . View  $\mathbb{k}_{12}$  as an  $R[Y_1]$ -algebra by sending  $Y_1 \mapsto Y_{12} := Y_1 Y_2$ , and view  $\mathbb{k}_{23}$  as an  $R[Y_2]$ -algebra by sending  $Y_2 \mapsto Y_{23} := Y_2 Y_3$ . Then there is a homotopy unital isomorphism*

$$(\mathcal{A}_1 \otimes_{u\Gamma_1} \mathcal{A}_2) \otimes_{u\Gamma_2} \mathcal{A}_3 \cong \mathcal{A}_1 \otimes_{u\Gamma_1} (\mathcal{A}_2 \otimes_{u\Gamma_2} \mathcal{A}_3)$$

over  $\mathbb{k}_1 \otimes_R \mathbb{k}_2 \otimes_R \mathbb{k}_3$ .

*Proof.* The proof is similar to the unweighted case, point (A4) in Theorem 1.1. We define a *homotopy unital algebra double diagonal* to be a collection of chain maps

$$u\mathbf{\Gamma}^{n,w} : uX_*^{n,w} \rightarrow \bigoplus_{w_1, w_2, w_3 \leq w} uX_*^{n, w_1} \otimes_R uX_*^{n, w_2} \otimes_R uX_*^{n, w_3} \otimes_R R[Y_1, Y_2, Y_3]$$

which respect composition and so that

$$\begin{aligned} u\mathbf{\Gamma}^{0,0}(\top) &= \top \otimes \top \otimes \top \\ u\mathbf{\Gamma}^{1,0}(\downarrow) &= \downarrow \otimes \downarrow \otimes \downarrow \\ u\mathbf{\Gamma}^{2,0}(\Psi_2^0) &= \Psi_2^0 \otimes \Psi_2^0 \otimes \Psi_2^0. \end{aligned}$$

The *seed* of  $u\mathbf{\Gamma}^{*,*}$  is  $u\mathbf{\Gamma}^{0,1}$ . Define a homotopy unital algebra map double diagonal similarly, using the transformation thorn trees complex. Then:

- (1) Both  $(\mathbb{I} \otimes u\mathbf{\Gamma}_2^{*,*} |_{(Y_1, Y_2) \rightarrow (Y_2, Y_3)}) \circ (u\mathbf{\Gamma}_1^{*,*} |_{Y_2 \rightarrow Y_2 Y_3})$  and  $(u\mathbf{\Gamma}_1^{*,*} \otimes \mathbb{I}) \circ (u\mathbf{\Gamma}_2^{*,*} |_{(Y_1, Y_2) \rightarrow (Y_1 Y_2, Y_3)})$  are homotopy unital algebra double diagonals. Here, the subscripts indicate variable substitutions; for example,  $(Y_1, Y_2) \rightarrow (Y_2, Y_3)$  indicates the substitution replacing  $Y_1$  by  $Y_2$  and  $Y_2$  by  $Y_3$ .
- (2) A homotopy unital algebra double diagonal allows one to define a triple tensor product  $\mathcal{A}_1 \otimes_R \mathcal{A}_2 \otimes_R \mathcal{A}_3$  and a homotopy unital algebra map double diagonal allows one to define a triple tensor product of maps  $f_1 \otimes f_2 \otimes f_3$ .
- (3) A triple tensor product of quasi-isomorphisms is a quasi-isomorphism and a triple tensor product of isomorphisms is an isomorphism. (Both statements use the nondegeneracy condition for the diagonals, and the second statement uses Lemma 4.81.)
- (4) Any two homotopy algebra double diagonals with the same seed are related by a homotopy unital algebra map double diagonal.
- (5) The two homotopy unital double diagonals in point (1) have the same seed.

The result follows.  $\square$

**Corollary 7.38.** *Let  $\mathcal{A}$ ,  $\mathcal{B}$ , and  $\mathcal{C}$  be split unital weighted algebras over  $\mathbb{k}_1$ ,  $\mathbb{k}_2$ , and  $\mathbb{k}_3$ , and  $\mathbf{\Gamma}_1^{*,*}$  and  $\mathbf{\Gamma}_2^{*,*}$  weighted algebra diagonals. Let  $\overline{\mathcal{A} \otimes_{\mathbf{\Gamma}_1} \mathcal{B}}$  be the result of tensoring together  $\mathcal{A}$  and  $\mathcal{B}$  using  $\mathbf{\Gamma}_1^{*,*}$  as in Definition 7.3 and then making the result strictly unital as in Theorem 4.25. Similarly, let  $\overline{\mathcal{B} \otimes_{\mathbf{\Gamma}_2} \mathcal{C}}$  be the result of tensoring together  $\mathcal{B}$  and  $\mathcal{C}$  using  $\mathbf{\Gamma}_2^{*,*}$  and then making the result strictly unital. View  $\mathbb{k}_{12}$  as an  $R[Y_1]$ -algebra by sending  $Y_1 \mapsto Y_{12} := Y_1 Y_2$ , and view  $\mathbb{k}_{23}$  as an  $R[Y_2]$ -algebra by sending  $Y_2 \mapsto Y_{23} := Y_2 Y_3$ . Then there is an isomorphism*

$$\overline{\mathcal{A} \otimes_{\mathbf{\Gamma}_1} \mathcal{B} \otimes_{\mathbf{\Gamma}_2} \mathcal{C}} \cong \overline{\mathcal{A} \otimes_{\mathbf{\Gamma}_1} \overline{\mathcal{B} \otimes_{\mathbf{\Gamma}_2} \mathcal{C}}}.$$

*Proof.* Fix homotopy unital weighted algebra diagonals  $u\mathbf{\Gamma}_i^{*,*}$  extending  $\mathbf{\Gamma}_i^{*,*}$ . Let  $\mathcal{F}$  be the forgetful functor from homotopy unital algebras to ordinary algebras. By Theorem 7.34,

$$\begin{aligned} \mathcal{F}(\mathcal{A} \otimes_{u\mathbf{\Gamma}_1} \mathcal{B}) &\cong \mathcal{A} \otimes_{\mathbf{\Gamma}_1} \mathcal{B} \\ \mathcal{F}(\overline{\mathcal{B} \otimes_{u\mathbf{\Gamma}_2} \mathcal{C}}) &\cong \overline{\mathcal{B} \otimes_{\mathbf{\Gamma}_2} \mathcal{C}}. \end{aligned}$$

Let  $\overline{\mathcal{A} \otimes_{u\mathbf{\Gamma}_1} \mathcal{B}}$  and  $\overline{\mathcal{B} \otimes_{u\mathbf{\Gamma}_2} \mathcal{C}}$  be strictly unital weighted algebras which are homotopy unital isomorphic to  $\mathcal{A} \otimes_{u\mathbf{\Gamma}_1} \mathcal{B}$  and  $\overline{\mathcal{B} \otimes_{u\mathbf{\Gamma}_2} \mathcal{C}}$ , respectively, the existence of which is guaranteed by Theorem 4.92. Then

$$\begin{aligned} \mathcal{F}(\overline{\mathcal{A} \otimes_{u\mathbf{\Gamma}_1} \mathcal{B}}) &\cong \overline{\mathcal{A} \otimes_{\mathbf{\Gamma}_1} \mathcal{B}} \\ \mathcal{F}(\overline{\mathcal{B} \otimes_{u\mathbf{\Gamma}_2} \mathcal{C}}) &\cong \overline{\mathcal{B} \otimes_{\mathbf{\Gamma}_2} \mathcal{C}}. \end{aligned}$$

By Theorems 7.34 and 7.37,

$$(\overline{\mathcal{A} \otimes_{u\mathbf{\Gamma}_1} \mathcal{B}}) \otimes_{u\mathbf{\Gamma}_2} \mathcal{C} \cong (\mathcal{A} \otimes_{u\mathbf{\Gamma}_1} \mathcal{B}) \otimes_{u\mathbf{\Gamma}_2} \mathcal{C}$$

$$\begin{aligned} &\cong \mathcal{A} \otimes_{u\Gamma_1} (\mathcal{B} \otimes_{u\Gamma_2} \mathcal{C}) \\ &\cong \mathcal{A} \otimes_{u\Gamma_1} \overline{\mathcal{B} \otimes_{u\Gamma_2} \mathcal{C}}. \end{aligned}$$

Applying the forgetful functor and Theorem 7.34 again gives the result.  $\square$

*Remark 7.39.* If we think of  $Y_i$  as associated to the algebra  $\mathcal{A}_i$ , then Corollary 7.38 says that the  $Y$ -variable associated to  $\mathcal{A}_1 \otimes_{\Gamma} \mathcal{A}_2$  should be  $Y_{12} = Y_1 Y_2$ . Similarly, a category of weighted type  $D$  structures is associated to a pair  $(\mathcal{A}_i, X_i)$ , and Definition 7.23 implies that these charges should satisfy  $X_2 = X_{12} Y_1$  (and similarly  $X_1 = X_{12} Y_2$ ). (That is, the 1-sided box tensor product relates the category of type  $DD$  structures associated to  $(\mathcal{A}_1 \otimes_{\Gamma} \mathcal{A}_2, X_{12})$ , the category of  $w$ -modules over  $(\mathcal{A}_1, Y_1)$ , and the category of type  $D$  structures over  $(\mathcal{A}_2, X_{12} Y_1)$ .) In particular, this suggests considering variables satisfying

$$(7.40) \quad X_1 Y_1 = X_2 Y_2 = X_{12} Y_{12}.$$

Recall that the grading of  $X_i$  is  $-\kappa_i$ , and of  $Y_i$  is  $\kappa_i - 2$ . So, all terms in Equation (7.40) have grading  $-2$ . (In bordered Floer theory,  $X_i Y_i$  will be the variable  $U$ , which corresponds in monopole Floer theory to a generator of  $H^2(\mathbb{C}P^\infty)$ .)

On a related point, if  $\mathcal{A}^1 P$  and  $\mathcal{A}^2 Q$  are type  $D$  structures then one might try to define an operation  $\delta^1$  on  $P \otimes_R Q$ , making  $P \otimes_R Q$  into a type  $DD$  structure, by  $\delta^1 = \delta_P^1 \otimes \mathbf{1} + \mathbf{1} \otimes \delta_Q^1$ . It is not hard to see that the type  $DD$  structure relation for this type  $DD$  structure would require the charge to be  $X_2/Y_1 = X_1/Y_2$ . (Even then, it is not apparent that this operation  $\delta^1$  satisfies the type  $DD$  structure relation for a general diagonal; a correct, general definition of the external tensor product of two type  $D$  structures, when variables are chosen as above, can be given using a DADD diagonal, as in Section 3.6.2.)

**7.5. The category of type  $D$  structures over a homotopy unital algebra and independence of the category of type  $DD$  structures from the algebra diagonal.** We now show that the  $A_\infty$ -category of type  $D$  structures over a homotopy unital weighted  $A_\infty$ -algebra is itself an (unweighted) homotopy unital category. We start with some definitions.

**Definition 7.41.** *Let  $\mathcal{A}$  be a homotopy unital weighted  $A_\infty$ -algebra over  $\mathbb{k}$  and let  $X \in \mathbb{k}$  be an element acting centrally on every module under consideration. Recall that there is an underlying weighted  $A_\infty$ -algebra  $\mathcal{A}'$  of  $\mathcal{A}$ . A type  $D$  structure over  $\mathcal{A}$  with charge  $X$  is simply a type  $D$  structure over  $\mathcal{A}'$  with charge  $X$  (Definition 4.60).*

*Remark 7.42.* Implicitly, in Definition 7.41, we are assuming that either  $\mathcal{A}'$  is bonsai or the type  $D$  structure is bounded.

**Definition 7.43.** *The unweighted thorn trees complex  $uX_*^n$  is the subcomplex  $uX_*^{n,0}$  of the thorn trees complex (Definition 4.69).*

**Definition 7.44.** *A homotopy unital  $A_\infty$ -category  $\mathcal{C}$  consists of*

- a collection of objects  $\text{Ob}(\mathcal{C})$ ;
- for each pair of objects  $C_1, C_2$ , a chain complex  $\text{Mor}_{\mathcal{C}}(C_0, C_1)$ ; and
- for each  $n \geq 0$  and each sequence  $C_0, \dots, C_n$  of objects of  $\mathcal{C}$ , a chain map

$$\mu_{\mathcal{C}}: uX_*^n \rightarrow \text{Mor}(\text{Mor}_{\mathcal{C}}(C_0, C_1) \otimes \dots \otimes \text{Mor}_{\mathcal{C}}(C_{n-1}, C_n), \text{Mor}_{\mathcal{C}}(C_0, C_n))$$

so that  $\mu_{\mathcal{C}}(S \circ_i T) = \mu_{\mathcal{C}}(S) \circ_i \mu_{\mathcal{C}}(T)$ . (In the special case  $n = 0$ ,  $\mu_{\mathcal{C}}: uX_*^n \rightarrow \text{Mor}(C_0, C_0)$ .)

To define a homotopy unital structure on the category of type  $D$  structures, it suffices to define the unit  $\mathbb{I}_P^1$  and the corollas  $\mu_{n_1 \uparrow \dots \uparrow n_k}$ . We distinguish between the maps  $\mu_{\mathcal{A}}$  on the underlying homotopy-unital  $A_\infty$ -algebra and  $\mu_D$  for the category of type  $D$  structures.



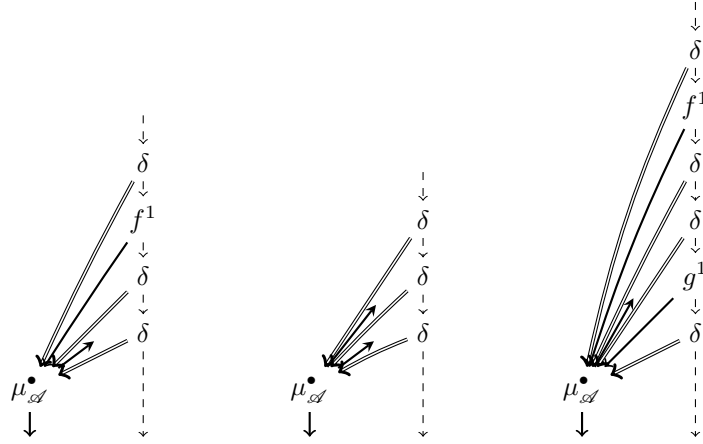
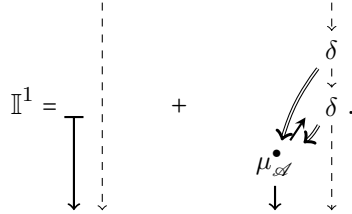

FIGURE 47. **Examples of homotopy unital compositions on the category of type  $D$  structures.** Left:  $\mu_D(\Psi_{1\uparrow}^0)$ . Center:  $\mu_D(\Psi_{\uparrow\uparrow}^0)$ . Right:  $\mu_D(\Psi_{1\uparrow 1}^0)$

**Definition 7.45.** Given a homotopy unital weighted algebra  $\mathcal{A}$  and a type  $D$  structure  ${}^{\mathcal{A}}P$  over  $\mathcal{A}$  with charge  $X$ , with either  $\mathcal{A}$  bonsai or  ${}^{\mathcal{A}}P$  operationally bounded, the identity map of  ${}^{\mathcal{A}}P$  is defined by

$$\mathbb{I}^1(x) = \mathbf{1} \otimes x + \sum_{n_1, n_2, w} X^w (\mu_{\mathcal{A}, n_1 \uparrow n_2}^w \otimes \mathbb{I}_P) \circ \delta^{n_1 + n_2}(x)$$

or, graphically,



(In the formula,  $\mathbb{I}_P$  means the identity map of the vector space  $P$ . Also, recall that  $\mu^\bullet = \sum_{n,w} X^w \mu_n^w$ .)

**Convention 7.46.** To keep statements simpler, in the rest of this section we will suppress the boundedness hypotheses. In each case, either the weighted  $A_\infty$ -algebras and weighted  $A_\infty$ -algebra homomorphisms involved are required to be bonsai or the weighted type  $D$  and  $DD$  structures are required to be operationally bounded.

**Definition 7.47.** Given a homotopy unital weight algebra  $\mathcal{A}$ , a corolla  $\Psi_{n_1 \uparrow \dots \uparrow n_k}^w$  with a total of  $N = \sum_{i=1}^k n_i$  inputs, a sequence of  $N+1$  type  $D$  structures  ${}^{\mathcal{A}}P_j$  with structure map  $\delta_j^1$  and charge  $X$ , and type  $D$  morphisms  $\phi_j$  between them, define the interpretation of the corolla by interspersing an arbitrary number of  $\delta_j^1$  inputs among the inputs to the corolla, as shown by example in Figure 47 and defined formally by

$$(7.48) \quad \mu_D(\Psi_{n_1 \uparrow \dots \uparrow n_k})(\phi_1, \dots, \phi_N) = \sum_w X^w \sum_{m_0, \dots, m_N=0}^{\infty} \sum'_{M_1, \dots, M_k=0}^{\infty} \left( (\mu_{\mathcal{A}, n_1 + M_1 \uparrow n_2 + M_2 \uparrow \dots \uparrow n_k + M_k}^w \otimes \mathbb{I}_{P_N}) \right. \\ \left. \circ (\mathbb{I} \otimes \delta_N^{m_0}) \circ (\mathbb{I} \otimes \phi_N) \circ \dots \circ (\mathbb{I} \otimes \delta_1^{m_1}) \circ (\mathbb{I} \otimes \phi_1) \circ \delta_0^{m_0} \right)$$

where the sum over the  $M_i$  is constrained to make the arrows properly interspersed: we require

$$\sum_{i=1}^k M_i = \sum_{i=0}^N m_i$$

and, for  $1 \leq j \leq k$ ,

$$\sum_{i=0}^{n_1+\dots+n_{j-1}} m_i \leq \sum_{i=1}^j M_i \leq \sum_{i=0}^{n_1+\dots+n_j} m_i.$$

**Proposition 7.49.** *Fix a weighted  $A_\infty$ -algebra  $\mathcal{A}$  over  $\mathbb{k}$  and an element  $X \in R$ . The structure maps in Definition 7.47 make the category of type  $D$  structures  $\mathcal{A}^{,X}\text{Mod}$  over  $\mathcal{A}$  with charge  $X$ , where  $\mathcal{A}$  is a homotopy unital weighted algebra, into a homotopy unital  $A_\infty$ -category.*

*Proof.* We have to check that the map  $\mu_D$  defined above is a chain map. We check two special cases before the general case. First, we check that the identity map of  $P$  is a cycle in the morphism complex, i.e.,  $\partial(\mu_D(\tau)) = \mu_D(\partial\tau) = 0$ . We have

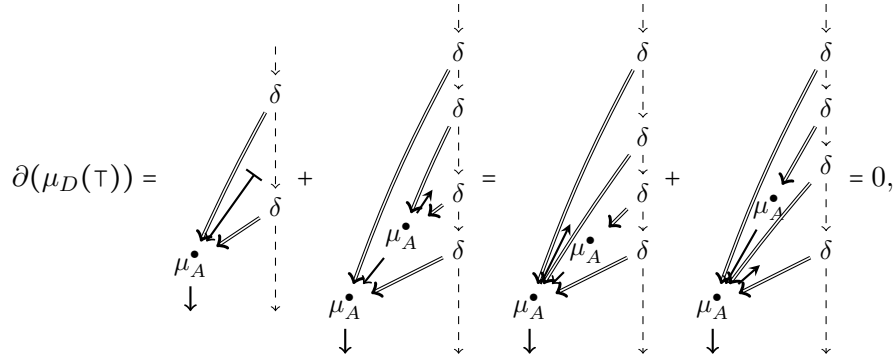

The second equality comes from the homotopy unital  $A_\infty$ -algebra relations. The third equality uses the structure relation for  $P$ .

It remains to prove that

$$\partial(\mu_D(\Psi_{n_1 \uparrow \dots \uparrow n_k})) = \mu_D(\partial\Psi_{n_1 \uparrow \dots \uparrow n_k}).$$

(Actually, we must prove this identity for any tree, but as usual it suffices to prove it for the basic building blocks, namely stumps (above) and corollas (here).) The cases  $\Psi_{\uparrow 1}$  and  $\Psi_{1\uparrow}$  are slightly special, since the differential of a 3-valent vertex with one input a thorn has a term corresponding to erasing that thorn. We check that  $\Psi_{\uparrow 1}$  is a chain map; the case of  $\mu_D(\Psi_{1\uparrow})$  is similar. We have

$$(\partial(\mu_D(\Psi_{\uparrow 1}))) (f) = \partial((\mu_D(\Psi_{\uparrow 1}))(f)) + (\mu_D(\Psi_{\uparrow 1}))(\partial f)$$

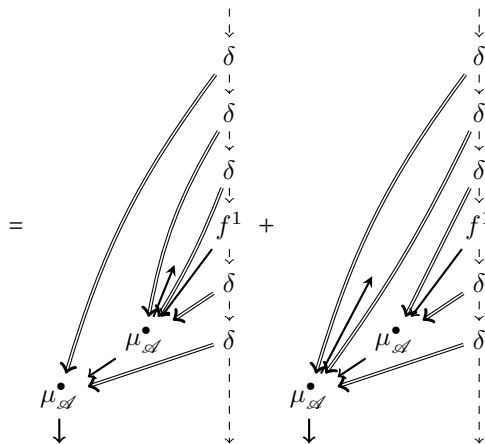

$$(\mu_D(\partial\Psi_{\uparrow 1}))(f) =$$

These are most of the terms coming from the homotopy unital  $A_\infty$ -relation at the  $\mu_{sd}^\bullet$ -vertex of

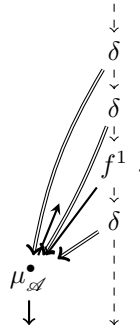

(The term with just the map  $f^1$  corresponds to the case that all of the instances  $\delta$  are the map  $\delta^0 = \mathbb{I}$ .) The remaining terms coming from this  $A_\infty$ -relation, like

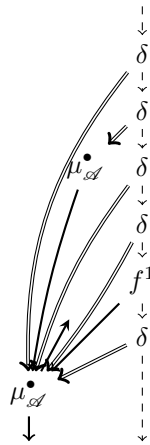

cancel by the type  $D$  structure relation.

The strategy for the remaining cases is similar. We will again show that on the level of operation trees,

$$(7.50) \quad \partial(\mu_D(\Psi_{n_1 \uparrow \dots \uparrow n_k}^w)) + \mu_D(\partial\Psi_{n_1 \uparrow \dots \uparrow n_k}^w) \\ = \sum_{m_i, M_i} \left( ((\mu_{sd}^\bullet(\partial\Psi_{n_1+M_1 \uparrow \dots \uparrow n_k+M_k}^w) + \partial\mu_{sd}^\bullet(\Psi_{n_1+M_1 \uparrow \dots \uparrow n_k+M_k}^w)) \otimes \mathbb{I}_{P_N}) \right)$$

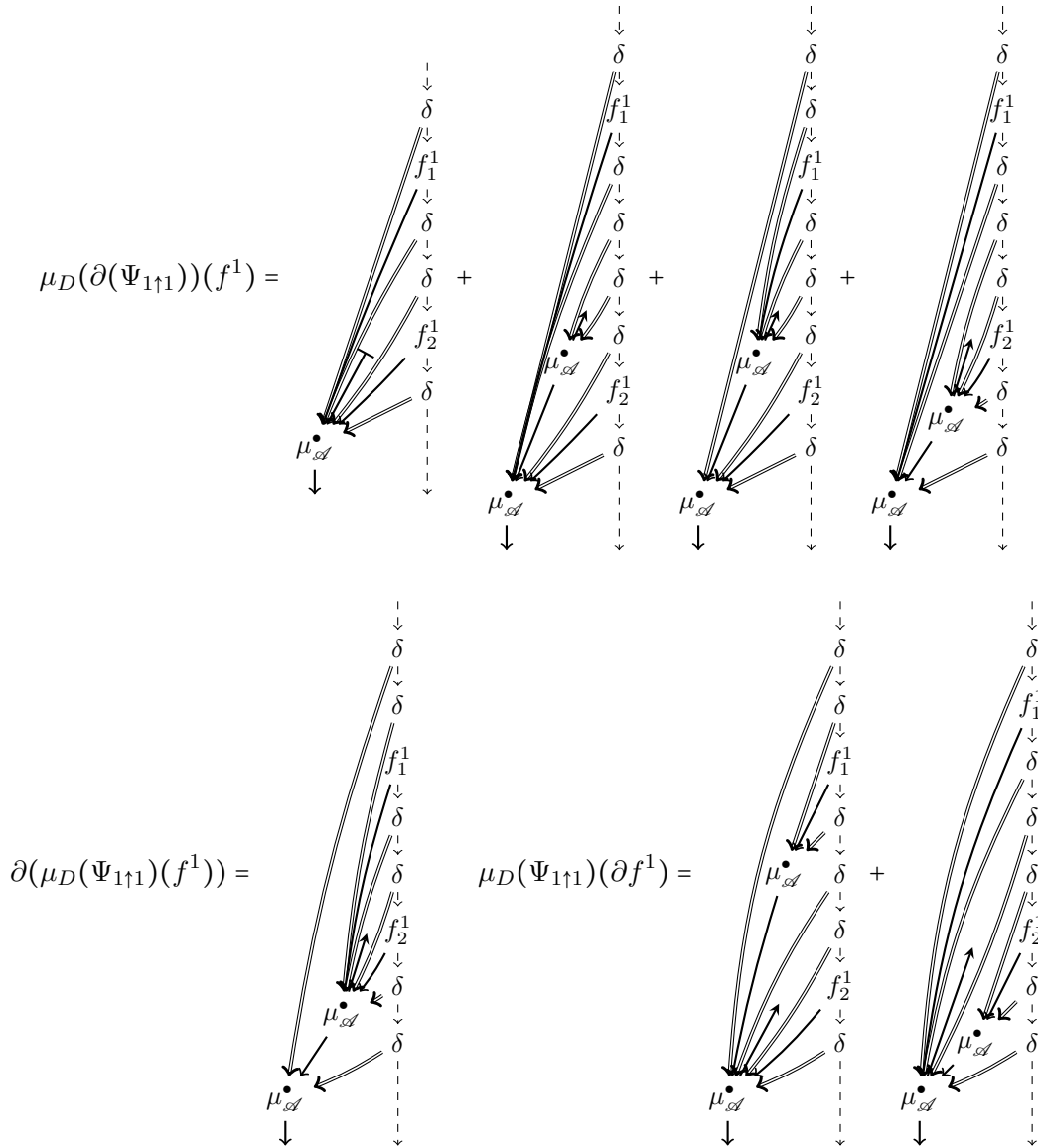

FIGURE 48. **The generic case of the proof of Proposition 7.49.** The case of  $\mu_D(\Psi_{1\uparrow 1})$  is shown. The terms in the first row are of types (1),(A), (1),(C), (2),(F), and (2),(F). The term in the second row is of types (3),(E). The terms in the third row are of types (3),(D). The remaining terms obtained from the weighted  $A_\infty$ -relations cancel by the type  $D$  structure relations.

$$\begin{aligned} & \circ (\mathbb{I} \otimes \delta_N^{m_N}) \circ (\mathbb{I} \otimes \phi_N) \circ \cdots \circ (\mathbb{I} \otimes \delta_1^{m_1}) \circ (\mathbb{I} \otimes \phi_1) \circ \delta_0^{m_0} \\ & + (\text{terms that vanish by the type } D \text{ structure relations}) \end{aligned}$$

where the sum over the  $m_i$  and  $M_i$  is constrained as in Equation (7.48). We will describe the various terms and how they cancel in pairs; Figure 48 shows an example where terms of all of the kinds described appear.

In the  $\mu_D \partial$  part of the left side of Equation (7.50), from the definition of the differential on  $uX_*^n$ , we have terms that

- (1) turn a thorn into a stump; or
- (2) split the corolla into two corollas.

We also have

- (3) terms in  $\partial\mu_D$ , i.e., coming from the differential on the space of type  $D$  morphisms.

On the right side of Equation (7.50), the terms in  $\partial\mu_{\mathcal{A}}$  can be viewed as splittings of a vertex where one of the vertices involved is 2-valent; we will usually not distinguish these terms from other types of splittings. Instead, we divide up the terms a different way. When we split a vertex, we label two resulting vertices as “inner” and “outer”, with the output of the inner vertex feeding into the outer vertex. We consider what kinds of inputs feed into these two vertices: in addition to the strand from the inner vertex to the outer vertex, we have  $\delta$  strands, from one of the  $\delta^{m_i}$  terms, morphism strands from one of the  $\phi_i$ , or thorns. Then on the right side we have terms that

- (A) turn a thorn into a stump;

or splittings with

- (B) only  $\delta$  strands into the inner vertex;
- (C)  $\delta$  strands and one thorn on the inner vertex;
- (D)  $\delta$  strands and one morphism strand on the inner vertex;
- (E) only  $\delta$  strands on the outer vertex (in addition to the strand from the inner vertex); or
- (F) anything else.

(Terms in  $\partial\mu_{\mathcal{A}}$  can only appear in types (B) or (E).)

These terms cancel as follows.

- Terms of type (1) cancel with terms of type (A) and (C).
- Terms of type (B) form relations in the type  $D$  structures.
- Terms of type (3) cancel with terms of type (D). and (E)
- Terms of type (2) cancel with terms of type (F); since a term of type (F) does not fall into one of the other cases, it must correspond to a valid splitting of the vertex in the differential on  $uX_*^n$ . □

**Definition 7.51.** *Given a homotopy unital  $A_\infty$ -category  $\mathcal{C}$ , the homology category  $H_*\mathcal{C}$  of  $\mathcal{C}$  is the category with the same objects as  $\mathcal{C}$  and  $\text{Hom}_{H_*\mathcal{C}}(X, Y) = H_*\text{Mor}_{\mathcal{C}}^{nu}(X, Y)$ , where  $\text{Mor}_{\mathcal{C}}^{nu}(X, Y)$  denotes the space of morphisms in the non-unital  $A_\infty$ -category associated to  $\mathcal{C}$  (by ignoring morphisms with a positive number of thorns or stumps). The identity map in  $\text{Hom}_{H_*\mathcal{C}}(X, Y)$  is the image of the stump.*

**Lemma 7.52.** *Given a homotopy unital  $A_\infty$ -category  $\mathcal{C}$ , the homology category  $H_*\mathcal{C}$  is an ordinary category.*

In other words, Lemma 7.52 asserts that a homotopy unital  $A_\infty$ -category is homologically unital.

*Proof.* We need to check that composition is associative (i.e.,  $(f \circ_2 g) \circ_2 h = f \circ_2 (g \circ_2 h)$ ) and that the image of the stump is an identity (i.e.,  $f \circ_2 \mathbb{I}_X = \mathbb{I}_Y \circ_2 f = f$ ). Both are immediate from the definitions. □

**Definition 7.53.** *Let  $\mathcal{C}$  and  $\mathcal{D}$  be a homotopy unital  $A_\infty$ -categories. A homotopy unital functor  $F: \mathcal{C} \rightarrow \mathcal{D}$  consists of:*

- For each object  $X \in \text{Ob}(\mathcal{C})$ , an object  $F(X) \in \text{Ob}(\mathcal{D})$ , and
- For each sequence of objects  $X_0, \dots, X_n \in \text{Ob}(\mathcal{C})$ , a chain map

$$F: uJ_*^n \rightarrow \text{Mor}(\text{Mor}_{\mathcal{C}}(X_0, X_1) \otimes \dots \otimes \text{Mor}_{\mathcal{C}}(X_{n-1}, X_n), \text{Mor}_{\mathcal{D}}(F(X_0), F(X_n)))$$

so that for  $S \in uX_*^m$  and  $T \in uJ_*^n$

$$F(T \circ_i S) = F(T) \circ_i \mu_{\mathcal{C}}(S)$$

and for  $S_i \in \mathcal{U}J_*^{m_i}$ ,  $i = 1, \dots, n$  and  $T \in \mathcal{U}X_*^n$ ,

$$F(T \circ (S_1, \dots, S_n)) = \mu_{\mathcal{D}}(T) \circ (F(S_1), \dots, F(S_n)).$$

Given a homotopy unital functor  $F: \mathcal{C} \rightarrow \mathcal{D}$ ,  $F$  restricts to a functor of underlying non-unital  $A_\infty$ -categories.

**Lemma 7.54.** *Given a homotopy unital functor  $F: \mathcal{C} \rightarrow \mathcal{D}$ , there is an induced honest functor  $F: H_*\mathcal{C} \rightarrow H_*\mathcal{D}$  of ordinary categories.*

*Proof.* Again, this is immediate from the definitions.  $\square$

**Definition 7.55.** *A homotopy unital functor  $F: \mathcal{C} \rightarrow \mathcal{D}$  is a quasi-equivalence if the induced functor of ordinary categories is an equivalence.*

Given strictly unital  $A_\infty$ -categories  $\mathcal{C}$ ,  $\mathcal{D}$ , an  $A_\infty$ -functor  $F: \mathcal{C} \rightarrow \mathcal{D}$  is *strictly unital* if for each  $X \in \text{Ob}(\mathcal{C})$ ,  $F(\mathbb{1}_X) = \mathbb{1}_{F(X)}$  and for each  $X_1, \dots, X_n \in \text{Ob}(\mathcal{C})$ ,  $n \geq 2$ , and  $f_i \in \text{Mor}_{\mathcal{C}}(X_i, X_{i+1})$ , if some  $f_i = \mathbb{1}_{X_i}$  then  $F(f_{n-1}, \dots, f_1) = 0$ . We note the following analogue of Proposition 3.92:

**Proposition 7.56.** *If  $\mathcal{C}$  and  $\mathcal{D}$  are strictly unital  $A_\infty$ -categories which are homotopy unittally quasi-isomorphic then  $\mathcal{C}$  and  $\mathcal{D}$  are quasi-isomorphic via a strictly unital functor.*

*Proof.* The proof is similar to the proof of Proposition 3.92 or Theorem 4.92 or [Sei08, Lemma 2.1] (see also [Sei08, Remark 2.2]) or [LH03, Theorem 3.2.2.1], and is left to the reader.  $\square$

**Definition 7.57.** *Fix homotopy unital weighted  $A_\infty$ -algebras  $\mathcal{A}$  and  $\mathcal{B}$  over  $\mathbb{k}$ , an element  $X \in \mathbb{k}$  acting centrally on  $\mathcal{A}$  and  $\mathcal{B}$ , and a homotopy unital homomorphism  $F: \mathcal{A} \rightarrow \mathcal{B}$ . Then there is a homotopy unital functor  $F_*: \mathcal{A}^X \text{Mod} \rightarrow \mathcal{B}^X \text{Mod}$  between categories of type  $D$  structures with charge  $X$  defined as follows. On objects,  $F_*$  sends a type  $D$  structure  $(P, \delta_P^1)$  to the same  $\mathbb{k}$ -module  $P$  with operation*

$$\delta_{F_*(P)}^1 = \sum_{n=0}^{\infty} F_n^\bullet \begin{array}{c} \downarrow \\ \delta_P^n \\ \downarrow \end{array} = \sum_{(n,w) \neq (0,0)} X^w F_n^w \begin{array}{c} \downarrow \\ \delta_P^n \\ \downarrow \end{array}.$$

On sequences of morphisms,  $F_*$  is defined by:

$$(7.58) \quad F_*(\mathbf{p}\Psi_{n_1 \uparrow \dots \uparrow n_k})(\phi_1, \dots, \phi_N) = \sum_w X^w \sum_{m_0, \dots, m_N=0}^{\infty} \sum'_{M_1, \dots, M_k=0}^{\infty} \left( (F_{n_1+M_1 \uparrow n_2+M_2 \uparrow \dots \uparrow n_k+M_k}^w \otimes \mathbb{1}_{P_N}) \right. \\ \left. \circ (\mathbb{1} \otimes \delta_N^{m_N}) \circ (\mathbb{1} \otimes \phi_N) \circ \dots \circ (\mathbb{1} \otimes \delta_1^{m_1}) \circ (\mathbb{1} \otimes \phi_1) \circ \delta_0^{m_0} \right)$$

where as in Equation (7.48) we constrain the sum over  $M_i$  to make the arrows properly interspersed. That is, the map  $F_*$  is obtained by feeding the outputs of the type  $D$  structure morphisms into the corolla, interspersed with an arbitrary number of  $\delta_j^1$  outputs, in all ways compatible with the thorns. (For a graphical representation of a few cases, see Figure 47, and replace the vertex  $\mu_{\mathcal{A}}^\bullet$  with  $F^\bullet$ .)

**Proposition 7.59.** *Definition 7.57 defines a homotopy unital functor. Further, if  $F$  is an isomorphism then  $F_*$  is a quasi-equivalence.*

*Proof.* The proof of the first statement is similar to the proof of Proposition 7.49, and is left to the reader.

For the second statement, it suffices to verify that for each pair of type  $D$  structures  ${}^{\mathcal{A}}P$ ,  ${}^{\mathcal{A}}Q$ , the map

$$F_*(\mathbf{p}\Psi_1): \text{Mor}({}^{\mathcal{A}}P, {}^{\mathcal{A}}Q) \rightarrow \text{Mor}({}^{\mathcal{B}}F_*(P), {}^{\mathcal{B}}F_*(Q))$$

induces an isomorphism on homology; in fact, we will show that if  $G$  is the inverse of  $F$  then  $F_*(\mathbf{p}\Psi_1)$  is an isomorphism of chain complexes, with inverse given by  $G_*(\mathbf{p}\Psi_1)$ . (Essential surjectivity of the map of homology categories induced by  $F_*$  is clear from this and invertibility of  $F$ .)

By definition,

$$F_*(\mathbf{p}\Psi_1)(\phi^1) = \begin{array}{c} \downarrow \\ \delta \\ \downarrow \\ \phi^1 \\ \downarrow \\ \delta \\ \downarrow \\ F^\bullet \\ \downarrow \end{array} .$$

Let

$$\underline{F}^\bullet = \sum_{m=1}^{\infty} (F^\bullet \otimes \cdots \otimes F^\bullet): \bigoplus_n A^{\otimes n} \rightarrow \bigoplus_m B^{\otimes m},$$

i.e.,

$$\begin{array}{c} \downarrow \\ \underline{F}^\bullet \\ \downarrow \end{array} = \sum \begin{array}{c} \downarrow \downarrow \downarrow \downarrow \\ F^\bullet F^\bullet \cdots F^\bullet F^\bullet \\ \downarrow \downarrow \downarrow \downarrow \end{array} .$$

The fact that  $G$  is the inverse to  $F$  implies that the composition

$$\begin{array}{c} \downarrow \\ \underline{F}^\bullet \\ \downarrow \\ G^\bullet \\ \downarrow \end{array}$$

is the identity map  $A \rightarrow A$  (and vanishes on  $A^{\otimes m}$  for  $m > 1$ ). So,

$$G_*(\mathbf{p}\Psi_1)(F_*(\mathbf{p}\Psi_1)(\phi^1)) = \begin{array}{c} \downarrow \\ \delta \\ \downarrow \\ \underline{F}^\bullet \\ \downarrow \\ \delta \\ \downarrow \\ \phi^1 \\ \downarrow \\ \delta \\ \downarrow \\ F^\bullet \\ \downarrow \\ \delta \\ \downarrow \\ \underline{F}^\bullet \\ \downarrow \\ G^\bullet \\ \downarrow \end{array} = \begin{array}{c} \downarrow \\ \delta \\ \downarrow \\ \phi^1 \\ \downarrow \end{array} .$$

So,  $G_*(\mathbf{p}\Psi_1) \circ F_*(\mathbf{p}\Psi_1)$  is the identity map of  $\text{Mor}({}^{\mathcal{A}}P, {}^{\mathcal{A}}Q)$ . Similarly,  $F_*(\mathbf{p}\Psi_1) \circ G_*(\mathbf{p}\Psi_1)$  is the identity map of  $\text{Mor}({}^{\mathcal{B}}F_*(P), {}^{\mathcal{B}}F_*(Q))$ . This proves the result.  $\square$

**Definition 7.60.** Let  $\mathcal{A}$  and  $\mathcal{B}$  be homotopy unital  $A_\infty$ -algebras over  $\mathbb{k}_1$  and  $\mathbb{k}_2$ ,  $X_{12} \in \mathbb{k}$ , and  $u\Gamma^{*,*}$  a homotopy unital algebra diagonal. Then the homotopy unital category of type  $DD$  structures over  $\mathcal{A}$  and  $\mathcal{B}$  with charge  $X_{12}$  is the homotopy unital category of type  $D$  structures over  $\mathcal{A} \otimes_{u\Gamma} \mathcal{B}$  with charge  $X_{12}$ .

**Corollary 7.61.** Let  $\mathcal{A}$  and  $\mathcal{B}$  be homotopy unital  $A_\infty$ -algebras over  $\mathbb{k}_1$  and  $\mathbb{k}_2$  and let  $X_{12} \in \mathbb{k}$ . Let  $u\Gamma_1^{*,*}$  and  $u\Gamma_2^{*,*}$  be homotopy unital algebra diagonals with the same seed. Then the categories of type  $DD$  structures over  $\mathcal{A}$  and  $\mathcal{B}$  with charge  $X_{12}$  with respect to  $u\Gamma_1^{*,*}$  and  $u\Gamma_2^{*,*}$  are quasi-equivalent.

*Proof.* By Theorem 7.34, there is a homotopy unital isomorphism  $\mathcal{A} \otimes_{u\Gamma_1} \mathcal{B} \rightarrow \mathcal{A} \otimes_{u\Gamma_2} \mathcal{B}$ . So, this follows from Proposition 7.59.  $\square$

We finally reach the goal of this discussion, a result not mentioning homotopy unitality at all:

**Theorem 7.62.** Given split unital weighted  $A_\infty$ -algebras  $\mathcal{A}$  and  $\mathcal{B}$  over  $\mathbb{k}_1$  and  $\mathbb{k}_2$ , respectively;  $X_{12} \in \mathbb{k}$ ; weighted diagonals  $\Gamma_1^{*,*}$  and  $\Gamma_2^{*,*}$ ; and strictly unital weighted algebras  $\mathcal{C}_i$  isomorphic to  $\mathcal{A} \otimes_{\Gamma_i} \mathcal{B}$ , the (strictly unital) categories of type  $D$  structures  $\mathcal{C}_{1,X_{12}}\text{Mod}$  and  $\mathcal{C}_{2,X_{12}}\text{Mod}$  with charge  $X_{12}$  are quasi-equivalent.

*Proof.* Let  $u\Gamma_i^{*,*}$  be a homotopy unital diagonal extending  $\Gamma_i^{*,*}$ , so  $\mathcal{A} \otimes_{u\Gamma_i} \mathcal{B}$  is a homotopy unital algebra with underlying non-unital algebra  $\mathcal{A} \otimes_{\Gamma_i} \mathcal{B}$ . By Theorem 4.92, there is a strictly unital algebra  $\mathcal{C}'_i$  homotopy unitaly isomorphic to  $\mathcal{A} \otimes_{u\Gamma_i} \mathcal{B}$ . By Theorem 7.34,  $\mathcal{A} \otimes_{u\Gamma_1} \mathcal{B}$  and  $\mathcal{A} \otimes_{u\Gamma_2} \mathcal{B}$  are homotopy unitaly isomorphic. So, by Proposition 7.59, the categories of type  $D$  structures over  $\mathcal{C}'_1$ ,  $\mathcal{A} \otimes_{\Gamma_1} \mathcal{B}$ ,  $\mathcal{A} \otimes_{\Gamma_2} \mathcal{B}$ , and  $\mathcal{C}'_2$  are all quasi-equivalent. On the other hand, by Proposition 4.29,  $\mathcal{C}_i$  and  $\mathcal{C}'_i$  are strictly unitaly quasi-isomorphic, so the categories of type  $D$  structures over  $\mathcal{C}_i$  and  $\mathcal{C}'_i$  are quasi-equivalent. Thus, the categories of type  $D$  structures over  $\mathcal{C}_1$  and  $\mathcal{C}_2$  are homotopy unitaly quasi-equivalent. By Proposition 7.56, this, in turn, implies these categories of type  $D$  structures are strictly unitaly quasi-equivalent.  $\square$

## 8. THE ASSOCIAPLEX

The present section provides a geometric interpretation of the chain complex of weighted trees. Specifically, we define here a CW complex, the *weighted associaplex*  $\mathbf{X}^{n,w}$ , with one cell  $Q^T$  for each stably-weighted tree  $T$ , and whose differential agrees with the differential on the weighted trees complex  $X_*^{n,w}$ . In the special case  $w = 0$ , the associahedron serves as such a CW complex (see for example [Dev99]): indeed, the associahedron is a polytope. For  $w \geq 1$ , however, the weighted associaplex is not a polytope, though its underlying topological space is homeomorphic to a disk. Although the material here is logically independent of the rest of the paper, the reader may find this topological perspective useful as motivation.

We start with a brief description of the weighted associaplex, based on the Deligne-Mumford compactification of the moduli space of points on a disk, and then give a more detailed explanation using basic complex analysis. Consider the configuration space of  $w$  distinct, unordered points in the interior of  $D^2$  and  $n + 1$  points in  $\partial D^2$ , one of which is distinguished. The Deligne-Mumford compactification of this space has strata corresponding to disks and spheres glued together at nodes (which are additional marked points), so that:

- at each boundary node, two disks are glued together;
- at each interior node either two spheres are glued together, or a sphere is glued to a disk;
- smoothing all of the nodes gives a single topological disk (so, for instance, the disks are glued together according to some tree); and
- each sphere has at least 3 special points (marked points or nodes) and each disk has at least three boundary special points or an interior special point and a boundary special point.

The stratum corresponding to such a configuration is the product over the disks and spheres  $\Sigma$  of the Deligne-Mumford moduli space of  $\Sigma$ . Then the weighted associaplex with weight  $w$  and  $(n + 1)$



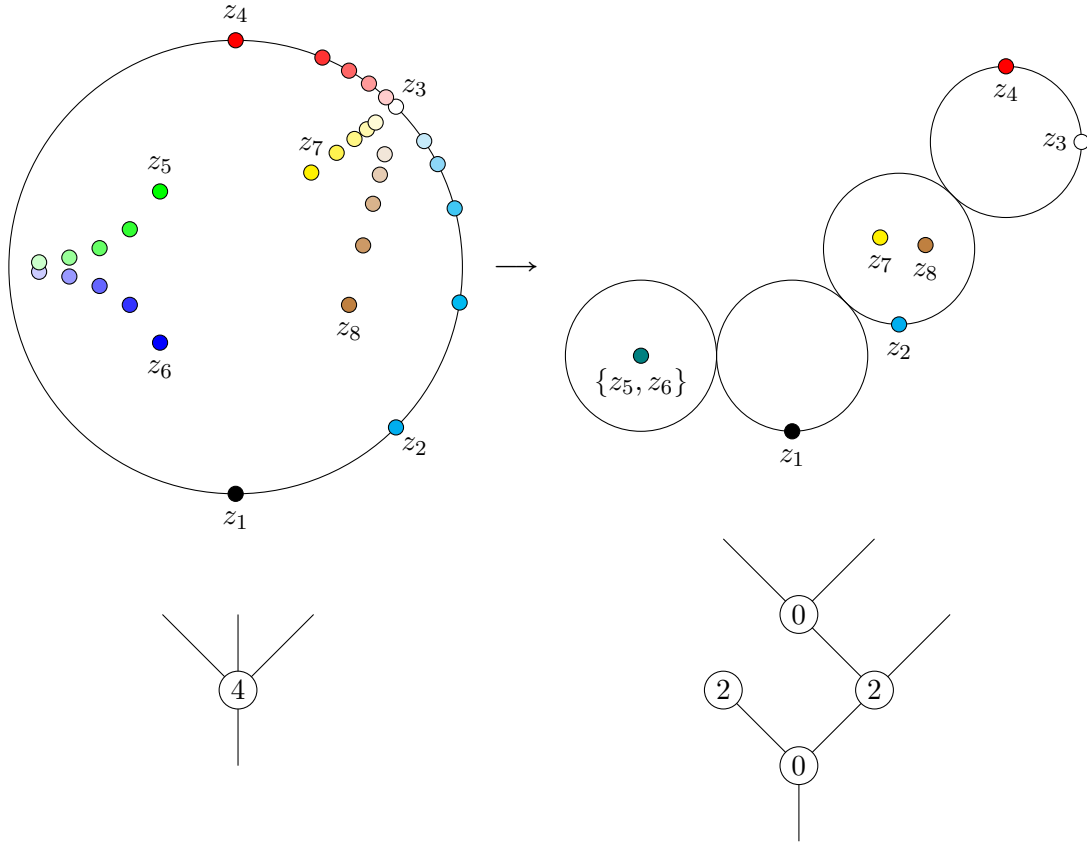

FIGURE 49. **Convergence in the associaplex.** Top-left: a sequence of points in  $\text{Sym}^{4,4}(\mathbb{D})$ . Subsequent terms in the sequence appear in lighter colors. Top-right: the limit in (one stratum of) the associaplex  $Q^T(\mathbb{D})$ . Note that the points  $z_5, z_6$  would converge to distinct points in a sphere bubble in the Deligne-Mumford compactification, and this sphere has been collapsed here. Bottom: the weighted trees corresponding to these strata.

boundary marked points is obtained by collapsing each factor corresponding to a sphere  $\Sigma$  to a single point. It is straightforward to see that this collapsing respects the gluing between strata. Roughly, this means that in the associaplex, we do not keep track of the directions in which interior marked points collide.

Turning to the more detailed description, let  $\mathbb{H}$  denote the lower half plane  $\{a + bi \mid a, b \in \mathbb{R}, b \leq 0\} \subset \mathbb{C}$ , and let  $\mathbb{H}^\circ$  denote its interior. The conformal automorphism group  $\text{Aut}(\mathbb{H})$  is the group of affine transformations  $z \rightarrow az + b$ , where  $a, b \in \mathbb{R}$  and  $a > 0$ . (Under the conformal identification of  $\mathbb{H}$  with the unit disk, this automorphism group corresponds to the set of Möbius transformations that preserve  $-i$ .) Let  $\text{Sym}^{n,w}(\mathbb{H})$  denote the product of the space of order-preserving embeddings  $\{1, \dots, n\} \hookrightarrow \mathbb{R} = \partial\mathbb{H}$  with the  $w^{\text{th}}$  symmetric product of  $\mathbb{H}^\circ$ . Our goal is to define, for integers  $n \geq 0$  and  $w \geq 0$  with  $n + 2w \geq 2$ , a useful compactification of  $Q^{n,w} := \text{Sym}^{n,w}(\mathbb{H}) / \text{Aut}(\mathbb{H})$ . We call this compactification the *weighted associaplex* or just the *associaplex*.

Strata in the associaplex are indexed by stably-weighted trees. Precisely, let  $T$  be a stably-weighted tree with  $n$  inputs and weight  $w$ . Let  $\text{val}(v)$  denote the valence of an internal vertex  $v$

and let  $w(v)$  denote the weight of  $v$ . The open stratum corresponding to  $T$  is

$$Q^T := \prod_{v \in \text{Vert}(T)} Q^{\text{val}(v)-1, w(v)}.$$

The space  $Q^{n,w}$  is an open subspace of the quotient of a space of ordered  $(n+w)$ -tuples of points,

$$(8.1) \quad \tilde{Q}^{n,w} \subset \left( \prod_{i=1}^n \partial\mathbb{H} \right) \times \left( \prod_{i=1}^w \mathbb{H}^o \right) \subset \prod_{i=1}^{n+w} \mathbb{H},$$

by  $\text{Aut}(\mathbb{H})$  and then by the action of the symmetric group on  $w$  letters. In defining  $\tilde{Q}^{n,w}$  we assume that the  $n$  points in the boundary come first in the ordering, and that their ordering induced by  $\mathbb{R}$  agrees with the chosen ordering; correspondingly, in Equation (8.1), a point  $(z^1, \dots, z^{n+w})$  satisfies  $z^1 < z^2 < \dots < z^n \in \mathbb{R}$ .

We will denote elements of  $\prod_{i=1}^{n+w} \mathbb{H}$  with bold letters. Let  $z^i \in \mathbb{H}$  denote the  $i^{\text{th}}$  component of  $\mathbf{z} \in \tilde{Q}^{n,w}$ . We will also consider, for each weighted tree  $T$ , the space

$$\tilde{Q}^T = \prod_{v \in \text{Vert}(T)} \tilde{Q}^{\text{val}(v)-1, w(v)}.$$

Often, we will find it convenient to work with the one-point compactification  $\overline{\mathbb{H}}$  of  $\mathbb{H}$ . Given a point  $p \in \mathbb{H}^o$ , let  $\phi^p \in \text{Aut}(\mathbb{H})$  denote the map with  $\phi^p(p) = -i$ . Explicitly, if  $p = a + bi$  then

$$\phi^p(z) = \frac{a - z}{b}.$$

Let

$$\Phi^p: \prod_{i=1}^{n+w} \overline{\mathbb{H}} \rightarrow \prod_{i=1}^{n+w} \overline{\mathbb{H}}$$

denote the induced map on the Cartesian product.

**Definition 8.2.** *A tuple of points  $(z_1, \dots, z_\ell)$  in  $\mathbb{H}$ , satisfies the slice condition if the following two properties hold:*

- $\sum_{i=1}^{\ell} z_i$  have vanishing real part and
- $\sum_{i=1}^{\ell} |z_i| = \ell$ .

If  $(z_1, \dots, z_\ell)$  contains at least two distinct entries, or one entry which is not real, then there is a unique  $p \in \mathbb{H}^o$  so that  $(\phi^p(z_1), \dots, \phi^p(z_\ell))$  satisfies the slice condition.

**Definition 8.3.** *Given a sequence  $\{z_j^1\}_{j=1}^\infty$  in  $\mathbb{H}^o$ , a stabilizing sequence  $\{p_j\}_{j=1}^\infty$  is a sequence in  $\mathbb{H}^o$  with the property that the sequence  $\{\phi^{p_j}(z_j^1)\}_{j=1}^\infty$  converges to a point in  $\mathbb{H}^o$ . Given a sequence  $\{(z_j^1, z_j^2)\}_{j=1}^\infty$  of pairs of points in  $\mathbb{H}$  that are required to be distinct if both are on  $\partial\mathbb{H}$ , a stabilizing sequence  $\{p_j\}_{j=1}^\infty$  is a sequence in  $\mathbb{H}^o$  with the property that  $\{(\phi^{p_j}(z_j^1), \phi^{p_j}(z_j^2))\}_{j=1}^\infty$  converges to pair of points  $(z^1, z^2)$  in  $\mathbb{H}$ , which are distinct if both are on  $\partial\mathbb{H}$ .*

Any sequence  $\{z_j^1\}_{j=1}^\infty$  in  $\mathbb{H}^o$  has a stabilizing sequence: let  $p_j = z_j^1$ . For pairs of points, we have the following:

**Lemma 8.4.** *A sequence  $\{(z_j^1, z_j^2)\}_{j=1}^\infty$  of pairs of points in  $\mathbb{H}$  that are distinct if they are both in  $\partial\mathbb{H}$  has a subsequence that admits a stabilizing sequence.*

*Proof.* For each  $j$ , choose  $q_j$  so that for  $(\phi^{q_j}(z_j^1), \phi^{q_j}(z_j^2))$  satisfies the slice condition. By compactness of the unit ball in  $\mathbb{H}$ , we can find a subsequence of  $\{(\phi^{q_j}(z_j^1), \phi^{q_j}(z_j^2))\}_{j=1}^\infty$  that converges to a pair of points  $(z^1, z^2)$  in  $\mathbb{H}$  that also satisfy the slice condition.  $\square$

**Lemma 8.5.** *If  $\{p_j\}_{j=1}^\infty$  and  $\{q_j\}_{j=1}^\infty$  are two stabilizing sequences for the same sequence  $\{z_j\}_{j=1}^\infty$  with  $z_j \in \mathbb{H}^o$  or for the same sequence  $\{(z_j^1, z_j^2)\}_{j=1}^\infty$  of pairs of points in  $\mathbb{H}$ , then  $\phi^{p_j} \circ (\phi^{q_j})^{-1}$  converges to some automorphism of  $\mathbb{H}$ .*

*Proof.* Suppose that  $\{p_j\}_{j=1}^\infty$  and  $\{q_j\}_{j=1}^\infty$  are stabilizing sequences for the same sequence of pairs  $\{(z_j^1, z_j^2)\}_{j=1}^\infty$ . It suffices to consider the case that  $\{q_j\}_{j=1}^\infty$  is the stabilizing sequence from the proof of Lemma 8.4; i.e.  $(\phi^{q_j}(z_j^1), \phi^{q_j}(z_j^2))$  satisfies the slice condition for each  $j$ . Replacing  $z_j^k$  with  $\phi^{q_j}(z_j^k)$  for  $k = 1, 2$ , we can assume that the pair  $(z_j^1, z_j^2)$  satisfies the slice condition and  $\phi^{q_j} = \mathbb{I}$  for all  $j$ .

Suppose first that  $\{p_j\}_{j=1}^\infty$  converges to a point  $p \in \overline{\mathbb{H}}$ . If  $p \in \mathbb{H}^o$ , then  $\{\phi^{p_j}\}_{j=1}^\infty \rightarrow \phi^p$ . If  $p \notin \mathbb{H}^o$ , we claim that  $\{p_j\}_{j=1}^\infty$  is not a stabilizing sequence. Specifically, if  $p = \infty$ , then it is easy to see that either

$$\lim_{j \rightarrow \infty} \phi^{p_j}(z_j^1) = \lim_{j \rightarrow \infty} \phi^{p_j}(z_j^2) \in \mathbb{R} \cup \infty.$$

(The limit is real when  $\{p_j\}_{j=1}^\infty$  converges.) Suppose next that  $p \in \partial\mathbb{H}$ . If  $p \neq \lim_{j \rightarrow \infty} \phi^{p_j}(z_j^k)$  for  $k = 1, 2$ , then it is easy to see that  $\phi^{p_j}(z_j^k) \rightarrow \infty$ .

Finally, if the sequence  $\{p_j\}_{j=1}^\infty$  has more than one limit point then the argument above shows that each limit point must be in  $\mathbb{H}^o$  and, since the sequence  $\{(\phi^{p_j}(z_j^1), \phi^{p_j}(z_j^2))\}_{j=1}^\infty$  converges, in fact all the limit points must be the same.

A similar argument applies in the case where  $\{p_j\}_{j=1}^\infty$  and  $\{q_j\}_{j=1}^\infty$  are stabilizing sequences for the same sequence  $\{z_j\}_{j=1}^\infty$  with  $z_j \in \mathbb{H}^o$ .  $\square$

A *stable configuration* is a point in  $\prod^{w+n} \mathbb{H}$  that either contains at least one component in the interior of  $\mathbb{H}$  or at least two components that are distinct points on the boundary. Fix a sequence  $\{\mathbf{z}_j\}_{j=1}^\infty$  in  $\widetilde{Q}^{n,w}$ . A *stabilizing sequence* for  $\{\mathbf{z}_j\}_{j=1}^\infty$  is a sequence  $\{p_j\}_{j=1}^\infty$  of points in  $\mathbb{H}^o$ , with the following properties:

- The sequence of points  $\{\Phi^{p_j}(\mathbf{z}_j)\}_{j=1}^\infty$  converges to some point  $\mathbf{z} \in \prod^{n+w} \overline{\mathbb{H}}$ .
- The limit point  $\mathbf{z}$  is a stable configuration.

Elements  $\mathbf{z}$  that arise as  $\lim_{j \rightarrow \infty} \{\Phi^{p_j}(\mathbf{z}_j)\}_{j=1}^\infty$  for some choice of stabilizing sequence  $\{p_j\}_{j=1}^\infty$ , are called *stable limits*.

Call two stabilizing sequences for  $\{\mathbf{z}_j\}_{j=1}^\infty$  *equivalent* if  $\lim_{j \rightarrow \infty} \Phi^{p_j}(\mathbf{z}_j)$  and  $\lim_{j \rightarrow \infty} \Phi^{q_j}(\mathbf{z}_j)$  differ by  $\text{Aut}(\mathbb{H})$  or, more precisely, if there is a  $\psi \in \text{Aut}(\mathbb{H})$  inducing a map  $\Psi$  on  $\prod^{n+w} \overline{\mathbb{H}}$  such that

$$\Psi \left( \lim_{j \rightarrow \infty} \Phi^{p_j}(\mathbf{z}_j) \right) = \lim_{j \rightarrow \infty} \Phi^{q_j}(\mathbf{z}_j).$$

We denote the equivalence class of a stabilizing sequence  $\{p_j\}_{j=1}^\infty$  by  $[[\{p_j\}_{j=1}^\infty]]$ .

**Definition 8.6.** Fix a sequence of points  $\{\mathbf{z}_j\}_{j=1}^\infty$  in  $\widetilde{Q}^{n,w}$ . Let  $\{p_j\}_{j=1}^\infty$  be any stabilizing sequence  $\{p_j\}_{j=1}^\infty$  for  $\{\mathbf{z}_j\}_{j=1}^\infty$ , for some  $i \in \{n+1, \dots, n+w\}$ , or for  $\{(z_j^i, z_j^k)\}_{j=1}^\infty$  for some pair of  $i, k \in \{1, \dots, n+w\}$ . The sequence  $\{\mathbf{z}_j\}_{j=1}^\infty$  is called *pre-convergent* if for any  $\{p_j\}_{j=1}^\infty$  as above,  $\{\Phi^{p_j}(\mathbf{z}_j)\}_{j=1}^\infty$  converges in  $\prod^{n+m} \overline{\mathbb{H}}$ .

We will show that each pre-convergent sequence in  $\widetilde{Q}^{n,w}$  converges to a well-defined limit point in  $\widetilde{Q}^T$  for some tree  $T$ .

**Lemma 8.7.** Let  $\{\mathbf{z}_j\}_{j=1}^\infty$  be a sequence in  $\widetilde{Q}^{n,w}$ , suppose  $\{p_j\}_{j=1}^\infty$  and  $\{q_j\}_{j=1}^\infty$  are two stabilizing sequences for  $\{\mathbf{z}_j\}_{j=1}^\infty$ , and suppose one of the following two conditions holds:

- For some  $i \in \{1, \dots, n+w\}$ ,  $\lim_{j \rightarrow \infty} \phi^{p_j}(z_j^i)$  and  $\lim_{j \rightarrow \infty} \phi^{q_j}(z_j^i)$  both lie in  $\mathbb{H}^o$ ; or
- There are two distinct  $i, k \in \{1, \dots, n+w\}$  so that  $\lim_{j \rightarrow \infty} \phi^{p_j}(z_j^i)$  and  $\lim_{j \rightarrow \infty} \phi^{p_j}(z_j^k)$  are two distinct points in  $\partial\mathbb{H}$ , as are  $\lim_{j \rightarrow \infty} \phi^{q_j}(z_j^i)$  and  $\lim_{j \rightarrow \infty} \phi^{q_j}(z_j^k)$ .

Then,  $\{p_j\}_{j=1}^\infty$  and  $\{q_j\}_{j=1}^\infty$  are equivalent.

*Proof.* This follows from Lemma 8.5.  $\square$

**Definition 8.8.** The input set of a stabilizing sequence  $\{p_j\}_{j=1}^\infty$ , denoted  $I(\{p_j\}_{j=1}^\infty)$ , is the set of  $i \in \{1, \dots, n+w\}$  with the property that the sequence  $\{\phi^{p_j}(z_j^i)\}_{j=1}^\infty$  converges to some point in  $\mathbb{H}$  (i.e., the sequence does not diverge to infinity).

**Lemma 8.9.** Let  $\{p_j\}_{j=1}^\infty$  and  $\{q_j\}_{j=1}^\infty$  be two stabilizing sequences for some sequence  $\{\mathbf{z}_j\}_{j=1}^\infty$ , and suppose that there is  $r \in \partial\mathbb{H}$  so that (at least) one of the following two conditions holds:

- for some  $i \in I(\{p_j\}_{j=1}^\infty)$ ,

$$(8.10) \quad \lim_{j \rightarrow \infty} \phi^{p_j}(z_j^i) \in \mathbb{H}^\circ \quad \text{and} \quad \lim_{j \rightarrow \infty} \phi^{q_j}(z_j^i) = r$$

- for some  $i, k \in I(\{p_j\}_{j=1}^\infty)$ ,

$$(8.11) \quad \lim_{j \rightarrow \infty} \phi^{p_j}(z_j^i) \neq \lim_{j \rightarrow \infty} \phi^{p_j}(z_j^k); \quad \text{and} \quad \lim_{j \rightarrow \infty} \phi^{q_j}(z_j^i) = \lim_{j \rightarrow \infty} \phi^{q_j}(z_j^k) = r.$$

Then, for all  $\ell \in I$ ,

$$(8.12) \quad \lim_{j \rightarrow \infty} \phi^{q_j}(z_j^\ell) = r.$$

Thus, any two stabilizing sequences with the same input set are equivalent.

*Proof.* Write  $\phi^{q_j} \circ (\phi^{p_j})^{-1}(z) = a_j z + b_j$ . Either of the conditions from Equations (8.10) and (8.11) implies that  $\{a_j\}_{j=1}^\infty \rightarrow 0$  and  $\{b_j\}_{j=1}^\infty \rightarrow r$ , which in turn implies that if  $\{\phi^{p_j}(z_j)\}_{j=1}^\infty$  converges in  $\mathbb{H}$ , then  $\{\phi^{q_j} \circ (\phi^{p_j})^{-1}(z_j)\}_{j=1}^\infty \rightarrow r$ , verifying Equation (8.12).

Suppose the input set  $I$  for  $\{p_j\}_{j=1}^\infty$  is contained in the input set  $J$  of  $\{q_j\}_{j=1}^\infty$ , but the sequences are inequivalent. Then, by Lemma 8.7, at least one of the two conditions from Equations (8.10) and (8.11) holds. Equation (8.12) and the definition of a stable configuration ensures that  $I$  is a proper subset of  $J$ .  $\square$

**Corollary 8.13.** There are only finitely many different equivalence classes of stabilizing sequences for a given sequence  $\{\mathbf{z}_j\}_{j=1}^\infty$ .

*Proof.* There are only finitely many possible input sets and, by Lemma 8.9, the equivalence class of a stabilizing sequence is determined by its input set.  $\square$

**Lemma 8.14.** Let  $\{\mathbf{z}_j\}_{j=1}^\infty$  be a pre-convergent sequence and  $\{q_j\}_{j=1}^\infty$  be a stabilizing sequence for a subsequence  $\{\mathbf{z}_{n_j}\}_{j=1}^\infty$ . Then, there is a stabilizing sequence  $\{p_j\}_{j=1}^\infty$  for  $\{\mathbf{z}_j\}_{j=1}^\infty$  with the same input set as  $\{q_j\}_{j=1}^\infty$ .

*Proof.* Suppose that  $\{q_j\}_{j=1}^\infty$  is a stabilizing sequence for  $\{\mathbf{z}_{n_j}\}_{j=1}^\infty$ . This means we can find either some  $i \in \{n+1, \dots, n+w\}$  so that  $\{\phi^{q_j}(z_{n_j}^i)\}_{j=1}^\infty$  converges to a point in  $\mathbb{H}^\circ$ , or we can find distinct  $i, k \in \{1, \dots, n+w\}$  so that  $\{(\phi^{q_j}(z_{n_j}^i), \phi^{q_j}(z_{n_j}^k))\}_{j=1}^\infty$  converges to a pair of distinct points in  $\partial\mathbb{H}$ . Let  $\{p_j\}_{j=1}^\infty$  be a stabilizing sequence for  $\{z_j^i\}_{j=1}^\infty$  (in the first case) or for  $\{(z_j^i, z_j^k)\}_{j=1}^\infty$  (in the second case). Lemma 8.5 shows that  $\{q_{n_j}\}_{j=1}^\infty$  and  $\{p_{n_j}\}_{j=1}^\infty$  are equivalent sequences. In particular, they have the same input sets. For a pre-convergent sequence, the input set of a stabilizing sequence  $\{p_j\}_{j=1}^\infty$  is the same as the input set of any of its subsequences.  $\square$

**Lemma 8.15.** Suppose that  $\{q_j\}_{j=1}^\infty$  is a stabilizing sequence for some sequence  $\{\mathbf{z}_j\}_{j=1}^\infty$  in  $\tilde{Q}^{n,w}$ , and fix  $r \in \partial\mathbb{H}$  with the property that

$$I = \{i \in \{1, \dots, n+w\} \mid \lim_{j \rightarrow \infty} \phi^{q_j}(z_j^i) = r\}$$

contains at least two elements in  $\{1, \dots, n\}$  (i.e., for which  $z_j^i \in \partial\mathbb{H}$ ) or at least one element of  $\{n+1, \dots, n+w\}$  (i.e., for which  $z_j^i \in \mathbb{H}^\circ$ ). Then there is a subsequence  $\{\mathbf{z}_{n_j}\}_{j=1}^\infty$  which has a stabilizing sequence  $\{p_j\}_{j=1}^\infty$  whose input set is  $I$ . In particular, if the original sequence  $\{\mathbf{z}_j\}_{j=1}^\infty$  is pre-convergent, then there is another stabilizing sequence with input set  $I$ .

*Proof.* For each  $j$ , let  $I_j = \{z_j^i \mid i \in I\}$ . Choose  $t_j$  so that  $\phi^{t_j}(I_j)$  satisfies the slice condition. By compactness of the unit ball in  $\mathbb{H}$ , we can find a subsequence  $\{t_{n_j}\}_{j=1}^\infty = \{p_j\}_{j=1}^\infty$  that is a stabilizing sequence for  $\{\mathbf{z}_{n_j}\}_{j=1}^\infty$ . Let  $J$  be the input set of  $\{q_j\}_{j=1}^\infty$ . By construction,  $I \subseteq J$ . By Lemma 8.9,  $J \subseteq I$ ; so  $J = I$ . The final statement in the lemma now follows from Lemma 8.14.  $\square$

**Lemma 8.16.** *Let  $\{z_j\}_{j=1}^\infty$  be a pre-convergent sequence in  $\widetilde{Q}^{n,w}$ . Given  $i \in \{1, \dots, n\}$  (i.e., for which  $z_j^i \in \partial\mathbb{H}$ ), there is a stabilizing sequence  $\{p_j\}_{j=1}^\infty$  with the property that for all  $k \neq i$  with  $k \in \{1, \dots, n+w\}$ ,*

$$(8.17) \quad \lim_{j \rightarrow \infty} \phi^{p_j}(z_j^i) \neq \lim_{j \rightarrow \infty} \phi^{p_j}(z_j^k).$$

Moreover,  $\{p_j\}_{j=1}^\infty$  is uniquely characterized up to equivalence by that property.

*Proof.* To construct the desired stabilizing sequence, we argue as follows. Let  $\mathcal{P}$  be the set of equivalence classes of stabilizing sequences whose input set contains  $i$ .

First, we argue that  $\mathcal{P}$  is non-empty. Consider the sequence  $\{t_j\}_{j=1}^\infty$  so that  $(\phi^{t_j}(z_j^1), \dots, \phi^{t_j}(z_j^{n+w}))$  satisfies the slice condition. As in the proof of Lemma 8.15, this has a subsequence that is a stabilizing sequence for a subsequence of  $\{z_j\}_{j=1}^\infty$  with input set  $\{1, \dots, n+w\}$ . Lemma 8.14 now gives a stabilizing sequence for all of  $\mathbf{z}_j$  with input set  $\{1, \dots, n+w\}$ .

Next, given  $v_1, v_2 \in \mathcal{P}$ , we declare  $v_1 < v_2$  if the input set of  $v_1$  is contained in the input set of  $v_2$ . This induces a partial ordering on the elements of  $\mathcal{P}$ . Lemma 8.15 implies that any element  $[[\{p_j\}_{j=1}^\infty]]$  of  $\mathcal{P}$  that is minimal with respect to this ordering satisfies Equation (8.17) for all  $k \neq i$ .

For uniqueness, we argue as follows. Let  $\{p_j\}_{j=1}^\infty$  and  $\{q_j\}_{j=1}^\infty$  be stabilizing sequences satisfying the hypothesis, with input sets  $I$  and  $J$  respectively. Then, we can find  $k \in I$  with

$$\lim_{j \rightarrow \infty} \phi^{p_j}(z_j^i) \neq \lim_{j \rightarrow \infty} \phi^{q_j}(z_j^k),$$

and  $\ell \in J$  so that

$$\lim_{j \rightarrow \infty} \phi^{q_j}(z_j^i) \neq \lim_{j \rightarrow \infty} \phi^{q_j}(z_j^\ell).$$

Choose a stabilizing sequence  $\{s_j\}_{j=1}^\infty$  so that  $(\phi^{s_j}(z_j^i), \phi^{s_j}(z_j^k), \phi^{s_j}(z_j^\ell))$  satisfies the slice condition.

By the slice condition, at least two of

$$\lim_{j \rightarrow \infty} \phi^{s_j}(z_j^i), \quad \lim_{j \rightarrow \infty} \phi^{s_j}(z_j^k), \quad \text{and} \quad \lim_{j \rightarrow \infty} \phi^{s_j}(z_j^\ell)$$

are distinct. If

$$(8.18) \quad \lim_{j \rightarrow \infty} \phi^{s_j}(z_j^i) \neq \lim_{j \rightarrow \infty} \phi^{s_j}(z_j^k),$$

then by Lemma 8.7,  $\{p_j\}_{j=1}^\infty$  and  $\{s_j\}_{j=1}^\infty$  are equivalent. In particular,  $\ell \in I$ ; so Equation (8.17) (for  $k = \ell$ ) gives  $\lim_{j \rightarrow \infty} \phi^{p_j}(z_j^i) \neq \lim_{j \rightarrow \infty} \phi^{p_j}(z_j^\ell)$ . By Lemma 8.7, we conclude that  $\{p_j\}_{j=1}^\infty$  is equivalent to  $\{q_j\}_{j=1}^\infty$ , provided Equation (8.18) holds. An analogous argument proves that  $\{p_j\}_{j=1}^\infty$  and  $\{q_j\}_{j=1}^\infty$  are equivalent when Equation (8.18) is replaced by

$$\lim_{j \rightarrow \infty} \phi^{s_j}(z_j^i) \neq \lim_{j \rightarrow \infty} \phi^{s_j}(z_j^\ell).$$

This completes the proof.  $\square$

Fix a pre-convergent sequence  $\{z_j\}_{j=1}^\infty$ . Construct a weighted planar graph  $T$  as follows. The vertices of  $T$  correspond to equivalence classes of stabilizing sequences for  $\{z_j\}_{j=1}^\infty$ . The weight of a vertex is the number of  $i \in \{n+1, \dots, n+w\}$  with the property that  $\{\phi^{p_j}(z_j^i)\}_{j=1}^\infty$  converges to some point in  $\mathbb{H}^\circ$ . The edges of  $T$  coming into a vertex  $[[\{p_j\}_{j=1}^\infty]]$  correspond to the distinct  $q \in \partial\mathbb{H}$  that arise as limit points of  $\{\phi^{p_j}(z_j^i)\}_{j=1}^\infty$ . The planar ordering of the edges into each vertex is the one induced by the ordering of these points in  $\mathbb{R}$ . The input edges into  $T$  whose endpoint is at the

vertex  $\llbracket \{p_j\}_{j=1}^\infty \rrbracket$  correspond to  $i$  for which  $\lim_{j \rightarrow \infty} \phi^{p_j}(z_j^i) \in \partial\mathbb{H}$  is distinct from all  $\lim_{j \rightarrow \infty} \phi^{p_j}(z_j^k)$  for all  $k \neq i$ . For each edge pointing into the vertex  $\llbracket \{p_j\}_{j=1}^\infty \rrbracket$  that is not an input edge, Lemma 8.15 constructs the other endpoint of that edge.

Orient the edges of  $T$  from the vertex with smaller input set to the one with larger input set.

**Definition 8.19.** *An increasing path is a path between two vertices of  $T$  obtained by juxtaposing edges oriented so that the input set is always increasing.*

**Lemma 8.20.** *Let  $\{\mathbf{z}_j\}_{j=1}^\infty$  be a pre-convergent sequence, and let  $T$  be the associated weighted graph as above. Let  $v_1$  and  $v_2$  be two vertices of  $T$  whose stabilizing sequences have input sets  $I$  and  $J$  respectively, with  $I \subset J$ . Then, there is a unique increasing path from  $v_1$  to  $v_2$ .*

*Proof.* The construction and proof of uniqueness is inductive on  $|J \setminus I|$ . If  $I = J$ , the sequences are equivalent by Lemma 8.7 and the path is necessarily trivial. Otherwise, Lemma 8.9, provides an  $r \in \mathbb{R}$  so that for all  $i \in I$ ,  $\phi^{q_j}(x_j^i) = r$ . This clearly determines the final edge  $e$  in any increasing path from  $\{p_j\}_{j=1}^\infty$  to  $\{q_j\}_{j=1}^\infty$ , since all other edges into  $\llbracket \{q_j\}_{j=1}^\infty \rrbracket$  point from vertices that do not contain  $I$  in their input set. Lemma 8.15 supplies the initial endpoint  $\llbracket \{s_j\}_{j=1}^\infty \rrbracket$  of the edge  $e$ . The inductive hypothesis constructs uniquely the path from  $\{p_j\}_{j=1}^\infty$  to  $\{s_j\}_{j=1}^\infty$ ; the desired path is obtained by appending the edge  $e$ .  $\square$

**Proposition 8.21.** *For a pre-convergent sequence  $\{\mathbf{z}_j\}_{j=1}^\infty$ , the associated weighted graph  $T$  is a finite, planar tree with  $n$  inputs, weight  $w$ , and with no valence two, weight-0 internal vertices.*

*Proof.* Corollary 8.13 ensures that  $T$  has finitely many vertices. Orient each edge from  $v_1 = \llbracket \{q_j\}_{j=1}^\infty \rrbracket$  to  $v_2 = \llbracket \{p_j\}_{j=1}^\infty \rrbracket$  if the input set of  $v_1$  is properly contained in the input set of  $v_2$ . If  $I(v_1) \subset I(v_2)$  then Lemma 8.20 constructs an oriented path from  $v_1$  to  $v_2$ , and that path is unique.

The trunk vertex  $\tau$  (i.e., the predecessor to the root) is the vertex whose input set is all of  $\{1, \dots, n+w\}$ , which can be realized by the stabilizing sequence that achieves the slice condition for  $(z_j^1, \dots, z_j^{n+w})$ . Lemma 8.20 gives a path from any vertex to this trunk vertex; thus, the graph is connected. Uniqueness of the path, together with Lemma 8.16, shows that each input points into a unique internal vertex, and ensures that the graph is a tree.

The stability condition eliminates the possibility of valence two, weight-0 internal vertices.

To verify that the total weight is  $w$ , observe that for any  $i$  so that  $\{z_j^i\}_{j=1}^\infty$  has  $z_j^i \in \mathbb{H}^o$  for all  $j$ , the sequence  $\{z_j^i\}_{j=1}^\infty$  is a stabilizing sequence. By Lemma 8.7, any other stabilizing sequence such that  $\{\phi^{p_j}(z_j^i)\}_{j=1}^\infty$  converges to some point in  $\mathbb{H}^o$  is equivalent to this stabilizing sequence, so there is a unique vertex where  $\{z_j^i\}_{j=1}^\infty$  contributes to the weight.

The fact that the tree has  $n$  inputs follows from Lemma 8.16. Any ordering of the edges into each vertex gives a tree a planar structure so, in particular, the ordering specified above does. It is immediate from the construction that the induced ordering of the inputs agrees with the ordering  $1, \dots, n$ .  $\square$

Having identified the stratum  $T$  that a pre-convergent sequence  $\{\mathbf{z}_j\}_{j=1}^\infty$  converges to, we explain how to find the actual limit point. Each vertex  $v \in \text{Vert}(T)$  corresponds to an equivalence class of stabilizing sequence  $\{p_j\}_{j=1}^\infty$ . Thought of as points in  $\Pi^{w+n} \mathbb{H}$ , the sequence  $\phi^{p_j}(\mathbf{z}_j)$  converges to some  $\mathbf{z}^v \in \tilde{Q}^{w+n}(\mathbb{H})$ , exactly  $\text{val}(v) - 1$  many components of which are distinct points on  $\partial\mathbb{H}$ . Thus, it represents a point in  $\tilde{Q}^{\text{val}(v)-1, w(v)}$ . Clearly, if  $\{q_j\}_{j=1}^\infty$  is equivalent to  $\{p_j\}_{j=1}^\infty$ , then  $\phi^{q_j}(\mathbf{z}_j)$  represents the same point modulo the action of  $\text{Aut}(\mathbb{H})$ . Extracting such limits for all vertices  $v$ , we obtained the promised configuration  $\mathbf{z} \in \tilde{Q}^T$ .

Let

$$(8.22) \quad \tilde{\mathbf{X}}^{n,w} = \bigcup_{T \in \mathcal{T}_{n,w}} \tilde{Q}^T.$$



Given a vertex  $v$  of  $T$ , let  $\pi_v: \tilde{Q}^T \rightarrow \tilde{Q}^{\text{val}(v)-1, w(v)}$  denote projection. Define a sequence  $\{\mathbf{z}_j\}_{j=1}^\infty$  in  $\tilde{Q}^T$  to be convergent if for each vertex  $v$  of  $T$ , the sequence  $\{\pi_v(\mathbf{z}_j)\}_{j=1}^\infty$  is pre-convergent. The limit of such a convergent sequence  $\{\mathbf{z}_j\}_{j=1}^\infty$  has underlying tree  $T'$  obtained by splicing in the tree for  $\lim\{\pi_v(\mathbf{z}_j)\}_{j=1}^\infty$  at the vertex  $v$  (for each  $v$ ), and the limit of  $\{\mathbf{z}_j\}_{j=1}^\infty$  in  $\tilde{Q}^{T'}$  is given by the limits of the points  $\{\pi_v(\mathbf{z}_j)\}_{j=1}^\infty$  in the obvious way. Finally, call an arbitrary sequence  $\{\mathbf{z}_j\}_{j=1}^\infty$  in  $\tilde{\mathbf{X}}^{n,w}$  *convergent* if the intersection of  $\{\mathbf{z}_j\}_{j=1}^\infty$  with each stratum  $\tilde{Q}^T$  is either finite or a convergent sequence, and all of these convergent sequences converge to the same limit.

A topological space  $X$  is *sequentially Hausdorff* if any convergent sequence in  $X$  has a unique limit.

**Proposition 8.23.** *The above notion of convergence gives the point set*

$$\tilde{\mathbf{X}}^{n,w} = \bigcup_{T \in \mathcal{T}_{n,w}} \tilde{Q}^T$$

*the structure of a sequentially compact, sequentially Hausdorff topological space. Further, the topology on each subspace  $\tilde{Q}^T$  is the standard topology on the open disk.*

*Proof.* We first show that  $\tilde{\mathbf{X}}^{n,w}$  is sequentially Hausdorff, i.e., that any convergent sequence as defined above has a unique limit. It follows that the convergent sequences induce a topology on  $\tilde{\mathbf{X}}^{n,w}$ . We then verify that this topology is sequentially compact.

For a pre-convergent sequence in  $\tilde{Q}^{n,w}$ , the above construction gives a tree  $T$  and a unique limit point in  $\tilde{Q}^T$ . In particular, convergent sequences in  $\tilde{Q}^{n,w}$  have unique limits. This implies immediately that any convergent sequence contained in a single open stratum has a unique limit. Since the limit of a sequence that intersects several open strata is the common limit of the subsequences in each stratum, such a sequence also has a unique limit.

Now, define a topology on  $\tilde{\mathbf{X}}^{n,w}$  by declaring that a subset  $C \subset \tilde{\mathbf{X}}^{n,w}$  is closed if every sequence  $\{\mathbf{z}_j\}_{j=1}^\infty \subset C$  which converges to a point  $\mathbf{z} \in \tilde{\mathbf{X}}^{n,w}$  has  $\mathbf{z} \in C$ . It is immediate from the construction that  $\emptyset$  and  $\tilde{\mathbf{X}}^{n,w}$  are closed and that arbitrary intersections of closed sets are closed. The fact that finite unions of closed sets are closed follows from sequential Hausdorffness and the fact that, for our collection of convergent sequences, a subsequence of a convergent sequence converges. It also follows from the fact that subsequences of convergent sequences are convergent that  $U \subset \tilde{\mathbf{X}}^{n,w}$  is open (i.e.,  $\tilde{\mathbf{X}}^{n,w} \setminus U$  is closed) if and only if every sequence which converges to a point in  $U$  is eventually contained in  $U$ .

To prove this topology is sequentially compact, we need to show that if  $\{\mathbf{z}_j\}_{j=1}^\infty$  is any sequence in  $\tilde{Q}^{n,w}$ , then it has a pre-convergent subsequence. For each  $\{i, k\} \subset \{1, \dots, n+w\}$ , Lemma 8.4 gives a stabilizing sequence  $\{p_j\}_{j=1}^\infty$  for  $\{(z_j^i, z_j^k)\}_{j=1}^\infty$ . By compactness of  $\mathbb{H}$ , there is a subsequence so that  $\{\Phi^{p_{n_j}}(\mathbf{z}_{n_j})\}_{j=1}^\infty$  converges in  $\Pi^{n+w}(\overline{\mathbb{H}})$ . Similarly, for each  $i \in \{n+1, \dots, n+w\}$ , there is a stabilizing sequence  $\{p_j\}_{j=1}^\infty$  for  $\{z_j^i\}_{j=1}^\infty$  (which we can take to be  $p_j = z_j^i$ ). Again, we can find a subsequence so that  $\{\Phi^{p_{n_j}}(\mathbf{z}_{n_j})\}_{j=1}^\infty$  converges in  $\Pi^{n+w}(\overline{\mathbb{H}})$ . Take a common subsequence of the  $\{\mathbf{z}_j\}_{j=1}^\infty$  over the finitely many choices for  $\{i, k\} \subset \{1, \dots, n+w\}$  and  $i \in \{n+1, \dots, n+w\}$ . This is pre-convergent because by Lemma 8.5, any other stabilizing sequence for  $\{\mathbf{z}_j\}_{j=1}^\infty$  is equivalent to one of the finitely many stabilizing sequences considered above.

Finally, we show that the subspace topology on  $\tilde{Q}^T$  agrees with the standard topology on the open disk. If  $U$  is open in  $\tilde{Q}^T$  as a subspace of  $\tilde{\mathbf{X}}^{n,w}$ , so  $U = V \cap \tilde{Q}^T$  where  $V \subset \tilde{\mathbf{X}}^{n,w}$  is some open set, then any sequence in  $\tilde{Q}^T$  which converges to a point in  $U$  is eventually contained in  $U$ , hence  $U$  is open in the standard topology on  $\tilde{Q}^T \cong D^{\dim(T)}$ . Conversely, if  $U$  is open in the standard topology then let  $V$  be the union of  $U$  and all of the open strata whose closures strictly contain  $U$  (i.e., all  $\tilde{Q}^S$  where  $T$  is obtained by inserting edges in  $S$ ). It is immediate from the definition of convergence that  $V$  is open. Hence,  $U$  is open in the subspace topology.  $\square$

Let  $T \in \mathcal{T}_{n,w}$ . Let  $E$  be a subset of the internal edges of  $T$  and let  $K_E(T) \in \mathcal{T}_{n,w}$  be the tree obtained from  $T$  by contracting all the edges in  $E$ . Let  $(0, \infty)^E$  denote the set of maps from  $E$  to  $(0, \infty)$ .

**Lemma 8.24.** *Given any  $T \in \mathcal{T}_{n,w}$  and any subset  $E$  of the internal edges of  $T$ , there is a map*

$$\varphi: (0, \infty)^E \times \tilde{Q}^T \rightarrow \tilde{Q}^{K_E(T)}$$

which is a homeomorphism onto its image and which extends continuously to a map

$$\bar{\varphi}: (0, \infty]^E \times \tilde{Q}^T \rightarrow \tilde{\mathbf{X}}^{n,w}$$

which is also a homeomorphism onto its image, with the property that  $\bar{\varphi}_{\{\infty\}^E \times \tilde{Q}^T}$  is the inclusion of  $\tilde{Q}^T \subset \tilde{\mathbf{X}}^{n,w}$ .

*Proof.* For  $E = \text{Edge}(T)$ , we write a formula for  $\varphi$ . The case that  $E$  is a proper subset of  $\text{Edge}(T)$  is obtained by applying this formula to each sub-tree spanned by the edges in  $E$ .

A point in  $(0, \infty)^E \times \tilde{Q}^T$  can be thought of as consisting of a pair:

- A function  $r: E \rightarrow (0, \infty)$ ;
- For each vertex  $v$ , a tuple  $(z_i^{(v)}) \in \prod_{i \in I(v)} \mathbb{H}$  satisfying the slice condition.

Note that  $z_i^{(v)} \in \partial\mathbb{H}$  unless  $i \in \{n+1, \dots, n+w\}$  and  $v$  is the vertex which is furthest from the trunk vertex  $\tau$ , among all vertices containing  $i$  in their input set.

The image under  $\varphi$  of such a pair  $(r, (z_i^{(v)})_{v \in \text{Vert}(T), i \in I(v)})$  is an  $(n+w)$ -tuple of points in  $\mathbb{H}$  whose  $i^{\text{th}}$  component is defined as follows. Let  $v_1, \dots, v_\ell$  be the vertices with the property that  $i \in I(v_j)$ ; order  $v_1, \dots, v_\ell = \tau$  in decreasing distance to the output; i.e.  $I(v_1) \subset \dots \subset I(v_\ell)$ . Then the  $i^{\text{th}}$  component is given by

$$(8.25) \quad z_i = \sum_{j=1}^{\ell} \left( z_i^{(v_j)} / \prod_{k=j}^{\ell-1} r(e_k) \right),$$

where  $e_k$  is the edge from  $v_k$  to  $v_{k+1}$ .

We consider next the case where all the  $\{r_j(e_k)\}_{j=1}^{\infty} \rightarrow \infty$ , to verify that the limit  $\varphi(r_j, q)$  as  $j \rightarrow \infty$  is the inclusion of  $\tilde{Q}^T \subset \tilde{\mathbf{X}}^{n,w}$ . For such sequences with  $z_i$  as in Equation (8.25), we have that  $\lim_{j \rightarrow \infty} z_i = z_i^{(\tau)}$ . This shows that the  $\{z_j\}_{j=1}^{\infty}$  is a sequence which has  $(z_i^{(\tau)})_{i \in I(\tau)}$  as a stable limit. Next, we can pick any edge  $e$  that points into the trunk vertex, and let  $v_1$  denote its other vertex on  $e$ . Observe that  $k = z_i^{(\tau)}$  is a real number that is independent of the choice of  $i \in I(v_1)$ . Choose  $\lambda_j \in \text{Aut}(\mathbb{H})$  defined by  $\lambda_j(z) = (z - k)r_j(e)$ . It is easy to see that

$$\lim_{j \rightarrow \infty} \lambda_j(z_i) = \begin{cases} z_i^{(v_1)} & \text{if } i \in I(v_1) \\ \infty & \text{otherwise,} \end{cases}$$

exhibiting  $(z_i^{(v_1)})_{i \in I(v_1)}$  as a stable limit. Proceeding in a similar manner for other vertices, we can find stable limits realizing  $(z_i^{(v)})_{i \in I(v)}$  for all vertices  $v$ , verifying that  $\bar{\varphi}_{\{\infty\}^E \times \tilde{Q}^T}$  is the inclusion of  $\tilde{Q}^T \subset \tilde{\mathbf{X}}^{n,w}$ .

To check that  $\varphi$  is injective, fix a tree  $T$ , and let  $E = \text{Edge}(T)$ . We construct a continuous map

$$\psi_T: \tilde{Q}^{n,w} \rightarrow \tilde{Q}^T$$

as follows. The input to  $\psi_T$  is an element  $\mathbf{z} = (z_1, \dots, z_{n+w}) \in \tilde{Q}^{n,w}$ . Fix a vertex  $v$  of  $T$ , with  $d$  incoming edges  $e_1, \dots, e_d$  and weight  $\omega$ . For  $j = 1, \dots, d$ , the edge  $e_j$  into  $v$  corresponds to a



non-empty subset  $S_j$  of the input set  $I(v)$ . Define  $(Z_1, \dots, Z_{d+\omega}) \in \prod_{i=1}^{d+\omega} \mathbb{H}$ , as follows. Let  $|S_j|$  denote the number of elements in  $S_j$ , and let

$$Z_j = \sum_{i \in S_j} \frac{\operatorname{Re}(z_i)}{|S_j|}.$$

If  $k$  is any of the remaining elements  $d+1, \dots, d+\omega$  of the input set for  $v$  let

$$Z_k = z_k.$$

The  $v$  component of  $\psi_T(\mathbf{z})$  is the element  $(z_1^{(v)}, \dots, z_{d+\omega}^{(v)}) \in \tilde{Q}^{d,\omega}$  satisfying the slice condition that is in the same  $\operatorname{Aut}(\mathbb{H})$ -orbit as  $(Z_1, \dots, Z_{d+\omega})$ . Letting  $v$  vary, we obtain the desired element  $\psi_T(z_1, \dots, z_{n+\omega}) \in \tilde{Q}^T$ .

We claim that  $\psi_T(\varphi(r, q)) = q$ . To verify this identity, we argue as follows. Fix a vertex  $v$  for the tree  $T$ . Let  $S_k \subset I(v)$  be the set coming from a parent vertex of  $v$ . Equation (8.25) specifies the components of  $\varphi(r, q)$ . Each  $z_i$  is a sum of terms, which are of the following three kinds: terms involving  $z_i^{(v_j)}$ , where  $I(v_j) \subsetneq I(v)$ ; the term involving  $z_i^{(v_j)}$  with  $v_j = v$ ; and the terms involving  $z_i^{(v_j)}$  with  $I(v_j) \supsetneq I(v)$ . We call the contributions of the first kind *ancestral contributions*; the contribution of  $v$  the *contemporary contribution*; and terms of the third kind *descendant contributions*. Observe that the descendant contributions are all the same, independent of  $i \in I(v)$ , and each contribution is real. We denote the sum of these contributions  $K$ . Next, observe that in the definition of  $Z_j$ , the ancestral contributions cancel, because of the slice condition on the parents. Finally, for each of the  $S_j \subset I(v)$ , the contemporary contribution to  $z_i$  is independent of the choice of  $i \in S_j$ . Let  $d$  denote the number of inputs to  $v$  and  $\omega$  denote the weight of  $v$ . Comparing the labels  $\{1, \dots, n+\omega\}$  of the factors of  $\tilde{Q}^{n,\omega}$  with the labels  $\{1, \dots, d+\omega\}$  of the corresponding factors of  $\tilde{Q}^{d,\omega}$  in  $\tilde{Q}^T$  specifies a surjection

$$\{1, \dots, n+\omega\} \supset I(v) \xrightarrow{\Pi} \{1, \dots, d+\omega\}.$$

Let  $\sigma$  be a section of  $\Pi$ . For any  $j \in \{1, \dots, d\}$ , we have that

$$(8.26) \quad Z_j = \frac{z_{\sigma(j)}^{(v)}}{R} + K,$$

where  $R$  is the product of  $r(e)$  over all edges from  $v$  to the trunk vertex (in particular, it is independent of  $j$ ). For  $j \in \{d+1, \dots, d+\omega\}$ , there are no ancestral contributions, and  $j$  is uniquely determined by  $\sigma(j)$ ; Equation 8.26 holds for such  $j$ , as well. It follows that  $\operatorname{Aut}(\mathbb{H})$  orbit of  $(Z_1, \dots, Z_{d+\omega})$  contains  $(z_{\sigma(1)}^{(v)}, \dots, z_{\sigma(d+\omega)}^{(v)})$ . Since this holds for all  $v \in T$ , it follows that  $q = \psi_T(\varphi(r, q))$ .

To show  $\varphi$  is injective, we extract the function  $r$  from the element of  $\varphi(r, q)$ . We determine  $r$  on all edges inductively on the distance from the edge to the trunk vertex. Specifically, suppose that  $e_1, \dots, e_\ell$  is an oriented path of edges to the trunk vertex, connecting vertices  $v_1, \dots, v_{\ell+1} = \tau$ . By stability, there is some  $i$  so that  $z_i^{(v_1)} \neq 0$ . For that choice of  $i$ , Equation (8.25) determines  $r(e_1)$  uniquely in terms of the real numbers  $r(e_2), \dots, r(e_\ell)$ , the complex numbers  $z_i^{(v_1)}, \dots, z_i^{(v_\ell)}$  and  $z_i$ . Note that, for  $i = 1, \dots, \ell$ ,  $z^{(v_i)}$  are specified by  $q = \psi_T(\varphi(r, q))$ , and  $z_i$  a component of  $\varphi(r, q)$ .

Since  $\varphi$  is an injective map between Euclidean spaces of the same dimension, it follows from Invariance of Domain [Hat02, Theorem 2B.3] that  $\varphi$  is a homeomorphism onto its image.

By construction,  $\bar{\varphi}$  has the property that if  $F \subset E$ , then  $\bar{\varphi}((0, \infty)^F \times \{\infty\}^{E \setminus F} \times \tilde{Q}^T) \subset \tilde{Q}^{K_F(T)}$ . Indeed, the restriction of  $\bar{\varphi}$  to  $(0, \infty)^F \times \{\infty\}^{E \setminus F} \times \tilde{Q}^T$  is the Cartesian product of the maps obtained by applying  $\varphi$  to the various components of  $T \setminus (E \setminus F)$ .

It follows that  $\bar{\varphi}$  takes the boundary of  $(0, \infty]^E \times \tilde{Q}^T$  to the boundary of  $\tilde{\mathbf{X}}^{n,w}$ ; and the description of  $\bar{\varphi}$  in terms of  $\varphi$  shows that this map, too, is a homeomorphism onto its image. By construction,  $\bar{\varphi}|_{(0, \infty)^E \times \tilde{Q}^T}$  is the inclusion map of  $\tilde{Q}^T$  into  $\tilde{\mathbf{X}}^{n,w}$ .  $\square$

**Corollary 8.27.** *The space  $\tilde{\mathbf{X}}^{n,w}$  is second-countable and Hausdorff, hence a topological manifold-with-boundary, the boundary of which is*

$$(8.28) \quad \partial \tilde{\mathbf{X}}^{n,w} = \bigcup_{T \in \mathcal{T}_{n,w} \setminus \{\Psi_n^w\}} Q^T.$$

Further,  $\tilde{\mathbf{X}}^{n,w}$  is compact.

*Proof.* Lemma 8.24 gives a countable (in fact, finite) open cover of  $\tilde{\mathbf{X}}^{n,w}$  by open subsets of  $(0, \infty]^{n+2w-2}$ . Hence,  $\tilde{\mathbf{X}}^{n,w}$  is second-countable and locally Euclidean (in the sense of manifolds with boundary), and the boundary of  $\tilde{\mathbf{X}}^{n,w}$  is given by Equation (8.28).

By Proposition 8.23,  $\tilde{\mathbf{X}}^{n,w}$  is sequentially Hausdorff. For locally Euclidean spaces, sequential Hausdorffness implies Hausdorffness. Indeed, given points  $\mathbf{z}$  and  $\mathbf{z}'$ , fix Euclidean charts around  $\mathbf{z}$  and  $\mathbf{z}'$ . If the balls  $B_{1/n}(\mathbf{z})$  and  $B_{1/n}(\mathbf{z}')$  intersect for all  $n$ , there is a sequence  $\{\mathbf{z}_n\}_{j=1}^\infty$  in their intersection converging to both  $\mathbf{z}$  and  $\mathbf{z}'$ ; so  $\mathbf{z} = \mathbf{z}'$  by sequential Hausdorffness.

For manifolds-with-boundary, compactness is equivalent to sequential compactness, which again was verified in Proposition 8.23.  $\square$

Let

$$\mathbf{X}^{n,w} = \tilde{\mathbf{X}}^{n,w}/S_w,$$

the quotient by the symmetric group action permuting the labels of the interior marked points.

**Proposition 8.29.** *The space  $\mathbf{X}^{n,w}$  is a compact manifold-with-boundary, the boundary of which is*

$$(8.30) \quad \partial \mathbf{X}^{n,w} = \bigcup_{T \in \mathcal{T}_{n,w} \setminus \{\Psi_n^w\}} Q^T.$$

*Proof.* First we verify that  $\mathbf{X}^{n,w}$  is locally Euclidean, i.e., locally modeled on open subsets of  $[0, 1]^{n+2w-2}$ . Recall that the symmetric product  $\text{Sym}^k(D^2)$  is homeomorphic to  $D^{2k}$ . It follows that the interior of each  $Q^T$  is homeomorphic to an open ball. By Lemma 8.24, a neighborhood of the interior of each  $Q^T$  in  $\tilde{\mathbf{X}}^{n,w}$  is given by  $\tilde{Q}^T \times (0, \infty]^k$ . The action of the symmetric group on the  $(0, \infty]^k$ -factor is trivial: the group acts by permuting components of  $\tilde{Q}^T$  (each of which is a ball) and by acting on each component. Hence, the quotient space  $\mathbf{X}^{n,w}$  is locally Euclidean.

The space  $\tilde{\mathbf{X}}^{n,w}$  is compact and the equivalence relation induced by the  $S_w$ -orbits is a closed subset of  $\tilde{\mathbf{X}}^{n,w} \times \tilde{\mathbf{X}}^{n,w}$ . Hence, the quotient space  $\mathbf{X}^{n,w}$  is Hausdorff (see, e.g., [Lee11, Theorem 4.57]). Of course, compactness is inherited by quotients, so by Proposition 8.23,  $\mathbf{X}^{n,w}$  is compact. Similarly, second countability is inherited by quotients which are manifolds (see, e.g., [Lee11, Proposition 3.56]). Hence  $\mathbf{X}^{n,w}$  is a manifold with boundary. Since the action of  $S_w$  respects the decomposition in Equation (8.28) and, for each stratum of the boundary and each edge, the action of  $S_w$  respects the local collar neighborhoods from Lemma 8.24, the boundary of  $\mathbf{X}^{n,w}$  is given by Equation (8.30).  $\square$

We will use the following folklore result:

**Lemma 8.31.** *If  $X$  is an  $n$ -dimensional compact topological manifold-with-boundary whose interior is homeomorphic to an open ball then  $X$  is homeomorphic to a closed ball.*

*Proof.* It follows from Lefschetz duality that  $H_i(X, \partial X) = 0$  for  $i < n$  and  $H_n(X, \partial X) \cong \mathbb{Z}$ . Hence, the long exact sequence for the pair  $(X, \partial X)$  shows that  $\partial X$  is a homology sphere. By the topological collar neighborhood theorem [Hat02, Proposition 3.42] (see also [Bro62, Con71]), the boundary of  $X$  has a collar neighborhood. It follows that  $\partial X$  is simply-connected, since Euclidean space is simply-connected at infinity. Thus,  $\partial X$  is a homotopy sphere. By the topological generalized Poincaré

conjecture [New66, Fre82, Per02, Per03b, Per03a] we obtain a homeomorphism from  $\partial X$  to a sphere. Further, the collar neighborhood gives an embedding of  $X$  into the interior of  $X$ , i.e., into  $\mathbb{R}^n$ . So, it follows from Brown’s Schoenflies theorem [Bro60] that  $X$  is a closed ball.  $\square$

**Theorem 8.32.** *The space  $\mathbf{X}^{n,w}$  is homeomorphic to a closed ball, expressed as a CW complex whose  $k$ -dimensional cells  $Q^T$  correspond to trees  $T \in X_k^{n,w}$  with  $k = n + 2w - 2$ , and whose cellular chain complex is identified with  $X_*^{n,w}$  (over  $\mathbb{Z}$ ).*

*Proof.* We prove by induction on the dimension  $n + 2w - 2$  that  $\mathbf{X}^{n,w}$  is a CW complex and that its cellular chain complex is  $X_*^{n,w}$ . For the base cases  $(n, w) \in \{(2, 0), (0, 1)\}$ ,  $\mathbf{X}^{n,w}$  is a single point.

For the inductive step, by Proposition 8.29 and the inductive hypothesis, Equation (8.30) expresses  $\partial \mathbf{X}^{n,w}$  as a CW complex, with cells corresponding to the trees  $T \in \mathcal{T}_{n,w} \setminus \{\Psi_n^w\}$ , and whose differential is identified with the corresponding subcomplex of  $X_*^{n,w}$ . Since the interior of  $\mathbf{X}^{n,w}$  is an open ball, Lemma 8.31 implies that  $\mathbf{X}^{n,w}$  is homeomorphic to a closed ball. In particular, the topological collar neighborhood theorem then implies that  $\mathbf{X}^{n,w}$  is a CW complex.

Finally, we verify that the cellular chain complex of  $\mathbf{X}^{n,w}$  is isomorphic to  $X_*^{n,w}$ . Of course, both  $C_*^{cell}(\mathbf{X}^{n,w})$  and  $X_*^{n,w}$  have generating sets in bijection with the stably weighted trees with  $n$  inputs and weight  $w$ . To verify the complexes are isomorphic we start by determining the signs in the identification between the generating sets. Fix arbitrarily an orientation of the (open) top-dimensional cell  $D$  of  $\mathbf{X}^{n,w}$ . For any other  $Q^T$ , fix an ordering  $\omega$  of the  $e$  internal edges of  $T$ , i.e., an orientation of  $T$  in the sense of Section 5.1. By Lemma 8.24, this ordering induces an inclusion  $(0, \infty)^e \times Q^T \hookrightarrow D$ . The chosen orientation of  $D$  and the standard orientation of  $(0, \infty)^e$  then induce an orientation of  $Q^T$ . If we change  $\omega$  by an even (respectively odd) permutation then this orientation is unchanged (respectively changed). Hence, we obtain a well-defined map  $C_*^{cell}(\mathbf{X}^{n,w}) \xrightarrow{\cong} X_*^{n,w}$ , sending the generator corresponding to  $T$  with orientation induced by  $\omega$  to  $(T, \omega)$ .

We must verify that this isomorphism is a chain map. From the description of the strata of  $\mathbf{X}^{n,w}$ ,  $Q^{T'}$  appears in the topological boundary of  $Q^T$  if and only if  $T'$  is obtained from  $T$  by collapsing an internal edge  $e$ . Fix such  $T, T'$ , and  $e$ , and let  $\omega$  be an orientation of  $T$ . Then  $e \wedge \omega$  is an orientation of  $T'$ . If we use  $\omega$  to orient  $Q^T$  and  $e \wedge \omega$  to orient  $Q^{T'}$  then, by Lemma 8.24 (taking  $E = \{e\}$ ), the edge  $e$  contributes 1 to the coefficient of  $Q^{T'}$  in the cellular boundary of  $Q^T$ . This agrees with the differential on  $X_*^{n,w}$  (Equation (5.1)), proving the result.  $\square$

## 9. ON BOUNDEDNESS

The conditions of being bonsai or bounded is used in the following places:

- For the type  $D$  (respectively  $DD$ ) structure equation to make sense (Definitions 4.60 and 7.19), we need the algebra(s) to be bonsai or the type  $D$  (or  $DD$ ) structure to be operationally bounded.
- Similarly, to define the morphism complexes between type  $D$  (respectively  $DD$ ) structures and the composition maps on them (Section 4.7 and Definition 7.19), we need the algebra(s) to be bonsai or the type  $D$  (or  $DD$ ) structure to be operationally bounded.
- For the box tensor products to be well-defined:
  - For the box tensor product of a module and a type  $D$  structure to be defined, and an  $A_\infty$ -bifunctor, either the module must be bonsai or the type  $D$  structure operationally bounded (Lemmas 4.67 and 4.68).
  - For the triple box tensor product  $[\mathcal{M}_{\mathcal{A}} \boxtimes^{\mathcal{A}} P^{\mathcal{B}^{\text{op}}} \boxtimes_{\mathcal{B}^{\text{op}}} \mathcal{N}]_{\mathbf{M}}$  (Definition 7.22 and Theorem 1.16) to be well-defined, either the algebras and modules must be bonsai or the type  $DD$  structure must be operationally bounded. (This is a special case of the previous point.)
  - For the one-sided box tensor product  $\mathcal{M} \boxtimes^{\mathbf{P}} P$  to be defined (Definition 7.23 and Proposition 7.24), either the algebras and module must be bonsai or the type  $DD$  structure

must be operationally bounded. Further, in the latter case, the resulting type  $D$  structure is operationally bounded.

- For associativity of the box tensor product (Proposition 7.24), either all the algebras and modules involved must be bonsai or the type  $DD$  structure must be operationally bounded.
- For functoriality of the one-sided box tensor products (Lemma 7.27 and Proposition 7.28), either the type  $DD$  structure must be operationally bounded or the algebras, modules, and module morphisms must be bonsai.
- For associativity of the box tensor product of morphisms (Lemma 7.32 and Corollary 7.33), again either the type  $DD$  structure must be operationally bounded or the algebras, modules, and module morphism must be bonsai.

Further, these conditions need to satisfy:

- The (external) tensor product of two bonsai weighted algebras, modules, algebra homomorphisms, or module morphisms is bonsai (Lemmas 7.5 and 7.10).
- A weakly unital bonsai algebra is isomorphic to a strictly unital bonsai algebra via a bonsai isomorphism (Theorem 4.25 and Proposition 4.29).
- A weakly unital bonsai module is isomorphic to a strictly unital bonsai module via a bonsai isomorphism (Theorem 4.50).
- The complex of bonsai morphisms between strictly unital bonsai modules is homotopy equivalent to the subcomplex of strictly unital bonsai morphisms (Proposition 4.52).

For our application to bordered Floer theory, we will need to weaken these hypotheses slightly.

**Definition 9.1.** Let  $\mathcal{A} = (A, \{\mu_n^w\})$  be a weighted  $A_\infty$ -algebra. A filtration of  $\mathcal{A}$  is a sequence of subspaces  $A = \mathcal{F}^0 A \supset \mathcal{F}^1 A \supset \mathcal{F}^2 A \supset \dots$  of  $A$  so that if  $a_i \in \mathcal{F}^{m_i} A$ ,  $i = 1, \dots, n$  then

$$\mu_n^w(a_1, \dots, a_n) \in \mathcal{F}^{m_1 + \dots + m_n} A.$$

The algebra  $\mathcal{A}$  is complete with respect to the filtration  $\mathcal{F}$  if the vector space  $A$  is complete with respect to  $\mathcal{F}$ .

A filtration of a weighted  $A_\infty$ -module  $\mathcal{M}$  over a filtered, weighted  $A_\infty$ -algebra  $\mathcal{A}$  is a sequence of subspaces  $M = \mathcal{F}^0 M \supset \mathcal{F}^1 M \supset \dots$  so that if  $x \in \mathcal{F}^{m_0} M$  and  $a_i \in \mathcal{F}^{m_i} A$  then

$$\mu_{1+n}^w(x, a_1, \dots, a_n) \in \mathcal{F}^{m_0 + \dots + m_n} M.$$

The module  $\mathcal{M}$  is complete with respect to the filtration if the underlying vector space  $M$  is.

If  $(\mathcal{A}, \mathcal{F})$  and  $(\mathcal{B}, \mathcal{F})$  are filtered weighted  $A_\infty$ -algebras then a homomorphism  $f: \mathcal{A} \rightarrow \mathcal{B}$  is filtered if for all  $a_1, \dots, a_n \in A$  with  $a_i \in \mathcal{F}^{m_i} A$ ,

$$f_n^w(a_1, \dots, a_n) \in \mathcal{F}^{m_1 + \dots + m_n} B.$$

If  $(\mathcal{M}, \mathcal{F})$  and  $(\mathcal{N}, \mathcal{F})$  are filtered weighted  $A_\infty$ -modules over  $(\mathcal{A}, \mathcal{F})$  then a morphism  $f: \mathcal{M} \rightarrow \mathcal{N}$  is filtered if for all  $x \in \mathcal{F}^{m_0} M$  and  $a_i \in \mathcal{F}^{m_i} A$  we have

$$f_{1+n}^w(x, a_1, \dots, a_n) \in \mathcal{F}^{m_0 + \dots + m_n} N.$$

It is immediate from the definitions that the filtered morphisms form a subcomplex  $\text{Mor}((\mathcal{M}, \mathcal{F}), (\mathcal{N}, \mathcal{F}))$  of  $\text{Mor}(\mathcal{M}, \mathcal{N})$ . Note also that if  $T$  is a stably weighted tree with  $n$  inputs and  $(\mathcal{A}, \mathcal{F})$  is a filtered  $A_\infty$ -algebra then it follows from the definitions that

$$\mu(T): \mathcal{F}^{m_1} A \otimes \dots \otimes \mathcal{F}^{m_n} A \rightarrow \mathcal{F}^{m_1 + \dots + m_n} A$$

(and similar statements for modules, homomorphisms, and morphisms).

*Example 9.2.* If  $\mathcal{A}$  is a weighted  $A_\infty$ -algebra over the power series ring  $\mathbb{F}_2[[U]]$ , and  $A$  is a finitely-generated free module over  $\mathbb{F}_2[[U]]$ , then there is a  $U$ -power filtration on  $\mathcal{A}$ ,  $\mathcal{F}^m = U^m A$ , and  $\mathcal{A}$  is complete with respect to this filtration.

Observe that if  $(\mathcal{A}, \mathcal{F})$  is a filtered weighted  $A_\infty$ -algebra then each quotient  $A/\mathcal{F}^m A$  inherits the structure of a weighted  $A_\infty$ -algebra  $\mathcal{A}/\mathcal{F}^m \mathcal{A}$ ; and if  $(\mathcal{M}, \mathcal{F})$  is a filtered weighted  $A_\infty$ -module over  $(\mathcal{A}, \mathcal{F})$  then each quotient  $M/\mathcal{F}^m M$  inherits the structure of a weighted  $A_\infty$ -module  $\mathcal{M}/\mathcal{F}^m \mathcal{M}$  over  $\mathcal{A}/\mathcal{F}^m \mathcal{A}$ . Homomorphisms (respectively morphisms) of filtered weighted algebras (respectively modules) induce homomorphisms (respectively morphisms) of these quotients

- Definition 9.3.**
- A filtered weighted  $A_\infty$ -algebra  $(\mathcal{A}, \mathcal{F})$  is filtered bonsai if  $\mathcal{A}$  is complete with respect to  $\mathcal{F}$  and each quotient  $\mathcal{A}/\mathcal{F}^m \mathcal{A}$  is bonsai.
  - A filtered weighted  $A_\infty$ -module  $(\mathcal{M}, \mathcal{F})$  over a filtered bonsai  $(\mathcal{A}, \mathcal{F})$  is filtered bonsai if  $\mathcal{M}$  is complete with respect to  $\mathcal{F}$  and each  $\mathcal{M}/\mathcal{F}^m \mathcal{M}$  is bonsai.
  - A filtered homomorphism  $f: (\mathcal{A}, \mathcal{F}) \rightarrow (\mathcal{B}, \mathcal{F})$  between filtered bonsai weighted  $A_\infty$ -algebras is filtered bonsai if the induced map  $\mathcal{A}/\mathcal{F}^m \mathcal{A} \rightarrow \mathcal{B}/\mathcal{F}^m \mathcal{B}$  is bonsai for each  $m$ .
  - A filtered morphism  $f: (\mathcal{M}, \mathcal{F}) \rightarrow (\mathcal{N}, \mathcal{F})$  between filtered bonsai weighted  $A_\infty$ -modules is filtered bonsai if the induced map  $\mathcal{M}/\mathcal{F}^m \mathcal{M} \rightarrow \mathcal{N}/\mathcal{F}^m \mathcal{N}$  is bonsai for each  $m$ .

**Definition 9.4.** A weighted type  $D$  or  $DD$  structure with charge  $X$  over a filtered weighted  $A_\infty$ -algebra  $(\mathcal{A}, \mathcal{F})$  is filtered operationally bounded if the operation  $\delta^n$  vanishes for all sufficiently large  $n$  and the action of  $X$  on  $\mathcal{A}/\mathcal{F}^m \mathcal{A}$  is nilpotent for each  $m$  (i.e., for each  $m$  there exists an  $N$  so that for  $n > N$  and any  $a \in A$ ,  $X^n \cdot a \in \mathcal{F}^m A$ ).

**Lemma 9.5.** If  $(\mathcal{A} = (A, \{\mu_n^w\}), \mathcal{F})$  and  $(\mathcal{B} = (B, \{\nu_n^w\}), \mathcal{F})$  are filtered bonsai algebras then so is  $\mathcal{A} \otimes_{\Gamma} \mathcal{B}$ . The analogous statement holds for filtered bonsai modules, filtered bonsai algebra homomorphisms, and filtered bonsai module morphisms.

*Proof.* We explain the case of filtered bonsai algebras; the remaining cases are similar. Define the filtration on  $A \otimes_R B$  by declaring that

$$\mathcal{F}^n(A \otimes_R B) = \sum_{p+q=n} \mathcal{F}^p(A) \otimes_R \mathcal{F}^q(B).$$

To see this defines a filtration on  $\mathcal{A} \otimes_{\Gamma} \mathcal{B}$ , note that if  $T$  is a stably weighted trees with  $n$  inputs then  $\mu \otimes_{\Gamma} \nu(T)$  is a linear combination of pairs of trees with  $n$  inputs, so defines a map

$$(\mathcal{F}^{p_1} A \otimes \dots \otimes \mathcal{F}^{p_n} A) \otimes_R (\mathcal{F}^{q_1} B \otimes \dots \otimes \mathcal{F}^{q_n} B) \rightarrow (\mathcal{F}^{p_1 + \dots + p_n} A) \otimes_R (\mathcal{F}^{q_1 + \dots + q_n} B) \subset \mathcal{F}^{p_1 + \dots + p_n + q_1 + \dots + q_n}(A \otimes_R B).$$

For each  $m$  and  $p$ , the composition

$$(A \otimes_R B)^{\otimes n} \xrightarrow{\mu_n(T)} (A \otimes_R B) \rightarrow (A \otimes_R B)/\mathcal{F}^m(A \otimes_R B) \rightarrow (A/\mathcal{F}^p A) \otimes_R (B/\mathcal{F}^{m-p} B)$$

vanishes for  $\dim(T)$  sufficiently large. It follows that for each  $m$ , the map

$$(A \otimes_R B)^{\otimes n} \xrightarrow{\mu_n(T)} (A \otimes_R B) \rightarrow (A \otimes_R B)/\mathcal{F}^m(A \otimes_R B)$$

vanishes for  $\dim(T)$  sufficiently large. Hence,  $\mathcal{A} \otimes_{\Gamma} \mathcal{B}$  is filtered bonsai, as desired.  $\square$

The results about unitality also hold in the filtered bonsai case:

**Lemma 9.6.** The bonsai statements in Theorem 4.25, Proposition 4.29, Theorem 4.50, and Proposition 4.52 hold for filtered bonsai weighted algebras, modules, and algebra homomorphisms, and module morphisms.

*Proof.* We explain (briefly) the case of Theorem 4.25; the other cases are similar. It suffices to check that each modification of the weighted operations respects the filtration, and the induced map of quotients  $A/\mathcal{F}^m A$  is bonsai. The first statement follows from the fact that each  $\phi_n^v$  and  $\psi_n^v$  used to perform the modification is filtered, and composition of filtered maps are filtered. The second follows from the fact that the new multiplication is a linear combination of operation trees for the old multiplication of the same dimension, with some inputs  $\mathbf{1}$ .  $\square$

**Proposition 9.7.** *Throughout this paper, the hypothesis of being bonsai can be replaced by the hypothesis of being filtered bonsai, and the hypothesis of being operationally bounded can be replaced by the hypothesis of being filtered operationally bounded.*

*Proof.* This is straightforward, and is left to the reader. □

APPENDIX A. TERMS IN DIAGONALS

For the reader's convenience, we include the first few terms in the weighted diagonals of various types introduced in the text. To save space, we draw weight-0 vertices without the circle labelled 0.

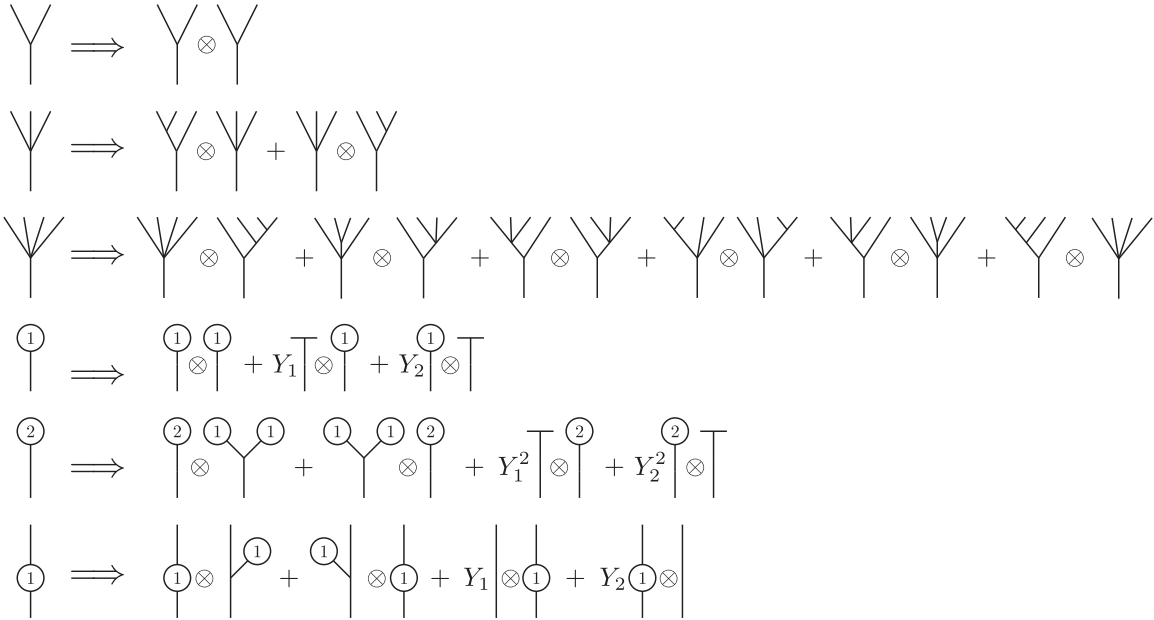

A WEIGHTED ALGEBRA DIAGONAL  $\Gamma^{*,*}$ .

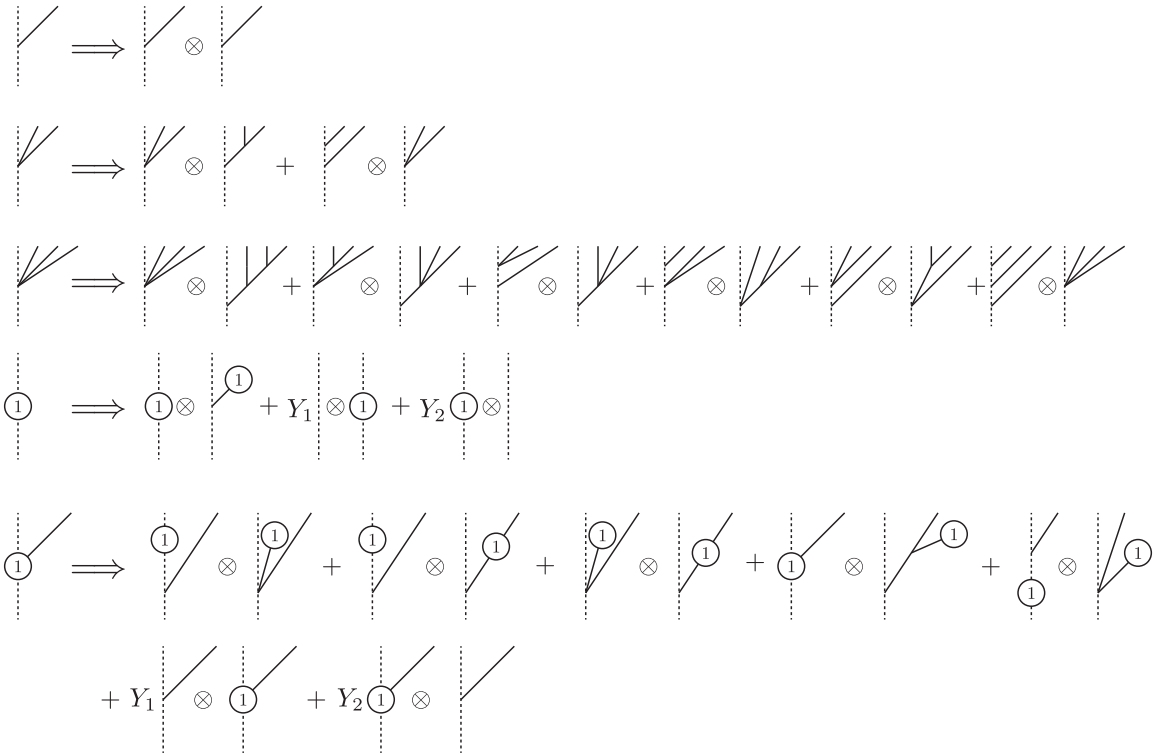

A WEIGHTED MODULE DIAGONAL  $\mathbf{M}^{*,*}$  COMPATIBLE WITH  $\Gamma^{*,*}$ .

$$\begin{aligned}
 \mathbf{p}^{2,0} &= \text{diagram} \\
 \mathbf{p}^{3,0} &= \text{diagram} \\
 \mathbf{p}^{4,0} &= \text{diagram} + \text{diagram} + \text{diagram} \\
 \mathbf{p}^{1,1} &= \text{diagram} + Y_2 \text{diagram} \\
 \mathbf{p}^{2,1} &= \text{diagram} + \text{diagram} + \text{diagram} + \text{diagram} + Y_2 \text{diagram} \\
 \mathbf{p}^{1,2} &= \text{diagram} + \text{diagram} + \text{diagram} + \text{diagram} + Y_2 \text{diagram}
 \end{aligned}$$

A WEIGHTED MODULE DIAGONAL PRIMITIVE  $\mathbf{p}^{*,*}$  COMPATIBLE WITH  $\Gamma^{*,*}$  AND INDUCING  $\mathbf{M}^{*,*}$ .

$$\begin{aligned}
 &\text{diagram} \implies \text{diagram} \\
 &\text{diagram} \implies \text{diagram} + \text{diagram} \\
 &\text{diagram} \implies \text{diagram} + \text{diagram} + \text{diagram} + \text{diagram} + \text{diagram} + \text{diagram} + \text{diagram} \\
 &\text{diagram} \implies \text{diagram} + \text{diagram} + Y_1 \text{diagram} + Y_2 \text{diagram}
 \end{aligned}$$

A WEIGHTED MODULE-MAP DIAGONAL  $\mathbf{L}^{*,*}$  COMPATIBLE WITH  $\mathbf{M}^{*,*}$  AND  $\mathbf{M}^{*,*}$ .



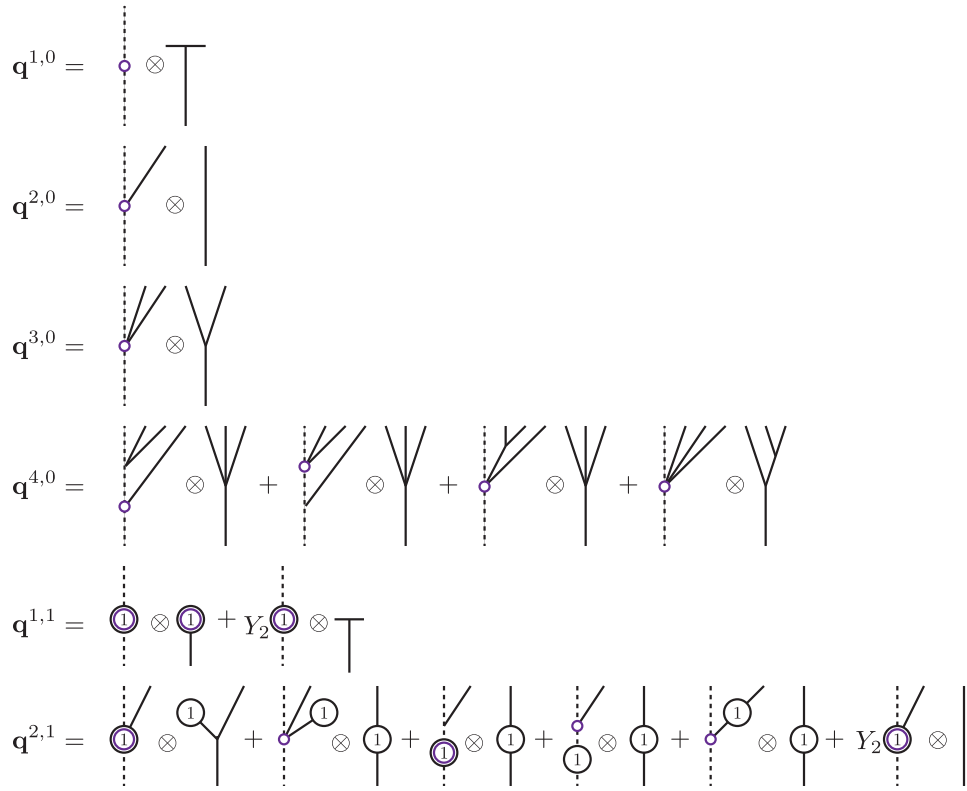

A WEIGHTED MODULE-MAP PRIMITIVE  $q^{*,*}$  COMPATIBLE WITH  $p^{*,*}$  AND  $p^{*,*}$ .

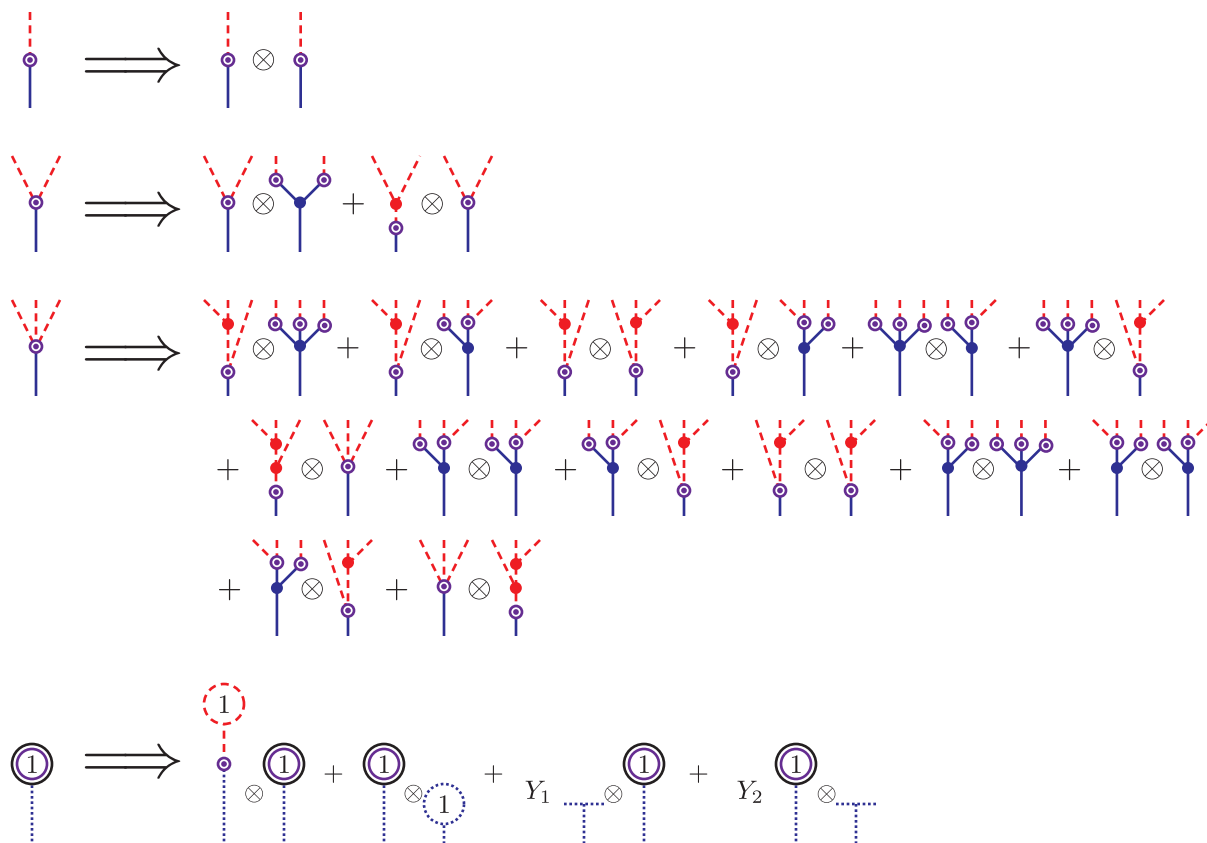

A WEIGHTED (ALGEBRA) MAP DIAGONAL  $\Theta^{*,*}$  COMPATIBLE WITH  $\Gamma^{*,*}$  AND  $\Gamma^{*,*}$ .

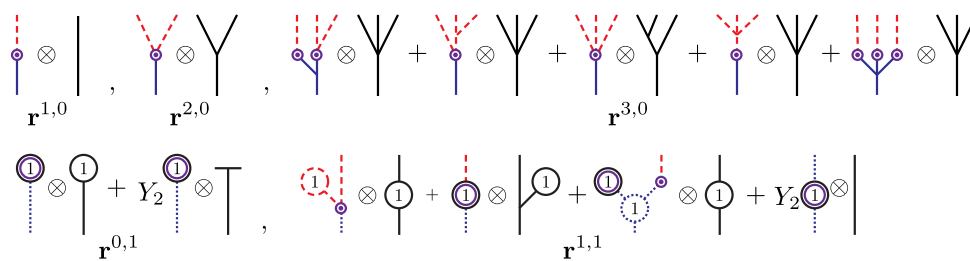

A WEIGHTED DADD DIAGONAL  $\mathbf{r}^{*,*}$  COMPATIBLE WITH  $\Gamma^{*,*}$  AND  $\Gamma^{*,*}$ .

APPENDIX B. A CONVENTION OF TABLES

Object	Notation	Definition	Terms	Use
Associahedron diagonal	$\Gamma^n, \gamma_n$	2.13, 2.16	Fig. 3	Tensor product of $A_\infty$ -algebras, definition of $DD$ structure.
Module diagonal	$\mathbf{M}^n, \mathbf{m}_n$	2.22	Fig. 3	Tensor product of $A_\infty$ -modules, triple box tensor product.
Module diagonal primitive	$\mathbf{p}_n$	2.29	Fig. 7	One-sided box tensor product.
Multiplihedron diagonal	$\Theta^n, \theta_n$	2.44	Fig. 10	Tensor product of morphisms of $A_\infty$ -algebras.
Module-map diagonal	$\mathbf{L}_n, \ell_n$	2.48	Fig. 12	Tensor product of morphisms of $A_\infty$ -modules.
Module-map primitive	$\mathbf{q}_n$	2.55	Fig. 13	One-sided box product of identity map of a $DD$ structure with a morphism of $A_\infty$ -modules.
Partial module-map diagonal	$\mathbf{k}_n$	2.62		Tensor product of a morphism of $A_\infty$ -modules with the identity map of another $A_\infty$ -module.
Weighted algebra diagonal	$\Gamma^{n,w}, \gamma^{n,w}$	6.4, 6.6	Fig. 35	Tensor product of $w$ -algebras, definition of weighted $DD$ structure.
Weighted module diagonal	$\mathbf{M}^{n,w}, \mathbf{m}^{n,w}$	6.19	Fig. 38	Tensor product of $w$ -modules, triple box tensor product of a weighted $DD$ structure and two $w$ -modules.
Weighted module diagonal primitive	$\mathbf{p}^{n,w}$	6.29	Fig. 39	One-sided box tensor product of a weighted $DD$ structure and a $w$ -module.
Weighted map diagonal	$\Theta^{n,w}, \theta^{n,w}$	6.14, 6.16	Fig. 37	Tensor product of morphisms of $w$ -algebras.
Weighted module-map diagonal	$\mathbf{L}^{n,w}, \ell^{n,w}$	6.39	Fig. 40	Tensor product of morphisms of $w$ -modules.
Weighted module-map primitive	$\mathbf{q}^{n,w}$	6.42	Fig. 41	One-sided box product of identity map of a $DD$ structure with a morphism of $A_\infty$ -modules.
Partial weighted module-map diagonal	$\mathbf{k}^{n,w}$	6.49		Tensor product of a morphism of $w$ -modules with the identity map of another $w$ -module.

TABLE 1. Things and their uses.

Convention	Summary
2.1, 6.1	Tensor products in Sections 2 and 6 are over $R$ by default.
3.1, 7.1	The ground ring notation in Sections 3, 4, 7. Tensor products over $\mathbb{k}$ by default.
2.2	Terminology for trees.
2.7	Cellular chain complex are with $R$ -coefficients.
3.2	Grading shifts.
3.39	Boundedness hypotheses for type $D$ structures.
4.3	Weighted $A_\infty$ -algebras are uncurved.
4.51	Modules over strictly unital weighted algebras assumed strictly unital.
7.46	Boundedness hypotheses suppressed in the rest of this section.

TABLE 2. Table of conventions, to help the reader find which conventions are in force.

## REFERENCES

- [Amo16] Lino Amorim, *Tensor product of filtered  $A_\infty$ -algebras*, J. Pure Appl. Algebra **220** (2016), no. 12, 3984–4016.
- [Aur10] Denis Auroux, *Fukaya categories of symmetric products and bordered Heegaard-Floer homology*, J. Gökova Geom. Topol. GGT **4** (2010), 1–54, arXiv:1001.4323.
- [BK90] A. I. Bondal and M. M. Kapranov, *Framed triangulated categories*, Mat. Sb. **181** (1990), no. 5, 669–683.
- [Bro60] Morton Brown, *A proof of the generalized Schoenflies theorem*, Bull. Amer. Math. Soc. **66** (1960), 74–76.
- [Bro62] ———, *Locally flat imbeddings of topological manifolds*, Ann. of Math. (2) **75** (1962), 331–341.
- [Con71] Robert Connelly, *A new proof of Brown’s collaring theorem*, Proc. Amer. Math. Soc. **27** (1971), 180–182.
- [CSZ15] Cesar Ceballos, Francisco Santos, and Günter M. Ziegler, *Many non-equivalent realizations of the associahedron*, Combinatorica **35** (2015), no. 5, 513–551.
- [Dev99] Satyan L. Devadoss, *Tessellations of moduli spaces and the mosaic operad*, Homotopy invariant algebraic structures (Baltimore, MD, 1998), Contemp. Math., vol. 239, Amer. Math. Soc., Providence, RI, 1999, pp. 91–114.
- [Flo88] Andreas Floer, *An instanton-invariant for 3-manifolds*, Comm. Math. Phys. **118** (1988), no. 2, 215–240.
- [FO97] Kenji Fukaya and Yong-Geun Oh, *Zero-loop open strings in the cotangent bundle and Morse homotopy*, Asian J. Math. **1** (1997), no. 1, 96–180.
- [FOOO09] Kenji Fukaya, Yong-Geun Oh, Hiroshi Ohta, and Kaoru Ono, *Lagrangian intersection Floer theory: anomaly and obstruction. Part I*, AMS/IP Studies in Advanced Mathematics, vol. 46, American Mathematical Society, Providence, RI; International Press, Somerville, MA, 2009.
- [Fre82] Michael Hartley Freedman, *The topology of four-dimensional manifolds*, J. Differential Geometry **17** (1982), no. 3, 357–453.
- [Hat02] Allen Hatcher, *Algebraic topology*, Cambridge University Press, Cambridge, 2002.
- [IM89] Norio Iwase and Mamoru Mimura, *Higher homotopy associativity*, Algebraic topology (Arcata, CA, 1986), Lecture Notes in Math., vol. 1370, Springer, Berlin, 1989, pp. 193–220.
- [Kela] Bernhard Keller, *A brief introduction to  $A$ -infinity algebras*, <http://people.math.jussieu.fr/~keller/publ/IntroAinfEdinb.pdf>.
- [Kelb] ———, *Koszul duality and coderived categories (after K. Lefèvre)*, <http://people.math.jussieu.fr/~keller/publ/kdc.dvi>.
- [Kel01] ———, *Introduction to  $A$ -infinity algebras and modules*, Homology Homotopy Appl. **3** (2001), no. 1, 1–35, arXiv:math.RA/9910179.
- [Kel06] ———, *On differential graded categories*, International Congress of Mathematicians. Vol. II, Eur. Math. Soc., Zürich, 2006, pp. 151–190, arXiv:math.KT/0601185.
- [KM07] Peter Kronheimer and Tomasz Mrowka, *Monopoles and three-manifolds*, New Mathematical Monographs, vol. 10, Cambridge University Press, Cambridge, 2007.
- [Kon95] Maxim Kontsevich, *Homological algebra of mirror symmetry*, Proceedings of the International Congress of Mathematicians, Vol. 1, 2 (Zürich, 1994) (Basel), Birkhäuser, 1995, pp. 120–139.
- [Laz03] A. Lazarev, *Hochschild cohomology and moduli spaces of strongly homotopy associative algebras*, Homology Homotopy Appl. **5** (2003), no. 1, 73–100.
- [Lee11] John M. Lee, *Introduction to topological manifolds*, second ed., Graduate Texts in Mathematics, vol. 202, Springer, New York, 2011.
- [LH03] Kenji Lefèvre-Hasegawa, *Sur les  $A_\infty$ -catégories*, Ph.D. thesis, Université Denis Diderot – Paris 7, 2003, arXiv:math.CT/0310337.
- [Lod11] Jean-Louis Loday, *The diagonal of the Stasheff polytope*, Higher structures in geometry and physics, Progr. Math., vol. 287, Birkhäuser/Springer, New York, 2011, pp. 269–292, arXiv:0710.0572.
- [LOT14] Robert Lipshitz, Peter S. Ozsváth, and Dylan P. Thurston, *Computing  $\widehat{HF}$  by factoring mapping classes*, Geom. Topol. **18** (2014), no. 5, 2547–2681, arXiv:1010.2550.
- [LOT15] ———, *Bimodules in bordered Heegaard Floer homology*, Geom. Topol. **19** (2015), no. 2, 525–724, arXiv:1003.0598.
- [LOT18] ———, *Bordered Heegaard Floer homology*, Mem. Amer. Math. Soc. **254** (2018), no. 1216, viii+279, arXiv:0810.0687.
- [Lyu11] Volodymyr Lyubashenko, *Homotopy unital  $A_\infty$ -algebras*, J. Algebra **329** (2011), 190–212.
- [MS06] Martin Markl and Steve Shnider, *Associahedra, cellular  $W$ -construction and products of  $A_\infty$ -algebras*, Trans. Amer. Math. Soc. **358** (2006), no. 6, 2353–2372, arXiv:math.AT/0312277.
- [MT14] Fernando Muro and Andrew Tonks, *Unital associahedra*, Forum Math. **26** (2014), no. 2, 593–620.
- [MTTV19] Naruki Masuda, Hugh Thomas, Andy Tonks, and Bruno Vallette, *The diagonal of the associahedra*, 2019, arXiv:1902.08059.

- [MW10] S. Ma'u and C. Woodward, *Geometric realizations of the multiplihedra*, Compos. Math. **146** (2010), no. 4, 1002–1028.
- [New66] M. H. A. Newman, *The engulfing theorem for topological manifolds*, Ann. of Math. (2) **84** (1966), 555–571.
- [Ni13] Yi Ni, *Nonseparating spheres and twisted Heegaard Floer homology*, Algebr. Geom. Topol. **13** (2013), no. 2, 1143–1159.
- [OSz04a] Peter S. Ozsváth and Zoltán Szabó, *Holomorphic disks and genus bounds*, Geom. Topol. **8** (2004), 311–334.
- [OSz04b] ———, *Holomorphic disks and topological invariants for closed three-manifolds*, Ann. of Math. (2) **159** (2004), no. 3, 1027–1158, arXiv:math.SG/0101206.
- [OSz06] ———, *Holomorphic triangles and invariants for smooth four-manifolds*, Adv. Math. **202** (2006), no. 2, 326–400, arXiv:math.SG/0110169.
- [Per02] Grigori Perelman, *The entropy formula for the Ricci flow and its geometric applications*, 2002, arXiv:math/0211159.
- [Per03a] ———, *Finite extinction time for the solutions to the Ricci flow on certain three-manifolds*, 2003, arXiv:math/0307245.
- [Per03b] ———, *Ricci flow with surgery on three-manifolds*, 2003, arXiv:math/0303109.
- [Pos18] Leonid Positselski, *Weakly curved  $A_\infty$ -algebras over a topological local ring*, Mém. Soc. Math. Fr. (N.S.) (2018), no. 159, vi+206, arXiv:1202.2697.
- [Sei02] Paul Seidel, *Fukaya categories and deformations*, Proceedings of the International Congress of Mathematicians, Vol. II (Beijing, 2002) (Beijing), Higher Ed. Press, 2002, pp. 351–360, arXiv:math.SG/0206155.
- [Sei08] ———, *Fukaya categories and Picard-Lefschetz theory*, Zurich Lectures in Advanced Mathematics, European Mathematical Society (EMS), Zürich, 2008.
- [Sei15] ———, *Homological mirror symmetry for the quartic surface*, Mem. Amer. Math. Soc. **236** (2015), no. 1116, vi+129, arXiv:math/0310414v4.
- [Sta63] James Dillon Stasheff, *Homotopy associativity of  $H$ -spaces. I*, Trans. Amer. Math. Soc. **108** (1963), 275–292.
- [SU04] Samson Sanedidze and Ronald Umble, *Diagonals on the permutahedra, multiplihedra and associahedra*, Homology Homotopy Appl. **6** (2004), no. 1, 363–411, arXiv:math.AT/0209109.
- [Wan20] Donghao Wang, *Monopoles and Landau-Ginzburg models II: Floer homology*, 2020, arXiv:2005.04333.

DEPARTMENT OF MATHEMATICS, UNIVERSITY OF OREGON, EUGENE, OR 97403  
*Email address:* lipshitz@uoregon.edu

DEPARTMENT OF MATHEMATICS, PRINCETON UNIVERSITY, NEW JERSEY, 08544  
*Email address:* petero@math.princeton.edu

DEPARTMENT OF MATHEMATICS, INDIANA UNIVERSITY, BLOOMINGTON, INDIANA 47405, USA  
*Email address:* dphurst@indiana.edu